

price list

effective April 3, 2023

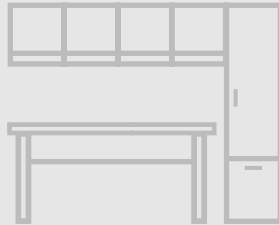
TABLES + CASEGOODS



JSI Price Lists

Tables + Casegoods

- [Apogee](#)
- [Bourne Tables](#)
- [Brogan](#)
- [Collective Conference](#)
- [Finale](#)
- [Lincoln](#)
- [Native](#)
- [Nosh](#)
- [Privacy Program](#)
- [Prost](#)
- [Reef](#)
- [Romy](#)
- [Strata](#)
- [Traditional](#)
- [Trail](#)
- [Walden](#)
- [Wellington](#)
- [Accessories](#)



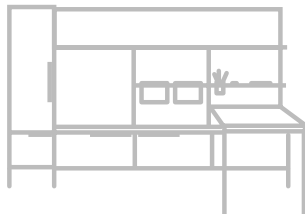
Lok

- [Training Tables](#)
- [Teamwork Tables](#)
- [Conference Tables](#)
- [Occasional Tables](#)



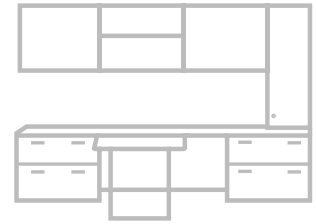
Flux

- [Private Office](#)



Vision

- [Casegoods](#)
- [Tables](#)



Seating

- | | |
|-----------------------------------|--------------------------|
| Addison | Madison |
| Americana | Melrose |
| Ansen | Millie |
| Arwyn | Moto |
| Avalon | Murphy |
| Avini | Newton |
| BeSpace | Oxley |
| Boston | Pillow |
| Bourne Seating | Poet |
| Bryn | Protocol |
| Caav | Proxy |
| Cabaret | Ramona |
| Class Act | Ria |
| Collective Motion | Sosa |
| Connect | Tara |
| Encore | Teekan |
| Esque | Totem |
| Finn | Trinity |
| Finn Nu | Tyler |
| Garvey R5 | Wink |
| Gatsby | Ziva |
| Harbor | |
| Hoopz | |
| Indie | |
| Jude | |
| Knox | |
| Kyla | |
| Laurel | |
| Mackey | |



Environmental Mission

Our vision and goal is a sustaining supplier, manufacturer and customer for the long term protection and preservation of our environment for future generations.

MISSION

To achieve this vision, we are dedicated to ensuring the health and wellbeing of all of our partners, reducing negative impact on the environment, and maintaining price structure by increasing efficiencies and reducing consumption.

JSI, and it's parent company, is an internal manufacturer and has been an environmentally conscious organization for more than 80 years.

We are proud to use wood as our primary sustainable material resource and all corporate policies and procedures support the efforts to "recover, recycle, reuse, repurpose, reduce, refuse, and re-engineer". In doing this, we are committed to the conservation of the environment and its natural resources as well as encouraging our suppliers and customers to do the same. A goal of a "Sustainable Partnership", supplier, manufacturer and customer, is essential for the long term protection preservation and sustainability of our environment for future generations.

LOCATION

Our manufacturing facilities are located in the center of Southern Indiana. With our diverse product offering and manufacturing capabilities, we provide a single source for all of your project needs allowing you to conserve our fossil fuels and reduce greenhouse gases.

PACKAGING

We place emphasis on the minimal use of disposable packaging while still providing adequate protection to the finished product. Our corrugated packaging is recyclable, reusable, and up to 100% recycled content. We reuse or recycle more than 175 tons of corrugated material annually.

REGULATORY

All of our manufacturing facilities are in compliance with applicable OSHA regulations and meet or exceed all applicable DEM and EPA regulations for air emissions, storm water and hazardous waste disposal.

MANUFACTURING FACILITIES

Our manufacturing facilities are geared toward eco-efficiency and are encouraged to continually improve and conserve. Solid wood not used in the direct manufacturing process is recovered for the operation of our dry kilns, thus reducing greenhouse gases, the use of fossil fuels, and the burden of waste placed on landfills. Composite panels not used in the direct manufacturing process are ground and sold for use as animal bedding and boiler fuel. In addition to other energy savings techniques, our manufacturing facilities use high efficient lighting, make use of power factor capacitors, and encourage all to conserve and reduce energy consumption and water usage. Condensation pumps are used to aid in water conservation as well as extending boiler life.

MANUFACTURING PROCESSES

Our finish processes utilize efficient spray guns and proper spray techniques to reduce wasted material. Excess finish material, solvents, and waste are recycled. Many of the assembly processes use water based glues that contain no hazardous ingredients.

TEXTILES

Many of our fabric options utilize up to 100% recycled content. Our leather alternative program includes selections that contain no toxic materials, plasticizers, heavy metals, or formaldehyde and have a 100% biodegradable back cloth. Some of the available panel fabric used, if discarded is a biological nutrient for the soil. Most of the components (foam, batting, and polycord) used in upholstered products are recyclable. Excess fabrics and leathers not utilized in the upholstery process go to recyclers and local charities for additional use.

WOOD

Wood is the most diverse, most process friendly, and most widely utilized natural resource in mankind's history. No other natural resource can match the environmental advantages of wood, including being renewable, recyclable, natural, carbon negative, and biodegradable. Utilizing the sun's energy, trees grow and remove carbon dioxide from the air while giving off oxygen to benefit the entire planet. Approximately 49% of wood's dry weight is carbon and harvesting mature trees in a sustainable forest, which has slowed in the absorption of carbon dioxide, allows the photosynthetic cycle to continue at full optimization and allow for the carbon to remain sequestered. We are proud to use wood as our primary "sustainable" renewable resource.

WOOD OPTIONS

Many environmentally friendly solid wood and engineered wood options are available for quote, including: Lyptus®, Plyboo®, reclaimed woods, agricultural and post-consumer waste fiber products, etc.

INDOOR AIR QUALITY

Our goal is to reduce the impact our products will have on the indoor air quality. We practice the latest technologies and utilize a third party to assure we meet this goal. GreenGuard, one of the leaders in IAQ certification, continues to certify our product offering with UL2818 - GreenGuard Indoor Air Quality certification.

PARTNERSHIPS

BIFMA
Business and Institutional Furniture Manufacturer Association

USGBC

United States Green Building Council

IIDA

International Interior Design Association

FSC

Forest Stewardship Council - Forestland

UL GreenGuard

Indiana Department of Natural/Resources - Division of Forestry - Classified Forest, Wildlands Program

Lifetime Warranty

JSI warrants to the original purchaser that each piece of furniture will be free from defects in workmanship, given normal use and care for as long as the original customer owns and uses the product. Normal use is defined as the equivalent of a single shift, 40-hour work week.

JSI will, at its option, repair or replace with comparable product within the terms of the warranty.

Exceptions to Warranty:

12 Years (from date of purchase)

- Wood Seating
- Seating Controls
- Veneer Surfaces
- Laminate Surfaces
- Pneumatic Cylinders

5 Years (from date of purchase)

- Glides · Casters · Task Lights
- Mesh/Knit Material · Foam
- Florette Plastic Frame Chairs
- Electrical Components
- Electric Height Adjustable Bases

This Warranty Does Not Cover:

- Natural variations in color, grain or texture of wood and other covering materials over which JSI has no control.
- Normal wear, color fastness, shrinkage, puddling, wrinkling and stretching of upholsteries including fabric, vinyl, leather and other textiles. This warranty does not cover any defects that may arise in the use of COM or COL upholstery materials. Textile manufacturer's warranty will apply.
- Damages resulting from transportation, improper assembly, installation, handling, accident, user modification attachments, misuse, or neglect of product care.
- Damage resulting from extreme climate conditions.
- Finish damages resulting from normal wear and tear, improper maintenance, water damage, exposure to sunlight, extreme high or low humidity or temperature, or other acts of nature.
- Damage created by loading file drawers with anything other than hanging folders.

JSI makes no expressed or implied warranties to any product and, in particular, makes no warranty of merchantability or fitness for any particular purpose. JSI will not be liable for any consequential or incidental damages under this warranty.

Unique Characteristic of Natural Woods and Veneers

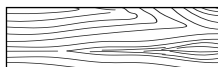
JSI uses high quality wood and veneer harvested from sustainably managed forests. Every tree has unique and defining characteristics, like fingerprints. These characteristics can be defined by differences in color, grain configuration, and textures. These characteristics will be more noticeable if the product has a clear or lighter finish.

Maple and Cherry species have a higher degree of uneven distribution of grain, small color streaks, and pin knots.

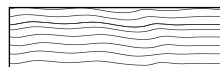
At JSI, we take care of selecting woods and veneers that are used in our products. With this in mind, we hope you appreciate the beauty of each tree's fingerprints. Products will not be replaced due to these natural characteristics.

Veneers can be sliced in a variety of ways to create unique patterns. JSI uses several different patterns, as shown below.

Flat (Plain) Cut as shown in diagram



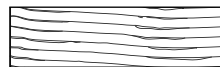
Quarter Sliced as shown in diagram



Double Cut as shown in diagram



Rift Cut as shown in diagram



Double Cut

The Double Cut veneer is a processed product that has at least two cuttings to create the final veneers. These cuts of veneer strands are dyed and layered into a block to create variation of patterns from a very tight grain pattern to an exotic figure grain pattern.

JSI uses select beech, cherry, maple, oak and walnut cut wood products to produce the desired look of our furniture products.

Laminates (Veneer Series)

An alternative HPL (Higher Pressure Laminate) laminate work surface can be specified on most of our casegood product lines. The specification pages will also list the available coordinating finishes.

Laminate Series

JSI laminate series offer a full laminated product with imprinted grain to hide finger prints and provide durability. The worksurface tops are HPL (High Pressure Laminate) or TFL (Thermal Fused Laminate). TFL is used on the product's chassis.

Please reference the featured highlights of each product line to identify the species, grain patterns, finishes for that product series

Finish - Top Coat

To reduce hazardous formaldehyde emissions, we use our proprietary specially designed top coat, DuraTex™. It significantly reduces hazardous formaldehyde emissions and helps improve indoor air quality.

Finish - Color/Stains

A wide range of stains are available to bring out the beautiful characteristics of each wood species. We coordinate finish color between our veneer stains and solid lumber stains; however, not all may be a perfect match. The stains are continually reviewed for accuracy of color, as well as a constant monitoring of the latest color trends in the furniture market.

Finish - Matching

Due to the natural characteristics of wood, environmental effects, and material upgrades, JSI cannot guarantee exact finish matches on existing furniture previously ordered.

If an exact match is required to accompany existing furniture, it must be specified at the time of order placement, so specific internal procedures can be followed to ensure a proper and acceptable finish match. We reserve the right to change our finish formula at any time to improve safety, quality, and appearance. Unless a finish match for existing furniture is requested at the time of ordering, we accept no liability for finish that may not match the existing furniture from prior orders.

Solid lumber may inherently have mineral streaks, pits, and various other natural occurrences. Care is taken in selecting the solid lumber to coordinate with the requested finish on our veneer products. This internal selection process is subject to availability of solid lumber parts.

Finish Sheen

All casegood veneer finishes are standard in 35-sheen, with the exception of Raven, which is only offered in 15 sheen. All other finishes are available in 15 sheen, with a 5% upcharge, per model

Custom/Special Finishes

JSI, upon request, will accommodate special finishes. A written request is required to proceed with custom finish orders. A sample reference is required for first time matches and must be included with the written request.

There is a one time charge of **\$372 list per order** for any non-standard wood finish.

Orders will be entered noting the special finish. A sample match will be provided to the customer. Written approval is needed before the finish process can be started. Delays in approval may have an impact on lead times.

Every effort will be made to create the requested match; however, an acceptable match may not be possible because of natural variations of wood. These natural variations can also cause minor differences in the final finish product.

Samples

Samples of standard wood finishes, paints colors, metal colors, and standard laminate are available upon request. The fastest way for requests to be filled is by using our website. See below for options to request samples.

Website – jsifurniture.com (click the resource tab)
JSI Sales representatives
Phone – 800.457.4511 – Customer Service
Email – customerservice@jaspergroup.us.com

Pricing

Prices found in this document or on our website are list prices in U.S. dollars for standard product delivery to one destination. Prices do not include storage, installation, or taxes. Possession of this price list does not constitute an offer to sell. Orders can only be received from approved authorized JSI dealers.

Prices and product information in this document, as well as our website, are subject to change without notice. Reference website for most up to date product offering and pricing.

Orders

Detailed specification pages are available in the price list at the beginning of each series.

Additional information may be obtained by consulting the Customer Service Department or our website.

Indicate shipping address if different from billing address.

Send Orders To:

US Mail – JSI
225 Clay Street
Jasper, IN 47546
Fax – 812-482-1548
Email – orders@jaspergroup.us.com

JSI reserves the right to make changes in dimensions, styles, or specifications if we believe these changes will improve the safety, quality, or appearance of the product.

Acceptance of orders will be subject to credit approval, barring any acts of governments, or any other causes beyond our control (e.g. strikes, fire, embargo of materials, etc).

Product Modifications

While we offer a wide range of products to accommodate many possible solutions, we also recognize the needs for our products to be modified from our standard offering.

In the series introduction section of each product, we address modification options for that series.

To see if the desired modification is possible, please contact our Customer Service Department for a quote. Note that order quantities and material availability can affect the quote. Additional information may be requested to fully quote modifications.

Order Acknowledgments

All orders will be acknowledged promptly upon entry of a clean order. The acknowledgment will show how the order was entered, ship date and any other information pertinent to the order. It is the purchaser's responsibility to verify all the information on the acknowledgment carefully and notify us immediately, in writing, of any discrepancies.

Every reasonable effort is made to ship as acknowledged; however, the acknowledged ship date is approximate. Company will generally ship within five (5) working days of the acknowledged ship date. If a firm ship date is necessary, customer must inform company at time of order and company will make all reasonable efforts to meet each customer's request. Acknowledged shipping dates are contingent upon the force majeure conditions contained in these terms and conditions.

Quickship

JSI offers select Vision models, with select options, in our Quickship program. These items ship within 10 business days after receipt of a clean, credit approved purchase order. Items should be placed on order separate from standard lead time models.

Product for up to 10 offices or 10 tables can be included on a single Quickship order. Available capacity is filled by orders as they are received. If normal 10 day Quickship is not available because capacity has been filled, you will be immediately notified by JSI customer service. Changes and cancellations to Quickship orders are not allowed under any circumstances, nor are modifications to the predetermined Quickship offering. Limit one order per project.

Delivery

Our freight policy consists of prepaid freight to the 48 contiguous states; all other shipments are prepaid to port of exit ONLY. JSI reserves the right to select the appropriate carrier and shipment routes, most shipments are on freight carriers that are dedicated furniture specialists. Standard deliveries require a DOCK that can accommodate **75 foot trucks**. Ownership and inspection of product is the responsibility of the buyer upon pickup by the freight carrier. Pricing in this book is for standard delivery only. Standard delivery does **not** include non-dock delivery, inside delivery, residential delivery or installation of product. Fees and changes for non-standard deliveries are listed below.

Standard Delivery Time

Between 8AM and 3PM Monday through Friday. Special delivery requests can be subject to additional fees to accommodate requests.

Cancellations and Changes

All orders are considered firm and are not subject to cancellation or change without approval from JSI. All approved changes are subject to additional charges and revised lead times

No Touch Freight

Our freight is considered "no touch". Therefore, customers are to be prepared to unload freight from inside the truck prior to arrival. In the instance that a driver must unload the shipment, driver assists fees will apply (see fees below).

On-Site Deliveries

Shipments to the installation site, and time deliveries are available on full truckloads or slightly less, at no additional charge. Shipments or timed deliveries for smaller shipments may not be available, or if available may require an additional charge.



Detention Fees

- Carriers are given two-hour maximum time allotment to unload for one-stop truckloads.
- Carriers are given one hour maximum time allotment to unload for multi-stop truckloads
- *Detention fees apply after allotted unloading time and will be at buyer's expense.

Fees

Orders of less than \$1,000 net \$90 net per order
 (If order is UPS shippable, the handling fee is waived and customer is invoiced for exact shipping charges.)
 Weekday deliveries outside of standard delivery times \$300
 Weekend deliveries (Saturday or Sunday) \$600
 Liftgate Deliveries. \$500 minimum 7% of net price
 Driver Assist \$90
 Jobsite Non-Dock Delivery \$150 per truck
 Inside Delivery (first floor inside only) - no installation or carton removal. \$250 minimum 7% of net price
 NO RESIDENTIAL DELIVERIES

Warehouse/Storage Fees

Additional storage time with a provided two-week approved notice is calculated at 3% per month of the product amount or per day.

Please be Advised

- Reconsignment fees are the responsibility of the buyer.
- Any charges arising from failure to meet shipment, re-routing while in transit or carrier storage charges are the responsibility of the buyer.
- Contact Customer Service to inquire about skidding of products, special crating of products and product installation. These requests must be approved by JSI and made at the time of order.
- Carriers have the right to refuse delivery to a specified location if it conflicts with their liability policy.

Freight Damage

JSI products are packed in cartons and meet or exceed existing codes for furniture and seating products. All shipments are delivered to the carrier in good condition and our liability ceases thereafter. If delivery arrives short or damaged, contact the carrier immediately to file a claim. In the event of concealed damage, notify the carrier and request immediate inspection. Failure to file a claim within 15 days after receipt of merchandise constitutes acceptance and a waiver of any such claims. Please inspect merchandise immediately upon receipt, otherwise there is no recourse. Keep all cartons and packing material, discarding these materials may negate your claim.

Storage of product in areas of uncontrolled humidity and temperature may cause damage to the product and void the JSI warranty.

Repairs

JSI will not issue credit allowance for any type of repairs without prior written consent.

Sales order, product model numbers, and reason for repair will be expected in order to process the repair request. A digital photo will help to expedite the request. JSI reserves the right to recommend solutions for repair.

Replacement Parts

Obtain information and pricing on replacement parts by contacting Customer Service. Please have the model number available when requesting replacement parts. Additional information may be required to ensure proper replacement parts.

Returns

JSI products are made to order and may not be returned for credit. No merchandise may be returned to JSI without a signed Return Good Authorization (RGA) form issued by our Customer Service Department. RGA's will be considered for the following reasons:

1. Manufacturing defect (validated by JSI representative).
2. JSI order processing error.
3. Shipping error.
4. Mis-marked cartons.
5. Duplicate shipments.

Liability for defective merchandise shall be limited to replacement or repair.

If you have questions as to whether your reason for return qualifies for consideration, please contact Customer Service. At the discretion of JSI, returns on stocked items may be considered with the following stipulations:

1. 60% restocking fee.
2. All return freight charges must be prepaid by dealer.
3. Product was never removed from the original carton.
4. Product must be returned within 30 days of RGA issue date.
5. Credit will not be issued if product returned is damaged.
6. Under no circumstances can we accept COD (Cash on Delivery) returns. Any such shipment will be refused.

Please note most models on Quickship are produced on demand and cannot be returned. Modified, special or custom-built product is not eligible for return.

Fire Retardancy

All JSI upholstered components comply with California Bureau of Home Furnishings and Thermal Insulation-Technical Bulletin 117-2013 issued by State of California Department of Consumer Affairs. This standard requires upholstered furniture to be safer from the hazards associated with smolder ignition in all four (4) categories of materials, as applicable.

Compliance with more stringent codes may require special manufacturing considerations and upcharges.

California Technical Bulletin 133 (CAL 133)

JSI uses a barrier material between the foam cushioning and the upholstery cover in order to comply with CAL 133. The standard upcharge on products specified to comply with CAL 133 is **\$78 list per yard** of textile.

JSI has performed a series of full scale fire tests on samples - representing worst case scenarios of upholstered units - to comply with the requirements of the state of California Technical Bulletin 133 (CAL 133). Products in compliance are labeled in accordance of the standards.

Some product designs and fabric cannot be combined to comply with CAL 133. Because of this, we reserve the right to reject any request for an upholstery cover, including COM, textile may not contain olefin or product style that we feel may compromise the integrity or safety of a product specified to comply with CAL 133.

Contact Customer Service for a quote if you require laboratory certification that a specific product and upholstery combination WILL PASS CAL 133. The quotation will include testing, video, and transportation charges plus the list cost of the sample.

Our standard lead time will apply to products that do not require certification. Allow an additional six weeks over the standard lead time for products that need actual laboratory certification.

The end user, specifier and/or dealer have the responsibility to make sure all products specified will meet the flammability and safety codes of the jurisdiction where the products will be located and used.

Flame Spread

All JSI may be required to comply with the requirements of Flame Spread based on ASTM standards/NFPA Life Safety Codes and general public knowledge are as follows:

Solid Wood - Class C
 Topcoats - Class A
 Carded Fabric - Class A
 Composite Panels - Class C
 Laminate - Class B

Plastics - According to the NFPA, the lack of stability of plastics under high temperature conditions and inherit combustibility have eliminated the use of plastics for applications requiring a flame spread rating.

Also be advised that improvements may be attained in certain instances with the addition of chemicals which may add additional costs, chemical exposure and/or compromise the integrity of the product.

Textile Carded Programs

JSI is proud to partner with Maharam, Momentum, Spradling, Stinson, Ultrafabrics, Camira and Cortina Leather. Please refer to our website for our standard patterns, along with the current grade.

<https://www.jsifurniture.com/finishes-and-materials/textiles>

Textile Grade-In Programs

For the convenience of our specifiers, we offer an extensive graded in program. Please reference our website for the most up to date information on our graded in program.

<https://www.jsifurniture.com/resources/textile-partner-info/overview/>

For additional specifications on the pattern or to order memo samples, please contact the textile suppliers directly:

Arc Com www.arc-com.com
 Camira www.camirafabrics.com
 Designtex www.designtex.com
 Maharam www.maharam.com
 Mayer www.mayerfabrics.com
 Momentum www.themomgroup.com
 Spradling www.spradlingvinyl.com
 Stinson www.cfstinson.com
 Ultrafabrics www.ultrafabricsllc.com
 Cortina Leather www.cortinaleathers.com

Any textile not graded in or pre-approved for COM/COL will require application test approval prior to order entry and shipment of fabric or leather to JSI. For current JSI grades and application status by series visit jsifurniture.com Resources > Graded-In + COM; [Graded-In + COM](http://jsifurniture.com).

Indicate on purchase order if JSI is to order the fabric.

Grades and availability of fabric are subject to change without notice. Changes could include but are not limited to price increase, discontinued patterns, discontinued colors, etc. See jsifurniture.com for up to date information.

Many textiles have repeats and the additional yardage required has been factored in for textiles ordered through the JSI Carded and Grade-In Programs. We reserve the right not to match textiles with a horizontal or vertical repeat greater than 17". Additional charges may apply for textile being applied with special instructions.

Some fabric thickness or stiffness may cause issue with proper upholstering of tackable wall panels or upholstery privacy screens. Please contact customer service with concerns on the fabric thickness for these items.

COM/COL Address

JSI
 Attn: COM/COL Department
 Receiving B
 Dock 71
 201 East Martin St.
 Orleans, IN 47452

Tag: Dealer Name / Purchase Order #

General COM Fabric/COL Hide Policy

Refer to the COM/COL Price Columns for list prices.

All yardage requirements listed in the price list are based upon 54" plain non-directional material. Additional yardage may be required based on fabric repeat and matching.

All square footage requirements for COL are based on an average hide size of 50 square feet.

Contact Customer Service for any of the following conditions:

- + approval of COM/COL to be used (see policy on the next page)
- + fabric repeats greater than 3"
- + fabric less than 54" wide
- + leather hides smaller than 50 square feet
- + special application requirements request

When requesting information from Customer Service on COM/COL please supply the following information:

- + model number and quantity of the product the COM/COL will be applied
- + COM/COL textile supplier's name
- + name of pattern and color of the textile
- + any special application request

Visit jsifurniture.com Resources > Graded-In + COM to see if the textile has already been approved. If there is no record for this particular textile then a Memo Sample will be required.

JSI takes no responsibility when additional materials must be ordered.

COM Fabric Repeat Guide

Roll Width	Plain Fabric	1" - 5" Repeat	6" - 10" Repeat	11" - 15" Repeat	16" - 20" Repeat	21" - 30" Repeat	31" - 40" Repeat	41" - 50" Repeat
54"	0%	10%	15%	20%	25%	30%	40%	50%
53" to 51"	15%	20%	25%	30%	35%	40%	50%	60%
50" to 48"	30%	35%	40%	45%	50%	55%	70%	90%
47" to 36"	60%	65%	70%	75%	80%	85%	100%	120%

The percentage represents the additional fabric yardage that needs to be added to the COM yardage. Contact Customer Service for repeats greater than 50".

All COM/COL must meet applicable codes and regulations, including TB117-2013. By selecting COM/COL, customer certifies that the material meets such codes. JSI assumes no responsibility for the applicable codes and regulation regarding flammability rating and safety rating of any COM/COL.

JSI cannot be held responsible for receipt of defective fabrics, as we apply all COM as first quality goods.

We can take no responsibility for tailoring, wear-ability or application of COM/COL textiles. Any warranty claims for the COM/COL Textile materials will fall to the original vendor of the textile, not JSI.



COM Fabric/COL Hide Process for JSI Seating

General COM Fabric and COL Hide Policy also apply.

JSI will approve or disapprove COM/COL on all products. An approval of a textile from JSI makes no claim that performance, durability or tailoring of COM/COL will result in satisfactory upholstery. Every effort will be made to meet customer's expectation, but fabrics/leathers have unforeseen inherent characteristics that may limit JSI's ability to deliver a well tailored product.

Approval COM Textile/COL Hide Process for Seating

Follow the Steps Below:

1. Send a Memo Sample of the COM/COL (recommended memo be at least 4" x 4")

JSI

Attn: COM/COL Approval Department

201 East Martin Street

Receiving B, Dock 71

Orleans, IN 47452

2. Call our Customer Service Department at 812-482-3204 to request an electronic version of approval form.

Please send sample to:
JSI
Attn: COM/COL Approval Depart.
201 East Martin St.
Receiving B, Dock 71
Orleans, IN 47452

Please forward a copy of this form
to your JSI CSR for record keeping

Guide Order Form for COM and COL

① **Order Information:**

Quote #: _____ **Purchase Order #:** _____

Customer Service: _____

Dealer Name/Project Name: _____

Contact: _____

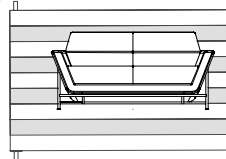
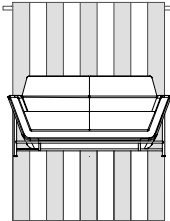
Address: _____

Phone: _____ **Email:** _____

Model Number(s) Receiving COM / COL: _____

② **Select off the bolt application:** *(Check one of the boxes)*

- Up the roll (standard on most seating) Railroaded



③ **Additional information:**

④

Attach sample here.

JSI will review and test as needed all requests. You will be notified as soon as results are documented by our review personnel. JSI reserves the right to reject any COM/COL on our products. We will provide COM/COL explanation of any unapproved textile whenever possible.

Custom Options

Wood Laser Engraved Back

Many of our seating models are available with a custom wood laser engraved back. University seals, logos, unique designs, or any type of graphic can be designed into the seating back for a custom creation. Copyright approval may be required. Consult JSI Customer Service for pricing and artwork specifications. Artwork must be submitted as a JPG or PDF file.



Wood Laser Engraved Back General Pricing

* must order plain back when choosing these options

For Artwork 4" x 4" or Less	\$56 list per chair
For Artwork Less than 6" x 6"	\$99 list per chair
For Artwork Larger than 6" x 6"	Call For Pricing

For orders fewer than 50 pieces, add \$153 list per design, per order. This pricing reflects etching (leaving the wood dark). If additional painted colors are added to artwork please call customer service for pricing.

A \$134 list set-up fee applies.

Care and Maintenance

Care and Maintenance

Care of Upholstery Surfaces

Cleanability will vary based on the fabric type. For best results, a professional service is recommended. Dirt and crumbs may be gently brushed or vacuumed off. Spills should be wiped up immediately with a cloth. Vinyl textiles can be cleaned with warm soapy water and then wiped down with a warm damp cloth. For more details on any JSI carded fabric and vinyl, please visit our website at jsifurniture.com or consult the back of the appropriate swatch card for cleaning codes and any specific instructions. For COM materials, consult with the individual textile manufacturer for cleaning codes and any specific instructions pertaining to your particular fabric.

Maintenance of Mechanical Parts

Clean any lint or debris from the moving parts of the base mechanisms. Mechanisms have been designed and tested to not require lubrication under normal conditions; however, lubricant can be used if needed.

Care of Wood Edges and Veneer Surfaces

Clean all surfaces frequently with water dampened soft cloth, moving the cloth with the grain direction. Immediately remove any liquids that come in contact with wood surfaces with a blotting action to absorb liquid. Buff dry. Lift objects to move them, never pull them across the finished surface. For an additional safeguard, use a protective surface pad. This will ensure a lasting finish by protecting your furniture from possible damage caused by pens, cups and sharp objects. Avoid exposure of furniture to extremes of heat and cold, or to wide humidity variances. Avoid exposure of furniture to strong sunlight. Avoid exposure of furniture to harsh solvents such as nail polish remover, acetates, etc., as it will cause finish deterioration. If using a protective glass top, place spacer pads under the glass top to allow the wood to breath.

Care of Metal Finishes

Wash you powder-coated item at least one every six months. Use soft rags only - No abrasives. For stubborn stains and grease marks, use soap and water mixture. Combine 1 gallon of water and 1 cup of the neutral detergent in the bucket. Mix it up by swirling one of the rags around in it. Wipe down the powder coat with a rag that has been dampened with the cleaning solution. Do not scrub, but use gentle, repetitive pressure to remove any built-up grime. Rinse the powder coat off with a rag dampened with clear, clean water. Do not spray it down, but rather wipe it off with the rag. You may need to do this several times to get all the soap off. Wipe the powder coat down with a clean dry rag. This will prevent streaking and spotting.

Care of Frosted Glass

Use a clean, dry lint free cloth to wipe the surface. Follow with warm water and a clean rag; no soap or chemicals. Wipe dry with a clean, dry lint free cloth. Cleaning the frosted side is not recommended, if desired to clean use the above method but do not spray the water on the frosted side, use a clean rag. Please allow 48 hours for the frosted side to dry and not to show cloudiness.

Tempered Glass Information

JSI is aware of occasional occurrences of spontaneous glass breakage in various furniture products. Tempered glass makes it stronger and if it breaks, will cause it to break into many small pieces of "cubes" rather than sharp and potentially dangerous shards.

Glass breakage in furniture may occur for a variety of reasons. Tempered glass is particularly prone to breakage from damage (scratches, nicks, etc.) that may occur during shipping, handling, installation, use or maintenance. Exposure to rapid changes in temperature or concentrated temperature zones may also cause breakage.

Tempered glass may also break due to a specific type of imperfection or "inclusion" that occurs within the glass when manufactured. When this condition exists glass breakage may occur without any obvious cause. This is often referred to as "spontaneous" breakage but is a very isolated occurrence in the glass industry.

Care of Dry Erase Boards

Erase after every use to eliminate ghosting. Clean weekly with a Dry Erase Cleaner. Avoid the use of orange and red Dry Erase Markers. Follow manufacturers cleaning instructions for the eraser. If ghosting or staining remains use a small amount of rubbing alcohol on a clean, soft towel to remove.

Care of Solid Surface

Although liquids cannot penetrate Solid Surface, it is best to wipe up spills as they occur. Generally, a damp microfiber cloth used with a standard household kitchen spray should remove most stains.

For most residues, all you need to clean your Solid Surface countertops is a warm soapy water, ammonia-based household cleaner or a dedicated countertop cleaner. Do avoid window cleaners; however, as they can leave a waxy build-up that dulls the surface. Always clean using a circular motion.

Film will build up on countertops if water is left to dry on the surface. This film will dull the countertop surface, making the finish appear blotchy and uneven. To prevent film build-up, it is very important to wipe the countertop completely dry immediately after spills and cleaning.

Some color of Solid Surface may require more frequent cleaning to maintain a uniform finish. Darker colors tend to require more attention than lighter colors. Over time, even with proper care, your countertop will acquire a sheen. Dark colors may show light scratches more readily.

Specification Tools

JSI products are manufactured to order and provide a multitude of options to address your individual customer needs. As you process your order do not forget to include all the necessary information to allow the order entry process to be completed. Please see the order checklist at the beginning of every series.

JSI Customer Service edits every order for complete information. If details are not included with the purchase order, Customer Service will contact you to answer these questions. If information is not completed in a timely manner it will delay the entry process and could affect your product delivery date. To avoid delay in order entry and potential delay in delivery of your order, please double check the line items to ensure all selections have been completed.

To ensure completion of details on your purchase order, electronic catalogs and specification tools have been developed to aid in the process. These electronic tools include:

20-20 GIZA Studio and 20-20 CAP Studio software offers state-of-the-art design, specification, photo-realistic rendering and three-dimensional visualization capabilities for configurable products in the commercial interior design markets. 20-20 GIZA Studio and 20-20 CAP Studio are available for all JSI Casegood and Seating products, in 2D and 3D graphics and the Specifier Catalog. Updates are made monthly reflecting any changes that occurred. To be sure the most up to date information is provided on orders, users of this software program are responsible to update their catalogs.

CET Designer, by Configura is an all-in-one software solution for space planning and configuration of products. The intuitive workflow guides you through entire process from idea to reality - supporting every step of the sales process

ProjectMatrix, Inc. offers a full software solution for the contract furniture industry. Their software can help you create space plans to specifications for ease of specifying our JSI Casegood and Seating product lines. Updates are made monthly reflecting any changes that occurred. To be sure the most up to date information is provided on orders, users of this software program are responsible to update their catalogs.

GSAdvantage is a Federal Government electronic catalog site offered to assist GSA customers in specifying and pricing JSI product. Listed at this site are all contract items and prices under GSA Contract # GS-28F-0030U.

Our JSI website jsifurniture.com provides many tools to assist in the design and order selection. Included in the site are downloadable images, typicals, product symbols, brochures, contact information, price lists, sales representative locations, warranty and environmental information.

GSA Terms and Conditions



Contract Holder
Contract # GS-28F-0030U

In addition to the standard terms and conditions, the following terms and conditions apply to GSA contract.

Contract Number
GS-28F-0030U

Contract Period
June 24, 2013 - June 24, 2028

Statement of Intended Use
The furniture covered by special item number 33721 Office Furniture shall comply with the requirements defined in purchase description 3QSAB 09-608. All furniture offered under this SIN shall be GSA Chassis Grade 1, 2, 3 or NA, GSA Drawer Grade 1, 2, 3, 4 or NA, Design A B or C, as defined in 3QSAB 09-608.

Description of Special Item Number SIN #33721

Cooperative Purchasing
No

Set Aside
No

FSC/PSC Code
7125

NAICS 337211 Wood Office Furniture Manufacturing 1000 employees

Includes all furniture placed in an office, such as chairs, desks, etc. In addition, ancillary services are included, however services performed shall not be the primary purpose of the work ordered.

Lowest Price Model

SIN #	Model Number	Net Price
33721	VS-LBRKT-20	\$28.03

Maximum Order
\$250,000 net

Geographic Coverage
48 contiguous states and Washington D.C.

Point of Production
Jasper, Dubois County, Indiana
Orleans, Orange County, Indiana

Discount
Discount 61.6%* off list.

*Discount for Walden and Wellington is 61.71% off list.

Discount Quantity
Walden and Wellington only
\$300,000 to \$350,000 Net = 0.5%
\$350,001 to \$400,000 Net = 1%
\$400,001 to \$450,000 Net = 1.5%

Prompt Payment Terms
1% 15 - net 30 days from date of invoice.

Government purchase cards are accepted at or below the micro-purchase threshold

Government purchase cards are accepted above the micro-purchase threshold

Foreign Terms
Not applicable.

Time of Delivery
30-75 days after receipt of order, 90 days maximum.

Expedited Delivery
Contact Customer Service 800-457-4511

Overnight and 2-day Delivery
Not applicable.

Urgent Requirements
Contact Customer Service 800-457-4511

F.O.B. Points
F.O.B. destination, freight prepaid and allowed to 48 contiguous states and Washington D.C. excludes special delivery requirements.

GSA Terms and Conditions

Ordering Address

Jasper Seating Company, Inc. d/b/a JSI
Attn: Participating Dealer
225 Clay Street
Jasper, IN 47546
Fax: 812-482-1548
Phone: 800-457-4511
Email: orders@jaspergroup.us.com

Order Procedures:

Per contract

Payment Address

JSI
225 Clay Street
Jasper, IN 47546

Warranty Provision

Limited Lifetime

Export Package Charges

Quoted on project-by-project basis.

Terms of Government Commercial Credit Card Acceptance

Accepted.

Rental, Maintenance, and Repair

Not applicable.

Terms and Conditions of installation

12% of net purchase order for installation services up to \$250,000.00 of net purchase price.

Terms and conditions of repair parts, etc.

See warranty.

List of service and distribution points

Contact Customer Service 800-457-4511.

List of participating dealers

Contact Customer Service 800-457-4511.

Preventive Maintenance

N/A

Environmental Attributes

GreenGuard Certified and recycled wood waste and fabric remnants

Section 508 Compliance.

N/A

DUNS

00-636-7767

CCR and SAMS Registration

Jasper Seating Company, Inc. is registered
Cage Code #31881
Federal ID #35-0420370
UEI #DDJ2GKQM7M84

Product Modifications

We willingly accept customers' modifications to standard products. See product modification information by series at the start of each series under the "Product Modification" sections. If there is a modification you desire that is not listed in this section, please call Customer Service for a modification quote/price

Acceptance, Modification, Assignment

By placing this order for furniture, material or other products (sometimes collectively referred to as "goods"), customer agrees to these terms and conditions which shall prevail over inconsistent provisions in any other form or document of customer. No change or modification shall be applicable unless set forth in writing and signed by company. Neither this order nor any interest therein shall be assigned by customer except with the prior written consent of company.

Payment

Customer agrees to pay to company the amount indicated on the invoice, 1% 15 days, net 30 days from date of invoice (U.S. funds only), for goods ordered. Interest will be charged after 30 days from the date of invoice at the rate of one and a half percent (1.5%) per month. International sales will require additional payment arrangements. No goods shall be sold on consignment or conditional sales basis. Payment for the goods delivered hereunder shall constitute acceptance thereof.

Attorneys' Fees

Customer shall be responsible for all expenses and cost in connection with the enforcement by company of these terms and conditions and the cost of collection (including the fees of any collection agencies to whom the customer's account may be referred), plus reasonable attorneys' fees (which attorneys' fees shall not be less than 25% of the amount due, unless a lower amount is specified by applicable law).

Remedies

The remedies herein reserved shall be cumulative, and additional to any other or further remedies provided in law or equity. No waiver of a breach of any provision of these terms and conditions shall constitute waiver of any other breach or of such provision.

Insolvency

Company may forthwith cancel this order in the event of the happening of any of the following or any other comparable event: insolvency of the customer, the filing of a voluntary petition in bankruptcy, the filing of any involuntary petition to have customer declared bankrupt provided it is not vacated within thirty (30) days from the date of filing, the appointment of a receiver or trustee for customer provided such appointment is not vacated within thirty (30) days from the date of such appointment, or the execution by customer of an assignment for the benefit of creditors.

GSA Terms and Conditions

Limitation of Liability

The Company shall not under any circumstances be liable to the customer, owner of the goods or any third party for special, indirect, incidental, or consequential damages, including, without limitation, loss of profits or revenues, loss or damage to other property or equipment, cost of capital or of purchased or replacement goods, or expense, delay, or inconvenience cause by or arising from the purchase, sale, use, repair or inability to use the goods or by any performance or non-performance under, or breach of, these terms and conditions. The Company's sole liability for any defective goods shall be its repair or its replacement pursuant to the express warranties set forth above, or if amended, as applicable at the time of manufacture or repair of the goods. Some states do not allow the exclusion or limitation of incidental or consequential damages, so the above limitations or exclusion may not apply to all customers. Any action resulting from any breach on the part of company as to the goods or services delivered here under must be commenced within one year after the cause of action has occurred.

Returns and Allowances

Reasonable touch-up and deluxing is the dealer's responsibility. The Company will not make allowances for trip or delivery charges, but will only make allowance for actual work performed to correct manufacturing defects. Allowances maybe authorized only by a company officer. It is the responsibility of the field sales representative to inspect any defective merchandise and make suggestions and recommendations as to the proper disposition. Field personnel cannot obligate or bind the company by definite agreement, without final authorization by a company officer. Company will not accept automatic charge backs which do not have prior authorization. All defects must be called to the company's attention upon arrival at the customer's "ship to" destination. To initiate any type of claim or request for parts, it is imperative to have the model number or fabric number, which may be located on the tag attached to the frame of the unit. Authorization for return to the company via a return goods authorization. Company will not issue credit allowances for any repairs without company's prior consent. Under no circumstances shall the company accept COD (cash on delivery) returns, and any such shipment will be refused.

Security Agreement

The Company may require and customer shall grant a security interest in goods sold pursuant to any credit the company may extend to the customer.

Governing Law

All disputes between the parties, whether or not arising out of these terms and conditions, will be governed by the laws of the state of Indiana. Customer agrees to submit to the jurisdiction of and agrees all lawsuits relating to any disputes between the customer and the company will be brought only in a state court located in Dubois County, Indiana or the United States District Court for the Southern District of Indiana. The customer hereby waives the right to a trial by jury in any action, proceeding, claim, or counterclaim whether in contract or tort, at law or in equity, arising out of or relating in any way to these terms and conditions and all other disputes between the parties.

Mitigation

If the company repossesses the goods prior to payment by the customer of all amounts due hereunder, the company may sell the goods, as is, where is, free and clear of all rights of the customer at either public or private sales, and apply the net proceeds (after deducting expenses of repossession and sale) to the obligation of customer hereunder. The customer may dispose of the goods in any commercially reasonable place and manner and the customer waives any notice of time, place and manner of sale.

Integration

This order for goods, including these terms and conditions, along with any credit application, invoice, statement, dealer contract, acknowledgment, bill of lading (and any exhibits, addenda or amendments thereto) of which this order may be a part, constitutes the sole and complete agreement between the company and the customer with respect to the purchase of the goods.

Dimensions/Specifications/Finishes

All dimensions are approximate and may vary due to the upholstery technique of each craftsman. If exact dimensions are required, it is necessary for the customer to state such specifications with the order. Detailed specifications sheets are available for each series of goods, and customer should consult the company's customer service department for these specification sheets. Company reserves the right to make changes in dimensions, style, or specifications if company believes these changes will improve the goods' quality or appearance. Company reserves the right to substitute hardwoods due to availability at production. Due to the natural characteristics of wood, environmental effects, and material upgrades, the company cannot guarantee exact finish matches on existing goods previously ordered from company. If an exact match to customer's existing goods is required, it must be specified so that the proper procedures can be followed to ensure an acceptable finish. Company will accept no liability for the finish if this procedure isn't followed. Company reserves the right to make changes in a finish formula if company believes the change will improve the quality or appearance of company's goods.

Company's Performance of Its Obligation

The production and delivery of the goods to the extent delayed or hindered or prevented from the performance by reason of natural disasters, acts of god, strikes, lockouts, labor troubles, inability to procure materials, casualties, failure of power, restrictive governmental laws or regulations, riots, insurrections, acts of terrorism, war or other reason of a like nature not the fault of the company shall excuse for the period of the delay the company's performance and the period for the performance shall be extended for a period equivalent to the period of such delay.



Desks	AP34
Consoles	AP41
Meeting Tables.	AP42
Bridges	AP42
Returns	AP43
Credenzas.	AP46
Lateral Files	AP47
Modular Credenzas	AP52
Overhead Cabinets.	AP72
Wall Mount Storage	AP86
Wall Panels	AP100
Wall Mount Tackboards.	AP101
Vertical Storage Units	AP105
Workwalls	AP123
Accessories	AP139

Apogee™ - Overview

Desks



Double Pedestal Desk with Full Modesty Panel



Veneer Table Desk with Open Frame Leg



Glass Table Desk with Open Frame Leg



Single Pedestal Desk with Full Modesty Panel

Peninsula Desks



End Panel Desk



Access End Panel Desk

Run-Off Desks



Rectangular Pedestal Run-Off



Table Desk with Open Frame Leg



Rectangular Desk with Post

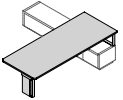


Arc Run-Off Desk

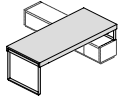


Trapezoid Run-Off Desk

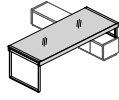
Console Desks



Console Desk with Leg Support



Console Desk with Open Frame Leg



Console Glass Desk with Open Frame Leg

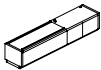
One-High Console Return



Low Console Bridge



Low Console Connector with Hinge Door



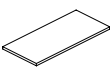
Freestanding Low Console Return

Meeting Table

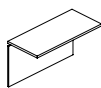


Meeting Table

Bridges



Bridge Top



Bridge with Modesty Panel

Apogee™ - Overview

Returns



Return



Lateral File Return

Return Shells

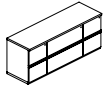


Return Shell

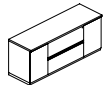


Return Shell with Wall Access Panel

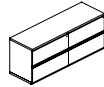
Credenzas



Storage credenza



Storage credenza



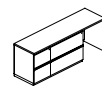
Lateral File Credenza



Open Corner Credenza



Open Corner Lateral File Credenza



Open Corner Credenza

Freestanding Lateral Files

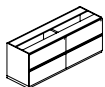


Two-High Lateral File



One-High Lateral File

Two-High Modular Credenzas



Two-High Lateral File



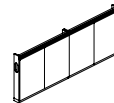
Two-High Lateral File



Utility/Box/File Pedestal



File/File Pedestal



Kneespace Access Panel, Full Height

End Support



End Support



End Panel Transition to Access Panel

Apogee™ - Overview

One-High Modular Credenzas



One-High Lateral File



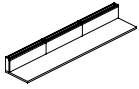
One-High Lateral File



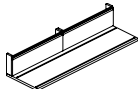
One-High Pedestal

APOGEE™

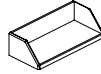
One-High Kneespace Units



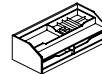
Kneespace Access Panel, Partial Height with Workwall Top



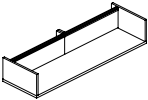
Workwall Top with Shuttle Tracks and Access Panels



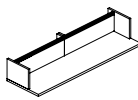
Storage Shuttle



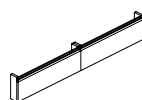
Piling Shuttle



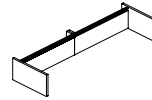
Kneespace Access Panel, with 22\"/>



Kneespace Access Panel, with 15\"/>

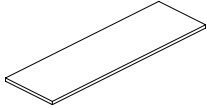


Kneespace Access Panel, Partial Height



Kneespace Access Panel with Extensions, Partial Height

Workwall Top



Workwall Top

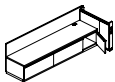
Modular Credenzas



Two-High Run-Off Lateral File Credenza



Two-High Run-Off Lateral File Credenza



One-High Run-Off Credenza with Access Door



One-High Run-Off Credenza



Utility/File Mobile Pedestal



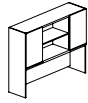
Utility/File Mobile Pedestal with Cushion Top

Apogee™ - Overview

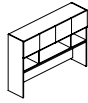
Double Height Storage Overhead Cabinets



Double Height Storage Overhead Cabinet with Doors

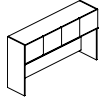


Double Height Storage Overhead Cabinet with Doors and Open Center Shelf



Double Height Storage Overhead Cabinet with Doors and Open Storage

Storage Overhead Cabinets



Storage Overhead Cabinet with Doors



Overhead Cabinet with Doors and Open Center Shelf



Storage Overhead Cabinet with Flipper Doors

Double Height Wall Mount Overhead Cabinet



Double Height Wall Mount Overhead Cabinet with Open Storage



Double Height Wall Mount Overhead Cabinet with Doors



Double Height Wall Mount Overhead Cabinet with Doors and Open Storage

Wall Mount Overhead Cabinet



Wall Mount Overhead Cabinet with Open Storage



Wall Mount Overhead Cabinet with Doors



Wall Mount Overhead Cabinet with Flipper Doors

Open End Shelves



Open End Shelves



Open End Shelf

Valance



Valance

Overhead Support End Panel



Overhead Support Panel

Apogee™ - Overview

Wall Panels

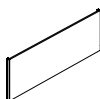


Wall Panel

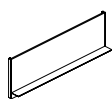


Wall Panel with Shelf

Wall Mount Tackboards

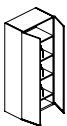


Wall Mount Tackboards

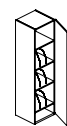


Wall Mount Tackboards with Shelf

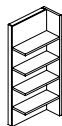
Worksurface Storage Towers / Asymmetric Shelves



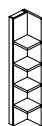
Storage Tower



Storage Tower

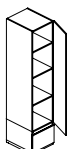


Asymmetric Shelves

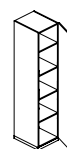


Asymmetric Shelves

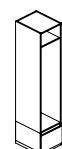
Storage Units



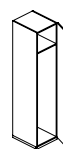
Storage Unit with Drawer



Storage Unit



Wardrobe Unit

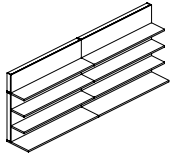


Wardrobe Unit

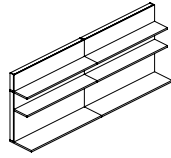
APOGEE™

Apogee™ - Overview

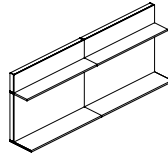
Workwalls with Shelves



Dual Open Workwall with 3 Shelves

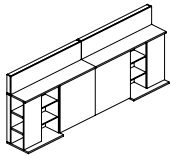


Dual Open Workwall with 2 Shelves

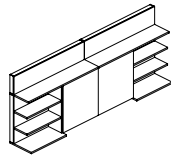


Dual Open Workwall with Shelf

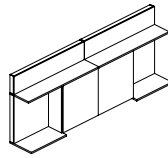
Workwalls



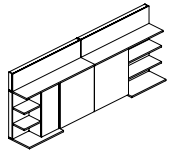
Dual Wardrobe Workwall with Sliding Doors



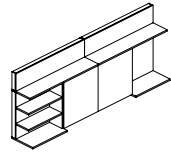
Dual Shelf Workwall with Sliding Doors



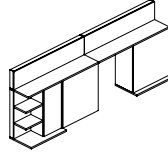
Dual Display Workwall with Sliding Doors



Wardrobe Workwall and Shelf Workwall with Sliding Doors

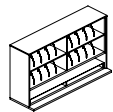


Shelf Workwall and Display Workwall with Sliding Doors

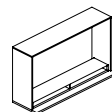


Wardrobe Workwall and Display Workwall with Sliding Doors

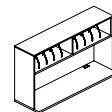
Workcenters



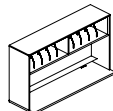
Workcenter



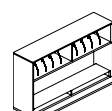
Media Workcenter



Workcenter

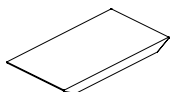


Workcenter with Mini Shelf

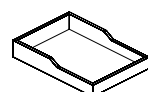


Workcenter

Accessories



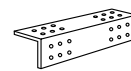
Leather Desk Pad



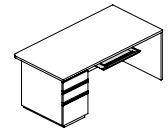
Paper Trays



Magnets



Angle Bracket



Angled Front Center Drawer

APOGEE™

Apogee™ Product Information

Wood Materials

Exterior surfaces are made from the finest selected veneers. Matching solid lumber wood species are used to coordinate with the veneer. High quality MDF is used on the painted surfaces.

Apogee™ is available in quarter cut Walnut, quarter cut Maple, quarter cut Makore or Double Cut veneer.

Exterior Metal Materials

A custom shaped extruded anodized aluminum pull is used on the drawers and doors. The thin profile glass door frame is also anodized aluminum, along with the valance rail used with task lights on overheads.

Leg and Post frames are fabricated steel tubing finished with a Bright White or Arctic Silver powder coat. Shelf dividers, wire dividers, and other metal trims are fabricated and finished in a matching Silver powder coat.

Metal Finishes

ASL Arctic Silver BWH Bright White

Worksurface Construction

All tops are 1 3/16" thick with 3-ply construction and trimmed off with matching 1.5mm rims. Worksurface tops are only available in the Apogee™ veneer options. Requests for laminated tops will need to be reviewed for approval, contact Customer Service.

Case Construction

All cases are constructed with mortise, tenon, and dowels. Interior cases are reinforced with glued cleats and screws. Panels for cases are normally 3/4" thick with 3-ply construction. All pedestals have enclosed bottoms.

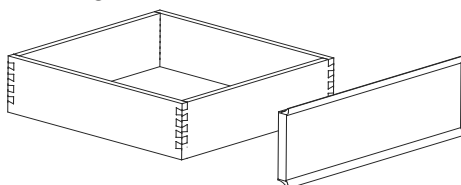
Plinth style bases are attached directly to the bottom of the cases. The metal glide housing inside the base provides for accurate leveling. Front and back glides in drawer pedestals can be adjusted up and down by removing the lower drawer and using the glide access hole located in the bottom of the case.

Cabinet doors have 110° swing hinges to allow adequate access into cabinets. Hinges are fitted with a soft close device, requiring only a soft push to close the door. Units taller than 18" are fitted with an adjustable shelf.

Drawer Construction

Drawers are assembled using a four corner dovetail box and 3/4" thick drawer bottom panel construction. The exterior front is attached separately. Sides and backs are approximately 1/2" thick solid hardwood. Drawer components have a UV finish to protect against shrinking, swelling, or warping and to provide a clean smooth feel and appearance. Lateral files have reinforced bottoms.

The exterior front panel is 3-ply and 3/4" thick. The front is attached to the assembled drawer box. The anodized aluminum pull runs along the top or bottom edge of the drawer front.



box drawer and front with pulls (middle drawer)
wood drawer box - DRW

Drawer Suspensions

Suspensions are black and carry a lifetime warranty. File and Box drawers have 100% full extension with over travel. Slides feature steel ball bearings for longer wear. Suspensions on utility, box and file drawers have a soft close device, allowing for an effortless closing of the drawer.

Filing Systems

All drawers intended for filing come with clips and metal stretchers to accommodate hanging folders.

Finish - Stain/Colors

We offer a variety of wood stains and paint colors on Apogee™. Please see the chart below. Samples are available upon request.

MK2 Makore *Quarter Cut Veneer*

BBM Bourbon Medium	HRV Harvest
BRM Brighton Medium	HRV Harvest
CLA Classic	PRL Praline
CLL Collectors	PRL Praline

MA2 Maple *Quarter Cut Veneer*

ALM Ale Medium	FLX Flax
BUT Butterscotch	VEN Venetian

WA2 Walnut *Quarter Cut Veneer*

ESP Espresso	TRF Truffle
MCH Mocha	UMB Umber
SIE Sienna	

B01 Black Oak *Flat Cut Veneer*

RAV Raven

DC1 Double Cut Veneer

COF Coffee	KHK Khaki
FAW Fawn	STU Studio Teak
GRH Graphite	VAL Valley

PNT Paint *MDF Board*

BKD Backdrop	GRV Greek Villa
BFX Black Fox	NET Network Gray
BWH Bright White	NWH Nonchalant White
CGP Cargo Pants	STM Storm
CHT Chatroom	TRC Tricorn Black
FRR French Roast	

Protective Top Coat

DuraTex™ offers exceptional hardness along with abrasion and impact resistance, it has been formulated to eliminate hazardous and harmful gases that are normally associated with wood finish.

DuraTex™ Features

Safety - Significantly reduces hazardous formaldehyde emissions which help improve the quality of the indoor air we breathe. Quality - Developed to be tough and durable with special attention to appearance. The DuraTex™ finish preserves the natural beauty of wood. Durability - Designed to meet a wide range of demanding performance and environmental standards to withstand even the highest wear and tear.

Apogee™ Product Information

Product Modification

Special Finishes

Special finishes can be requested by following the instructions in the general introduction section. There is a one time charge of \$372 list per order.

Finish Sheen

All veneer finishes are standard in 35-sheen, with the exception of Raven. Raven is only offered in 15 sheen. All other finishes can have their sheen modified with a 15% upcharge added to the list price of each item.

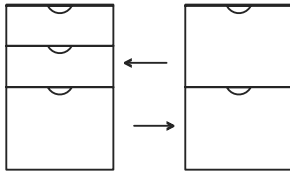
Premium Veneer

Upon request standard veneer can be changed to a special veneer contact Customer Service for availability and pricing.

Pedestal Configuration Change

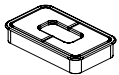
Utility/Box/File configuration is standard on all desks and File/File configuration is standard on all return units.

Apogee drawer configuration on pedestals 29½" high can be reconfigured to a Utility/Box/File or File/File configuration, but must be specified at the time of order with an additional \$189 list per pedestal.



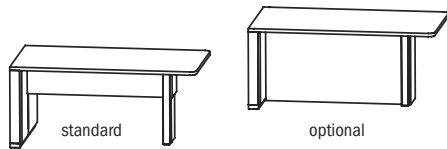
Grommets

Please see [page AP20](#) for location and placement availability. Add \$114 list for each grommet.

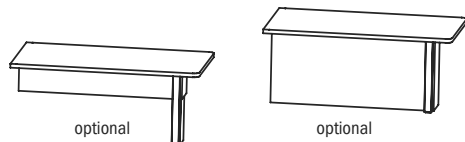


Modesty Panel

End Panel Desks are standard with a partial modesty. A full modesty is available as an option and should be ordered with the desk. See price list pages for availability and pricing.

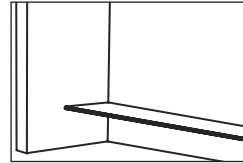


Run-Off Desks are standard without a modesty. Optional partial or full modesty may be specified on the desk. See price list pages for availability and pricing.



Mini Shelf

Aluminum mini shelf is optional on the insert panel overhead cabinets. This option needs to be specified with the overhead cabinet.

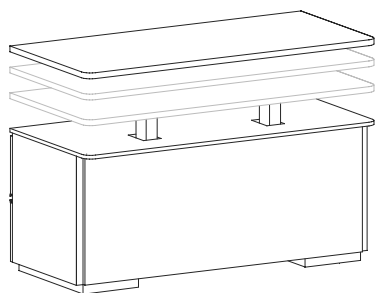


Special Sizes and Construction

Apogee has various modular units to create many popular applications. Please contact Customer Service if you need help in creating a particular layout.

Apogee™ Product Information

APOGEE™



Ergo Adjustable Work Height Mechanism

Our proprietary adjustable work height mechanism can be specified on many of the models in Apogee.

ERGO mechanism allows height adjustability to be added to the worksurface. Our solution uses a standardized design that minimizes the modifications required to standard desk, bridge or credenza models. The mechanism and control box are neatly concealed to maintain the appearance of the original elegance of the product. A push button control activates the electric powered lifting columns for adjustability from sitting height to a standing height. A 3/4" thick finished sub top is added to the top of the desk chassis for a clean appearance when the surface is in the raised position. In the lowered position, please note that Ergo adds 3/4" to the standard height of the desk and the installation will decrease kneespace depth by 8".

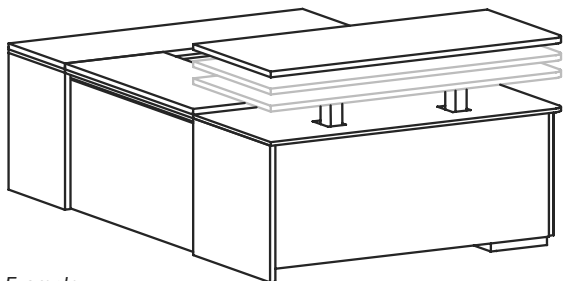
Automatic Collision Control is built in to each mechanism as a standard feature. When the system senses an obstacle obstructing the movement, the mechanism will reverse direction and retreat by 1".

When Ergo is added to a worksurface in an "L" or "U" group, all units in the configuration need to have a sub top added. These units are considered to be ERGO ADJACENT units. ERGO ADJACENT units must have a fixed height worksurface that matches the lowest position of the Ergo mechanism and the top. This is accomplished by adding a 3/4" sub top between the chassis and the worksurface. This feature can also be specified for cabinets which may sit next to a unit with the Ergo mechanism.

Height adjustment starts at 30 1/4", to a standing height of 49 3/4", a range of 19 1/2".

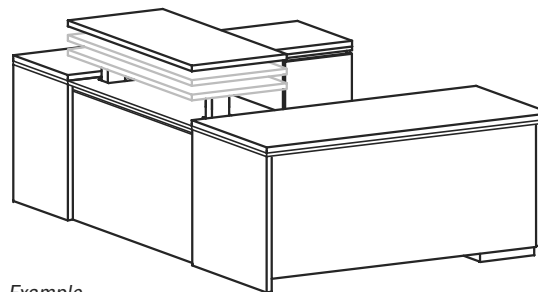
Note: The kneespace depth is decreased when the ERGO mechanism is specified. Contact Customer Service for dimension information.

The Ergo mechanism and controls are warranted for a period of (1) year. The rest of the casegood unit(s) are warranted under the Lifetime Warranty.



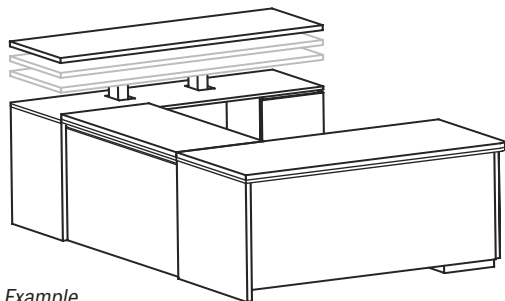
Example

AP1-SPR-1-3066L (with ERGO option) add \$4,835 to list
 AP3-BMR-1-2250 (with ERGO ADJACENT option) add \$711 to list
 AP2-OCP-1-2266R (with ERGO ADJACENT option) add \$711 to list



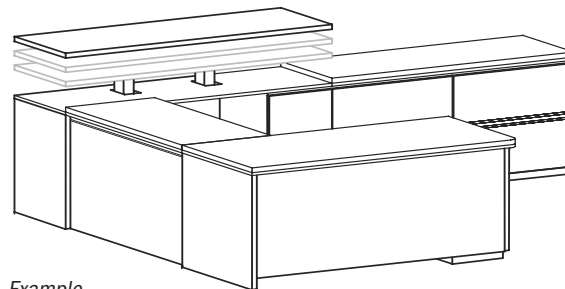
Example

AP1-SPR-1-3066L (with ERGO ADJACENT option) add \$711 to list
 AP3-BMR-1-2250 (with ERGO option) add \$4,835 to list
 AP2-OCP-1-2266R (with ERGO ADJACENT option) add \$711 to list



Example

AP1-SPR-1-3066L (with ERGO ADJACENT option) add \$711 to list
 AP3-BMR-1-2250 (with ERGO ADJACENT option) add \$711 to list
 AP2-OCP-1-2266R (with ERGO option) add \$4,835 to list



Example

AP1-SPR-1-3066L (with ERGO ADJACENT option) add \$711 to list
 AP3-BMR-1-2250 (with ERGO ADJACENT option) add \$711 to list
 AP2-OCP-1-2266R (with ERGO option) add \$4,835 to list
 AP2-DST-1-2260 (with ERGO ADJACENT option) add \$711 to list

Apogee™ Product Information

Availability of Apogee Units with the Mechanism

The following models are available with the ERGO Adjustable Work Height Mechanism.

Freestanding Units - Units below do not require adjacent products; select ERGO option and add \$4,835 to the list price.

Double Pedestal Desk

AP1-DPF-1-3066

AP1-DPF-1-3672

Adjacent Connecting Units - Select ERGO option for the model you wish to have height adjustment and add \$4,835 to the list price. For units, from this list, that are connecting to the ERGO model, you must select ERGO ADJACENT on each of these connecting models and add \$711 list to each model. *If the connecting model is 24"x 48" or less, add \$606 list.

Single Pedestal Desk

AP1-SPR-1-3066L

AP1-SPR-1-3066R

AP1-SPR-1-3666L

AP1-SPR-1-3666R

AP1-SPR-1-3672L

AP1-SPR-1-3672R

AP1-SPR-1-3678L

AP1-SPR-1-3678R

Bridges

AP3-BMR-1-2244*

AP3-BMR-1-2250*

AP3-BMR-1-2256*

Note: On bridges modesty panel will no longer be removable.

Open Corner Credenzas

AP2-OCP-1-2260L*

AP2-OCP-1-2260R*

AP2-OCP-1-2266L*

AP2-OCP-1-2266R*

AP2-OCP-1-2272L*

AP2-OCP-1-2272R*

AP2-OCP-1L-2260L*

AP2-OCP-1R-2260R*

AP2-OCP-1L-2266L*

AP2-OCP-1R-2266R*

AP2-OCP-1L-2272L*

AP2-OCP-1R-2272R*

Returns

AP3-RTP-1-2248L*

AP3-RTP-1-2248R*

AP3-RTP-1-2254L*

AP3-RTP-1-2254R*

AP3-RTP-1-2260L*

AP3-RTP-1-2260R*

AP3-RTP-1L-2248L*

AP3-RTP-1R-2248R*

AP3-RTP-1L-2254L*

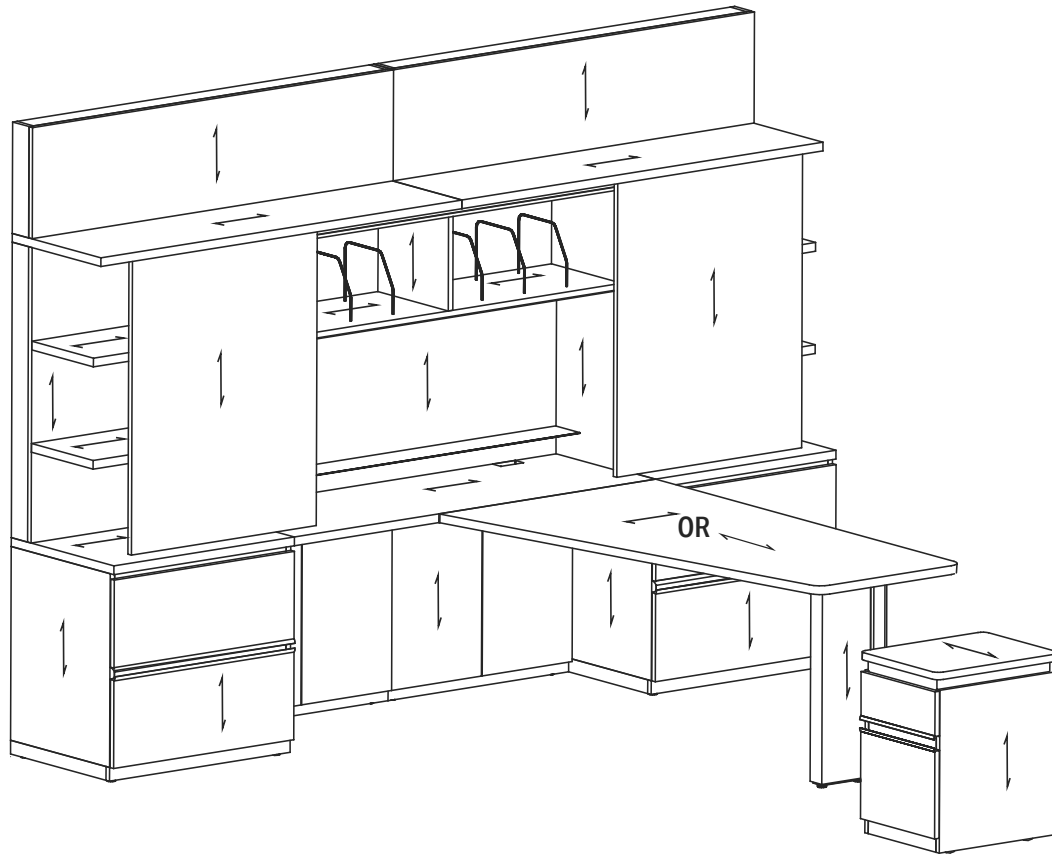
AP3-RTP-1R-2254R*

AP3-RTP-1L-2260L*

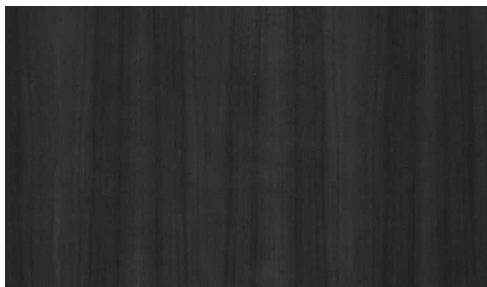
AP3-RTP-1R-2260R*

Apogee™ Product Information

Quarter Cut Veneer Grain Direction



APOGEE™



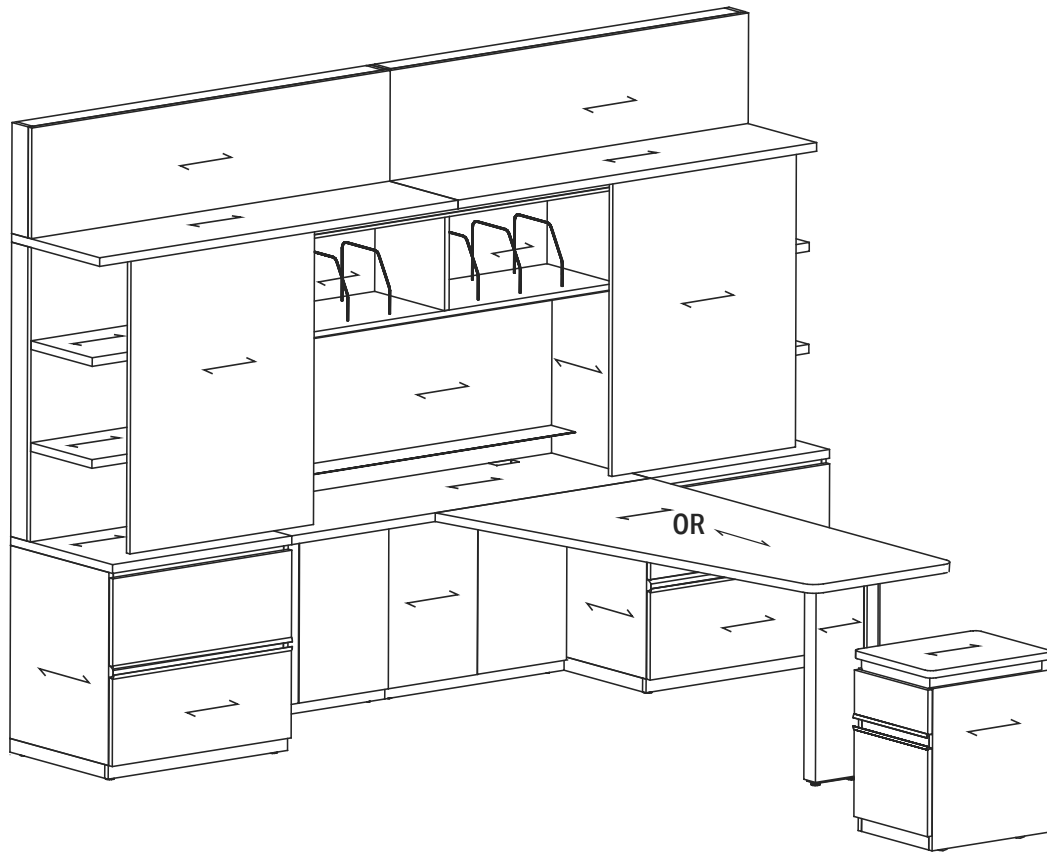
Quarter Cut Veneer

Standard direction for quarter cut veneer on Apogee™ is vertical.

The log is cut into quarters prior to slicing. This method bisects annual growth rings and results in a straight grain or ribbon-striped appearance.

Apogee™ Product Information

Double Cut Veneer Grain Direction



APOGEE™



Double Cut Veneer

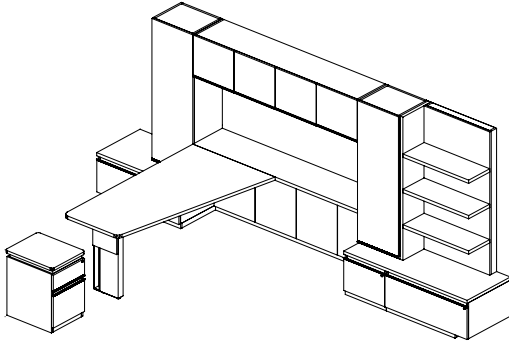
Standard direction for double cut veneer on Apogee™ is horizontal.

This veneer uses multiple layers of thin wood which is re-assembled, then re-cut in a factory, under controlled specifications. The veneer used in our program is a uniform straight grain pattern and is pre-stained for color consistency.

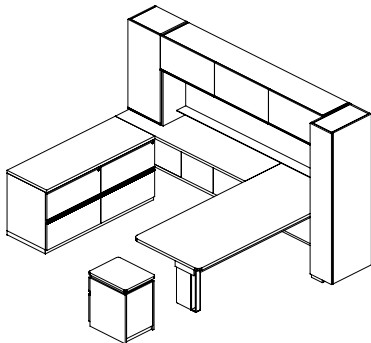
Apogee™ Product Information

Layouts

Two typical casegood layouts that can easily be created with Apogee™



Casegood layout made up of modular components, Trapezoid Run-Off Desk, One-High Lateral with Full Height Wall Access, Towers, Wall Mount Overhead, and Asymmetric Shelf



U-Group layout made up of built up, free standing casegood components, End Panel Desk, Full Height Access, Panel-Support Overhead, Tower, Wardrobe and Two-High Lateral

Casegoods feature modular wall components including: storage overhead cabinets, asymmetric shelves and back panels

Two heights & two depths of wall components
 Wall-mount or Panel-supported Overheads
 Casegood worksurface tops specified separately

1 Overhead, Wall Mount

2 Wall Panel

Available in veneer, magnetic glass markerboard, paint or tackable fabric. Thin profile anodized aluminum frame is featured on the panels with the glass option.

3 Wall Panel with Mini Shelf

Available in veneer, magnetic glass markerboard, paint or tackable fabric. Thin profile anodized aluminum frame is featured on the panels with the glass option. 5" Mini shelf is finished in anodized aluminum.

4 Run-Off Desk

Has an option for partial or full modesty panels in veneer or paint.

5 Tops

Modular items can be attached together with common worksurface tops. Refer to the items, some tops may be included.

6 Low Storage: Two-High Lateral File

7 Low Storage: One-High Lateral File

8 Low Storage: Wall Access Panel (partial height)

Allow for wiring to pass through to building wall.

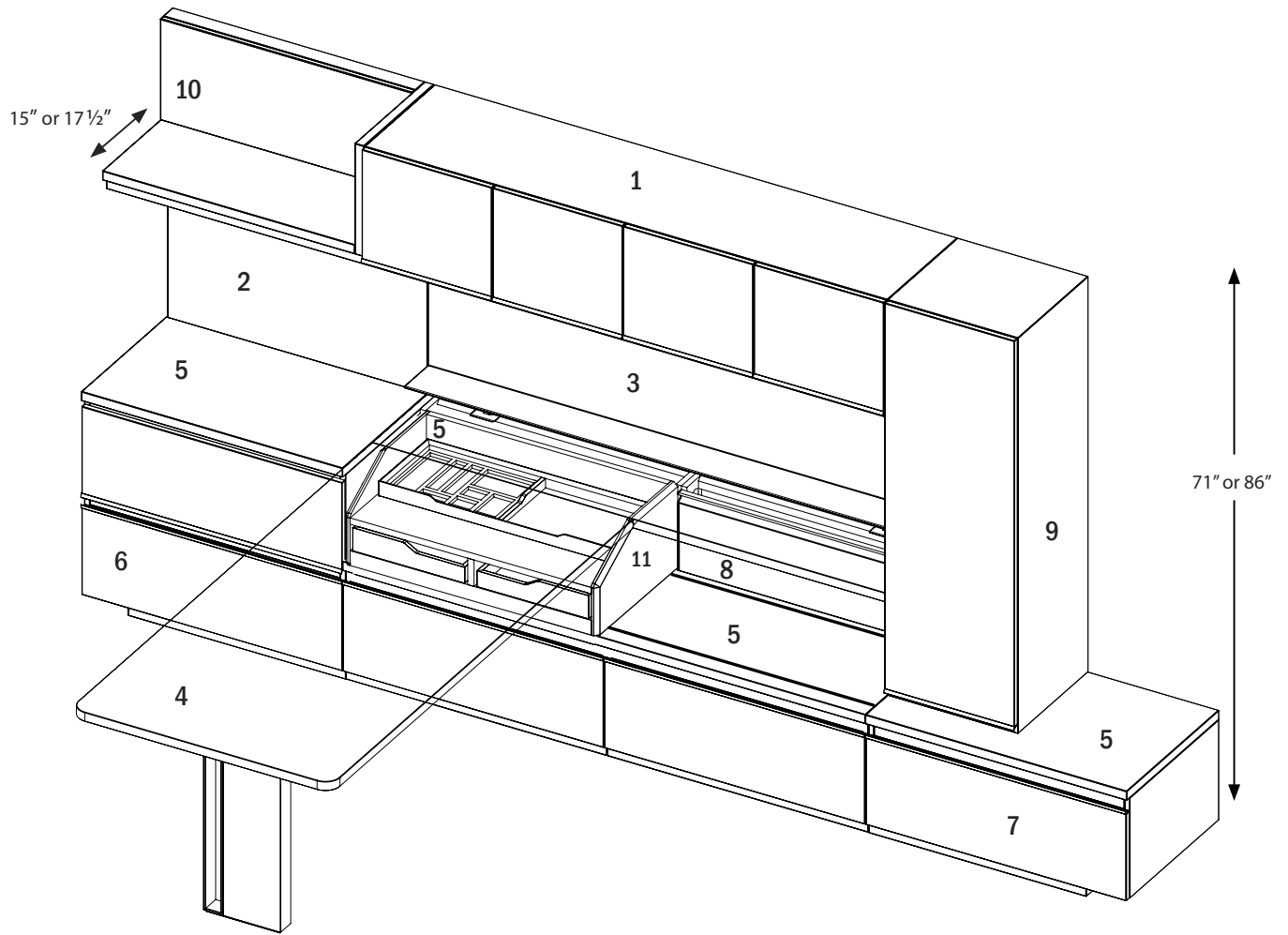
9 Storage Tower

10 Asymmetric Shelf

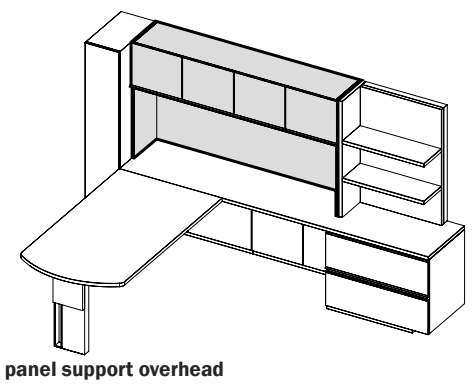
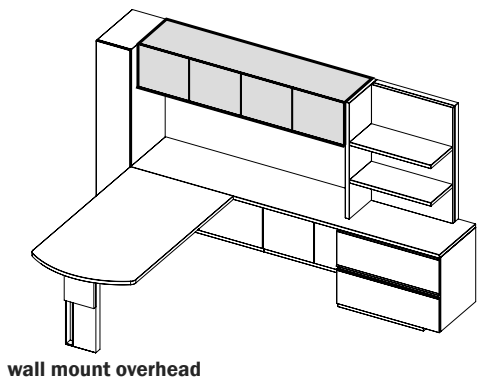
11 Accessories: Piling Shuttle (tops with shuttle tracks)

Shuttle slides back and forth on the track.

Apogee™ Product Information



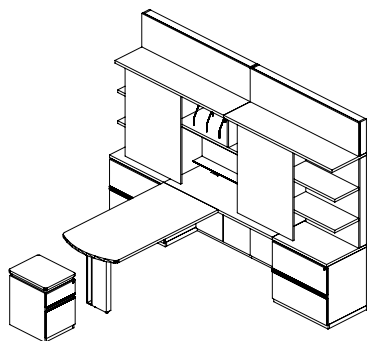
APOGEE™



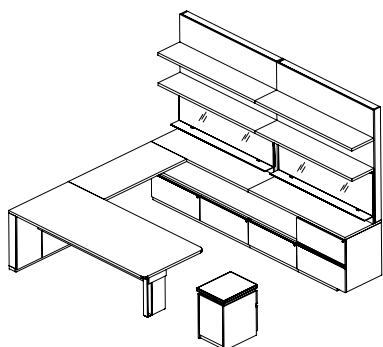
Apogee™ Product Information

Layouts

Two typical workwall layouts that can easily be created with Apogee™



Workwall grouping with Arc End Runoff Desk, Two-High Lateral Files, Full Height Wall Access with two piece Workwall and Workcenter



U-Group layout with End Panel Desk, Bridge Top, One-High and Two High Lateral Files, Partial Wall Access Panels, Open Workwall Shelves with Magnetic Back Painted Glass Markerboard

Workwalls can be specified with Open Shelves or Workwall with Work Centers solutions

One height & one depth of workwall
 Left and Right End Section specified as a set
 Tops are included with each section of workwalls components

1 Sections of WorkWall

Doors available in veneer finish, paint, or back painted glass with or without magnetic feature. Wall attachment required.

2 Workcenter

Five different configurations: combination of shelves with wire dividers, lower cubby, glass markerboards, monitor opening, refer to pages [AP135-AP138](#).

3 Open Frame Desk with Return Console Feature

Frame available in two finishes, Bright White or Arctic Silver.
 Power & Data unit available as an option.

4 Tops (included with WorkWall components)

5 Partial Wall Access Panel

Tops included with some units.

6 Low Storage: One-High Lateral File

7 Low Storage: Console Connector with Hinged Door

Use in conjunction with return console, provides pass thru for wiring from the desk to the building wall.

8 Return Console

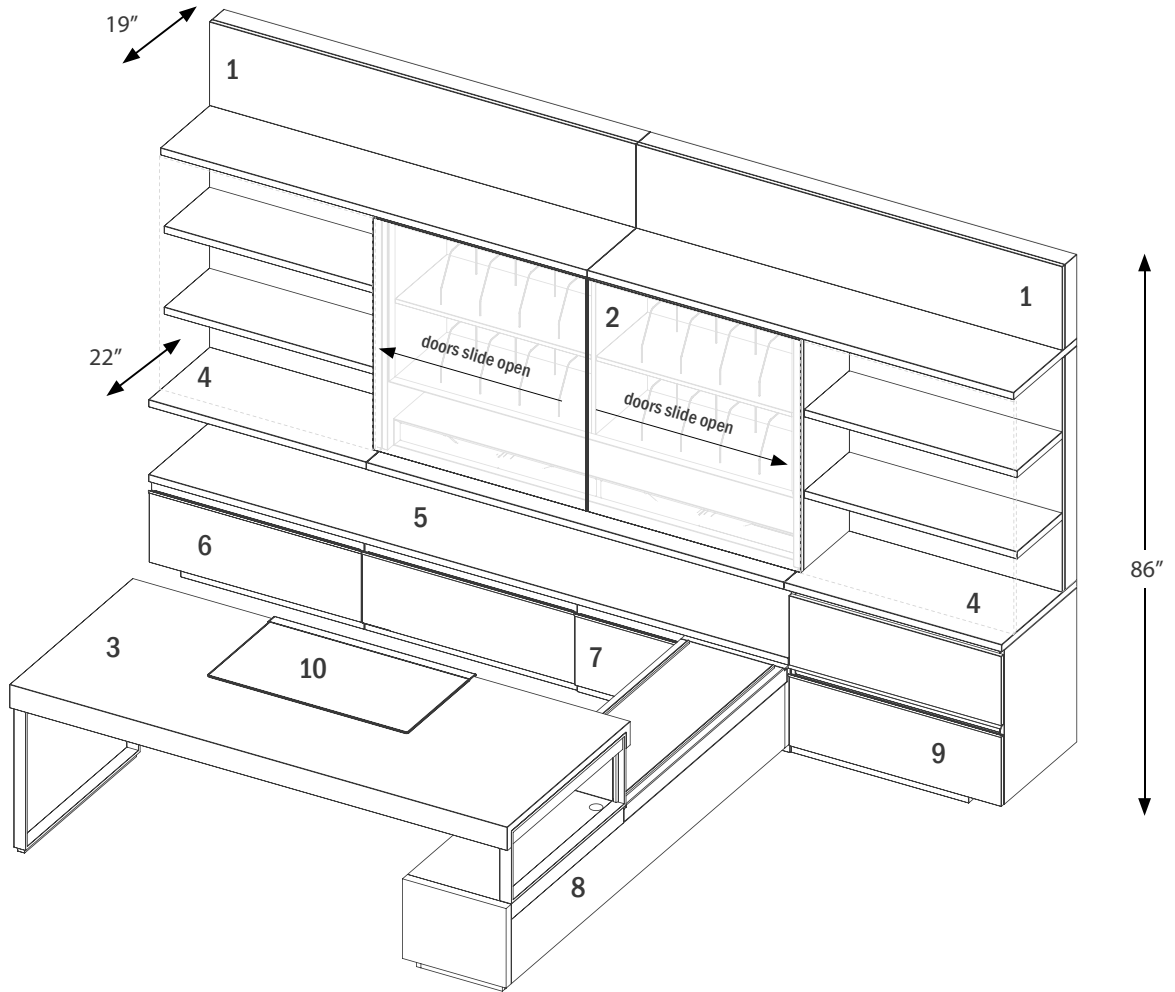
Sliding door opens up to lift out charging and organization trays lined in felt. Section under desk provides access to wire storage and includes a power strip.

9 Low Storage: Two-High Lateral File

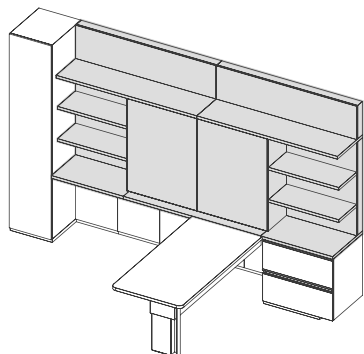
10 Accessories: Leather Desk Pad

Apogee™ Product Information

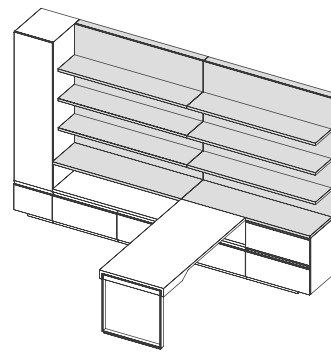
Workwall Components



APOGEE™



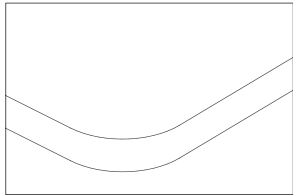
workcenter workwall



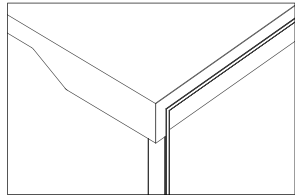
open shelf workwall

Apogee™ Product Information

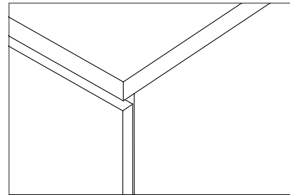
Corner Details



approach view of a standard desk corner



corner of an open frame end desk



front corner of a credenza top

Primary Worksurface Top Shapes

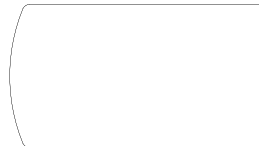
(diagrams show run-off tops)



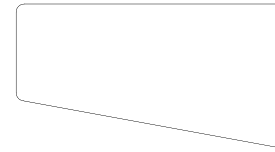
rectangle with radius corners



rectangular shape for open frame end



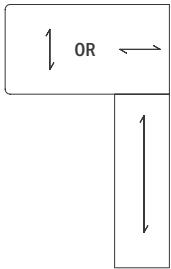
arc end



trapezoid

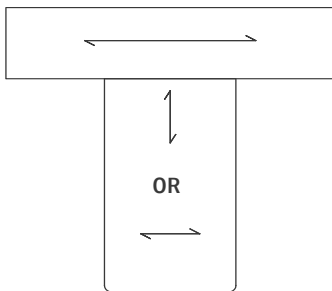
Grain Direction on End Panel Desk

*** Grain direction choice is required at the time of ordering.

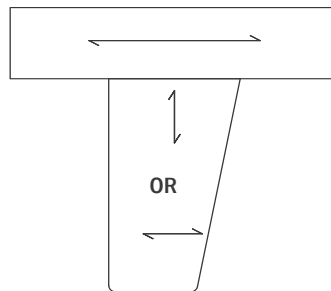


Grain Direction on Run-Off Worksurface Top

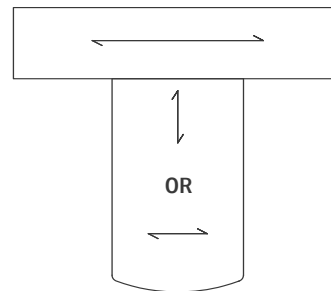
*** Grain direction choice is required at the time of ordering these three shapes.



rectangular



trapezoid



arc

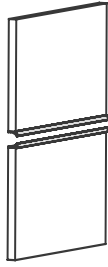
***The veneer grain on secondary worksurfaces always runs long grain. How the grain runs on peninsula style tops and how it mates to the secondary worksurface top is a design preference, on Apogee™ the specifier must choose a grain direction.

Apogee™ Product Information

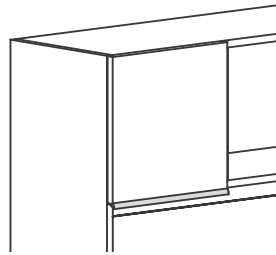
Pull Orientation



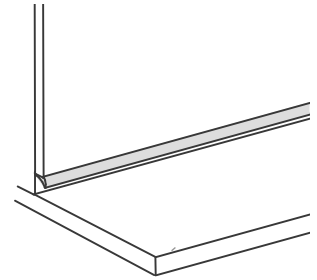
utility/box/file drawer



file/file drawer



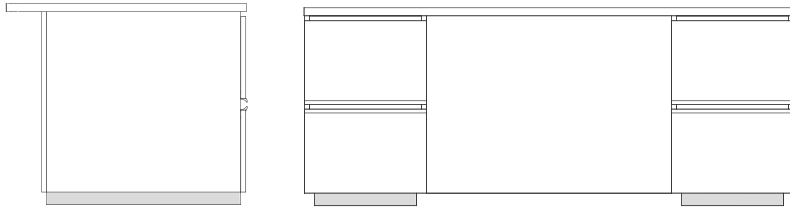
overhead



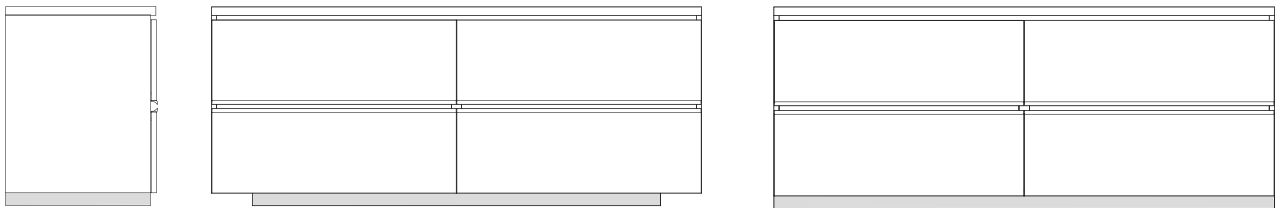
storage tower

Note: Wardrobe doors have a concealed bevel on the side to allow the door to open easily.

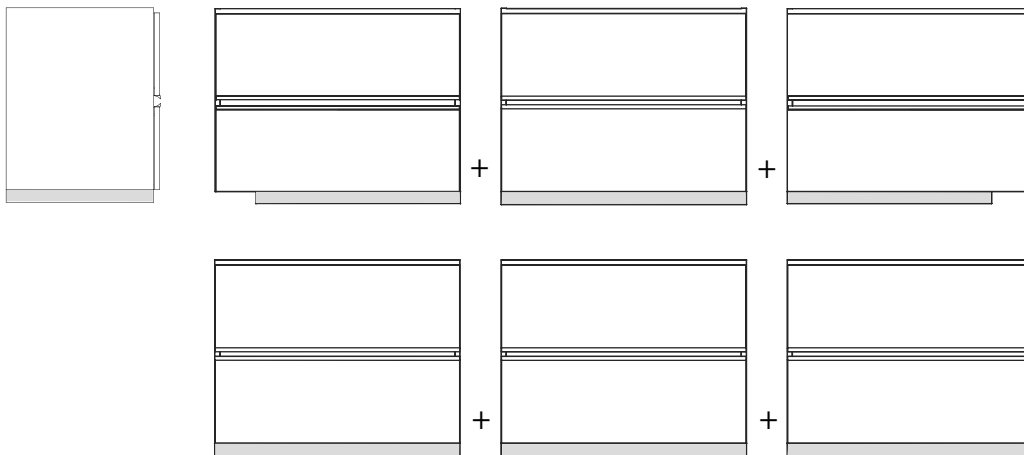
Base Details



All bases on pedestal desks have 1 1/2" inset on both sides and 3/4" on the front and back base.



Stand alone laterals and credenzas are available with either a 6" inset base or a flush base; all have a 3/4" inset on the front base.



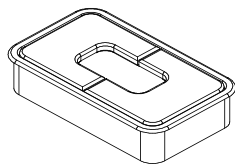
Modular units, storage cabinets, and wardrobes with bases are available with left inset, flush, or right inset.

Inset bases on the sides are 6", all have the front inset 3/4".

*** Specify the correct models to create the desired aesthetics.

Apogee™ Product Information

Standard Worksurface Grommet



Primary Worksurfaces - Run-Off Tops, Panel Desks & Open Frame Desk

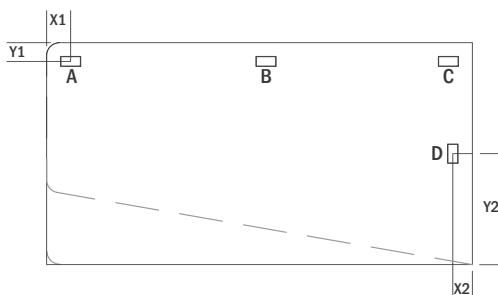


Diagram: G1 Applies to all rectangular, rectangle with radius corner, and trapezoid tops. (diagram shows run-off tops)

	X1	Y1	X2	Y2
A	3 3/4" from end	3" from edge		
B	center	3" from edge		
C	3 3/4" from end	3" from edge		
D			3" from end	center

* grommet for location D is not available on desk with open frame legs

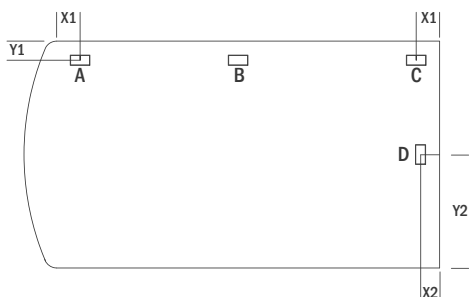


Diagram: G2 Applies to all arc end tops.

	X1	Y1	X2	Y2
A	3 3/4" start of radius	3" from edge		
B	center	3" from edge		
C	3 3/4" from end	3" from edge		
D			3" from end	center

Primary Worksurfaces - Pedestal Desks & Pedestal Run-Off Desks

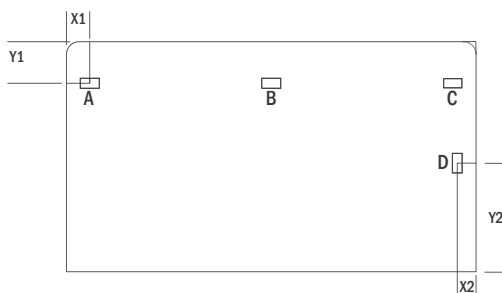


Diagram: G3 Applies to all worksurface tops with pedestals. Grommets cannot be placed over the top of a pedestal.

	X1	Y1	X2	Y2
A	3 3/4" front end	6 1/2" from edge		
B	center	6 1/2" from edge		
C	3 3/4" from end	6 1/2" from edge		
D*			3" from end	center

* grommet for location D applies only to Pedestal Run-Off Desks

Apogee™ Product Information

Bridges, Pedestal Returns and Shell Returns

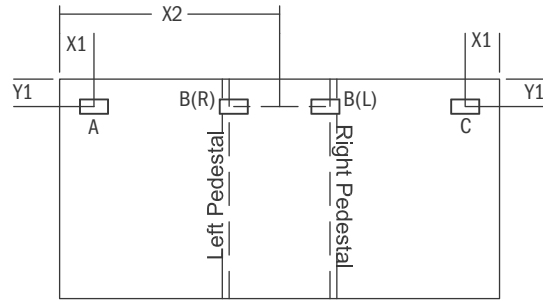
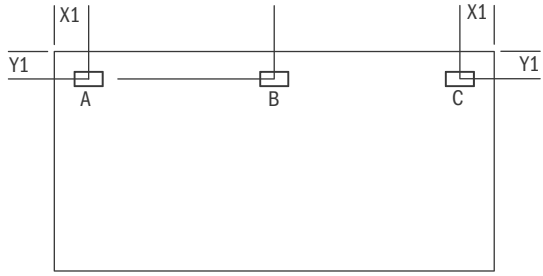


Diagram: G4 Applies to all bridge or return tops.
Grommets cannot be placed over the top of a pedestals.

	X1	Y1	X2
A	3 3/4" from end	3" from edge	
B	center	3" from edge	
BL		3" from edge	center plus 5"
BR		3" from edge	center minus 5"
C	3 3/4" from end	3" front edge	

APOGEE™

Open Corner, Run-Off and Storage Credenza

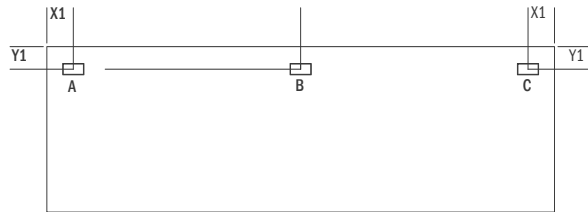


Diagram: G5 Applies to all credenza tops.
Grommets cannot be placed over the top of a pedestals

	X1	Y1
A	3 3/4" from end	3" from edge
B	center	3" from edge
C	3 3/4" from end	3" front edge

Workwall Tops with Wall Access

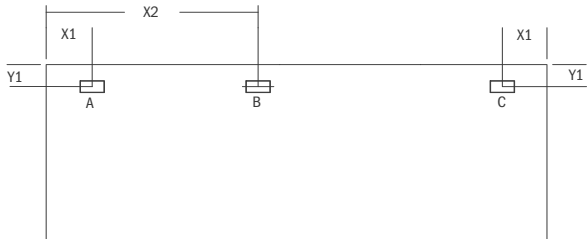


Diagram: G6 Applies to all tops that span under the workwalls when using wall access panels.

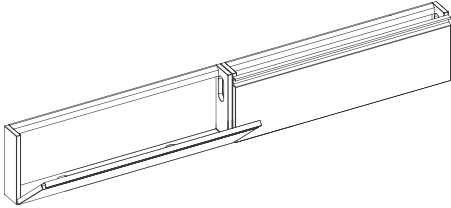
	X1	Y1	X2
A	8" from end	3" from edge	
B		3" from edge	center minus 5"
C	8" from end	3" from edge	

Apogee™ Product Information

Access to Wall & Wire Management

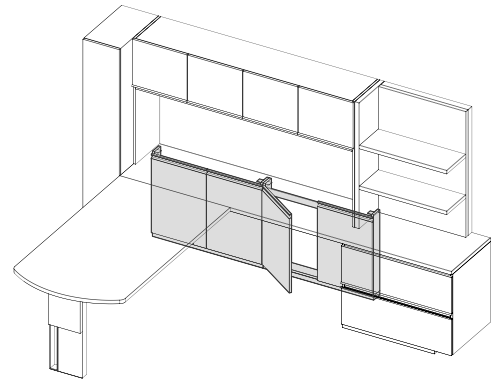
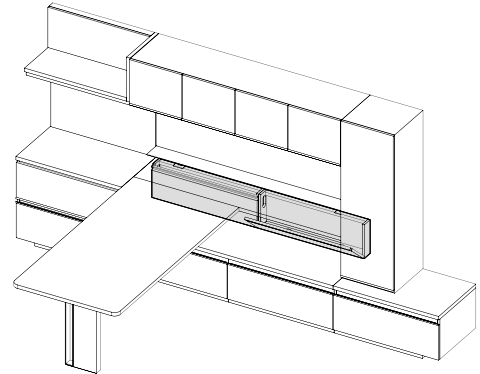
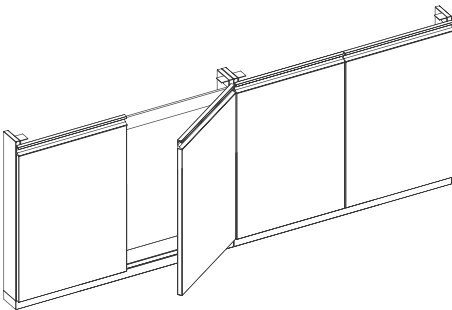
kneespace access panel, partial height

Doors flip down for access to building power and data outlets, use above one-high lateral.

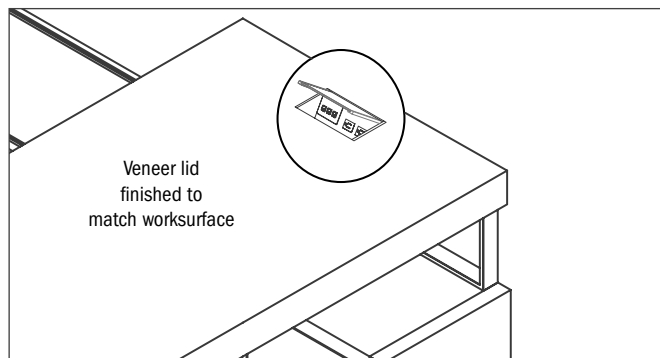


kneespace access panel, full height

Doors swing open for access to building power and data outlets

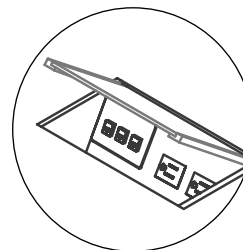
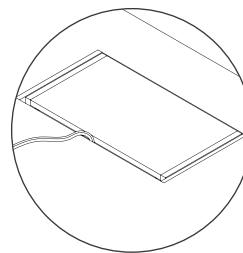


Power Unit



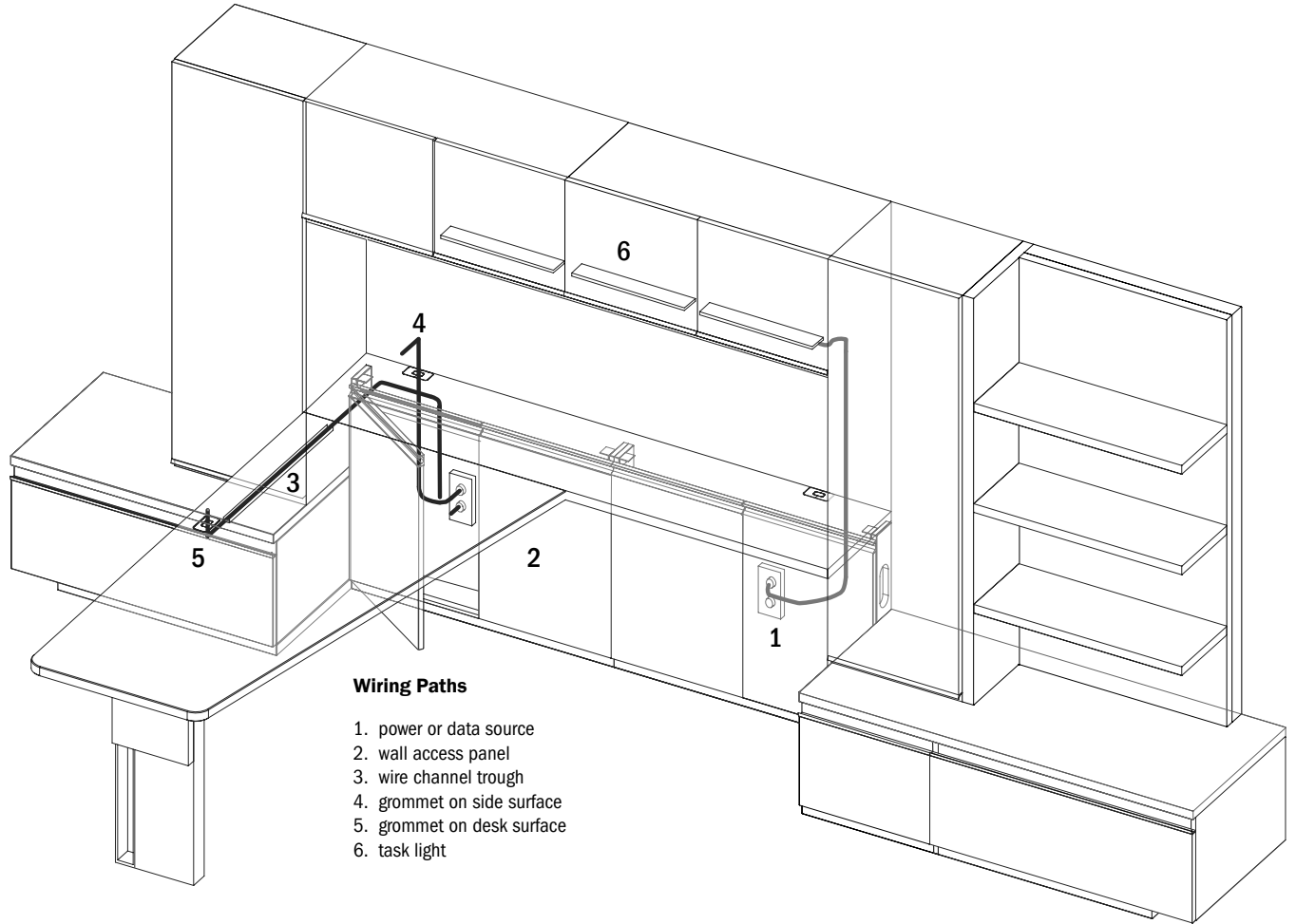
PU01 - power and data surface access (EC18)

This accessory features two 110 device, one RJ12 jack and two CAT 6 jacks. This unit eliminates the need for a grommet, wires can easily pass thru to the underside of the top.



Apogee™ Product Information

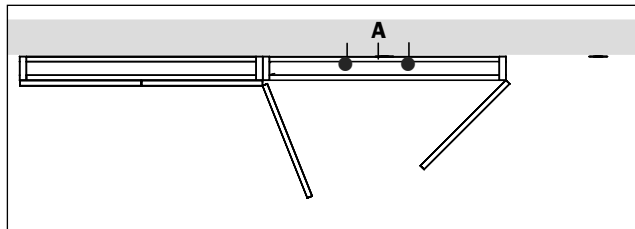
Access to Wall & Wire Management



APOGEE™

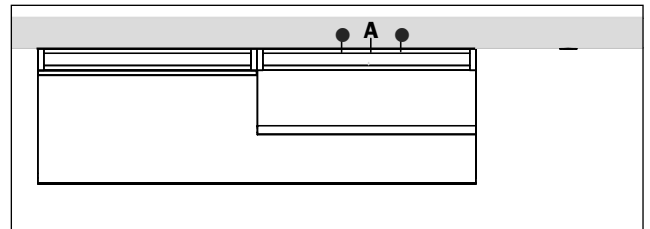
Power or Data Source - Recommended Location

AM7-PAP-1-0472

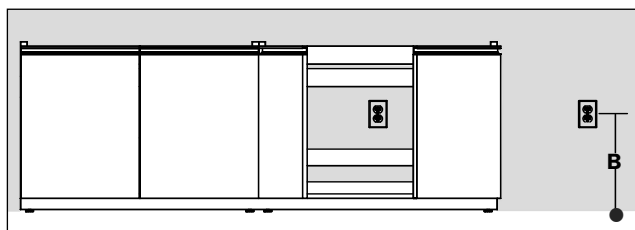


A - horizontal location + or - 5" from door center

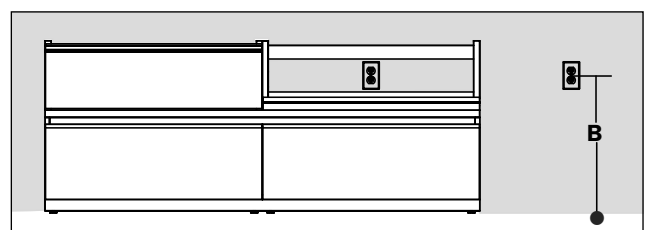
AM7-PAS-1-0472



A - horizontal location + or - 5" from door center



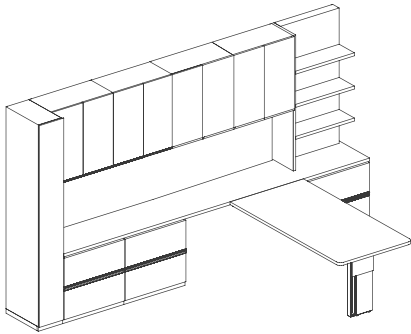
B - vertical location 15" to 24" AFF (above finish floor)



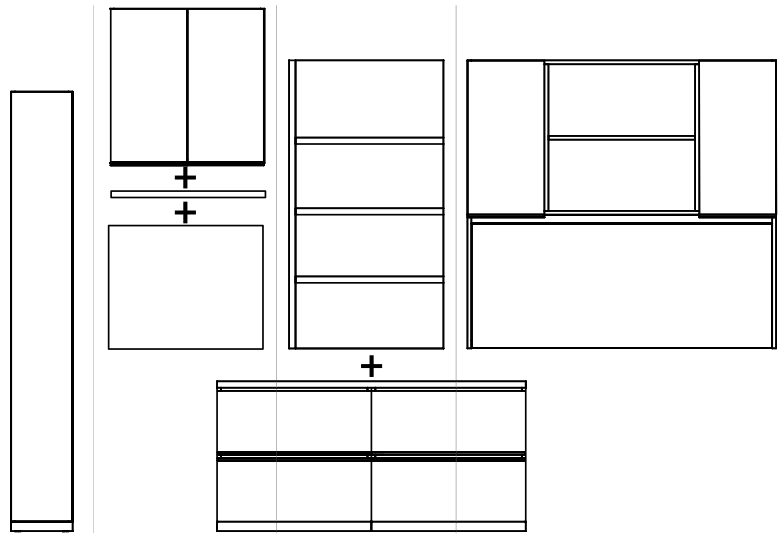
B - vertical location **REQUIRED** to be 24" AFF (above finish floor)

Apogee™ Product Information

86" Overall Height



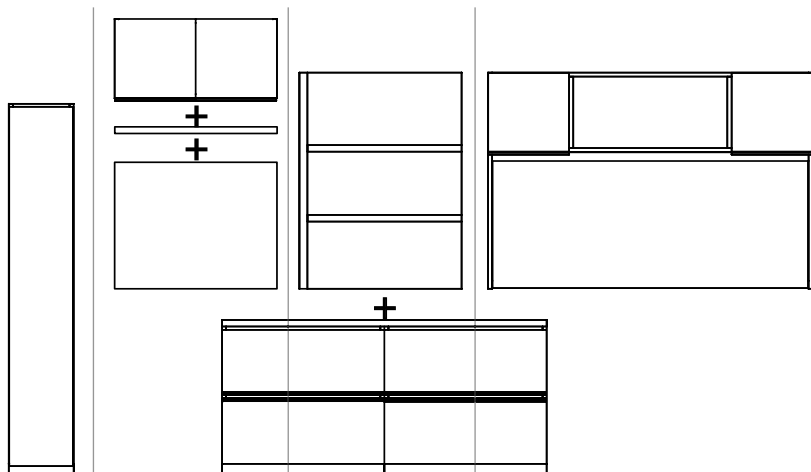
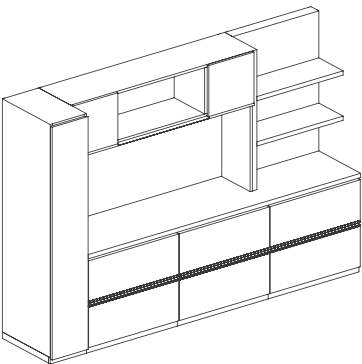
APOGEE™



wardrobe	85 7/8"	overhead	30"	tower	56"	storage cabinet	56"
		valance	1 3/4"	credenza	29 1/2"	credenza	29 1/2"
		wall panel	24"				
		spacing	1/4"				
		credenza	29 1/2"				
overall*	86"		86"		86"		86"

*overall height is rounded up, consideration for leveling tolerance is included.

71" Overall Height

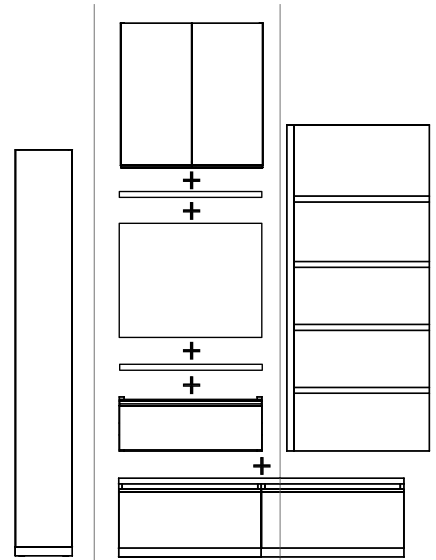
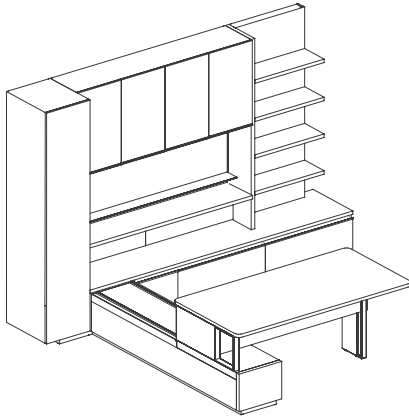


wardrobe	70 1/2"	overhead	15"	tower	41"	storage cabinet	41"
		valance	1 3/4"	credenza	29 1/2"	credenza	29 1/2"
		wall panel	24"				
		spacing	3/4"				
		credenza	29 1/2"				
overall*	71"		71"		71"		71"

*overall height is rounded up, consideration for leveling tolerance is included.

Apogee™ Product Information

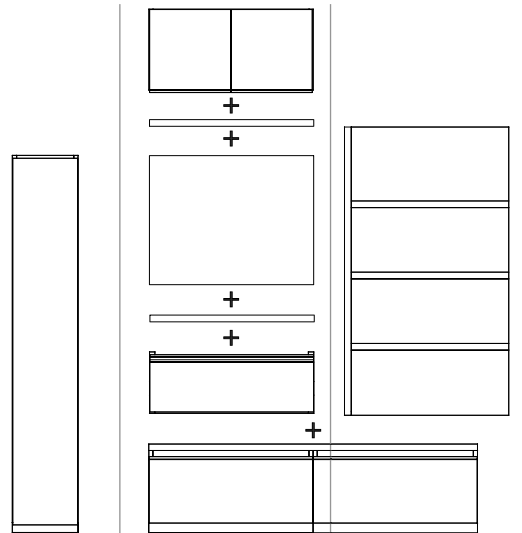
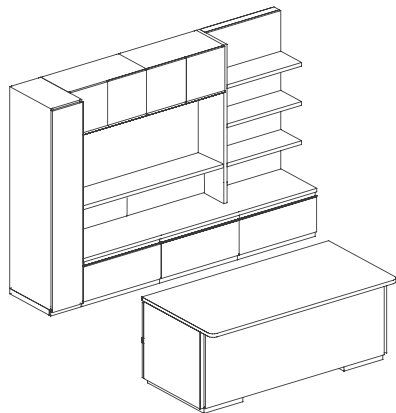
86" Overall Height



wardrobe	85 1/2"	overhead	30"	tower	68 1/2"
		valance	1 3/4"	credenza	16 7/8"
		wall panel	24"		
		spacing	1/4"		
		worksurface	1 1/8"		
		wall access	11 1/2"		
		credenza	16 7/8"		
overall*	86"		86"		86"

*overall height is rounded up, consideration for leveling tolerance is included.

71" Overall Height

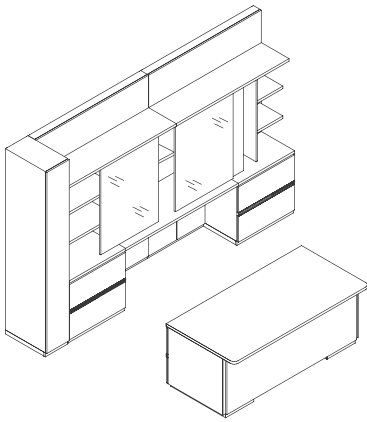


wardrobe	70 1/2"	overhead	15"	tower	53 5/8"
		valance	1 3/4"	credenza	16 7/8"
		wall panel	24"		
		spacing	3/4"		
		worksurface	1 1/8"		
		wall access	11 1/2"		
		credenza	16 7/8"		
overall*	71"		71"		71"

*overall height is rounded up, consideration for leveling tolerance is included.

Apogee™ Product Information

86" Overall Height



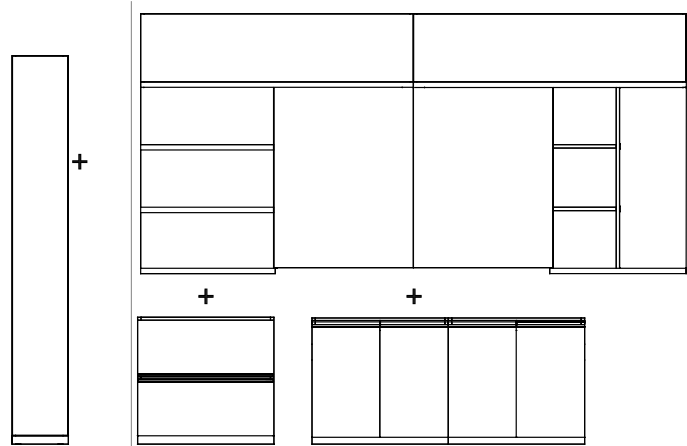
APOGEE™

Important

Tops are included with the work wall

Upper workwall component will not work with other overhead components

(Storage Overhead, Wall Mount Overheads, Towers and Asymmetric Shelves)

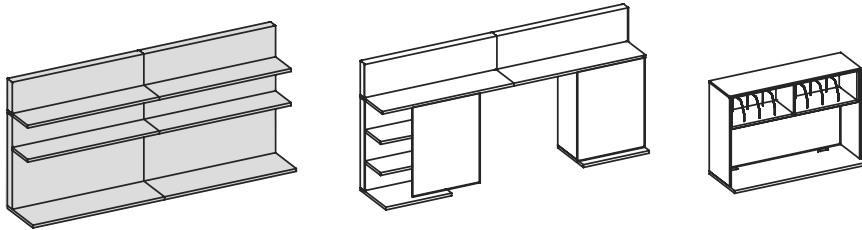


wardrobe	85 1/2"	workwall with sliding door	57"
		lateral without top and wall access panel	28 1/2"
overall*	86"		86"

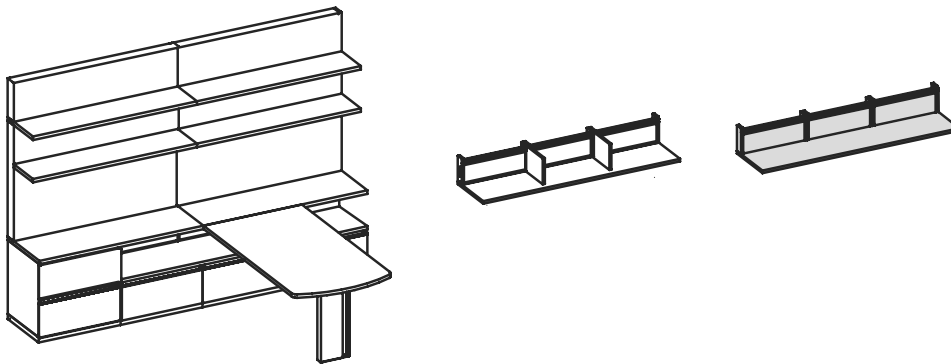
*overall height is rounded up, consideration for leveling tolerance is included.

Apogee™ Product Information

- **1** Select an overall layout style (primary runoff, U grouping or freestanding table desk). Consider the overall width, Workwalls are available in 144" or 120" widths. Then determine the method of support for secondary workwall top.
- **2** Choose the workwall, either full open shelves or units with an open center section and doors. When choosing the units with doors you must also select a workcenter, this is required and is specified as a separate model.

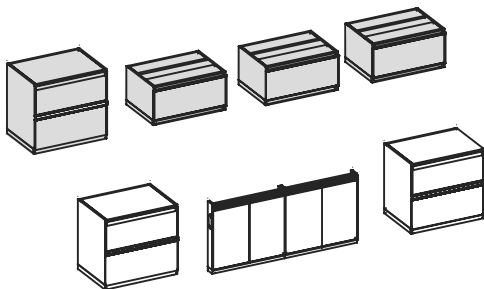


- **3** If using one-high storage/lateral, select the correct kneespace access unit. If side units such as wardrobe cabinets flank the workwall use the unit without the built in support extensions.

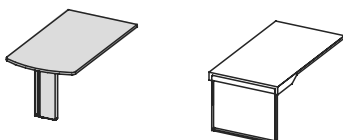


Note: These units are only needed when NOT using a workwall and without adjacent storage support

- **4** Choose the lower units to complete the workwall.



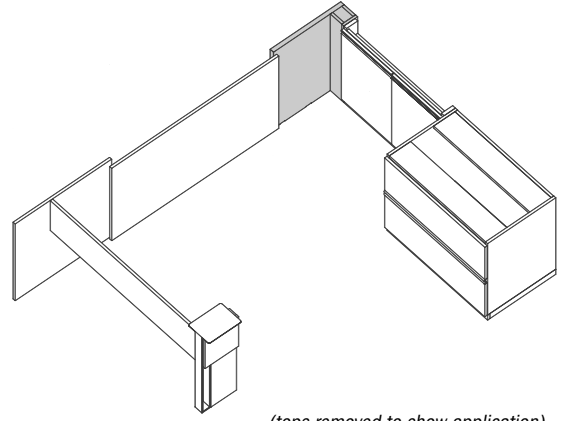
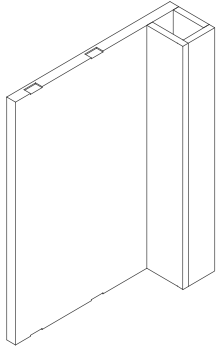
- **5** Choose run-off desk to finish the layout.



Apogee™ Product Information

End Panel Transition to Access Panel

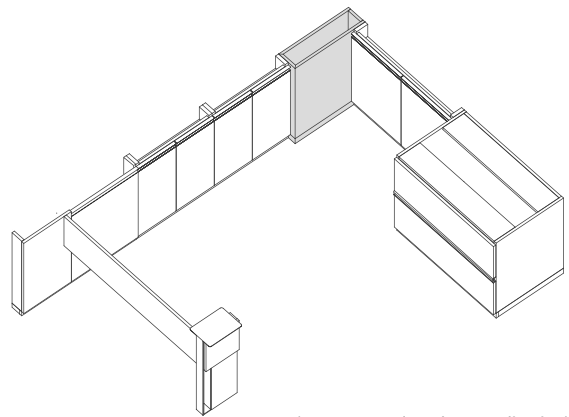
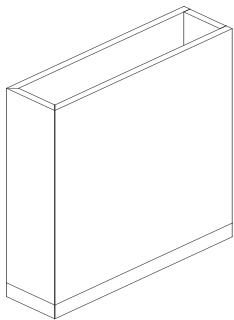
End panel transition supports and creates a transition when using a standard end panel desk and bridge; turning the corner to a kneespace access panel. (This item can be flipped for left or right).



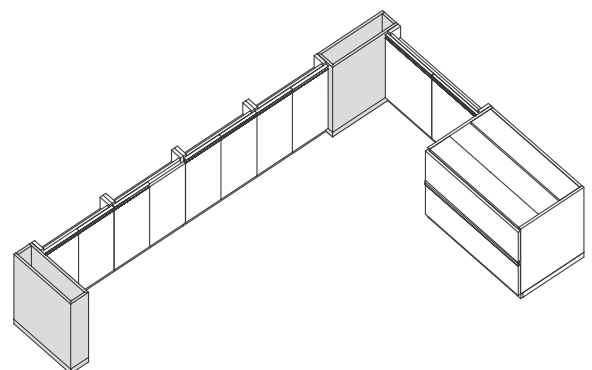
(tops removed to show application)

End Support

End support can be used to end a run of modular units or to turn the corner. Front corners are mitered. (Unit can be used for left or right applications).



(tops removed to show application)



(tops removed to show application)

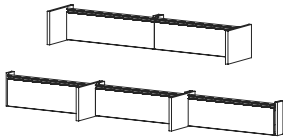
Apogee™ Product Information

Floating Top Appearance

Partial height kneespace access panels are used above one-high storage units to support floating workwall tops. Depending on adjacent storage and support, different types of wall access panels are required.

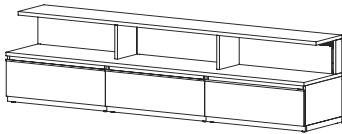
If you are using a Workwall or have top support on both sides, you can use the Wall Access Panel. If you are not using a Workwall and do not have top support on both sides, a Wall Access Panel with Support Panels is required.

Wall Access Panel with Support Panels



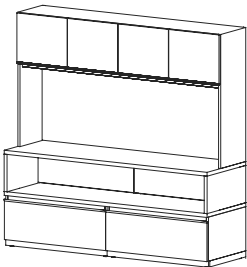
Use the partial wall access units with panel support when configuring examples 1, 2 & 3.

Example 1



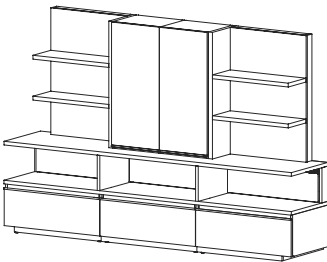
This example needs the additional support for the top, shown with a 15" deep top.

Example 2



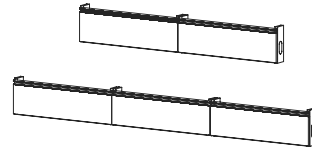
The wall access panel 72" wide has the support panel on the outside which supports the 22" deep top.

Example 3



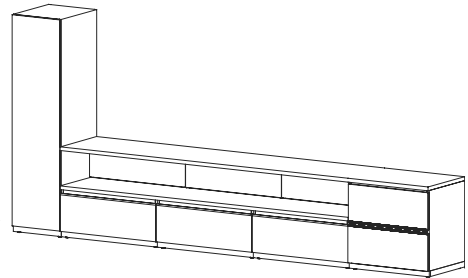
Support for this configuration is needed for the top and the asymmetric shelves and towers.

Wall Access Panel



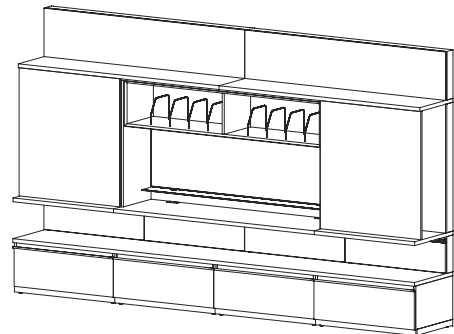
The partial wall access panels as shown above are used in configuration examples 4 & 5.

Example 4



The top is supported from both sides, shown with a 22" deep top.

Example 5



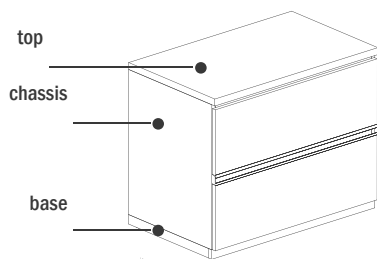
Tops are part of the wall hung workwall components. It is recommended the wall access panel be attached to the wall.

Apogee™ Product Information

Finish & Paint Scheme

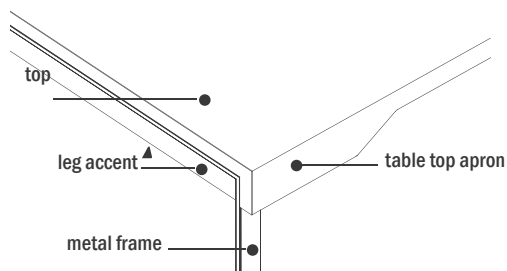
(see page AP32 for list finish options)

APOGEE™



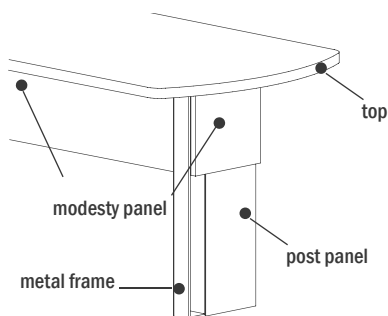
tops - veneer only
chassis/drawer fronts - veneer or paint
base - must match either top or chassis

can only choose one veneer finish and one paint per unit



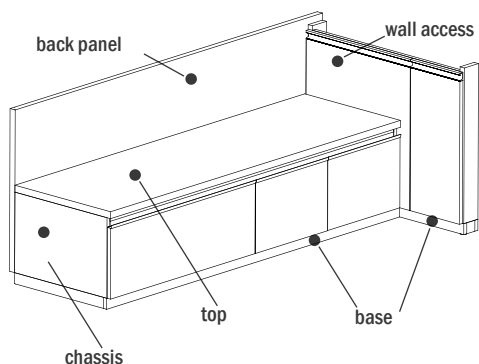
top and table top apron - veneer only
leg accent - veneer or paint
metal frame - arctic silver or bright white

can only choose one veneer finish and one paint per unit



top - veneer only
modesty panel - veneer or paint
post panel - veneer or paint
metal frame - arctic silver or bright white

can only choose one veneer finish and one paint per unit

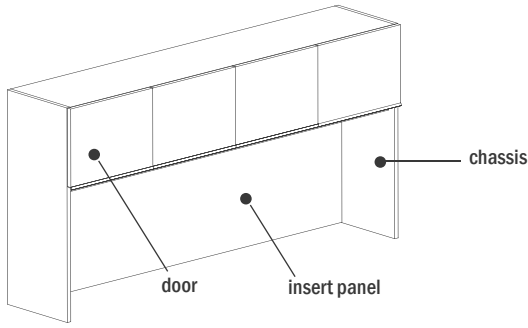


top - veneer only
wall access unit, back panel and chassis/fronts - veneer or paint
base - must match top or wall access unit, back panel and chassis/front

can only choose one veneer finish and one paint per unit

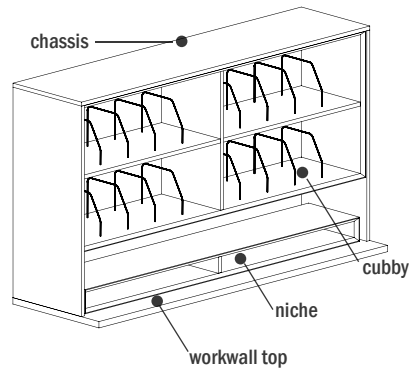
optional cushions can be ordered to create a bench

Apogee™ Product Information



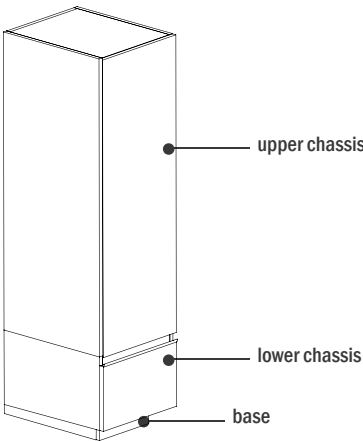
chassis - veneer or paint
doors - veneer or paint
insert panel - veneer, paint, magnetic back painted white glass or fabric
(requires a specification)

can only choose one veneer finish and one paint per unit



workwall top - veneer only
chassis - veneer (same as workwall top) or paint
cubby - paint only
divider - silver
niche - paint only

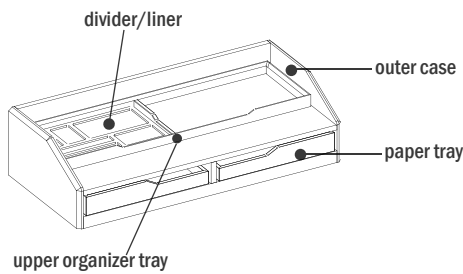
can only choose one veneer finish and one paint per unit



upper chassis/door fronts - veneer or paint
lower chassis/drawer fronts - veneer or paint
base - veneer or paint

can only choose one veneer finish and one paint per unit

scheme allows one high modular components to match lower sections of wardrobe cabinets



outer case - paint
divider/liner - charcoal felt
upper organizer tray - matches outer case
paper tray - paint or veneer

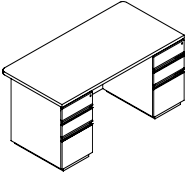
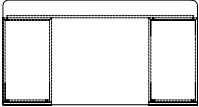
can only choose one veneer finish and one paint per unit

Apogee™ Product Information

Finish and Reference Codes - Summary

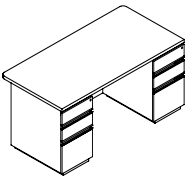
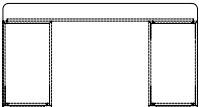
Select	Code	Paint Colors	Code
Veneer/Substrate			
Makore	MK2	Backdrop	BKD
Maple	MA2	Black Fox	BFX
Walnut	WA2	Bright White	BWH
Double Cut	DC1	Cargo Pants	CGP
		Chatroom	CHT
		French Roast	FRR
		Greek Villa	GRV
		Network Gray	NET
		Nonchalant White	NWH
		Storm	STM
		Tricorn Black	TRC
Finish		Metal Finishes	
Makore Finishes		Arctic Silver	ASL
Bourbon Medium	BBM	Bright White	BWH
Brighton Medium	BRM		
Classic	CLA		
Collectors	CLL		
Harvest	HRV		
Praline	PRL		
Maples Finishes			
Ale Medium	ALM		
Butterscotch	BUT		
Flax	FLX		
Venetian	VEN		
Walnut Finishes			
Espresso	ESP		
Mocha	MCH		
Sienna	SIE		
Truffle	TRF		
Umber	UMB		
Black Oak Finishes			
Raven	RAV		
Double Cut Finishes			
Coffee	COF		
Fawn	FAW		
Graphite	GRH		
Khaki	KHK		
Studio Teak	STU		
Valley	VAL		

Description	D	W	H	CTN WT	CU FT	① Model	List Price
72" w Double Pedestal Desk with Full Modesty	36	72	29 1/2	369	53	AP1-DPF-1-3672	\$5,786

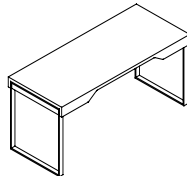
- 18" w utility/box/file pedestal left
- 18" w utility/box/file pedestal right
- utility drawer with box drawer front
- soft close utility/box/file drawers
- pedestal front locking
- top long grain veneer direction
- base on pedestals is inset
- center drawer available, [see page AP139](#)
- grommet available, specify and add \$114 list each; [see page AP20](#)
- adjustable levelers/glides
- kneespace width: 36"
- kneespace height: 28 1/4"
- 5 3/8" overhang on approach side

66" w Double Pedestal Desk with Full Modesty	30	66	29 1/2	308	41	AP1-DPF-1-3066	\$5,567
--	----	----	--------	-----	----	----------------	---------

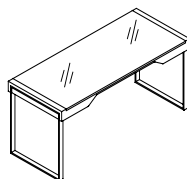
- 15 1/2" w utility/box/file pedestal left
- 15 1/2" w utility/box/file pedestal right
- utility drawer with box drawer front
- soft close utility/box/file drawers
- pedestal front locking
- top long grain veneer direction
- center drawer available, [see page AP139](#)
- grommet available, specify and add \$114 list each; [see page AP20](#)
- base on pedestals is inset
- adjustable levelers/glides
- kneespace width: 34 7/8"
- kneespace height: 28 1/4"
- 3 3/8" overhang on approach side

Veneer Table Desk with Open Frame Leg	36	84	29 1/2	166	61	AP1-TDR-1-3684	\$4,293
	36	72	29 1/2	148	53	AP1-TDR-1-3672	\$3,860
	30	66	29 1/2	119	41	AP1-TDR-1-3066	\$3,699



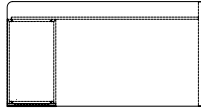
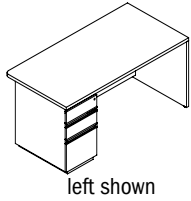
- veneer top with veneer wrapped apron
- angled apron user side
- top long grain veneer direction
- legs are tubular steel structure with powder coated finish
- recessed leveling guides
- center drawer not available
- grommet available, specify and add \$114 list each; [see page AP20](#) or diagram G1
- kneespace height: 27 3/4"
- -3684 kneespace width: 48"
- -3672 & -3066 kneespace width: 36"

Glass Table Desk with Open Frame Leg	36	84	29 1/2	202	61	AP1-TDR-1T-3684	\$6,623
	36	72	29 1/2	179	53	AP1-TDR-1T-3672	\$6,403
	30	66	29 1/2	143	41	AP1-TDR-1T-3066	\$6,257



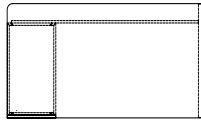
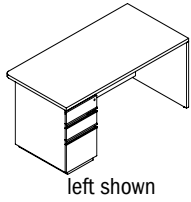
- glass top with veneer wrapped apron
- angled apron user side
- glossy low iron bright white back painted glass insert
- recessed leveling guides
- center drawer not available
- kneespace height: 27 3/4"
- -3684 kneespace width: 48"
- -3672 & -3066 kneespace width: 36"

Description	D	W	H	CTN WT	CU FT	① Model	List Price
Single Pedestal Desk with Full Modesty	36	78	29 ½	298	57	AP1-SPR-1-3678R	\$5,134
	36	78	29 ½	298	57	AP1-SPR-1-3678L	\$5,134
	36	72	29 ½	286	53	AP1-SPR-1-3672R	\$5,058
	36	72	29 ½	286	53	AP1-SPR-1-3672L	\$5,058



- 18" w utility/box/file pedestal
- utility drawer with box drawer front
- soft close utility/box/file drawers
- pedestal front locking
- top long grain veneer direction
- base on pedestal is inset
- adjustable levelers/glides
- center drawer available, [see page AP139](#)
- grommet available, specify and add \$114 list each; [see page AP20](#)
- kneespace height: 28 ¼"
- -3678 kneespace width: 58 7/8"
- -3672 kneespace width: 52 7/8"
- 5 3/8" overhang on approach side

Single Pedestal Desk with Full Modesty	36	66	29 ½	266	49	AP1-SPR-1-3666R	\$4,913
	36	66	29 ½	266	49	AP1-SPR-1-3666L	\$4,913
	30	66	29 ½	237	41	AP1-SPR-1-3066R	\$4,840
	30	66	29 ½	237	41	AP1-SPR-1-3066L	\$4,840



- 15 ½" w utility/box/file pedestal
- utility drawer with box drawer front
- soft close utility/box/file drawers
- pedestal front locking
- top long grain veneer direction
- base on pedestal is inset
- adjustable levelers/glides
- center drawer available, [see page AP139](#)
- grommet available, specify and add \$114 list each; [see page AP20](#)
- kneespace height: 28 ¼"
- kneespace width: 49 ¼"
- 5 3/8" overhang on approach side

To Order, Specify:

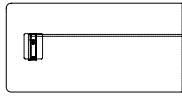
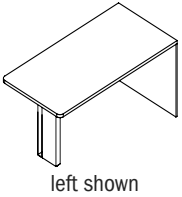
- ① Model Number
- ② Wood Species on Top/Veneer Wrapped Apron - Makore (MK2), Maple (MA2), Walnut (WA2), Black Oak (BO1) or Double Cut (DC1) [\(see page AP32\)](#)
- ③ Finish Color for Top/Veneer Wrapped Apron [\(see page AP32\)](#)
- ④ Finish Color for Chassis/Drawer Fronts or Leg Accent
 - a.) Same as Top/Veneer Wrapped Apron
 - b.) Paint Color [\(see page AP32\)](#)
- ⑤ Finish Color for Base
 - a.) Same as Top/Veneer Wrapped Apron
 - b.) Same as Chassis/Drawer Fronts or Paint [\(see page AP32\)](#)

- ⑥ Metal Open Frame Color [\(see page AP32\)](#)
Note: Only one wood finish and one paint color can be specified per unit

Product Modifications:

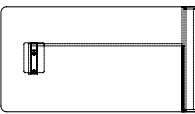
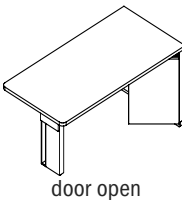
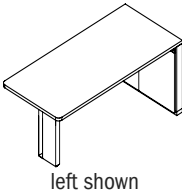
Pedestal Change - [see page AP9](#)

Description	D	W	H	CTN WT	CU FT	① Model	List Price
End Panel Desk with Partial Modesty	36	84	29½	167	12	AP1-LER-1-3684R	\$3,430
	36	84	29½	167	12	AP1-LER-1-3684L	\$3,430
	36	78	29½	156	11	AP1-LER-1-3678R	\$3,204
	36	78	29½	156	11	AP1-LER-1-3678L	\$3,204
	36	72	29½	153	11	AP1-LER-1-3672R	\$3,125
	36	72	29½	153	11	AP1-LER-1-3672L	\$3,125
	36	66	29½	145	10	AP1-LER-1-3666R	\$3,073
	36	66	29½	145	10	AP1-LER-1-3666L	\$3,073
	30	66	29½	128	9	AP1-LER-1-3066R	\$3,000
	30	66	29½	128	9	AP1-LER-1-3066L	\$3,000



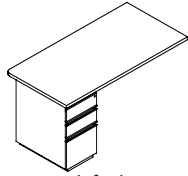
- must be used with a return or bridge
- end panel finished on back
- tubular metal post accent
- recessed leveling guides
- optional full modesty panel available, specify and add \$847 list for 84" w, \$819 list for 78" w, \$760 list for 72" w or \$730 list for 66" w
- grommet available, specify and add \$114 list each; [see page AP20](#)
- kneespace height: 28¼"

Access End Panel Desk with Partial Modesty	36	84	29½	171	12	AP1-LER-W-3684R	\$4,011
	36	84	29½	171	12	AP1-LER-W-3684L	\$4,011
	36	78	29½	163	11	AP1-LER-W-3678R	\$3,785
	36	78	29½	163	11	AP1-LER-W-3678L	\$3,785
	36	72	29½	153	11	AP1-LER-W-3672R	\$3,707
	36	72	29½	153	11	AP1-LER-W-3672L	\$3,707
	36	66	29½	148	10	AP1-LER-W-3666R	\$3,657
	36	66	29½	148	10	AP1-LER-W-3666L	\$3,657
	30	66	29½	137	9	AP1-LER-W-3066R	\$3,583
	30	66	29½	137	9	AP1-LER-W-3066L	\$3,583

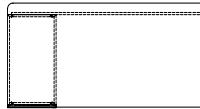


- must be used with a return shell with access panel or full height kneespace access panel
- end panel opened on back
- tubular metal post accent
- recessed leveling guides
- optional full modesty panel available, specify and add \$847 list for 84" w, \$819 list for 78" w, \$760 list for 72" w or \$730 list for 66" w
- due to back construction unit is intended to sit against wall for access
- grommet available, specify and add \$114 list each; [see page AP20](#)
- kneespace height: 28¼"
- 36" d access door dimension: 21" w
- 30" d access door dimension: 18" w

Description	D	W	H	CTN WT	CU FT	① Model	List Price
Pedestal Run-Off Desk	36	72	29 ½	167	12	AM1-PRR-1-3672R	\$3,657
	36	72	29 ½	167	12	AM1-PRR-1-3672L	\$3,657



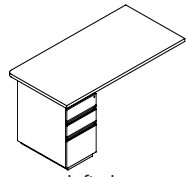
left shown



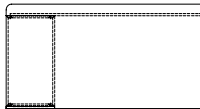
shown with optional modesty panel

- base on pedestal is inset
- 18" w utility/box/file pedestal
- utility drawer with box drawer front
- soft close utility/box/file drawers
- pedestal front locking
- adjustable levelers/glides
- optional full modesty panel available, specify and add \$1,022 list and indicate depth of side workwall top; 15" d or 22" d
- optional partial modesty panel available, specify and add \$768 list and indicate depth of side workwall top; 15" d or 22" d
- grommet available, specify and add \$114 list each; [see page AP20](#)
- kneespace height: 28 ¼"
- kneespace width: 54"
- 5 ¼" overhang on approach side

Pedestal Run-Off Desk	36	66	29 ½	189	8	AM1-PRR-1-3666R	\$3,583
	36	66	29 ½	189	8	AM1-PRR-1-3666L	\$3,583
	30	66	29 ½	165	7	AM1-PRR-1-3066R	\$3,510
	30	66	29 ½	165	7	AM1-PRR-1-3066L	\$3,510
	30	60	29 ½	159	7	AM1-PRR-1-3060R	\$3,438
	30	60	29 ½	159	7	AM1-PRR-1-3060L	\$3,438



left shown



shown with optional modesty panel

- base on pedestal is inset
- 15 ¼" w utility/box/file pedestal
- utility drawer with box drawer front
- soft close utility/box/file drawers
- pedestal front locking
- adjustable levelers/glides
- optional full modesty panel available, specify and add \$935 list for 66" w or \$847 list for 60" w and indicate depth of side workwall top; 15" d or 22" d
- optional partial modesty panel available, specify and add \$704 list for 66" w or \$637 list for 60" w and indicate depth of side workwall top; 15" d or 22" d
- grommet available, specify and add \$114 list each; [see page AP20](#)
- kneespace height: 28 ¼"
- -3666 & -3066 kneespace width: 50 ⅜"
- -3060 kneespace width: 44 ⅜"
- 3 ⅜" overhang on approach side

To Order, Specify:

- ① Model Number
- ② Wood Species on Top - Makore (MK2), Maple (MA2) Walnut (WA2), Black Oak (BO1) or Double Cut (DC1) ([see page AP32](#))
- ③ Finish Color for Top ([see page AP32](#))
- ④ Top Veneer Direction: long or short grain
- ⑤ Finish Color for Chassis/Drawer Fronts
 - a.) Same as Top
 - b.) Paint Color ([see page AP32](#))
- ⑥ Finish Color for Base
 - a.) Same as Top
 - b.) Same as Chassis/Drawer Fronts or Paint ([see page AP32](#))

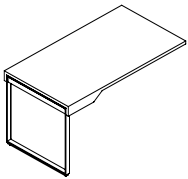
- ⑦ Finish Color for Post Panel
 - a.) Same as Top
 - b.) Same as Chassis/Drawer Fronts or Paint Color ([see page AP32](#))
- ⑧ Metal Post Accent Color ([see page AP32](#))
- ⑨ Finish Color for Modesty Panel:
 - a.) Same as Top
 - b.) Same as Chassis/Drawer Fronts or Paint Color ([see page AP32](#))

Note: Only one wood finish and one paint color can be specified per unit

Product Modifications:

Pedestal Change - [see page AP9](#)

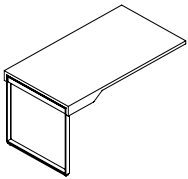
Description	D	W	H	CTN WT	CU FT	① Model	List Price
36" d Run-Off Table Desk with Open Frame Leg	36	66	29½	122	49	AM1-LRR-T-3666R	\$3,058
	36	66	29½	122	49	AM1-LRR-T-3666L	\$3,058
	36	60	29½	112	44	AM1-LRR-T-3660R	\$2,987
	36	60	29½	112	44	AM1-LRR-T-3660L	\$2,987



left shown

- veneer top with veneer wrapped apron
- angled apron both sides
- top long grain veneer direction
- legs are tubular steel structure with powder coated finish
- recessed leveling guides
- grommet available, specify and add \$114 list each; [see page AP20](#) for diagram G1
- kneespace height: 28¼"
- -3666 kneespace width: 47"
- -3660 kneespace width: 41"

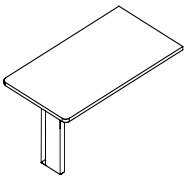
30" d Run-Off Table Desk with Open Frame Leg	30	66	29½	101	41	AM1-LRR-T-3066R	\$2,911
	30	66	29½	101	41	AM1-LRR-T-3066L	\$2,911
	30	60	29½	99	37	AM1-LRR-T-3060R	\$2,840
	30	60	29½	99	37	AM1-LRR-T-3060L	\$2,840
	30	54	29½	91	34	AM1-LRR-T-3054R	\$2,767
	30	54	29½	91	34	AM1-LRR-T-3054L	\$2,767



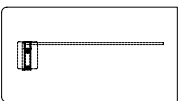
left shown

- veneer top with veneer wrapped apron
- angled apron both sides
- top long grain veneer direction
- legs are tubular steel structure with powder coated finish
- recessed leveling guides
- grommet available, specify and add \$114 list each; [see page AP20](#) for diagram G1
- kneespace height: 28¼"
- -3066 kneespace width: 47"
- -3060 kneespace width: 41"
- -3054 kneespace width: 35"

Run-Off Desk with Post	36	66	29½	125	10	AP1-LRR-1-3666R	\$2,623
	36	66	29½	125	10	AP1-LRR-1-3666L	\$2,623
	30	66	29½	112	9	AP1-LRR-1-3066R	\$2,551
	30	66	29½	112	9	AP1-LRR-1-3066L	\$2,551
	30	60	29½	106	9	AP1-LRR-1-3060R	\$2,477
	30	60	29½	106	9	AP1-LRR-1-3060L	\$2,477
	30	54	29½	100	8	AP1-LRR-1-3054R	\$2,405
	30	54	29½	100	8	AP1-LRR-1-3054L	\$2,405



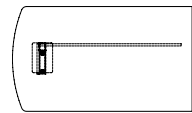
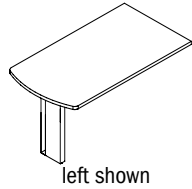
left shown



shown with optional modesty panel

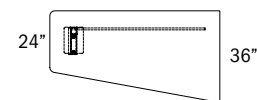
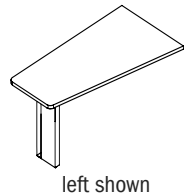
- tubular metal post accent
- recessed leveling guides
- specify top veneer direction, long or short grain
- optional full modesty panel available, specify and add \$935 list for 66" w, \$847 list for 60" w or \$768 list for 54" w and indicate depth of side workwall; 15" d or 22" d
- optional partial modesty panel available, specify and add \$704 list for 66" w, \$637 list for 60" w or \$571 list for 54" w and indicate depth of side workwall; 15" d or 22" d
- grommet available, specify and add \$114 list each; [see page AP20](#)
- kneespace height: 28¼"

Description	D	W	H	CTN WT	CU FT	① Model	List Price
Arc End Run-Off Desk with Post	36	66	29 ½	124	8	AM1-LRA-1-3666R	\$2,805
	36	66	29 ½	124	8	AM1-LRA-1-3666L	\$2,805
	36	60	29 ½	117	8	AM1-LRA-1-3660R	\$2,733
	36	60	29 ½	117	8	AM1-LRA-1-3660L	\$2,733
	30	66	29 ½	111	7	AM1-LRA-1-3066R	\$2,659
	30	66	29 ½	111	7	AM1-LRA-1-3066L	\$2,659
	30	60	29 ½	105	7	AM1-LRA-1-3060R	\$2,587
	30	60	29 ½	105	7	AM1-LRA-1-3060L	\$2,587
	30	54	29 ½	99	6	AM1-LRA-1-3054R	\$2,515
	30	54	29 ½	99	6	AM1-LRA-1-3054L	\$2,515



- tubular metal post accent
- recessed leveling guides
- specify top veneer direction, long or short grain
- optional full modesty panel available, specify and add \$935 list for 66" w, \$847 list for 60" w or \$768 list for 54" w and indicate depth of side workwall; 15" d or 22" d
- optional partial modesty panel available, specify and add \$704 list for 66" w, \$637 list for 60" w or \$571 list for 54" w and indicate depth of side workwall; 15" d or 22" d
- grommet available, specify and add \$114 list each; [see page AP20](#)
- kneespace height: 28 ¼"

Trapezoid Run-Off Desk with Post	36	66	29 ½	109	8	AM1-LRT-1-3666R	\$2,950
	36	66	29 ½	109	8	AM1-LRT-1-3666L	\$2,950
	36	60	29 ½	102	8	AM1-LRT-1-3660R	\$2,877
	36	60	29 ½	102	8	AM1-LRT-1-3660L	\$2,877
	36	54	29 ½	97	7	AM1-LRT-1-3654R	\$2,659
	36	54	29 ½	97	7	AM1-LRT-1-3654L	\$2,659



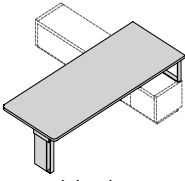
- tubular metal post accent
- recessed leveling guides
- specify top veneer direction, long or short grain
- optional full modesty panel available, specify and add \$935 list for 66" w, \$847 list for 60" w or \$768 list for 54" w and indicate depth of side workwall; 15" d or 22" d
- optional partial modesty panel available, specify and add \$704 list for 66" w, \$637 list for 60" w or \$571 list for 54" w and indicate depth of side workwall; 15" d or 22" d
- grommet available, specify and add \$114 list each; [see page AP20](#)
- kneespace height: 28 ¼"

To Order, Specify:

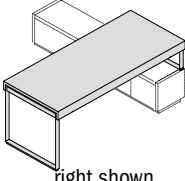
- ① Model Number
- ② Wood Species on Top/Veneer Wrapped Apron - Makore (MK2), Maple (MA2), Walnut (WA2), Black Oak (BO1) or Double Cut (DC1) ([see page AP32](#))
- ③ Finish Color on Top/Veneer Wrapped Apron ([see page AP32](#))
- ④ Top Veneer Grain Direction: long or short grain (for desks with a post leg)
- ⑤ Leg Accent/Post Panel Accent Color
 - a.) Same as Top
 - b.) Paint ([see page AP32](#))
- ⑥ Metal Open Frame Color or Metal Post Accent Color ([see page AP32](#))

- ⑦ Finish Color for Modesty Panel:
 - a.) Same as Top
 - b.) Same as Chassis/Drawer Fronts or Paint Color ([see page AP32](#))

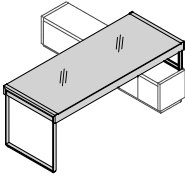
Note: Only one wood finish and one paint color can be specified per unit

Description	D	W	H	CTN WT	CU FT	Model	List Price
 <p>right shown</p>	36	90	29½	167	66	AP1-LCR-1-3690R	\$3,423
	36	90	29½	167	66	AP1-LCR-1-3690L	\$3,423
	36	84	29½	157	61	AP1-LCR-1-3684R	\$3,276
	36	84	29½	157	61	AP1-LCR-1-3684L	\$3,276
	36	72	29½	139	53	AP1-LCR-1-3672R	\$3,023
	36	72	29½	139	53	AP1-LCR-1-3672L	\$3,023
	30	66	29½	114	41	AP1-LCR-1-3066R	\$2,911
	30	66	29½	114	41	AP1-LCR-1-3066L	\$2,911

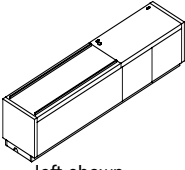
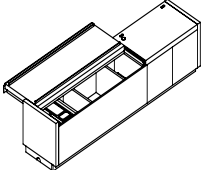
- use with low console
- top long grain veneer direction
- tubular metal post accent
- recessed leveling glides
- optional partial modesty panel available, specify and add \$951 list for 90"w, \$893 list for 84"w, \$768 list for 72"w and \$704 list for 66"w
- power access unit available, specify and add \$382 list
- grommet available, specify and add \$114 list each; see page AP20 for diagram G1
- kneespace height: 28¼"
- -3690 & -3684 kneespace width: 48"
- -3072 & -3066 kneespace width: 36"

 <p>right shown</p>	36	90	29½	170	66	AP1-LCR-T-3690R	\$3,829
	36	90	29½	170	66	AP1-LCR-T-3690L	\$3,829
	36	84	29½	160	61	AP1-LCR-T-3684R	\$3,669
	36	84	29½	160	61	AP1-LCR-T-3684L	\$3,669
	36	72	29½	141	53	AP1-LCR-T-3672R	\$3,438
	36	72	29½	141	53	AP1-LCR-T-3672L	\$3,438
	30	66	29½	117	41	AP1-LCR-T-3066R	\$3,276
	30	66	29½	117	41	AP1-LCR-T-3066L	\$3,276

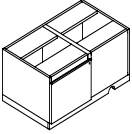
- use with low console
- veneer top with veneer wrapped apron
- top long grain veneer direction
- legs are tubular steel structure with powder coated finish
- power access unit available, specify and add \$382 list
- recessed leveling glides
- grommet available, specify and add \$114 list each; see page AP20 for diagram G1
- kneespace height: 28¼"
- -3690 & -3684 kneespace width: 48"
- -3072 & -3066 kneespace width: 36"

 <p>right shown</p>	36	90	29½	223	66	AP1-LCR-TT-3690R	\$6,331
	36	90	29½	223	66	AP1-LCR-TT-3690L	\$6,331
	36	84	29½	210	61	AP1-LCR-TT-3684R	\$5,995
	36	84	29½	210	61	AP1-LCR-TT-3684L	\$5,995
	36	72	29½	183	53	AP1-LCR-TT-3672R	\$5,763
	36	72	29½	183	53	AP1-LCR-TT-3672L	\$5,763
	30	66	29½	149	41	AP1-LCR-TT-3066R	\$5,604
	30	66	29½	149	41	AP1-LCR-TT-3066L	\$5,604

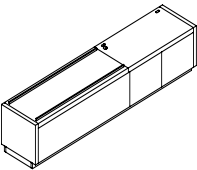
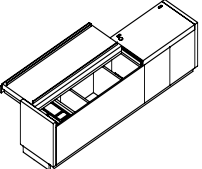
- use with low console
- glass top with veneer wrapped apron
- glossy low iron white back painted glass insert
- recessed leveling glides
- kneespace height: 28¼"
- -3690 & -3684 kneespace width: 48"
- -3072 & -3066 kneespace width: 36"

Description	D	W	H	CTN WT	CU FT	① Model	List Price
Low Console Bridge  left shown  left shown	18	83	15 ¾	200	18	AP3-RCS-1-1883R	\$5,095
	18	83	15 ¾	200	18	AP3-RCS-1-1883L	\$5,095
	18	77	15 ¾	190	17	AP3-RCS-1-1877R	\$4,513
	18	77	15 ¾	190	17	AP3-RCS-1-1877L	\$4,513

- 83" w console return must be used with 36" d console desk
- 77" w console return must be used with 30" d console desk
- includes electrical power unit with two power outlets, one each CAT6 data and phone jack, 10' long power cord and 14' long phone and data cords
- includes bright white charging tray and bright white organizer tray with felt liner
- hinge door unit for wire access only
- surface grommet
- internal wire pass thru to low console bridge connector
- sliding top locking
- locking doors available, specify and add \$142 list

Low Console Bridge Connector with Hinge Door  left shown	22	36	15 ¾	88	10	AP7-CCR-1-2236R	\$1,947
	22	36	15 ¾	88	10	AP7-CCR-1-2236L	\$1,947
	22	30	15 ¾	78	8	AP7-CCR-1-2230R	\$1,798
	22	30	15 ¾	78	8	AP7-CCR-1-2230L	\$1,798

- use with console bridge only
- wall access pass thru
- locking door available, specify and add \$142 list

Freestanding Low Console Return  left shown  left shown	18	83	15 ¾	200	18	AP3-RCS-6-1883R	\$5,169
	18	83	15 ¾	200	18	AP3-RCS-6-1883L	\$5,169
	18	77	15 ¾	190	17	AP3-RCS-6-1877R	\$4,587
	18	77	15 ¾	190	17	AP3-RCS-6-1877L	\$4,587

- 83" w console return must be used with 36" d console desk
- 77" w console return must be used with 30" d console desk
- includes electrical power unit with two power outlets, one each CAT6 data and phone jack, 10' long power cord and 14' long phone and data cords
- includes bright white charging tray and bright white organizer tray with felt liner
- hinge door unit for wire access only
- surface grommet
- sliding top locking
- locking doors available, specify and add \$142 list

To Order, Specify:

Desk

- ① Model Number
- ② Wood Species on Top/Veneer Wrapped Apron - Makore (MK2), Maple (MA2), Walnut (WA2), Black Oak (BO1) or Double Cut (DC1) (see page AP32)
- ③ Finish Color for Top/Veneer Wrapped Apron (see page AP32)
- ④ Leg Accent Finish
 - a.) Same as Top
 - b.) Paint (see page AP32)

- ⑤ Finish Color for Post Panel
 - a.) Same as Top
 - b.) Paint (see page AP32)
- ⑥ Metal Open Frame Color or Metal Post Accent Color (see page AP32)
- ⑦ Finish Color for Modesty Panel:
 - a.) Same as Top
 - b.) Same as Chassis/Drawer Fronts or Paint Color (see page AP32)

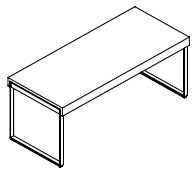
Note: Only one wood finish and one paint color can be specified per unit

To Order, Specify:

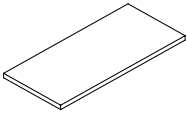
Console

- ① Model Number
- ② Species on Chassis/Drawers/Doors - Makore (MK2), Maple (MA2), Walnut (WA2), Double Cut (DC1) or Paint (PNT) (see page AP32)
- ③ Finish Color for Chassis/Drawers/Doors (see page AP32)
- ④ Finish Color for Base
 - a.) Same as Chassis/Drawers/Doors
 - b.) Paint (see page AP32)

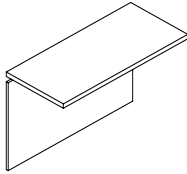
Description	D	W	H	CTN WT	CU FT	① Model	List Price
-------------	---	---	---	-----------	----------	---------	------------



- veneer top with veneer wrapped apron
- straight apron both sides
- top long grain veneer direction
- grommet available, specify and add \$114 list each; [see page AP20](#) for diagram G1
- kneespace height: 25½"
- kneespace width between legs: 80"

Bridge Top 	22	56	1 ⅞	42	3	AP3-BTU-1-2256	\$1,299
	22	50	1 ⅞	38	3	AP3-BTU-1-2250	\$1,277
	22	44	1 ⅞	34	3	AP3-BTU-1-2244	\$1,256

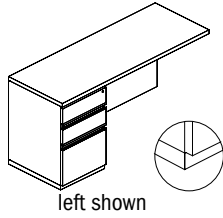
- short grain veneer direction
- flat bracket connectors included
- for mounting to open frame table desk order 6-AB angle bracket, see page 173
- grommet available, specify and add \$114 list each; [see page AP20](#)

Bridge with Modesty Panel 	22	56	29 ½	77	13	AP3-BMR-1-2256	\$2,050
	22	50	29 ½	69	12	AP3-BMR-1-2250	\$2,004
	22	44	29 ½	61	10	AP3-BMR-1-2244	\$1,960

- top short grain veneer direction
- finished, removable inset back panel
- cannot be used with AM7-CSP-1-2206 or AM7-CSP-1-1506 end support
- adjustable levelers/glides
- grommet available, specify and add \$114 list each; [see page AP20](#)
- kneespace height: 28 ¼"

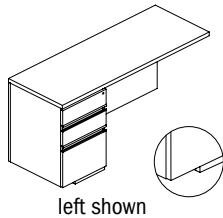
APOGEE™

Description	D	W	H	CTN WT	CU FT	① Model	List Price
Return with Flush Base	22	60	29 ½	179	28	AP3-RTP-1-2260R	\$3,342
	22	60	29 ½	179	28	AP3-RTP-1-2260L	\$3,342
	22	54	29 ½	169	25	AP3-RTP-1-2254R	\$3,286
	22	54	29 ½	169	25	AP3-RTP-1-2254L	\$3,286
	22	48	29 ½	158	23	AP3-RTP-1-2248R	\$3,224
	22	48	29 ½	158	23	AP3-RTP-1-2248L	\$3,224



- base on pedestal is flush
- 15 ½" w utility/box/file pedestal
- utility drawer with box drawer front
- soft close utility/box/file drawers
- pedestal front locking
- top short grain veneer direction
- adjustable levelers/glides
- grommet available, specify and add \$114 list each; [see page AP21](#)
- kneespace height: 28 ¼"
- -2260 kneespace width: 44 ½"
- -2254 kneespace width: 38 ½"
- -2248 kneespace width: 32 ½"

Return with Inset Base	22	60	29 ½	176	28	AP3-RTP-1R-2260R	\$3,342
	22	60	29 ½	176	28	AP3-RTP-1L-2260L	\$3,342
	22	54	29 ½	165	25	AP3-RTP-1R-2254R	\$3,286
	22	54	29 ½	165	25	AP3-RTP-1L-2254L	\$3,286
	22	48	29 ½	155	23	AP3-RTP-1R-2248R	\$3,224
	22	48	29 ½	155	23	AP3-RTP-1L-2248L	\$3,224



- base on pedestal is inset on one side
- 15 ½" w utility/box/file pedestal
- utility drawer with box drawer front
- soft close utility/box/file drawers
- pedestal front locking
- top short grain veneer direction
- adjustable levelers/glides
- grommet available, specify and add \$114 list each; [see page AP21](#)
- kneespace height: 28 ¼"
- -2260 kneespace width: 44 ½"
- -2254 kneespace width: 38 ½"
- -2248 kneespace width: 32 ½"

To Order, Specify:

- ① Model Number
- ② Wood Species on Top/Veneer Wrapped Apron - Makore (MK2), Maple (MA2), Walnut (WA2), Black Oak (BO1) or Double Cut (DC1) [\(see page AP32\)](#)
- ③ Finish Color for Top/Veneer Wrapped Apron [\(see page AP32\)](#)
- ④ Chassis/Drawer Fronts Finish:
 - a.) Same as Top
 - b.) Paint [\(see page AP32\)](#)
- ⑤ Leg Accent Finish
 - a.) Same as Top
 - b.) Paint [\(see page AP32\)](#)

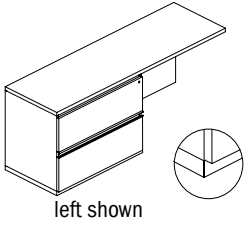
Product Modifications:

Pedestal Change - [see page AP9](#)

- ⑥ Finish Color for Base
 - a.) Same as Top
 - b.) Paint [\(see page AP32\)](#)
- ⑦ Metal Open Frame Color [\(see page AP32\)](#)
- ⑧ Bridge Modesty Panel Finish:
 - a.) Same as Top
 - b.) Paint [\(see page AP32\)](#)

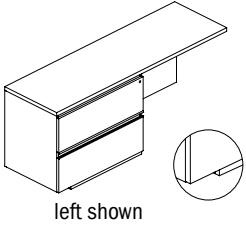
Note: Only one wood finish and one paint color can be specified per unit

Description	D	W	H	CTN WT	CU FT	① Model	List Price
Lateral File Return with Flush Base	22	72	29½	249	33	AP3-RTL-1-2272R	\$4,135
	22	72	29½	249	33	AP3-RTL-1-2272L	\$4,135
	22	66	29½	220	31	AP3-RTL-1-2266R	\$4,078
	22	66	29½	220	31	AP3-RTL-1-2266L	\$4,078
	22	60	29½	210	28	AP3-RTL-1-2260R	\$4,017
	22	60	29½	210	28	AP3-RTL-1-2260L	\$4,017



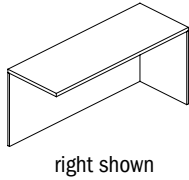
- base on pedestal is flush
- top short grain veneer direction
- pedestal front locking
- adjustable levelers/glides
- grommet available, specify and add \$114 list each; [see page AP20](#)
- kneespace height: 28¼"
- -2272 lateral files: 36"w
- -2266 or -2260 lateral files: 30"w
- -2272 & -2266 kneespace width: 36"
- -2260 kneespace width: 30"

Lateral File Return with Inset Base	22	72	29½	246	33	AP3-RTL-1R-2272R	\$4,135
	22	72	29½	246	33	AP3-RTL-1L-2272L	\$4,135
	22	66	29½	217	31	AP3-RTL-1R-2266R	\$4,078
	22	66	29½	217	31	AP3-RTL-1L-2266L	\$4,078
	22	60	29½	207	28	AP3-RTL-1R-2260R	\$4,017
	22	60	29½	207	28	AP3-RTL-1L-2260L	\$4,017



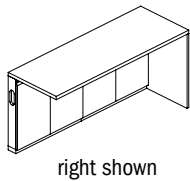
- base on pedestal is inset on one side
- top short grain veneer direction
- pedestal front locking
- adjustable levelers/glides
- grommet available, specify and add \$114 list each; [see page AP20](#)
- kneespace height: 28¼"
- -2272 lateral files: 36"w
- -2266 or -2260 lateral files: 30"w
- -2272 & -2266 kneespace width: 36"
- -2260 kneespace width: 30"

Description	D	W	H	CTN WT	CU FT	① Model	List Price
Return Shell	22	72	29 ½	149	33	AP3-RTS-1-2272R	\$2,608
	22	72	29 ½	149	33	AP3-RTS-1-2272L	\$2,608
	22	66	29 ½	138	31	AP3-RTS-1-2266R	\$2,521
	22	66	29 ½	138	31	AP3-RTS-1-2266L	\$2,521
	22	60	29 ½	128	28	AP3-RTS-1-2260R	\$2,435
	22	60	29 ½	128	28	AP3-RTS-1-2260L	\$2,435



- use with end panel desk
- top short grain veneer direction
- finished back panel
- adjustable levelers/glides
- grommet available, specify and add \$114 list each; [see page AP21](#)
- kneespace height: 28 ¼"

Return Shell with Wall Access Panel	22	72	29 ½	158	15	AP3-RTS-8-2272R	\$4,310
	22	72	29 ½	158	15	AP3-RTS-8-2272L	\$4,310
	22	66	29 ½	148	14	AP3-RTS-8-2266R	\$4,092
	22	66	29 ½	148	14	AP3-RTS-8-2266L	\$4,092
	22	60	29 ½	137	13	AP3-RTS-8-2260R	\$3,872
	22	60	29 ½	137	13	AP3-RTS-8-2260L	\$3,872



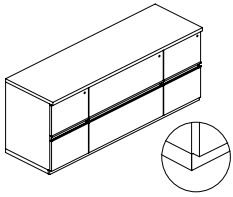
- use with access panel desk
- top short grain veneer direction
- access for outlets 18"-24" AFF (Above Finished Floor)
- wire pass thru holes
- hinge doors
- due to back construction unit is intended to sit against wall for wall access
- adjustable levelers/glides
- grommet available, specify and add \$114 list each; [see page AP21](#)
- kneespace height: 28 ¼"

To Order, Specify:

- ① Model Number
- ② Wood Species on Top - Makore (MK2), Maple (MA2) Walnut (WA2), Black Oak (BO1) or Double Cut (DC1) [\(see page AP32\)](#)
- ③ Finish Color for Top [\(see page AP32\)](#)
- ④ Finish Color for Chassis/Drawer Fronts
 - a.) Same as Top
 - b.) Paint Color [\(see page AP32\)](#)
- ⑤ Finish Color for Base
 - a.) Same as Top
 - b.) Same as Chassis/Drawer Fronts or Paint [\(see page AP32\)](#)

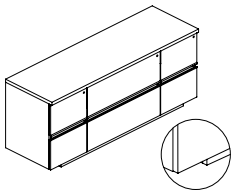
Note: Only one wood finish and one paint color can be specified per unit

Description	D	W	H	CTN WT	CU FT	① Model	List Price
Storage Credenza with Flush Base	22	72	29½	377	33	AP2-DSN-1-2272	\$6,986



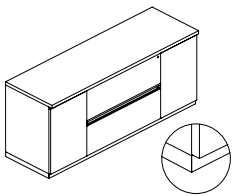
- base is flush
- top long grain veneer direction
- pedestal front locking
- two 36" w lateral files
- four 18" w file/file pedestals
- 18" w soft close file/file drawers
- adjustable levelers/glides

Storage Credenza with Inset Base	22	72	29½	370	33	AP2-DSN-B-2272	\$6,986
---	----	----	-----	-----	----	-----------------------	----------------



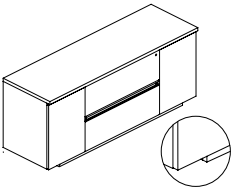
- base is inset on both sides
- top long grain veneer direction
- pedestal front locking
- two 36" w lateral files
- four 18" w file/file pedestals
- 18" w soft close file/file drawers
- adjustable levelers/glides

Storage Credenza with Flush Base	22	72	29½	347	33	AP2-HPD-1-2272	\$6,367
	22	60	29½	303	28	AP2-HPD-1-2260	\$6,221



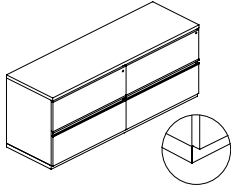
- base is flush
- top long grain veneer direction
- pedestal front locking
- locking doors available, specify and add \$284 list
- soft close hinge doors
- door top has concealed bevel for opening
- adjustable levelers/glides
- grommet available, specify and add \$114 list each; [see page AP21](#)
- -2272 two hinged door compartments with adjustable shelf, 18" w
- -2272 two 36" w lateral files
- -2260 two hinged door compartments with adjustable shelf, 15" w
- -2260 two 30" w lateral files

Storage Credenza with Inset Base	22	72	29½	340	33	AP2-HPD-B-2272	\$6,367
	22	60	29½	297	28	AP2-HPD-B-2260	\$6,221



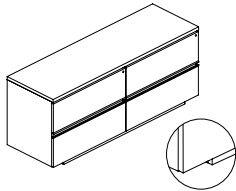
- base is inset on both sides
- top long grain veneer direction
- pedestal front locking
- locking doors available, specify and add \$284 list
- soft close hinge doors
- door top has concealed bevel for opening
- adjustable levelers/glides
- grommet available, specify and add \$114 list each; [see page AP21](#)
- -2272 two hinged door compartments with adjustable shelf, 18" w
- -2272 two 36" w lateral files
- -2260 two hinged door compartments with adjustable shelf, 15" w
- -2260 two 30" w lateral files

Description	D	W	H	CTN WT	CU FT	① Model	List Price
Lateral File Credenza with Flush Base	22	72	29 ½	360	33	AP2-DST-1-2272	\$6,623
	22	60	29 ½	297	28	AP2-DST-1-2260	\$6,476



- base is flush
- top long grain veneer direction
- pedestal front locking
- adjustable levelers/glides
- -2272 four 36" w lateral files
- -2260 four 30" w lateral files

Lateral File Credenza with Inset Base	22	72	29 ½	353	33	AP2-DST-B-2272	\$6,623
	22	60	29 ½	296	28	AP2-DST-B-2260	\$6,476



- base is inset on both sides
- top long grain veneer direction
- pedestal front locking
- adjustable levelers/glides
- -2272 four 36" w lateral files
- -2260 four 30" w lateral files

APOGEE™

To Order, Specify:

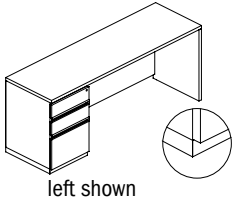
- ① Model Number
- ② Wood Species on Top - Makore (MK2), Maple (MA2) Walnut (WA2), Black Oak (BO1) or Double Cut (DC1)
(see page AP32)
- ③ Finish Color for Top *(see page AP32)*
- ④ Finish Color for Chassis/Drawer Fronts
 - a.) Same as Top
 - b.) Paint *(see page AP32)*
- ⑤ Finish Color for Base
 - a.) Same as Top
 - b.) Same as Chassis/Drawer Fronts or Paint *(see page AP32)*

Note: Only one wood finish and one paint color can be specified per unit

Product Modifications:

Pedestal Change - [see page AP9](#)

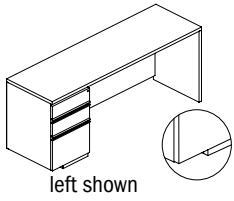
Description	D	W	H	CTN WT	CU FT	① Model	List Price
Open Corner Credenza with Flush Base	22	72	29½	208	33	AP2-OCP-1-2272R	\$4,046
	22	72	29½	208	33	AP2-OCP-1-2272L	\$4,046
	22	66	29½	193	31	AP2-OCP-1-2266R	\$3,959
	22	66	29½	193	31	AP2-OCP-1-2266L	\$3,959
	22	60	29½	185	28	AP2-OCP-1-2260R	\$3,872
	22	60	29½	185	28	AP2-OCP-1-2260L	\$3,872



left shown

- base on pedestal is flush
- top long grain veneer direction
- pedestal front locking
- soft close utility/box/file drawers
- adjustable levelers/glides
- grommet available, specify and add \$114 list each; [see page AP21](#)
- kneespace height: 28 ¼"
- -2272 utility/box/file pedestal, 18"w
- -2260 utility/box/file pedestal, 15 ½"w
- -2272 kneespace width: 52 ¾"
- -2266 kneespace width: 49 ¼"
- -2260 kneespace width: 43 ¼"

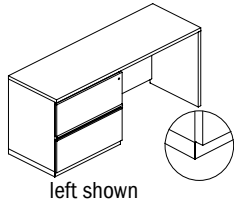
Open Corner Credenza with Inset Base	22	72	29½	204	33	AP2-OCP-1R-2272R	\$4,046
	22	72	29½	204	33	AP2-OCP-1L-2272L	\$4,046
	22	66	29½	190	31	AP2-OCP-1R-2266R	\$3,959
	22	66	29½	190	31	AP2-OCP-1L-2266L	\$3,959
	22	60	29½	181	28	AP2-OCP-1R-2260R	\$3,872
	22	60	29½	181	28	AP2-OCP-1L-2260L	\$3,872



left shown

- base on pedestal is inset on one side
- top long grain veneer direction
- pedestal front locking
- soft close utility/box/file drawers
- adjustable levelers/glides
- grommet available, specify and add \$114 list each; [see page AP21](#)
- kneespace height: 28 ¼"
- -2272 utility/box/file pedestal, 18"w
- -2260 utility/box/file pedestal, 15 ½"w
- -2272 kneespace width: 52 ¾"
- -2266 kneespace width: 49 ¼"
- -2260 kneespace width: 43 ¼"

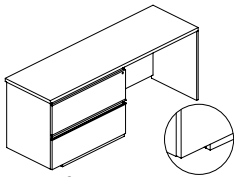
Description	D	W	H	CTN WT	CU FT	① Model	List Price
Open Corner Lateral File Credenza with Flush Base	22	72	29 ½	257	33	AP2-OCL-1-2272R	\$4,513
	22	72	29 ½	257	33	AP2-OCL-1-2272L	\$4,513
	22	66	29 ½	229	31	AP2-OCL-1-2266R	\$4,425
	22	66	29 ½	229	31	AP2-OCL-1-2266L	\$4,425
	22	60	29 ½	217	28	AP2-OCL-1-2260R	\$4,337
	22	60	29 ½	217	28	AP2-OCL-1-2260L	\$4,337



left shown

- base on pedestal is flush
- top long grain veneer direction
- pedestal front locking
- adjustable levelers/glides
- grommet available, specify and add \$114 list each; [see page AP21](#)
- kneespace height: 28 ¼"
- -2272 file/file pedestal, 36"w
- -2266 & -2260 file/file pedestal, 30"w
- -2272 or -2266 kneespace width: 34 ⅞"
- -2260 kneespace width: 28 ⅞"

Open Corner Lateral File Credenza with Inset Base	22	72	29 ½	254	33	AP2-OCL-1R-2272R	\$4,513
	22	72	29 ½	254	33	AP2-OCL-1L-2272L	\$4,513
	22	66	29 ½	225	31	AP2-OCL-1R-2266R	\$4,425
	22	66	29 ½	225	31	AP2-OCL-1L-2266L	\$4,425
	22	60	29 ½	214	28	AP2-OCL-1R-2260R	\$4,337
	22	60	29 ½	214	28	AP2-OCL-1L-2260L	\$4,337



left shown

- base on pedestal is inset on one side
- top long grain veneer direction
- pedestal front locking
- adjustable levelers/glides
- grommet available, specify and add \$114 list each; [see page AP21](#)
- kneespace height: 28 ¼"
- -2272 file/file pedestal, 36"w
- -2266 & -2260 file/file pedestal, 30"w
- -2272 or -2266 kneespace width: 34 ⅞"
- -2260 kneespace width: 28 ⅞"

To Order, Specify:

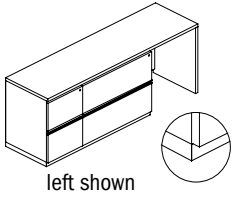
- ① Model Number
- ② Wood Species on Top - Makore (MK2), Maple (MA2) Walnut (WA2), Black Oak (BO1) or Double Cut (DC1) [\(see page AP32\)](#)
- ③ Finish Color for Top [\(see page AP32\)](#)
- ④ Finish Color for Chassis/Drawer Fronts
 - a.) Same as Top
 - b.) Paint [\(see page AP32\)](#)
- ⑤ Finish Color for Base
 - a.) Same as Top
 - b.) Same as Chassis/Drawer Fronts or Paint [\(see page AP32\)](#)

Note: Only one wood finish and one paint color can be specified per unit

Product Modifications:

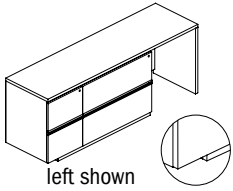
Pedestal Change - [see page AP9](#)

Description	D	W	H	CTN WT	CU FT	① Model	List Price
Open Corner Credenza with Flush Base	22	84	29½	354	39	AP2-OBL-1-2284R	\$6,403
	22	84	29½	354	39	AP2-OBL-1-2284L	\$6,403
	22	78	29½	345	36	AP2-OBL-1-2278R	\$6,331
	22	78	29½	345	36	AP2-OBL-1-2278L	\$6,331



- base is flush
- top long grain veneer direction
- pedestal front locking
- 18" w file/file pedestal
- 36" w lateral file
- 18" w soft close file/file drawers
- adjustable levelers/glides
- grommet available, specify and add \$114 list each; [see page AP21](#)
- kneespace height: 28 ¼"
- -2284 kneespace width: 28 ⅞"
- -2278 kneespace width: 22 ⅞"

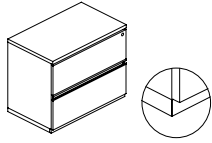
Open Corner Credenza with Inset Base	22	84	29½	350	39	AP2-OBL-1R-2284R	\$6,403
	22	84	29½	350	39	AP2-OBL-1L-2284L	\$6,403
	22	78	29½	342	36	AP2-OBL-1R-2278R	\$6,331
	22	78	29½	342	36	AP2-OBL-1L-2278L	\$6,331



- base is inset on one side
- top long grain veneer direction
- pedestal front locking
- 18" w file/file pedestal
- 36" w lateral file
- 18" w soft close file/file drawers
- adjustable levelers/glides
- grommet available, specify and add \$114 list each; [see page AP21](#)
- kneespace height: 28 ¼"
- -2284 kneespace width: 28 ⅞"
- -2278 kneespace width: 22 ⅞"

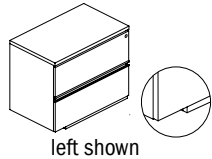
Freestanding

Description	D	W	H	CTN WT	CU FT	① Model	List Price
Two-High Lateral File with Flush Base	22	36	29 ½	182	17	AP6-FLS-1-2236	\$3,350
	22	30	29 ½	154	14	AP6-FLS-1-2230	\$3,276



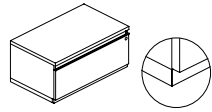
- base is flush
- top long grain veneer direction
- pedestal front locking
- adjustable levelers/glides

Two-High Lateral File with Inset Base	22	36	29 ½	179	17	AP6-FLS-1R-2236R	\$3,350
	22	36	29 ½	179	17	AP6-FLS-1L-2236L	\$3,350
	22	30	29 ½	150	14	AP6-FLS-1R-2230R	\$3,276
	22	30	29 ½	150	14	AP6-FLS-1L-2230L	\$3,276



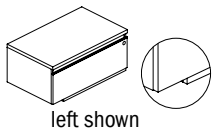
- base is inset on one side
- top long grain veneer direction
- pedestal front locking
- adjustable levelers/glides

One-High Lateral File with Flush Base	22	36	16 7/8	131	10	AP6-FLA-1-2236	\$2,551
	22	30	16 7/8	111	9	AP6-FLA-1-2230	\$2,477



- base is flush
- top long grain veneer direction
- pedestal front locking
- adjustable levelers/glides

One-High Lateral File with Inset Base	22	36	16 7/8	128	10	AP6-FLA-1R-2236R	\$2,551
	22	36	16 7/8	128	10	AP6-FLA-1L-2236L	\$2,551
	22	30	16 7/8	107	9	AP6-FLA-1R-2230R	\$2,477
	22	30	16 7/8	107	9	AP6-FLA-1L-2230L	\$2,477



- base is inset on one side
- top long grain veneer direction
- pedestal front locking
- adjustable levelers/glides

To Order, Specify:

- ① Model Number
- ② Wood Species on Top - Makore (MK2), Maple (MA2) Walnut (WA2), Black Oak (BO1) or Double Cut (DC1) (see page AP32)
- ③ Finish Color for Top (see page AP32)
- ④ Finish Color for Chassis/Drawer Fronts
 - a.) Same as Top
 - b.) Paint (see page AP32)
- ⑤ Finish Color for Base
 - a.) Same as Top
 - b.) Same as Chassis/Drawer Fronts or Paint (see page AP32)

Note: Only one wood finish and one paint color can be specified per unit

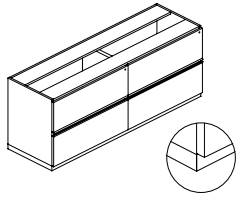
Product Modifications:

Pedestal Change - see page AP9

Modular

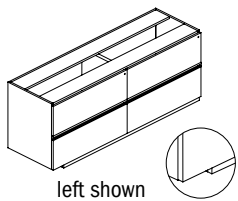
APOGEE™

Description	D	W	H	CTN WT	CU FT	① Model	List Price
Two-High Lateral File with Flush Base	22	72	28 3/8	307	32	AM7-FLS-1-2272	\$4,876
	22	60	28 3/8	253	27	AM7-FLS-1-2260	\$4,732



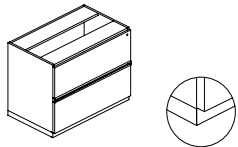
- without top
- base is flush
- pedestal front locking
- adjustable levelers/glides
- modular top required, [see page AP61](#)
- -2272 four 36" w lateral files
- -2260 four 30" w lateral files

Two-High Lateral File with Inset Base	22	72	28 3/8	304	32	AM7-FLS-1R-2272R	\$4,876
	22	72	28 3/8	304	32	AM7-FLS-1L-2272L	\$4,876
	22	60	28 3/8	250	27	AM7-FLS-1R-2260R	\$4,732
	22	60	28 3/8	250	27	AM7-FLS-1L-2260L	\$4,732



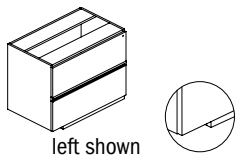
- without top
- base is inset on one side
- pedestal front locking
- adjustable levelers/glides
- modular top required, [see page AP61](#)
- -2272 four 36" w lateral files
- -2260 four 30" w lateral files

Two-High Lateral File with Flush Base	22	36	28 3/8	157	17	AM7-FLS-1-2236	\$2,665
	22	30	28 3/8	129	14	AM7-FLS-1-2230	\$2,593



- without top
- base is flush
- pedestal front locking
- adjustable levelers/glides
- modular top required, [see page AP61](#)

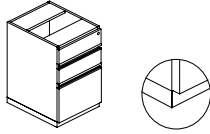
Two-High Lateral File with Inset Base	22	36	28 3/8	153	17	AM7-FLS-1R-2236R	\$2,665
	22	36	28 3/8	153	17	AM7-FLS-1L-2236L	\$2,665
	22	30	28 3/8	126	14	AM7-FLS-1R-2230R	\$2,593
	22	30	28 3/8	126	14	AM7-FLS-1L-2230L	\$2,593



- without top
- base is inset on one side
- pedestal front locking
- adjustable levelers/glides
- modular top required, [see page AP61](#)

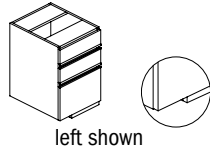
Modular

Description	D	W	H	CTN WT	CU FT	① Model	List Price
Utility/Box/File Pedestal with Flush Base	22	18	28 3/8	95	9	AM7-PUN-1-2218	\$1,728



- without top
base is flush
- utility drawer with box drawer front
- pedestal front locking
- soft close drawers
- adjustable levelers/glides
- modular top required, [see page AP61](#)

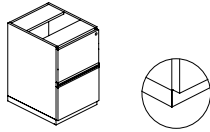
Utility/Box/File Pedestal with Inset Base	22	18	28 3/8	92	9	AM7-PUN-1R-2218R	\$1,728
	22	18	28 3/8	92	9	AM7-PUN-1L-2218L	\$1,728



- without top
- base is inset on one side
- utility drawer with box drawer front
- pedestal front locking
- soft close drawers
- adjustable levelers/glides
- modular top required, [see page AP61](#)

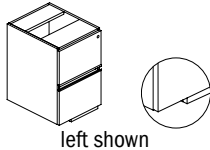
Note: not a stand alone unit

File/File Pedestal with Flush Base	22	18	28 3/8	95	9	AM7-PUN-M-2218	\$1,728
------------------------------------	----	----	--------	----	---	----------------	---------



- without top
- base is flush
- pedestal front locking
- soft close drawers
- adjustable levelers/glides
- modular top required, [see page AP61](#)

File/File Pedestal with Inset Base	22	18	28 3/8	92	9	AM7-PUN-MR-2218R	\$1,728
	22	18	28 3/8	92	9	AM7-PUN-ML-2218L	\$1,728



- without top
- base is inset on one side
- pedestal front locking
- soft close drawers
- adjustable levelers/glides
- modular top required, [see page AP61](#)

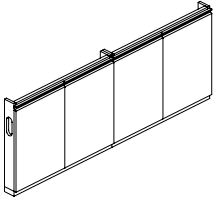
Note: not a stand alone unit

To Order, Specify:

- ① Model Number
- ② Wood Species/Paint on Chassis/Drawer Fronts -
Makore (MK2), Maple (MA2), Walnut (WA2), Black Oak (BO1)
Double Cut (DC1) or Paint (PNT)
[\(see page AP32\)](#)
- ③ Finish Color for Chassis/Drawer Fronts
[\(see page AP32\)](#)
- ④ Finish Color for Base
 - a.) Same as Chassis/Drawer Fronts
 - b.) Paint [\(see page AP32\)](#)

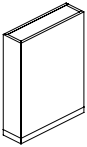
Note: Only one wood finish and one paint color can be specified per unit

Description	D	W	H	CTN WT	CU FT	① Model	List Price
Kneespace Access Panel, Full Height	4	72	28 3/8	80	8	AM7-PAP-1-0472	\$2,753
	4	66	28 3/8	74	7	AM7-PAP-1-0466	\$2,534
	4	60	28 3/8	69	7	AM7-PAP-1-0460	\$2,318
	4	54	28 3/8	64	6	AM7-PAP-1-0454	\$2,170
	4	48	28 3/8	58	5	AM7-PAP-1-0448	\$2,025
	4	42	28 3/8	46	5	AM7-PAP-1-0442	\$1,880
	4	36	28 3/8	40	4	AM7-PAP-1-0436	\$1,737
	4	30	28 3/8	34	3	AM7-PAP-1-0430	\$1,591
	4	24	28 3/8	29	3	AM7-PAP-1-0424	\$1,445

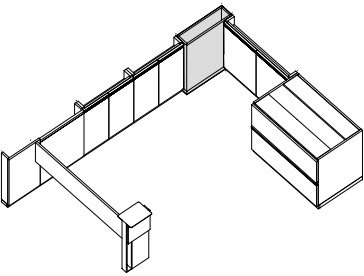


- hinge doors
- wire pass thru to allow access to the next unit
- access for outlets 18"-24" AFF (Above Finished Floor)
- cantilever bracket included
- adjustable levelers/glides
- due to back construction unit is intended to sit against wall for wall access
- recommend wall attachment

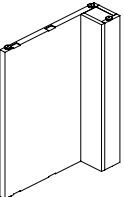
End Support	22	6	28 3/8	49	3	AM7-CSP-1-2206	\$1,509
	15	6	28 3/8	34	2	AM7-CSP-1-1506	\$1,351



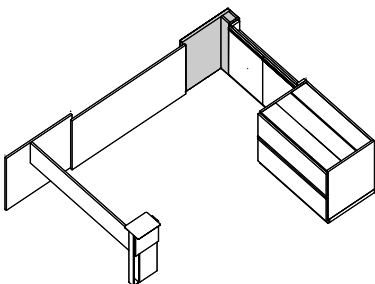
- use with modular components at the end of a run
- attachment bracket included
- non-handed, requires field boring for hardware
- adjustable levelers/glides



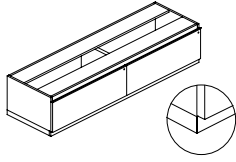
End Panel Transition to Access Panel	22	6	28 3/8	45	4	AM7-EPT-1-2206	\$1,678
	15	6	28 3/8	41	3	AM7-EPT-1-1506	\$1,451



- creates the transition from 1 1/8" panel to 6" thick access panel
- top attachment hardware included
- non-handed, bored for left or right applications
- adjustable levelers/glides

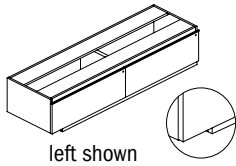


Description	D	W	H	CTN WT	CU FT	① Model	List Price
One-High Lateral File with Flush Base	22	72	15 ¾	205	19	AM7-FLA-1-2272	\$3,714
	22	60	15 ¾	170	16	AM7-FLA-1-2260	\$3,566



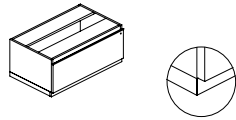
- without top
- base is flush
- pedestal front locking
- adjustable levelers/glides
- modular top required, [see page AP61](#)

One-High Lateral File with Inset Base	22	72	15 ¾	202	19	AM7-FLA-1R-2272R	\$3,714
	22	72	15 ¾	202	19	AM7-FLA-1L-2272L	\$3,714
	22	60	15 ¾	166	16	AM7-FLA-1R-2260R	\$3,566
	22	60	15 ¾	166	16	AM7-FLA-1L-2260L	\$3,566



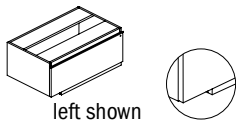
- without top
- base is inset on one side
- pedestal front locking
- adjustable levelers/glides
- modular top required, [see page AP61](#)

One-High Lateral File with Flush Base	22	36	15 ¾	105	10	AM7-FLA-1-2236	\$2,012
	22	30	15 ¾	87	8	AM7-FLA-1-2230	\$1,938



- without top
- base is flush
- pedestal front locking
- adjustable levelers/glides
- modular top required, [see page AP61](#)

One-High Lateral File with Inset Base	22	36	15 ¾	102	10	AM7-FLA-1R-2236R	\$2,012
	22	36	15 ¾	102	10	AM7-FLA-1L-2236L	\$2,012
	22	30	15 ¾	84	8	AM7-FLA-1R-2230R	\$1,938
	22	30	15 ¾	84	8	AM7-FLA-1L-2230L	\$1,938



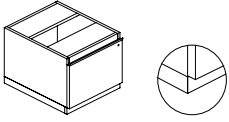
- without top
- base is inset on one side
- pedestal front locking
- adjustable levelers/glides
- modular top required, [see page AP61](#)

To Order, Specify:

- ① Model Number
- ② Wood Species/Paint on Chassis/Drawer Fronts -
Makore (MK2), Maple (MA2), Walnut (WA2), Black Oak (BO1)
Double Cut (DC1) or Paint (PNT)
[\(see page AP32\)](#)
- ③ Finish Color for Chassis/Drawer Fronts
[\(see page AP32\)](#)
- ④ Finish Color for Base
 - a.) Same as Chassis/Drawer Front
 - b.) Paint [\(see page AP32\)](#)

Note: Only one wood finish and one paint color can be specified per unit

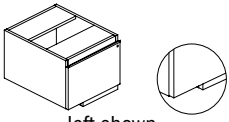
Description	D	W	H	CTN WT	CU FT	① Model	List Price
One-High Pedestal with Flush Base	22	18	15 ¾	62	5	AM7-PUA-1-2218	\$1,409



- without top
- base is flush
- soft close file drawer
- pedestal front locking
- adjustable levelers/glides
- modular top required, [see page AP61](#)

APOGEE™

One-High Pedestal with Inset Base	22	18	15 ¾	58	5	AM7-PUA-1R-2218R	\$1,409
	22	18	15 ¾	58	5	AM7-PUA-1L-2218L	\$1,409

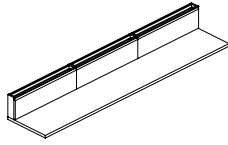


left shown

- without top
- base is inset on one side
- soft close file drawer
- pedestal front locking
- adjustable levelers/glides
- modular top required, [see page AP61](#)

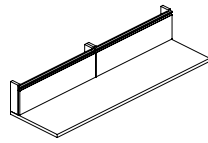
note: not a stand alone unit

Description	D	W	H	CTN WT	CU FT	① Model	List Price
Kneespace Access Panel, Partial Height with Workwall Top	22	108	12 5/8	135	24	AM7-WTP-1-22108	\$4,644
	22	90	12 5/8	114	20	AM7-WTP-1-2290	\$4,397



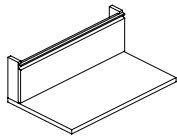
- use with one-high pedestals
- internal wire pass thru
- cantilever bracket included
- recommend wall attachment
- required access outlet 24" AFF (Above Finished Floor)

Kneespace Access Panel, Partial Height with Workwall Top	22	72	12 5/8	90	16	AM7-WTP-1-2272	\$3,611
	22	60	12 5/8	76	13	AM7-WTP-1-2260	\$3,365



- use with one-high pedestals
- internal wire pass thru
- cantilever bracket included
- recommend wall attachment
- required access outlet 24" AFF (Above Finished Floor)

Kneespace Access Panel, Partial Height with Workwall Top	22	36	12 5/8	45	8	AM7-WTP-1-2236	\$2,143
	22	30	12 5/8	38	7	AM7-WTP-1-2230	\$1,981



- use with one-high pedestals
- internal wire pass thru
- recommend wall attachment
- required access outlet 24" AFF (Above Finished Floor)

To Order, Specify:

Pedestal

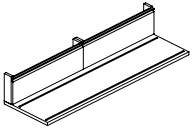
- ① Model Number
- ② Wood Species/Paint on Chassis/Drawer Front - Makore (MK2), Maple (MA2), Walnut (WA2), Black Oak (BO1), Double Cut (DC1) or Paint (PNT) [\(see page AP32\)](#)
- ③ Finish Color for Chassis/Drawer Fronts [\(see page AP32\)](#)
- ④ Finish Color for Base
 - a.) Same as Chassis/Drawer Front
 - b.) Paint [\(see page AP32\)](#)

Access Panel

- ① Model Number
- ② Wood Species on Top - Makore (MK2), Maple (MA2), Walnut (WA2), Black Oak (BO1) or Double Cut (DC1) [\(see page AP32\)](#)
- ③ Finish Color for Top [\(see page AP32\)](#)
- ④ Finish Color for Chassis/Door Front
 - a.) Same as Top
 - b.) Paint [\(see page AP32\)](#)

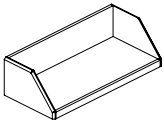
Note: Only one wood finish and one paint color can be specified per unit

Description	D	W	H	CTN WT	CU FT	① Model	List Price
22" d Workwall Top with Shuttle Tracks and Access Panels	22	108	12 5/8	142	24	AM7-WTP-SH-22108	\$4,789
	22	90	12 5/8	120	20	AM7-WTP-SH-2290	\$4,521
	22	72	12 5/8	95	16	AM7-WTP-SH-2272	\$3,714
	22	60	12 5/8	80	13	AM7-WTP-SH-2260	\$3,457



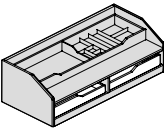
- use with one-high lateral files
- must be used between modular tower units or two-high units
- internal wire pass thru
- cantilever bracket included
- recommend wall attachment
- access outlet 24" AFF (Above Finished Floor)

Storage Shuttle	16	36	10 1/8	26	5	AM9-SHU-9-1636	\$760
	16	30	10 1/8	22	4	AM9-SHU-9-1630	\$747

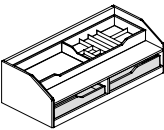


- must use with shuttle top
- available in painted finishes only

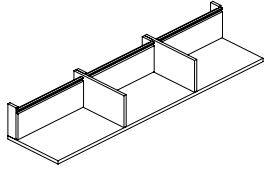
Piling Shuttle	16	36	10 1/8	48	5	AM9-SHU-PM-1636	\$1,860
	16	30	10 1/8	37	4	AM9-SHU-PM-1630	\$1,765



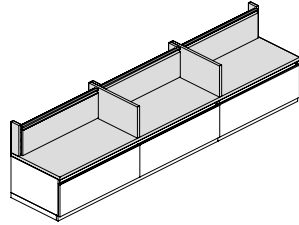
- must use with shuttle top
- shuttle and organizer trays available in painted finishes only
- paper trays available in wood or painted finishes
- -1636 consists of (1) organizer tray and (2) legal paper trays
- -1630 consists of (1) organizer tray and (2) letter paper trays



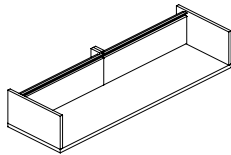
Description	D	W	H	CTN WT	CU FT	① Model	List Price
Kneespace Access Panel with 22"d Extensions, Partial Height with Workwall Top	22	108	12 5/8	150	24	AM7-WTP-EX-22108	\$4,084
	22	90	12 5/8	124	20	AM7-WTP-EX-2290	\$3,838



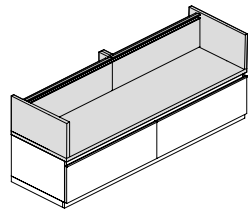
- use with one-high pedestals
- doors flip down for access to the wall
- internal wire pass thru
- access outlet 24" AFF (Above Finished Floor)
- due to back construction unit is intended to sit against wall for wall access
- 22"d extensions



Kneespace Access Panel with 22"d Extensions, Partial Height with Workwall Top	22	72	12 5/8	95	16	AM7-WTP-EX-2272	\$3,342
	22	60	12 5/8	86	13	AM7-WTP-EX-2260	\$3,182



- use with one-high pedestals
- doors flip down for access to the wall
- internal wire pass thru
- access outlet 24" AFF (Above Finished Floor)
- due to back construction unit is intended to sit against wall for wall access
- 22"d extensions



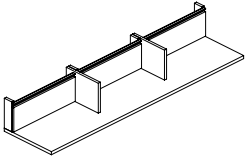
To Order, Specify:

- ① Model Number
- ② Wood Species on Top - Makore (MK2), Maple (MA2), Walnut (WA2), Black Oak (BO1) or Double Cut (DC1) (see page AP32)
- ③ Finish Color for Top (see page AP32)
- ④ Finish Color for Chassis/Door Front
 - a.) Same as Top
 - b.) Paint (see page AP32)

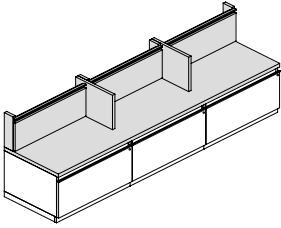
Note: Only one wood finish and one paint color can be specified per unit

APOGEE™

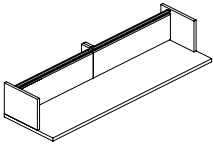
Description	D	W	H	CTN WT	CU FT	① Model	List Price
Kneespace Access Panel with 15"d Extensions, Partial Height with Workwall Top	22	108	12 5/8	145	24	AM7-WTP-ES-22108	\$4,011
	22	90	12 5/8	119	20	AM7-WTP-ES-2290	\$3,672



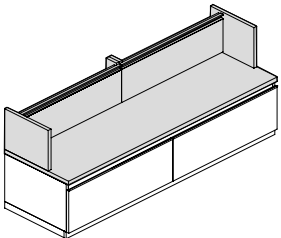
- use with one-high pedestals
- doors flip down for access to the wall
- internal wire pass thru
- access outlet 24" AFF (Above Finished Floor)
- due to back construction unit is intended to sit against wall for wall access
- 15"d extensions

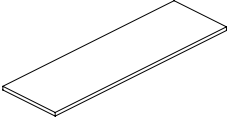


Kneespace Access Panel with 15"d Extensions, Partial Height with Workwall Top	22	72	12 5/8	95	16	AM7-WTP-ES-2272	\$3,270
	22	60	12 5/8	81	13	AM7-WTP-ES-2260	\$3,109



- use with one-high pedestals
- doors flip down for access to the wall
- internal wire pass thru
- access outlet 24" AFF (Above Finished Floor)
- due to back construction unit is intended to sit against wall for wall access
- 15"d extensions



Description	D	W	H	CTN WT	CU FT	① Model	List Price
22"d Workwall Top 	22	120	1 1/8	89	7	AM7-WTU-1-22120	\$2,265
	22	114	1 1/8	85	7	AM7-WTU-1-22114	\$2,179
	22	108	1 1/8	80	6	AM7-WTU-1-22108	\$2,091
	22	102	1 1/8	76	6	AM7-WTU-1-22102	\$2,004
	22	96	1 1/8	71	6	AM7-WTU-1-2296	\$1,916
	22	90	1 1/8	67	5	AM7-WTU-1-2290	\$1,829
	22	84	1 1/8	62	5	AM7-WTU-1-2284	\$1,684
	22	78	1 1/8	58	5	AM7-WTU-1-2278	\$1,597
	22	72	1 1/8	53	4	AM7-WTU-1-2272	\$1,509
	22	66	1 1/8	49	4	AM7-WTU-1-2266	\$1,421
	22	60	1 1/8	45	4	AM7-WTU-1-2260	\$1,335
	22	54	1 1/8	40	3	AM7-WTU-1-2254	\$1,247
	22	48	1 1/8	36	3	AM7-WTU-1-2248	\$1,162
	22	42	1 1/8	32	3	AM7-WTU-1-2242	\$1,074
	22	36	1 1/8	27	2	AM7-WTU-1-2236	\$986
	22	30	1 1/8	23	2	AM7-WTU-1-2230	\$898

· long grain veneer direction

APOGEE™

To Order, Specify:

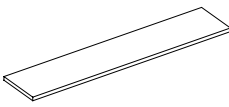
Access Panel

- ① Model Number
- ② Wood Species on Top - Makore (MK2), Maple (MA2), Walnut (WA2), Black Oak (BO1) or Double Cut (DC1) [\(see page AP32\)](#)
- ③ Finish Color for Top [\(see page AP32\)](#)
- ④ Finish Color for Chassis/Door Front
 - a.) Same as Top
 - b.) Paint [\(see page AP32\)](#)

Workwall Top

- ① Model Number
- ② Wood Species - Makore (MK2), Maple (MA2), Walnut (WA2), Black Oak (BO1) or Double Cut (DC1) [\(see page AP32\)](#)
- ③ Finish Color [\(see page AP32\)](#)

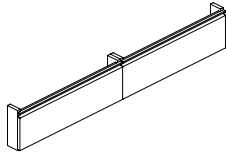
Note: Only one wood finish and one paint color can be specified per unit

Description	D	W	H	CTN WT	CU FT	① Model	List Price
15" d Workwall Top 	15	120	1 7/8	61	5	AM7-WTU-1-15120	\$1,787
	15	114	1 7/8	58	5	AM7-WTU-1-15114	\$1,728
	15	108	1 7/8	55	4	AM7-WTU-1-15108	\$1,671
	15	102	1 7/8	52	4	AM7-WTU-1-15102	\$1,612
	15	96	1 7/8	49	4	AM7-WTU-1-1596	\$1,554
	15	90	1 7/8	46	4	AM7-WTU-1-1590	\$1,496
	15	84	1 7/8	43	3	AM7-WTU-1-1584	\$1,378
	15	78	1 7/8	40	3	AM7-WTU-1-1578	\$1,321
	15	72	1 7/8	37	3	AM7-WTU-1-1572	\$1,263
	15	66	1 7/8	34	3	AM7-WTU-1-1566	\$1,205
	15	60	1 7/8	31	3	AM7-WTU-1-1560	\$1,145
	15	54	1 7/8	28	2	AM7-WTU-1-1554	\$1,089
	15	48	1 7/8	25	2	AM7-WTU-1-1548	\$1,030
	15	42	1 7/8	22	2	AM7-WTU-1-1542	\$972
	15	36	1 7/8	19	2	AM7-WTU-1-1536	\$914
	15	30	1 7/8	15	1	AM7-WTU-1-1530	\$856

· long grain veneer direction

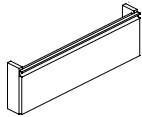
APOGEE™

Description	D	W	H	CTN WT	CU FT	① Model	List Price
Kneespace Access Panel, Partial Height	4	72	11 ½	33	4	AM7-PAS-1-0472	\$2,260
	4	60	11 ½	29	3	AM7-PAS-1-0460	\$2,012

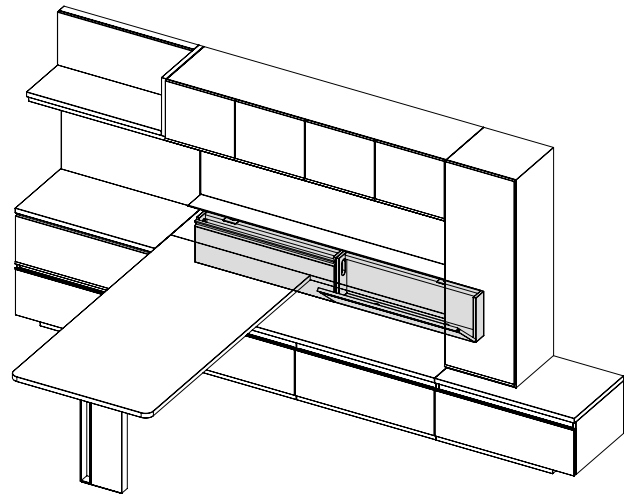


- use with one-high pedestals
- doors flip down for access to the wall
- internal wire pass thru
- cantilever bracket included
- recommended wall attachment
- access outlet 24" AFF (Above Finished Floor)

Kneespace Access Panel, Partial Height	4	36	11 ½	17	2	AM7-PAS-1-0436	\$1,516
	4	30	11 ½	15	2	AM7-PAS-1-0430	\$1,394
	4	18	11 ½	11	1	AM7-PAS-1-0418	\$1,269



- use with one-high pedestals
- door flips down for access to the wall
- recommended wall attachment
- access outlet 24" AFF (Above Finished Floor)



To Order, Specify:

Workwall Top

- ① Model Number
- ② Wood Species - Makore (MK2), Maple (MA2), Walnut (WA2), Black Oak (BO1) or Double Cut (DC1) [\(see page AP32\)](#)
- ③ Finish Color [\(see page AP32\)](#)

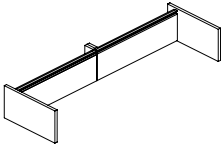
Access Panel

- ① Model Number
- ② Wood Species or Paint - Makore (MK2), Maple (MA2), Walnut (WA2), Black Oak (BO1) Double Cut (DC1) or Paint (PNT) [\(see page AP32\)](#)
- ③ Finish Color [\(see page AP32\)](#)

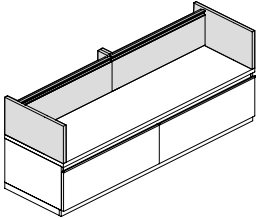
Note: Only one wood finish and one paint color can be specified per unit

Modular

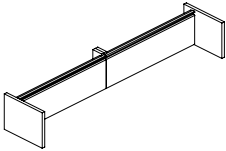
Description	D	W	H	CTN WT	CU FT	① Model	List Price
Kneespace Access Panel with 22"d Extensions, Partial Height	22	72	11 ½	48	15	AM7-PAS-EX-2272	\$3,023
	22	60	11 ½	43	15	AM7-PAS-EX-2260	\$2,778



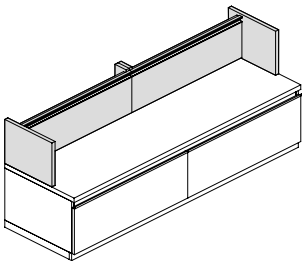
- use with 22"d worksurface top
- use with one-high pedestals with outside support units
- doors flip down for access to the wall
- wire pass thru to allow access to the next unit
- access outlet 24" AFF (Above Finished Floor)
- top mounting brackets included
- due to back construction unit is intended to sit against the wall for wall access



Kneespace Access Panel with 15"d Extensions, Partial Height	15	72	11 ½	41	11	AM7-PAS-ES-1572	\$2,950
	15	60	11 ½	36	9	AM7-PAS-ES-1560	\$2,702

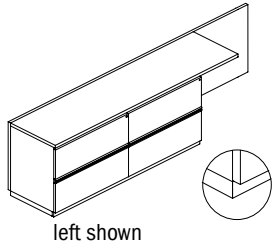


- use with 15"d worksurface top
- use with one-high pedestals with outside support units
- doors flip down for access to the wall
- wire pass thru to allow access to the next unit
- access outlet 24" AFF (Above Finished Floor)
- top mounting brackets included
- due to back construction unit is intended to sit against the wall for wall access



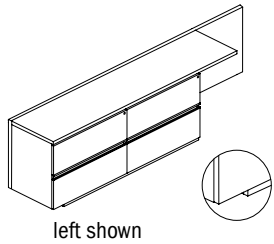
Modular

Description	D	W	H	CTN WT	CU FT	① Model	List Price
Two-High Run-Off Lateral File Credenza with Flush Base	23	90	29 ½	475	43	AM2-ROC-7-2390R	\$4,752
	23	90	29 ½	475	43	AM2-ROC-7-2390L	\$4,752



- use with 22" d workwall & kneespace access panel
- base is flush
- four 36" w lateral files
- pedestal front locking
- adjustable levelers/glides
- grommet available, specify and add \$114 list each; [see page AP21](#)
- kneespace height: 28 ¼"
- kneespace width: 18"

Two-High Run-Off Lateral File Credenza with Inset Base	23	90	29 ½	472	43	AM2-ROC-7R-2390R	\$4,752
	23	90	29 ½	472	43	AM2-ROC-7L-2390L	\$4,752



- use with 22" d workwall & kneespace access panel
- base is inset on one side
- four 36" w lateral files
- pedestal front locking
- adjustable levelers/glides
- grommet available, specify and add \$114 list each; [see page AP21](#)
- kneespace height: 28 ¼"
- kneespace width: 18"

To Order, Specify:

Access Panel

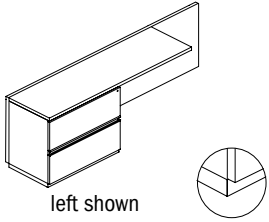
- ① Model Number
- ② Wood Species or Paint - Makore (MK2), Maple (MA2), Walnut (WA2), Black Oak (BO1), Double Cut (DC1) or Paint (PNT) ([see page AP32](#))
- ③ Finish Color ([see page AP32](#))

Credenza

- ① Model Number
- ② Wood Species on Top - Makore (MK2), Maple (MA2), Walnut (WA2), Black Oak (BO1) or Double Cut (DC1) ([see page AP32](#))
- ③ Finish Color for Top ([see page AP32](#))
- ④ Finish Color for Chassis/Drawer Fronts
 - a.) Same as Top
 - b.) Paint ([see page AP32](#))
- ⑤ Finish Color for Base
 - a.) Same as Top
 - b.) Same as Chassis/Drawer Fronts or Paint ([see page AP32](#))

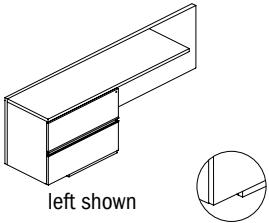
Note: Only one wood finish and one paint color can be specified per unit

Description	D	W	H	CTN WT	CU FT	① Model	List Price
Two-High Run-Off Lateral File Credenza with Flush Base	23	72	29½	299	35	AM2-ROC-7-2372R	\$4,319
	23	72	29½	299	35	AM2-ROC-7-2372L	\$4,319
	23	66	29½	261	32	AM2-ROC-7-2366R	\$4,259
	23	66	29½	261	32	AM2-ROC-7-2366L	\$4,259



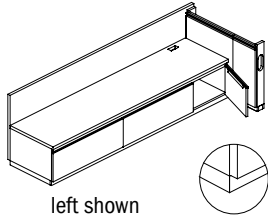
- use with 22"d workwall & kneespace access panel
- base is flush
- pedestal front locking
- adjustable levelers/glides
- grommet available, specify and add \$114 list each; [see page AP21](#)
- kneespace height: 28¼"
- kneespace width: 36"
- -2372 lateral files: 36"w
- -2366 lateral files: 30"w

Two-High Run-Off Lateral File Credenza with Inset Base	23	72	29½	295	35	AM2-ROC-7R-2372R	\$4,319
	23	72	29½	295	35	AM2-ROC-7L-2372L	\$4,319
	23	66	29½	258	32	AM2-ROC-7R-2366R	\$4,259
	23	66	29½	258	32	AM2-ROC-7L-2366L	\$4,259



- use with 22"d workwall & kneespace access panel
- base is inset on one side
- pedestal front locking
- adjustable levelers/glides
- grommet available, specify and add \$114 list each; [see page AP21](#)
- kneespace height: 28¼"
- kneespace width: 36"
- -2372 lateral files: 36"w
- -2366 lateral files: 30"w

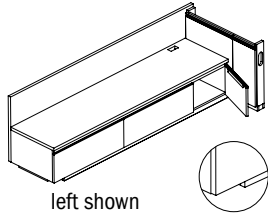
Description	D	W	H	CTN WT	CU FT	① Model	List Price No Cushion	List Price With Cushion
One-High Run-Off Credenza with Access Door and Flush Base	37	94	29 ½	466	67	AM2-ROC-8-3790R	\$6,659	COM \$6,964
	37	94	29 ½	466	67	AM2-ROC-8-3790L		A \$6,981 B \$7,015 COL/C \$7,077 D \$7,152 E \$7,229 F \$7,345 G \$7,472 H \$7,608 I \$7,820 J \$8,073 L1 \$7,565 L2 \$7,718



left shown

- base is flush
- two 36" w lateral files
- one hinged door
- pedestal front locking
- surface grommet
- wire pass thru hole to allow access to the next unit
- adjustable levelers/glides
- bench height: 16 7/8"
- optional 36" w cushion
- com: 1 ¼
- col sq ft: 22

One-High Run-Off Credenza with Access Door and Inset Base	37	94	29 ½	449	67	AM2-ROC-8R-3790R	\$6,659	COM \$6,964
	37	94	29 ½	449	67	AM2-ROC-8L-3790L		A \$6,981 B \$7,015 COL/C \$7,077 D \$7,152 E \$7,229 F \$7,345 G \$7,472 H \$7,608 I \$7,820 J \$8,073 L1 \$7,565 L2 \$7,718



left shown

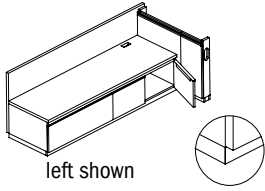
- base is inset on one side
- two 36" w lateral files
- one hinged door
- pedestal front locking
- surface grommet
- wire pass thru hole to allow access to the next unit
- adjustable levelers/glides
- bench height: 16 7/8"
- optional 36" w cushion
- com: 1 ¼
- col sq ft: 22

To Order, Specify:

- ① Model Number
- ② Wood Species on Top - Makore (MK2), Maple (MA2), Walnut (WA2), Black Oak (BO1) or Double Cut (DC1)
(see page AP32)
- ③ Finish Color for Top *(see page AP32)*
- ④ Finish Color for Chassis/Drawer/Door Fronts
 - a.) Same as Top
 - b.) Paint *(see page AP32)*
- ⑤ Finish Color for Base
 - a.) Same as Top
 - b.) Same as Chassis/Drawer/Door Fronts or Paint Color *(see page AP32)*
- ⑥ Fabric - vendor, pattern, color
Visit www.jsi.furniture.com/finishes-and-material/textiles for our textiles program. See selection of standard and graded in manufactures and patterns.

Note: Only one wood finish and one paint color can be specified per unit

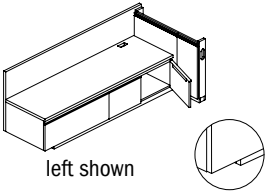
Description	D	W	H	CTN WT	CU FT	① Model	List Price No Cushion	List Price With Cushion
One-High Run-Off Credenza with Access Door and Flush Base	37	76	29½	389	54	AM2-ROC-8-3772R	\$5,786	COM \$6,091
	37	76	29½	389	54	AM2-ROC-8-3772L		A \$6,108 B \$6,140 COL/C \$6,203 D \$6,280 E \$6,355 F \$6,472 G \$6,599 H \$6,735 I \$6,946 J \$7,200 L1 \$6,693 L2 \$6,845



left shown

- base is flush
- one 36" w lateral file
- one 18" w file drawer
- one 18" w hinged door
- pedestal front locking
- surface grommet
- wire pass thru hole to allow access to the next unit
- adjustable levelers/glides
- bench height: 16 7/8"
- optional 36" w cushion
- com ydg: 1 1/4
- col sq ft: 22

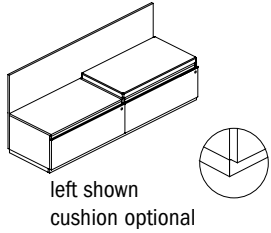
One-High Run-Off Credenza with Access Door and Inset Base	37	76	29½	373	54	AM2-ROC-8R-3772R	\$5,786	COM \$6,091
	37	76	29½	373	54	AM2-ROC-8L-3772L		A \$6,108 B \$6,140 COL/C \$6,203 D \$6,280 E \$6,355 F \$6,472 G \$6,599 H \$6,735 I \$6,946 J \$7,200 L1 \$6,693 L2 \$6,845



left shown

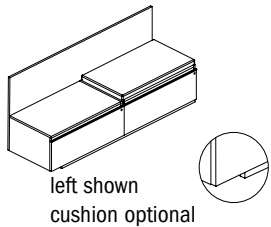
- inset base one side
- one 36" w lateral file
- one 18" w file drawer
- one 18" w hinged door
- pedestal front locking
- surface grommet
- wire pass thru hole to allow access to the next unit
- adjustable levelers/glides
- bench height: 16 7/8"
- optional 36" w cushion
- com ydg: 1 1/4
- col sq ft: 22

Description	D	W	H	CTN WT	CU FT	① Model	List Price No Cushion	List Price With Cushion
One-High Run-Off Credenza with Flush Base	23 ¼	72	29 ½	326	35	AP6-STC-1-2272R	\$4,913	COM \$5,218
	23 ¼	72	29 ½	326	35	AP6-STC-1-2272L		A \$5,237 B \$5,271 COL/C \$5,328 D \$5,404 E \$5,481 F \$5,600 G \$5,726 H \$5,863 I \$6,073 J \$6,328 L1 \$5,819 L2 \$5,974



- base is flush
- 36" w lateral files
- pedestal front locking
- adjustable levelers/glides
- bench height: 16 7/8"
- optional 36" w cushion
- com ydg: 1 ¼
- col sq ft: 22

One-High Run-Off Credenza with Inset Base	23 ¼	72	29 ½	323	35	AP6-STC-1R-2272R	\$4,913	COM \$5,218
	23 ¼	72	29 ½	323	35	AP6-STC-1L-2272L		A \$5,237 B \$5,271 COL/C \$5,328 D \$5,404 E \$5,481 F \$5,600 G \$5,726 H \$5,863 I \$6,073 J \$6,328 L1 \$5,819 L2 \$5,974



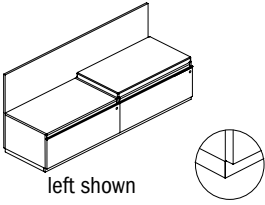
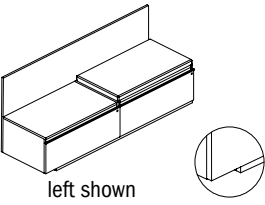
- base is inset on one side
- 36" w lateral files
- pedestal front locking
- adjustable levelers/glides
- bench height: 16 7/8"
- optional 36" w cushion
- com ydg: 1 ¼
- col sq ft: 22

To Order, Specify:

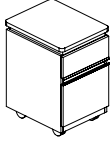
- ① Model Number
- ② Wood Species on Top - Makore (MK2), Maple (MA2), Walnut (WA2), Black Oak (BO1) or Double Cut (DC1) (see page AP32)
- ③ Finish Color for Top (see page AP32)
- ④ Finish Color for Chassis/Drawer/Door Fronts
 - a.) Same as Top
 - b.) Paint (see page AP32)
- ⑤ Finish Color for Base
 - a.) Same as Top
 - b.) Same as Chassis/Drawer/Door Fronts or Paint Color (see page AP32)
- ⑥ Fabric - vendor, pattern, color

Note: Only one wood finish and one paint color can be specified per unit

Visit www.jsi.furniture.com/finishes-and-material/textiles for our textiles program. See selection of standard and graded in manufactures and patterns.

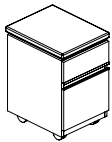
Description	D	W	H	CTN WT	CU FT	① Model	List Price No Cushion	List Price With Cushion
One-High Run-Off Credenza with Flush Base	23 ¼	60	29 ½	274	29	AP6-STC-1-2260R	\$4,769	COM \$5,073
	23 ¼	60	29 ½	274	29	AP6-STC-1-2260L		A \$5,092 B \$5,123 COL/C \$5,184 D \$5,259 E \$5,336 F \$5,456 G \$5,583 H \$5,717 I \$5,929 J \$6,182 L1 \$5,673 L2 \$5,829
 <p>left shown cushion optional</p> <ul style="list-style-type: none"> · base is flush · 30" w lateral files · pedestal front locking · adjustable levelers/glides · bench height: 16 7/8" · optional 30" w cushion · com ydg: 1 ¼ · col sq ft: 22 								
One-High Run-Off Credenza with Inset Base	23 ¼	60	29 ½	271	29	AP6-STC-1R-2260R	\$4,769	COM \$5,073
	23 ¼	60	29 ½	271	29	AP6-STC-1L-2260L		A \$5,092 B \$5,123 COL/C \$5,184 D \$5,259 E \$5,336 F \$5,456 G \$5,583 H \$5,717 I \$5,929 J \$6,182 L1 \$5,673 L2 \$5,829
 <p>left shown cushion optional</p> <ul style="list-style-type: none"> · base is inset on one side · 30" w lateral files · pedestal front locking · adjustable levelers/glides · bench height: 16 7/8" · optional 30" w cushion · com ydg: 1 ¼ · col sq ft: 22 								

Description	D	W	H	CTN WT	CU FT	① Model	List Price
Utility/File Mobile Pedestal	22	16	27 7/8	95	7	AP6-MBP-1-2216	\$1,872



- utility drawer with box drawer front
- soft close drawers
- pedestal front locking

Description	D	W	H	CTN WT	CU FT	① Model	List Price Per Grade
Utility/File Mobile Pedestal with Cushion Top	22	16	27 7/8	95	7	AP6-MBP-C-2216	COM \$1,901



- utility drawer with box drawer front
- soft close drawers
- pedestal front locking
- cushion top
- com ydg: 1
- col sq ft: 15

- A \$1,913
- B \$1,939
- COL/C \$1,988
- D \$2,052
- E \$2,110
- F \$2,205
- G \$2,306
- H \$2,414
- I \$2,586
- J \$2,787
- L1 \$2,381
- L2 \$2,504

To Order, Specify:

Credenza

- ① Model Number
- ② Wood Species on Top - Makore (MK2), Maple (MA2), Walnut (WA2), Black Oak (BO1) or Double Cut (DC1) (see page AP32)
- ③ Finish Color for Top (see page AP32)
- ④ Finish Color for Chassis/Drawer Fronts
 - a.) Same as Top
 - b.) Paint (see page AP32)
- ⑤ Finish Color for Base
 - a.) Same as Top
 - b.) Same as Chassis/Drawer Fronts or Paint Color (see page AP32)
- ⑥ Fabric - vendor, pattern, color
Visit www.jsi.furniture.com/finishes-and-material/textiles for our textiles program. See selection of standard and graded in manufactures and patterns.

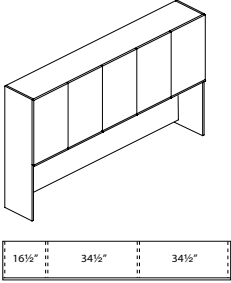
Mobile Pedestal

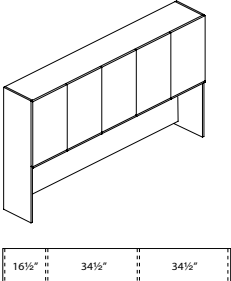
- ① Model Number
- ② Wood Species on Top - Makore (MK2), Maple (MA2), Walnut (WA2), Black Oak (BO1) or Double Cut (DC1) (see page AP32)
 - a.) Finish Color for Top, (see page AP32)
- ③ Finish Color for Chassis/Drawer Fronts
 - a.) Same as Top
 - b.) Paint (see page AP32)

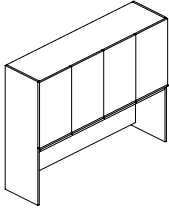
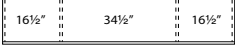
Mobile Pedestal with Cushion Top

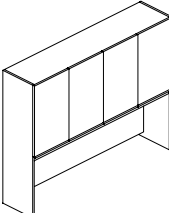
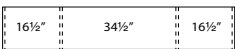
- ① Model Number
- ② Cushion
 1. Fabric - vendor, pattern, color
Visit www.jsi.furniture.com/finishes-and-material/textiles for our textiles program. See selection of standard and graded in manufactures and patterns.
- ③ Chassis/Drawer Front Species - Makore (MK2), Maple (MA2), Walnut (WA2), Black Oak (BO1), Double Cut (DC1) or Paint (PNT) (see page AP32)
- ④ Finish Color for Chassis/Drawer Fronts (see page AP32)

Note: Only one wood finish and one paint color can be specified per unit

Description	D	W	H	CTN WT	CU FT	① Model	List Price	
18" d Double Height Storage Overhead Cabinet with 5 Doors	18	90	56	383	63	AP4-BOT-1D-1890R	VENEER PANEL \$7,276	
	18	90	56	383	63	AP4-BOT-1D-1890L	PAINT PANEL \$7,276	
 <p>left shown</p>	<ul style="list-style-type: none"> chassis and doors available in veneer or paint or veneer/paint combination required insert panel available in veneer, paint, magnetic back painted white glass or fabric, indicate selection on order and select appropriate list price aluminum mini shelf available, specify and add \$1,137 list glass insert panel has a thin aluminum frame pack of 6 magnets come with magnetic glass option task lights available, see accessories price list 1 1/2" wire access bottom across the bottom of back panel legal depth soft close hinge doors adjustable shelves aluminum valance rail finished, flush back panel fabric is railroaded locking doors available, specify and add \$426 list compartment height: 28 1/2" compartment depth: 16 1/2" worksurface to valance rail: 24 1/2" com ydg: 2 3/4" 						FABRIC PANEL	
							COM	\$8,196
							A	\$8,233
							B	\$8,308
							C	\$8,438
							D	\$8,605
							E	\$8,774
							F	\$9,036
							G	\$9,314
							H	\$9,612
						I	\$10,077	
						J	\$10,634	

15" d Double Height Storage Overhead Cabinet with 5 Doors	15	90	56	355	53	AP4-BOT-1-1590R	VENEER PANEL \$7,130	
	15	90	56	355	53	AP4-BOT-1-1590L	PAINT PANEL \$7,130	
 <p>left shown</p>	<ul style="list-style-type: none"> chassis and doors available in veneer or paint or veneer/paint combination required insert panel available in veneer, paint, magnetic back painted white glass or fabric, indicate selection on order and select appropriate list price aluminum mini shelf available, specify and add \$1,137 list glass insert panel has a thin aluminum frame pack of 6 magnets come with magnetic glass option task lights available, see accessories price list 1 1/2" wire access bottom across the bottom of back panel letter depth soft close hinge doors adjustable shelves aluminum valance rail finished, flush back panel fabric is railroaded locking doors available, specify and add \$426 list compartment height: 28 1/2" compartment depth: 13 1/2" worksurface to valance rail: 24 1/2" com ydg: 2 3/4" 						FABRIC PANEL	
							COM	\$8,051
							A	\$8,089
							B	\$8,163
							C	\$8,293
							D	\$8,462
							E	\$8,627
							F	\$8,890
							G	\$9,169
							H	\$9,465
						I	\$9,931	
						J	\$10,489	

Description	D	W	H	CTN WT	CU FT	① Model	List Price
18"d Double Height Storage Overhead Cabinet with 4 Doors  	18	72	56	321	51	AP4-BOT-1D-1872	VENEER PANEL \$6,433 PAINT PANEL \$6,433 GLASS PANEL \$8,706 FABRIC PANEL COM \$7,143 A \$7,173 B \$7,235 C \$7,342 D \$7,477 E \$7,614 F \$7,828 G \$8,057 H \$8,300 I \$8,681 J \$9,135
<ul style="list-style-type: none"> chassis and doors available in veneer or paint or veneer/paint combination required insert panel available in veneer, paint, magnetic back painted white glass or fabric, indicate selection on order and select appropriate list price aluminum mini shelf available, specify and add \$1,089 list glass insert panel has a thin aluminum frame pack of 6 magnets come with magnetic glass option task lights available, see accessories price list 1 1/2" wire access bottom across the bottom of back panel legal depth soft close hinge doors adjustable shelves aluminum valance rail finished, flush back panel fabric is railroaded locking doors available, specify and add \$426 list compartment height: 28 1/2" compartment depth: 16 1/2" worksurface to valance rail: 24 1/2" com ydg: 2 1/4" 							

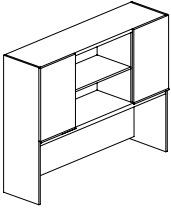

15"d Double Height Storage Overhead Cabinet with 4 Doors  	15	72	56	297	43	AP4-BOT-1-1572	VENEER PANEL \$6,288 PAINT PANEL \$6,288 GLASS PANEL \$8,559 FABRIC PANEL COM \$6,997 A \$7,029 B \$7,088 C \$7,197 D \$7,332 E \$7,470 F \$7,682 G \$7,911 H \$8,156 I \$8,537 J \$8,992
<ul style="list-style-type: none"> chassis and doors available in veneer or paint or veneer/paint combination required insert panel available in veneer, paint, magnetic back painted white glass or fabric, indicate selection on order and select appropriate list price aluminum mini shelf available, specify and add \$1,089 list glass insert panel has a thin aluminum frame pack of 6 magnets come with magnetic glass option task lights available, see accessories price list 1 1/2" wire access bottom across the bottom of back panel letter depth soft close hinge doors adjustable shelves aluminum valance rail finished, flush back panel fabric is railroaded locking doors available, specify and add \$426 list compartment height: 28 1/2" compartment depth: 13 1/2" worksurface to valance rail: 24 1/2" com ydg: 2 1/4" 							

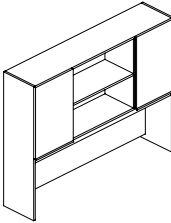
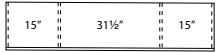
To Order, Specify:

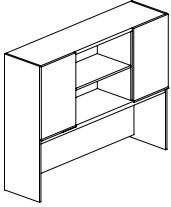
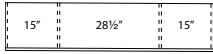
- ① Model Number
- ② Finish Application
 - a.) All Veneer
 - 1.) Wood Species - Makore (MK2), Maple (MA2), Walnut (WA2), Black Oak (BO1) or Double Cut (DC1) ([see page AP32](#))
 - a.) Finish Color ([see page AP32](#))
 - b.) All Paint (PNT)
 - 1.) Paint Color ([see page AP32](#))
 - c.) Veneer/Paint Combination
 - 1.) Chassis Wood Species/Paint - Makore (MK2), Maple (MA2), Walnut (WA2), Double Cut (DC1) or Paint (PNT) ([see page AP32](#))
 - a.) Finish Color for Chassis ([see page AP32](#))
 - 2.) Door Wood Species/Paint - Makore (MK2), Maple (MA2), Walnut (WA2), Double Cut (DC1) or Paint (PNT) ([see page AP32](#))
 - a.) Finish Color for Door ([see page AP32](#))
 - ③ Insert Panel
 - a.) Veneer
 - 1.) Wood Species - Makore (MK2), Maple (MA2), Walnut (WA2), Black Oak (BO1) or Double Cut (DC1) ([see page AP32](#))
 - A. Finish Color ([see page AP32](#))
 - b.) Paint (PNT)
 - 1.) Paint Color ([see page AP32](#))
 - c.) Back Painted Magnetic Glass
 - d.) Fabric - vendor, pattern, color

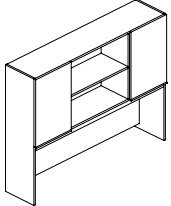
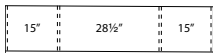
Visit www.jsi.furniture.com/finishes-and-material/textiles for our textiles program. See selection of standard and graded in manufactures and patterns.

Note: Only one wood finish and one paint color can be specified per unit

Description	D	W	H	CTN WT	CU FT	① Model	List Price	
18"d Double Height Storage Overhead Cabinet with 2 Doors and Open Center Shelf  	18	66	56	279	46	AP4-BOT-4D-1866	VENEER PANEL \$5,459	
								PAINT PANEL \$5,459
								GLASS PANEL \$7,428
								FABRIC PANEL
								COM \$6,152
								A \$6,178
								B \$6,232
								C \$6,328
								D \$6,450
								E \$6,571
								F \$6,760
								G \$6,964
								H \$7,180
							I \$7,519	
							J \$7,926	
<ul style="list-style-type: none"> · chassis and doors available in veneer or paint or veneer/paint combination · required insert panel available in veneer, paint, magnetic back painted white glass or fabric, indicate selection on order and select appropriate list price · aluminum mini shelf available, specify and add \$1,038 · glass insert panel has a thin aluminum frame · pack of 6 magnets come with magnetic glass option · task lights available, see accessories price list · 1 1/2" wire access bottom across the bottom of back panel · legal depth · soft close hinge doors · adjustable shelves · aluminum valance rail · finished, flush back panel · fabric is railroaded · locking doors available, specify and add \$284 list · compartment height: 28 1/2" · compartment depth: 16 1/2" · worksurface to valance rail: 24 1/2" · com ydg: 2 								

15"d Double Height Storage Overhead Cabinet with 2 Doors and Open Center Shelf  	15	66	56	256	39	AP4-BOT-4-1566	VENEER PANEL \$5,314	
								PAINT PANEL \$5,314
								GLASS PANEL \$7,282
								FABRIC PANEL
								COM \$6,005
								A \$6,033
								B \$6,088
								C \$6,182
								D \$6,303
								E \$6,426
								F \$6,616
								G \$6,819
								H \$7,035
							I \$7,373	
							J \$7,781	
<ul style="list-style-type: none"> · chassis and doors available in veneer or paint or veneer/paint combination · required insert panel available in veneer, paint, magnetic back painted white glass or fabric, indicate selection on order and select appropriate list price · aluminum mini shelf available, specify and add \$1,038 · glass insert panel has a thin aluminum frame · pack of 6 magnets come with magnetic glass option · task lights available, see accessories price list · 1 1/2" wire access bottom across the bottom of back panel · letter depth · soft close hinge doors · adjustable shelves · aluminum valance rail · finished, flush back panel · fabric is railroaded · locking doors available, specify and add \$284 list · compartment height: 28 1/2" · compartment depth: 13 1/2" · worksurface to valance rail: 24 1/2" · com ydg: 2 								

Description	D	W	H	CTN WT	CU FT	① Model	List Price
18"d Double Height Storage Overhead Cabinet with 2 Doors and Open Center Shelf  	18	60	56	261	42	AP4-BOT-4D-1860	VENEER PANEL \$5,278 PAINT PANEL \$5,278 GLASS PANEL \$6,946 FABRIC PANEL COM \$5,951 A \$5,979 B \$6,033 C \$6,129 D \$6,250 E \$6,370 F \$6,562 G \$6,765 H \$6,981 I \$7,321 J \$7,726
<ul style="list-style-type: none"> chassis and doors available in veneer or paint or veneer/paint combination required insert panel available in veneer, paint, magnetic back painted white glass or fabric, indicate selection on order and select appropriate list price aluminum mini shelf available, specify and add \$980 list glass insert panel has a thin aluminum frame pack of 6 magnets come with magnetic glass option task lights available, see accessories price list 1 1/2" wire access bottom across the bottom of back panel legal depth soft close hinge doors adjustable shelves aluminum valance rail finished, flush back panel fabric is railroaded locking doors available, specify and add \$284 list compartment height: 28 1/2" compartment depth: 16 1/2" worksurface to valance rail: 24 1/2" com ydg: 2 							

15"d Double Height Storage Overhead Cabinet with 2 Doors and Open Center Shelf  	15	60	56	239	36	AP4-BOT-4-1560	VENEER PANEL \$5,134 PAINT PANEL \$5,134 GLASS PANEL \$6,800 FABRIC PANEL COM \$5,806 A \$5,834 B \$5,888 C \$5,983 D \$6,105 E \$6,224 F \$6,416 G \$6,619 H \$6,835 I \$7,173 J \$7,581
<ul style="list-style-type: none"> chassis and doors available in veneer or paint or veneer/paint combination required insert panel available in veneer, paint, magnetic back painted white glass or fabric, indicate selection on order and select appropriate list price aluminum mini shelf available, specify and add \$980 list glass insert panel has a thin aluminum frame pack of 6 magnets come with magnetic glass option task lights available, see accessories price list 1 1/2" wire access bottom across the bottom of back panel letter depth soft close hinge doors adjustable shelves aluminum valance rail finished, flush back panel fabric is railroaded locking doors available, specify and add \$284 list compartment height: 28 1/2" compartment depth: 13 1/2" worksurface to valance rail: 24 1/2" com ydg: 2 							

To Order, Specify:

① Model Number

② Finish Application

a.) All Veneer

- 1.) Wood Species - Makore (MK2), Maple (MA2), Walnut (WA2), Black Oak (BO1) or Double Cut (DC1) ([see page AP32](#))

a.) Finish Color ([see page AP32](#))

b.) All Paint (PNT)

- 1.) Paint Color ([see page AP32](#))

c.) Veneer/Paint Combination

- 1.) Chassis Wood Species/Paint - Makore (MK2), Maple (MA2), Walnut (WA2), Double Cut (DC1) or Paint (PNT) ([see page AP32](#))

a.) Finish Color for Chassis ([see page AP32](#))

- 2.) Door Wood Species/Paint - Makore (MK2), Maple (MA2), Walnut (WA2), Double Cut (DC1) or Paint (PNT) ([see page AP32](#))

a.) Finish Color for Door ([see page AP32](#))

③ Insert Panel

a.) Veneer

- 1.) Wood Species - Makore (MK2), Maple (MA2), Walnut (WA2), Black Oak (BO1) or Double Cut (DC1) ([see page AP32](#))

a.) Finish Color ([see page AP32](#))

b.) Paint (PNT)

- 1.) Paint Color ([see page AP32](#))

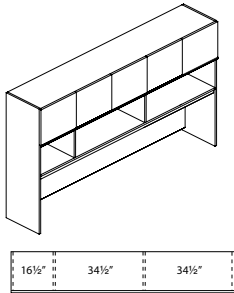
c.) Back Painted Magnetic Glass

d.) Fabric - vendor, pattern, color

Visit www.jsi.furniture.com/finishes-and-material/textiles for our textiles program. See selection of standard and graded in manufactures and patterns.

Note: Only one wood finish and one paint color can be specified per unit

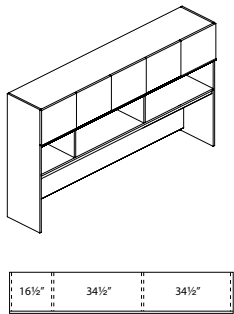
Description	D	W	H	CTN WT	CU FT	① Model	List Price
18" d Double Height Storage Overhead Cabinet with 5 Doors and Open Storage	18	90	56	357	63	AP4-BOT-SD-1890R	VENEER PANEL \$6,912
	18	90	56	357	63	AP4-BOT-SD-1890L	PAINT PANEL \$6,912
							GLASS PANEL \$9,614
							FABRIC PANEL
							COM \$7,831
							A \$7,870
							B \$7,943
							C \$8,074
							D \$8,243
							E \$8,409
							F \$8,671
							G \$8,950
							H \$9,246
							I \$9,712
							J \$10,271



left shown

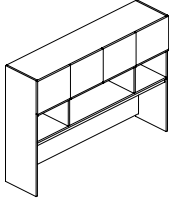

- chassis and doors available in veneer or paint or veneer/paint combination
- required insert panel available in veneer, paint, magnetic back painted white glass or fabric, indicate selection on order and select appropriate list price
- aluminum mini shelf available, specify and add \$1,137 list
- glass insert panel has a thin aluminum frame
- pack of 6 magnets come with magnetic glass option
- task lights available, see [accessories price list](#)
- 1 1/2" wire access bottom across the bottom of back panel
- legal depth
- soft close hinge doors
- adjustable shelves
- aluminum valance rail
- finished, flush back panel
- fabric is railroaded
- locking doors available, specify and add \$426 list
- small outside closed binder section: 16 1/2" w x 16 1/2" d x 14 1/4" h
- large closed binder section: 34 1/2" w x 16 1/2" d x 14 1/4" h
- small outside open binder section: 16 1/2" w x 16 1/2" d x 14 1/4" h
- large open binder section: 34 1/2" w x 16 1/2" d x 14 1/4" h
- worksurface to valance rail: 24 1/2"
- com ydg: 2 3/4

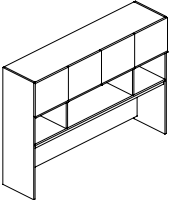
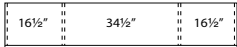
15" d Double Height Storage Overhead Cabinet with 5 Doors and Open Storage	15	90	56	329	53	AP4-BOT-S-1590R	VENEER PANEL \$6,769
	15	90	56	329	53	AP4-BOT-S-1590L	PAINT PANEL \$6,769
							GLASS PANEL \$9,468
							FABRIC PANEL
							COM \$7,686
							A \$7,724
							B \$7,796
							C \$7,930
							D \$8,097
							E \$8,263
							F \$8,524
							G \$8,806
							H \$9,102
							I \$9,567
							J \$10,125



left shown

- chassis and doors available in veneer or paint or veneer/paint combination
- required insert panel available in veneer, paint, magnetic back painted white glass or fabric, indicate selection on order and select appropriate list price
- aluminum mini shelf available, specify and add \$1,137 list
- glass insert panel has a thin aluminum frame
- pack of 6 magnets come with magnetic glass option
- task lights available, see [accessories price list](#)
- 1 1/2" wire access bottom across the bottom of back panel
- letter depth
- soft close hinge doors
- adjustable shelves
- aluminum valance rail
- finished, flush back panel
- fabric is railroaded
- locking doors available, specify and add \$426 list
- small outside closed binder section: 16 1/2" w x 13 1/2" d x 14 1/4" h
- large closed binder section: 34 1/2" w x 13 1/2" d x 14 1/4" h
- small outside open binder section: 16 1/2" w x 13 1/2" d x 14 1/4" h
- large open binder section: 34 1/2" w x 13 1/2" d x 14 1/4" h
- worksurface to valance rail: 24 1/2"
- com ydg: 2 3/4

Description	D	W	H	CTN WT	CU FT	① Model	List Price
18"d Double Height Storage Overhead Cabinet with 4 Doors and Open Storage  	18	72	56	300	51	AP4-BOT-SD-1872	VENEER PANEL \$6,070 PAINT PANEL \$6,070 GLASS PANEL \$8,340 FABRIC PANEL COM \$6,778 A \$6,811 B \$6,871 C \$6,979 D \$7,117 E \$7,251 F \$7,466 G \$7,694 H \$7,936 I \$8,317 J \$8,776
	<ul style="list-style-type: none"> chassis and doors available in veneer or paint or veneer/paint combination required insert panel available in veneer, paint, magnetic back painted white glass or fabric, indicate selection on order and select appropriate list price aluminum mini shelf available, specify and add \$1,089 list glass insert panel has a thin aluminum frame pack of 6 magnets come with magnetic glass option task lights available, see accessories price list 1 1/2" wire access bottom across the bottom of back panel legal depth soft close hinge doors adjustable shelves aluminum valance rail finished, flush back panel fabric is railroaded locking doors available, specify and add \$426 list small outside closed binder section: 16 1/2"w x 16 1/2"d x 14 1/4"h large closed binder section: 34 1/2"w x 16 1/2"d x 14 1/4"h small outside open binder section: 16 1/2"w x 16 1/2"d x 14 1/4"h large open binder section: 34 1/2"w x 16 1/2"d x 14 1/4"h worksurface to valance rail: 24 1/2" com ydg: 2 1/4 						

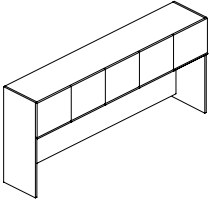
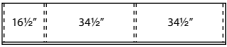
15"d Double Height Storage Overhead Cabinet with 4 Doors and Open Storage  	15	72	56	275	43	AP4-BOT-S-1572	VENEER PANEL \$5,924 PAINT PANEL \$5,924 GLASS PANEL \$8,196 FABRIC PANEL COM \$6,634 A \$6,665 B \$6,726 C \$6,833 D \$6,970 E \$7,106 F \$7,321 G \$7,548 H \$7,790 I \$8,170 J \$8,628
	<ul style="list-style-type: none"> chassis and doors available in veneer or paint or veneer/paint combination required insert panel available in veneer, paint, magnetic back painted white glass or fabric, indicate selection on order and select appropriate list price aluminum mini shelf available, specify and add \$1,089 list glass insert panel has a thin aluminum frame pack of 6 magnets come with magnetic glass option task lights available, see accessories price list 1 1/2" wire access bottom across the bottom of back panel letter depth soft close hinge doors adjustable shelves aluminum valance rail finished, flush back panel fabric is railroaded locking doors available, specify and add \$426 list small outside closed binder section: 16 1/2"w x 13 1/2"d x 14 1/4"h large closed binder section: 34 1/2"w x 13 1/2"d x 14 1/4"h small outside open binder section: 16 1/2"w x 13 1/2"d x 14 1/4"h large open binder section: 34 1/2"w x 13 1/2"d x 14 1/4"h worksurface to valance rail: 24 1/2" com ydg: 2 1/4 						

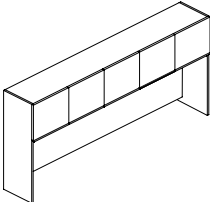
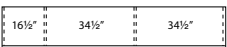
To Order, Specify:

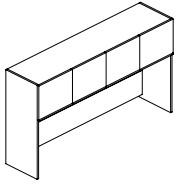
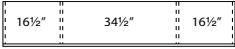
- ① Model Number
- ② Finish Application
 - a.) All Veneer
 - 1.) Wood Species - Makore (MK2), Maple (MA2), Walnut (WA2), Black Oak (BO1) or Double Cut (DC1) ([see page AP32](#))
 - a.) Finish Color ([see page AP32](#))
 - b.) All Paint (PNT)
 - 1.) Paint Color ([see page AP32](#))
- c.) Veneer/Paint Combination
 - 1.) Chassis Wood Species/Paint - Makore (MK2), Maple (MA2), Walnut (WA2), Black Oak (BO1), Double Cut (DC1) or Paint (PNT) ([see page AP32](#))
 - a.) Finish Color for Chassis ([see page AP32](#))
 - 2.) Door Wood Species/Paint - Makore (MK2), Maple (MA2), Walnut (WA2), Double Cut (DC1) or Paint (PNT) ([see page AP32](#))
 - a.) Finish Color for Door ([see page AP32](#))
- ③ Insert Panel
 - a.) Veneer
 - 1.) Wood Species - Makore (MK2), Maple (MA2), Walnut (WA2), Black Oak (BO1) or Double Cut (DC1) ([see page AP32](#))
 - a.) Finish Color ([see page AP32](#))
 - b.) Paint (PNT)
 - 1.) Paint Color ([see page AP32](#))
 - c.) Back Painted Magnetic Glass
 - d.) Fabric - vendor, pattern, color

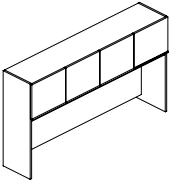
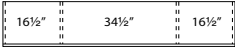
Visit www.jsi.furniture.com/finishes-and-material/textiles for our textiles program. See selection of standard and graded in manufactures and patterns.

Note: Only one wood finish and one paint color can be specified per unit **Apogee™ AP77**

Description	D	W	H	CTN WT	CU FT	① Model	List Price
18" d Storage Overhead Cabinet with 5 Doors	18	90	41	267	47	AP4-BOS-1D-1890R	VENEER PANEL \$6,623
	18	90	41	267	47	AP4-BOS-1D-1890L	PAINT PANEL \$6,623
  left shown	<ul style="list-style-type: none"> chassis and doors available in veneer or paint or veneer/paint combination required insert panel available in veneer, paint, magnetic back painted white glass or fabric, indicate selection on order and select appropriate list price aluminum mini shelf available, specify and add \$1,137 list glass insert panel has a thin aluminum frame pack of 6 magnets come with magnetic glass option task lights available, see accessories price list 1 1/2" wire access bottom across the bottom of back panel legal depth soft close hinge doors adjustable shelves aluminum valance rail finished, flush back panel fabric is railroaded locking doors available, specify and add \$426 list compartment height: 13 1/2" compartment depth: 16 1/2" worksurface to valance rail: 24 1/2" com ydg: 2 3/4" 						GLASS PANEL \$9,323
							FABRIC PANEL
							COM \$7,542
							A \$7,580
							B \$7,652
							C \$7,784
							D \$7,952
							E \$8,118
							F \$8,380
							G \$8,661
						H \$8,955	
						I \$9,420	
						J \$9,980	

15" d Storage Overhead Cabinet with 5 Doors	15	90	41	249	40	AP4-BOS-1-1590R	VENEER PANEL \$6,476
	15	90	41	249	40	AP4-BOS-1-1590L	PAINT PANEL \$6,476
  left shown	<ul style="list-style-type: none"> chassis and doors available in veneer or paint or veneer/paint combination required insert panel available in veneer, paint, magnetic back painted white glass or fabric, indicate selection on order and select appropriate list price aluminum mini shelf available, specify and add \$1,137 list glass insert panel has a thin aluminum frame pack of 6 magnets come with magnetic glass option task lights available, see accessories price list 1 1/2" wire access bottom across the bottom of back panel letter depth soft close hinge doors adjustable shelves aluminum valance rail finished, flush back panel fabric is railroaded locking doors available, specify and add \$426 list compartment height: 13 1/2" compartment depth: 16 1/2" worksurface to valance rail: 24 1/2" com ydg: 2 3/4" 						GLASS PANEL \$9,177
							FABRIC PANEL
							COM \$7,397
							A \$7,433
							B \$7,507
							C \$7,639
							D \$7,806
							E \$7,974
							F \$8,234
							G \$8,514
						H \$8,811	
						I \$9,276	
						J \$9,832	

Description	D	W	H	CTN WT	CU FT	① Model	List Price
18"d Storage Overhead Cabinet with 4 Doors  	18	72	41	223	38	AP4-BOS-1D-1872	VENEER PANEL \$5,487 PAINT PANEL \$5,487 GLASS PANEL \$7,758 FABRIC PANEL COM \$6,198 A \$6,228 B \$6,290 C \$6,396 D \$6,533 E \$6,671 F \$6,884 G \$7,113 H \$7,355 I \$7,736 J \$8,194
<ul style="list-style-type: none"> chassis and doors available in veneer or paint or veneer/paint combination required insert panel available in veneer, paint, magnetic back painted white glass or fabric, indicate selection on order and select appropriate list price aluminum mini shelf available, specify and add \$1,089 list glass insert panel has a thin aluminum frame pack of 6 magnets come with magnetic glass option task lights available, see accessories price list 1 1/2" wire access bottom across the bottom of back panel legal depth soft close hinge doors adjustable shelves aluminum valance rail finished, flush back panel fabric is railroaded locking doors available, specify and add \$426 list compartment height: 13 1/2" compartment depth: 16 1/2" worksurface to valance rail: 24 1/2" com ydg: 2 1/4 							

15"d Storage Overhead Cabinet with 4 Doors  	15	72	41	207	32	AP4-BOS-1-1572	VENEER PANEL \$5,342 PAINT PANEL \$5,342 GLASS PANEL \$7,613 FABRIC PANEL COM \$6,051 A \$6,084 B \$6,142 C \$6,251 D \$6,389 E \$6,527 F \$6,738 G \$6,967 H \$7,210 I \$7,591 J \$8,049
<ul style="list-style-type: none"> chassis and doors available in veneer or paint or veneer/paint combination required insert panel available in veneer, paint, magnetic back painted white glass or fabric, indicate selection on order and select appropriate list price aluminum mini shelf available, specify and add \$1,089 list glass insert panel has a thin aluminum frame pack of 6 magnets come with magnetic glass option task lights available, see accessories price list 1 1/2" wire access bottom across the bottom of back panel letter depth soft close hinge doors adjustable shelves aluminum valance rail finished, flush back panel fabric is railroaded locking doors available, specify and add \$426 list compartment height: 13 1/2" compartment depth: 13 1/2" worksurface to valance rail: 24 1/2" com ydg: 2 1/4 							

To Order, Specify:

① Model Number

② Finish Application

a.) All Veneer

- 1.) Wood Species - Makore (MK2), Maple (MA2), Walnut (WA2), Black Oak (BO1) or Double Cut (DC1) ([see page AP32](#))

a.) Finish Color ([see page AP32](#))

b.) All Paint (PNT)

- 1.) Paint Color ([see page AP32](#))

c.) Veneer/Paint Combination

- 1.) Chassis Wood Species/Paint - Makore (MK2), Maple (MA2), Walnut (WA2), Black Oak (BO1), Double Cut (DC1) or Paint (PNT) ([see page AP32](#))

a.) Finish Color for Chassis ([see page AP32](#))

- 2.) Door Wood Species/Paint - Makore (MK2), Maple (MA2), Walnut (WA2), Double Cut (DC1) or Paint (PNT) ([see page AP32](#))

a.) Finish Color for Door ([see page AP32](#))

③ Insert Panel

a.) Veneer

- 1.) Wood Species - Makore (MK2), Maple (MA2), Walnut (WA2), Black Oak (BO1) or Double Cut (DC1) ([see page AP32](#))

a.) Finish Color ([see page AP32](#))

b.) Paint (PNT)

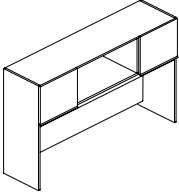
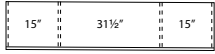
- 1.) Paint Color ([see page AP32](#))

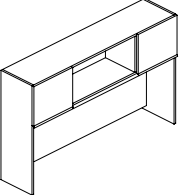
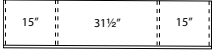
c.) Back Painted Magnetic Glass

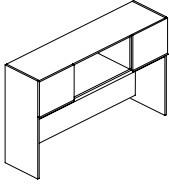
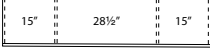
d.) Fabric - vendor, pattern, color

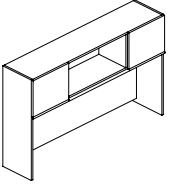
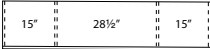
Visit www.jsi.furniture.com/finishes-and-material/textiles for our textiles program. See selection of standard and graded in manufactures and patterns.

Note: Only one wood finish and one paint color can be specified per unit

Description	D	W	H	CTN WT	CU FT	① Model	List Price
18" d Storage Overhead Cabinet with 2 Doors and Open Center Shelf  	18	66	41	197	35	AP4-BOS-4D-1866	VENEER PANEL \$5,021 PAINT PANEL \$5,021 GLASS PANEL \$6,990 FABRIC PANEL COM \$5,715 A \$5,743 B \$5,797 C \$5,891 D \$6,014 E \$6,134 F \$6,324 G \$6,529 H \$6,744 I \$7,084 J \$7,490
	<ul style="list-style-type: none"> · chassis and doors available in veneer or paint or veneer/paint combination · required insert panel available in veneer, paint, magnetic back painted white glass or fabric, indicate selection on order and select appropriate list price · aluminum mini shelf available, specify and add \$1,038 list · glass insert panel has a thin aluminum frame · pack of 6 magnets come with magnetic glass option · task lights available, see accessories price list · 1 1/2" wire access bottom across the bottom of back panel · legal depth · soft close hinge doors · adjustable shelves · aluminum valance rail · finished, flush back panel · fabric is railroaded · locking doors available, specify and add \$284 list · compartment height: 13 1/2" · compartment depth: 16 1/2" · worksurface to valance rail: 24 1/2" · com ydg: 2 						

15" d Storage Overhead Cabinet with 2 Doors and Open Center Shelf  	15	66	41	182	29	AP4-BOS-4-1566	VENEER PANEL \$4,876 PAINT PANEL \$4,876 GLASS PANEL \$6,845 FABRIC PANEL COM \$5,568 A \$5,597 B \$5,651 C \$5,746 D \$5,868 E \$5,988 F \$6,178 G \$6,384 H \$6,598 I \$6,940 J \$7,344
	<ul style="list-style-type: none"> · chassis and doors available in veneer or paint or veneer/paint combination · required insert panel available in veneer, paint, magnetic back painted white glass or fabric, indicate selection on order and select appropriate list price · aluminum mini shelf available, specify and add \$1,038 list · glass insert panel has a thin aluminum frame · pack of 6 magnets come with magnetic glass option · task lights available, see accessories price list · 1 1/2" wire access bottom across the bottom of back panel · letter depth · soft close hinge doors · adjustable shelves · aluminum valance rail · finished, flush back panel · fabric is railroaded · locking doors available, specify and add \$284 list · compartment height: 13 1/2" · compartment depth: 13 1/2" · worksurface to valance rail: 24 1/2" · com ydg: 2 						

Description	D	W	H	CTN WT	CU FT	① Model	List Price
18" d Storage Overhead Cabinet with 2 Doors and Open Center Shelf  	18	60	41	183	32	AP4-BOS-4D-1860	VENEER PANEL \$4,826 PAINT PANEL \$4,826 GLASS PANEL \$6,495 FABRIC PANEL COM \$5,501 A \$5,527 B \$5,583 C \$5,678 D \$5,800 E \$5,921 F \$6,109 G \$6,313 H \$6,531 I \$6,868 J \$7,275
<ul style="list-style-type: none"> chassis and doors available in veneer or paint or veneer/paint combination required insert panel available in veneer, paint, magnetic back painted white glass or fabric, indicate selection on order and select appropriate list price aluminum mini shelf available, specify and add \$980 list glass insert panel has a thin aluminum frame pack of 6 magnets come with magnetic glass option task lights available, see accessories price list 1 1/2" wire access bottom across the bottom of back panel legal depth soft close hinge doors adjustable shelves aluminum valance rail finished, flush back panel fabric is railroaded locking doors available, specify and add \$284 list compartment height: 13 1/2" compartment depth: 16 1/2" worksurface to valance rail: 24 1/2" com ydg: 2 							

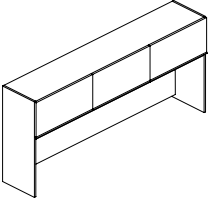

15" d Storage Overhead Cabinet with 2 Doors and Open Center Shelf  	15	60	41	169	27	AP4-BOS-4-1560	VENEER PANEL \$4,679 PAINT PANEL \$4,679 GLASS PANEL \$6,351 FABRIC PANEL COM \$5,355 A \$5,383 B \$5,436 C \$5,533 D \$5,654 E \$5,776 F \$5,965 G \$6,168 H \$6,386 I \$6,722 J \$7,129
<ul style="list-style-type: none"> chassis and doors available in veneer or paint or veneer/paint combination required insert panel available in veneer, paint, magnetic back painted white glass or fabric, indicate selection on order and select appropriate list price aluminum mini shelf available, specify and add \$980 list glass insert panel has a thin aluminum frame pack of 6 magnets come with magnetic glass option task lights available, see accessories price list 1 1/2" wire access bottom across the bottom of back panel letter depth soft close hinge doors adjustable shelves aluminum valance rail finished, flush back panel fabric is railroaded locking doors available, specify and add \$284 list compartment height: 13 1/2" compartment depth: 13 1/2" worksurface to valance rail: 24 1/2" com ydg: 2 							

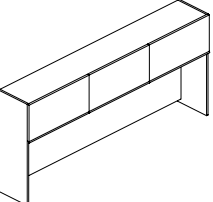

To Order, Specify:

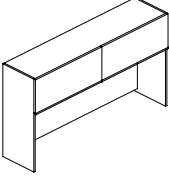
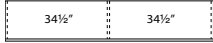
- ① Model Number
- ② Finish Application
 - a.) All Veneer
 - 1.) Wood Species - Makore (MK2), Maple (MA2), Walnut (WA2), Black Oak (BO1) or Double Cut (DC1) ([see page AP32](#))
 - a.) Finish Color ([see page AP32](#))
 - b.) All Paint (PNT)
 - 1.) Paint Color ([see page AP32](#))
- c.) Veneer/Paint Combination
 - 1.) Chassis Wood Species/Paint - Makore (MK2), Maple (MA2), Walnut (WA2), Black Oak (BO1), Double Cut (DC1) or Paint (PNT) ([see page AP32](#))
 - a.) Finish Color for Chassis ([see page AP32](#))
 - 2.) Door Wood Species/Paint - Makore (MK2), Maple (MA2), Walnut (WA2), Double Cut (DC1) or Paint (PNT) ([see page AP32](#))
 - a.) Finish Color for Door ([see page AP32](#))
- ③ Insert Panel
 - a.) Veneer
 - 1.) Wood Species - Makore (MK2), Maple (MA2), Walnut (WA2), Black Oak (BO1) or Double Cut (DC1) ([see page AP32](#))
 - a.) Finish Color ([see page AP32](#))
 - b.) Paint (PNT)
 - 1.) Paint Color ([see page AP32](#))
 - c.) Back Painted Magnetic Glass
 - d.) Fabric - vendor, pattern, color

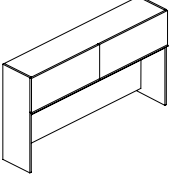
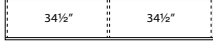
Visit www.jsi.furniture.com/finishes-and-material/textiles for our textiles program. See selection of standard and graded in manufactures and patterns.

Note: Only one wood finish and one paint color can be specified per unit

Description	D	W	H	CTN WT	CU FT	① Model	List Price	
18" d Storage Overhead Cabinet with 3 Flipper Doors  	18	90	41	269	47	AP4-BOS-FD-1890	VENEER PANEL \$6,912	
	<ul style="list-style-type: none"> · chassis and doors available in veneer or paint or veneer/paint combination · required insert panel available in veneer, paint, magnetic back painted white glass or fabric, indicate selection on order and select appropriate list price · aluminum mini shelf available, specify and add \$1,137 list · glass insert panel has a thin aluminum frame · task lights available, see accessories price list · pack of 6 magnets come with magnetic glass option · 1 1/2" wire access bottom across the bottom of back panel · legal depth · vertical lift doors · aluminum valance rail · finished, flush back panel · fabric is railroaded · compartment height: 13 1/2" · compartment depth: 16 1/2" · worksurface to valance rail: 24 1/2" · com ydg: 2 3/4 							PAINT PANEL \$6,912
								GLASS PANEL \$9,614
								FABRIC PANEL
								COM \$7,831
								A \$7,870
								B \$7,943
								C \$8,074
								D \$8,243
								E \$8,409
								F \$8,671
								G \$8,950
								H \$9,246
							I \$9,712	
							J \$10,271	

15" d Storage Overhead Cabinet with 3 Flipper Doors  	15	90	41	251	40	AP4-BOS-F-1590	VENEER PANEL \$6,769	
	<ul style="list-style-type: none"> · chassis and doors available in veneer or paint or veneer/paint combination · required insert panel available in veneer, paint, magnetic back painted white glass or fabric, indicate selection on order and select appropriate list price · aluminum mini shelf available, specify and add \$1,137 list · glass insert panel has a thin aluminum frame · pack of 6 magnets come with magnetic glass option · task lights available, see accessories price list · 1 1/2" wire access bottom across the bottom of back panel · letter depth · vertical lift doors · aluminum valance rail · finished, flush back panel · fabric is railroaded · compartment height: 13 1/2" · compartment depth: 13 1/2" · worksurface to valance rail: 24 1/2" · com ydg: 2 3/4 							PAINT PANEL \$6,769
								GLASS PANEL \$9,468
								FABRIC PANEL
								COM \$7,686
								A \$7,724
								B \$7,796
								C \$7,930
								D \$8,097
								E \$8,263
								F \$8,524
								G \$8,806
								H \$9,102
							I \$9,567	
							J \$10,125	

Description	D	W	H	CTN WT	CU FT	① Model	List Price
18" d Storage Overhead Cabinet with 2 Flipper Doors  	18	72	41	215	38	AP4-BOS-FD-1872	VENEER PANEL \$5,778 PAINT PANEL \$5,778 GLASS PANEL \$8,051 FABRIC PANEL COM \$6,489 A \$6,521 B \$6,580 C \$6,686 D \$6,824 E \$6,961 F \$7,173 G \$7,403 H \$7,646 I \$8,025 J \$8,483
	<ul style="list-style-type: none"> chassis and doors available in veneer or paint or veneer/paint combination required insert panel available in veneer, paint, magnetic back painted white glass or fabric, indicate selection on order and select appropriate list price aluminum mini shelf available, specify and add \$1,089 list glass insert panel has a thin aluminum frame pack of 6 magnets come with magnetic glass option task lights available, see accessories price list 1 1/2" wire access bottom across the bottom of back panel legal depth vertical lift doors aluminum valance rail finished, flush back panel fabric is railroaded compartment height: 13 1/2" compartment depth: 16 1/2" worksurface to valance rail: 24 1/2" com ydg: 2 1/4 						

15" d Storage Overhead Cabinet with 2 Flipper Doors  	15	72	41	200	32	AP4-BOS-F-1572	VENEER PANEL \$5,632 PAINT PANEL \$5,632 GLASS PANEL \$7,905 FABRIC PANEL COM \$6,341 A \$6,372 B \$6,435 C \$6,541 D \$6,679 E \$6,816 F \$7,029 G \$7,257 H \$7,500 I \$7,881 J \$8,338
	<ul style="list-style-type: none"> chassis and doors available in veneer or paint or veneer/paint combination required insert panel available in veneer, paint, magnetic back painted white glass or fabric, indicate selection on order and select appropriate list price aluminum mini shelf available, specify and add \$1,089 list glass insert panel has a thin aluminum frame pack of 6 magnets come with magnetic glass option task lights available, see accessories price list 1 1/2" wire access bottom across the bottom of back panel letter depth vertical lift doors aluminum valance rail finished, flush back panel fabric is railroaded compartment height: 13 1/2" compartment depth: 13 1/2" worksurface to valance rail: 24 1/2" com ydg: 2 1/4 						

To Order, Specify:

① Model Number

② Finish Application

- a.) All Veneer
 - 1.) Wood Species - Makore (MK2), Maple (MA2), Walnut (WA2), Black Oak (BO1) or Double Cut (DC1) ([see page AP32](#))
 - a.) Finish Color ([see page AP32](#))
- b.) All Paint (PNT)
 - 1.) Paint Color ([see page AP32](#))

c.) Veneer/Paint Combination

- 1.) Chassis Wood Species/Paint - Makore (MK2), Maple (MA2), Walnut (WA2), Black Oak (BO1), Double Cut (DC1) or Paint (PNT) ([see page AP32](#))
 - a.) Finish Color for Chassis ([see page AP32](#))
- 2.) Door Wood Species/Paint - Makore (MK2), Maple (MA2), Walnut (WA2), Double Cut (DC1) or Paint (PNT) ([see page AP32](#))
 - a.) Finish Color for Door ([see page AP32](#))

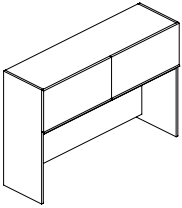
③ Insert Panel

- a.) Veneer
 - 1.) Wood Species - Makore (MK2), Maple (MA2), Walnut (WA2), Black Oak (BO1) or Double Cut (DC1) ([see page AP32](#))
 - a.) Finish Color ([see page AP32](#))
- b.) Paint (PNT)
 - 1.) Paint Color ([see page AP32](#))
- c.) Back Painted Magnetic Glass
- d.) Fabric - vendor, pattern, color

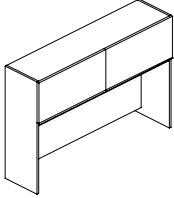

Visit www.jsi.furniture.com/finishes-and-material/textiles for our textiles program. See selection of standard and graded in manufactures and patterns.

Note: Only one wood finish and one paint color can be specified per unit

Description	D	W	H	CTN WT	CU FT	① Model	List Price
18" d Storage Overhead Cabinet with 2 Flipper Doors	18	60	41	185	32	AP4-BOS-FD-1860	VENEER PANEL \$5,554
	<ul style="list-style-type: none"> · chassis and doors available in veneer or paint or veneer/paint combination · required insert panel available in veneer, paint, magnetic back painted white glass or fabric, indicate selection on order and select appropriate list price · aluminum mini shelf available, specify and add \$980 list · glass insert panel has a thin aluminum frame · pack of 6 magnets come with magnetic glass option · task lights available, see accessories price list · 1 1/2" wire access bottom across the bottom of back panel · legal depth · vertical lift doors · aluminum valance rail · finished, flush back panel · fabric is railroaded · compartment height: 13 1/2" · compartment depth: 16 1/2" · worksurface to valance rail: 24 1/2" · com ydg: 2 						PAINT PANEL \$5,554 GLASS PANEL \$7,223 FABRIC PANEL COM \$6,225 A \$6,254 B \$6,310 C \$6,405 D \$6,528 E \$6,647 F \$6,836 G \$7,041 H \$7,257 I \$7,596 J \$8,003



APOGEE™

Description	D	W	H	CTN WT	CU FT	① Model	List Price
15"d Storage Overhead Cabinet with 2 Flipper Doors  	15	60	41	172	27	AP4-BOS-F-1560	VENEER PANEL \$5,407 PAINT PANEL \$5,407 GLASS PANEL \$7,079 FABRIC PANEL COM \$6,083 A \$6,109 B \$6,164 C \$6,260 D \$6,383 E \$6,503 F \$6,692 G \$6,896 H \$7,113 I \$7,450 J \$7,857
<ul style="list-style-type: none"> • chassis and doors available in veneer or paint or veneer/paint combination • required insert panel available in veneer, paint, magnetic back painted white glass or fabric, indicate selection on order and select appropriate list price • aluminum mini shelf available, specify and add \$980 list • glass insert panel has a thin aluminum frame • pack of 6 magnets come with magnetic glass option • task lights available, see accessories price list • 1 1/2" wire access bottom across the bottom of back panel • letter depth • vertical lift doors • aluminum valance rail • finished, flush back panel • fabric is railroaded • compartment height: 13 1/2" • compartment depth: 13 1/2" • worksurface to valance rail: 24 1/2" • com ydg: 2 							

APOGEE™

To Order, Specify:

① Model Number

② Finish Application

a.) All Veneer

- 1.) Wood Species - Makore (MK2), Maple (MA2), Walnut (WA2), Black Oak (BO1) or Double Cut (DC1) ([see page AP32](#))

a.) Finish Color ([see page AP32](#))

b.) All Paint (PNT)

- 1.) Paint Color ([see page AP32](#))

c.) Veneer/Paint Combination

- 1.) Chassis Wood Species/Paint - Makore (MK2), Maple (MA2), Walnut (WA2), Black Oak (BO1), Double Cut (DC1) or Paint (PNT) ([see page AP32](#))

a.) Finish Color for Chassis ([see page AP32](#))

- 2.) Door Wood Species/Paint - Makore (MK2), Maple (MA2), Walnut (WA2), Double Cut (DC1) or Paint (PNT) ([see page AP32](#))

a.) Finish Color for Door ([see page AP32](#))

③ Insert Panel

a.) Veneer

- 1.) Wood Species - Makore (MK2), Maple (MA2), Walnut (WA2), Black Oak (BO1) or Double Cut (DC1) ([see page AP32](#))

a.) Finish Color ([see page AP32](#))

b.) Paint (PNT)

- 1.) Paint Color ([see page AP32](#))

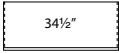
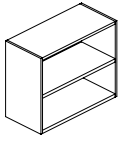
c.) Back Painted Magnetic Glass

d.) Fabric - vendor, pattern, color

Visit www.jsi.furniture.com/finishes-and-material/textiles for our textiles program. See selection of standard and graded in manufactures and patterns.

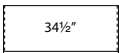
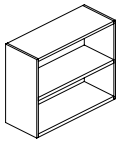
Note: Only one wood finish and one paint color can be specified per unit

Description	D	W	H	CTN WT	CU FT	① Model	List Price
17" d Double Height Wall Mount Overhead Cabinet with Open Storage	17	36	30	70	14	AM4-BOX-1D-1736	\$2,783



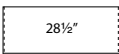
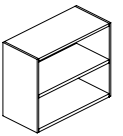
- legal depth storage
- mounting hardware included
- valance rail highly recommended, [see page AP99](#)
- upper compartment height: 13 1/2"
- lower compartment height: 14 1/4"
- compartment depth: 16 1/4"

14" d Double Height Wall Mount Overhead Cabinet with Open Storage	14	36	30	62	12	AM4-BOX-1-1436	\$2,638
--	----	----	----	----	----	----------------	---------



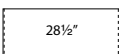
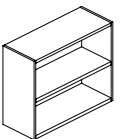
- letter depth storage
- mounting hardware included
- valance rail highly recommended, [see page AP99](#)
- upper compartment height: 13 1/2"
- lower compartment height: 14 1/4"
- compartment depth: 13 1/4"

17" d Double Height Wall Mount Overhead Cabinet with Open Storage	17	30	30	62	12	AM4-BOX-1D-1730	\$2,696
--	----	----	----	----	----	-----------------	---------



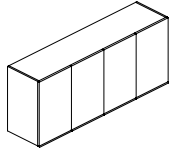
- legal depth storage
- mounting hardware included
- valance rail highly recommended, [see page AP99](#)
- upper compartment height: 13 1/2"
- lower compartment height: 14 1/4"
- compartment depth: 16 1/4"

14" d Double Height Wall Mount Overhead Cabinet with Open Storage	14	30	30	54	10	AM4-BOX-1-1430	\$2,551
--	----	----	----	----	----	----------------	---------

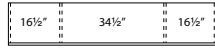


- letter depth storage
- mounting hardware included
- valance rail highly recommended, [see page AP99](#)
- upper compartment height: 13 1/2"
- lower compartment height: 14 1/4"
- compartment depth: 13 1/4"

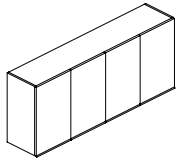
Description	D	W	H	CTN WT	CU FT	① Model	List Price
18"d Double Height Wall Mount Overhead Cabinet with 4 Doors	18	72	30	203	28	AM4-BBX-1D-1872	\$4,658



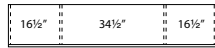
- legal depth storage
- mounting hardware included
- locking doors available, specify and add \$426 list
- valance rail highly recommended, [see page AP99](#)
- compartment height: 28 1/4"
- compartment depth: 16 1/2"



15"d Double Height Wall Mount Overhead Cabinet with 4 Doors	15	72	30	182	24	AM4-BBX-1-1572	\$4,513
---	----	----	----	-----	----	----------------	---------



- letter depth storage
- mounting hardware included
- locking doors available, specify and add \$426 list
- valance rail highly recommended, [see page AP99](#)
- compartment height: 28 1/4"
- compartment depth: 13 1/2"



APOGEE™

To Order, Specify:

Open Storage

- ① Model Number
- ② Wood Species/Paint - Makore (MK2), Maple (MA2), Walnut (WA2), Black Oak (BO1), Double Cut (DC1) or Paint (PNT) ([see page AP32](#))
- ③ Finish Color ([see page AP32](#))

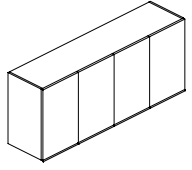
Overhead Cabinet

- ① Model Number
- ② Finish Application
 - a.) All Veneer
 - 1.) Wood Species - Makore (MK2), Maple (MA2), Walnut (WA2), Black Oak (BO1) or Double Cut (DC1) ([see page AP32](#))
 - a.) Finish Color ([see page AP32](#))
 - b.) All Paint (PNT)
 - 1.) Paint Color ([see page AP32](#))

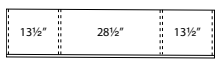
- c.) Veneer/Paint Combination
 - 1.) Chassis Wood Species/Paint - Makore (MK2), Maple (MA2), Walnut (WA2), Black Oak (BO1), Double Cut (DC1) or Paint (PNT) ([see page AP32](#))
 - a.) Finish Color for Chassis ([see page AP32](#))
 - 2.) Door Wood Species/Paint - Makore (MK2), Maple (MA2), Walnut (WA2), Black Oak (BO1), Double Cut (DC1) or Paint (PNT) ([see page AP32](#))
 - a.) Finish Color for Door ([see page AP32](#))

Note: Only one wood finish and one paint color can be specified per unit

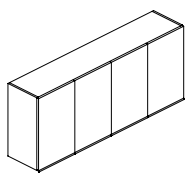
Description	D	W	H	CTN WT	CU FT	① Model	List Price
18" d Double Height Wall Mount Overhead Cabinet with 4 Doors	18	60	30	179	24	AM4-BBX-1D-1860	\$4,367



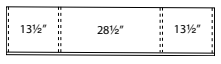
- legal depth storage
- mounting hardware included
- locking doors available, specify and add \$426 list
- valance rail highly recommended, [see page AP99](#)
- compartment height: 28 1/2"
- compartment depth: 16 1/2"



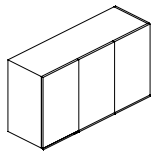
15" d Double Height Wall Mount Overhead Cabinet with 4 Doors	15	60	30	160	20	AM4-BBX-1-1560	\$4,221
--	----	----	----	-----	----	----------------	---------



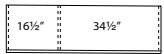
- letter depth storage
- mounting hardware included
- locking doors available, specify and add \$426 list
- valance rail highly recommended, [see page AP99](#)
- compartment height: 28 1/2"
- compartment depth: 13 1/2"



18" d Double Height Wall Mount Overhead Cabinet with 3 Doors	18	54	30	148	21	AM4-BBX-1D-1854R	\$3,860
	18	54	30	148	21	AM4-BBX-1D-1854L	\$3,860

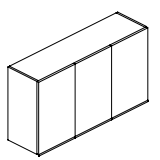


- legal depth storage
- mounting hardware included
- locking doors available, specify and add \$284 list
- valance rail highly recommended, [see page AP99](#)
- compartment height: 28 1/2"
- compartment depth: 16 1/2"

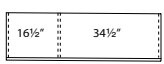


left shown

15" d Double Height Wall Mount Overhead Cabinet with 3 Doors	15	54	30	133	18	AM4-BBX-1-1554R	\$3,714
	15	54	30	133	18	AM4-BBX-1-1554L	\$3,714

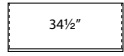
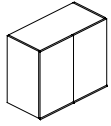


- letter depth storage
- mounting hardware included
- locking doors available, specify and add \$284 list
- valance rail highly recommended, [see page AP99](#)
- compartment height: 28 1/2"
- compartment depth: 13 1/2"



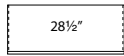
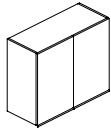
left shown

Description	D	W	H	CTN WT	CU FT	① Model	List Price
18"d Double Height Wall Mount Overhead Cabinet with 2 Doors	18	36	30	94	15	AM4-BBX-1D-1836	\$3,291



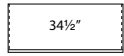
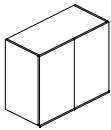
- legal depth storage
- mounting hardware included
- locking doors available, specify and add \$142 list
- valance rail highly recommended, [see page AP99](#)
- compartment height: 28 1/2"
- compartment depth: 16 1/2"

15"d Double Height Wall Mount Overhead Cabinet with 2 Doors	15	36	30	84	12	AM4-BBX-1-1536	\$3,145
---	----	----	----	----	----	----------------	---------



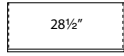
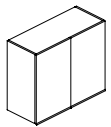
- letter depth storage
- mounting hardware included
- locking doors available, specify and add \$142 list
- valance rail highly recommended, [see page AP99](#)
- compartment height: 28 1/2"
- compartment depth: 13 1/2"

18"d Double Height Wall Mount Overhead Cabinet with 2 Doors	18	30	30	81	12	AM4-BBX-1D-1830	\$3,204
---	----	----	----	----	----	-----------------	---------



- legal depth storage
- mounting hardware included
- locking doors available, specify and add \$142 list
- valance rail highly recommended, [see page AP99](#)
- compartment height: 28 1/2"
- compartment depth: 16 1/2"

15"d Double Height Wall Mount Overhead Cabinet with 2 Doors	15	30	30	73	10	AM4-BBX-1-1530	\$3,058
---	----	----	----	----	----	----------------	---------



- letter depth storage
- mounting hardware included
- locking doors available, specify and add \$142 list
- valance rail highly recommended, [see page AP99](#)
- compartment height: 28 1/2"
- compartment depth: 13 1/2"

To Order, Specify:

① Model Number

② Finish Application

a.) All Veneer

- 1.) Wood Species - Makore (MK2), Maple (MA2), Walnut (WA2), Black Oak (BO1) or Double Cut (DC1) ([see page AP32](#))

a.) Finish Color ([see page AP32](#))

b.) All Paint (PNT)

- 1.) Paint Color ([see page AP32](#))

c.) Veneer/Paint Combination

- 1.) Chassis Wood Species/Paint - Makore (MK2), Maple (MA2), Walnut (WA2), Black Oak (BO1), Double Cut (DC1) or Paint (PNT) ([see page AP32](#))

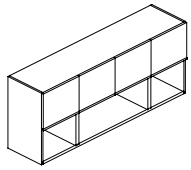
a.) Finish Color for Chassis ([see page AP32](#))

- 2.) Door Wood Species/Paint - Makore (MK2), Maple (MA2), Walnut (WA2), Black Oak (BO1), Double Cut (DC1) or Paint (PNT) ([see page AP32](#))

a.) Finish Color for Door ([see page AP32](#))

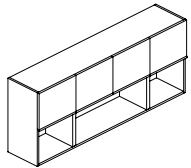
Note: Only one wood finish and one paint color can be specified per unit

Description	D	W	H	CTN WT	CU FT	① Model	List Price
18" d Double Height Wall Mount Overhead Cabinet with 4 Doors and Open Storage	18	72	30	182	28	AM4-BDX-1D-1872	\$4,221



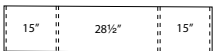
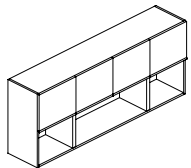
- legal depth storage
- mounting hardware included
- locking doors available, specify and add \$426 list
- valance rail highly recommended, [see page AP99](#)
- upper compartment height: 13 1/2"
- lower compartment height: 14 1/4"
- compartment depth: 16 1/4"

15" d Double Height Wall Mount Overhead Cabinet with 4 Doors and Open Storage	15	72	30	161	24	AM4-BCX-1-1572	\$4,078
---	----	----	----	-----	----	----------------	---------



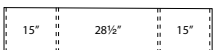
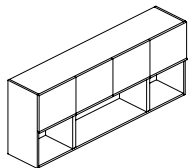
- letter depth storage
- mounting hardware included
- locking doors available, specify and add \$426 list
- valance rail highly recommended, [see page AP99](#)
- upper compartment height: 13 1/2"
- lower compartment height: 14 1/4"
- compartment depth: 13 1/4"

18" d Double Height Wall Mount Overhead Cabinet with 4 Doors and Open Storage	18	60	30	161	24	AM4-BDX-1D-1860	\$3,931
---	----	----	----	-----	----	-----------------	---------

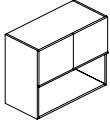
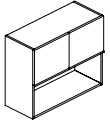
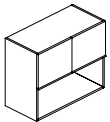
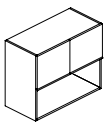


- legal depth storage
- mounting hardware included
- locking doors available, specify and add \$426 list
- valance rail highly recommended, [see page AP99](#)
- upper compartment height: 13 1/2"
- lower compartment height: 14 1/4"
- compartment depth: 16 1/4"

15" d Double Height Wall Mount Overhead Cabinet with 4 Doors and Open Storage	15	60	30	143	20	AM4-BCX-1-1560	\$3,785
---	----	----	----	-----	----	----------------	---------



- letter depth storage
- mounting hardware included
- locking doors available, specify and add \$426 list
- valance rail highly recommended, [see page AP99](#)
- upper compartment height: 13 1/2"
- lower compartment height: 14 1/4"
- compartment depth: 13 1/4"

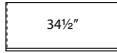
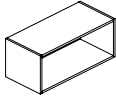
Description	D	W	H	CTN WT	CU FT	① Model	List Price
18" d Double Height Wall Mount Overhead Cabinet with 2 Doors and Open Storage  <div style="border: 1px solid black; padding: 2px; width: fit-content; margin-top: 5px;">34½"</div> <ul style="list-style-type: none"> · legal depth storage · mounting hardware included · locking doors available, specify and add \$142 list · valance rail highly recommended, see page AP99 · upper compartment height: 13 ½" · lower compartment height: 14 ¼" · compartment depth: 16 ¼" 	18	36	30	83	15	AM4-BDX-1D-1836	\$3,073
15" d Double Height Wall Mount Overhead Cabinet with 2 Doors and Open Storage  <div style="border: 1px solid black; padding: 2px; width: fit-content; margin-top: 5px;">28½"</div> <ul style="list-style-type: none"> · letter depth storage · mounting hardware included · locking doors available, specify and add \$142 list · valance rail highly recommended, see page AP99 · upper compartment height: 13 ½" · lower compartment height: 14 ¼" · compartment depth: 13 ¼" 	15	36	30	74	12	AM4-BCX-1-1536	\$2,928
18" d Double Height Wall Mount Overhead Cabinet with 2 Doors and Open Storage  <div style="border: 1px solid black; padding: 2px; width: fit-content; margin-top: 5px;">34½"</div> <ul style="list-style-type: none"> · legal depth storage · mounting hardware included · locking doors available, specify and add \$142 list · valance rail highly recommended, see page AP99 · upper compartment height: 13 ½" · lower compartment height: 14 ¼" · compartment depth: 16 ¼" 	18	30	30	72	12	AM4-BDX-1D-1830	\$2,987
15" d Double Height Wall Mount Overhead Cabinet with 2 Doors and Open Storage  <div style="border: 1px solid black; padding: 2px; width: fit-content; margin-top: 5px;">28½"</div> <ul style="list-style-type: none"> · letter depth storage · mounting hardware included · locking doors available, specify and add \$142 list · valance rail highly recommended, see page AP99 · upper compartment height: 13 ½" · lower compartment height: 14 ¼" · compartment depth: 13 ¼" 	15	30	30	64	10	AM4-BCX-1-1530	\$2,840

To Order, Specify:

- ① Model Number
- ② Finish Application
 - a.) All Veneer
 - 1.) Wood Species - Makore (MK2), Maple (MA2), Black Oak (BO1), Walnut (WA2) or Double Cut (DC1) ([see page AP32](#))
 - a.) Finish Color ([see page AP32](#))
 - 2.) Door Wood Species/Paint - Makore (MK2), Maple (MA2), Walnut (WA2), Black Oak (BO1) Double Cut (DC1) or Paint (PNT) ([see page AP32](#))
 - a.) Finish Color for Door ([see page AP32](#))
 - b.) All Paint (PNT)
 - 1.) Paint Color ([see page AP32](#))
 - c.) Veneer/Paint Combination
 - 1.) Chassis Wood Species/Paint - Makore (MK2), Maple (MA2), Walnut (WA2), Black Oak (BO1) Double Cut (DC1) or Paint (PNT) ([see page AP32](#))
 - a.) Finish Color for Chassis ([see page AP32](#))
 - 2.) Door Wood Species/Paint - Makore (MK2), Maple (MA2), Walnut (WA2), Black Oak (BO1) Double Cut (DC1) or Paint (PNT) ([see page AP32](#))
 - a.) Finish Color for Door ([see page AP32](#))

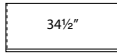
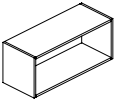
Note: Only one wood finish and one paint color can be specified per unit

Description	D	W	H	CTN WT	CU FT	① Model	List Price
17" d Wall Mount Overhead Cabinet with Open Storage	17	36	15	42	8	AM4-BOW-1D-1736	\$2,231



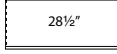
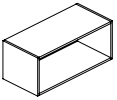
- legal depth storage
- mounting hardware included
- valance rail highly recommended, [see page AP99](#)
- compartment height: 13 1/2"
- compartment depth: 16 1/4"

14" d Wall Mount Overhead Cabinet with Open Storage	14	36	15	36	6	AM4-BOW-1-1436	\$2,085
--	----	----	----	----	---	-----------------------	----------------



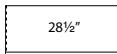
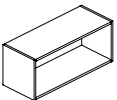
- letter depth storage
- mounting hardware included
- valance rail highly recommended, [see page AP99](#)
- compartment height: 13 1/2"
- compartment depth: 13 1/4"

17" d Wall Mount Overhead Cabinet with Open Storage	17	30	15	36	6	AM4-BOW-1D-1730	\$2,143
--	----	----	----	----	---	------------------------	----------------



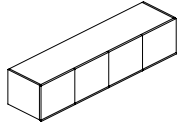
- legal depth storage
- mounting hardware included
- valance rail highly recommended, [see page AP99](#)
- compartment height: 13 1/2"
- compartment depth: 16 1/4"

14" d Wall Mount Overhead Cabinet with Open Storage	14	30	15	32	5	AM4-BOW-1-1430	\$1,997
--	----	----	----	----	---	-----------------------	----------------

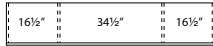


- letter depth storage
- mounting hardware included
- valance rail highly recommended, [see page AP99](#)
- compartment height: 13 1/2"
- compartment depth: 13 1/4"

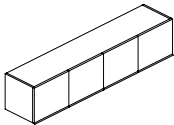
Description	D	W	H	CTN WT	CU FT	① Model	List Price
18"d Wall Mount Overhead Cabinet with 4 Doors	18	72	15	116	15	AM4-BBW-1D-1872	\$3,683



- legal depth storage
- mounting hardware included
- locking doors available, specify and add \$426 list
- valance rail highly recommended, [see page AP99](#)
- compartment height: 13 1/2"
- compartment depth: 16 1/4"



15"d Wall Mount Overhead Cabinet with 4 Doors	15	72	15	104	13	AM4-BBW-1-1572	\$3,540
---	----	----	----	-----	----	----------------	---------



- letter depth storage
- mounting hardware included
- locking doors available, specify and add \$426 list
- valance rail highly recommended, [see page AP99](#)
- compartment height: 13 1/2"
- compartment depth: 13 1/4"



APOGEE™

To Order, Specify:

Open Storage

- ① Model Number
- ② Wood Species/Paint - Makore (MK2), Maple (MA2), Walnut (WA2), Black Oak (BO1) or Double Cut (DC1) or Paint (PNT) ([see page AP32](#))
- ③ Finish Color ([see page AP32](#))

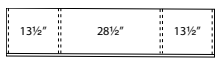
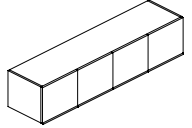
Note: Only one wood finish and one paint color can be specified per unit

Overhead Cabinet

- ① Model Number
- ② Finish Application
 - a.) All Veneer
 - 1.) Wood Species - Makore (MK2), Maple (MA2), Walnut (WA2), Black Oak (BO1) or Double Cut (DC1) ([see page AP32](#))
 - a.) Finish Color ([see page AP32](#))
 - b.) All Paint (PNT)
 - 1.) Paint Color ([see page AP32](#))

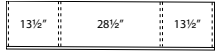
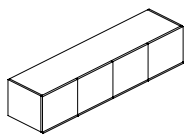
- c.) Veneer/Paint Combination
 - 1.) Chassis Wood Species/Paint - Makore (MK2), Maple (MA2), Walnut (WA2), Black Oak (BO1), Double Cut (DC1) or Paint (PNT) ([see page AP32](#))
 - a.) Finish Color for Chassis ([see page AP32](#))
 - 2.) Door Wood Species/Paint - Makore (MK2), Maple (MA2), Walnut (WA2), Black Oak (BO1), Double Cut (DC1) or Paint (PNT) ([see page AP32](#))
 - a.) Finish Color for Door ([see page AP32](#))

Description	D	W	H	CTN WT	CU FT	① Model	List Price
18" d Wall Mount Overhead Cabinet with 4 Doors	18	60	15	102	13	AM4-BBW-1D-1860	\$3,466



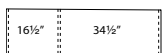
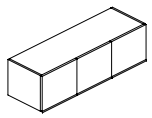
- legal depth storage
- mounting hardware included
- locking doors available, specify and add \$426 list
- valance rail highly recommended, [see page AP99](#)
- compartment height: 13 1/2"
- compartment depth: 16 1/4"

15" d Wall Mount Overhead Cabinet with 4 Doors	15	60	15	91	11	AM4-BBW-1-1560	\$3,319
---	----	----	----	----	----	-----------------------	----------------



- letter depth storage
- mounting hardware included
- locking doors available, specify and add \$426 list
- valance rail highly recommended, [see page AP99](#)
- compartment height: 13 1/2"
- compartment depth: 13 1/4"

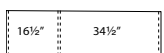
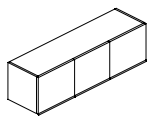
18" d Wall Mount Overhead Cabinet with 3 Doors	18	54	15	85	12	AM4-BBW-1D-1854R	\$2,957
	18	54	15	85	12	AM4-BBW-1D-1854L	\$2,957



- legal depth storage
- mounting hardware included
- locking doors available, specify and add \$284 list
- valance rail highly recommended, [see page AP99](#)
- compartment height: 13 1/2"
- compartment depth: 16 1/4"

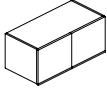
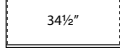
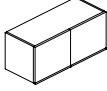
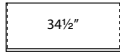
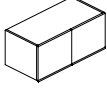
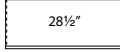
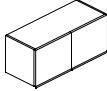

left shown

15" d Wall Mount Overhead Cabinet with 3 Doors	15	54	15	76	10	AM4-BBW-1-1554R	\$2,812
	15	54	15	76	10	AM4-BBW-1-1554L	\$2,812



- letter depth storage
- mounting hardware included
- locking doors available, specify and add \$284 list
- valance rail highly recommended, [see page AP99](#)
- compartment height: 13 1/2"
- compartment depth: 13 1/4"

left shown

Description	D	W	H	CTN WT	CU FT	① Model	List Price
18" d Wall Mount Overhead Cabinet with 2 Doors   <ul style="list-style-type: none"> • legal depth storage • mounting hardware included • locking doors available, specify and add \$142 list • valance rail highly recommended, see page AP99 • compartment height: 13 1/2" • compartment depth: 16 1/4" 	18	36	15	54	8	AM4-BBW-1D-1836	\$2,447
15" d Wall Mount Overhead Cabinet with 2 Doors   <ul style="list-style-type: none"> • letter depth storage • mounting hardware included • locking doors available, specify and add \$142 list • valance rail highly recommended, see page AP99 • compartment height: 13 1/2" • compartment depth: 13 1/4" 	15	36	15	49	7	AM4-BBW-1-1536	\$2,302
18" d Wall Mount Overhead Cabinet with 2 Doors   <ul style="list-style-type: none"> • legal depth storage • mounting hardware included • locking doors available, specify and add \$142 list • valance rail highly recommended, see page AP99 • compartment height: 13 1/2" • compartment depth: 16 1/4" 	18	30	15	47	7	AM4-BBW-1D-1830	\$2,302
15" d Wall Mount Overhead Cabinet with 2 Doors   <ul style="list-style-type: none"> • letter depth storage • mounting hardware included • locking doors available, specify and add \$142 list • valance rail highly recommended, see page AP99 • compartment height: 13 1/2" • compartment depth: 13 1/4" 	15	30	15	42	6	AM4-BBW-1-1530	\$2,157

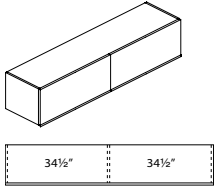
To Order, Specify:

- ① Model Number
- ② Finish Application
 - a.) All Veneer
 - 1.) Wood Species - Makore (MK2), Maple (MA2), Walnut (WA2), Black Oak (BO1) or Double Cut (DC1) ([see page AP32](#))
 - a.) Finish Color ([see page AP32](#))
 - b.) All Paint (PNT)
 - 1.) Paint Color ([see page AP32](#))
 - c.) Veneer/Paint Combination
 - 1.) Chassis Wood Species/Paint - Makore (MK2), Maple (MA2), Walnut (WA2), Black Oak (BO1), Double Cut (DC1) or Paint (PNT) ([see page AP32](#))
 - a.) Finish Color for Chassis ([see page AP32](#))
 - 2.) Door Wood Species/Paint - Makore (MK2), Maple (MA2), Walnut (WA2), Black Oak (BO1), Double Cut (DC1) or Paint (PNT) ([see page AP32](#))
 - a.) Finish Color for Door ([see page AP32](#))

Note: Only one wood finish and one paint color can be specified per unit

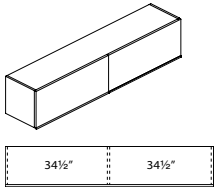
APOGEE™

Description	D	W	H	CTN WT	CU FT	① Model	List Price
18" d Wall Mount Overhead Cabinet with 2 Flipper Doors	18	72	15	108	15	AM4-BBW-FD-1872	\$3,975



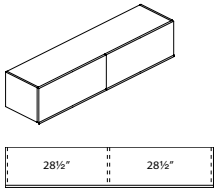
- legal depth storage
- vertical lift doors
- mounting hardware included
- valance rail highly recommended, [see page AP99](#)
- compartment height: 13 1/2"
- compartment depth: 16 1/4"

15" d Wall Mount Overhead Cabinet with 2 Flipper Doors	15	72	15	97	13	AM4-BBW-F-1572	\$3,829
---	----	----	----	----	----	----------------	---------



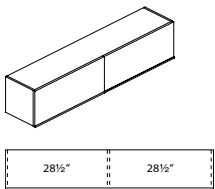
- letter depth storage
- vertical lift doors
- mounting hardware included
- valance rail highly recommended, [see page AP99](#)
- compartment height: 13 1/2"
- compartment depth: 13 1/2"

18" d Wall Mount Overhead Cabinet with 2 Flipper Doors	18	60	15	94	13	AM4-BBW-FD-1860	\$3,756
---	----	----	----	----	----	-----------------	---------



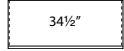
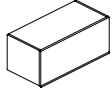
- legal depth storage
- vertical lift doors
- mounting hardware included
- valance rail highly recommended, [see page AP99](#)
- compartment height: 13 1/2"
- compartment depth: 16 1/4"

15" d Wall Mount Overhead Cabinet with 2 Flipper Doors	15	60	15	84	11	AM4-BBW-F-1560	\$3,611
---	----	----	----	----	----	----------------	---------



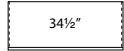
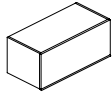
- letter depth storage
- vertical lift doors
- mounting hardware included
- valance rail highly recommended, [see page AP99](#)
- compartment height: 13 1/2"
- compartment depth: 13 1/2"

Description	D	W	H	CTN WT	CU FT	① Model	List Price
18" d Wall Mount Overhead Cabinet with Flipper Door	18	36	15	54	8	AM4-BBW-FD-1836	\$2,593



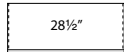
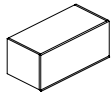
- legal depth storage
- vertical lift doors
- mounting hardware included
- valance rail highly recommended, [see page AP99](#)
- compartment height: 13 1/2"
- compartment depth: 16 1/4"

15" d Wall Mount Overhead Cabinet with Flipper Door	15	36	15	49	7	AM4-BBW-F-1536	\$2,447
--	----	----	----	----	---	----------------	---------



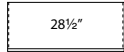
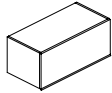
- letter depth storage
- vertical lift doors
- mounting hardware included
- valance rail highly recommended, [see page AP99](#)
- compartment height: 13 1/2"
- compartment depth: 13 1/2"

18" d Wall Mount Overhead Cabinet with Flipper Door	18	30	15	47	7	AM4-BBW-FD-1830	\$2,521
--	----	----	----	----	---	-----------------	---------



- legal depth storage
- vertical lift doors
- mounting hardware included
- valance rail highly recommended, [see page AP99](#)
- compartment height: 13 1/2"
- compartment depth: 16 1/4"

15" d Wall Mount Overhead Cabinet with Flipper Door	15	30	15	43	6	AM4-BBW-F-1530	\$2,375
--	----	----	----	----	---	----------------	---------



- letter depth storage
- vertical lift doors
- mounting hardware included
- valance rail highly recommended, [see page AP99](#)
- compartment height: 13 1/2"
- compartment depth: 13 1/2"

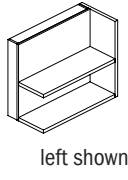
TTo Order, Specify:

- ① Model Number
- ② Finish Application
 - a.) All Veneer
 - 1.) Wood Species - Makore (MK2), Maple (MA2), Walnut (WA2), Black Oak (BO1) or Double Cut (DC1) ([see page AP32](#))
 - a.) Finish Color ([see page AP32](#))
 - b.) All Paint (PNT)
 - 1.) Paint Color ([see page AP32](#))
- c.) Veneer/Paint Combination
 - 1.) Chassis Wood Species/Paint - Makore (MK2), Maple (MA2), Walnut (WA2), Black Oak (BO1), Double Cut (DC1) or Paint (PNT) ([see page AP32](#))
 - a.) Finish Color for Chassis ([see page AP32](#))
 - 2.) Door Wood Species/Paint - Makore (MK2), Maple (MA2), Walnut (WA2), Black Oak (BO1), Double Cut (DC1) or Paint (PNT) ([see page AP32](#))
 - a.) Finish Color for Door ([see page AP32](#))

Note: Only one wood finish and one paint color can be specified per unit

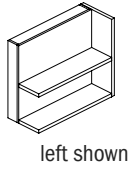
APOGEE™

Description	D	W	H	CTN WT	CU FT	① Model	List Price
17" d Open End Shelves	17	36	29 ¼	121	14	AM4-BOX-ED-1736R	\$2,563
	17	36	29 ¼	121	14	AM4-BOX-ED-1736L	\$2,563
	17	30	29 ¼	104	12	AM4-BOX-ED-1730R	\$2,477
	17	30	29 ¼	104	12	AM4-BOX-ED-1730L	\$2,477



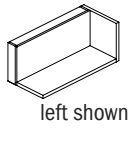
- use with overhead cabinet
- match with legal depth storage
- wall mounted
- mounting hardware included
- valance rail highly recommended
- shelf depth: 12 ½"

14" d Open End Shelves	14	36	29 ¼	115	12	AM4-BOX-E-1436R	\$2,417
	14	36	29 ¼	115	12	AM4-BOX-E-1436L	\$2,417
	14	30	29 ¼	98	10	AM4-BOX-E-1430R	\$2,331
	14	30	29 ¼	98	10	AM4-BOX-E-1430L	\$2,331



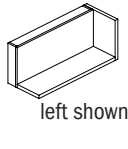
- use with overhead cabinet
- match with letter depth storage
- wall mounted
- mounting hardware included
- valance rail highly recommended
- shelf depth: 10"

17" d Open End Shelf	17	36	15	70	8	AM4-BOW-ED-1736R	\$2,012
	17	36	15	70	8	AM4-BOW-ED-1736L	\$2,012
	17	30	15	59	6	AM4-BOW-ED-1730R	\$1,923
	17	30	15	59	6	AM4-BOW-ED-1730L	\$1,923

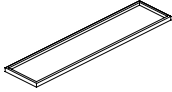


- use with overhead cabinet
- match with legal depth storage
- wall mounted
- mounting hardware included
- valance rail highly recommended
- shelf depth: 12 ½"

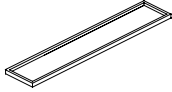
14" d Open End Shelf	14	36	15	63	6	AM4-BOW-E-1436R	\$1,865
	14	36	15	63	6	AM4-BOW-E-1436L	\$1,865
	14	30	15	54	5	AM4-BOW-E-1430R	\$1,779
	14	30	15	54	5	AM4-BOW-E-1430L	\$1,779




- use with overhead cabinet
- match with letter depth storage
- wall mounted
- mounting hardware included
- valance rail highly recommended
- shelf depth: 10"

Description	D	W	H	CTN WT	CU FT	① Model	List Price
Legal Valance 	16	108	1 ¾	16	5	AP9-VLB-1-16108	\$687
	16	102	1 ¾	16	5	AP9-VLB-1-16102	\$674
	16	96	1 ¾	15	5	AP9-VLB-1-1696	\$631
	16	90	1 ¾	14	5	AP9-VLB-1-1690	\$614
	16	72	1 ¾	12	4	AP9-VLB-1-1672	\$566
	16	60	1 ¾	9	3	AP9-VLB-1-1660	\$536
	16	54	1 ¾	9	2	AP9-VLB-1-1654	\$521
	16	36	1 ¾	7	2	AP9-VLB-1-1636	\$471
	16	30	1 ¾	6	2	AP9-VLB-1-1630	\$456

- use with legal wall mounted storage only
- anodized aluminum

Letter Valance 	14	108	1 ¾	15	5	AP9-VLB-1-14108	\$659
	14	102	1 ¾	15	5	AP9-VLB-1-14102	\$644
	14	96	1 ¾	14	5	AP9-VLB-1-1496	\$601
	14	90	1 ¾	13	4	AP9-VLB-1-1490	\$586
	14	72	1 ¾	10	3	AP9-VLB-1-1472	\$536
	14	60	1 ¾	9	3	AP9-VLB-1-1460	\$506
	14	54	1 ¾	8	2	AP9-VLB-1-1454	\$492
	14	36	1 ¾	7	2	AP9-VLB-1-1436	\$439
	14	30	1 ¾	5	1	AP9-VLB-1-1430	\$428

- use with letter wall mounted storage only
- anodized aluminum

Overhead Support End Panel 	17	85	85 ½	79	85	AM7-FEP-1D-1785	\$1,415
	17	70	70 ½	60	58	AM7-FEP-1D-1770	\$1,269
	14	85	85 ½	67	71	AM7-FEP-1-1485	\$1,372
	14	70	70 ½	51	49	AM7-FEP-1-1470	\$1,226

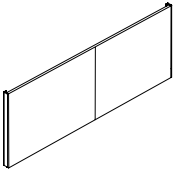
- 17"d use with legal depth storage
- 14"d use with letter depth storage

To Order, Specify:

- ① Model Number
- ② Wood Species/Paint - Makore (MK2), Maple (MA2)
Walnut (WA2), Black Oak (BO1), Double Cut (DC1)
or Paint (PNT) ([see page AP32](#))
- ③ Finish Color

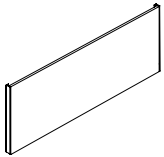
Note: Only one wood finish and one paint color can be specified per unit

Description	D	W	H	CTN WT	CU FT	① Model	Veneer	Paint	Magnetic Back Painted Glass
Wall Panel	1 ¾	108	24	64	6	AM9-HVB-1-24108	\$1,894	\$1,894	\$4,793



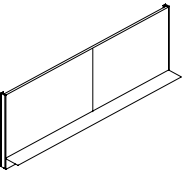
- use with wall mounted overhead storage
- wall mounted
- requires a valance, [see page AP99](#)
- glass option has a thin aluminum frame
- pack of 6 magnets come with magnetic glass option

Wall Panel	1 ¾	90	24	53	5	AM9-HVB-1-2490	\$1,749	\$1,749	\$4,197
	1 ¾	72	24	43	4	AM9-HVB-1-2472	\$1,314	\$1,314	\$3,275
	1 ¾	60	24	37	4	AM9-HVB-1-2460	\$1,205	\$1,205	\$2,791
	1 ¾	54	24	33	3	AM9-HVB-1-2454	\$1,132	\$1,132	\$2,563
	1 ¾	36	24	22	2	AM9-HVB-1-2436	\$1,022	\$1,022	\$2,299
	1 ¾	30	24	20	2	AM9-HVB-1-2430	\$951	\$951	\$2,073



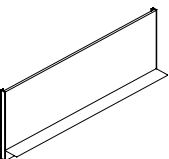
- use with wall mounted overhead storage
- wall mounted
- requires a valance, [see page AP99](#)
- glass option has a thin aluminum frame
- pack of 6 magnets come with magnetic glass option

Wall Panel with Shelf	6 ¾	108	24	86	15	AM9-HVB-S-24108	\$3,336	\$3,336	\$5,820
-----------------------	-----	-----	----	----	----	-----------------	---------	---------	---------

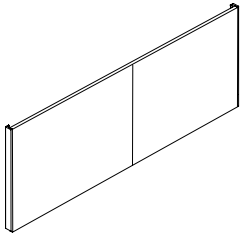


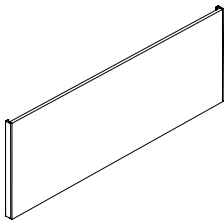
- use with wall mounted overhead storage
- wall mounted
- requires a valance, [see page AP99](#)
- glass option has a thin aluminum frame
- pack of 6 magnets come with magnetic glass option
- anodized aluminum shelf

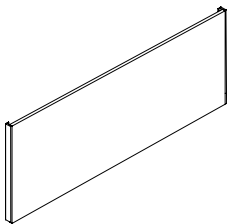
Wall Panel with Shelf	6 ¾	90	24	69	13	AM9-HVB-S-2490	\$3,162	\$3,162	\$5,226
	6 ¾	72	24	55	10	AM9-HVB-S-2472	\$2,638	\$2,638	\$4,302
	6 ¾	60	24	49	8	AM9-HVB-S-2460	\$2,499	\$2,499	\$3,816
	6 ¾	54	24	44	8	AM9-HVB-S-2454	\$2,325	\$2,325	\$3,494
	6 ¾	36	24	30	5	AM9-HVB-S-2436	\$2,179	\$2,179	\$3,204
	6 ¾	30	24	26	4	AM9-HVB-S-2430	\$2,012	\$2,012	\$2,935



- use with wall mounted overhead storage
- wall mounted
- requires a valance [see page AP99](#)
- glass option has a thin aluminum frame
- pack of 6 magnets come with magnetic glass option
- anodized aluminum shelf

Description	D	W	H	CTN WT	CU FT	① Model	List Price Per Grade
108" w Wall Mount Tackboard	1 ¾	108	24	42	6	AM9-HTB-1-24108	COM \$2,563
 <ul style="list-style-type: none"> • use with wall mount overhead storage cabinet • wall mounted • requires a valance, see page AP99 • fabric is railroaded • com ydg: 3 ¼ 	A						\$2,609
	B						\$2,697
	C						\$2,851
	D						\$3,048
	E						\$3,249
	F						\$3,555
	G						\$3,887
	H						\$4,237
	I						\$4,787
	J						\$5,447

90" w Wall Mount Tackboard	1 ¾	90	24	35	5	AM9-HTB-1-2490	COM \$2,302
 <ul style="list-style-type: none"> • use with wall mount overhead storage cabinet • wall mounted • requires a valance, see page AP99 • fabric is railroaded • com ydg: 2 ¾ 	A						\$2,341
	B						\$2,414
	C						\$2,548
	D						\$2,714
	E						\$2,880
	F						\$3,141
	G						\$3,421
	H						\$3,717
	I						\$4,182
	J						\$4,741

72" w Wall Mount Tackboard	1 ¾	72	24	28	4	AM9-HTB-1-2472	COM \$1,779
 <ul style="list-style-type: none"> • use with wall mount overhead storage cabinet • wall mounted • requires a valance, see page AP99 • fabric is railroaded • com ydg: 2 ¼ 	A						\$1,814
	B						\$1,870
	C						\$1,977
	D						\$2,113
	E						\$2,252
	F						\$2,466
	G						\$2,695
	H						\$2,936
	I						\$3,316
	J						\$3,775

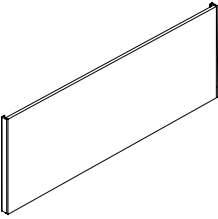
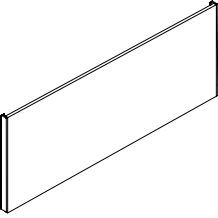
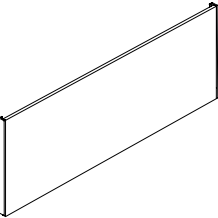
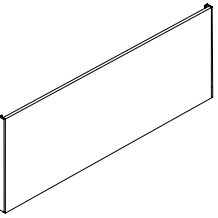
To Order, Specify:

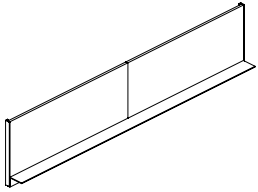
Wall Panel

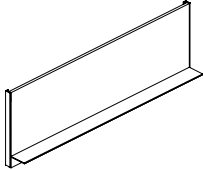
- ① Model Number
- ② Finish Application
 - a.) All Veneer
 - 1.) Wood Species - Makore (MK2), Maple (MA2), Walnut (WA2), Black Oak (BO1) or Double Cut (DC1) ([see page AP32](#))
 - a.) Finish Color ([see page AP32](#))
 - b.) All Paint (PNT)
 - 1.) Paint Color ([see page AP32](#))
 - c.) Magnetic Back Painted Glass

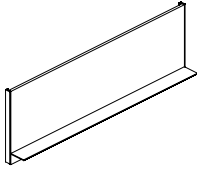
Tackboard

- ① Model Number
- ② Fabric - vendor, pattern, color
 - Visit www.jsi.furniture.com/finishes-and-material/textiles for our textiles program. See selection of standard and graded in manufactures and patterns.

Description	D	W	H	CTN WT	CU FT	① Model	List Price Per Grade
 <ul style="list-style-type: none"> · use with wall mount overhead storage cabinet · wall mounted · requires a valance rail, see page AP99 · fabric is railroaded · com ydg: 2 	1 ¾	60	24	25	4	AM9-HTB-1-2460	COM \$1,690
	A \$1,718						
	B \$1,775						
	C \$1,869						
	D \$1,990						
	E \$2,111						
	F \$2,301						
	G \$2,505						
	H \$2,721						
	I \$3,061						
	J \$3,466						
 <ul style="list-style-type: none"> · use with wall mount overhead storage cabinet · wall mounted · requires a valance rail, see page AP99 · fabric is railroaded · com ydg: 1 ¾ 	1 ¾	54	24	22	3	AM9-HTB-1-2454	COM \$1,604
	A \$1,629						
	B \$1,677						
	C \$1,758						
	D \$1,865						
	E \$1,973						
	F \$2,140						
	G \$2,317						
	H \$2,506						
	I \$2,801						
	J \$3,157						
 <ul style="list-style-type: none"> · use with wall mount overhead storage cabinet · wall mounted · requires a valance rail, see page AP99 · fabric is railroaded · com ydg: 1 ¼ 	1 ¾	36	24	15	2	AM9-HTB-1-2436	COM \$1,516
	A \$1,535						
	B \$1,568						
	C \$1,628						
	D \$1,706						
	E \$1,782						
	F \$1,900						
	G \$2,025						
	H \$2,162						
	I \$2,372						
	J \$2,628						
 <ul style="list-style-type: none"> · use with wall mount overhead storage cabinet · wall mounted · requires a valance rail, see page AP99 · fabric is railroaded · com ydg: 1 	1 ¾	30	24	13	2	AM9-HTB-1-2430	COM \$1,429
	A \$1,445						
	B \$1,470						
	C \$1,519						
	D \$1,581						
	E \$1,642						
	F \$1,737						
	G \$1,835						
	H \$1,946						
	I \$2,113						
	J \$2,318						

Description	D	W	H	CTN WT	CU FT	① Model	List Price Per Grade
108" w Wall Mount Tackboard with Shelf  <ul style="list-style-type: none"> • use with wall mount overhead storage cabinet • wall mounted • requires a valance rail, see page AP99 • anodized aluminum shell • fabric is railroaded • com ydg: 3 ¼ 	6 ¾	108	24	57	15	AM9-HTB-S-24108	COM \$3,825 A \$3,869 B \$3,957 C \$4,111 D \$4,310 E \$4,509 F \$4,816 G \$5,145 H \$5,497 I \$6,048 J \$6,709

90" w Wall Mount Tackboard with Shelf  <ul style="list-style-type: none"> • use with wall mount overhead storage cabinet • wall mounted • requires a valance rail, see page AP99 • anodized aluminum shelf • fabric is railroaded • com ydg: 2 ¾ 	6 ¾	90	24	48	13	AM9-HTB-S-2490	COM \$3,542 A \$3,580 B \$3,653 C \$3,783 D \$3,950 E \$4,118 F \$4,378 G \$4,658 H \$4,954 I \$5,423 J \$5,979
---	-----	----	----	----	----	-----------------------	--

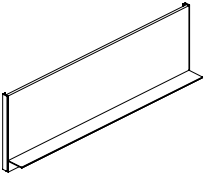
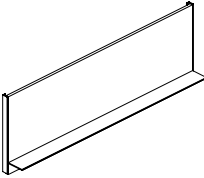
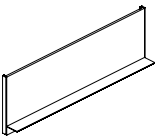
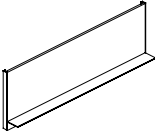
72" w Wall Mount Tackboard with Shelf  <ul style="list-style-type: none"> • use with wall mount overhead storage cabinet • wall mounted • requires a valance rail, see page AP99 • anodized aluminum shelf • fabric is railroaded • com ydg: 2 ¼ 	6 ¾	72	24	38	10	AM9-HTB-S-2472	COM \$2,971 A \$3,004 B \$3,065 C \$3,171 D \$3,307 E \$3,444 F \$3,660 G \$3,888 H \$4,130 I \$4,510 J \$4,968
---	-----	----	----	----	----	-----------------------	--

To Order, Specify:

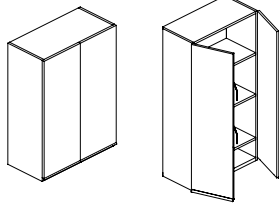
① Model Number

② Fabric - vendor, pattern, color

Visit www.jsi.furniture.com/finishes-and-material/textiles for our textiles program. See selection of standard and graded in manufactures and patterns.

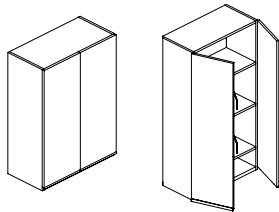
Description	D	W	H	CTN WT	CU FT	① Model	List Price Per Grade			
60" w Wall Mount Tackboard with Shelf  <ul style="list-style-type: none"> · use with wall mount overhead storage cabinet · wall mounted · requires a valance rail, see page AP99 · anodized aluminum shelf · fabric is railroaded · com ydg: 2 	6 ¾	60	24	32	8	AM9-HTB-S-2460	COM \$2,840 A \$2,868 B \$2,923 C \$3,019 D \$3,138 E \$3,261 F \$3,450 G \$3,655 H \$3,869 I \$4,211 J \$4,616			
	54" w Wall Mount Tackboard with Shelf  <ul style="list-style-type: none"> · use with wall mount overhead storage cabinet · wall mounted · requires a valance rail, see page AP99 · anodized aluminum shelf · fabric is railroaded · com ydg: 1 ¾ 	6 ¾	54	24	30	8	AM9-HTB-S-2454	COM \$2,674 A \$2,698 B \$2,745 C \$2,828 D \$2,935 E \$3,042 F \$3,209 G \$3,385 H \$3,576 I \$3,869 J \$4,225		
		36" w Wall Mount Tackboard with Shelf  <ul style="list-style-type: none"> · use with wall mount overhead storage cabinet · wall mounted · requires a valance rail, see page AP99 · anodized aluminum shelf · fabric is railroaded · com ydg: 1 ¼ 	6 ¾	36	24	20	5	AM9-HTB-S-2436	COM \$2,484 A \$2,503 B \$2,534 C \$2,596 D \$2,673 E \$2,749 F \$2,865 G \$2,992 H \$3,129 I \$3,339 J \$3,594	
			30" w Wall Mount Tackboard with Shelf  <ul style="list-style-type: none"> · use with wall mount overhead storage cabinet · wall mounted · requires a valance, see page AP99 · anodized aluminum shelf · fabric is railroaded · com ydg: 1 	6 ¾	30	24	17	4	AM9-HTB-S-2430	COM \$2,411 A \$2,427 B \$2,453 C \$2,500 D \$2,561 E \$2,623 F \$2,717 G \$2,818 H \$2,927 I \$3,097 J \$3,299

Description	D	W	H	CTN WT	CU FT	① Model	List Price
56" h Storage Tower with Doors	18	30	56	165	22	AP5-OCS-TD-1830	\$4,221



- use with 56" h overhead and two-high storage
- legal depth storage
- top shelf adjustable
- two fixed shelves
- stand-up wire dividers
- soft close hinge doors
- locking doors available, specify and add \$142 list

56" h Storage Tower with Doors	15	30	56	151	19	AP5-OCS-T1-1530	\$4,078
--------------------------------	----	----	----	-----	----	-----------------	---------



- use with 56" h overhead and two-high storage
- letter depth storage
- top shelf adjustable
- two fixed shelves
- stand-up wire dividers
- soft close hinge doors
- locking doors available, specify and add \$142 list

To Order, Specify:

Wall Mount Tackboard

- ① Model Number
- ② Fabric - vendor, pattern, color

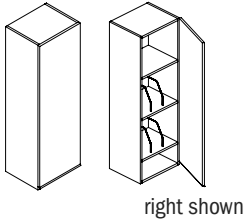
Storage Tower

- ① Model Number
- ② Finish Application
 - a.) All Veneer
 - 1.) Wood Species - Makore (MK2), Maple (MA2), Walnut (WA2), Black Oak (BO1) or Double Cut (DC1) ([see page AP32](#))
 - a.) Finish Color ([see page AP32](#))
 - b.) All Paint (PNT)
 - 1.) Paint Color ([see page AP32](#))

- c.) Veneer/Paint Combination
 - 1.) Chassis Wood Species/Paint - Makore (MK2), Maple (MA2), Walnut (WA2), Black Oak (BO1), Double Cut (DC1) or Paint (PNT) ([see page AP32](#))
 - a.) Finish Color for Chassis ([see page AP32](#))
 - 2.) Door Wood Species/Paint - Makore (MK2), Maple (MA2), Black Oak (BO1), Walnut (WA2), Double Cut (DC1) or Paint (PNT) ([see page AP32](#))
 - a.) Finish Color for Door ([see page AP32](#))

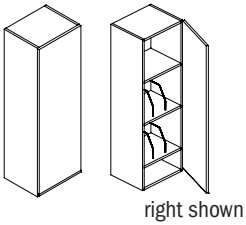
Note: Only one wood finish and one paint color can be specified per unit

Description	D	W	H	CTN WT	CU FT	① Model	List Price
56" h Storage Tower with Door	18	18	56	113	14	AP5-OCS-TD-1818R	\$3,204
	18	18	56	113	14	AP5-OCS-TD-1818L	\$3,204



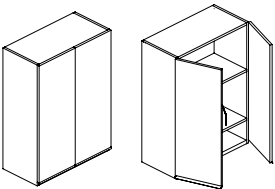
- use with 56" overhead and two-high storage
- legal depth storage
- top shelf adjustable
- two fixed shelves
- stand-up wire dividers
- soft close hinge doors
- locking door available, specify and add \$142 list

56" h Storage Tower with Door	15	18	56	102	12	AP5-OCS-T1-1518R	\$3,058
	15	18	56	102	12	AP5-OCS-T1-1518L	\$3,058



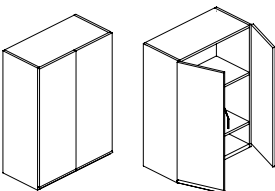
- use with 56" overhead and two-high storage
- letter depth storage
- top shelf adjustable
- two fixed shelves
- stand-up wire dividers
- soft close hinge doors
- locking door available, specify and add \$142 list

41" h Storage Tower with Doors	18	30	41	126	16	AP5-OCS-1D-1830	\$3,931
--------------------------------	----	----	----	-----	----	-----------------	---------



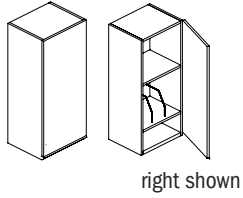
- use with 41" overhead and two-high storage
- legal depth storage
- top shelf adjustable
- one fixed shelf
- stand-up wire dividers
- soft close hinge doors
- locking door available, specify and add \$142 list

41" h Storage Tower with Doors	15	30	41	115	14	AP5-OCS-1-1530	\$3,785
--------------------------------	----	----	----	-----	----	----------------	---------



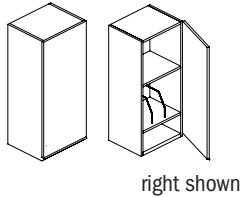
- use with 41" overhead and two-high storage
- letter depth storage
- top shelf adjustable
- one fixed shelf
- stand-up wire dividers
- soft close hinge doors
- locking door available, specify and add \$142 list

Description	D	W	H	CTN WT	CU FT	① Model	List Price
41" h Storage Tower with Door	18	18	41	86	10	AP5-OCS-1D-1818R	\$2,911
	18	18	41	86	10	AP5-OCS-1D-1818L	\$2,911



- use with 41" h overhead and two-high storage
- legal depth storage
- top shelf adjustable
- one fixed shelf
- stand-up wire dividers
- soft close hinge doors
- locking door available, specify and add \$142 list

41" h Storage Tower with Door	15	18	41	78	9	AP5-OCS-1-1518R	\$2,767
	15	18	41	78	9	AP5-OCS-1-1518L	\$2,767



- use with 41" h overhead and two-high storage
- letter depth storage
- top shelf adjustable
- one fixed shelf
- stand-up wire dividers
- soft close hinge doors
- locking door available, specify and add \$142 list

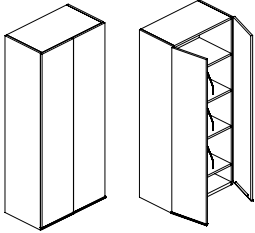
To Order, Specify:

- ① Model Number
- ② Finish Application
 - a.) All Veneer
 - 1.) Wood Species - Makore (MK2), Maple (MA2), Walnut (WA2), Black Oak (BO1), or Double Cut (DC1) ([see page AP32](#))
 - a.) Finish Color ([see page AP32](#))
 - b.) All Paint (PNT)
 - 1.) Paint Color ([see page AP32](#))
 - c.) Veneer/Paint Combination
 - 1.) Chassis Wood Species/Paint - Makore (MK2), Maple (MA2), Walnut (WA2), Black Oak (BO1), Double Cut (DC1) or Paint (PNT) ([see page AP32](#))
 - a.) Finish Color for Chassis ([see page AP32](#))
 - 2.) Door Wood Species/Paint - Makore (MK2), Maple (MA2), Walnut (WA2), Black Oak (BO1), Double Cut (DC1) or Paint (PNT) ([see page AP32](#))
 - a.) Finish Color for Door ([see page AP32](#))

Note: Only one wood finish and one paint color can be specified per unit

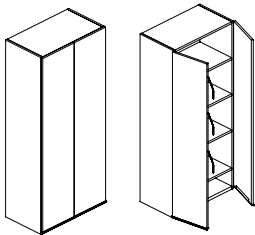
APOGEE™

Description	D	W	H	CTN WT	CU FT	① Model	List Price
68½" h Storage Tower with Doors	18	30	68½	200	26	AP5-OCT-TD-1830	\$4,193



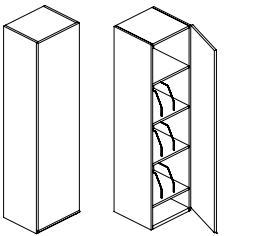
- use with 56" h overhead and one-high storage
- legal depth storage
- top shelf adjustable
- three fixed shelves
- stand-up wire dividers
- soft close hinge doors
- locking door available, specify and add \$142 list

68½" h Storage Tower with Doors	15	30	68½	183	23	AP5-OCT-T1-1530	\$4,046
---------------------------------	----	----	-----	-----	----	-----------------	---------



- use with 56" h overhead and one-high storage
- letter depth storage
- top shelf adjustable
- three fixed shelves
- stand-up wire dividers
- soft close hinge doors
- locking door available, specify and add \$142 list

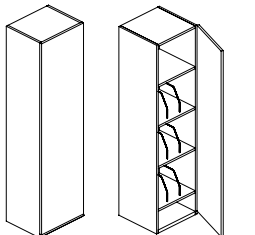
68½" h Storage Tower with Door	18	18	68½	137	17	AP5-OCT-TD-1818R	\$3,466
	18	18	68½	137	17	AP5-OCT-TD-1818L	\$3,466



right shown

- use with 56" h overhead and one-high storage
- legal depth storage
- top shelf adjustable
- three fixed shelves
- stand-up wire dividers
- soft close hinge doors
- locking door available, specify and add \$142 list

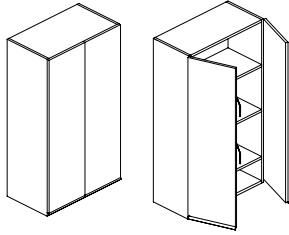
68½" h Storage Tower with Door	15	18	68½	124	14	AP5-OCT-T1-1518R	\$3,319
	15	18	68½	124	14	AP5-OCT-T1-1518L	\$3,319



right shown

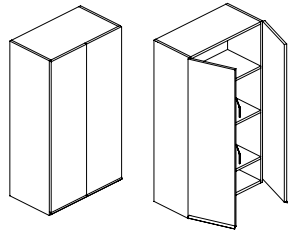
- use with 56" h overhead and one-high storage
- letter depth storage
- top shelf adjustable
- three fixed shelves
- stand-up wire dividers
- soft close hinge doors
- locking door available, specify and add \$142 list

Description	D	W	H	CTN WT	CU FT	① Model	List Price
53 ½" h Storage Tower with Doors	18	30	53 ½	161	21	AP5-OCT-1D-1830	\$3,756



- use with 41" h overhead and one-high storage
- legal depth storage
- top shelf adjustable
- two fixed shelves
- stand-up wire dividers
- soft close hinge doors
- locking doors available, specify and add \$142 list

53 ½" h Storage Tower with Doors	15	30	53 ½	146	18	AP5-OCT-1-1530	\$3,611
----------------------------------	----	----	------	-----	----	----------------	---------



- use with 41" h overhead and one-high storage
- letter depth storage
- top shelf adjustable
- two fixed shelves
- stand-up wire dividers
- soft close hinge doors
- locking doors available, specify and add \$142 list

To Order, Specify:

① Model Number

② Finish Application

a.) All Veneer

- 1.) Wood Species - Makore (MK2), Maple (MA2), Walnut (WA2), Black Oak (BO1) or Double Cut (DC1) [\(see page AP32\)](#)

a.) Finish Color [\(see page AP32\)](#)

b.) All Paint (PNT)

- 1.) Paint Color [\(see page AP32\)](#)

c.) Veneer/Paint Combination

- 1.) Chassis Wood Species/Paint - Makore (MK2), Maple (MA2), Walnut (WA2), Black Oak (BO1), Double Cut (DC1) or Paint (PNT) [\(see page AP32\)](#)

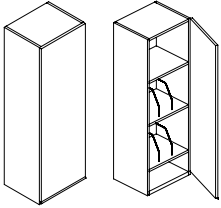
a.) Finish Color for Chassis [\(see page AP32\)](#)

- 2.) Door Wood Species/Paint - Makore (MK2), Maple (MA2), Walnut (WA2), Black Oak (BO1), Double Cut (DC1) or Paint (PNT) [\(see page AP32\)](#)

a.) Finish Color for Door [\(see page AP32\)](#)

Note: Only one wood finish and one paint color can be specified per unit

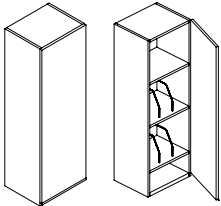
Description	D	W	H	CTN WT	CU FT	① Model	List Price
53½" h Storage Tower with Doors	18	18	53½	110	13	AP5-OCT-1D-1818R	\$3,029
	18	18	53½	110	13	AP5-OCT-1D-1818L	\$3,029



right shown

- use with 41" h overhead and one-high storage
- legal depth storage
- top shelf adjustable
- two fixed shelves
- stand-up wire dividers
- soft close hinge doors
- locking door available, specify and add \$142 list

53½" h Storage Tower with Doors	15	18	53½	99	11	AP5-OCT-1-1518R	\$2,884
	15	18	53½	99	11	AP5-OCT-1-1518L	\$2,884

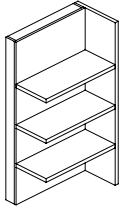


right shown

- use with 41" h overhead and one-high storage
- letter depth storage
- top shelf adjustable
- two fixed shelves
- stand-up wire dividers
- soft close hinge doors
- locking door available, specify and add \$142 list

APOGEE™

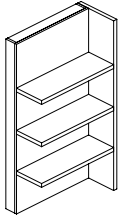
Description	D	W	H	CTN WT	CU FT	① Model	List Price
56" h Asymmetric Shelves	17	30	56	109	21	AP5-OAS-TD-1730R	\$2,717
	17	30	56	109	21	AP5-OAS-TD-1730L	\$2,717



left shown

- use with 56" h overhead and two-high storage
- match with legal depth storage
- shelf depth: 12 1/2"

56" h Asymmetric Shelves	14	30	56	100	17	AP5-OAS-T1-1430R	\$2,571
	14	30	56	100	17	AP5-OAS-T1-1430L	\$2,571



left shown

- use with 56" h overhead and two-high storage
- match with letter depth storage
- shelf depth: 10"

To Order, Specify:

Storage Tower

- ① Model Number
- ② Finish Application
 - a.) All Veneer
 - 1.) Wood Species - Makore (MK2), Maple (MA2), Walnut (WA2), Black Oak (BO1) or Double Cut (DC1) ([see page AP32](#))
 - a.) Finish Color ([see page AP32](#))
 - b.) All Paint (PNT)
 - 1.) Paint Color ([see page AP32](#))

c.) Veneer/Paint Combination

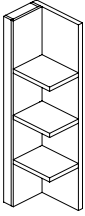
- 1.) Chassis Wood Species/Paint - Makore (MK2), Maple (MA2), Walnut (WA2), Black Oak (BO1), Double Cut (DC1) or Paint (PNT) ([see page AP32](#))
 - a.) Finish Color for Chassis ([see page AP32](#))
- 2.) Door Wood Species/Paint - Makore (MK2), Maple (MA2), Walnut (WA2), Black Oak (BO1), Double Cut (DC1) or Paint (PNT) ([see page AP32](#))
 - a.) Finish Color for Door ([see page AP32](#))

Shelves

- ① Model Number
- ② Wood Species/Paint - Makore (MK2), Maple (MA2), Walnut (WA2), Black Oak (BO1), Double Cut (DC1) or Paint (PNT) ([see page AP32](#))
- ③ Finish Color

Note: Only one wood finish and one paint color can be specified per unit

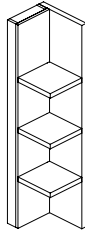
Description	D	W	H	CTN WT	CU FT	① Model	List Price
56" h Asymmetric Shelves	17	12	56	57	9	AP5-OAS-TD-1712R	\$2,281
	17	12	56	57	9	AP5-OAS-TD-1712L	\$2,281



left shown

- use with 56 1/2" h overhead and two-high storage
- match with legal depth storage
- shelf depth: 12 1/2"

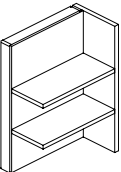
56" h Asymmetric Shelves	14	12	56	49	8	AP5-OAS-T1-1412R	\$2,136
	14	12	56	49	8	AP5-OAS-T1-1412L	\$2,136



left shown

- use with 56" h overhead and two-high storage
- match with letter depth storage
- shelf depth: 10"

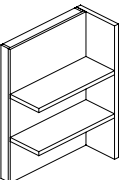
41" h Asymmetric Shelves	17	30	41	78	15	AP5-OAS-1D-1730R	\$2,499
	17	30	41	78	15	AP5-OAS-1D-1730L	\$2,499



left shown

- use with 41" h overhead and two-high storage
- match with legal depth storage
- shelf depth: 12 1/2"

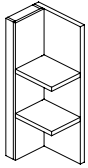
41" h Asymmetric Shelves	14	30	41	73	13	AP5-OAS-1-1430R	\$2,352
	14	30	41	73	13	AP5-OAS-1-1430L	\$2,352



left shown

- use with 41" h overhead and two-high storage
- match with letter depth storage
- shelf depth: 10"

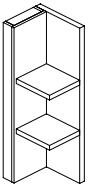
Description	D	W	H	CTN WT	CU FT	① Model	List Price
41" h Asymmetric Shelves	17	12	41	46	7	AP5-OAS-1D-1712R	\$2,062
	17	12	41	46	7	AP5-OAS-1D-1712L	\$2,062



left shown

- use with 41" h overhead and two-high storage
- match with legal depth storage
- shelf depth: 12 1/2"

41" h Asymmetric Shelves	14	12	41	41	6	AP5-OAS-1-1412R	\$1,916
	14	12	41	41	6	AP5-OAS-1-1412L	\$1,916



left shown

- use with 41" h overhead and two-high storage
- match with letter depth storage
- shelf depth: 10"

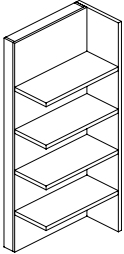
To Order, Specify:

- ① Model Number
- ② Wood Species/Paint - Makore (MK2), Maple (MA2)
Walnut (WA2), Black Oak (BO1), Double Cut (DC1)
or Paint (PNT)
(see page AP32)
- ③ Finish Color

Note: Only one wood finish and one paint color can be specified per unit

APOGEE™

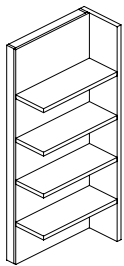
Description	D	W	H	CTN WT	CU FT	① Model	List Price
68½" Asymmetric Shelves	17	30	68½	140	25	AP5-OAT-TD-1730R	\$2,834
	17	30	68½	140	25	AP5-OAT-TD-1730L	\$2,834



left shown

- use with 56" overhead and one-high storage
- match with legal depth storage
- shelf depth: 12 ½"

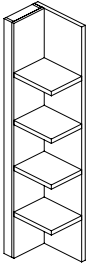
68½" Asymmetric Shelves	14	30	68½	129	21	AP5-OAT-T1-1430R	\$2,687
	14	30	68½	129	21	AP5-OAT-T1-1430L	\$2,687



left shown

- use with 56" overhead and one-high storage
- match with letter depth storage
- shelf depth: 10"

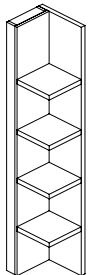
68½" Asymmetric Shelves	17	12	68½	70	11	AP5-OAT-TD-1712R	\$2,325
	17	12	68½	70	11	AP5-OAT-TD-1712L	\$2,325



left shown

- use with 56" overhead and one-high storage
- match with legal depth storage
- shelf depth: 12 ½"

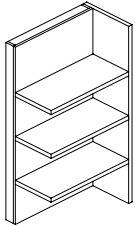
68½" Asymmetric Shelves	14	12	68½	63	9	AP5-OAT-T1-1412R	\$2,179
	14	12	68½	63	9	AP5-OAT-T1-1412L	\$2,179



left shown

- use with 56" overhead and one-high storage
- match with letter depth storage
- shelf depth: 10"

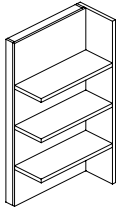
Description	D	W	H	CTN WT	CU FT	❶ Model	List Price
53 ½" h Asymmetric Shelves	17	30	53 ½	109	20	AP5-OAT-1D-1730R	\$2,542
	17	30	53 ½	109	20	AP5-OAT-1D-1730L	\$2,542



left shown

- use with 41" h overhead and one-high storage
- match with legal depth storage
- shelf depth: 12 ½"

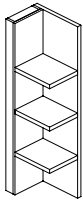
53 ½" h Asymmetric Shelves	14	30	53 ½	103	17	AP5-OAT-1-1430R	\$2,398
	14	30	53 ½	103	17	AP5-OAT-1-1430L	\$2,398



left shown

- use with 41" h overhead and one-high storage
- match with legal depth storage
- shelf depth: 10"

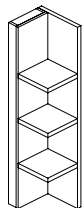
53 ½" h Asymmetric Shelves	17	12	53 ½	57	9	AP5-OAT-1D-1712R	\$2,107
	17	12	53 ½	57	9	AP5-OAT-1D-1712L	\$2,107



left shown

- use with 41" h overhead and one-high storage
- match with legal depth storage
- shelf depth: 12 ½"

53 ½" Asymmetric Shelves	14	12	53 ½	52	7	AP5-OAT-1-1412R	\$1,960
	14	12	53 ½	52	7	AP5-OAT-1-1412L	\$1,960



left shown

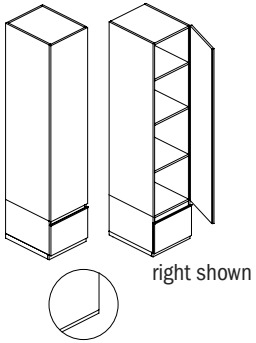
- use with 41" h overhead and one-high storage
- match with legal depth storage
- shelf depth: 10"

To Order, Specify:

- ❶ Model Number
- ❷ Wood Species/Paint - Makore (MK2), Maple (MA2)
Walnut (WA2), Black Oak (BO1), Double Cut (DC1)
or Paint (PNT) ([see page AP32](#))
- ❸ Finish Color

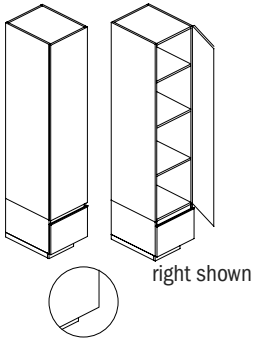
Note: Only one wood finish and one paint color can be specified per unit

Description	D	W	H	CTN WT	CU FT	① Model	List Price
85 1/2" h Storage Unit with Drawer and Flush Base	22	18	85 1/2	214	25	AP6-DDT-B-2218R	\$5,386
	22	18	85 1/2	214	25	AP6-DDT-B-2218L	\$5,386



- base is flush
- three adjustable shelves
- pedestal front locking
- door side has concealed bevel for opening
- soft close hinge door
- locking door available, specify and add \$142 list
- adjustable levelers/glides

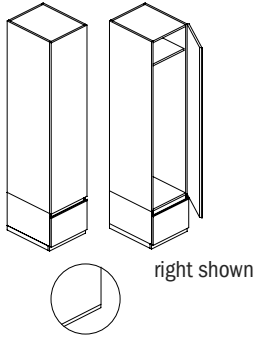
85 1/2" h Storage Unit with Drawer and Inset Base	22	18	85 1/2	211	25	AP6-DDT-BR-2218R	\$5,386
	22	18	85 1/2	211	25	AP6-DDT-BL-2218L	\$5,386



- base is inset on one side
- three adjustable shelves
- pedestal front locking
- door side has concealed bevel for opening
- soft close hinge door
- locking door available, specify and add \$142 list
- adjustable levelers/glides

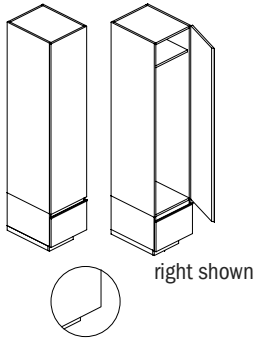
must be mounted

Description	D	W	H	CTN WT	CU FT	① Model	List Price
85 ½" h Wardrobe Unit with Drawer and Flush Base	22	18	85 ½	201	25	AP6-DDT-A-2218R	\$5,123
	22	18	85 ½	201	25	AP6-DDT-A-2218L	\$5,123



- base is flush
- fixed shelf
- hanging bar
- pedestal front locking
- door side has concealed bevel for opening
- soft close hinge door
- locking door available, specify and add \$142 list
- adjustable leveler/glides

85 ½" h Wardrobe Unit with Drawer and Inset Base	22	18	85 ½	198	25	AP6-DDT-AR-2218R	\$5,123
	22	18	85 ½	198	25	AP6-DDT-AL-2218L	\$5,123



- base is inset on one side
- fixed shelf
- hanging bar
- pedestal front locking
- door side has concealed bevel for opening
- soft close hinge door
- locking door available, specify and add \$142 list
- adjustable leveler/glides

must be mounted

To Order, Specify:

① Model Number

② Finish Application

a.) All Veneer

- 1.) Wood Species - Makore (MK2), Maple (MA2), Walnut (WA2), Black Oak (BO1) or Double Cut (DC1) (see page AP32)

a.) Finish Color (see page AP32)

b.) All Paint (PNT)

- 1.) Paint Color (see page AP32)

c.) Veneer/Paint Combination

- 1.) Upper Chassis Wood Species/Paint - Makore (MK2), Maple (MA2), Walnut (WA2), Black Oak (BO1), Double Cut (DC1) or Paint (PNT) (see page AP32)

a.) Finish Color for Upper Chassis (see page AP32)

- 2.) Lower Chassis Wood Species/Paint - Makore (MK2), Maple (MA2), Walnut (WA2), Double Cut (DC1) or Paint (PNT) (see page AP32)

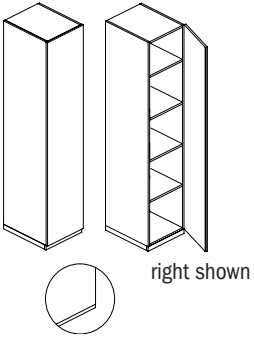
a.) Finish Color for Lower Chassis (see page AP32)

Note: Only one wood finish and one paint color can be specified per unit

3.) Finish Color for Base

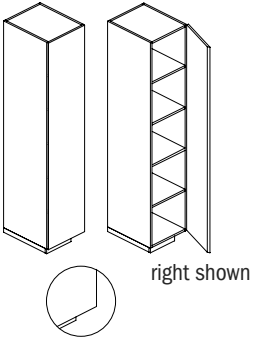
- a.) Same as Upper Chassis
- b.) Same as Lower Chassis
- c.) Paint

Description	D	W	H	CTN WT	CU FT	① Model	List Price
85 1/2" h Storage Unit with Flush Base	22	18	85 1/2	195	25	AP6-ADT-2-2218R	\$4,599
	22	18	85 1/2	195	25	AP6-ADT-2-2218L	\$4,599



- base is flush
- four adjustable shelves
- door side has concealed bevel for opening
- soft close hinge door
- locking door available, specify and add \$142 list
- adjustable levelers/glides

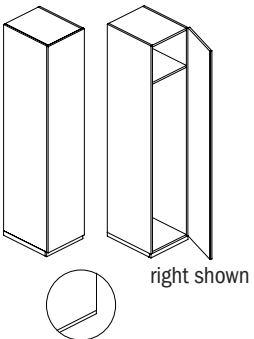
85 1/2" h Storage Unit with Inset Base	22	18	85 1/2	192	25	AP6-ADT-2R-2218R	\$4,599
	22	18	85 1/2	192	25	AP6-ADT-2L-2218L	\$4,599



- base is inset on one side
- four adjustable shelves
- door side has concealed bevel for opening
- soft close hinge door
- locking door available, specify and add \$142 list
- adjustable levelers/glides

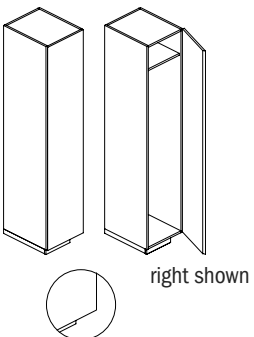
must be mounted

85 1/2" h Wardrobe Unit with Flush Base	22	18	85 1/2	176	25	AP6-ADT-1-2218R	\$4,250
	22	18	85 1/2	176	25	AP6-ADT-1-2218L	\$4,250



- base is flush
- fixed shelf
- hanging bar
- door side has concealed bevel for opening
- soft close hinge door
- locking door available, specify and add \$142 list
- adjustable leveler/glides

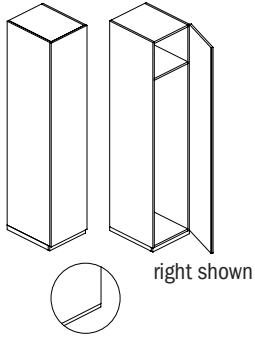
85 1/2" h Wardrobe Unit with Inset Base	22	18	85 1/2	172	25	AP6-ADT-1R-2218R	\$4,250
	22	18	85 1/2	172	25	AP6-ADT-1L-2218L	\$4,250



- base is inset on one side
- fixed shelf
- hanging bar
- door side has concealed bevel for opening
- soft close hinge door
- locking door available, specify and add \$142 list
- adjustable leveler/glides

must be mounted

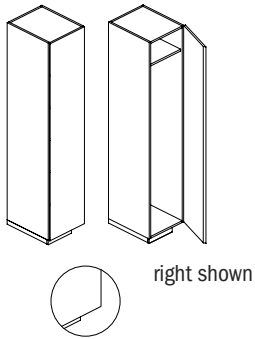
Description	D	W	H	CTN WT	CU FT	① Model	List Price
85 ½" h Wardrobe Unit with Flush Base	22	12	85 ½	141	17	AP6-ADT-1-2212R	\$3,741
	22	12	85 ½	141	17	AP6-ADT-1-2212L	\$3,741



- base is flush
- fixed shelf
- coat hook
- door side has concealed bevel for opening
- soft close hinge door
- locking door available, specify and add \$142 list
- adjustable leveler/glides

must be mounted
 Note: Not a Freestanding Unit

85 ½" h Wardrobe Unit with Inset Base	22	12	85 ½	138	17	AP6-ADT-1R-2212R	\$3,741
	22	12	85 ½	138	17	AP6-ADT-1L-2212L	\$3,741



- base is inset on one side
- fixed shelf
- coat hook
- door side has concealed bevel for opening
- soft close hinge door
- locking door available, specify and add \$142 list
- adjustable leveler/glides

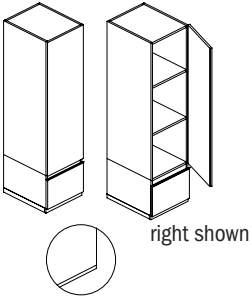
must be mounted
 Note: Not a Freestanding Unit

To Order, Specify:

- ① Model Number
- ② Wood Species/Paint on Chassis/Door Fronts -
 Makore (MK2), Maple (MA2), Walnut (WA2),
 Black Oak (BO1), Double Cut (DC1) or Paint (PNT)
 (see page AP32)
- ③ Finish Color for Chassis/Door Fronts
 (see page AP32)
- ④ Finish Color for Base
 - a.) Same as Chassis/Drawer Front
 - b.) Paint (see page AP32)

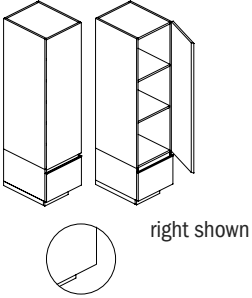
Note: Only one wood finish and one paint color can be specified per unit

Description	D	W	H	CTN WT	CU FT	① Model	List Price
70 1/2" h Storage Unit with Drawer and Flush Base	22	18	70 1/2	182	20	AP6-DDS-B-2218R	\$4,862
	22	18	70 1/2	182	20	AP6-DDS-B-2218L	\$4,862



- base is flush
- two adjustable shelves
- pedestal front locking
- door side has concealed bevel for opening
- soft close hinge door
- locking door available, specify and add \$142 list
- adjustable levelers/glides

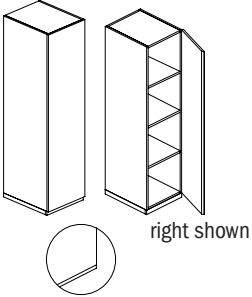
70 1/2" h Storage Unit with Drawer and Inset Base	22	18	70 1/2	179	20	AP6-DDS-BR-2218R	\$4,862
	22	18	70 1/2	179	20	AP6-DDS-BL-2218L	\$4,862



- base is inset on one side
- two adjustable shelves
- pedestal front locking
- door side has concealed bevel for opening
- soft close hinge door
- locking door available, specify and add \$142 list
- adjustable levelers/glides

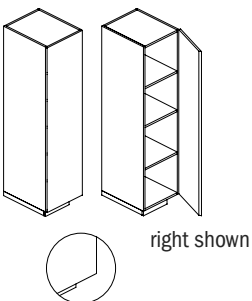
must be mounted

70 1/2" h Storage Unit with Flush Base	22	18	70 1/2	163	20	AP6-ADS-2-2218R	\$4,078
	22	18	70 1/2	163	20	AP6-ADS-2-2218L	\$4,078



- base is flush
- three adjustable shelves
- door side has concealed bevel for opening
- soft close hinge door
- locking door available, specify and add \$142 list
- adjustable levelers/glides

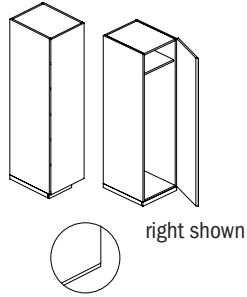
70 1/2" h Storage Unit with Inset Base	22	18	70 1/2	160	20	AP6-ADS-2R-2218R	\$4,078
	22	18	70 1/2	160	20	AP6-ADS-2L-2218L	\$4,078



- base is inset on one side
- three adjustable shelves
- door side has concealed bevel for opening
- soft close hinge door
- locking door available, specify and add \$142 list
- adjustable levelers/glides

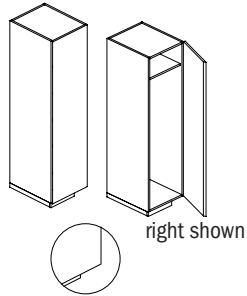
must be mounted

Description	D	W	H	CTN WT	CU FT	① Model	List Price
70 ½" h Wardrobe Unit with Flush Base	22	18	70 ½	150	20	AP6-ADS-1-2218R	\$3,816
	22	18	70 ½	150	20	AP6-ADS-1-2218L	\$3,816



- base is flush
- fixed shelf
- hanging bar
- door side has concealed bevel for opening
- soft close hinge door
- locking door available, specify and add \$142 list
- adjustable leveler/glides

70 ½" h Wardrobe Unit with Inset Base	22	18	70 ½	147	20	AP6-ADS-1R-2218R	\$3,816
	22	18	70 ½	147	20	AP6-ADS-1L-2218L	\$3,816



- base is inset on one side
- fixed shelf
- hanging bar
- door side has concealed bevel for opening
- soft close hinge door
- locking door available, specify and add \$142 list
- adjustable leveler/glides

must be mounted

To Order, Specify:

① Model Number

② Finish Application

a.) All Veneer

- 1.) Wood Species - Makore (MK2), Maple (MA2), Walnut (WA2), Black Oak (BO1) or Double Cut (DC1) (see page AP32)

a.) Finish Color (see page AP32)

b.) All Paint (PNT)

- 1.) Paint Color (see page AP32)

c.) Veneer/Paint Combination

1.) Upper Chassis Wood Species/Paint -

- Makore (MK2), Maple (MA2), Walnut (WA2), Black Oak (BO1), Double Cut (DC1) or Paint (PNT) (see page AP32)

a.) Finish Color for Upper Chassis (see page AP32)

2.) Lower Chassis Wood Species/Paint -

- Makore (MK2), Maple (MA2), Walnut (WA2), Black Oak (BO1), Double Cut (DC1) or Paint (PNT) (see page AP32)

a.) Finish Color for Lower Chassis (see page AP32)

3.) Finish Color for Base -

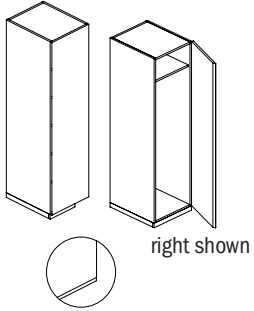
a.) Same as Upper Chassis

b.) Same as Lower Chassis

c.) Paint

Note: Only one wood finish and one paint color can be specified per unit

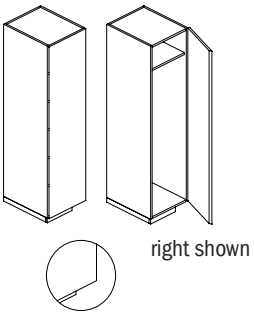
Description	D	W	H	CTN WT	CU FT	① Model	List Price
70 1/2" h Wardrobe Unit with Flush Base	22	12	70 1/2	120	14	AP6-ADS-1-2212R	\$3,379
	22	12	70 1/2	120	14	AP6-ADS-1-2212L	\$3,379



- base is flush
- fixed shelf
- coat hook
- door side has concealed bevel for opening
- soft close hinge door
- locking door available, specify and add \$142 list
- adjustable leveler/glides

must be mounted

70 1/2" h Wardrobe Unit with Inset Base	22	12	70 1/2	117	14	AP6-ADS-1R-2212R	\$3,379
	22	12	70 1/2	117	14	AP6-ADS-1L-2212L	\$3,379

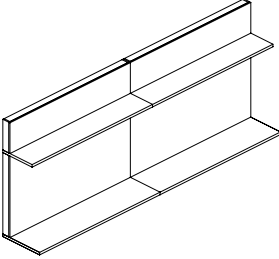


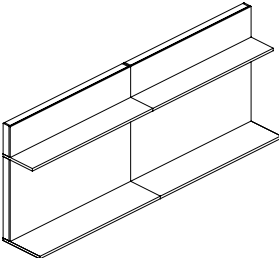
- base is inset on one side
- fixed shelf
- coat hook
- door side has concealed bevel for opening
- soft close hinge door
- locking door available, specify and add \$142 list
- adjustable leveler/glides

To Order, Specify:

- ① Model Number
- ② Wood Species/Paint on Chassis/Door Fronts -
Makore (MK2), Maple (MA2), Walnut (WA2),
Black Oak (BO1), Double Cut (DC1) or Paint (PNT)
(see page AP32)
- ③ Finish Color for Chassis/Door Fronts
(see page AP32)
- ④ Finish Color for Base
 - a.) Same as Chassis/Drawer Front
 - b.) Paint (see page AP32)

Note: Only one wood finish and one paint color can be specified per unit

Description	D	W	H	CTN WT	CU FT	① Model	List Price
144" w Dual Open Workwall with Shelf  <ul style="list-style-type: none"> • wall mounted • workwall top included (17 ¾" deep) • one fixed shelf • shipped in four sections • finish scheme <ul style="list-style-type: none"> -workwall top - veneer only -chassis and shelves - veneer or paint • two grommets 31" off center of each section of the workwall available, specify and add \$228 list • aluminum mini shelf available, specify and add \$2,170 list; an insert back panel is required when ordering a mini shelf • back insert panel between shelf and top available, indicate selection on order and select appropriate list price; panel reduces workwall by 1" <ul style="list-style-type: none"> -veneer panel -paint panel -magnetic back painted white glass with thin aluminum frame and 6 magnets -tackable fabric panel - com ydg: 5 <p>Note: use insert panel when wanting to add contrast</p>	22	144	57	568	124	AM4-CWO-SP-22144	W/O PANEL \$15,245 VENEER PANEL \$17,484 PAINT PANEL \$17,484 GLASS PANEL \$22,031 FABRIC PANEL COM \$16,664 A \$16,736 B \$16,868 C \$17,108 D \$17,414 E \$17,715 F \$18,189 G \$18,699 H \$19,241 I \$20,086 J \$21,101

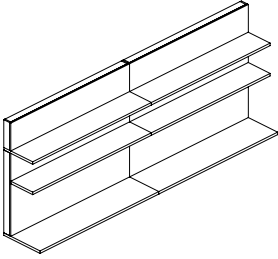
120" w Dual Open Workwall with Shelf  <ul style="list-style-type: none"> • wall mounted • workwall top included (17 ¾" deep) • one fixed shelf • shipped in four sections • finish scheme <ul style="list-style-type: none"> -workwall top - veneer only -chassis and shelves - veneer or paint • two grommets 25" off center of each section of the workwall available, specify and add \$228 list • aluminum mini shelf available, specify and add \$2,088 list; an insert back panel is required when ordering a mini shelf • back insert panel between shelf and top available, indicate selection on order and select appropriate list price; panel reduces workwall by 1" <ul style="list-style-type: none"> -veneer panel -paint panel -magnetic back painted white glass with thin aluminum frame and 6 magnets -tackable fabric panel - com ydg: 4 ½" <p>Note: use insert panel when wanting to add contrast</p>	22	120	57	474	104	AM4-CWO-SP-22120	W/O PANEL \$14,199 VENEER PANEL \$16,176 PAINT PANEL \$16,176 GLASS PANEL \$19,648 FABRIC PANEL COM \$15,550 A \$15,612 B \$15,732 C \$15,947 D \$16,222 E \$16,493 F \$16,922 G \$17,379 H \$17,863 I \$18,626 J \$19,540
---	----	-----	----	-----	-----	-------------------------	---

To Order, Specify:

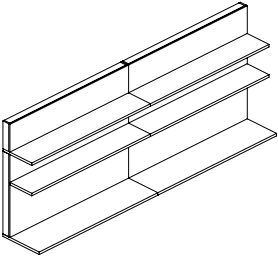
- ① Model Number
- ② Wood Species on Top - Makore (MK2), Maple (MA2)
Walnut (WA2), Black Oak (BO1) or Double Cut (DC1) [\(see page AP32\)](#)
- ③ Finish Color for Top [\(see page AP32\)](#)
- ④ Finish Color for Chassis/Shelves
 - a.) Same as Top
 - b.) Paint Color [\(see page AP32\)](#)
- ⑤ Insert Panel
 - a.) Veneer
 - 1.) Wood Species - Makore (MK2), Maple (MA2), Walnut (WA2), Black Oak (BO1) or Double Cut (DC1) [\(see page AP32\)](#)
 - a.) Finish Color [\(see page AP32\)](#)
 - b.) Paint (PNT)
 - 1.) Paint Color [\(see page AP32\)](#)
 - c.) Back Painted Magnetic Glass
 - d.) Fabric - vendor, pattern, color

Visit www.jsi.furniture.com/finishes-and-material/textiles for our [textiles](#) program. See selection of standard and graded in manufactures and patterns.

Note: Only one wood finish and one paint color can be specified per unit

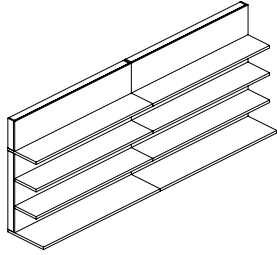
Description	D	W	H	CTN WT	CU FT	① Model	List Price
144" w Dual Open Workwall with 2 Shelves  <ul style="list-style-type: none"> · wall mounted · workwall top included (17 ¾" deep) · two fixed shelves · shipped in four sections · finish scheme <ul style="list-style-type: none"> -workwall top - veneer only -chassis and shelves - veneer or paint · eight letter divider fins available, specify and add \$876 list · six legal divider fins available, specify and add \$659 list · two grommets 31" off center of each section of the workwall available, specify and add \$228 list · aluminum mini shelf available, specify and add \$2,170 list; an insert back panel is required when ordering a mini shelf · back insert panel between bottom shelf and top available, indicate selection on order and select appropriate list price; panel reduces workwall by 1" <ul style="list-style-type: none"> -veneer panel -paint panel -magnetic back painted white glass with thin aluminum frame and 6 magnets -tackable fabric panel - com ydg: 5 	22	144	57	610	124	AM4-CWO-S2-22144	W/O PANEL \$15,391 veneer panel \$17,629 paint panel \$17,629 glass panel \$22,175 fabric panel COM \$16,813 A \$16,882 B \$17,013 C \$17,252 D \$17,559 E \$17,859 F \$18,337 G \$18,844 H \$19,386 I \$20,232 J \$21,247

Note: use insert panel when wanting to add contrast

120" w Dual Open Workwall with 2 Shelves  <ul style="list-style-type: none"> · wall mounted · workwall top included (17 ¾" deep) · two fixed shelves · shipped in four sections · finish scheme <ul style="list-style-type: none"> -workwall top - veneer only -chassis and shelves - veneer or paint · six letter divider fins available, specify and add \$659 list · six legal divider fins available, specify and add \$659 list · two grommets 31" off center of each section of the workwall available, specify and add \$228 list · aluminum mini shelf available, specify and add \$2,088 list; an insert back panel is required when ordering a mini shelf · back insert panel between bottom shelf and top available, indicate selection on order and select appropriate list price; panel reduces workwall by 1" <ul style="list-style-type: none"> -veneer panel -paint panel -magnetic back painted white glass with thin aluminum frame and 6 magnets -tackable fabric panel - com ydg: 4 ½ 	22	120	57	508	104	AM4-CWO-S2-22120	W/O PANEL \$14,344 veneer panel \$16,454 paint panel \$16,454 glass panel \$19,793 fabric panel COM \$15,694 A \$15,759 B \$15,878 C \$16,093 D \$16,367 E \$16,639 F \$17,069 G \$17,524 H \$18,008 I \$18,772 J \$19,686
---	----	-----	----	-----	-----	------------------	--

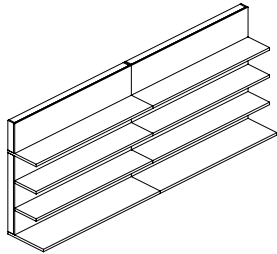
Note: use insert panel when wanting to add contrast

Description	D	W	H	CTN WT	CU FT	① Model	List Price
144" w Dual Open Workwall with 3 Shelves	22	144	57	678	124	AM4-CWO-S3-22144	\$13,151

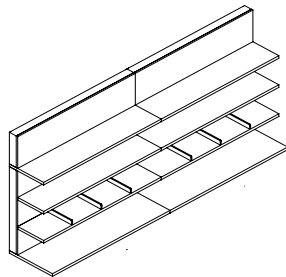


- wall mounted
- workwall top included (17 ¾" deep)
- three fixed shelves
- shipped in four sections
- finish scheme
 - workwall top - veneer only
 - chassis and shelves - veneer or paint
- eight letter divider fins available, specify and add \$876 list
- six legal divider fins available, specify and add \$659
- two grommets 31" off center of each section of the workwall available, specify and add \$228 list

120" w Dual Open Workwall with 3 Shelves	22	120	57	566	104	AM4-CWO-S3-22120	\$12,220
--	----	-----	----	-----	-----	------------------	----------



- wall mounted
- workwall top included (17 ¾" deep)
- three fixed shelves
- shipped in four sections
- finish scheme
 - workwall top - veneer only
 - chassis and shelves - veneer or paint
- six letter divider fins available, specify and add \$659 list
- six legal divider fins available, specify and add \$659 list
- two grommets 25" off center of each section of the workwall available, specify and add \$228 list



divider fins shown optional

To Order, Specify:

- ① Model Number
- ② Wood Species on Top - Makore (MK2), Maple (MA2)
Walnut (WA2), Black Oak (BO1) or Double Cut (DC1) [\(see page AP32\)](#)
- ③ Finish Color for Top [\(see page AP32\)](#)
- ④ Finish Color for Chassis/Shelves
 - a.) Same as Top
 - b.) Paint Color [\(see page AP32\)](#)

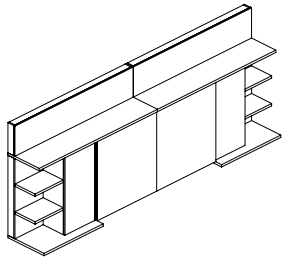
- ⑤ Insert Panel
 - a.) Veneer
 - 1.) Wood Species - Makore (MK2), Maple (MA2), Walnut (WA2), Black Oak (BO1) or Double Cut (DC1) [\(see page AP32\)](#)
 - a.) Finish Color [\(see page AP32\)](#)
 - b.) Paint (PNT)
 - 1.) Paint Color [\(see page AP32\)](#)
 - c.) Back Painted Magnetic Glass
 - d.) Fabric - vendor, pattern, color
- Visit www.jsi.furniture.com/finishes-and-material/textiles for our textiles program.
See selection of standard and graded in manufactures and patterns.

Note: Only one wood finish and one paint color can be specified per unit

Description

144" w Dual Wardrobe Workwall with Sliding Doors

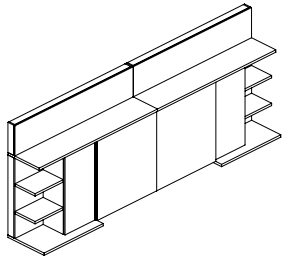
D	W	H	CTN WT	CU FT	Model	List Price
22	144	57	588	140	AM4-CWW-1-22144	\$20,308



- must order work center section, see pages 169-172
- wall mounted
- workwall top included
- shipped in four sections
- left and right side
 - 18" w fixed outer shelves
 - 18" w storage/wardrobe (sliding interior bi-pass door) adjustable shelves and coat hook
- finish scheme
 - workwall top - veneer only
 - chassis, interior sliding doors and shelves
 - veneer
 - paint
 - exterior 36" w sliding doors
 - veneer
 - paint
 - back painted white glass with thin aluminum frame, add \$2,725 list
 - magnetic back painted white glass with thin aluminum frame and 6 magnets, add \$3,204 list

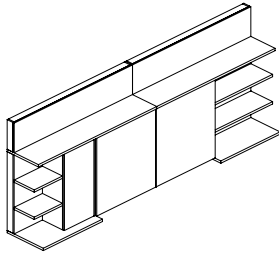
120" w Dual Wardrobe Workwall with Sliding Doors

22	120	57	448	118	AM4-CWW-1-22120	\$19,201
----	-----	----	-----	-----	-----------------	----------



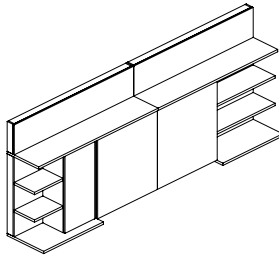
- must order work center section, see pages 169-172
- wall mounted
- workwall top included
- shipped in four sections
- left and right side
 - 15" w fixed outer shelves
 - 15" w storage/wardrobe (sliding interior bi-pass door) adjustable shelves and coat hook
- finish scheme
 - workwall top - veneer only
 - chassis, interior sliding doors and shelves
 - veneer
 - paint
 - exterior 30" w sliding doors
 - veneer
 - paint
 - back painted white glass with thin aluminum frame, add \$2,511 list
 - magnetic back painted white glass with thin aluminum frame and 6 magnets, add \$2,944 list

Description	D	W	H	CTN WT	CU FT	① Model	List Price
144" w Wardrobe Workwall and Shelf Workwall with Sliding Doors	22	144	57	572	138	AM4-CWC-WS-22144	\$18,402



- must order work center section, see pages 169-172
- wall mounted
- workwall top included
- shipped in four sections
- left side
 - 18" w fixed outer shelves
 - 18" w storage/wardrobe (sliding interior bi-pass door) adjustable shelves and coat hook
- right side
 - 36" w fixed outer shelves
- finish scheme
 - workwall top - veneer only
 - chassis, interior sliding doors and shelves
 - veneer
 - paint
 - exterior 36" w sliding doors
 - veneer
 - paint
 - back painted white glass with thin aluminum frame, add \$2,725 list
 - magnetic back painted white glass with thin aluminum frame and 6 magnets, add \$3,204 list

120" w Wardrobe Workwall and Shelf Workwall with Sliding Door	22	120	57	434	115	AM4-CWC-WS-22120	\$17,455
---	----	-----	----	-----	-----	------------------	----------



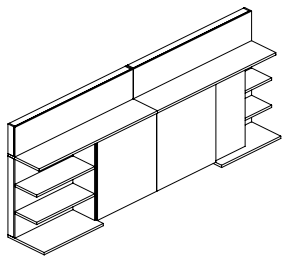
- must order work center section, see pages 169-172
- wall mounted
- workwall top included
- shipped in four sections
- left side
 - 15" w fixed outer shelves
 - 15" w storage/wardrobe (sliding interior bi-pass door) adjustable shelves and coat hook
- right side
 - 30" w fixed outer shelves
- finish scheme
 - workwall top - veneer only
 - chassis, interior sliding doors and shelves
 - veneer
 - paint
 - exterior 30" w sliding doors
 - veneer
 - paint
 - back painted white glass with thin aluminum frame, add \$2,511 list
 - magnetic back painted white glass with thin aluminum frame and 6 magnets, add \$2,944 list

To Order, Specify:

- ① Model Number Note: Only one wood finish and one paint color can be specified
- ② Wood Species on Top - Makore (MK2), Maple (MA2) per unit
Walnut (WA2), Black Oak (BO1) or Double Cut (DC1) [\(see page AP32\)](#)
- ③ Finish Color for Top [\(see page AP32\)](#)
- ④ Finish Color for Chassis, Interior Sliding Doors and Shelves
 - a.) Same as Top
 - b.) Paint Color [\(see page AP32\)](#)
- ⑤ Exterior Sliding Doors
 - a.) Same as Top
 - b.) Paint Color [\(see page AP32\)](#)
 - c.) Glass

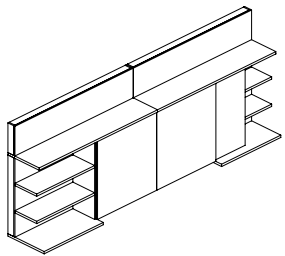
APOGEE™

Description	D	W	H	CTN WT	CU FT	① Model	List Price
144" w Shelf Workwall and Wardrobe Workwall with Sliding Doors	22	144	57	572	138	AM4-CWC-SW-22144	\$18,402



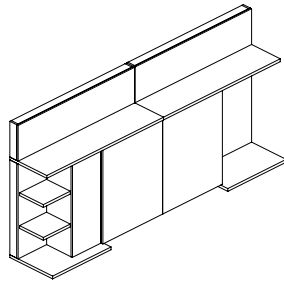
- must order work center section, see pages 169-172
- wall mounted
- workwall top included
- shipped in four sections
- left side
 - 36" w fixed outer shelves
- right side
 - 18" w fixed outer shelves
 - 18" w storage/wardrobe (sliding interior bi-pass door) adjustable shelves and coat hook
- finish scheme
 - workwall top - veneer only
 - chassis, interior sliding doors and shelves
 - veneer
 - paint
 - exterior 36" w sliding doors
 - veneer
 - paint
 - back painted white glass with thin aluminum frame, add \$2,725 list
 - magnetic back painted white glass with thin aluminum frame and 6 magnets, add \$3,204 list

120" w Shelf Workwall and Wardrobe Workwall with Sliding Doors	22	120	57	434	115	AM4-CWC-SW-22120	\$17,455
---	----	-----	----	-----	-----	-------------------------	-----------------



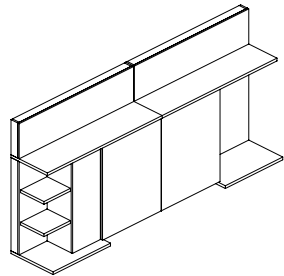
- must order work center section, see pages 169-172
- wall mounted
- workwall top included
- shipped in four sections
- left side
 - 30" w fixed outer shelves
- right side
 - 15" w fixed outer shelves
 - 15" w storage/wardrobe (sliding interior bi-pass door) adjustable shelves and coat hook
- finish scheme
 - workwall top - veneer only
 - chassis, interior sliding doors and shelves
 - veneer
 - paint
 - exterior 36" w sliding doors
 - veneer
 - paint
 - back painted white glass with thin aluminum frame, add \$2,511 list
 - magnetic back painted white glass with thin aluminum frame and 6 magnets, add \$2,944 list

Description	D	W	H	CTN WT	CU FT	① Model	List Price
144" w Wardrobe Workwall and Display Workwall with Sliding Doors	22	144	57	550	138	AM4-CWC-WD-22144	\$17,966



- must order work center section, see pages 169-172
- wall mounted
- workwall top included
- shipped in four sections
- left side
 - 18" w fixed outer shelves
 - 18" w storage/ wardrobe (sliding interior bi-pass door) adjustable shelves and coat hook
- right side
 - 36" w open display area
- finish scheme
 - workwall top - veneer only
 - chassis, interior sliding door and shelves
 - veneer
 - paint
 - exterior 36" w sliding doors
 - veneer
 - paint
 - back painted white glass with thin aluminum frame, add \$2,725 list
 - magnetic back painted white glass with thin aluminum frame and 6 magnets, add \$3,204 list

120" w Wardrobe Workwall and Display Workwall with Sliding Doors	22	120	57	417	115	AM4-CWC-WD-22120	\$17,020
--	----	-----	----	-----	-----	------------------	----------



- must order work center section, see pages 169-172
- wall mounted
- workwall top included
- shipped in four sections
- left side
 - 15" w fixed outer shelves
 - 15" w storage/ wardrobe (sliding interior bi-pass door) adjustable shelves and coat hook
- right side
 - 30" w open display area
- finish scheme
 - workwall top - veneer only
 - chassis, interior sliding door and shelves
 - veneer
 - paint
 - exterior 30" w sliding doors
 - veneer
 - paint
 - back painted white glass with thin aluminum frame, add \$2,511 list
 - magnetic back painted white glass with thin aluminum frame and 6 magnets, add \$2,944 list

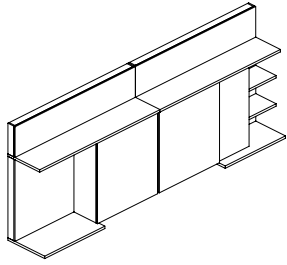
To Order, Specify:

- ① Model Number
- ② Wood Species on Top - Makore (MK2), Maple (MA2) Walnut (WA2), Black Oak (BO1) or Double Cut (DC1) [\(see page AP32\)](#)
- ③ Finish Color for Top [\(see page AP32\)](#)
- ④ Finish Color for Chassis, Interior Sliding Doors and Shelves
 - a.) Same as Top
 - b.) Paint Color [\(see page AP32\)](#)

- ⑤ Exterior Sliding Doors
 - a.) Same as Top
 - b.) Paint Color [\(see page AP32\)](#)
 - b.) Glass

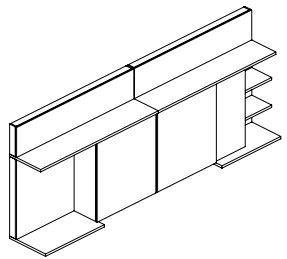
Note: Only one wood finish and one paint color can be specified per unit

Description	D	W	H	CTN WT	CU FT	① Model	List Price
144" w Display Workwall and Wardrobe Workwall with Sliding Doors	22	144	57	550	138	AM4-CWC-DW-22144	\$17,966



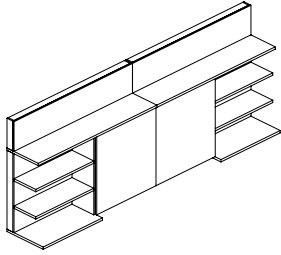
- must order work center section, see pages 169-172
- wall mounted
- workwall top included
- shipped in four sections
- left side
 - 36" w open display area
- right side
 - 18" w fixed outer shelves
 - 18" w storage/wardrobe (sliding interior bi-pass door) adjustable shelves and coat hook
- finish scheme
 - workwall top - veneer only
 - chassis, interior sliding door and shelves
 - veneer
 - paint
 - exterior 36" w sliding doors
 - veneer
 - paint
 - back painted white glass with thin aluminum frame, add \$2,725 list
 - magnetic back painted white glass with thin aluminum frame and 6 magnets, add \$3,204 list

120" w Display Workwall and Wardrobe Workwall with Sliding Doors	22	120	57	417	115	AM4-CWC-DW-22120	\$17,020
---	----	-----	----	-----	-----	-------------------------	-----------------



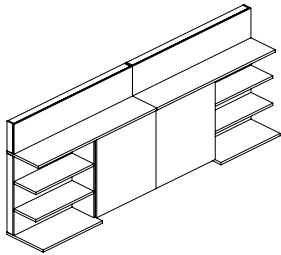
- must order work center section, see pages 169-172
- wall mounted
- workwall top included
- shipped in four sections
- left side
 - 30" w open display area
- right side
 - 15" w fixed outer shelves
 - 15" w storage/wardrobe (sliding interior bi-pass door) adjustable shelves and coat hook
- finish scheme
 - workwall top - veneer only
 - chassis, interior sliding door and shelves
 - veneer
 - paint
 - exterior 30" w sliding doors
 - veneer
 - paint
 - back painted white glass with thin aluminum frame, add \$2,511 list
 - magnetic back painted white glass with thin aluminum frame and 6 magnets, add \$2,944 list

Description	D	W	H	CTN WT	CU FT	① Model	List Price
144" w Dual Shelf Workwall with Sliding Doors	22	144	57	556	136	AM4-CWS-1-22144	\$16,498



- must order work center section, see pages 169-172
- wall mounted
- workwall top included
- shipped in four sections
- left and right side
 - 36" w fixed outer shelves
- finish scheme
 - workwall top - veneer only
 - chassis and shelves
 - veneer
 - paint
 - exterior 36" w sliding doors
 - veneer
 - paint
 - back painted white glass with thin aluminum frame, add \$2,725 list
 - magnetic back painted white glass with thin aluminum frame and 6 magnets, add \$3,204 list

120" w Dual Shelf Workwall with Sliding Doors	22	120	57	420	112	AM4-CWS-1-22120	\$15,712
---	----	-----	----	-----	-----	-----------------	----------



- must order work center section, see pages 169-172
- wall mounted
- workwall top included
- shipped in four sections
- left and right side
 - 30" w fixed outer shelves
- finish scheme
 - workwall top - veneer only
 - chassis and shelves
 - veneer
 - paint
 - exterior 30" w sliding doors
 - veneer
 - paint
 - back painted white glass with thin aluminum frame, add \$2,511 list
 - magnetic back painted white glass with thin aluminum frame and 6 magnets, add \$2,944 list

To Order, Specify:

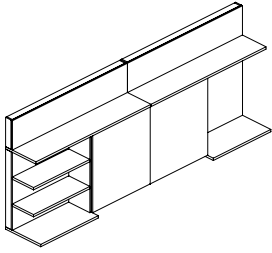
- ① Model Number
- ② Wood Species on Top - Makore (MK2), Maple (MA2) Walnut (WA2), Black Oak (BO1) or Double Cut (DC1) [\(see page AP32\)](#)
- ③ Finish Color for Top [\(see page AP32\)](#)
- ④ Finish Color for Chassis, Interior Sliding Doors and Shelves
 - a.) Same as Top
 - b.) Paint Color [\(see page AP32\)](#)

- ⑤ Exterior Sliding Doors
 - a.) Same as Top
 - b.) Paint Color [\(see page AP32\)](#)
 - c.) Glass

Note: Only one wood finish and one paint color can be specified per unit

Description	D	W	H	CTN WT	CU FT	① Model	List Price
144" w Shelf Workwall and Display Workwall with Sliding Doors	22	144	57	534	136	AM4-CWC-SD-22144	\$16,059

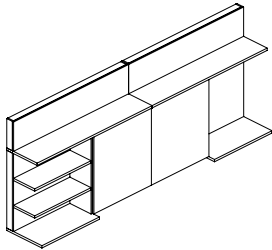
- must order work center section, see pages 169-172
- wall mounted
- workwall top included
- shipped in four sections
- left side
 - 36" w fixed outer shelves
- right side
 - 36" w display area
- finish scheme
 - workwall top - veneer only
 - chassis and shelves
 - veneer
 - paint
 - exterior 36" w sliding doors
 - veneer
 - paint
 - back painted white glass with thin aluminum frame, add \$2,725 list
 - magnetic back painted white glass with thin aluminum frame and 6 magnets, add \$3,204 list



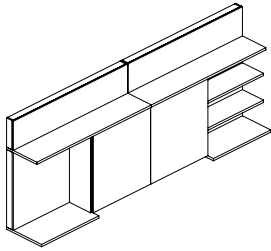
APOGEE™

120" w Shelf Workwall and Display Workwall with Sliding Doors	22	120	57	403	112	AM4-CWC-SD-22120	\$15,274
--	----	-----	----	-----	-----	-------------------------	-----------------

- must order work center section, see pages 169-172
- wall mounted
- workwall top included
- shipped in four sections
- left side
 - 30" w fixed outer shelves
- right side
 - 30" w display area
- finish scheme
 - workwall top - veneer only
 - chassis and shelves
 - veneer
 - paint
 - exterior 30" w sliding doors
 - veneer
 - paint
 - back painted white glass with thin aluminum frame, add \$2,511 list
 - magnetic back painted white glass with thin aluminum frame and 6 magnets, add \$2,944 list

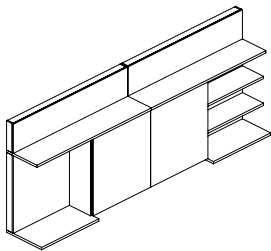


Description	D	W	H	CTN WT	CU FT	① Model	List Price
144" w Display Workwall and Shelf Workwall with Sliding Doors	22	144	57	534	136	AM4-CWC-DS-22144	\$16,059



- must order work center section, see pages 169-172
- wall mounted
- workwall top included
- shipped in four sections
- left side
 - 36" w display area
- right side
 - 36" w outer fixed shelves
- finish scheme
 - workwall top - veneer only
 - chassis and shelves
 - veneer
 - paint
 - exterior 36" w sliding doors
 - veneer
 - paint
 - back painted white glass with thin aluminum frame, add \$2,725 list
 - magnetic back painted white glass with thin aluminum frame and 6 magnets, add \$3,204 list

120" w Display Workwall and Shelf Workwall with Sliding Doors	22	120	57	403	112	AM4-CWC-DS-22120	\$15,274
--	----	-----	----	-----	-----	-------------------------	-----------------



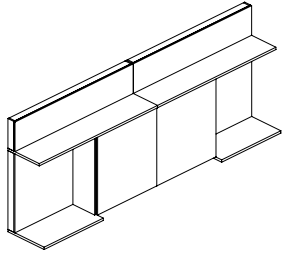
- must order work center section, see pages 169-172
- wall mounted
- workwall top included
- shipped in four sections
- left side
 - 30" w display area
- right side
 - 30" w outer fixed shelves
- finish scheme
 - workwall top - veneer only
 - chassis and shelves
 - veneer
 - paint
 - exterior 30" w sliding doors
 - veneer
 - paint
 - back painted white glass with thin aluminum frame, add \$2,511 list
 - magnetic back painted white glass with thin aluminum frame and 6 magnets, add \$2,944 list

To Order, Specify:

- ① Model Number Note: Only one wood finish and one paint color can be specified per unit
- ② Wood Species on Top - Makore (MK2), Maple (MA2) Walnut (WA2), Black Oak (BO1) or Double Cut (DC1) [\(see page AP32\)](#)
- ③ Finish Color for Top [\(see page AP32\)](#)
- ④ Finish Color for Chassis, Interior Sliding Doors and Shelves
 - a.) Same as Top
 - b.) Paint Color [\(see page AP32\)](#)
- ⑤ Exterior Sliding Doors
 - a.) Same as Top
 - b.) Paint Color [\(see page AP32\)](#)
 - c.) Glass

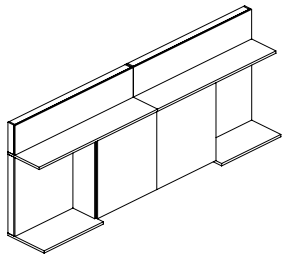
APOGEE™

Description	D	W	H	CTN WT	CU FT	① Model	List Price
144" w Dual Display Workwall with Sliding Doors	22	144	57	512	136	AM4-CWD-1-22144	\$15,625



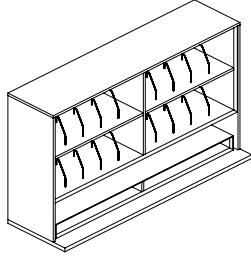
- must order work center section, see pages 169-172
- wall mounted
- workwall top included
- shipped in four sections
- left and right side
 - 36" w display area
- finish scheme
 - workwall top - veneer only
 - chassis and shelves
 - veneer
 - paint
 - exterior 36" w sliding doors
 - veneer
 - paint
 - back painted white glass with thin aluminum frame, add \$2,725 list
 - magnetic back painted white glass with thin aluminum frame and 6 magnets, add \$3,204 list

120" w Dual Display Workwall with Sliding Doors	22	120	57	386	112	AM4-CWD-1-22120	\$14,838
---	----	-----	----	-----	-----	-----------------	----------



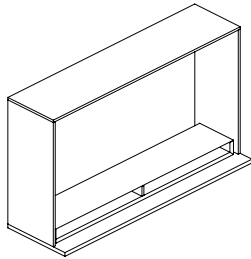
- must order work center section, see pages 169-172
- wall mounted
- workwall top included
- shipped in four sections
- left and right side
 - 30" w display area
- finish scheme
 - workwall top - veneer only
 - chassis and shelves
 - veneer
 - paint
 - exterior 30" w sliding doors
 - veneer
 - paint
 - back painted white glass with thin aluminum frame, add \$2,511 list
 - magnetic back painted white glass with thin aluminum frame and 6 magnets, add \$2,944 list

Description	D	W	H	CTN WT	CU FT	① Model	List Price
Workcenter	22	72	41	362	45	AM4-CZW-05-22144	\$5,735
	22	60	41	302	38	AM4-CZW-05-22120	\$5,503



- -22144 use with 144" w workwall with sliding doors
- -22120 use with 120" w workwall with sliding doors
- wall mounted
- workwall top included
- wire pass thru
- -22144 cubby opening 34" w each
- -22120 cubby opening 28" w each

Media Workcenter with Cubby and Two Niches	22	72	41	291	45	AM4-CZW-06-22144	\$3,553
	22	60	41	243	38	AM4-CZW-06-22120	\$3,408



- -22144 use with 144" w workwall with sliding doors
- -22120 use with 120" w workwall with sliding doors
- wall mounted
- workwall top included
- wire pass thru
- -22144 cubby opening 34" w each
- -22120 cubby opening 28" w each
- -22144: TV dimension not to exceed 68" w x 32" h to allow proper mounting clearance and air circulation
- -22120: TV dimension not to exceed 56" w x 32" h to allow proper mounting clearance and air circulation

To Order, Specify:

Workwall

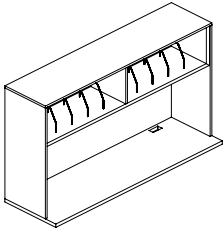
- ① Model Number
- ② Wood Species on Top - Makore (MK2), Maple (MA2), Walnut (WA2), Black Oak (BO1) or Double Cut (DC1) [\(see page AP32\)](#)
- ③ Finish Color for Top [\(see page AP32\)](#)
- ④ Finish Color for Chassis and Shelves
 - a.) Same as Top
 - b.) Paint Color [\(see page AP32\)](#)
- ⑤ Exterior Sliding Doors
 - a.) Same as Top
 - b.) Paint Color [\(see page AP32\)](#)
 - c.) Glass

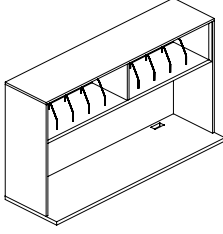
Workcenter

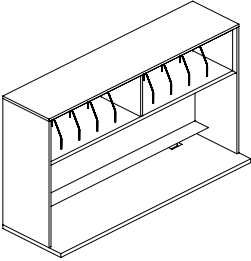
- ① Model Number
- ② Wood Species on Top - Makore (MK2), Maple (MA2), Walnut (WA2), Black Oak (BO1) or Double Cut (DC1) [\(see page AP32\)](#)
- ③ Finish Color for Top [\(see page AP32\)](#)
- ④ Finish Color for Chassis
 - a.) Same as Top
 - b.) Paint Color [\(see page AP32\)](#)
- ⑤ Cubby and Niche Paint Color

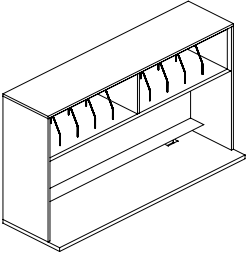
Note: Only one wood finish and one paint color can be specified per unit

APOGEE™

Description	D	W	H	CTN WT	CU FT	① Model	List Price
 <ul style="list-style-type: none"> · use with 144" w workwall with sliding doors · wall mounted · LED task lights auto on off door switch · required insert panel available in veneer, paint, magnetic back painted white glass or fabric, indicate selection on order and select appropriate list price · glass insert panel has a thin aluminum frame · glass not factory installed · pack of 6 magnets come with magnetic glass option · worksurface grommets · com ydg: 5 	22	72	41	273	45	AM4-CZW-01-22144	VENEER PANEL \$4,965
							PAINT PANEL \$4,965
							GLASS PANEL \$7,236
							FABRIC PANEL
							COM \$4,554
							A \$4,623
							B \$4,758
							C \$4,994
							D \$5,299
							E \$5,604
							F \$6,078
							G \$6,587
							H \$7,126
						I \$7,974	
						J \$8,988	

 <ul style="list-style-type: none"> · use with 120" w workwall with sliding doors · wall mounted · LED task lights auto on off door switch · required insert panel available in veneer, paint, magnetic back painted white glass or fabric, indicate selection on order and select appropriate list price · glass insert panel has a thin aluminum frame · glass not factory installed · pack of 6 magnets come with magnetic glass option · worksurface grommets · com ydg: 5 	22	60	41	228	38	AM4-CZW-01-22120	VENEER PANEL \$4,665
							PAINT PANEL \$4,665
							GLASS PANEL \$6,335
							FABRIC PANEL
							COM \$4,286
							A \$4,356
							B \$4,490
							C \$4,728
							D \$5,031
							E \$5,336
							F \$5,810
							G \$6,319
							H \$6,859
						I \$7,705	
						J \$8,719	

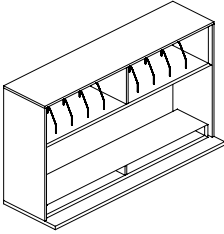
Description	D	W	H	CTN WT	CU FT	① Model	List Price
 <ul style="list-style-type: none"> · use with 144" w workwall with sliding doors · wall mounted · aluminum mini shelf · LED task light auto on off door switch · required insert panel available in veneer, paint, magnetic back painted white glass or fabric, indicate selection on order and select appropriate list price · glass insert panel has a thin aluminum frame · glass not factory installed · pack of 6 magnets come with magnetic glass option · worksurface grommets · com ydg; 4 ½ 	22	72	41	290	45	AM4-CZW-02-22144	VENEER PANEL \$6,410 PAINT PANEL \$6,410 GLASS PANEL \$8,682 FABRIC PANEL COM \$6,002 A \$6,063 B \$6,183 C \$6,398 D \$6,672 E \$6,946 F \$7,372 G \$7,828 H \$8,316 I \$9,078 J \$9,992

 <ul style="list-style-type: none"> · use with 120" w workwall with sliding doors · wall mounted · aluminum mini shelf · LED task light auto on off door switch · required insert panel available in veneer, paint, magnetic back painted white glass or fabric, indicate selection on order and select appropriate list price · glass insert panel has a thin aluminum frame · glass not factory installed · pack of 6 magnets come with magnetic glass option · worksurface grommets · com ydg; 4 ½ 	22	60	41	242	38	AM4-CZW-02-22120	VENEER PANEL \$5,995 PAINT PANEL \$5,995 GLASS PANEL \$7,667 FABRIC PANEL COM \$5,619 A \$5,679 B \$5,801 C \$6,015 D \$6,288 E \$6,563 F \$6,989 G \$7,446 H \$7,933 I \$8,694 J \$9,610
---	----	----	----	-----	----	------------------	--

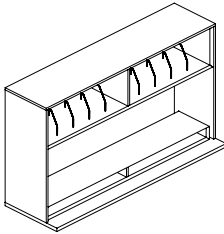
To Order, Specify:

- ① Model Number
- ② Wood Species on Workwall Top - Makore (MK2), Maple (MA2)
Walnut (WA2), Black Oak (BO1) or Double Cut (DC1)
(see page AP32)
- ③ Finish Color for Workwall Top *(see page AP32)*
- ④ Finish Color for Chassis
 - a.) Same as Workwall Top
 - b.) Paint *(see page AP32)*
- ⑤ Cubby Paint Color

Note: Only one wood finish and one paint color can be specified per unit

Description	D	W	H	CTN WT	CU FT	① Model	List Price
 <ul style="list-style-type: none"> · use with 144" w workwall with sliding doors · wall mounted · LED task light auto on off door switch · wire pass thru · required insert panel available in veneer, paint, magnetic back painted white glass or fabric, indicate selection on order and select appropriate list price · glass insert panel has a thin aluminum frame · glass not factory installed · pack of 6 magnets come with magnetic glass option · worksurface grommets · cubby accepts (4) legal paper trays · cubby opening 34" w each · com ydg; 5 	22	72	41	323	45	AM4-CZW-03-22144	VENEER PANEL \$5,967 PAINT PANEL \$5,967 GLASS PANEL \$8,254 FABRIC PANEL COM \$5,571 A \$5,641 B \$5,776 C \$6,014 D \$6,319 E \$6,623 F \$7,096 G \$7,604 H \$8,144 I \$8,991 J \$10,006

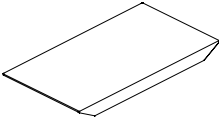
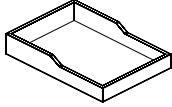
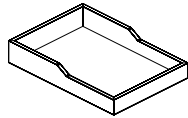
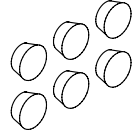
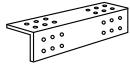
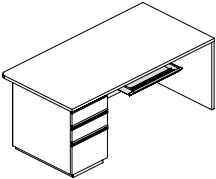
APOGEE™

 <ul style="list-style-type: none"> · use with 120" w workwall with sliding doors · wall mounted · LED task light auto on off door switch · wire pass thru · required insert panel available in veneer, paint, magnetic back painted white glass or fabric, indicate selection on order and select appropriate list price · glass insert panel has a thin aluminum frame · glass not factory installed · pack of 6 magnets come with magnetic glass option · worksurface grommets · cubby accepts (4) letter paper trays · cubby opening 28" w each · com ydg; 4 1/2 	22	60	41	269	38	AM4-CZW-03-22120	VENEER PANEL \$5,685 PAINT PANEL \$5,685 GLASS PANEL \$7,354 FABRIC PANEL COM \$5,303 A \$5,366 B \$5,487 C \$5,701 D \$5,976 E \$6,250 F \$6,676 G \$7,132 H \$7,618 I \$8,381 J \$9,296
---	----	----	----	-----	----	------------------	--

To Order, Specify:

- ① Model Number
- ② Wood Species on Top - Makore (MK2), Maple (MA2)
Walnut (WA2), Black Oak (BO1) or Double Cut (DC1)
(see page AP32)
- ③ Finish Color for Top *(see page AP32)*
- ④ Finish Color for Chassis
 - a.) Same as Top
 - b.) Paint *(see page AP32)*
- ⑤ Cubby and Niche Paint Color

Note: Only one wood finish and one paint color can be specified per unit

Description	D	W	H	CTN WT	CU FT	① Model	List Price
Leather Desk Pad  <ul style="list-style-type: none"> · use on worksurfaces · col sq ft: 12 · col list price \$524 	20	34		15	1	AP9-LDP-1-2034	L1 \$1,622 L2 \$1,864
Letter Paper Tray  <ul style="list-style-type: none"> · select veneer or paint 	10 ¼	13	2 ¾	3	1	AM9-PPT-1-1013	\$456
Legal Paper Tray  <ul style="list-style-type: none"> · select veneer or paint 	11 ½	16 ¼	2 ¾	3	1	AM9-PPT-1-1216	\$506
Magnets  <ul style="list-style-type: none"> · may be used with magnetic glass panels · white · pack of 6 				3	1	GP9-MAG-1-0101	\$95
Angle Bracket  <ul style="list-style-type: none"> · use when connecting a bridge to an open frame table desk · shipped with screws 	1	6	1	2	1	6-AB	\$56
Angled Front Center Drawer  <ul style="list-style-type: none"> · not available on table desk with apron · not available in makore or double cut · wood drawer · non-locking 	17 ⅝	24 ½	2 ½	20	1	GP9CDRC-1524	\$409

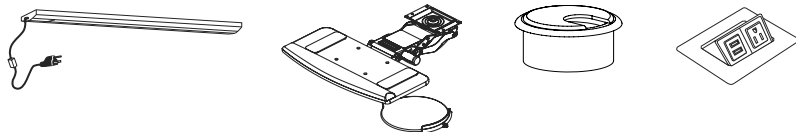
To Order, Specify:

- ① Model Number
- ② Wood Species - Cherry (CH1), Maple (MA2), Walnut (WA2) or Black Oak (BO1) ([see page AP32](#))
- ③ Leather - vendor, pattern, color
 Visit www.jsi.furniture.com/finishes-and-material/textiles-for-our-textiles program. See selection of standard and graded in manufactures and patterns.

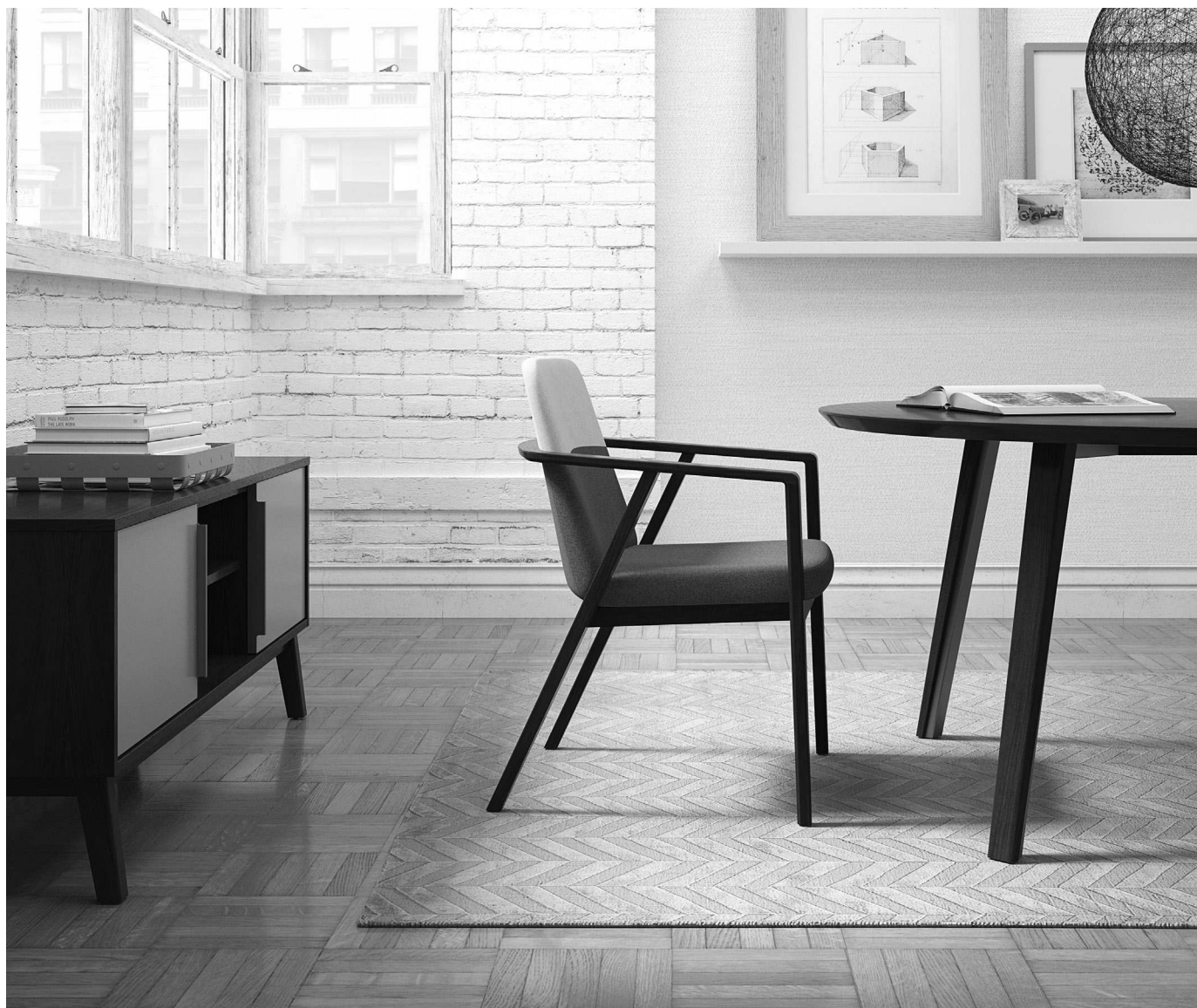
Accessories/ Keyboard/ Tasklights

For a list of electrical units, grommets, keyboards, wire management, monitor arms & telecom jacks, please see our [accessories price list](#)

Contact your customer service representative for specific questions regarding which units can be used with Apogee



Bourne Product Information



BOURNE

Standard Height TablesBU12
Counter Height TablesBU16
Bar Height TablesBU20
StorageBU22

Bourne Product Information

Product Overview

Bourne Seating and Occasional Tables below can be found in the JSI Seating Price List

Seating



Guest Chair
Single Fabric



Guest Chair
Dual Fabric



Lounge Chair
Single Fabric



Lounge Chair
Dual Fabric



Ottoman



Counter Height
Stool



Bar Stool

Occasional Tables



Rectangular
Coffee Table



Square
Coffee Table



Round
Coffee Table



Triangular
Coffee Table

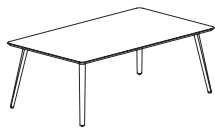


Square
Side Table



Round
Side Table

Standard and Counter Height Tables



Rectangular Table
with Wood Legs



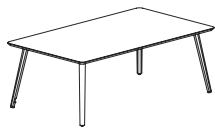
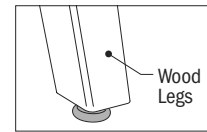
Racetrack Table
with Wood Legs



Square Table
with Wood Legs



Round Table
with Wood Legs



Rectangular Table
with Wood/Metal Legs



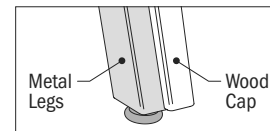
Racetrack Table
with Wood/Metal Legs



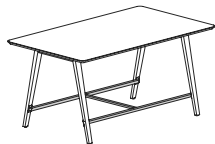
Square Table
with Wood/Metal Legs



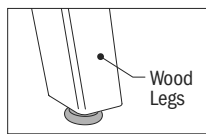
Round Table
with Wood/Metal Legs



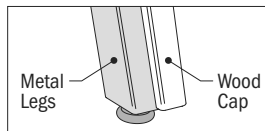
Bar Height Tables



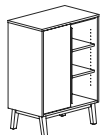
Rectangular Table with Wood Legs



Rectangular Table with Wood/Metal Legs



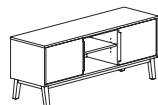
Storage



Tall Storage



Mid Storage



Low Storage

Bourne Product Information

Table Heights

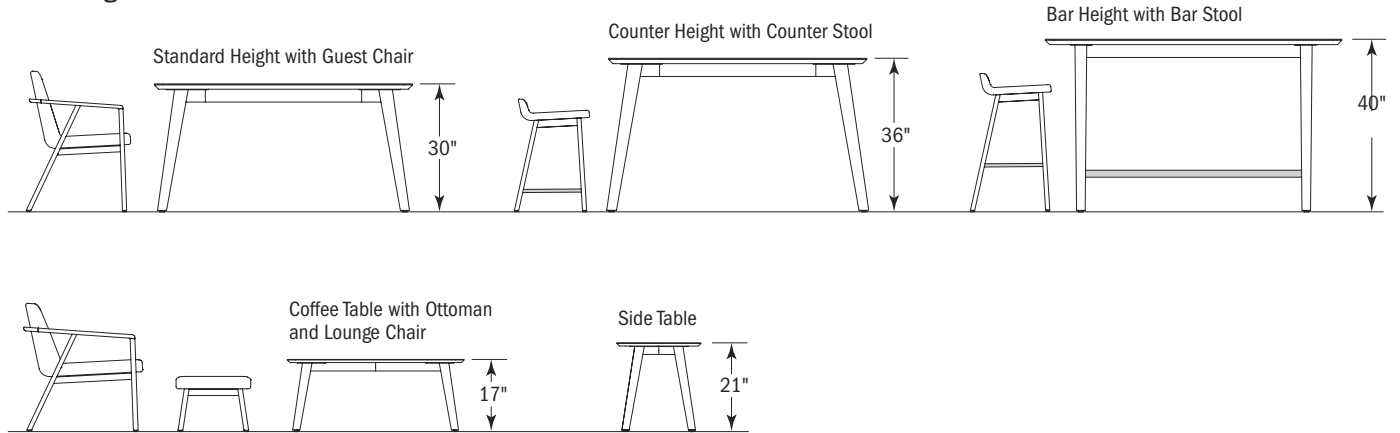


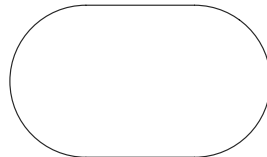
Table Shapes



rectangular

sizes available:

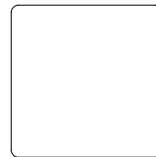
48" x 90" 42" x 90"
 48" x 84" 42" x 84"
 48" x 72" 42" x 72" 36" x 72"



racetrack

sizes available:

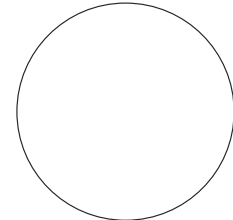
48" x 90" 42" x 90"
 48" x 84" 42" x 84"
 48" x 72" 42" x 72"
 42" x 60"



square

sizes available:

60" x 60"
 48" x 48"
 42" x 42"



round

size: 60" dia.

BOURNE

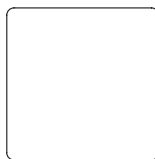
Bourne Occasional Tables below can be found in the JSI Seating Price List

Coffee Table Shapes



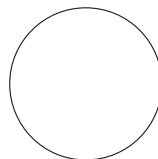
rectangular

size: 24" x 48"



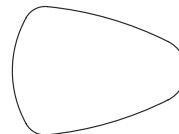
square

size: 42" x 42"



round

sizes available:
 42" dia.
 36" dia.



triangular

size: 36" x 48"

Side Table Shapes



square

size: 20" x 20"



round

size: 24" dia.

Bourne Tables Order Check List:



Specify:

- 1. Model Number
- 2. Top Material
 - a.) Veneer
 - 1.) Wood Species
 - 2.) Wood Finish
 - b.) Laminate
 - 1.) Laminate Color
 - c.) Solid Surface
 - 1.) Solid Surface Color
- 3. Legs/Apron Wood Species
 - a.) Maple (M)
 - 1.) Wood or Paint Color
 - b.) Walnut (W) (upcharge applies)
 - 1.) Wood Finish
- 4. Metal Legs/Foot Rail Color
- 5. Optional Accessory Hooks - four hooks; specify and add \$193 list
- 6. Optional Power Unit - units must be ordered separately
 - EC26 - worksurface power, specify cut-out on order - specify Black (B), or White (W)
 - EC27 - under surface power - specify Black (B), or White (W)

BOURNE

Example:

BU2448-17TTWL | **WA1** | **MCH** | **W** | **ESP** | **ASL**
 (model #) | (veneer species) | (wood finish) | (legs/apron species) | (wood finish) | (metal color)

1. Model Number

2. Top Material Selection:

Veneer

*finishes have coordinating laminate top

CH1 Cherry *Flat Cut Veneer*

BBM Bourbon Medium CLL Collectors
 BRM Brighton Medium HRV Harvest
 CLA Classic PRL Praline

MA1 Maple *Flat Cut Veneer*

ALM Ale Medium FLX Flax
 BUT Butterscotch VEN Venetian

WA1 Walnut *Flat Cut Veneer*

ESP Espresso TRF Truffle
 MCH Mocha UMB Umber
 SIE Sienna

B01 Black Oak *Flat Cut Veneer*

RAV Raven

Top Material Selection (continued):

Veneer

DC1 Double Cut Veneer

BAR Barrel - Oak Pattern	KHK Khaki
BUF Buff - Oak Pattern	MIN Mineral - Oak Pattern
CND Cinder - Oak Pattern	RYE Rye - Oak Pattern
COF Coffee	SAB Sable - Oak Pattern
EGR Egret - Oak Pattern	SAD Saddle - Oak Pattern
FAW Fawn	STU Studio Teak
GRH Graphite	VAL Valley

Laminate

HPL Wood Grain Pattern Laminates

ALL Ale Light	MIN Mineral
BOL Bourbon Light	OAT Oatmeal Cookie
BZW Brazilwood	PIN Pinnacle Walnut
BGL Brighton Light	STU Studio Teak
CLL Collectors	UMB Umber
FAW Fawn	VAL Valley
FLO Florence Walnut	VIN Vintage
GRH Graphite	WEA Weathered Ash

HPL Solid Laminates

ALB Alabaster	DWH Designer White
BLK Black	SHD Shadow
BBL Bridal Blanco	SLG Slate Grey

Top Material Selection (continued):

Solid Surface

ARM	Armadillo	PUR	Pure White
BLP	Black Pearl	PEB	Pebble Pearl

3. Legs/Apron Selection:

Maple (MA1)

Wood Finish:

ALM	Ale Medium	HRV	Harvest
CAL	Ale Light Coordinate	CKC	Khaki Coordinate
BBM	Bourbon Medium	MINC	Mineral Coordinate
CBZ	Brazilwood Coordinate	MCH	Mocha
BARC	Barrel Coordinate	CPI	Pinnacle Walnut Coordinate
CBO	Bourbon Light Coordinate	PRL	Praline
CBG	Brighton Light Coordinate	RAVC	Raven Coordinate
BRM	Brighton Medium	SABC	Sable Coordinate
BUT	Butterscotch	SIE	Sienna
CNDC	Cinder Coordinate	CST	Studio Teak Coordinate
CLA	Classic	TRF	Truffle
CLL	Collectors	UMB	Umber
EGRC	Egret Coordinate	VALC	Valley Coordinate
ESP	Espresso	VEN	Venetian
FAWC	Fawn Coordinate	CWE	Weathered Ash Coordinate
FLX	Flax		
CGR	Graphite Coordinate		

Paint Color:

BKD	Backdrop	GRV	Greek Villa
BFX	Black Fox	NET	Network Gray
BWH	Bright White	NWH	Nonchalant White
CGP	Cargo Pants	SND	Sandbank
CHT	Chatroom	TRC	Tricorn Black
FRR	French Roast		

Legs/Apron Selection (continues)

Walnut (WA1) (upcharge applies)

Wood Finish:

ESP	Espresso	UMB	Umber
MCH	Mocha	TRF	Truffle
SIE	Sienna		

4. Metal Legs/Foot Rail Color:

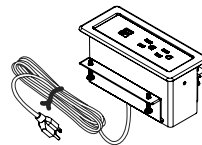
ABZ	Aged Bronze	PEW	Pewter
ASL	Arctic Silver	SBZ	Soft Bronze
GLD	Gold	SNK	Soft Nickel
MBK	Matte Black		

5. Optional Accessory Hooks - four hooks; specify and add \$193 list

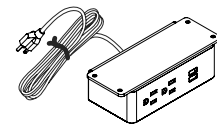
6. Power Unit - Power Units can be specified

Worksurface - EC26 - Two 110 outlets and a dual USB port with a 120" power cord - Black (B) or White (W); see page BU23.

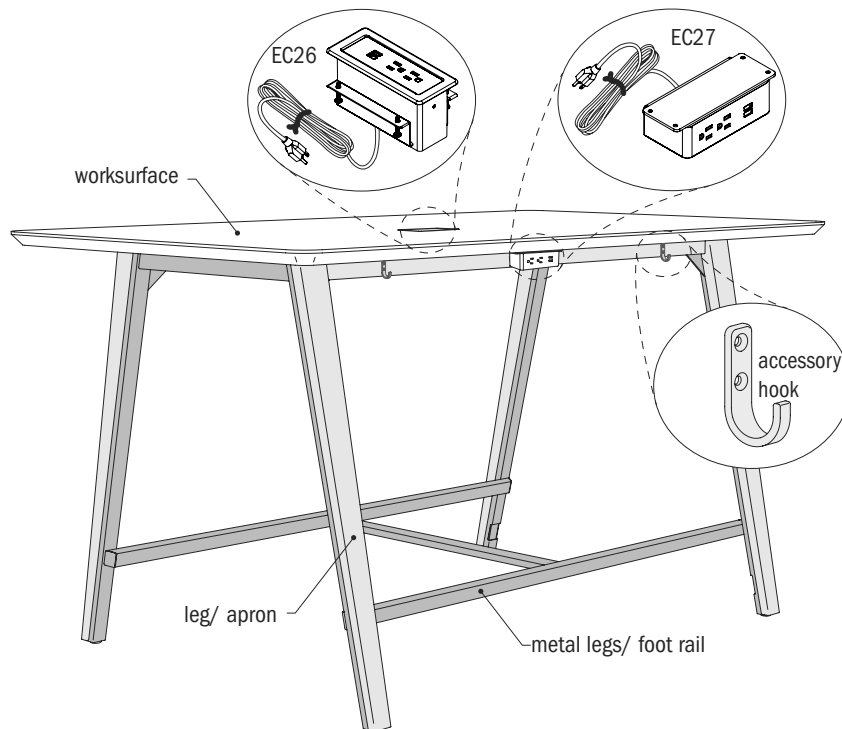
Under Surface - EC27 - Two 110 outlets and a dual USB port with a 120" power cord - Black (B) or White (W); see page BU23.



EC26



EC27



Bourne Storage Order Check List:



Specify:

- 1. Model Number
- 2. Chassis Species - Cherry (CH1), Maple (MA1), Walnut (WA1) or Double Cut (DC1)
- 3. Base Wood Species:
 - a.) Maple (M) - Standard (finish will be same as chassis)
 - b.) Walnut (W) - Upcharge Applies (only available when walnut chassis is specified, finish will be same as chassis)
- 4. Chassis/Base Finish
- 5. Door Finish
 - a.) Same as Chassis
 - b.) Paint
 - 1.) Paint Color

Examples:

BU1830-42STWL (model #)	MA1 (chassis species)	M (base species)	ALM (chassis/base finish)	NET (door paint color)
-----------------------------------	---------------------------------	----------------------------	-------------------------------------	----------------------------------

1. Model Number

2. Chassis Species:

CH1 Cherry *Flat Cut Veneer*

BBM Bourbon Medium	CLL Collectors
BRM Brighton Medium	HRV Harvest
CLA Classic	PRL Praline

MA1 Maple *Flat Cut Veneer*

ALM Ale Medium	FLX Flax
BUT Butterscotch	VEN Venetian

WA1 Walnut *Flat Cut Veneer*

ESP Espresso	TRF Truffle
MCH Mocha	UMB Umber
SIE Sienna	

BO1 Black Oak *Flat Cut Veneer*

RAV Raven	
-----------	--

DC1 Double Cut Veneer *Eased Edge Only*

BAR Barrel - Oak Pattern	KHK Khaki
BUF Buff - Oak Pattern	MIN Mineral - Oak Pattern
CND Cinder - Oak Pattern	RYE Rye - Oak Pattern
COF Coffee	SAB Sable - Oak Pattern
EGR Egret - Oak Pattern	SAD Saddle - Oak Pattern
FAW Fawn	STU Studio Teak
GRH Graphite	VAL Valley

3. Base Wood Species:

Maple (MA1)
Wood Finish:
 Same as Chassis

Walnut (WA1) (upcharge applies)
Wood Finish:
 Same as Chassis

4. Chassis/Base Finish:

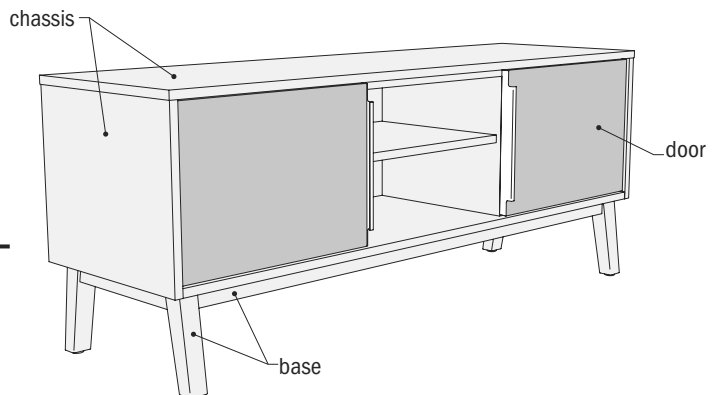
Wood Finish:
 See list of finishes under 2. Chassis Species
 (Base Finish same as Chassis)

5. Door Finish Selection:

Wood Finish:
 Same as Chassis

Paint Color:

BKD Backdrop	GRV Greek Villa
BFX Black Fox	NET Network Grey
BWH Bright White	NWH Nonchalant White
CGP Cargo Pants	STM Storm
CHT Chatroom	TRC Tricorn Black
FRR French Roast	

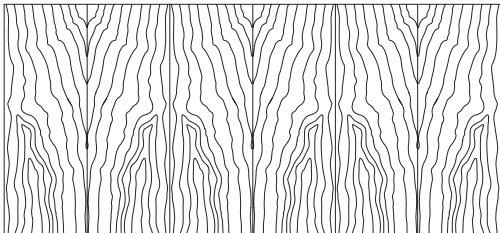


page left intentionally blank

Bourne Tables and Storage Product Information

Exterior Wood Materials

Exterior surfaces are made from the finest selected veneers to achieve clarity and consistency in the Bourne product line. To attain a pleasing, symmetrical pattern, all veneers in Bourne are book-matched. All exterior solid lumber is matched to coordinate with the veneer.



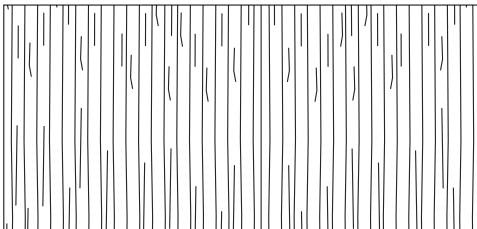
Book Matched Example

Alternating pieces of veneer are flipped over so they face each other like the pages within a book.

Bourne is available in flat cut cherry, maple, walnut veneer and black oak. A wide range of wood stains have been formulated to enhance the beauty of the veneer.

Double Cut veneer is another choice on Bourne Veneer product. This veneer is a processed product that has at least two cuttings to create the final veneers. These cuts of veneer strands are dyed and layered into a block to create variation of patterns from a very tight grain pattern to an exotic figure grain pattern.

The diagram below shows the tight pattern used on Bourne Double Cut Veneer.



Worksurface Construction

Veneer and Laminate Worksurface

Worksurfaces are 1 3/16" thick and are manufactured with 3-ply balanced construction. Surfaces are available in wood veneer or high pressure laminate. MDF edges on table tops have an undercut bevel profile and are painted to match top.

Solid Surface Worksurface

Solid surface worksurfaces are constructed with a 1/2" thick solid surface top and a 1 1/16" thick wood sub-top. Total thickness of this mixed material worksurface is 1 3/16". MDF edges on sub-top have an undercut bevel profile and are painted to match top.

Casework Construction

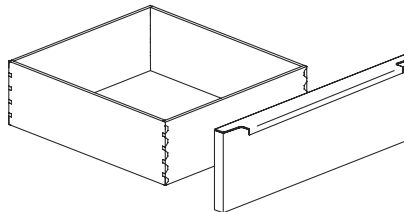
Casework tops are made up of layers of hardwood veneers molded to shape and RF cured. Outer veneers are matched for uniform grain patterns. All casework tops are 3/4" thick plywood.

Casework chassis, doors and drawer fronts consist of veneer over composite wood core; all wood core components are 3/4" thick.

Cabinet doors have 110° swing hinges to allow adequate access into the interior of the cabinet.

Drawers

The 9-ply unidirectional hardwood sides of the drawer box are 7/16" thick assembled with English dovetail construction at each corner of the box. The drawer bottom panel is 1/4" thick fitting into a groove machined into the side of the box. Interiors are sanded and coated with clear U.V. finish to protect against shrinking, swelling or warping, and to provide a clean, smooth feel and appearance.



Drawer Suspension

The high quality black drawer suspensions carry a lifetime warranty. Slides feature steel ball bearings for longer life with cushioned in/out stops. File and box drawers have 100% full extension with over travel.

Finish - Stain/Colors

We offer a variety of wood stains and paint colors on Bourne. Please see the chart below. Samples are available upon request.

CH1 Cherry	<i>Flat Cut Veneer</i>		
BBM Bourbon Medium		CLL Collectors	
BRM Brighton Medium		HRV Harvest	
CLA Classic		PRL Praline	

MA1 Maple	<i>Flat Cut Veneer</i>		
ALM Ale Medium		FLX Flax	
BUT Butterscotch		VEN Venetian	

WA1 Walnut	<i>Flat Cut Veneer</i>		
ESP Espresso		TRF Truffle	
MCH Mocha		UMB Umber	
SIE Sienna			

B01 Black Oak	<i>Flat Cut Veneer</i>		
RAV Raven			

DC1 Double Cut Veneer	<i>Eased Edge Only</i>		
BAR Barrel - Oak Pattern		KHK Khaki	
BUF Buff - Oak Pattern		MIN Mineral - Oak Pattern	
CND Cinder - Oak Pattern		RYE Rye - Oak Pattern	
COF Coffee		SAB Sable - Oak Pattern	
EGR Egret - Oak Pattern		SAD Saddle - Oak Pattern	
FAW Fawn		STU Studio Teak	
GRH Graphite		VAL Valley	

PNT Paint			
BKD Backdrop		GRV Greek Villa	
BFX Black Fox		NET Network Gray	
BWH Bright White		NWH Nonchalant White	
CGP Cargo Pants		STM Storm	
CHT Chatroom		TRC Tricorn Black	
FRR French Roast			

Bourne Tables and Storage Product Information

Protective Top Coat

DuraTex™ offers exceptional hardness along with abrasion and impact resistance, it has been formulated to eliminate hazardous and harmful gases that are normally associated with wood finish.

DuraTex™ Features

Safety - Significantly reduces hazardous formaldehyde emissions, which help improve the quality of the of the indoor air we breathe.
Quality - Developed to be tough and durable with special attention to appearance. The DuraTex™ finish preserves the natural beauty of wood.
Durability - Designed to meet a wide range of demanding performance and environmental standards to withstand even the highest wear and tear. To reduce hazardous formaldehyde emission we use our proprietary specially design top coat, DuraTex™. We are proud that our finish is Green-Guard certified.

Finish Sheen

All veneer finishes are standard in 35-sheen, with the exception of Raven. Raven is only offered in 15 sheen. All other finishes can have their sheen modified with a 15% upcharge added to the list price of each item.

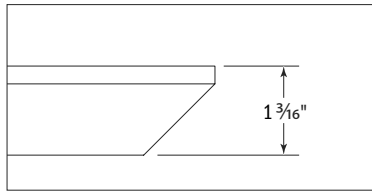
Care of Wood Edges and Veneer Surfaces

Clean all surfaces frequently with water dampened soft cloth, moving the cloth with the grain direction. Immediately remove any liquids that come in contact with wood surfaces, with a blotting action to absorb liquid. Buff dry. Lift objects to move them, never pull them across the finished surface. Avoid exposure of furniture to extremes of heat, cold, and wide variance of humidity. Avoid exposure of furniture to strong sunlight. Avoid exposure of furniture to harsh solvents such as nail polish remover, acetates, etc., as it will cause finish deterioration.

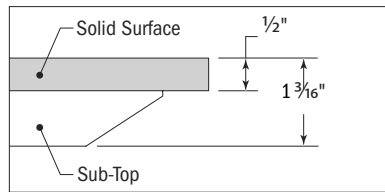
Metal Components

Wipe smooth powder coat finishes and textured metals with a damp cloth. For stubborn stains and grease marks, use soap and water. Lightly brush textured metals with a soft, dry brush to remove dirt.

Top Edge Details



Knife Edge - Veneer & Laminate

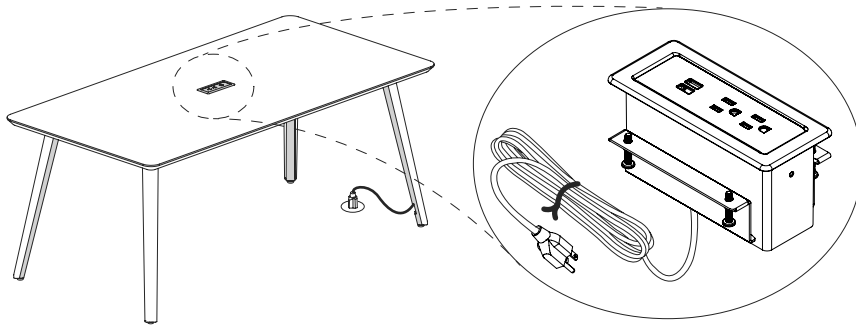


Painted Knife Edge with Solid Surface Top

Optional Power Units

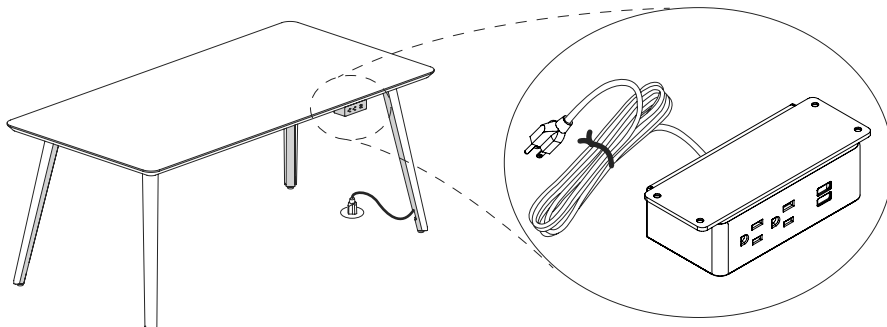
Worksurface Surface Power

Optional Worksurface Power (EC26) is available on standard, counter and bar height tables. Indicate "to accommodate Worksurface Power" on your purchase order. When this option is specified the worksurface will have one cut out in the center. One EC26 Worksurface Power unit must be ordered separately, [see page BU23](#). Length of cord is 10 feet.



Under Surface Power

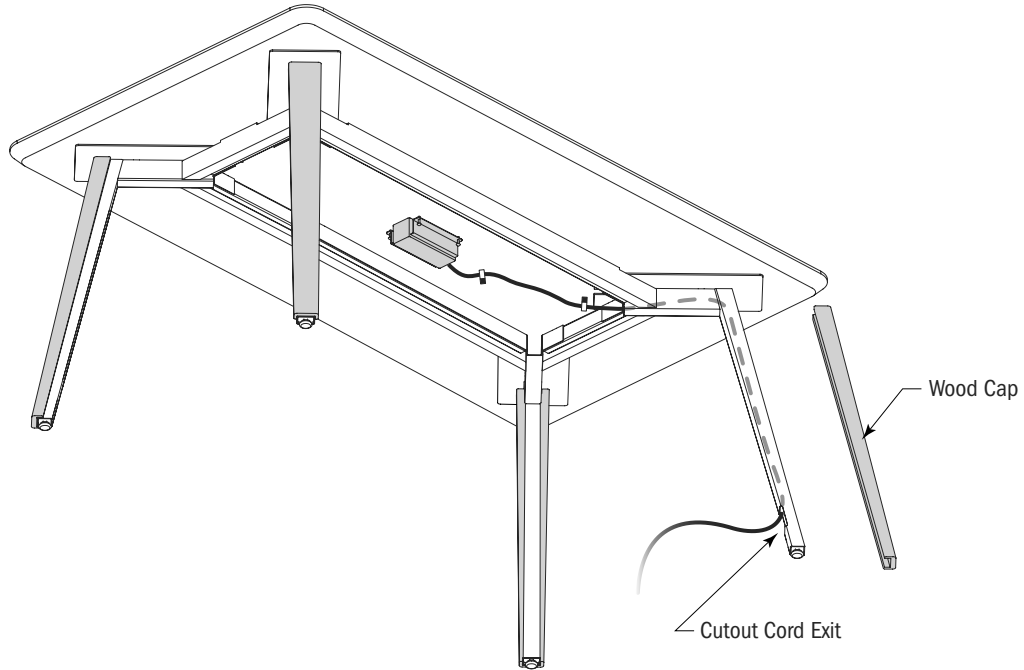
Under Surface Power (EC27) may be ordered for standard, counter and bar height tables. The EC27 Under Surface Power Unit(s) must be ordered separately, [see page BU23](#). This unit is field installed. Length of cord is 10 feet.



Bourne Tables and Casework Product Information

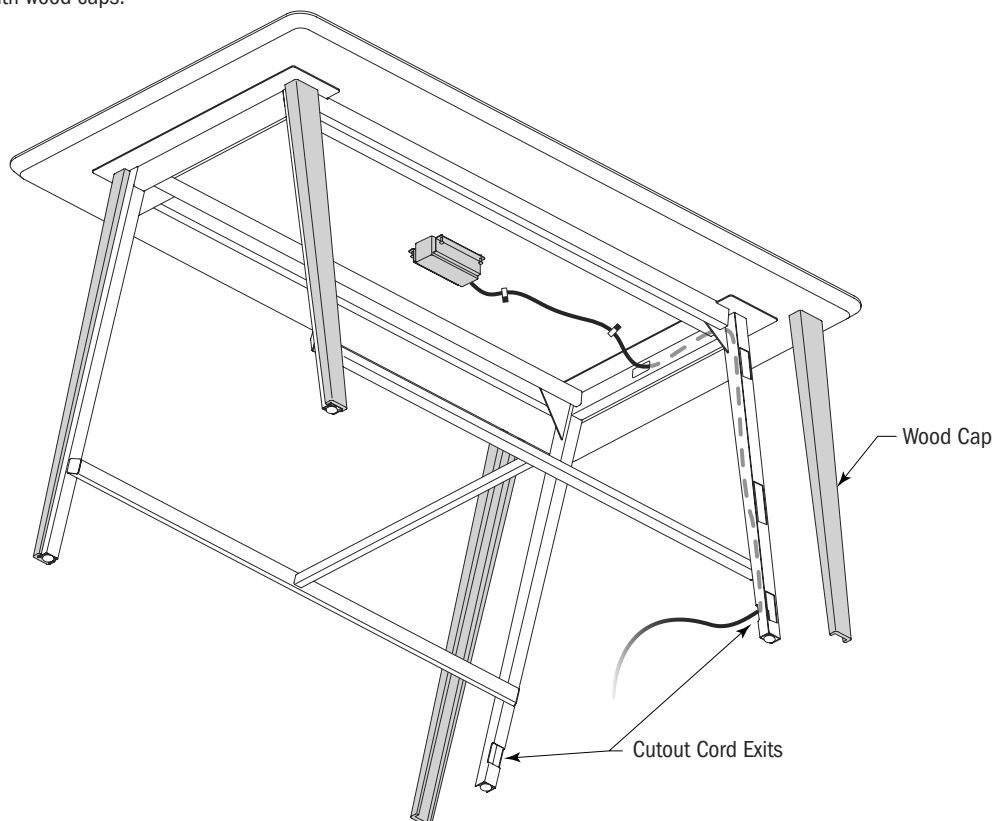
Wire Management - Standard and Counter Height Tables

Standard and counter height tables with metal legs contain one leg with a wire management channel/exit cutout which is accessed and concealed with a wood cap. This wire management leg can be attached to any corner of the table during assembly. Predetermining which corner of table cord exit is desired and assemble accordingly.



Wire Management - Bar Height Tables

Bar height tables with metal legs has a set of legs on one side of table with wire management channel and exit cutout. The management channels are accessed and concealed with wood caps.

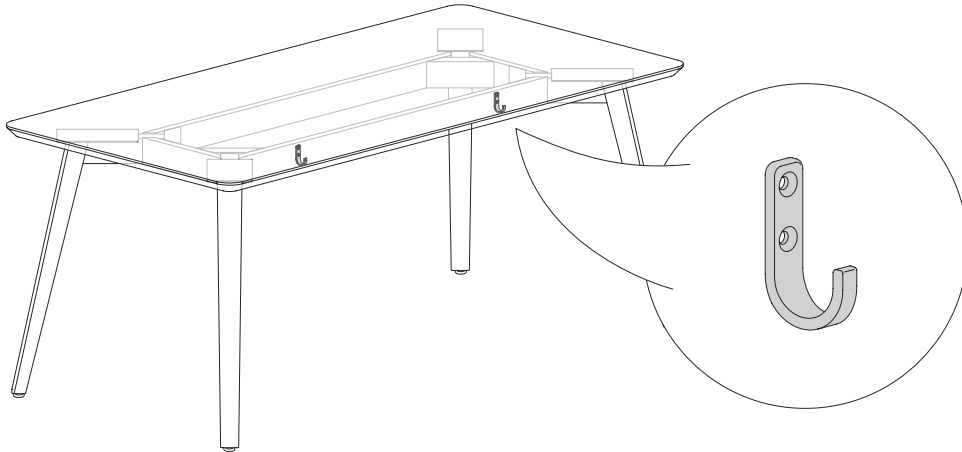


Bourne Tables and Casework Product Information

Optional Accessory Hooks

Optional satin stainless steel accessory hooks are available on the 30"h, 36"h and 40"h tables.

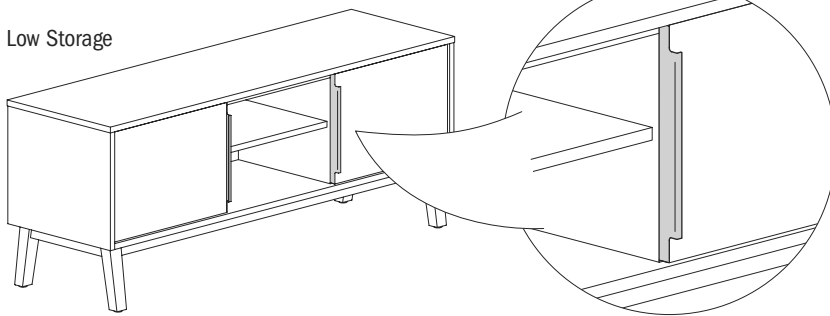
Four Hooks - add \$193 list



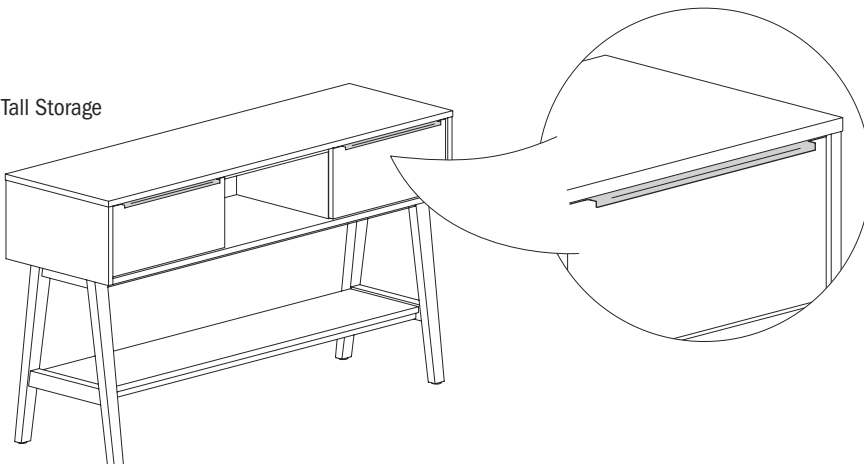
Integrated Metal Pull

Storage Units offer integrated clear anodized aluminum pulls standard.

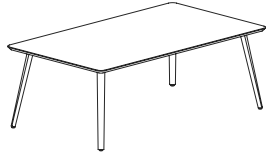
Low Storage



Tall Storage

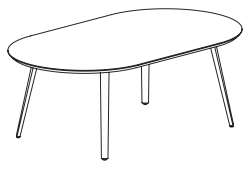


Description	D	W	H	CTN WT	CU FT	Model	Flat Cut or HPL Laminate Top	Double Cut Top	Solid Surface Top
30" h Rectangular Table with Wood Legs	48	90	30	210	38	BU4890-30TTWL	\$3,319	\$3,388	\$8,511
	48	90	30	200	35	BU4884-30TTWL	\$3,253	\$3,320	\$8,443
	48	72	30	180	30	BU4872-30TTWL	\$3,010	\$3,078	\$5,794
	42	90	30	191	33	BU4290-30TTWL	\$3,214	\$3,283	\$8,404
	42	84	30	183	31	BU4284-30TTWL	\$3,036	\$3,101	\$8,184
	42	72	30	165	27	BU4272-30TTWL	\$2,843	\$2,910	\$5,602
	36	72	30	151	23	BU3672-30TTWL	\$2,725	\$2,793	\$5,482



- ships KD
- optional accessory hooks (four hooks) available, specify and add \$193 list, [see page BU11](#)
- EC26 worksurface power available, specify "to accommodate worksurface power" on your purchase order; one EC26 unit must be ordered separately, [see page BU23](#)
- EC27 under surface power available, [see page BU23](#)
- knife edge
- maple legs/apron standard
- walnut legs/apron available, specify and add \$544 list

30" h Racetrack Table with Wood Legs	48	90	30	193	38	BU4890-30RTWL	\$3,286	\$3,352	\$8,475
	48	84	30	183	35	BU4884-30RTWL	\$3,215	\$3,284	\$8,407
	48	72	30	163	30	BU4872-30RTWL	\$2,972	\$3,039	\$5,754
	42	90	30	178	33	BU4290-30RTWL	\$3,184	\$3,251	\$8,374
	42	84	30	170	31	BU4284-30RTWL	\$3,003	\$3,072	\$8,150
	42	72	30	152	27	BU4272-30RTWL	\$2,810	\$2,876	\$5,565
	42	60	30	135	23	BU4260-30RTWL	\$2,652	\$2,721	\$5,411



- ships KD
- optional accessory hooks (four hooks) available, specify and add \$193 list, [see page BU11](#)
- EC26 worksurface power available, specify "to accommodate worksurface power" on your purchase order; one EC26 unit must be ordered separately, [see page BU23](#)
- EC27 under surface power available, [see page BU23](#)
- knife edge
- maple legs/apron standard
- walnut legs/apron available, specify and add \$544 list

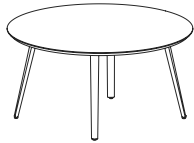
BOURNE

Description	D	W	H	CTN WT	CU FT	① Model	Flat Cut or HPL Laminate Top	Double Cut Top	Solid Surface Top
30" h Square Table with Wood Legs	60	60	30	185	32	BU6060-30TTWL	\$3,115	\$3,183	\$5,941
	48	48	30	141	21	BU4848-30TTWL	\$2,643	\$2,712	\$4,815
	42	42	30	122	16	BU4242-30TTWL	\$2,528	\$2,597	\$4,701



- ships KD
- optional accessory hooks (four hooks) available, specify and add \$193 list, [see page BU11](#)
- EC26 worksurface power available, specify "to accommodate worksurface power" on your purchase order; one EC26 unit must be ordered separately, [see page BU23](#)
- EC27 under surface power available, [see page BU23](#)
- knife edge
- maple legs/apron standard
- walnut legs/apron available, specify and add \$544 list

30" h Round Table with Wood Legs	60	60	30	159	32	BU60-30RDWL	\$3,057	\$3,125	\$5,884
----------------------------------	----	----	----	-----	----	-------------	---------	---------	---------

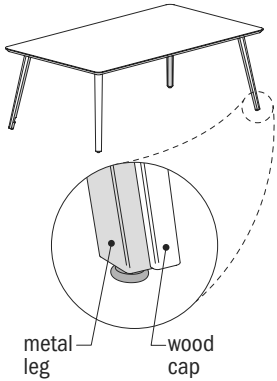


- ships KD
- optional accessory hooks (four hooks) available, specify and add \$193 list, [see page BU11](#)
- EC26 worksurface power available, specify "to accommodate worksurface power" on your purchase order; one EC26 unit must be ordered separately, [see page BU23](#)
- EC27 under surface power available, [see page BU23](#)
- knife edge
- maple legs/apron standard
- walnut legs/apron available, specify and add \$544 list

To Order, Specify:

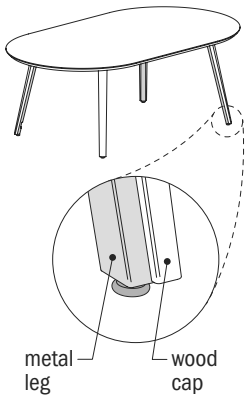
- ① Model Number
- ② Top Material:
 - a.) Veneer [See Veneer Top Finish Options](#)
 - 1.) Wood Species - Cherry (CH1), Maple (MA1), Walnut (WA1), Black Oak (BO1) or Double Cut (DC1)
 - a.) Finish Color
 - b.) Laminate [See Laminate Top Options](#)
 - 1.) Laminate Color
 - c.) Solid Surface [See Solid Surface Top Options](#)
- ③ Legs/Apron Species:
 - a.) Maple (M) [See Maple Legs/Apron Finish Options](#)
 - 1.) Finish Color - cherry, maple, black oak, walnut or paint color on maple legs/apron
 - b.) Walnut (W) [See Walnut Legs/Apron Finish Options](#) - upcharge applies
 - 1.) Finish Color - walnut finishes only on walnut legs/apron
- ④ Optional Accessory Hooks - four hooks; specify and add \$193 list, ([see page BU11](#))
- ⑤ Optional Power Units:
 - a.) Work Surface Power; specify with EC26 cut-out. EC26 must be ordered separately, ([see page BU23](#))
 - b.) Under Surface Power; mounts under top. EC27 must be ordered separately, ([see page BU23](#))

Description	D	W	H	CTN WT	CU FT	Model	Flat Cut or HPL Laminate Top	Double Cut Top	Solid Surface Top
30" h Rectangular Table with Wood/Metal Legs	48	90	30	222	38	BU4890-30TTML	\$5,565	\$5,633	\$10,757
	48	84	30	212	35	BU4884-30TTML	\$5,449	\$5,517	\$10,639
	48	72	30	192	30	BU4872-30TTML	\$5,158	\$5,226	\$7,944
	42	90	30	203	33	BU4290-30TTML	\$5,392	\$5,459	\$10,582
	42	84	30	195	31	BU4284-30TTML	\$5,168	\$5,233	\$10,313
	42	72	30	177	27	BU4272-30TTML	\$4,927	\$4,996	\$7,684
	36	72	30	162	23	BU3672-30TTML	\$4,772	\$4,837	\$7,529



- ships KD
- metal legs with removable wood surround to access and manage wires
- optional accessory hooks (four hooks) available, specify and add \$193 list, [see page BU11](#)
- EC26 worksurface power available, specify "to accommodate worksurface power" on your purchase order; one EC26 unit must be ordered separately, [see page BU23](#)
- EC27 under surface power available, [see page BU23](#)
- knife edge
- maple legs/apron standard
- walnut legs/apron available, specify and add \$376 list

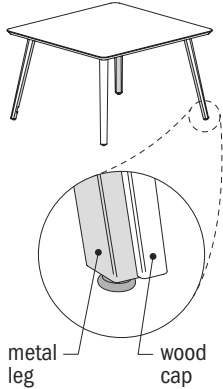
30" h Racetrack Table with Wood/Metal Legs	48	90	30	205	38	BU4890-30RTML	\$5,361	\$5,429	\$10,552
	48	84	30	195	35	BU4884-30RTML	\$5,235	\$5,303	\$10,425
	48	72	30	175	30	BU4872-30RTML	\$4,923	\$4,989	\$7,707
	42	90	30	190	33	BU4290-30RTML	\$5,223	\$5,291	\$10,412
	42	84	30	182	31	BU4284-30RTML	\$4,989	\$5,058	\$10,138
	42	72	30	164	27	BU4272-30RTML	\$4,728	\$4,795	\$7,485
	42	60	30	147	23	BU4260-30RTML	\$4,492	\$4,560	\$7,249



- ships KD
- metal legs with removable wood surround to access and manage wires
- optional accessory hooks (four hooks) available, specify and add \$193 list, [see page BU11](#)
- EC26 worksurface power available, specify "to accommodate worksurface power" on your purchase order; one EC26 unit must be ordered separately, [see page BU23](#)
- EC27 under surface power available, [see page BU23](#)
- knife edge
- maple legs/apron standard
- walnut legs/apron available, specify and add \$376 list

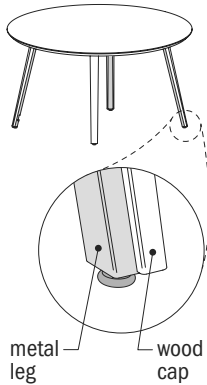
BOURNE

Description	D	W	H	CTN WT	CU FT	① Model	Flat Cut or HPL Laminate Top	Double Cut Top	Solid Surface Top
30" Square Table with Wood/Metal Legs	60	60	30	197	32	BU6060-30TTML	\$5,245	\$5,312	\$8,071
	48	48	30	153	21	BU4848-30TTML	\$4,648	\$4,713	\$6,822
	42	42	30	134	16	BU4242-30TTML	\$4,389	\$4,456	\$6,560



- ships KD
- metal legs with removable wood surround to access and manage wires
- optional accessory hooks (four hooks) available, specify and add \$193 list, [see page BU11](#)
- EC26 worksurface power available, specify "to accommodate worksurface power" on your purchase order; one EC26 unit must be ordered separately, [see page BU23](#)
- EC27 under surface power available, [see page BU23](#)
- knife edge
- maple legs/apron standard
- walnut legs/apron available, specify and add \$376 list

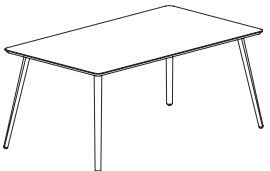
30" Round Table with Wood/Metal Legs	60	60	30	170	32	BU60-30RDML	\$4,918	\$4,984	\$7,730
--------------------------------------	----	----	----	-----	----	-------------	---------	---------	---------



- ships KD
- metal legs with removable wood surround to access and manage wires
- optional accessory hooks (four hooks) available, specify and add \$193 list, [see page BU11](#)
- EC26 worksurface power available, specify "to accommodate worksurface power" on your purchase order; one EC26 unit must be ordered separately, [see page BU23](#)
- EC27 under surface power available, [see page BU23](#)
- knife edge
- maple legs/apron standard
- walnut legs/apron available, specify and add \$376 list


To Order, Specify:

- ① Model Number
- ② Top Material:
 - a.) Veneer [See Veneer Top Finish Options](#)
 - 1.) Wood Species - Cherry (CH1), Maple (MA1), Walnut (WA1), Black Oak (BO1) or Double Cut (DC1)
 - a.) Finish Color
 - b.) Laminate [See Laminate Top Options](#)
 - 1.) Laminate Color
 - c.) Solid Surface [See Solid Surface Top Options](#)
- ③ Legs/Apron Species:
 - a.) Maple (M) [See Maple Legs/Apron Finish Options](#)
 - 1.) Finish Color - cherry, maple, black oak, walnut or paint color on maple legs/apron
 - b.) Walnut (W) [See Walnut Legs/Apron Finish Options](#) - upcharge applies
 - 1.) Finish Color - walnut finishes only on walnut legs/apron
- ④ Metal Leg Color [See Metal Leg Color Options](#)
- ⑤ Optional Accessory Hooks - four hooks; specify and add \$193 list, ([see page BU11](#))
- ⑥ Optional Power Units:
 - a.) Work Surface Power; specify with EC26 cut-out. EC26 must be ordered separately, ([see page BU23](#))
 - b.) Under Surface Power; mounts under top. EC27 must be ordered separately, ([see page BU23](#))

Description	D	W	H	CTN WT	CU FT	① Model	Flat Cut or HPL Laminate Top	Double Cut Top	Solid Surface Top
36" h Rectangular Table with Wood Legs 	48	90	36	202	38	BU4890-36TTWL	\$3,489	\$3,557	\$8,680
	48	84	36	192	35	BU4884-36TTWL	\$3,423	\$3,491	\$8,613
	48	72	36	172	30	BU4872-36TTWL	\$3,178	\$3,247	\$5,964
	42	90	36	184	33	BU4290-36TTWL	\$3,384	\$3,451	\$8,575
	42	84	36	175	31	BU4284-36TTWL	\$3,205	\$3,271	\$8,351
	42	72	36	158	27	BU4272-36TTWL	\$3,011	\$3,079	\$5,770
	36	72	36	143	23	BU3672-36TTWL	\$2,894	\$2,962	\$5,652

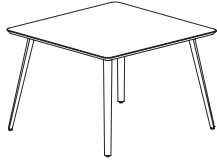
- ships KD
- optional accessory hooks (four hooks) available, specify and add \$193 list, [see page BU11](#)
- EC26 worksurface power available, specify "to accommodate worksurface power" on your purchase order; one EC26 unit must be ordered separately, [see page BU23](#)
- EC27 under surface power available, [see page BU23](#)
- knife edge
- maple legs/apron standard
- walnut legs/apron available, specify and add \$645 list

BOURNE

36" h Racetrack Table with Wood Legs 	48	90	36	185	38	BU4890-36RTWL	\$3,455	\$3,522	\$8,645
	48	84	36	175	35	BU4884-36RTWL	\$3,385	\$3,454	\$8,576
	48	72	36	155	30	BU4872-36RTWL	\$3,138	\$3,208	\$5,924
	42	90	36	171	33	BU4290-36RTWL	\$3,352	\$3,421	\$8,544
	42	84	36	162	31	BU4284-36RTWL	\$3,171	\$3,238	\$8,320
	42	72	36	145	27	BU4272-36RTWL	\$2,976	\$3,044	\$5,733
	42	60	36	127	23	BU4260-36RTWL	\$2,822	\$2,890	\$5,582

- ships KD
- optional accessory hooks (four hooks) available, specify and add \$193 list, [see page BU11](#)
- EC26 worksurface power available, specify "to accommodate worksurface power" on your purchase order; one EC26 unit must be ordered separately, [see page BU23](#)
- EC27 under surface power available, [see page BU23](#)
- knife edge
- maple legs/apron standard
- walnut legs/apron available, specify and add \$645 list

Description	D	W	H	CTN WT	CU FT	① Model	Flat Cut or HPL Laminate Top	Double Cut Top	Solid Surface Top
36" Square Table with Wood Legs	60	60	36	177	32	BU6060-36TTWL	\$3,284	\$3,351	\$6,111
	48	48	36	133	21	BU4848-36TTWL	\$2,813	\$2,879	\$4,983
	42	42	36	114	16	BU4242-36TTWL	\$2,697	\$2,764	\$4,870



- ships KD
- optional accessory hooks (four hooks) available, specify and add \$193 list, [see page BU11](#)
- EC26 worksurface power available, specify "to accommodate worksurface power" on your purchase order; one EC26 unit must be ordered separately, [see page BU23](#)
- EC27 under surface power available, [see page BU23](#)
- knife edge
- maple legs/apron standard
- walnut legs/apron available, specify and add \$645 list

36" Round Table with Wood Legs	60	60	36	151	32	BU60-36RDWL	\$3,225	\$3,293	\$6,052
--------------------------------	----	----	----	-----	----	-------------	---------	---------	---------



- ships KD
- optional accessory hooks (four hooks) available, specify and add \$193 list, [see page BU11](#)
- EC26 worksurface power available, specify "to accommodate worksurface power" on your purchase order; one EC26 unit must be ordered separately, [see page BU23](#)
- EC27 under surface power available, [see page BU23](#)
- knife edge
- maple legs/apron standard
- walnut legs/apron available, specify and add \$645 list

To Order, Specify:

- ① Model Number
- ② Top Material:
 - a.) Veneer [See Veneer Top Finish Options](#)
 - 1.) Wood Species - Cherry (CH1), Maple (MA1), Walnut (WA1), Black Oak (BO1) or Double Cut (DC1)
 - a.) Finish Color
 - b.) Laminate [See Laminate Top Options](#)
 - 1.) Laminate Color
 - c.) Solid Surface [See Solid Surface Top Options](#)
- ③ Legs/Apron Species:
 - a.) Maple (M) [See Maple Legs/Apron Finish Options](#)
 - 1.) Finish Color - cherry, maple, black oak, walnut or paint color on maple legs/apron
 - b.) Walnut (W) [See Walnut Legs/Apron Finish Options](#) - upcharge applies
 - 1.) Finish Color - walnut finishes only on walnut legs/apron
- ④ Optional Accessory Hooks - four hooks; specify and add \$193 list, ([see page BU11](#))
- ⑤ Optional Power Units:
 - a.) Work Surface Power; specify with EC26 cut-out. EC26 must be ordered separately, ([see page BU23](#))
 - b.) Under Surface Power; mounts under top. EC27 must be ordered separately, ([see page BU23](#))

Description	D	W	H	CTN WT	CU FT	Model	Flat Cut or HPL Laminate Top	Double Cut Top	Solid Surface Top
<p>36" h Rectangular Table with Wood/Metal Legs</p>	48	90	36	230	38	BU4890-36TTML	\$5,768	\$5,834	\$10,958
	48	84	36	220	35	BU4884-36TTML	\$5,652	\$5,719	\$10,842
	48	72	36	200	30	BU4872-36TTML	\$5,362	\$5,430	\$8,148
	42	90	36	212	33	BU4290-36TTML	\$5,593	\$5,661	\$10,783
	42	84	36	203	31	BU4284-36TTML	\$5,368	\$5,435	\$10,515
	42	72	36	186	27	BU4272-36TTML	\$5,132	\$5,196	\$7,886
	36	72	36	171	23	BU3672-36TTML	\$4,972	\$5,040	\$7,730

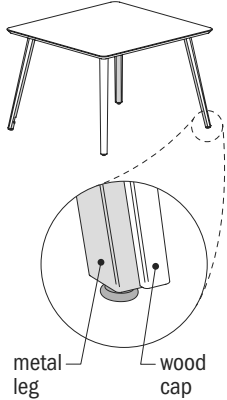
- ships KD
- metal legs with removable wood surround to access and manage wires
- optional accessory hooks (four hooks) available, specify and add \$193 list, [see page BU11](#)
- EC26 worksurface power available, specify "to accommodate worksurface power" on your purchase order; one EC26 unit must be ordered separately, [see page BU23](#)
- EC27 under surface power available, [see page BU23](#)
- knife edge
- maple legs/apron standard
- walnut legs/apron available, specify and add \$477 list

<p>36" h Racetrack Table with Wood/Metal Legs</p>	48	90	36	213	38	BU4890-36RTML	\$5,563	\$5,631	\$10,754
	48	84	36	203	35	BU4884-36RTML	\$5,437	\$5,506	\$10,629
	48	72	36	183	30	BU4872-36RTML	\$5,122	\$5,192	\$7,909
	42	90	36	199	33	BU4290-36RTML	\$5,427	\$5,493	\$10,616
	42	84	36	190	31	BU4284-36RTML	\$5,192	\$5,259	\$10,341
	42	72	36	173	27	BU4272-36RTML	\$4,929	\$4,998	\$7,687
	42	60	36	155	23	BU4260-36RTML	\$4,693	\$4,762	\$7,451

- ships KD
- metal legs with removable wood surround to access and manage wires
- optional accessory hooks (four hooks) available, specify and add \$193 list, [see page BU11](#)
- EC26 worksurface power available, specify "to accommodate worksurface power" on your purchase order; one EC26 unit must be ordered separately, [see page BU23](#)
- EC27 under surface power available, [see page BU23](#)
- knife edge
- maple legs/apron standard
- walnut legs/apron available, specify and add \$477 list

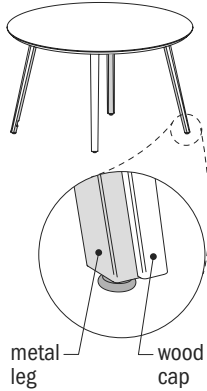
BOURNE

Description	D	W	H	CTN WT	CU FT	① Model	Flat Cut or HPL Laminate Top	Double Cut Top	Solid Surface Top
36" Square Table with Wood/Metal Legs	60	60	36	205	32	BU6060-36TTML	\$5,447	\$5,515	\$8,273
	48	48	36	161	21	BU4848-36TTML	\$4,850	\$4,918	\$7,023
	42	42	36	142	16	BU4242-36TTML	\$4,591	\$4,658	\$6,762



- ships KD
- metal legs with removable wood surround to access and manage wires
- optional accessory hooks (four hooks) available, specify and add \$193 list, [see page BU11](#)
- EC26 worksurface power available, specify "to accommodate worksurface power" on your purchase order; one EC26 unit must be ordered separately, [see page BU23](#)
- EC27 under surface power available, [see page BU23](#)
- knife edge
- maple legs/apron standard
- walnut legs/apron available, specify and add \$477 list


36" Round Table with Wood/Metal Legs	60	60	36	179	32	BU60-36RDML	\$5,118	\$5,186	\$7,935
--------------------------------------	----	----	----	-----	----	-------------	---------	---------	---------



- ships KD
- metal legs with removable wood surround to access and manage wires
- optional accessory hooks (four hooks) available, specify and add \$193 list, [see page BU11](#)
- EC26 worksurface power available, specify "to accommodate worksurface power" on your purchase order; one EC26 unit must be ordered separately, [see page BU23](#)
- EC27 under surface power available, [see page BU23](#)
- knife edge
- maple legs/apron standard
- walnut legs/apron available, specify and add \$477 list

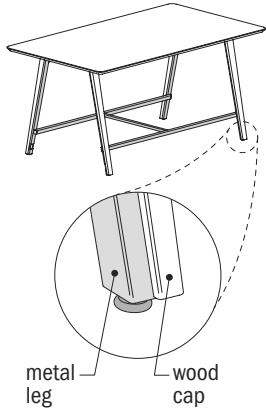
To Order, Specify:

- ① Model Number
- ② Top Material:
 - a.) Veneer [See Veneer Top Finish Options](#)
 - 1.) Wood Species - Cherry (CH1), Maple (MA1), Walnut (WA1), Black Oak (BO1) or Double Cut (DC1)
 - a.) Finish Color
 - b.) Laminate [See Laminate Top Options](#)
 - 1.) Laminate Color
 - c.) Solid Surface [See Solid Surface Top Options](#)
- ③ Legs/Apron Species:
 - a.) Maple (M) [See Maple Legs/Apron Finish Options](#)
 - 1.) Finish Color - cherry, maple, black oak, walnut or paint color on maple legs/apron
 - b.) Walnut (W) [See Walnut Legs/Apron Finish Options](#) - upcharge applies
 - 1.) Finish Color - walnut finishes only on walnut legs/apron
- ④ Metal Leg Color [See Metal Leg Color Options](#)
- ⑤ Optional Accessory Hooks - four hooks; specify and add \$193 list, ([see page BU11](#))
- ⑥ Optional Power Units:
 - a.) Work Surface Power; specify with EC26 cut-out. EC26 must be ordered separately, ([see page BU23](#))
 - b.) Under Surface Power; mounts under top. EC27 must be ordered separately, ([see page BU23](#))

Description	D	W	H	CTN WT	CU FT	Model	Flat Cut or HPL Laminate Top	Double Cut Top	Solid Surface Top
40" h Rectangular Table with Wood Legs 	48	90	40	219	38	BU4890-40TTWLH	\$4,641	\$4,707	\$9,830
	48	84	40	209	35	BU4884-40TTWLH	\$4,513	\$4,579	\$9,702
	48	72	40	189	30	BU4872-40TTWLH	\$4,239	\$4,305	\$7,023
	42	90	40	200	33	BU4290-40TTWLH	\$4,546	\$4,613	\$9,736
	42	84	40	192	31	BU4284-40TTWLH	\$4,317	\$4,385	\$9,466
	42	72	40	174	27	BU4272-40TTWLH	\$4,114	\$4,181	\$6,871

- ships KD
- optional accessory hooks (four hooks) available, specify and add \$193 list, [see page BU11](#)
- EC26 worksurface power available, specify "to accommodate worksurface power" on your purchase order; one EC26 unit must be ordered separately, [see page BU23](#)
- EC27 under surface power available, [see page BU23](#)
- metal foot rail
- knife edge
- maple legs/apron standard
- walnut legs/apron available, specify and add \$745 list

Description	D	W	H	CTN WT	CU FT	① Model	Flat Cut or HPL Laminate Top	Double Cut Top	Solid Surface Top
40" h Rectangular Table with Wood/Metal Legs	48	90	40	247	38	BU4890-40TTMLH	\$6,656	\$6,722	\$11,845
	48	84	40	237	35	BU4884-40TTMLH	\$6,493	\$6,560	\$11,684
	48	72	40	217	30	BU4872-40TTMLH	\$6,126	\$6,193	\$8,912
	42	90	40	228	33	BU4290-40TTMLH	\$6,558	\$6,627	\$11,750
	42	84	40	220	31	BU4284-40TTMLH	\$6,265	\$6,333	\$11,414
	42	72	40	202	27	BU4272-40TTMLH	\$5,981	\$6,049	\$8,739



- ships KD
- metal legs with removable wood surround to access and manage wires
- optional accessory hooks (four hooks) available, specify and add \$193 list, [see page BU11](#)
- EC26 worksurface power available, specify "to accommodate worksurface power" on your purchase order; one EC26 unit must be ordered separately, [see page BU23](#)
- EC27 under surface power available, [see page BU23](#)
- metal foot rail, color will be same as the metal leg
- knife edge
- maple legs/apron standard
- walnut legs/apron available, specify and add \$559 list

To Order, Specify:

- ① Model Number
- ② Top Material:
 - a.) Veneer [See Veneer Top Finish Options](#)
 - 1.) Wood Species - Cherry (CH1), Maple (MA1), Walnut (WA1), Black Oak (BO1) or Double Cut (DC1)
 - a.) Finish Color
 - b.) Laminate [See Laminate Top Options](#)
 - 1.) Laminate Color
 - c.) Solid Surface [See Solid Surface Top Options](#)
- ③ Legs/Apron Species:
 - a.) Maple (M) [See Maple Legs/Apron Finish Options](#)
 - 1.) Finish Color - cherry, maple, black oak, walnut or paint color on maple legs/apron
 - b.) Walnut (W) [See Walnut Legs/Apron Finish Options](#) - upcharge applies
 - 1.) Finish Color - walnut finishes only on walnut legs/apron
- ④ Metal Leg Color [See Metal Leg Color Options](#)
- ⑤ Optional Accessory Hooks - four hooks; specify and add \$193 list, ([see page BU11](#))
- ⑥ Optional Power Units:
 - a.) Work Surface Power; specify with EC26 cut-out. EC26 must be ordered separately, ([see page BU23](#))
 - b.) Under Surface Power; mounts under top. EC27 must be ordered separately, ([see page BU23](#))

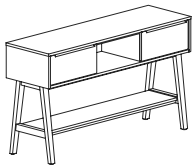
Description	D	W	H	CTN WT	CU FT	Model	Flat Cut Top	Double Cut Top
Tall Storage	18	30	42	115	6	BU1830-42STWR	\$3,312	\$3,513
	18	30	42	115	6	BU1830-42STWL	\$3,312	\$3,513



left shown

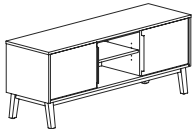
- hinged door cabinet contains two coat hooks standard
- open cabinet contains two adjustable shelves
- integrated clear anodized aluminum pull
- maple base standard
- walnut base available when walnut chassis is specified, specify and add \$172 list
- laminate top not available

Mid Storage	18	60	34	151	11	BU1860-34SCD	\$3,763	\$3,965
-------------	----	----	----	-----	----	---------------------	---------	---------



- two drawers
- open center cabinet
- veneer lower shelf
- integrated clear anodized aluminum pulls
- maple base standard
- walnut base available when walnut chassis is specified, specify and add \$273 list
- laminate top not available

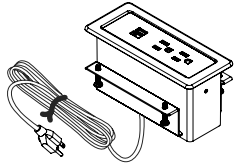
Low Storage	18	60	24	145	11	BU1860-24SCHD	\$3,600	\$3,803
-------------	----	----	----	-----	----	----------------------	---------	---------



- two single hinged door cabinets - both contain one adjustable shelf
- open center cabinet has one adjustable shelf
- integrated clear anodized aluminum pulls
- maple base standard
- walnut base available when walnut chassis is specified, specify and add \$241 list
- laminate top not available

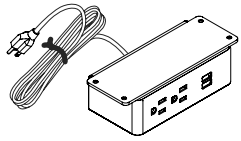
BOURNE

Description	D	W	H	CTN WT	CU FT	① Model	List Price
Worksurface Power	2 5/8	6 3/8	3	3	1	EC26	\$516



- two power receptacles - 120 volt; 15 amp dual powered USB
- 120" power cord with molded plug
- White (W) or Black (B) finish available, specify when ordering
- UL recognized
- meets UL spill requirements

Under Surface Power	3	6 1/2	1 13/16	2	1	EC27	\$406
---------------------	---	-------	---------	---	---	------	-------



- two power receptacles - 120 volt; 15 amp dual powered USB
- 120" power cord with molded plug
- White (W) or Black (B) finish available, specify when ordering
- UL recognized

To Order, Specify:

- ① Model Number
- ② Chassis Species - Cherry (CH1), Maple (MA1), Walnut (WA1), Black Oak (BO1) or Double Cut (DC1)
- ③ Base Species:
 - a.) Maple (M) - standard (finish same as chassis)
 - b.) Walnut (W) - upcharge applies; only available when walnut chassis is specified (finish same as chassis)
- ④ Chassis/Base Finish - [See Chassis Finish Options](#)
 - a.) Finish Color - cherry, maple, walnut, black oak or double cut
- ⑤ Door Finish [See Door Paint Color Options](#)
 - a.) Wood Finish - same as chassis
 - b.) Paint Color

Brogan

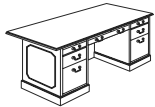


BROGAN

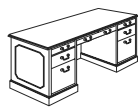
Desks [BG16](#)
 Modesty Panels [BG19, BG21](#)
 Returns and Bridges [BG22](#)
 Credenzas [BG24](#)
 Modular Components [BG26](#)
 Overhead Cabinets. [BG28](#)
 Wall Mount Storage [BG29](#)
 Tackboards [BG28](#)
 Transaction Counters. [BG30](#)
 Bookcases. [BG31](#)
 Lateral Files [BG32](#)
 Freestanding Tables [BG34](#)
 Storage Cabinets [BG35](#)

Brogan - Overview

Desks



Executive Double Pedestal Desk



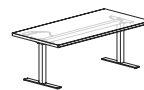
Double Pedestal Desk



Table Desk

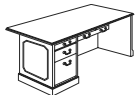


Electric Adjustable Height Table Desk

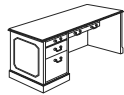


Pneumatic Adjustable Height Table Desk

Desk Applications

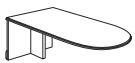


Single Pedestal Desk

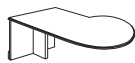


Single Pedestal Desk

Peninsula Desks



Bullet Peninsula Desk

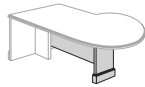


P-Top Peninsula Desk

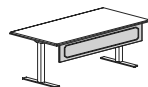
Peninsula Desk Bases and Modesty Panels



Column Base

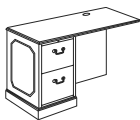


3/4 Modesty Panel

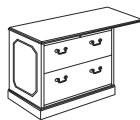


Adjustable Table Modesty Panel Page

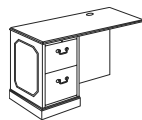
Return and Corner Unit Applications



File/File Return



Lateral File Return



File/File Corner

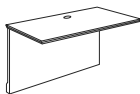


Lateral File Corner Return



Corner Unit

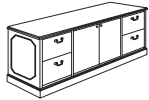
Bridge Applications



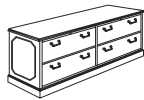
Executive Bridge

Brogan - Overview

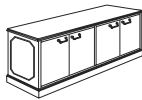
Credenzas



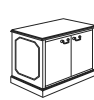
Storage Credenza



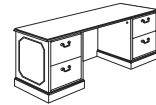
Lateral File Credenza



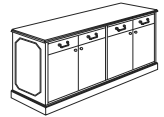
Four Door Credenza



Two Door Credenza

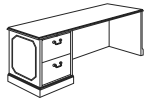


Kneespace Credenza

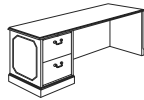


Buffet Credenza

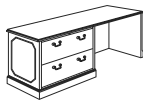
Credenza Applications



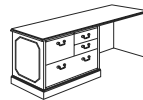
File/File Pedestal Credenza



File/File Reception Pedestal Credenza

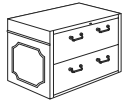


Lateral File Pedestal Credenza

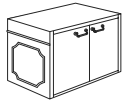


Multi-File Pedestal Credenza

Modular Applications



Modular Lateral File



Modular Storage Cabinet

Credenza Tops and Bases

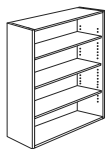


Modular Credenza Tops

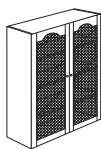


Modular Credenza Bases

Modular Bookcases



Modular Open Bookcase



Modular Grille Door Bookcase

Modular Bookcase Tops



Modular Bookcase Tops

Brogan - Overview

Overhead Cabinets



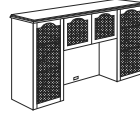
Open Storage Overhead Cabinet



Storage Overhead Cabinet with Four Doors



Storage Overhead Cabinet with Clear Glass

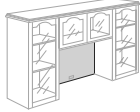


Storage Overhead Cabinet with Glass/Grille

Tackboards

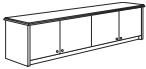


Tackboard for Storage Overhead Cabinet



Tackboard for Storage Overhead Cabinet

Wall Mount Storage



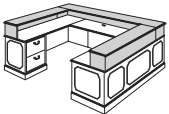
Wall Mount Overhead with Four Doors

Tackboards

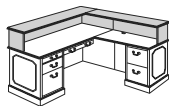


Wall Mount Tackboards

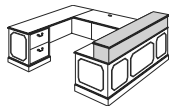
Transaction Counters



Transaction Counter for U Unit

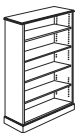


Transaction Counter for L Unit

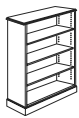


Transaction Counter

Bookcases



Bookcase



Bookcase



Bookcase

Lateral Files



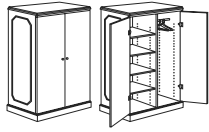
Lateral File



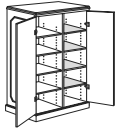
Lateral File

Brogan - Overview

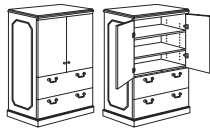
Storage Cabinets



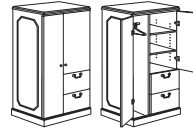
Wardrobe



Hanging Bar to Shelves
Conversion Kit



File/File Lateral
Storage Cabinet



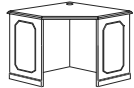
File/File Storage
Wardrobe

Printer Stand



Printer Stand

Corner Unit



Corner Unit

Tables



Sofa Table

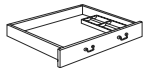


Magazine Table



End Table

Accessories

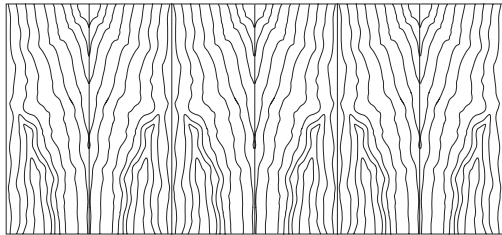


Center Drawer

Brogan Product Information

Exterior Wood Materials

Exterior surfaces are made from the finest selected veneers to achieve clarity and consistency in the Brogan product line. To attain a pleasing, symmetrical pattern, all veneers in Brogan are book-matched. All exterior solid lumber is matched to coordinate with the veneer.



Alternating pieces of veneer are flipped over so they face each other like the pages within a book.

Brogan is available in flat cut cherry and walnut veneer. A wide range of wood stains have been formulated to enhance the beauty of the veneer.

Work Surface Construction

Tops are 5-ply balanced construction, 1 3/8" thick with solid matching hardwood edges.

Coordinating high pressure laminate in a veneer grain pattern can be applied to the top surface and is available at no additional charge.

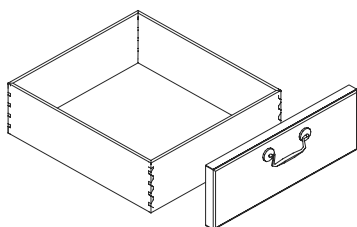
Case Construction

All construction is a combination of full mortise and tenon, reinforced with screws. Leveling glides are set in solid hardwood to prevent glides tear out.

Outside End Panels are 1 3/8" thick with 3-ply construction and rimmed with veneer bands.

Drawer Construction

Drawers are assembled using four corner, dovetailed box and 1/4" thick drawer bottom panel construction with exterior front attached separately. Sides and backs are 9-ply, 7/16" thick unidirectional hardwood. Interiors are sanded and finished with clear catalyzed varnish to protect against shrinking, swelling or warping, and to provide a clean, smooth feel and appearance.



Drawer Suspension

The high quality black drawer suspensions carry a lifetime warranty. Slides feature steel ball bearings for longer life with cushioned in/out stops. All drawers, including file and box drawers, fully extend past the pedestal chassis allowing full access to the drawer box.

Filing Hardware

All file drawers are constructed with a custom designed filing system in place to allow for hanging folders. Filing diagram on pages [BG14-BG15](#).

Locking

All desk, and lateral files feature central locking. Credenza and returns feature pedestal locking.

Units are shipped randomly keyed as standard. Key alike units are available upon request for no additional charges. Removable cores for in-field re-keying are standard.

Finish - Stain/Colors

We offer a variety of wood stains on Brogan. Please see the chart below. Samples are available upon request.

CH1 Cherry	<i>Flat Cut Veneer</i>
BBM Bourbon Medium	CLL Collectors
BRM Brighton Medium	HRV Harvest
CLA Classic	PRL Praline

WA1 Walnut	<i>Flat Cut Veneer</i>
ESP Espresso	TRF Truffle
MCH Mocha	UMB Umber
SIE Sienna	

Protective Top Coat

DuraTex™ offers exceptional hardness along with abrasion and impact resistance, it has been formulated to eliminate hazardous and harmful gases that are normally associated with wood finish.

DuraTex™ Features

Safety - Significantly reduces hazardous formaldehyde emissions, which help improve the quality of the indoor air we breathe.
Quality - Developed to be tough and durable with special attention to appearance. The DuraTex™ finish preserves the natural beauty of wood.
Durability - Designed to meet a wide range of demanding performance and environmental standards to withstand even the highest wear and tear.

Laminate Tops

Work surface only, no additional upcharge if Brogan's coordinating wood grain laminate is specified. Contact Customer Service for any other laminate request. Listed below are finishes that have coordinating wood grain HPL laminates.

CH1 Cherry	<i>Flat Cut Veneer</i>
CLL Collectors	
HRV Harvest	
PRL Praline	

WA1 Walnut	<i>Flat Cut Veneer</i>
MCH Mocha	TRF Truffle
SIE Sienna	UMB Umber

Brogan Product Information

Product Modification

Special Finishes

Special finishes can be requested by following the instruction in the general introduction section. There is a one time charge of \$372 list per order.

Special Veneer

Upon request standard veneer can be changed to a special veneer contact Customer Service for availability and pricing.

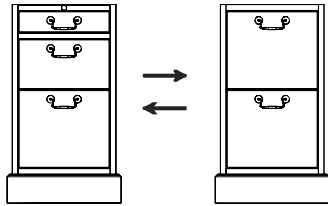
Finish Sheen

All veneer finishes, for Brogan, are standard in 35-sheen. All other finishes can have their sheen modified with a 15% upcharge added to the list price of each item.

Pedestal Configuration Change

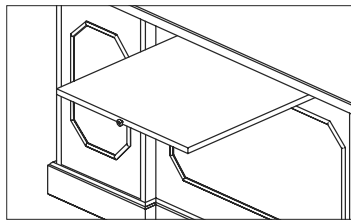
Writing shelf-tray-box-file drawer configuration standard on desk pedestals. Desk pedestal only can be switched out to a file-file configuration. Must be specified at the time of order with an additional \$192 list per pedestal.

Changing to a file-file pedestal configuration will eliminate the writing shelf (arm slide).



Desk Dictation Slide

The approach side of the desk in the center break front area has an option of a center pullout dictation slide. Add \$481 to the list price of the desk.

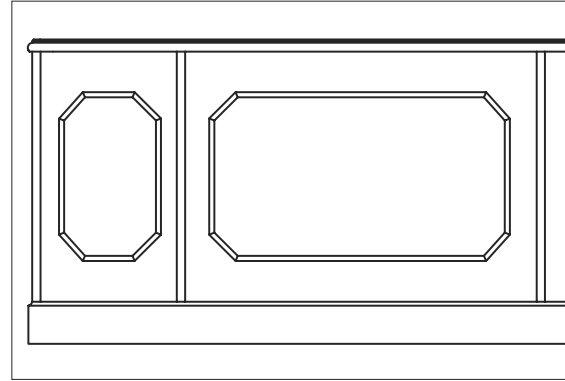


Product Modification

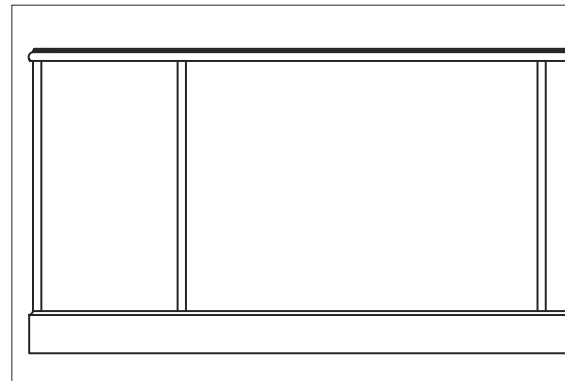
Trim Molding

Angled Trim molding is standard on all Brogan products.

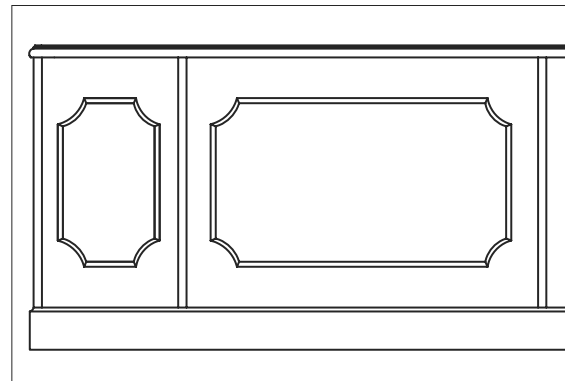
Without molding or Scalloped Trim molding can be specified at the time of order placement.



Angled Trim
standard



Base Molding Only (without trim)
optional at no charge



Scalloped Trim

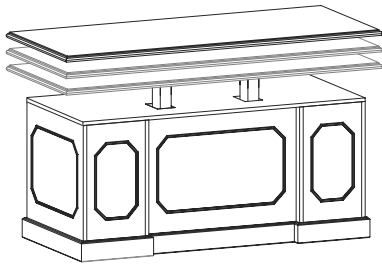
optional with upcharge to list for each item

\$146 for all desk

\$76 for all other product with standard trim molding

Brogan Product Information

BROGAN



ERGO Adjustable Work Height Mechanism

Our proprietary adjustable work height mechanism can be specified on many of the models in Brogan.

ERGO mechanism allows height adjustability to be added to the worksurface. Our solution uses a standardized design that minimizes the modifications required to standard desk, bridge, or credenza models. The mechanism and control box are neatly concealed to maintain the appearance of the original elegance of the product. A push button activates the electric powered lifting columns for adjustability from sitting height to a standing height. A 3/4" thick finished sub top is added to the top of the desk chassis for a clean appearance when the surface is in the raised position. In the lowered position, please note that ERGO adds 3/4" to the standard height of the desk and the installation will decrease kneespace depth by 8".

Automatic Collision Control is built into each mechanism as a standard feature. When the system senses an obstacle obstructing the movement, the mechanism will reverse direction and retreat by 1".

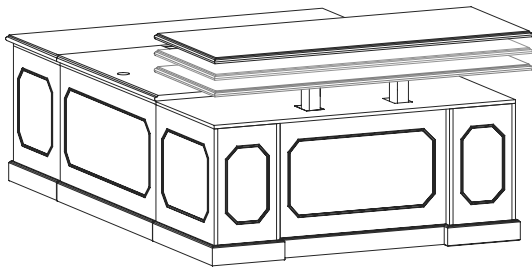
When ERGO is added to a desk worksurface in a "L" or "U" group, the unit that connects to the desk also needs to have a sub top added. These units are considered to be ERGO ADJACENT units. ERGO ADJACENT units must have a fixed height worksurface that matches the lowest position of the ERGO mechanism and the top. This is accomplished by adding a 3/4" sub top between the chassis and the worksurface. This feature can also be specified for cabinets which may sit next to a unit with the ERGO mechanism.

Height adjustment starts at 30 3/4", to a standing height of 50 1/4", a range of 19 1/2".

To specify the unit that has the mechanism, add **ERGO** to the end of the model number.
To specify the connecting or adjacent units add, **ERGO ADJACENT** to the end of the model number.

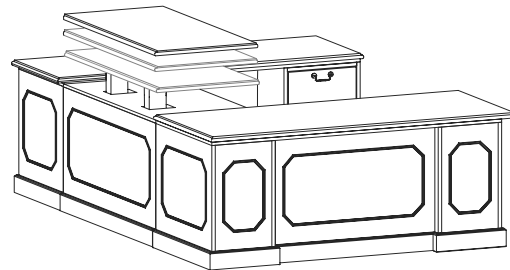
Note: The kneespace depth is decreased when the ERGO mechanism is specified. Contact Customer Service for dimension information.

The Ergo mechanism and controls are warranted for a period of (1) year. The rest of the casegood unit(s) are warranted under the Lifetime Warranty.



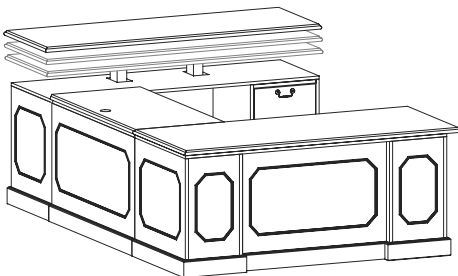
Example

BG3672LD-ERGO	add \$4,835 to list
BG2448EB-ERGO ADJACENT	add \$606 to list
BG2472RC-ERGO ADJACENT	add \$711 to list



Example

BG3672LD-ERGO ADJACENT	add \$711 to list
BG2448EB-ERGO	add \$4,835 to list
BG2472RC-ERGO ADJACENT	add \$711 to list



Example

BG3672LD-ERGO ADJACENT	add \$711 to list
BG2448EB-ERGO ADJACENT	add \$606 to list
BG2472RC-ERGO	add \$4,835 to list

Brogan Product Information

Availability of Brogan Units with the Mechanism

The following models are available with the ERGO Adjustable Work Height Mechanism. When specifying add "ERGO" to the end of the model number.

Adjacent Connecting Units - Models below require adjacent products to create "L" or "U" layouts; add \$4,835 to the list price.

Single Pedestal Desk	Bridges	Credenzas	Returns	Corner Units
BG3672LD	BG2448EB	BG2472LC	BG2448ELCR	BG4242CU
BG3672RD	BG2442EB	BG2472RC	BG2448ERCR	BG4242ELCU
BG3072LD	BG2436EB	BG2466LC	BG2448ELR	BG4242ERCU
BG3072RD		BG2466RC	BG2448ERR	
BG3066LD			BG2442ELCR	
BG3066RD			BG2442ERCR	
			BG2442ELR	
			BG2442ERR	

Freestanding Units - Models below do not require adjacent products; add \$4,835 to the list price.

Double Pedestal Desk	Credenzas
BG4284ED	BG2472KC
BG4278ED	BG2466KC
BG3672ED	
BG3672DD	
BG3072DD	
BG3066DD	
BG3060DD	

Connecting or Adjacent Units to Match Starting Height

All the units listed above can be specified as connecting or adjacent units. Other Brogan units could also be used as connecting units. Please contact Customer Service for additional items and pricing. When specifying, please add "ERGO ADJACENT" to the end of the model number.

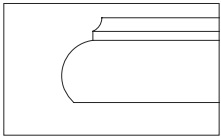
Pricing for Standard Connecting or Adjacent Units
 Tops larger than 24" x 48" add \$711 to list price.
 Tops 24" x 48" or smaller add \$606 to list price.

Brogan Product Information

Edge and Hardware

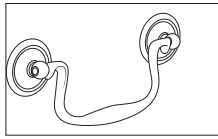
Brogan offers a traditional edge profile and three drawer pulls. Hardware is available in antique brass or antique pewter.

Edge Profile

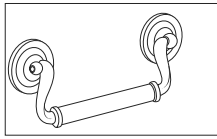


Brogan Edge Profile
Accepts Laminate Top

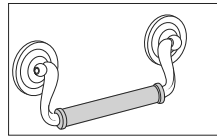
Drawer Hardware



Brogan Hardware
Antique Brass (ANB)
Antique Pewter (ANP)



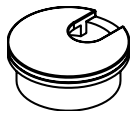
Gala Hardware
Antique Brass (ANB)
Antique Pewter (ANP)



Gala Leather Wrapped Hardware
Antique Brass (ANB)
Antique Pewter (ANP)

Optional matching leather wrapped pulls available for desk with leather inlay or other coordinating units. Specify leather wrapped pulls, add \$59 list upcharge per pull. Indicate Antique Brass (ANB) or Antique Pewter (ANP) pull.

Worksurface Grommets



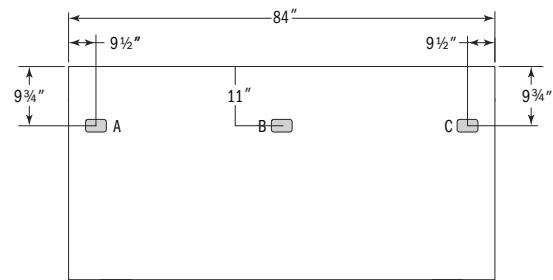
Worksurface Grommet
Antique Brass (ANB)
Black (BLK)

Worksurface grommets are standard on bridges, corner units, returns and the backs of overheads. Additional worksurface grommets can be specified on desks, credenzas, and other types of veneer/laminate worksurfaces. The grommet location must be approved by JSI manufacturing, contact Customer Service.

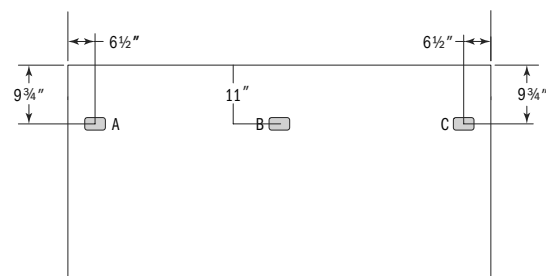
Add \$114 to the list for each additional grommet.

Models with an Antique Brass pull will receive an Antique Brass grommet, those with an Antique Pewter pull will receive a Black grommet.

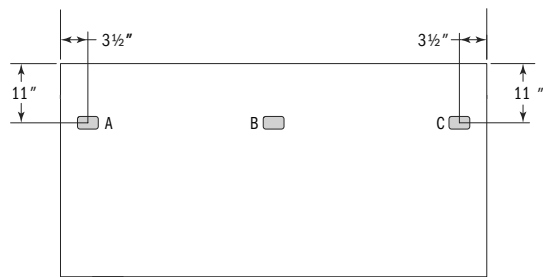
BG4284ED



BG4278ED and BG3672ED



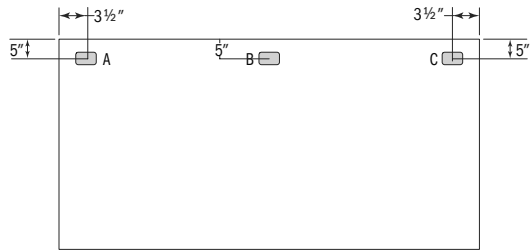
BG3672RD and BG3672LD



Brogan Product Information

Grommet and Color Options Continued

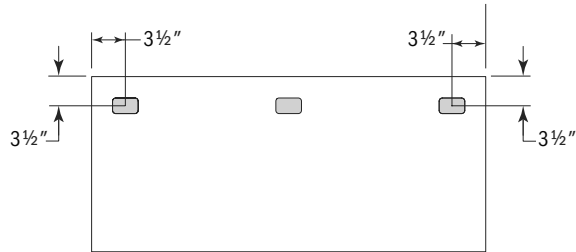
Desk without Overhang



Support End and Run-Off Desks



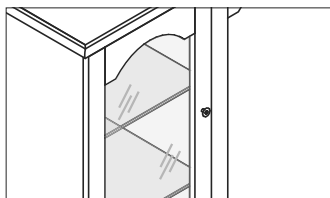
Bridges, Returns and Credenzas



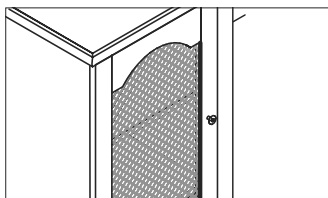
Brogan Product Information

Decorative Doors

Brogan offers four overhead cabinet models with two door styles, 72" & 66" wide overhead with clear glass doors and 72" & 66" wide overhead with open glass/grille mesh in two finishes, Antique Brass and Antique Pewter.



Clear Glass (not low iron)
with clear glass shelves



Glass/Grille
Antique Brass (ANB)
Antique Pewter (ANP)

3-Piece Leather Inlay

Brogan can be enhanced with a 3-Piece Leather Inlay, which may be added to the worksurface of any freestanding desk excluding the adjustable height table desk for a \$2,487 list price upcharge.

Models

BG4284ED	BG3672DD	BG3672TD	BG3672RD	BG3066RD
BG4278ED	BG3072DD	BG3066TD	BG3672LD	BG3066LD
BG3672ED	BG3066DD		BG3072RD	
	BG3060DD		BG3072LD	

Cortina Leather Options

Caprone
Old English

Leather Inlay is limited to specific style and thickness of leather.
Call Customer Service for more information.
Visit jsifurniture.com for leather colors.



Brogan Product Information

Finish and Product Reference Codes

Select	Code
--------	------

Veneer

Cherry	CH1
Walnut	WA1

Finish

Cherry Finishes

Bourbon Medium	BBM
Brighton Medium	BRM
Classic	CLA
Collectors	CLL
Harvest	HRV
Praline	PRL

Walnut Finishes

Espresso	ESP
Mocha	MCH
Sienna	SIE
Truffle	TRF
Umber	UMB

Laminate Coordinates

Cherry Finishes

Collectors	CLL
Harvest	HRV
Praline	PRL

Walnut Finishes

Mocha	MCH
Sienna	SIE
Truffle	TRF
Umber	UMB

Select	Code
--------	------

Top Edge Profile

Traditional Edge

Pull/Hardware Finish

Brogan

Antique Brass	ANB
Antique Pewter	ANP

Gala

Antique Brass	ANB
Antique Pewter	ANP

Molding Trim

Angled Trim

Base Molding Only

Scalloped Trim

see page BG7 price add-on

Top Grommet Finish

2" dia. Antique Brass

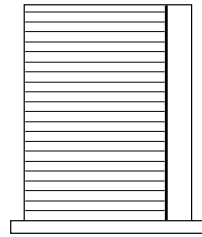
2" dia. Black

Brogan Product Information

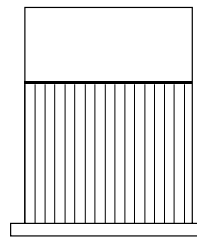
Standard Filing Option & Interior Drawer Sizes

- Models
 BG4284ED Desk
 BG4278ED Desk
 BG3672ED Desk
 BG3672DD Desk

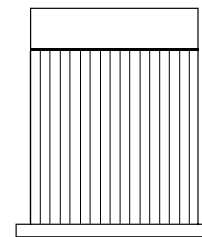
	D	W	H
Tray	21"	14 7/8"	1 7/8"
Box	21"	14 7/8"	4 1/4"
File	21"	14 7/8"	9 3/8"



Legal
Front to Back



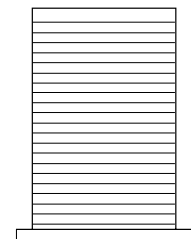
Letter
Side to Side



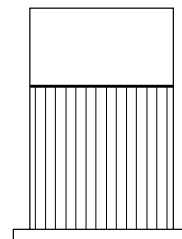
Legal
Side to Side Only

- Models
 BG3072DD Desk
 BG3066DD Desk
 BG3060DD Desk
 BG3672RD Desk
 BG3672LD Desk
 BG3072RD Desk
 BG3072LD Desk
 BG3066RD Desk
 BG3066LD¹ Desk

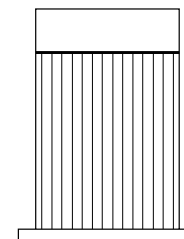
	D	W	H
Tray	21"	11 7/8"	1 7/8"
Box	21"	11 7/8"	4 1/4"
File	21"	11 7/8"	9 3/8"



Letter
Front to Back



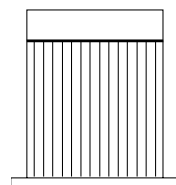
Letter
Side to Side



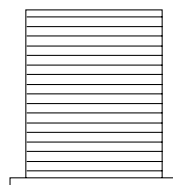
Legal
Side to Side

- Models
 BG2472SC Storage Credenza
 BG2466SC Storage Credenza
 BG2472KC Kneespace Credenza
 BG2466KC Kneespace Credenza

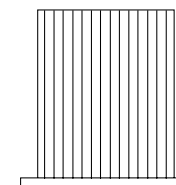
	D	W	H
File	21"	11 7/8"	9 3/8"



Letter
Side to Side



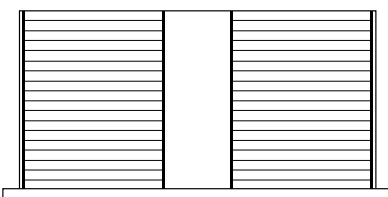
Legal
Front to Back



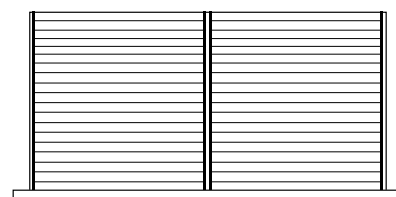
Legal
Side to Side

- Models
 BG2472LFC Lateral File Credenza
 BG3654LF Lateral File Cabinet
 BG3630LF Lateral File Cabinet

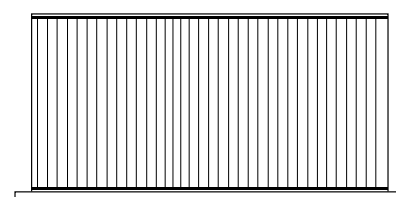
	D	W	H
Lateral File	15 1/4"	31"	9 3/8"



Letter
Double Front to Back



Legal
Double Front to Back

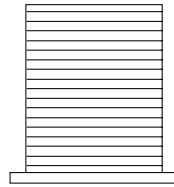


Legal
Side to Side

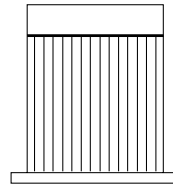
Brogan Product Information

Models

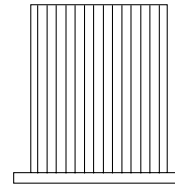
BG2448ERR	Return
BG2448ELR	Return
BG2448ERCR	Return
BG2448ELCR	Return
BG2442ERR	Return
BG2442ELR	Return
BG2442ERCR	Return
BG2442ELCR	Return
BG2448LRR	Return
BG2448LLR	Return
BG2448LLR	Return
BG2448LRCR	Return
BG2448LLCR	Return
BG3672SWLF	Storage Cabinet
BG2472SWR	Storage Cabinet
BG2472SWL	Storage Cabinet



Letter
Front to Back

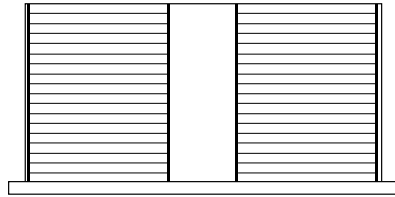


Letter
Side to Side

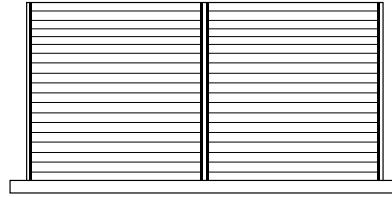


Legal
Side to Side Only

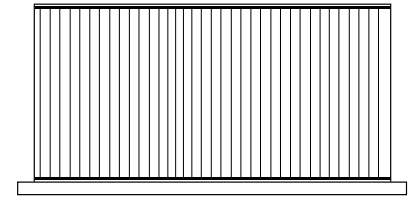
	D	W	H
File	15 1/4"	11 7/8"	9 3/8"
Lateral	15 1/4"	31"	9 3/8"



Letter
Double Front to Back



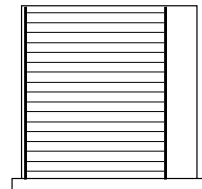
Legal
Double Front to Back



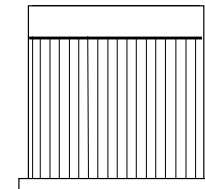
Legal
Side to Side

Models

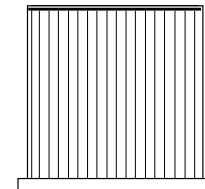
BG2472RC	Credenza
BG2472LC	Credenza
BG2466RC	Credenza
BG2466LC	Credenza
BG2472RCR	Credenza
BG2472LCR	Credenza
BG2472LRC	Credenza
BG2472LLC	Credenza
BG2472MRC	Credenza
BG2472MLC	Credenza



Legal
Front to Back

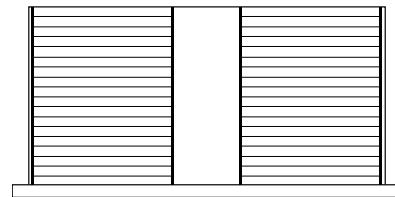


Letter
Side to Side

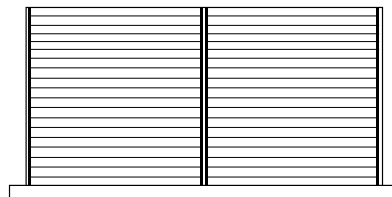


Legal
Side to Side

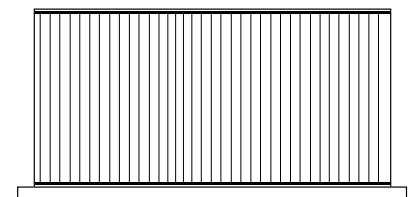
	D	W	H
File	15 1/4"	14 7/8"	9 3/8"
Lateral	15 1/4"	31"	9 3/8"



Letter
Double Front to Back



Legal
Double Front to Back



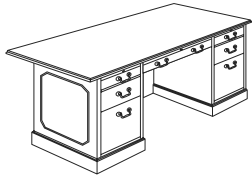
Legal
Side to Side

Other Models

BG2472BSC	Buffet Credenza
BG3672TD & BD3066TD	Table Desk
BG1826CDB	Center Drawer

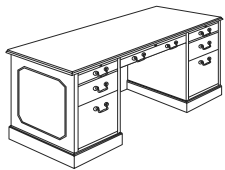
Drawer Type	D	W	H
Box Drawer	15 1/4"	14 3/16"	4 1/4"
Pencil Drawer	19 7/16"	23"	1 7/8"
Pencil Drawer	16"	26"	1 7/8"

Description	D	W	H	CTN WT	CU FT	① Model	List Price
Executive Desk	42	84	30	480	71	BG4284ED	\$6,957
	42	78	30	460	66	BG4278ED	\$6,206
	36	72	30	340	53	BG3672ED	\$4,832



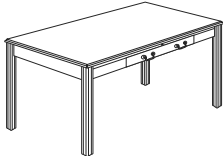
- locking center drawer
- central locking
- writing shelf/tray/box/file
- 3-piece leather inlay available, specify and \$2,487 add list
- BG4284ED has a 6" overhang on each end and 6" overhang on the approach side
- BG4278ED & BG3672ED has a 3" overhang on each end and 6" overhang on the approach side
- BG4284ED & BG4278ED have legal width pedestals
- BG3672ED has letter width pedestals
- BG4284ED chassis - 36" x 72"
- BG4278ED chassis - 36" x 72"
- BG3672ED chassis - 30" x 66"
- BG4284ED kneespace - 33"
- BG4278ED kneespace - 33"
- BG3672ED kneespace - 33"
- 24 $\frac{7}{8}$ " clearance from floor to bottom of center drawer

Double Pedestal Desk	36	72	30	435	53	BG3672DD	\$5,358
	30	72	30	320	44	BG3072DD	\$4,692
	30	66	30	310	41	BG3066DD	\$4,554
	30	60	30	300	37	BG3060DD	\$4,250



- writing shelf/tray/box/file
- letter width pedestals
- locking center drawer
- central locking
- 3-piece leather inlay available, specify and \$2,487 add list
- BG3672DD chassis - 36" x 72"
- BG3072DD chassis - 30" x 72"
- BG3066DD chassis - 30" x 66"
- BG3060DD chassis - 30" x 60"
- BG3672DD, BG3072DD and BG3066DD kneespace - 33"
- BG3060DD kneespace - 27"
- 24 $\frac{7}{8}$ " clearance from floor to bottom of center drawer

Description	D	W	H	CTN WT	CU FT	① Model	List Price
Table Desk	36	72	30	170	53	BG3672TD	\$3,785
	30	66	30	150	41	BG3066TD	\$3,323

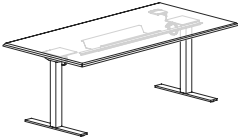


- locking center drawer
- 24⁷/₈" clearance from floor to bottom of center drawer
- 3-piece leather inlay available, specify and \$2,487add list

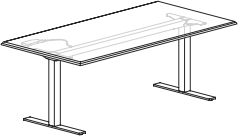
BROGAN

To Order, Specify:

- ① Model Number
- ② Wood Species - Cherry (CH1) or Walnut (WA1) ([see page BG13](#))
- ③ Finish Color ([see page BG13](#))
- ④ Pull Style and Color ([see page BG13](#))
- ⑤ Other Product Options ([see page BG7-BG12](#))
- ⑥ Accessories, Power and Data

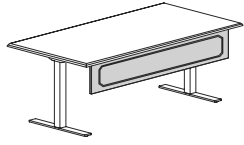
Description	D	W	H	CTN WT	CU FT	① Model	List Price
Electric Adjustable Height Table Desk 	36	72	Adj.	194	18	BG3672AHTD-EL	\$3,143
	30	72	Adj.	175	16	BG3072AHTD-EL	\$3,022
	30	66	Adj.	168	15	BG3066AHTD-EL	\$2,988
	30	60	Adj.	160	14	BG3060AHTD-EL	\$2,952
	24	72	Adj.	151	12	BG2472AHTD-EL	\$2,902
	24	66	Adj.	146	11	BG2466AHTD-EL	\$2,872
	24	60	Adj.	140	10	BG2460AHTD-EL	\$2,845

- 22 ½"- 49" height adjustment
- top edge profile on user and approach sides
- push button control pad mounted right or left
- maximum weight rating 140 lbs. (evenly distributed load)
- key pad features height display with three memory settings
- display will reference position to the nearest ½"
- 120" power cord
- specify Matte Black (MBK) or Arctic Silver (STS) base finish
- ships KD

Pneumatic Adjustable Height Table Desk 	36	72	Adj.	194	18	BG3672AHTD-PN	\$5,504
	30	72	Adj.	175	16	BG3072AHTD-PN	\$5,267
	30	66	Adj.	168	15	BG3066AHTD-PN	\$5,112
	30	60	Adj.	160	14	BG3060AHTD-PN	\$4,951
	24	72	Adj.	151	12	BG2472AHTD-PN	\$4,931
	24	66	Adj.	146	11	BG2466AHTD-PN	\$4,845
	24	60	Adj.	140	10	BG2460AHTD-PN	\$4,741

- 27 ½"- 44 ½" height adjustment
- top edge profile on all sides
- release lever mounts under edge of top
- 225 lb. max load
- specify Matte Black or Alloy base finish
- ships KD

Description	D	W	H	CTN WT	CU FT	① Model	List Price
Modesty Panels for Adjustable Height Tables	¾	64	12	18	2	BG0964TDM	\$792
	¾	58	12	16	2	BG0958TDM	\$766
	¾	52	12	14	2	BG0952TDM	\$747



- BG0964TDM use with 72" wide adjustable height desk
- BG0958TDM use with 66" wide adjustable height desk
- BG0952TDM use with 60" wide adjustable height desk
- flat edge detail
- modesty panel bracket is available in Black Sandtex (BSX) or Stardust Silver (STS)

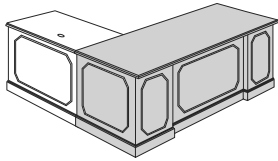
BROGAN

To Order, Specify:

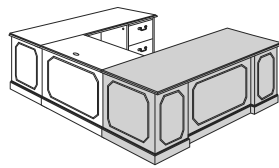
- ① Model Number
- ② Wood Species - Cherry (CH1) or Walnut (WA1) ([see page BG13](#))
- ③ Finish Color ([see page BG13](#))
- ④ Pull Style and Color ([see page BG13](#))
- ⑤ Other Product Options ([see page BG7-BG12](#))
- ⑥ Accessories, Power and Data

Desk Applications

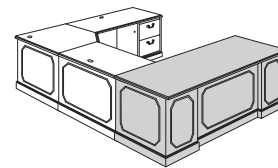
Executive L



Executive U

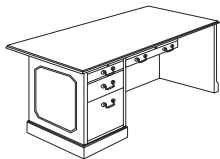


Computer U



BROGAN

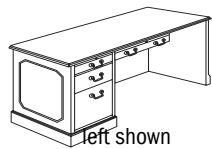
Description	D	W	H	CTN WT	CU FT	① Model	List Price
Single Pedestal Desk	36	72	30	270	53	BG3672RD	\$4,554
	36	72	30	270	53	BG3672LD	\$4,554



left shown

- 6" overhang on approach side
- chassis - 30" x 72"
- writing shelf/tray/box/file
- letter width pedestals
- locking center drawer
- central locking
- 3-piece leather inlay available, specify and \$2,487 add list

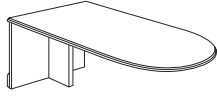
Single Pedestal Desk	30	72	30	260	44	BG3072RD	\$4,402
	30	72	30	260	44	BG3072LD	\$4,402
Single Pedestal Desk	30	66	30	240	41	BG3066RD	\$4,250
	30	66	30	240	41	BG3066LD	\$4,250



left shown

- writing shelf/tray/box/file
- letter width pedestals
- locking center drawer
- central locking
- 3-piece leather inlay available, specify and \$2,487 add list

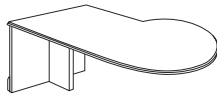
Description	D	W	H	CTN WT	CU FT	① Model	List Price
Bullet Peninsula Desk	36	72	30	185	53	BG3672RB	\$4,829
	36	72	30	185	53	BG3672LB	\$4,829
	30	72	30	177	44	BG3072RB	\$4,702
	30	72	30	177	44	BG3072LB	\$4,702



right shown

- not recommended for freestanding use
- bases must be purchased separately; see below for options

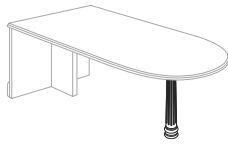
P-Top Peninsula Desk	42	72	30	210	58	BG4272RP	\$4,840
	42	72	30	210	58	BG4272LP	\$4,840



right shown

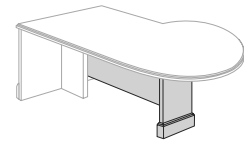
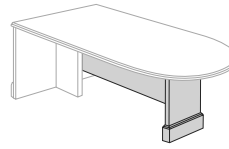
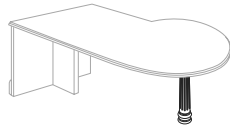
- 42" at widest point
- 36" at end panel
- not recommended for freestanding use
- bases must be purchased separately; see below for options

Bases Options and Modesty Panels for Peninsula Tops
(these bases must be ordered separately from the desks listed above)



Wood Column Base
· 04WB - Wood \$867

Base:
· 4" diameter

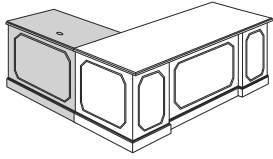


3/4 Modesty Panel
· BG2454RMP - right \$1,018
· BG2454LMP - left \$1,018

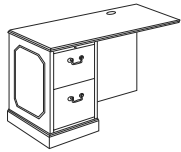
To Order, Specify:

- ① Model Number
- ② Wood Species - Cherry (CH1) or Walnut (WA1) (see page BG13)
- ③ Finish Color (see page BG13)
- ④ Pull Style and Color (see page BG13)
- ⑤ Other Product Options (see page BG7-BG12)
- ⑥ Accessories, Power and Data

Return Applications - Executive L



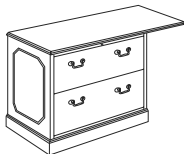
Description	D	W	H	CTN WT	CU FT	① Model	List Price
Executive Return	24	48	30	145	25	BG2448ERR	\$3,148
	24	48	30	145	25	BG2448ELR	\$3,148
	24	42	30	140	22	BG2442ERR	\$3,033
	24	42	30	140	22	BG2442ELR	\$3,033



left shown

- one surface grommet
- short grain direction
- letter width file/file pedestal
- pedestal locking

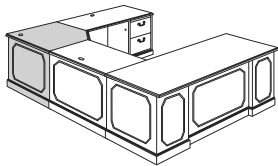
Lateral File Return	24	48	30	170	25	BG2448LRR	\$3,834
	24	48	30	170	25	BG2448LLR	\$3,834



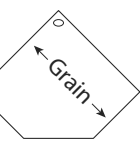
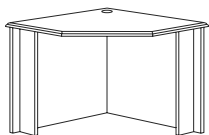
left shown

- 36" width lateral file
- no grommet
- short grain direction
- pedestal locking

Corner Unit Applications - Computer U



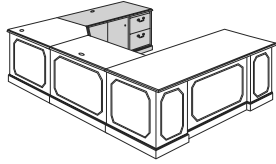
Description	D	W	H	CTN WT	CU FT	① Model	List Price
Executive Corner Unit	42	42	30	165	36	BG4242ERCU	\$3,181
	42	42	30	165	36	BG4242ELCU	\$3,181
	36	36	30	148	27	BG3636ERCU	\$2,930
	36	36	30	148	27	BG3636ELCU	\$2,930



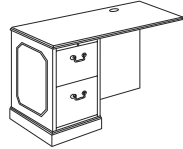
right shown

- straight grain top; direction determined by right and left units
- not for freestanding use
- use with pedestal return
- one surface grommet

Corner Return Applications - Computer U



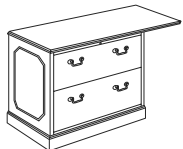
Description	D	W	H	CTN WT	CU FT	① Model	List Price
Executive Corner Return	24	48	30	145	25	BG2448ERCR	\$3,148
	24	48	30	145	25	BG2448ELCR	\$3,148
	24	42	30	140	22	BG2442ERCR	\$3,033
	24	42	30	140	22	BG2442ELCR	\$3,033



left shown

- use with corner unit
- one surface grommet
- long grain direction
- letter width file/file pedestal
- pedestal locking

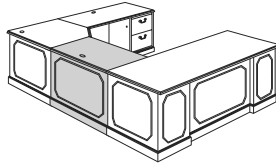
Lateral File Corner Return	24	48	30	170	25	BG2448LRCR	\$3,834
	24	48	30	170	25	BG2448LLCR	\$3,834



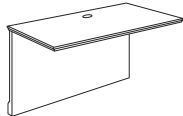
left shown

- use with corner unit
- 36" width lateral file
- anti-tip interlock mechanism
- no grommet
- long grain direction
- pedestal locking

Bridge Applications - Executive U



Description	D	W	H	CTN WT	CU FT	① Model	List Price
Executive Bridge	24	48	30	105	4	BG2448EB	\$1,601
	24	42	30	95	3	BG2442EB	\$1,475
	24	36	30	85	3	BG2436EB	\$1,374

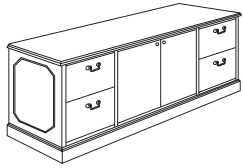


- one surface grommet
- short grain direction

To Order, Specify:

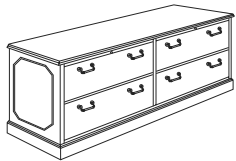
- ① Model Number
- ② Wood Species - Cherry (CH1) or Walnut (WA1) (see page BG13)
- ③ Finish Color (see page BG13)
- ④ Pull Style and Color (see page BG13)
- ⑤ Other Product Options (see page BG7-BG12)
- ⑥ Accessories, Power and Data

Description	D	W	H	CTN WT	CU FT	① Model	List Price
Storage Credenza Hinged Doors	24	72	30	290	36	BG2472SC	\$4,747
	24	66	30	270	33	BG2466SC	\$4,469



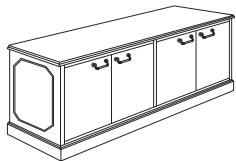
- legal width file/file pedestals
- adjustable shelf in center storage
- grommet located in top center of back panel
- pedestal locking
- locking doors available, specify and add \$142 list

Lateral File Credenza	24	72	30	300	36	BG2472LFC	\$4,938
-----------------------	----	----	----	-----	----	-----------	---------



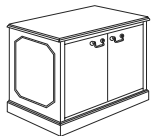
- two drawer lateral files side by side
- anti-tip interlock mechanism
- pedestal locking

Four Door Credenza	24	72	30	310	33	BG2472DSC	\$4,747
--------------------	----	----	----	-----	----	-----------	---------



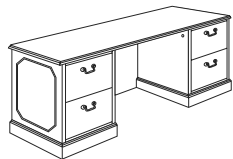
- adjustable shelves
- locking doors available, specify and add \$284 list

Two Door Credenza	24	36	30	90	15	BG3630SC	\$2,449
-------------------	----	----	----	----	----	----------	---------



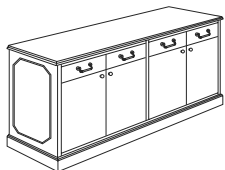
- one adjustable shelf
- locking doors available, specify and add \$142 list

Kneespace Credenza	24	72	30	240	36	BG2472KC	\$4,469
	24	66	30	220	33	BG2466KC	\$4,179



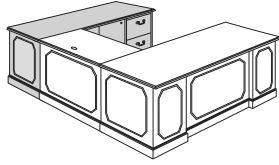
- legal width file/file pedestals
- grommet located in top center of back panel
- pedestal locking
- kneespace for BG2472KC - 33"
- kneespace for BG2466KC - 27"

Buffet Credenza	24	72	36	330	43	BG2472BSC	\$6,172
-----------------	----	----	----	-----	----	-----------	---------



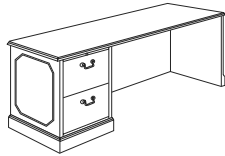
- four door credenza
- four box drawers above doors
- locking not available
- adjustable shelf in storage cabinet

Credenza Applications - Executive U



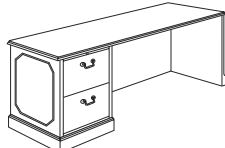
Description	D	W	H	CTN WT	CU FT	① Model	List Price
Pedestal Credenza	24	72	30	220	36	BG2472RC	\$4,092
	24	72	30	220	36	BG2472LC	\$4,092
left shown	24	66	30	210	33	BG2466RC	\$3,723
	24	66	30	210	33	BG2466LC	\$3,723

- grommet located in top center of back panel
- legal width file/file pedestal
- pedestal locking



left shown

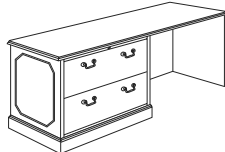
Reception Pedestal Credenza	24	72	30	220	36	BG2472RCR	\$4,092
	24	72	30	220	36	BG2472LCR	\$4,092



left shown

- no grommet
- legal width file/file pedestal
- pedestal locking

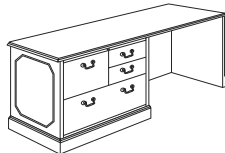
Lateral Pedestal Credenza	24	72	30	230	36	BG2472LRC	\$4,660
	24	72	30	230	36	BG2472LLC	\$4,660



left shown

- no grommet
- pedestal locking

Multi-File Pedestal Credenza	24	72	30	265	36	BG2472MRC	\$4,844
	24	72	30	265	36	BG2472MLC	\$4,844



left shown

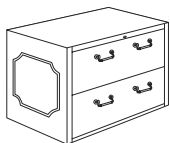
- no grommet
- pedestal locking

To Order, Specify:

- ① Model Number
- ② Wood Species - Cherry (CH1) or Walnut (WA1) (see page BG13)
- ③ Finish Color (see page BG13)
- ④ Pull Style and Color (see page BG13)
- ⑤ Other Product Options (see page BG7-BG12)
- ⑥ Accessories, Power and Data

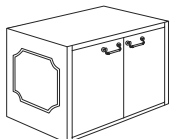
BROGAN

Description	D	W	H	CTN WT	CU FT	① Model	List Price
Modular Lateral File	23 ¼	34 ⅝	24 ¼	120	15	BG2436MLF	\$2,662



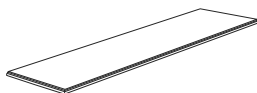
- anti-tip interlock mechanism
- pedestal locking
- no molding, molding on left, molding on right
- top and base required, see below

Modular Storage Cabinet	23 ¼	34 ⅝	24 ¼	90	15	BG2436MSC	\$2,237
--------------------------------	------	------	------	----	----	------------------	----------------



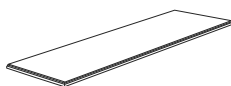
- one adjustable shelf
- non-locking
- no molding, molding on left, molding on right
- top and base required, see below

Modular Credenza Top	24	105 ⅜	1 ⅜	45	6	BG24108MCT	\$1,573
-----------------------------	----	-------	-----	----	---	-------------------	----------------



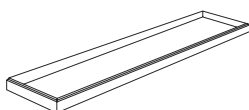
- for use with three modular units; BG2436MLF or BG2436MSC

Modular Credenza Top	24	72	1 ⅜	30	4	BG2472MCT	\$1,061
-----------------------------	----	----	-----	----	---	------------------	----------------



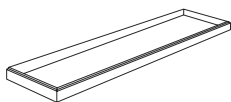
- for use with two modular units; BG2436MLF or BG2436MSC

Modular Credenza Base	23 ⅝	105	4 ¼	60	7	BG24108MCB	\$818
------------------------------	------	-----	-----	----	---	-------------------	--------------



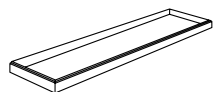
- for use with three modular units; BG2436MLF or BG2436MSC

Modular Credenza Base	23 ⅝	70 ⅜	4 ¼	30	4	BG2472MCB	\$584
------------------------------	------	------	-----	----	---	------------------	--------------



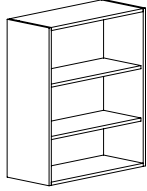
- for use with two modular units; BG2436MLF or BG2436MSC

Modular Credenza Base	23 ⅝	35 ¾	4 ¼	20	3	BG2436MCB	\$417
------------------------------	------	------	-----	----	---	------------------	--------------



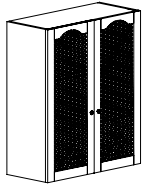
Description	D	W	H	CTN WT	CU FT	① Model	List Price
Modular Open Bookcase	15	34 ½	40 13/16	105	17	BG1542MBC	\$1,613

- two adjustable shelves



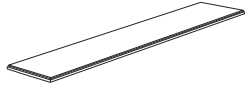
Modular Glass/Grille Door Bookcase	15	34 ½	40 13/16	105	17	BG1542MGBC	\$2,897
------------------------------------	----	------	----------	-----	----	------------	---------

- two adjustable shelves
- non-locking
- specify grille color - antique brass (ANB) or antique pewter (ANP)



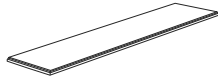
Modular Bookcase Top	15 7/8	105	1 3/16	73	5	BG15108MCT	\$1,102
----------------------	--------	-----	--------	----	---	------------	---------

- for use with three single bookcases; BG1542MGBC or BG1542MBC



Modular Bookcase Top	15 7/8	70 ½	1 3/16	48	3	BG1572MCT	\$745
----------------------	--------	------	--------	----	---	-----------	-------

- for use with two single bookcases; BG1542MGBC or BG1542MBC



Modular Bookcase Top	15 7/8	36	1 3/16	23	2	BG1536MCT	\$426
----------------------	--------	----	--------	----	---	-----------	-------

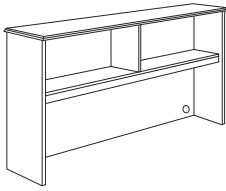
- for use with a single bookcase; BG1542MGBC or BG1542MBC



To Order, Specify:

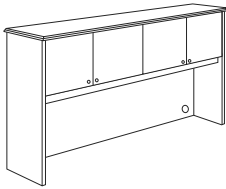
- ① Model Number
- ② Wood Species - Cherry (CH1) or Walnut (WA1) ([see page BG13](#))
- ③ Finish Color ([see page BG13](#))
- ④ Pull Style and Color ([see page BG13](#))
- ⑤ Other Product Options ([see page BG7-BG12](#))
- ⑥ Accessories, Power and Data

Description	D	W	H	CTN WT	CU FT	① Model	List Price
Open Storage Overhead Cabinet	15 7/8	84	42	220	39	BG158400	\$3,536
	15 7/8	78	42	205	37	BG157800	\$3,470
	15 7/8	72	42	190	33	BG157200	\$3,399
	15 7/8	66	42	170	30	BG156600	\$3,250



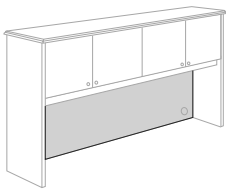
- tackboard available, see below and page BG29
- task lights available, see [accessories price list](#)
- grommet located bottom left and right and top center of back panel
- clearance opening for BG158400 - 19 1/2" h x 79 7/8" w
- clearance opening for BG157800 - 19 1/2" h x 73 7/8" w
- clearance opening for BG157200 - 19 1/2" h x 67 7/8" w
- clearance opening for BG156600 - 19 1/2" h x 61 7/8" w

Storage Overhead Cabinet with Four Doors	15 7/8	84	42	240	39	BG1584S0	\$3,721
	15 7/8	78	42	215	37	BG1578S0	\$3,649
	15 7/8	72	42	190	33	BG1572S0	\$3,579
	15 7/8	66	42	170	30	BG1566S0	\$3,428



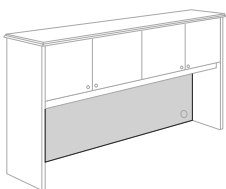
- tackboard available, see below and page BG29
- task lights available, see [accessories price list](#)
- grommet located bottom left and right and top center of back panel
- non-locking
- locking doors available, specify and add \$284 list
- clearance opening for BG1584S0 - 19 1/2" h x 79 7/8" w
- clearance opening for BG1578S0 - 19 1/2" h x 73 7/8" w
- clearance opening for BG1572S0 - 19 1/2" h x 67 7/8" w
- clearance opening for BG1566S0 - 19 1/2" h x 61 7/8" w

Description	D	W	H	CTN WT	CU FT	① Model	List Price Per Grade
Tackboard for 84" w Storage Overhead Cabinet	3/8	79 1/2	15 3/4	3	4	BG84TK	COM \$400
							A \$438
							B \$511
							C \$637
							D \$801
							E \$962
							F \$1,215
							G \$1,490
							H \$1,778
							I \$2,232
						J \$2,775	

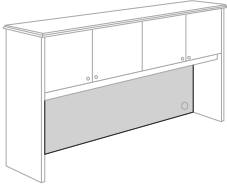


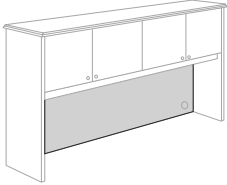
- for use with 84" wide storage overhead cabinet
- fabrics available; visit www.jsifurniture.com/finishes-and-materials/textiles for our textiles program
- com ydg: 2 3/4

Tackboard for 78" w Storage Overhead Cabinet	3/8	73 1/2	15 3/4	3	4	BG78TK	COM \$394
							A \$428
							B \$494
							C \$611
							D \$760
							E \$907
							F \$1,136
							G \$1,383
							H \$1,647
							I \$2,058
						J \$2,555	



- for use with 78" wide storage overhead cabinet
- fabrics available; visit www.jsifurniture.com/finishes-and-materials/textiles for our textiles program
- com ydg: 2 1/2

Description	D	W	H	CTN WT	CU FT	① Model	List Price Per Grade
Tackboard for 72" w Storage Overhead Cabinet 	3/8	67 3/4	15 3/4	2	3	BG72TK	COM \$371
							A \$402
<ul style="list-style-type: none"> for use with 72" wide storage overhead cabinet fabrics available; visit www.jsifurniture.com/finishes-and-materials/textiles for our textiles program com ydg: 2 1/4 							B \$462
							C \$565
							D \$699
							E \$832
							F \$1,039
							G \$1,261
							H \$1,497
							I \$1,869
							J \$2,313

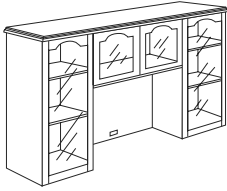
Tackboard for 66" w Storage Overhead Cabinet 	3/8	61 3/4	15 3/4	2	3	BG66TK	COM \$348
							A \$376
<ul style="list-style-type: none"> for use with 66" wide storage overhead cabinet fabrics available; visit www.jsifurniture.com/finishes-and-materials/textiles for our textiles program com ydg: 2 							B \$426
							C \$520
							D \$637
							E \$757
							F \$940
							G \$1,139
							H \$1,347
							I \$1,679
							J \$2,075

To Order, Specify:

- ① Model Number
- ② Wood Species - Cherry (CH1) or Walnut (WA1) (see page BG13)
- ③ Finish Color (see page BG13)
- ④ Pull Color (see page BG13)
- ⑤ Fabric Selection: vendor, pattern, color
- ⑥ Other Product Options (see page BG7-BG12)
- ⑦ Accessories, Power and Data

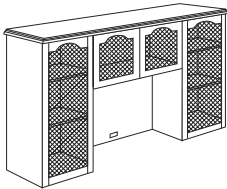
BROGAN

Description	D	W	H	CTN WT	CU FT	① Model	List Price
Storage Overhead Cabinet with Clear Glass	15 7/8	72	42	200	33	BG1572CO	\$5,069
	15 7/8	66	42	180	30	BG1566CO	\$4,811



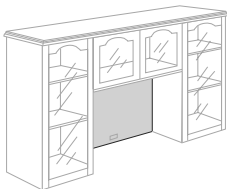
- four adjustable glass shelves
- grommets located in top and bottom center of back panel
- locking not available
- tackboards available, see below
- task lights available, see [accessories price list](#)
- BG1572CO clearance opening - 23 1/2" h x 33" w
- BG1566CO clearance opening - 23 1/2" h x 27" w
- interior lighting with 3 LED lights and on/off switch available, specify and add \$608

Storage Overhead Cabinet with Glass/Grille	15 7/8	72	42	200	33	BG1572GO	\$5,474
	15 7/8	66	42	180	30	BG1566GO	\$5,096



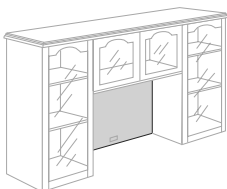
- four adjustable glass shelves
- grommets located in top and bottom center of back panel
- locking not available
- tackboards available, see below
- task lights available, see [accessories price list](#)
- BG1572GO clearance opening - 23 1/2" h x 33" w
- BG1566GO clearance opening - 23 1/2" h x 27" w
- interior lighting with 3 LED lights and on/off switch available, specify and add \$608
- specify grille color - antique brass or antique pewter

Description	D	W	H	CTN WT	CU FT	① Model	List Price Per Grade
Tackboard for 72" w Storage Overhead Cabinet	3/8	32 7/8	20 5/16	3	2	BG34TK	COM \$257
							A \$276
							B \$308
							C \$365
							D \$440
							E \$514
							F \$629
							G \$754
							H \$886
							I \$1,091
							J \$1,338



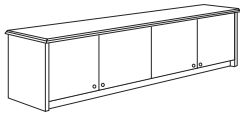
- for use with 72" wide storage overhead cabinet
- fabrics available; visit www.jsifurniture.com/finishes-and-materials/textiles for our textiles program com ydg: 1 1/4

Tackboard for 66" w Storage Overhead Cabinet	3/8	26 7/8	20 5/16	3	2	BG28TK	COM \$231
							A \$245
							B \$270
							C \$317
							D \$379
							E \$437
							F \$528
							G \$627
							H \$732
							I \$896
							J \$1,096



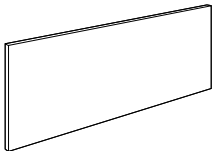
- for use with 66" wide storage overhead cabinet
- fabrics available; visit www.jsifurniture.com/finishes-and-materials/textiles for our textiles program
- com ydg: 1 1/4

Description	D	W	H	CTN WT	CU FT	① Model	List Price
Wall Mount Overhead with Four Doors	15 7/8	72	22	200	22	BG1572WS0	\$3,394
	15 7/8	66	22	190	20	BG1566WS0	\$3,246



- tackboard available, see below
- task lights available, see [accessories price list](#)
- locking doors available, specify and add \$284 list

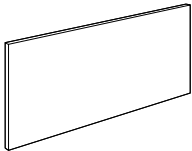
Description	D	W	H	CTN WT	CU FT	① Model	List Price Per Grade
72" w Wall Mount Tackboard	1 1/2	70	17	2	3	BG7220WT	COM \$450



- for use with 72" wide wall mount overhead cabinet
- fabrics available; visit www.jsifurniture.com/finishes-and-materials/textiles for our textiles program
- four 3/8" deep x 2" wide vertical channels in back of panel allow wire management
- com ydg: 2 1/4

A	\$482
B	\$540
C	\$647
D	\$779
E	\$913
F	\$1,121
G	\$1,341
H	\$1,579
I	\$1,949
J	\$2,393

66" w Wall Mount Tackboard	1 1/2	64	17	2	3	BG6620WT	COM \$426
----------------------------	-------	----	----	---	---	----------	-----------



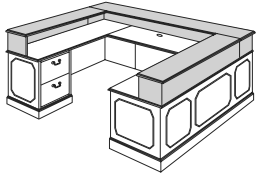
- for use with 66" wide wall mount overhead cabinet
- fabrics available; visit www.jsifurniture.com/finishes-and-materials/textiles for our textiles program
- four 3/8" deep x 2" wide vertical channels in back of panel allow wire management
- com ydg: 2

A	\$454
B	\$506
C	\$598
D	\$717
E	\$836
F	\$1,020
G	\$1,215
H	\$1,429
I	\$1,757
J	\$2,152

To Order, Specify:

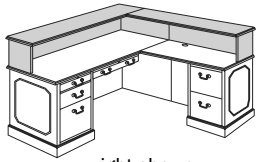
- ① Model Number
- ② Wood Species - Cherry (CH1) or Walnut (WA1) ([see page BG13](#))
- ③ Finish Color ([see page BG13](#))
- ④ Pull Style and Color ([see page BG13](#))
- ⑤ Fabric Selection: vendor, pattern, color
- ⑥ Other Product Options ([see page BG7-BG12](#))
- ⑦ Accessories, Power and Data

Description	D	W	H	CTN WT	CU FT	① Model	List Price
Transaction Counter for U Unit	13	90	17 3/16	145	12	BG13186TC coordinates with BG2472RCR, BG2472LCR, and BG2442EB	\$2,699



- for U units
- 16" vertical clearance from worksurface to bottom of transaction top

Transaction Counter for L Unit	13	66	17 3/16	110	9	BG13114RTC coordinates with BG3066LD BG2448ERR	\$2,105
--------------------------------	----	----	---------	-----	---	---	---------

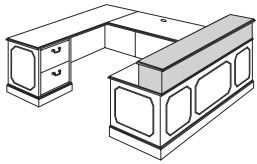


right shown

- for L units
- 16" vertical clearance from worksurface to bottom of transaction top

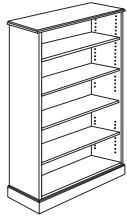
	13	66	17 3/16	110	9	BG13114LTC coordinates with BG3066RD BG2448ELR	\$2,105
--	----	----	---------	-----	---	---	---------

Transaction Counter	13	72	17 3/16	87	9	BG1372TC coordinates with a 72" surface	\$1,511
---------------------	----	----	---------	----	---	---	---------



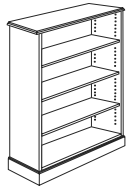
- | | | | | | | | |
|--|----|----|---------|----|---|---|---------|
| | 13 | 66 | 17 3/16 | 79 | 8 | BG1366TC
coordinates with a 66" surface | \$1,444 |
|--|----|----|---------|----|---|---|---------|
- 16" vertical clearance from worksurface to bottom of transaction top

Description	D	W	H	CTN WT	CU FT	① Model	List Price
Bookcase	15	36	72	165	28	BG3672BC	\$2,901



- one fixed shelf
- three adjustable shelves

Bookcase	15	36	54	135	21	BG3654BC	\$2,181
----------	----	----	----	-----	----	----------	---------



- three adjustable shelves

Bookcase	15	36	30	75	12	BG3630BC	\$1,453
----------	----	----	----	----	----	----------	---------



- one adjustable shelf

Bookcase Overhead	15	36	42	85	20	BG1536B0	\$1,458
-------------------	----	----	----	----	----	----------	---------



- for use with BG3630LF and BG3630SC
- one adjustable shelf
- one fixed shelf
- one back panel grommet standard

To Order, Specify:

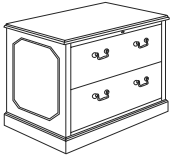
- ① Model Number
- ② Wood Species - Cherry (CH1) or Walnut (WA1) ([see page BG13](#))
- ③ Finish Color ([see page BG13](#))
- ④ Other Product Options ([see page BG7-BG12](#))

Description	D	W	H	CTN WT	CU FT	① Model	List Price
Lateral File	24	36	54	280	33	BG3654LF	\$4,425



- four drawers
- edge profile on three sides
- anti-tip interlock mechanism
- pedestal locking

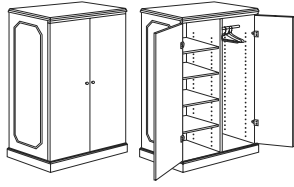
Lateral File	24	36	30	175	19	BG3630LF	\$2,928
--------------	----	----	----	-----	----	----------	---------



- two drawers
- edge profile on three sides
- anti-tip interlock mechanism
- pedestal locking

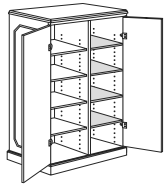
BROGAN

Description	D	W	H	CTN WT	CU FT	① Model	List Price
72" h Wardrobe	24	34 5/8	72	360	43	BG3672W	\$3,984



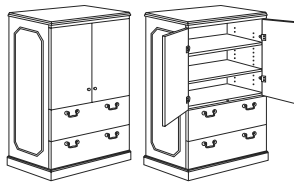
- chrome hanging bar on right
- shelves on left (second from bottom fixed)
- locking doors available; specify and add \$284 list

Hanging Bar to Shelves Conversion Kit			3/4	56	2	BG1824SK	\$858
---------------------------------------	--	--	-----	----	---	----------	-------



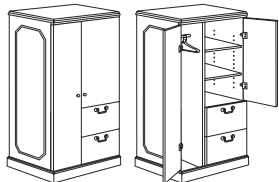
- four shelves
- for 36" wide wardrobe

72" h File/File Lateral Storage Cabinet	24	36	72	360	43	BG3672SWLF	\$5,571
---	----	----	----	-----	----	------------	---------



- two adjustable shelves
- locking doors available; specify and add \$142 list
- file/file lateral
- pedestal locking

72" h File/File Storage Wardrobe	24	23 5/8	72	340	30	BG2472SWR	\$3,864
	24	23 5/8	72	340	30	BG2472SWL	\$3,864



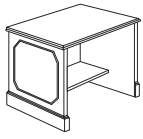
- chrome hanging bar
- two adjustable shelves
- bottom shelf fixed
- file/file pedestal
- locking not available

left shown

To Order, Specify:

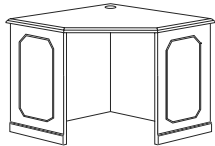
- ① Model Number
- ② Wood Species - Cherry (CH1) or Walnut (WA1) (see page BG13)
- ③ Finish Color (see page BG13)
- ④ Pull Style and Color (see page BG13)
- ⑤ Other Product Options (see page BG7-BG12)

Description	D	W	H	CTN WT	CU FT	① Model	List Price
Printer Stand	24	30	30	125	16	BG2430PS	\$2,257

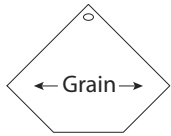


- fixed 11" deep shelf

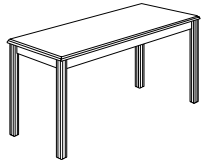
Corner Unit	42	42	30	165	36	BG4242CU	\$3,181
	36	36	30	148	27	BG3636CU	\$2,930



- angle grain direction on top
- one surface grommet
- freestanding
- keyboard tray or mouse pad cannot be used with BG3636CU

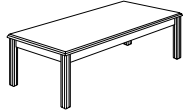


Description	D	W	H	CTN WT	CU FT	❶ Model	List Price
Sofa Table	18	60	30	81	4	BG1860ST	\$1,270



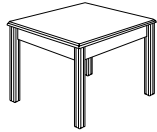
· ships KD in one carton

Magazine Table	20	42	16	63	4	BG2042MT	\$1,070
----------------	----	----	----	----	---	----------	---------



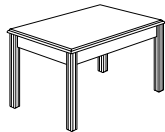
· ships KD in one carton

End Table	24	24	20	43	3	BG2424ET	\$907
-----------	----	----	----	----	---	----------	-------



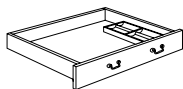
· ships KD in one carton

End Table	20	28	20	43	3	BG2028ET	\$902
-----------	----	----	----	----	---	----------	-------



· ships KD in one carton

Center Drawer	16	24 ¼	3	12	2	BG1826CDB	\$467
---------------	----	------	---	----	---	-----------	-------



· non-locking

To Order, Specify:

- ❶ Model Number
- ❷ Wood Species - Cherry (CH1) or Walnut (WA1) ([see page BG13](#))
- ❸ Finish Color ([see page BG13](#))
- ❹ Pull Style and Color ([see page BG13](#))
- ❺ Other Product Options ([see page BG7-BG12](#))
- ❻ Accessories, Power and Data

BROGAN

Brogan Conference Product Information

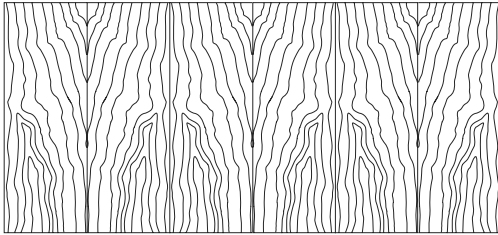


BROGAN

Brogan Conference Product Information

Exterior Wood Materials

Exterior surfaces are made from the finest selected veneers to achieve clarity and consistency in the Brogan product line. To attain a pleasing, symmetrical pattern, all veneers in Brogan are book-matched. All exterior solid lumber is matched to coordinate with the veneer.



Book Matched Example

Alternating pieces of veneer are flipped over so they face each other like the pages within a book.

Brogan is available in flat cut cherry and walnut veneer. A wide range of wood stains have been formulated to enhance the beauty of the veneer.

Work Surface Construction

Tops are 5-ply balanced construction, 1 3/4" thick with solid matching hardwood edges. Tops are available in one edge profile.

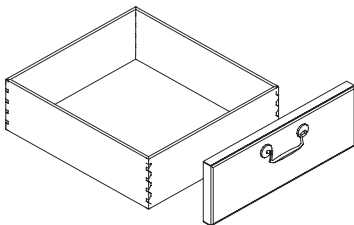
Matching or coordinating high pressure laminate in a veneer grain can be applied to the top surface and is available at no additional charge.

Base Construction

Panels are joined together by mortise and tenon construction. In addition to mortise and tenon joint construction. Leveling glides are set into solid hardwood with t-nut inserts, which helps to prevent the leveling glide from tear out. Tops are secured to the bases with top fastening cleats screwed to the inside of the panels.

Drawers

The 9ply unidirectional hardwood sides of the drawer box are 7/16" thick assembled with English dovetail construction at each corner of the box. The drawer bottom panel is 1/4" thick fitting into a groove machined into the side of the box. Interiors are sanded and coated with clear U.V. finish to protect against shrinking, swelling or warping, and to provide a clean, smooth feel and appearance.



Drawer Suspension

The high quality black drawer suspensions carry a lifetime warranty. Slides feature steel ball bearings for longer life with cushioned in/out stops. File and box drawers have 100% full extension.

Finish - Stain/Colors

We offer a variety of wood stains and paint colors on Brogan. Please see the chart below. Samples are available upon request.

CH1 Cherry		<i>Flat Cut Veneer</i>	
BBM	Bourbon Medium	CLL	Collectors
BRM	Brighton Medium	HRV	Harvest
CLA	Classic	PRL	Praline
WA1 Walnut		<i>Flat Cut Veneer</i>	
ESP	Espresso	TRF	Truffle
MCH	Mocha	UMB	Umber
SIE	Sienna		

Protective Top Coat

DuraTex™ offers exceptional hardness along with abrasion and impact resistance, it has been formulated to eliminate hazardous and harmful gases that are normally associated with wood finish.

DuraTex™ Features

Safety - Significantly reduces hazardous formaldehyde emissions, which help improve the quality of the of the indoor air we breathe.

Quality - Developed to be tough and durable with special attention to appearance. The DuraTex™ finish preserves the natural beauty of wood.

Durability - Designed to meet a wide range of demanding performance and environmental standards to withstand even the highest wear and tear.

Finish Sheen

All veneer finishes, for Brogan, are standard in 35-sheen. All other finishes can have their sheen modified with a 15% upcharge added to the list price of each item.

Special Finishes

Special finishes can be requested by following the instruction in the general introduction section. There is a one time charge of \$372 list per order.

Brogan Conference Product Information

Product Modification

Laminate Tops

Worksurface only, no additional upcharge if coordinating wood grain laminate is specified. Contact Customer Service for any other laminate request. Listed below are finishes that have coordinating wood grain HPL laminates.

CH1 Cherry *Flat Cut Veneer*

CLL Collectors

HRV Harvest

PRL Praline

WA1 Walnut *Flat Cut Veneer*

MCH Mocha TRF Truffle

SIE Sienna UMB Umber

Special Finishes

Special finishes can be requested by following the instruction in the general introduction section. There is a one time charge of \$372 list per order.

Finish Sheen

All veneer finishes are standard in 35-sheen, with the exception of Raven. Raven is only offered in 15 sheen. All other finishes can have their sheen modified with a 15% upcharge added to the list price of each item.

Species Change

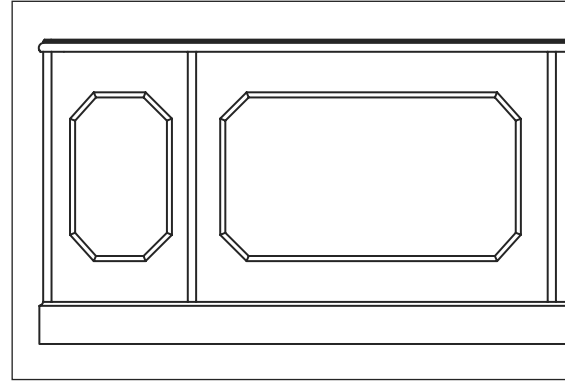
For species changes contact customer service for a quote.

Product Modification

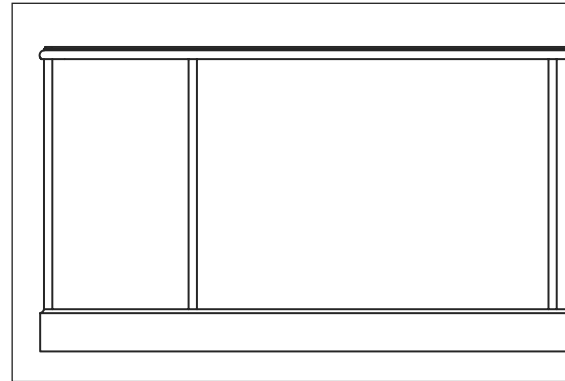
Trim Molding

Angled Trim molding is standard on all Brogan products.

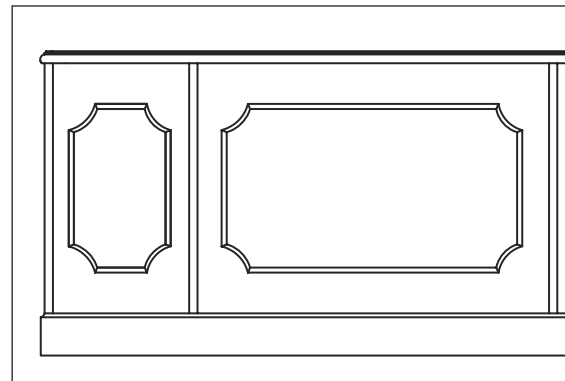
Without molding or Scalloped Trim molding can be specified at the time of order placement. (diagram below show the molding options)



Angled Trim
standard



Base Molding Only (without trim)
optional at no charge



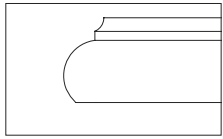
Scalloped Trim
optional with upcharge to list for each item
\$76 list per base

Brogan Conference Product Information

Edge and Hardware

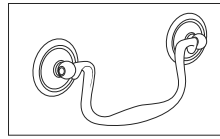
Brogan offers a traditional edge profile and the Brogan drawer pull in antique brass or antique pewter finish.

Edge Profile

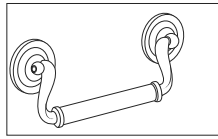


Federal Edge Profile (C3)
Accepts Laminate Top

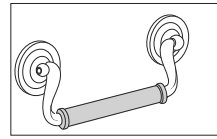
Drawer Hardware



Brogan Hardware
Antique Brass (ANB)
Antique Pewter (ANP)



Gala Hardware
Antique Brass (ANB)
Antique Pewter (ANP)



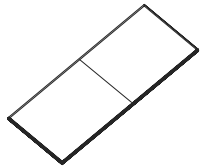
Gala Leather Wrapped Hardware
Antique Brass (ANB)
Antique Pewter (ANP)

Optional matching leather wrapped pulls available for desk with leather inlay or other coordinating units. Specify leather wrapped pulls, add \$59 list upcharge per pull. Indicate Antique Brass (ANB) or Antique Pewter (ANP) pull.

Top Shapes - size - base requirement - seating capacity

top sizes 108" through 192" are 2 pieces

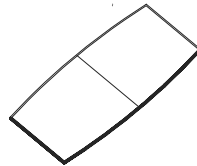
top sizes above 192" are 3 pieces



Size	Bases	Seats
264" x 54"	4 bases	seats 22
240" x 54"	4 bases	seats 20
216" x 54"	4 bases	seats 18
192" x 54"	3 bases	seats 16
264" x 48"	4 bases	seats 22
240" x 48"	4 bases	seats 20
216" x 48"	4 bases	seats 18
192" x 48"	3 bases	seats 16
168" x 48"	3 bases	seats 14
144" x 48"	3 bases	seats 12
120" x 48"	2-3* bases	seats 8
120" x 42"	2-3* bases	seats 8
108" x 42"	2 bases	seats 8
96" x 42"	2 bases	seats 8
72" x 36"	2 bases	seats 6



Size	Bases	Seats
264" x 54"	4 bases	seats 22
240" x 54"	4 bases	seats 20
216" x 54"	4 bases	seats 18
192" x 54"	3 bases	seats 16
264" x 48"	4 bases	seats 22
240" x 48"	4 bases	seats 20
216" x 48"	4 bases	seats 18
192" x 48"	3 bases	seats 16
168" x 48"	3 bases	seats 14
144" x 48"	3 bases	seats 12
120" x 48"	2-3* bases	seats 8
120" x 42"	2-3* bases	seats 8
108" x 42"	2 bases	seats 8
96" x 42"	2 bases	seats 8
72" x 36"	2 bases	seats 6

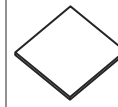


Size	Bases	Seats
264" x 54"	4 bases	seats 22
240" x 54"	4 bases	seats 20
216" x 54"	4 bases	seats 18
192" x 54"	3 bases	seats 16
264" x 48"	4 bases	seats 22
240" x 48"	4 bases	seats 20
216" x 48"	4 bases	seats 18
192" x 48"	3 bases	seats 16
168" x 48"	3 bases	seats 14
144" x 48"	3 bases	seats 12
120" x 48"	2-3* bases	seats 8
120" x 42"	2-3* bases	seats 8
108" x 42"	2 bases	seats 8
96" x 42"	2 bases	seats 8
72" x 36"	2 bases	seats 6



Size	Bases	Seats
60" dia.	Seats 6	
54" dia.	Seats 6	
48" dia.	Seats 4	
42" dia.	Seats 4	
36" dia.	Seats 4	

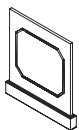
*requires 1 base



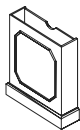
Size	Bases	Seats
60" sq.	seats 8	
54" sq.	seats 6	
48" sq.	seats 4	
42" sq.	seats 4	
36" sq.	seats 4	
30" sq.	seats 4	

*requires 1 base

Base (units with access panel in the base for wire management are available, order this feature with the appropriate model number.)



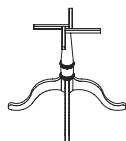
panel base
30" and 24" width



rectangular base
30" and 24" width



square base
24" width



cabriole base
33" width

Grommet

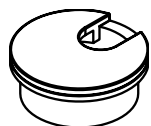
Brogan Grommets

Work surface grommets can be specified work surfaces. The grommet location must be approved by JSI manufacturing; contact Customer Service.

Add \$114 to the list for each grommet.

Grommet color must be specified, select Antique Brass or Matte Black. Lock cores will match grommet color.

Matte Black (MBK)
Antique Brass (ANB)



Brogan Conference Product Information

Finish and Product Reference Codes

Select	Code
--------	------

Veneer

Cherry Flat Cut	CH1
Walnut Flat Cut	WA1

Finish

Cherry Finishes	
Bourbon Medium	BBM
Brighton Medium	BRM
Classic	CLA
Collectors	CLL
Harvest	HRV
Praline	PRL

Select	Code
--------	------

Finish *(continued)*

Walnut Finishes	
Espresso	ESP
Mocha	MCH
Sienna	SIE
Truffle	TRF
Umber	UMB

Pull & Finishes Codes

Brogan Pull-Antique Brass	ANB
Brogan Pull-Pewter	PTR

Grommet Finish Codes

Antique Brass	ANB
Matte Black	MBK

Select	Code
--------	------

Laminate Coordinates

Cherry Wood Grain Patterns	
Collectors	CLL
Harvest	HRV
Praline	PRL

Walnut Wood Grain Patterns	
Mocha	MCH
Sienna	SIE
Truffle	TRF
Umber	UMB

Order Check List:

Specify:

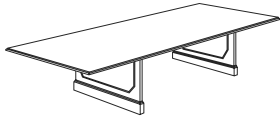
- 1. Model Number
- 2. Finish
- 3. Wood Species - cherry - walnut
- 4. Top Options - standard veneer - laminate surface (see page [BGC3](#))
- 5. Pull Section **if applicable**
- 6. Other Product Options
- 7. Power and Data Accessories (*drawing showing location and orientation must accompany order*)
- 8. Side Mark Information (*i.e. room number, East Conference Room*)
- 9. Shipping Address (*contact name and phone number*)
- 10. Special Delivery Instructions (*i.e. call before delivery, deliver to job site*)

Brogan

BROGAN

Description	D	W	H	Seating Capacity	CTN WT	CU FT	① Model	List Price
-------------	---	---	---	------------------	--------	-------	---------	------------

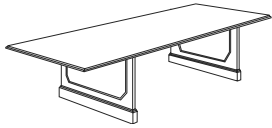
Conference Table	42	96	30	8			BG4296CTP	\$5,729
							Consists of:	
							BG4296TT - Table Top	\$3,925
							BG2428PB - Panel Bases (2)	\$902 ea.



- ships KD in four cartons
- one piece top
- price reflects two bases
- includes BG0655SP stretcher panel

Conference Table	36	72	30	6			BG3672CTP	\$4,328
------------------	----	----	----	---	--	--	------------------	----------------

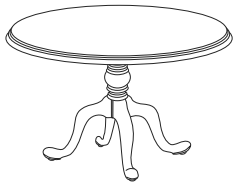
							Consists of:	
							BG3672TT - Table Top	\$2,524
							BG2428PB - Panel Bases (2)	\$902 ea.



- ships KD in four cartons
- one piece top
- price reflects two bases
- includes BG0631SP stretcher panel

Round Conference Table	48	48	30	4			BG48CTC	\$3,339
------------------------	----	----	----	---	--	--	----------------	----------------

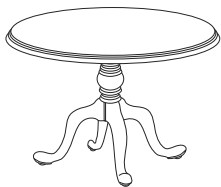
							Consists of:	
							BG48TT - Table Top	\$1,965
							BG33CB - Cabriole Base	\$1,374



- ships KD in two cartons

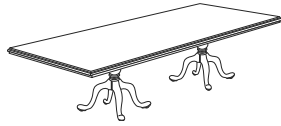
Round Conference Table	42	42	30	4			BG42CTC	\$2,876
------------------------	----	----	----	---	--	--	----------------	----------------

							Consists of:	
							BG42TT - Table Top	\$1,502
							BG33CB - Cabriole Base	\$1,374



- ships KD in two cartons

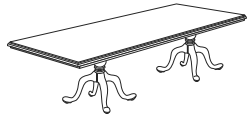
Description	D	W	H	Seating Capacity	CTN WT	CU FT	❶ Model	List Price
Conference Table	42	96	30	8			BG4296CTC	\$6,673



							Consists of:	
					172	15	BG4296TT - Table Top	\$3,925
					30 ea.	16 ea.	BG33CB - Cabriole Bases (2)	\$1,374 ea

- ships KD in three cartons
- one piece top
- price reflects two bases

Conference Table	36	72	30	6			BG3672CTC	\$5,272
------------------	----	----	----	---	--	--	------------------	---------



							Consists of:	
					110	10	BG3672TT - Table Top	\$2,524
					30 ea.	16 ea.	BG33CB - Cabriole Bases (2)	\$1,374 ea


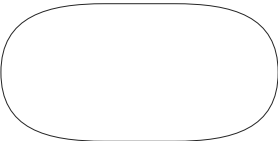
- ships KD in three cartons
- one piece top
- price reflects two bases

BROGAN

To Order, Specify:

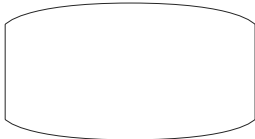
- ❶ Model Number
- ❷ Wood Species
- ❸ Finish Color
 - A Worksurface Finish
 - B. Chassis Finish
- ❹ Accessories, Power and Data
- ❺ Other Product Options


Brogan


Description	① Model	W	L	Seat Capacity	Top Pieces	Bases Required	CTN WT	CU FT	List Price	
Rectangular Tops 	BG60264TT	60	264	24	3	4	673	57	\$16,556	
	BG60240TT	60	240	22	3	4	613	51	\$15,052	
	BG60216TT	60	216	20	3	4	552	48	\$13,551	
	BG60192TT	60	192	18	2	3	490	42	\$12,041	
	BG54264TT	54	264	22	3	4	609	52	\$13,799	
	BG54240TT	54	240	20	3	4	554	50	\$12,544	
	BG54216TT	54	216	18	3	4	498	43	\$11,292	
	BG54192TT	54	192	16	2	3	441	38	\$10,037	
	BG48264TT	48	264	22	3	4	548	47	\$12,270	
	BG48240TT	48	240	20	3	4	498	43	\$11,156	
	BG48216TT	48	216	18	3	4	447	38	\$10,037	
	BG48192TT	48	192	16	2	3	396	33	\$8,924	
	BG48168TT	48	168	14	2	3	346	30	\$7,810	
	BG48144TT	48	144	12	2	3	296	28	\$6,695	
	BG48120TT**	48	120	8	2	2	245	22	\$5,582	
	BG4896TT	48	96	8	1	2	197	17	\$4,485	
	BG42120TT**	42	120	8	2	2	217	19	\$4,884	
	BG42108TT	42	108	8	2	2	195	17	\$4,399	
	BG4296TT	42	96	8	1	2	172	15	\$3,925	
	BG4284TT	42	84	8	1	2	151	13	\$3,417	
	BG3672TT	36	72	6	1	2	110	10	\$2,524	
	Racetrack Tops 	BG60264RT	60	264	24	3	4	646	57	\$19,565
		BG60240RT	60	240	22	3	4	589	51	\$17,787
		BG60216RT	60	216	20	3	4	530	48	\$16,012
		BG60192RT	60	192	18	2	3	471	42	\$14,235
		BG54264RT	54	264	22	3	4	586	52	\$16,304
		BG54240RT	54	240	20	3	4	530	50	\$14,824
BG54216RT		54	216	18	3	4	474	43	\$13,343	
BG54192RT		54	192	16	2	3	417	38	\$11,861	
BG48264RT		48	264	22	3	4	529	47	\$14,495	
BG48240RT		48	240	20	3	4	479	43	\$13,179	
BG48216RT		48	216	18	3	4	428	38	\$11,861	
BG48192RT		48	192	16	2	3	377	33	\$10,544	
BG48168RT		48	168	14	2	3	327	30	\$9,117	
BG48144RT		48	144	12	2	3	277	28	\$7,911	
BG48120RT**		48	120	8	2	2	226	22	\$6,596	
BG4896RT		48	96	8	1	2	185	17	\$5,279	
BG42120RT**		42	120	8	2	2	203	19	\$5,770	
BG42108RT		42	108	8	2	2	180	17	\$5,194	
BG4296RT		42	96	8	1	2	157	15	\$4,616	
BG4284RT		42	84	8	1	2	142	13	\$4,058	
BG3672RT		36	72	6	1	2	100	10	\$2,975	

**When ordering RECTANGLE or PANEL BASES - BG48120 and BG42120 require (3) panel bases and additional stretchers. Stretchers will be included as required.

**When ordering RECTANGLE or PANEL BASES - BG48120 and BG42120 require (3) panel bases and additional stretchers. Stretchers will be included as required.

Description	① Model	W	L	Seat Capacity	Top Pieces	Bases Required	CTN WT	CU FT	List Price
Boat Shape Tops 	BG60264BT	60	264	24	3	4	646	57	\$19,565
	BG60240BT	60	240	22	3	4	589	51	\$17,787
	BG60216BT	60	216	20	3	4	530	48	\$16,012
	BG60192BT	60	192	18	2	3	471	42	\$14,235
	BG54264BT	54	264	22	3	4	586	52	\$16,304
	BG54240BT	54	240	20	3	4	530	50	\$14,824
	BG54216BT	54	216	18	3	4	474	43	\$13,343
	BG54192BT	54	192	16	2	3	417	38	\$11,861
	BG48264BT	48	264	22	3	4	529	47	\$14,495
	BG48240BT	48	240	20	3	4	479	43	\$13,179
	BG48216BT	48	216	18	3	4	428	38	\$11,861
	BG48192BT	48	192	16	2	3	377	33	\$10,544
	BG48168BT	48	168	14	2	3	327	30	\$9,117
	BG48144BT	48	144	12	2	3	277	28	\$7,911
	BG48120BT**	48	120	8	2	2	226	22	\$6,596
	BG4896BT	48	96	8	1	2	185	17	\$5,279
	BG42120BT**	42	120	8	2	2	203	19	\$5,770
	BG42108BT	42	108	8	2	2	180	17	\$5,194
	BG4296BT	42	96	8	1	2	157	15	\$4,616
BG4284BT	42	84	8	1	2	142	13	\$4,058	
BG3672BT	36	72	6	1	2	100	10	\$2,975	

Description	① Model	W	L	Seat Capacity	Top Pieces	Bases Required	CTN WT	CU FT	List Price
Round Tops 	BG60TT	60	N/A	6	1	1	112	10	\$3,320
	BG54TT	54	N/A	6	1	1	92	8	\$2,493
	BG48TT	48	N/A	4	1	1	73	7	\$1,965
	BG42TT	42	N/A	4	1	1	56	5	\$1,502
	BG36TT	36	N/A	3	1	1	42	4	\$1,323

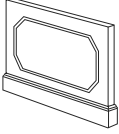
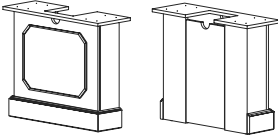
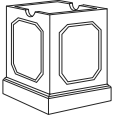
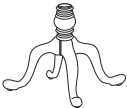
Description	① Model	W	L	Seat Capacity	Top Pieces	Bases Required	CTN WT	CU FT	List Price
Square Tops 	BG6060TT	60	60	8	1	1	154	10	\$3,042
	BG5454TT	54	54	6	1	1	125	8	\$2,305
	BG4848TT	48	48	4	1	1	99	7	\$1,819
	BG4242TT	42	42	4	1	1	77	5	\$1,396
	BG3636TT	36	36	4	1	1	56	4	\$1,259

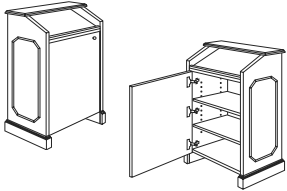
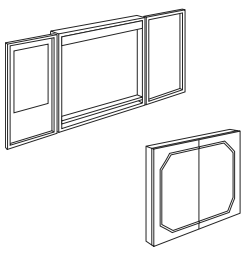
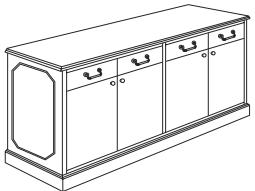
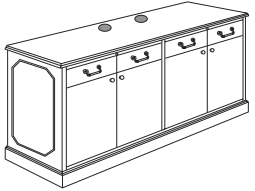
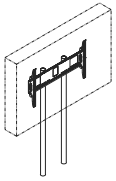
To Order, Specify:

- ① Model Number
- ② Wood Species
- ③ Finish Color
- ④ Accessories, Power and Data
- ⑤ Other Product Options

Brogan

BROGAN

Description	D	W	H	CTN WT	CU FT	① Model	List Price
Panel Base 	2 5/16	36	28 3/4	88	6	BG3628PB · for use with 60" width top	\$1,179
	2 5/16	30	28 3/4	73	5	BG3028PB · for use with 54" width top	\$1,042
	2 5/16	24	28 3/4	59	4	BG2428PB · for use with 36", 42", and 48" width top · (3) bases are required when ordering BG48120 or BG42120	\$902
Rectangle Base 	7 5/8	36	28 3/4	74	7	BG3628PBA · for use with 60" width top · access panel	\$1,665
	7 5/8	30	28 3/4	66	6	BG3028PBA · for use with 54" width top · access panel	\$1,591
	7 5/8	24	28 3/4	56	5	BG2428PBA · for use with 36", 42", and 48" width top · access panel	\$1,514
Square Base 	30	30	28 3/4	73	16	BG30SB · for use with 60" width top	\$1,494
	30	30	28 3/4	73	16	BG30SBA · for use with 60" width top · access panel	\$1,634
	24	24	28 3/4	74	12	BG24SB · for use with 54" width top	\$1,352
	24	24	28 3/4	74	12	BG24SBA · for use with 54" width top · access panel	\$1,497
	18	18	28 3/4	45	7	BG18SB · for use with 36", 42" and 48" width top	\$1,210
	18	18	28 3/4	45	7	BG18SBA · for use with 36", 42" and 48" width top · access panel	\$1,358
Cabriole Base 	33	33	28 3/4	30	16	BG33CB · for use with 36", 42" and 48" width top	\$1,374

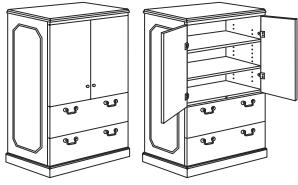
Description	D	W	H	CTN WT	CU FT	① Model	List Price
Conference Lectern  <ul style="list-style-type: none"> · two adjustable shelves · four concealed, locking casters · door is non-locking · standard door is hinged on left · round grommet in bottom panel · notches in adjustable shelves allow wires to pass through 	23	27	48	250	23	BG2723LEC	\$3,478
Visual Board  <ul style="list-style-type: none"> · corkboard on left and right doors; paper pad on left only · marker board in center · four markers and eraser included · locking not available 	3½	48	48	125	8	BG4848VB	\$4,190
Buffet Credenza  <ul style="list-style-type: none"> · four door credenza · four box drawers above doors · locking not available · adjustable shelf in storage cabinet 	24	72	36	330	43	BG2472BSC	\$6,172
Buffet Credenza - Flat Screen Support  <ul style="list-style-type: none"> · four door credenza · four box drawers above doors · locking not available · adjustable shelf in storage cabinet · flat screen mounting grommets in top · back panel includes cord exit grommets 	24	72	36	330	43	BG2472BSCT	\$6,675
Flat Screen Mounting Frame  <ul style="list-style-type: none"> · round 2" tube frame with cable management to inside of credenza · mounting bracket for TV provided · available in black (B) or silver (S) · TV not included · TV dimension not to exceed 70"w x 38"h to allow proper mounting clearance · coordinates with BG2472BSCT 	2	14	55	35	4	FSTV	\$1,716

To Order, Specify:

- ① Model Number
- ② Wood Species
- ③ Finish Color
- ④ Pull Style and Color (see page [BGC4](#))
- ⑤ Accessories, Power and Data
- ⑥ Other Product Options

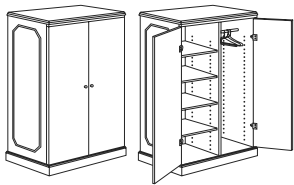
Brogan

Description	D	W	H	CTN WT	CU FT	① Model	List Price
72" h File/File Lateral Storage Cabinet	24	36	72	360	43	BG3672SWLF	\$5,571



- two adjustable shelves
- locking doors available; specify and add \$142 list
- file/file lateral
- pedestal locking

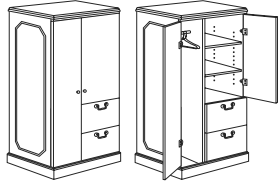
72" h Wardrobe	24	34 1/2	72	360	43	BG3672W	\$3,984
----------------	----	--------	----	-----	----	---------	---------



- chrome hanging bar on right
- shelves on left (second from bottom fixed)
- locking doors available; specify and add \$284 list

BROGAN

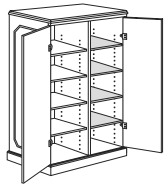
Description	D	W	H	CTN WT	CU FT	① Model	List Price
72" h File/File Storage Wardrobe	24	23 5/8	72	340	30	BG2472SWR	\$3,864
	24	23 5/8	72	340	30	BG2472SWL	\$3,864



left shown

- chrome hanging bar
- two adjustable shelves
- bottom shelf fixed
- file/file pedestal
- locking not available

Hanging Bar to Shelves Conversion Kit			3/4	56	2	BG1824SK	\$858
---------------------------------------	--	--	-----	----	---	----------	-------



- four shelves
- for 36" wide wardrobe

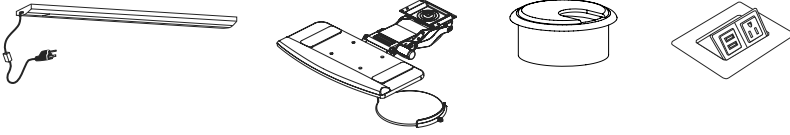
To Order, Specify:

- ① Model Number
- ② Wood Species
- ③ Finish Color
- ④ Pull Style and Color (see page [BGC4](#))
- ⑤ Accessories, Power and Data
- ⑥ Other Product Options

Accessories/ Keyboard/ Tasklights

For a list of electrical units, grommets, keyboards, wire management, monitor arms & telecom jacks, please see our [accessories price list](#)

Contact your customer service representative for specific questions regarding which units can be used with Brogan.



Collective Conference Tables Product Information

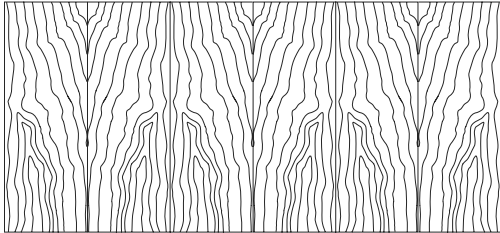


COLLECTIVE CONFERENCE

Collective Conference Tables Product Information

Exterior Wood Materials

Exterior surfaces are made from the finest selected veneers to achieve clarity and consistency in the Collective Conference product line. To attain a pleasing, symmetrical pattern, all veneers in Collective Conference are book-matched. All exterior solid lumber is matched to coordinate with the veneer.



Book Matched Example

Alternating pieces of veneer are flipped over so they face each other like the pages within a book.

Collective Conference is available in flat cut cherry, maple, and walnut veneer. A wide range of wood stains have been formulated to enhance the beauty of the veneer.

Solid painted finishes on MDF are also offered on bases, drawer and door fronts to provide an accent to the Collective Conference product.

Work Surface Construction

All tops are 1 3/8" thick with 3-ply construction and trimmed off with matching 1.5mm rims.

Tops are available in wood veneer, applied glass or laminate surfaces. No additional charges for laminate when selecting standard coordinating laminate as listed on the top of the next page.

Chassis Construction

The chassis consists of cherry, maple or walnut book-matched veneer. Mortise and tenon construction. Adjustable leveling glides ensure proper leveling of unit.

Extruded Aluminum Components

Telescopic Feet, Edge Trim Rails, Center Console Components, and Spacers all are made from an alloy aluminum compound, made up of 10% post consumer scrap, 60% post industrial scrap and 30% primary aluminum. The aluminum meets or exceeds the guidelines of USGBC - LEED V2.2. The parts are precisely machined and then processed in a clear anodized finish for a natural aluminum appearance.

Fabricated or Casted Metal Components

Base Trims, Base Pans, Scones and Wire Pans are made up of high grade metals. The metal is laser cut, bent to shape and robotically welded to the exact specifications, polished and powder coated to blend with the anodized aluminum.

Finish - Stain/Colors

We offer a variety of wood stains and paint colors on Collective Conference. Please see the chart below. Samples are available upon request, through our website or by contacting Customer Service.

CH1 Cherry <i>Flat Cut Veneer</i>			
BBM	Bourbon Medium	CLL	Collectors
BRM	Brighton Medium	HRV	Harvest
CLA	Classic	PRL	Praline

MA1 Maple <i>Flat Cut Veneer</i>			
ALM	Ale Medium	FLX	Flax
BUT	Butterscotch	VEN	Venetian

WA1 Walnut <i>Flat Cut Veneer</i>			
ESP	Espresso	TRF	Truffle
MCH	Mocha	UMB	Umber
SIE	Sienna		

PNT Paint			
BKD	Backdrop	GRV	Greek Villa
BFX	Black Fox	NET	Network Gray
CGP	Cargo Pants	NWH	Nonchalant White
CHT	Chatroom	TRC	Tricorn Black
FRR	French Roast		

Protective Top Coat

DuraTex™ offers exceptional hardness along with abrasion and impact resistance, it has been formulated to eliminate hazardous and harmful gases that are normally associated with wood finish.

DuraTex™ Features

Safety - Significantly reduces hazardous formaldehyde emissions which help improve the quality of the of the indoor air we breathe.

Quality - Developed to be tough and durable with special attention to appearance. The DuraTex™ finish preserves the natural beauty of wood.

Durability - Designed to meet a wide range of demanding performance and environmental standards to withstand even the highest wear and tear.

Collective Conference Tables Product Information

Product Modification

Laminate Tops

Work surface only, no additional upcharge if coordinating wood grain laminate is specified. Contact Customer Service for any other laminate request.

CH1 Cherry *Flat Cut Veneer*

CLL Collectors

HRV Harvest

PRL Praline

WA1 Walnut *Flat Cut Veneer*

MCH Mocha TRF Truffle

SIE Sienna UMB Umber

Special Finishes

Special finishes can be requested by following the instructions in the general introduction section. There is a one time charge of \$372 list per order.

Finish Sheen

All veneer finishes, for Collective, are standard in 35-sheen. All other finishes can have their sheen modified with a 15% upcharge added to the list price of each item.

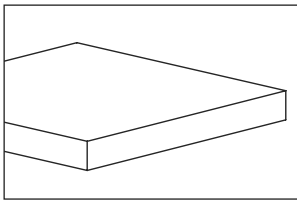
Special Top Sizes and Cabinets

Collective Conference offers a large offering of table tops shapes and sizes, along with the Collective Conference Storage products to create a perfect meeting room. Contact Customer Service if you are having trouble finding the right units to complete the desired configuration. Special sizes and cabinet variations need to be approved by JSI engineering.

Collective Conference Tables Product Information

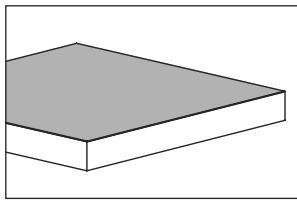
Top Edge Profiles

Collective Conference offer two edges profiles, along with optional details.



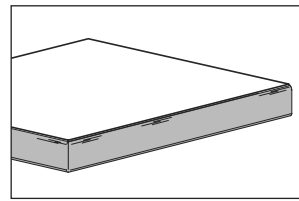
Straight Edge - Veneer

Standard on conference tables and casegoods products.



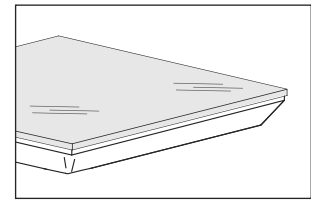
Straight Edge - Laminate

Straight edge with laminate surface available for conference tables and casegood products. See page [CC3](#) for standard wood grain laminate.



Aluminum Trim Edge Detail

Aluminum trim edge available only on Veneer rectangular shape conference tops. The trim edge is finished in clear anodized finish.

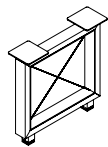


Thin Profile Edge - Glass

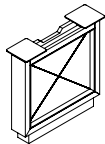
Reverse Bevel edge is available with low iron white back painted glass in glossy or frosted surface. Available only on conference table tops.

Base Types

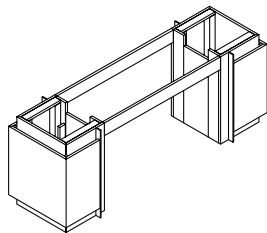
Collective Conference offers five base styles: open cable, closed cable, rectangular, panel and arc end.



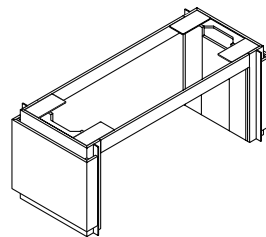
Open Cable Base



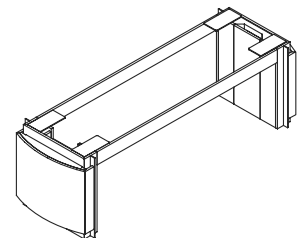
Closed Cable Base



Rectangular Base with Apron Rails



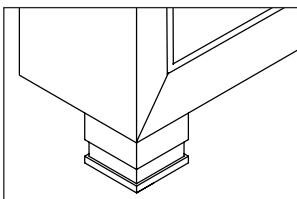
Panel Base with Apron Rails



Arc End Base with Apron Rails

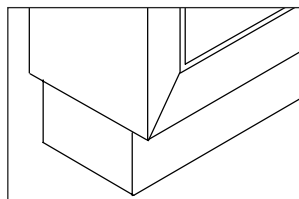
Foot/Plinth Style Base

Collective Conference Open Cable Base and Casegoods features an anodized aluminum foot. For a more classic feel, units may be specified with a wood plinth style base. Rectangular, Panel and Arc End Bases are available only with a plinth base.



Foot Style

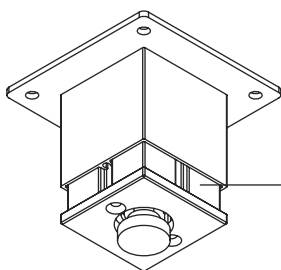
Anodized Aluminum Finish



Plinth Base

Concealed leveling glide

Foot Leveling Details



Telescopic cover can slide up to provide access for leveling adjustment

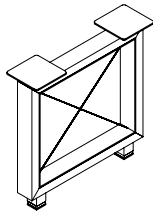
Collective Conference Tables Product Information

Conference Top Shapes and Sizes

Collective Conference offer six top shapes and sizes start at 216" in length. Note size 120" and above are two piece tops.

rectangular	arc end	racetrack	boat	ellipse	view
216" x 60" Seats 18/20 192" x 60" Seats 16/18 168" x 60" Seats 14/16 144" x 60" Seats 10/12 216" x 48" Seats 16/18 192" x 48" Seats 14/16 168" x 48" Seats 12/14 144" x 48" Seats 8/10 120" x 48" Seats 6/8 96" x 48" Seats 6/8 84" x 42" Seats 4/6 72" x 36" Seats 4/6	216" x 60" Seats 16/18 192" x 60" Seats 14/16 168" x 60" Seats 12/14 144" x 60" Seats 10/12 216" x 48" Seats 16/18 192" x 48" Seats 14/16 168" x 48" Seats 12/14 144" x 48" Seats 8/10 120" x 48" Seats 6/8 96" x 48" Seats 6/8 84" x 42" Seats 4/6 72" x 36" Seats 4/6	216" x 60" Seats 18/20 192" x 60" Seats 16/18 168" x 60" Seats 14/16 144" x 60" Seats 10/12 216" x 48" Seats 16/18 192" x 48" Seats 14/16 168" x 48" Seats 12/14 144" x 48" Seats 8/10 120" x 48" Seats 6/8 96" x 48" Seats 6/8 84" x 42" Seats 4/6 72" x 36" Seats 4/6	216" x 60" Seats 16/18 192" x 60" Seats 14/16 168" x 60" Seats 12/14 144" x 48" Seats 8/10 120" x 48" Seats 6/8 96" x 48" Seats 6/8	144" x 60" Seats 10/12 120" x 54" Seats 8/10 96" x 48" Seats 6/8	168" x 60" Seats 12/14 144" x 60" Seats 10/12 120" x 60" Seats 9/10 96" x 60" Seats 7/8 <i>This shape top is only available with bases</i>

Open Cable Bases

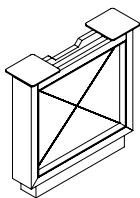


The open cable base features a 1³/₁₆" X-shaped stainless steel cable accent. Open cable bases provide no wire management compartment. The outer frame is wood with a metal inner frame in silver powder coat. Telescopic feet provide 1¹/₂" leveling adjustment.

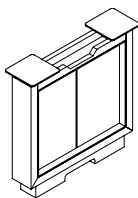
Configured tables with cable bases in this price list include support rails for the top.

Cable bases are not for use with 60"d tops. When specifying cable bases and tops separately, support rails may need to be included. Call Customer Service for more information.

Closed Cable Bases



Outside Base
side 1 (approach)



side 2

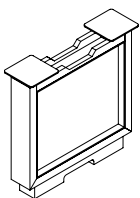
Closed cable bases include a hinged door compartment and plinth base for wire management.

The outside closed cable base features a visible 1³/₁₆" X-shaped stainless steel cable accent on the side opposite the hinge door. Wires pass through an opening above hinged doors. The base is wood with a silver powder coated inner frame.

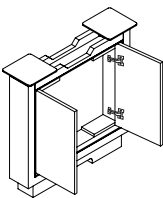
The middle closed cable base features a wood panel on the side opposite the side hinged door. Wires pass through an opening at the top of both sides.

Configured tables with cable bases in this price list include support rails for the top.

Cable bases are not for use with 60"d tops. When specifying cable bases and tops separately, support rails may need to be included. Call Customer Service for more information.



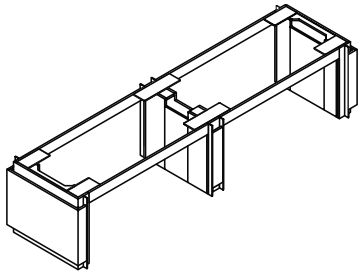
Middle Base
side 1



side 2

Collective Conference Tables Product Information

Panel Bases

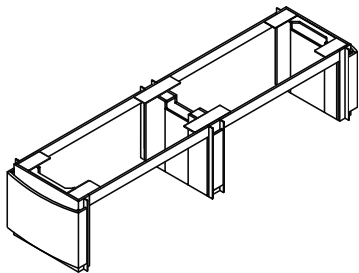


The panel base features slim wood pedestals surrounded by a wood accent. Each pedestal has a hinged door for wire management access and features a silver powder coat metal fin detail.

The panel base is standard with rectilinear end bases. Arc end bases may be specified as an option.

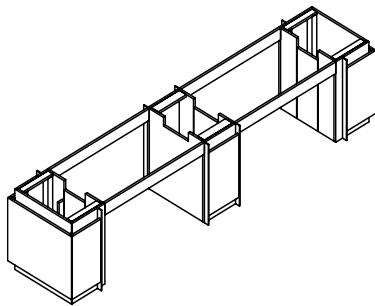
Arc End Bases

(an option to the panel base)



COLLECTIVE CONFERENCE

Rectangular Bases

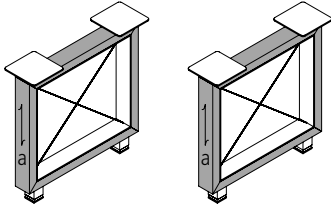


The rectangular base features wide wood pedestals surrounded by a wood accent. Each pedestal has a hinged door for wire management access, an ample storage compartment, and features a silver powder coat metal fin detail.

Collective Conference Tables Product Information

Open Cable Base

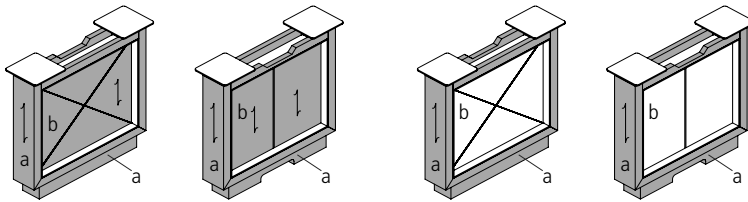
The open cable base is available in veneer only.



Open Cable Base
a. outer frame - veneer only

Closed Cable Base

There are two material options for the closed cable base. The outer frame and plinth are always veneer. The inner panel/door can be specified in the matching veneer or in a contrasting paint.



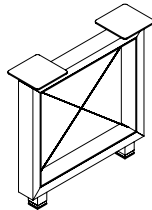
a. outer frame/plinth - veneer
b. inner panel/door - veneer

a. outer frame/plinth - veneer
b. inner panel/door - paint

photo copy or scan, submit with quote/order

Cable Base Ordering Worksheet

Open Cable Base



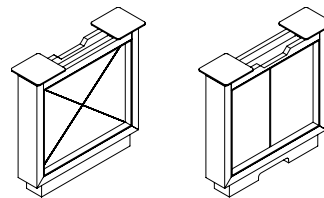
outer frame (a) - veneer only
wood species (choose one)
 cherry
 maple
 walnut

finish color - outer frame (a) _____
 (see page [CC2](#) for finish choices)

base
 feet
 plinth (veneer and finish matches outer frame)

metal frame / cable - arctic silver (standard)

Closed Cable Base



outer frame (a) - veneer only
wood species (choose one)
 cherry
 maple
 walnut

finish color - outer frame (a) _____
 (see page [CC2](#) for finish choices)

plinth style base only (veneer and finish matches outer frame)

inner panel/doors (b) - paint or veneer
 veneer (veneer and finish matches outer frame)
 paint
 color - inner panel/doors (b) _____
 (see page [CC2](#) for paint choices)

metal frame / cable - arctic silver (standard)

Collective Conference Tables Product Information

Panel and Rectangular Base Material Options

There are four finish schemes available for the panel (flat or arc) and rectangular bases.

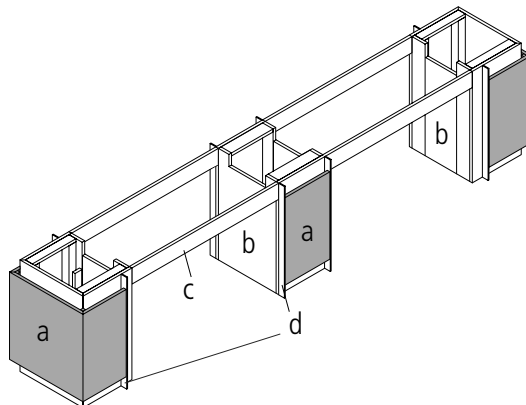
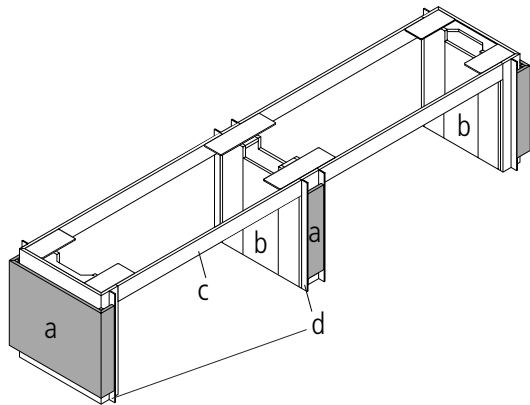


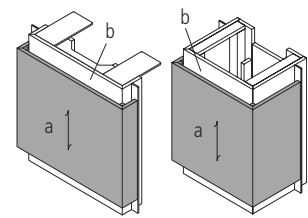
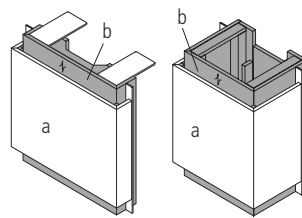
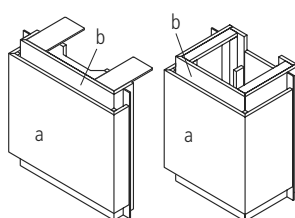
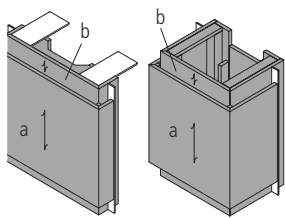
Table Base - Panel Style Parts

- a. accent panel and middle trim
- b. base cabinet
- c. apron
- d. metal trim fin

Table Base - Rectangular Style Parts

- a. accent surround and middle trim
- b. base cabinet
- c. apron
- d. metal trim fin

Finish Schemes



Scheme 1 - all veneer

- a. accent panel or surround - veneer
- b. base pedestal - veneer
- c. apron (shown below) - veneer

Scheme 2 - all paint

- a. accent panel or surround - paint
- b. base pedestal - paint
- c. apron (shown below) - paint

Scheme 3 - veneer and paint

- a. accent panel or surround - paint
- b. base pedestal - veneer
- c. apron (shown below) - veneer

Scheme 4 - paint and veneer

- a. accent panel or surround - veneer
- b. base pedestal - paint
- c. apron (shown below) - paint

photo copy or scan, submit with quote/order

Table Base Ordering Worksheet

part a - veneer or paint choice

(choose one)

cherry

maple

walnut

paint (MDF board)

finish or paint color - see page [CC2](#) for finish and paint choices) (part a) _____

part b & c- veneer or paint choice

(choose one)

cherry

maple

walnut

paint (MDF board)

finish or paint color - see page [CC2](#) for finish and paint choices) (part b) _____

part d - metal fin trim - arctic silver (standard)

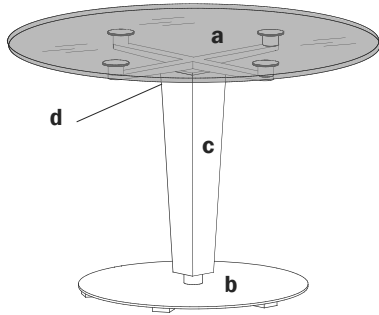
Collective Conference Tables Product Information

Round Meeting Tables and Bases

Collective Conference offers three styles of round meeting tables in several diameter sizes.

Glass Top with Column Disc Base

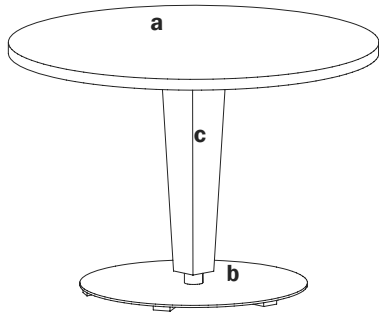
Available Tables - 48" dia - 42" dia - 36" dia (seats 3 to 4)



- a Top - ½" glass - frosted glass - acid etch underside
- b Base - 26" dia - cast aluminum - arctic silver powder coat
- c Column - veneer
cherry, maple, and walnut - (choice of one)
- d Spider Armature - glass puck (ultra-violet glue attachment) - arctic silver powder coat

Veneer Top with Column Disc Base

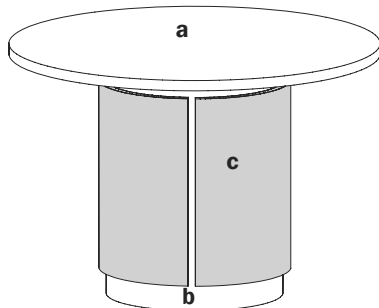
Available Tables - 48" dia - 42" dia - 36" dia - 30" dia (seats 3 to 4)



- a Top - 1½" veneer top (laminated surface available see page [CC3](#)) -
- b Base - 26" dia - cast aluminum - arctic silver powder coat
- c Column - veneer
cherry, maple, and walnut - (choice of one)

Veneer Top with Cylinder Base

Available Tables - 48" dia - 42" dia (seats 3 to 4)

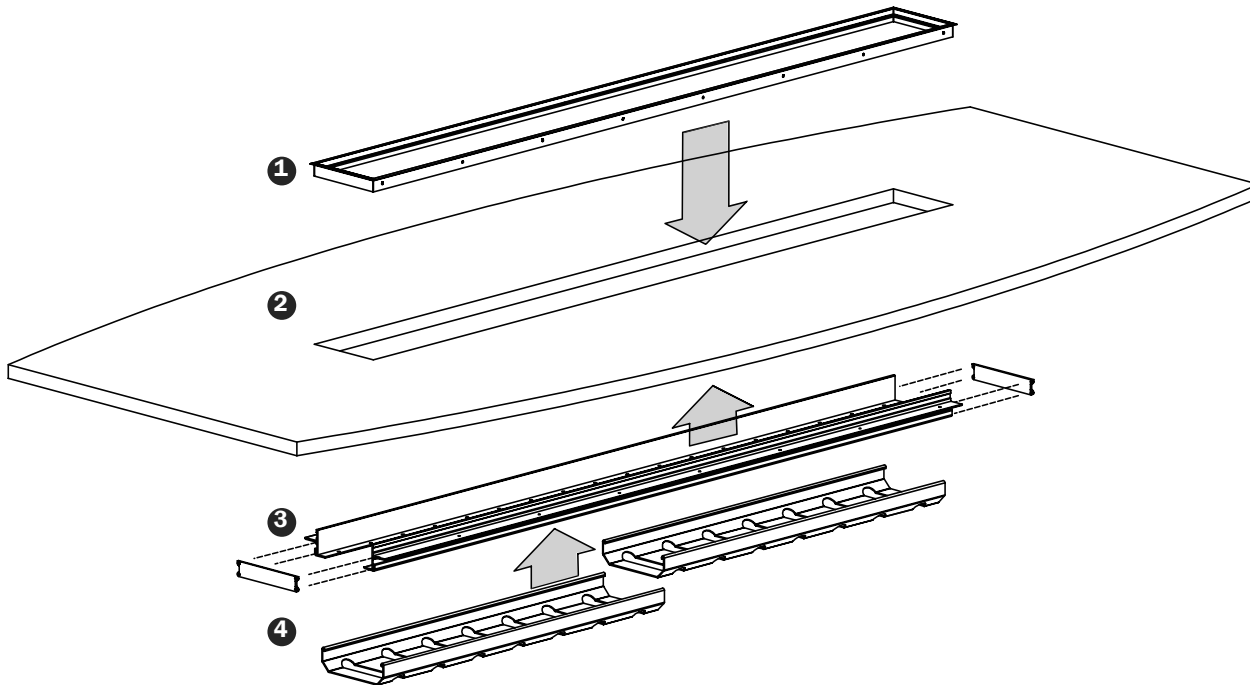


- a Top - 1½" veneer top (laminated surface available see page [CC3](#))
- b Cylinder Base - 24" dia - drum style construction
- c Accent Panel - veneer (choice of one)
cherry, maple and walnut
paint - (see page [CC2](#) for color choices)

Collective Conference Tables Product Information

Center Console Overview

The continuous center console supports a variety of functional and aesthetic options. A Collective Conference table with center console includes: the center spine assembly which houses 4", 8", 12" and 16" modules, ordered separately, the understructure of the console, and wire management tray as illustrated below.



COLLECTIVE CONFERENCE

1 Center Spine Bezel Assembly
The center spine bezel assembly accepts the 4", 8", 12" and 16" modules shown on pages [CC11](#) and [CC87](#) of the pricing section of this price list.

3 Center Spine Structural Extrusion Assembly
When a table with center console is specified, the center spine structural extrusion assembly is attached to the underside of the table top.

2 Table Top
Tops are available in several shapes including rectangular, racetrack, ellipse, arc end, boat and view. They come with or without center console.

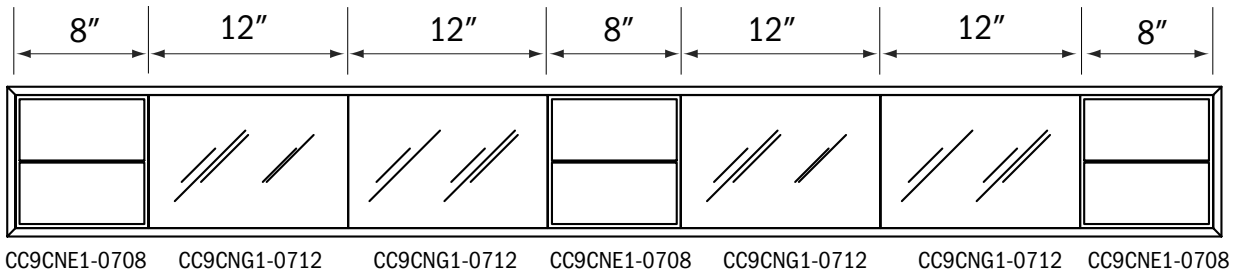
4 Wire Management Tray
When using power/data and lamp modules, the wire management tray channels the cords to the panel or rectangular bases.

Collective Conference Tables Product Information

Center Console Components

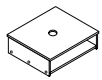
Collective Conference is available with a center console for storage, power/data and accessories. The center console is offered in lengths of: 48", 72", 96", 120", 144" & 160". The accessories are offered in 4" increments. When designing your center console the accessories selected must equal the length of your console. The center console is factory installed.

You must specify the order in which you want the accessories to appear using the chart on the bottom of the page.

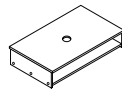


Center Console Accessories

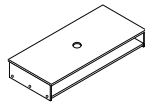
Storage



CC9CNS1-0708
8"



CC9CNS1-0712
12"

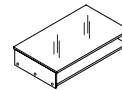


CC9CNS1-0716
16"

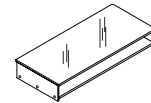
Glass Panels



CC9CNG1-0708
8"

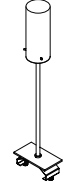


CC9CNG1-0712
12"



CC9CNG1-0716
16"

Lamp



CC9CML1-0704
4"

Vase



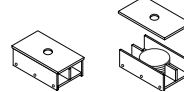
CC9CNS1-0704
4"

Accessory Shelf



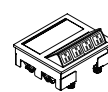
CC9CNA1-1516
16"

Coaster



CC9CNC1-0704
4"

Power Data Module



CC9CNE1-0708
8"

photo copy or scan, submit with quote/order

Center Console Worksheet - Order Sheet

A Use the following chart to determine the console length.

Table Length	Console Length
216"	160"
192"	144"
168"	120"
144"	96"
120"	72"
96"	48"

B List out the order in which you want the accessories to appear in the console.

Console Length _____

Item	Length	Item	Length
1. _____	_____	11. _____	_____
2. _____	_____	12. _____	_____
3. _____	_____	13. _____	_____
4. _____	_____	14. _____	_____
5. _____	_____	15. _____	_____
6. _____	_____	16. _____	_____
7. _____	_____	17. _____	_____
8. _____	_____	18. _____	_____
9. _____	_____	19. _____	_____
10. _____	_____	20. _____	_____

*Total length of accessory items must equal total length of console. _____

Collective Conference Tables Product Information

Finish and Product Reference Codes

Select	Code	Select	Code	Select	Code
Veneer		Walnut Finishes		Laminate Coordinates	
Cherry	CH1	Espresso	ESP	Cherry Wood Grain Patterns	
Maple	MA1	Mocha	MCH	Collectors	CLL
Walnut	WA1	Sienna	SIE	Harvest	HRV
		Truffle	TRF	Praline	PRL
		Umber	UMB		
Finish		Paint Finishes		Walnut Wood Grain Patterns	
Cherry		Backdrop	BKD	Mocha	MCH
Bourbon Medium	BBM	Black Fox	BFX	Sienna	SIE
Brighton Medium	BRM	Bright White	BWH	Truffle	TRF
Classic	CLA	Cargo Pants	CGP	Umber	UMB
Collectors	CLL	Chatroom	CHT		
Harvest	HRV	French Roast	FRR	Metal Finish	
Praline	PRL	Greek Villa	GRV	Arctic Silver	ASL
		Network Gray	NET	Anodized Aluminum	AAL
Maple Finishes		Nonchalant White	NWH		
Ale Medium	ALM	Storm	STM		
Butterscotch	BUT	Tricorn Black	TRC		
Flax	FLX				
Venetian	VEN				

COLLECTIVE CONFERENCE

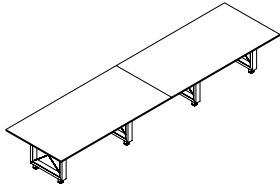
Order Check List:

Specify:

- 1. Model Number
- 2. Finish Scheme/Color (see pages [CC8-CC10](#))
- 3. Wood Species - cherry - maple - walnut
- 4. Top Options - standard veneer - laminate surface (see page [CC3](#)) - back painted white glass (glossy or frosted surface)
- 5. Aluminum Trim (rectangular tops only) - **if applicable**
- 6. Console Insert Accessories - **if applicable - order items separately**
- 7. Other Product Options
- 8. Power and Data Accessories (*drawing showing location and orientation must accompany order*)
- 9. Side Mark Information (*i.e. room number, East Conference Room*)
- 10. Shipping Address (*contact name and phone number*)
- 11. Special Delivery Instructions (*i.e. call before delivery, deliver to job site*)

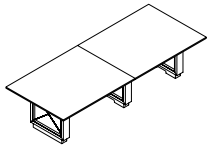
Collective Conference Tables Product Information

Description	Model	D	L	H	Seat Capacity	Top Pieces	Bases Required	CTN WT	CU FT	Veneer	Glass Top
Rectangular Table with Open Cable Base	CC8JRX1-48192	48	192	29	14	2	4	561	32	\$30,899	\$44,847



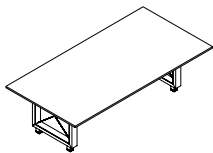
- short grain veneer direction
- base (4) CC8NC01-0427
- telescopic feet are anodized aluminum
- telescopic feet provide 1 1/2" leveling
- top is 1 1/4" thick and in two sections
- laminate worksurface, no charge if standard laminate is selected
- glass worksurface with reverse bevel edge, (see page [CC4](#))
- aluminum edge available on veneer and laminate tops, specify and add \$6,160 list

Rectangular Table with Open Cable Base	CC8JRX1-48168	48	168	29	12	2	3	460	26	\$24,281	\$36,489
	CC8JRX1-48144	48	144	29	8	2	3	421	24	\$22,458	\$32,920
	CC8JRX1-48120	48	120	29	6	2	3	381	21	\$20,986	\$29,185



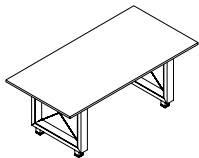
- short grain veneer direction
- base (3) CC8NC01-0427
- telescopic feet are anodized aluminum
- telescopic feet provide 1 1/2" leveling
- top is 1 1/4" thick and in two sections
- laminate worksurface, no charge if standard laminate is selected
- glass worksurface with reverse bevel edge, (see page [CC4](#))
- aluminum edge available on veneer and laminate tops, specify and add \$5,546 list for CC8JRX1-48168, \$4,928 list for CC8JRX1-48144 and \$4,313 list for CC8JRX1-48120

Rectangular Table with Open Cable Base	CC8JRX1-4896	48	96	29	6	1	2	281	16	\$14,379	\$20,940
--	---------------------	----	----	----	---	---	---	-----	----	----------	----------



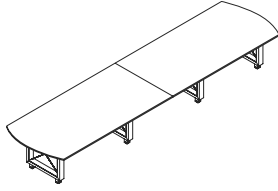
- long grain veneer direction
- base (2) CC8NC01-0427
- telescopic feet are anodized aluminum
- telescopic feet provide 1 1/2" leveling
- top is 1 1/4" thick
- laminate worksurface, no charge if standard laminate is selected
- glass worksurface with reverse bevel edge, (see page [CC4](#))
- aluminum edge available on veneer and laminate tops, specify and add \$3,699 list

Rectangular Table with Open Cable Base	CC8JRX1-4284	42	84	29	4	1	2	219	14	\$11,696	\$16,719
	CC8JRX1-3672	36	72	29	4	1	2	189	12	\$10,814	\$14,505



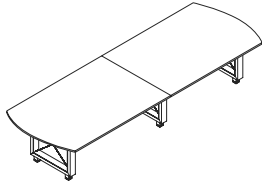
- long grain veneer direction
- base (2) CC8NC01-0423
- telescopic feet are anodized aluminum
- telescopic feet provide 1 1/2" leveling
- top is 1 1/4" thick
- laminate worksurface, no charge if standard laminate is selected
- glass worksurface with reverse bevel edge, (see page [CC4](#))
- aluminum edge available on veneer and laminate tops, specify and add \$3,237 list for CC8JRX1-4284, \$2,775 list for CC8JRX1-3672

Description	① Model	D	L	H	Seat Capacity	Top Pieces	Bases Required	CTN WT	CU FT	Veneer	Glass Top
Arc End Table with Open Cable Base	CC8JAX1-48192	48	192	29	14	2	4	561	32	\$31,548	\$45,496



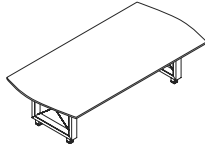
- short grain veneer direction
- base (4) CC8NC01-0427
- telescopic feet are anodized aluminum
- telescopic feet provide 1 1/2" leveling
- top is 1 1/4" thick and in two sections
- laminate worksurface, no charge if standard laminate is selected
- glass worksurface with reverse bevel edge, (see page [CC4](#))

Arc End Table with Open Cable Base	CC8JAX1-48168	48	168	29	12	2	3	460	26	\$24,836	\$37,041
	CC8JAX1-48144	48	144	29	8	2	3	421	24	\$22,922	\$33,383
	CC8JAX1-48120	48	120	29	6	2	3	381	21	\$21,365	\$29,562



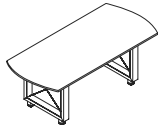
- short grain veneer direction
- base (3) CC8NC01-0427
- telescopic feet are anodized aluminum
- telescopic feet provide 1 1/2" leveling
- top is 1 1/4" thick and in two sections
- laminate worksurface, no charge if standard laminate is selected
- glass worksurface with reverse bevel edge, (see page [CC4](#))

Arc End Table with Open Cable Base	CC8JAX1-4896	48	96	29	6	1	2	281	16	\$14,653	\$21,214
------------------------------------	---------------------	----	----	----	---	---	---	-----	----	----------	----------



- long grain veneer direction
- base (2) CC8NC01-0427
- telescopic feet are anodized aluminum
- telescopic feet provide 1 1/2" leveling
- top is 1 1/4" thick
- laminate worksurface, no charge if standard laminate is selected
- glass worksurface with reverse bevel edge, (see page [CC4](#))

Arc End Table with Open Cable Base	CC8JAX1-4284	42	84	29	4	1	2	219	14	\$11,894	\$16,917
	CC8JAX1-3672	36	72	29	4	1	2	189	12	\$10,957	\$14,647



- long grain veneer direction
- base (2) CC8NC01-0423
- telescopic feet are anodized aluminum
- telescopic feet provide 1 1/2" leveling
- top is 1 1/4" thick
- laminate worksurface, no charge if standard laminate is selected
- glass worksurface with reverse bevel edge, (see page [CC4](#))

To Order, Specify:

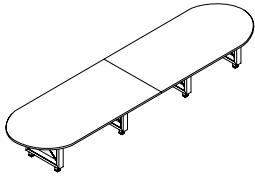
Rectangular Table with Open Cable Base

- ① Model Number
- ② Wood Species
- ③ Finish Color
- ④ Worksurface Option
 - A. Veneer
 - B. Laminate
 - C. Glossy Low Iron White Back Painted Glass
 - D. Frosted Low Iron White Back Painted Glass (see page [CC4](#))
- ⑤ Edge Detail
 - A. Straight
 - B. Aluminum Trim
- ⑥ Power and Data Options (see [accessories price list](#))
- ⑦ Other Product Options

Arc End Table with Open Cable Base

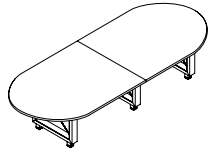
- ① Model Number
- ② Wood Species
- ③ Finish Color
- ④ Worksurface Option
 - A. Veneer
 - B. Laminate
 - C. Glossy Low Iron White Back Painted Glass
 - D. Frosted Low Iron White Back Painted Glass (see page [CC4](#))
- ⑤ Power and Data Options (see [accessories price list](#))
- ⑦ Other Product Options

Description	Model	D	L	H	Seat Capacity	Top Pieces	Bases Required	CTN WT	CU FT	Veneer	Glass Top
Racetrack Table with Open Cable Base	CC8J0X1-48192	48	192	29	14	2	4	535	42	\$31,763	\$45,711



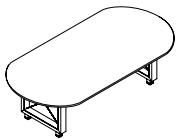
- short grain veneer direction
- base (4) CC8NC01-0427
- telescopic feet are anodized aluminum
- telescopic feet provide 1 1/2" leveling
- top is 1 1/4" thick and in two sections
- laminate worksurface, no charge if standard laminate is selected
- glass worksurface with reverse bevel edge, (see page [CC4](#))

Racetrack Table with Open Cable Base	CC8J0X1-48168	48	168	29	12	2	3	453	26	\$25,022	\$37,229
	CC8J0X1-48144	48	144	29	8	2	3	405	24	\$23,077	\$33,537
	CC8J0X1-48120	48	120	29	6	2	3	365	21	\$21,494	\$29,691



- short grain veneer direction
- base (3) CC8NC01-0427
- telescopic feet are anodized aluminum
- telescopic feet provide 1 1/2" leveling
- top is 1 1/4" thick and in two sections
- laminate worksurface, no charge if standard laminate is selected
- glass worksurface with reverse bevel edge, (see page [CC4](#))

Racetrack Table with Open Cable Base	CC8J0X1-4896	48	96	29	6	1	2	256	16	\$14,746	\$21,306
--------------------------------------	---------------------	----	----	----	---	---	---	-----	----	----------	----------



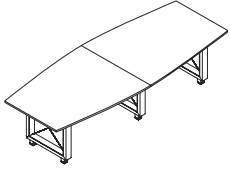
- long grain veneer direction
- base (2) CC8NC01-0427
- telescopic feet are anodized aluminum
- telescopic feet provide 1 1/2" leveling
- top is 1 1/4" thick
- laminate worksurface, no charge if standard laminate is selected
- glass worksurface with reverse bevel edge, (see page [CC4](#))

Racetrack Table with Open Cable Base	CC8J0X1-4284	42	84	29	4	1	2	206	14	\$11,963	\$16,986
	CC8J0X1-3672	36	72	29	4	1	2	180	12	\$11,008	\$14,696



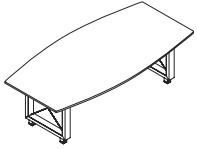
- long grain veneer direction
- base (2) CC8NC01-0423
- telescopic feet are anodized aluminum
- telescopic feet provide 1 1/2" leveling
- top is 1 1/4" thick
- laminate worksurface, no charge if standard laminate is selected
- glass worksurface with reverse bevel edge, (see page [CC4](#))

Description	① Model	D	L	H	Seat Capacity	Top Pieces	Bases Required	CTN WT	CU FT	Veneer	Glass Top
Boat Shape Table with Open Cable Base	CC8JBX1-48144	48	144	29	8	2	3	393	24	\$24,965	\$35,426
	CC8JBX1-48120	48	120	29	6	2	3	358	21	\$23,034	\$31,232



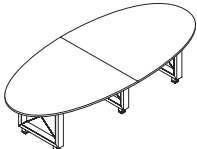
- short grain veneer direction
- base (3) CC8NC01-0427
- telescopic feet are anodized aluminum
- telescopic feet provide 1 1/2" leveling
- top is 1 1/4" thick
- laminate worksurface, no charge if standard laminate is selected
- glass worksurface with reverse bevel edge, (see page CC4)

Boat Shape Table with Open Cable Base	CC8JBX1-4896	48	96	29	6	1	2	262	16	\$15,901	\$22,460
---------------------------------------	--------------	----	----	----	---	---	---	-----	----	----------	----------



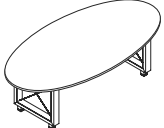
- long grain veneer direction
- base (2) CC8NC01-0427
- telescopic feet are anodized aluminum
- telescopic feet provide 1 1/2" leveling
- top is 1 1/4" thick
- laminate worksurface, no charge if standard laminate is selected
- glass worksurface with reverse bevel edge, (see page CC4)

Ellipse Table with Open Cable Base	CC8JEX1-54120	54	120	29	8	2	3	354	23	\$23,817	\$33,038
------------------------------------	---------------	----	-----	----	---	---	---	-----	----	----------	----------



- long grain veneer direction
- base (3) CC8NC01-0427
- telescopic feet are anodized aluminum
- telescopic feet provide 1 1/2" leveling
- top is 1 1/4" thick and in two sections
- laminate worksurface, no charge if standard laminate is selected
- glass worksurface with reverse bevel edge, (see page CC4)

Ellipse Table with Open Cable Base	CC8JEX1-4896	48	96	29	6	1	2	244	16	\$16,437	\$22,998
------------------------------------	--------------	----	----	----	---	---	---	-----	----	----------	----------



- long grain veneer direction
- base (2) CC8NC01-0423
- telescopic feet are anodized aluminum
- telescopic feet provide 1 1/2" leveling
- top is 1 1/4" thick
- laminate worksurface, no charge if standard laminate is selected
- glass worksurface with reverse bevel edge, (see page CC4)

To Order, Specify:

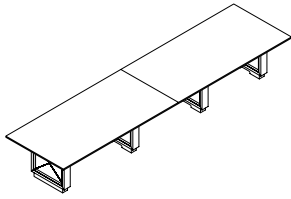
Racetrack Table with Open Cable Base

- ① Model Number
- ② Wood Species
- ③ Finish Color
- ④ Worksurface Option
 - A. Veneer
 - B. Laminate
 - C. Glossy Low Iron White Back Painted Glass
 - D. Frosted Low Iron White Back Painted Glass (see page CC4)
- ⑤ Power and Data Options (see [accessories price list](#))
- ⑥ Other Product Options

Boat Shape or Ellipse Table with Open Cable Base

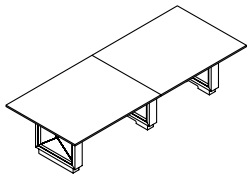
- ① Model Number
- ② Wood Species
- ③ Finish Color
- ④ Worksurface Option
 - A. Veneer
 - B. Laminate
 - C. Glossy Low Iron White Back Painted Glass
 - D. Frosted Low Iron White Back Painted Glass (see page CC4)
- ⑤ Power and Data Options (see [accessories price list](#))
- ⑥ Other Product Options

Description	Model	D	L	H	Seat Capacity	Top Pieces	Bases Required	CTN WT	CU FT	Veneer	Glass Top
Rectangular Table with Closed Cable Base	CC8JRY1-48192	48	192	29	14	2	4	601	32	\$26,824	\$40,772



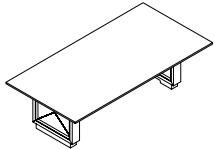
- short grain veneer direction
- bases (2) CC8NCC1-0527 outside and (2) CC8NCM1-0527 middle
- plinth base
- top is 1 ¼" thick and in two sections
- laminate worksurface, no charge if standard laminate is selected
- glass worksurface with reverse bevel edge, (see page [CC4](#))
- aluminum edge available on veneer and laminate tops, specify and add \$6,160 list

Rectangular Table with Closed Cable Base	CC8JRY1-48168	48	168	29	12	2	3	490	26	\$22,734	\$34,940
	CC8JRY1-48144	48	144	29	8	2	3	451	24	\$20,911	\$31,373
	CC8JRY1-48120	48	120	29	6	2	3	411	21	\$19,441	\$27,640



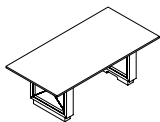
- short grain veneer direction
- bases (2) CC8NCC1-0527 outside and (1) CC8NCM1-0527 middle
- plinth base
- top is 1 ¼" thick and in two sections
- laminate worksurface, no charge if standard laminate is selected
- glass worksurface with reverse bevel edge, (see page [CC4](#))
- aluminum edge available on veneer and laminate tops, specify and add \$5,546 list for CC8JRY1-48168, \$4,928 list for CC8JRY1-48144 and \$4,313 list for CC8JRY1-48120

Rectangular Table with Closed Cable Base	CC8JRY1-4896	48	96	29	6	1	2	301	16	\$15,361	\$21,922
--	---------------------	----	----	----	---	---	---	-----	----	----------	----------



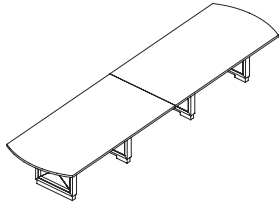
- long grain veneer direction
- bases (2) CC8NCC1-0527
- plinth base
- top is 1 ¼" thick
- laminate worksurface, no charge if standard laminate is selected
- glass worksurface with reverse bevel edge, (see page [CC4](#))
- aluminum edge available on veneer and laminate tops, specify and add \$3,699 list

Rectangular Table with Closed Cable Base	CC8JRY1-4284	42	84	29	4	1	2	245	14	\$12,953	\$17,976
	CC8JRY1-3672	36	72	29	4	1	2	213	12	\$12,071	\$15,759



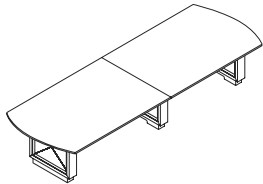
- long grain veneer direction
- bases (2) CC8NCC1-0523
- plinth base
- top is 1 ¼" thick
- laminate worksurface, no charge if standard laminate is selected
- glass worksurface with reverse bevel edge, (see page [CC4](#))
- aluminum edge available on veneer and laminate tops, specify and add \$3,237 list for CC8JRY1-4284, \$2,775 list for CC8JRY1-3672

Description	Model	D	L	H	Seat Capacity	Top Pieces	Bases Required	CTN WT	CU FT	Veneer	Glass Top
Arc End Table with Closed Cable Base	CC8JAY1-48192	48	192	29	14	2	4	601	32	\$27,473	\$41,422



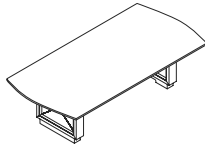
- short grain veneer direction
- bases (2) CC8NCC1-0527 outside and (2) CC8NCM1-0527 middle
- plinth base
- top is 1 1/4" thick
- laminate worksurface, no charge if standard laminate is selected
- glass worksurface with reverse bevel edge, (see page CC4)

Arc End Table with Closed Cable Base	CC8JAY1-48168	48	168	29	12	2	3	490	26	\$23,293	\$35,499
	CC8JAY1-48144	48	144	29	8	2	3	451	24	\$21,373	\$31,835
	CC8JAY1-48120	48	120	29	6	2	3	411	21	\$19,818	\$28,017



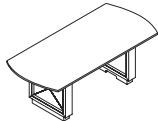
- short grain veneer direction
- bases (2) CC8NCC1-0527 outside and (1) CC8NCM1-0527 middle
- plinth base
- top is 1 1/4" thick
- laminate worksurface, no charge if standard laminate is selected
- glass worksurface with reverse bevel edge, (see page CC4)

Arc End Table with Closed Cable Base	CC8JAY1-4896	48	96	29	6	1	2	301	16	\$15,636	\$22,195
--------------------------------------	--------------	----	----	----	---	---	---	-----	----	----------	----------



- long grain veneer direction
- bases (2) CC8NCC1-0527
- plinth base
- top is 1 1/4" thick
- laminate worksurface, no charge if standard laminate is selected
- glass worksurface with reverse bevel edge, (see page CC4)

Arc End Table with Closed Cable Base	CC8JAY1-4284	42	84	29	4	1	2	245	14	\$13,155	\$18,179
	CC8JAY1-3672	36	72	29	4	1	2	213	12	\$12,217	\$15,905



- long grain veneer direction
- bases (2) CC8NCC1-0523
- plinth base
- top is 1 1/4" thick
- laminate worksurface, no charge if standard laminate is selected
- glass worksurface with reverse bevel edge, (see page CC4)

To Order, Specify:

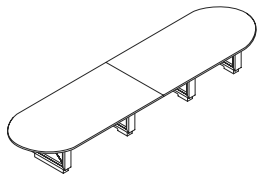
Rectangular Table with Closed Cable Base

- Model Number
- Wood Species
- Finish Color
- Worksurface Option
 - Veneer
 - Laminate
 - Glossy Low Iron White Back Painted Glass
 - Frosted Low Iron White Back Painted Glass (see page CC4)
- Edge Detail
 - Straight
 - Aluminum Trim
- Power and Data Options (see [accessories price list](#))
- Other Product Options

Arc End Table with Closed Cable Base

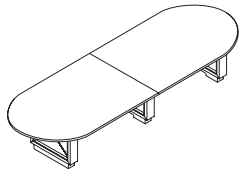
- Model Number
- Wood Species
- Finish Color
- Worksurface Option
 - Veneer
 - Laminate
 - Glossy Low Iron White Back Painted Glass
 - Frosted Low Iron White Back Painted Glass (see page CC4)
- Power and Data Options (see [accessories price list](#))
- Other Product Options

Description	① Model	D	L	H	Seat Capacity	Top Pieces	Bases Required	CTN WT	CU FT	Veneer	Glass Top
-------------	---------	---	---	---	---------------	------------	----------------	--------	-------	--------	-----------



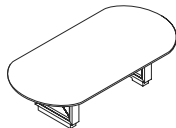
- short grain veneer direction
- bases (2) CC8NCC1-0527 outside and (2) CC8NCM1-0527 middle
- plinth base
- top is 1 ¼" thick and in two sections
- laminate worksurface, no charge if standard laminate is selected
- glass worksurface with reverse bevel edge, (see page [CC4](#))

Racetrack Table with Closed Cable Base	CC8JOY1-48168	48	168	29	12	2	3	483	26	\$23,478	\$35,685
	CC8JOY1-48144	48	144	29	8	2	3	435	24	\$21,531	\$31,992
	CC8JOY1-48120	48	120	29	6	2	3	395	21	\$19,943	\$28,143



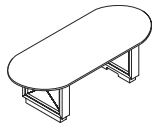
- short grain veneer direction
- bases (2) CC8NCC1-0527 outside and (1) CC8NCM1-0527 middle
- plinth base
- top is 1 ¼" thick and in two sections
- laminate worksurface, no charge if standard laminate is selected
- glass worksurface with reverse bevel edge, (see page [CC4](#))

Racetrack Table with Closed Cable Base	CC8JOY1-4896	48	96	29	6	1	2	276	16	\$15,727	\$22,285
--	---------------------	----	----	----	---	---	---	-----	----	----------	----------



- long grain veneer direction
- bases (2) CC8NCC1-0527
- plinth base
- top is 1 ¼" thick
- laminate worksurface, no charge if standard laminate is selected
- glass worksurface with reverse bevel edge, (see page [CC4](#))

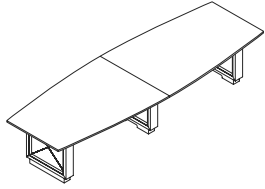
Racetrack Table with Closed Cable Base	CC8JOY1-4284	42	84	29	4	1	2	232	14	\$13,220	\$18,242
	CC8JOY1-3672	36	72	29	4	1	2	213	12	\$12,266	\$15,953



- long grain veneer direction
- bases (2) CC8NCC1-0523
- plinth base
- top is 1 ¼" thick
- laminate worksurface, no charge if standard laminate is selected
- glass worksurface with reverse bevel edge, (see page [CC4](#))

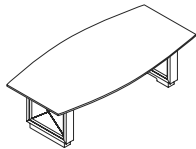
COLLECTIVE CONFERENCE

Description	Model	D	L	H	Seat Capacity	Top Pieces	Bases Required	CTN WT	CU FT	Veneer	Glass Top
Boat Shape Table with Closed Cable Base	CC8JBY1-48144	48	144	29	8	2	3	423	24	\$23,418	\$33,878
	CC8JBY1-48120	48	120	29	6	2	3	388	21	\$21,485	\$29,682



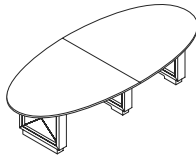
- short grain veneer direction
- bases (2) CC8NCC1-0527 outside and (1) CC8NCM1-0527 middle
- plinth base
- top is 1 1/4" thick and in two sections
- laminate worksurface, no charge if standard laminate is selected
- glass worksurface with reverse bevel edge, (see page CC4)

Boat Shape Table with Closed Cable Base	CC8JBY1-4896	48	96	29	6	1	2	282	16	\$16,883	\$23,442
---	--------------	----	----	----	---	---	---	-----	----	----------	----------



- long grain veneer direction
- bases (2) CC8NCC1-0527
- plinth base
- top is 1 1/4" thick
- laminate worksurface, no charge if standard laminate is selected
- glass worksurface with reverse bevel edge, (see page CC4)

Ellipse Table with Closed Cable Base	CC8JEY1-54120	54	120	29	8	2	3	384	23	\$22,268	\$31,491
--------------------------------------	---------------	----	-----	----	---	---	---	-----	----	----------	----------



- short grain veneer direction
- bases (2) CC8NCC1-0527 outside and (1) CC8NCM1-0527 middle
- plinth base
- top is 1 1/4" thick and in two sections
- laminate worksurface, no charge if standard laminate is selected
- glass worksurface with reverse bevel edge, (see page CC4)

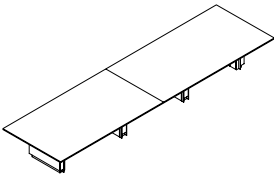
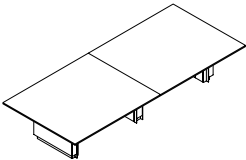
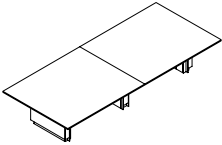
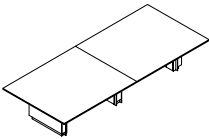
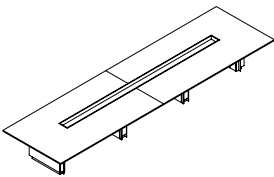
Ellipse Table with Closed Cable Base	CC8JEY1-4896	48	96	29	6	1	2	264	16	\$17,420	\$23,980
--------------------------------------	--------------	----	----	----	---	---	---	-----	----	----------	----------



- long grain veneer direction
- base (2) CC8NCC1-0527
- plinth base
- top is 1 1/4" thick
- laminate worksurface, no charge if standard laminate is selected
- glass worksurface with reverse bevel edge, (see page CC4)

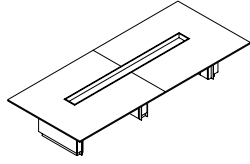
To Order, Specify:

- 1 Model Number
- 2 Wood Species
- 3 Finish Color
- 4 Worksurface Option
 - A. Veneer
 - B. Laminate
 - C. Glossy Low Iron White Back Painted Glass
 - D. Frosted Low Iron White Back Painted Glass
 (see page CC4)
- 5 Power and Data Options (see [accessories price list](#))
- 6 Other Product Options

Description	Model	D	L	H	Seat Capacity	Top Pieces	Bases Required	CTN WT	CU FT	Veneer	Glass Top
Rectangular Table with Panel Base 	CC8JRP2-60216	60	216	29	18	2	4	813	47	\$33,887	\$53,503
<ul style="list-style-type: none"> • short grain veneer direction • base CC8NPC2-32174 • plinth base • top is 1 1/4" thick and in two sections • laminate worksurface, no charge if standard laminate is selected • base front arc panel, add \$692 to list, arc is only outside bases • glass worksurface with reverse bevel edge, (see page CC4) • aluminum edge available on veneer and laminate tops, specify and add \$7,081 list 											
Rectangular Table with Panel Base 	CC8JRP2-60192	60	192	29	16	2	3	682	39	\$26,375	\$43,811
<ul style="list-style-type: none"> • short grain veneer direction • base CC8NPC2-32156 • plinth base • top is 1 1/4" thick and in two sections • laminate worksurface, no charge if standard laminate is selected • base front arc panel, add \$692 to list, arc is only outside bases • glass worksurface with reverse bevel edge, (see page CC4) • aluminum edge available on veneer and laminate tops, specify and add \$6,467 list 											
Rectangular Table with Panel Base 	CC8JRP2-60168	60	168	29	14	2	3	630	36	\$23,681	\$38,940
<ul style="list-style-type: none"> • short grain veneer direction • base CC8NPC2-32132 • plinth base • top is 1 1/4" thick and in two sections • laminate worksurface, no charge if standard laminate is selected • base front arc panel, add \$692 to list, arc is only outside bases • glass worksurface with reverse bevel edge, (see page CC4) • aluminum edge available on veneer and laminate tops, specify and add \$5,853 list 											
Rectangular Table with Panel Base 	CC8JRP2-60144	60	144	29	10	2	3	578	33	\$21,537	\$34,614
<ul style="list-style-type: none"> • short grain veneer direction • base CC8NPC2-32108 • plinth base • top is 1 1/4" thick and in two sections • laminate worksurface, no charge if standard laminate is selected • base front arc panel, add \$692 to list, arc is only outside bases • glass worksurface with reverse bevel edge, (see page CC4) • aluminum edge available on veneer and laminate tops, specify and add \$5,236 list 											
Rectangular Table with Panel Base and Center Console 	CC8JRP2-60216	60	216	29	18	2	4	814	55	\$41,659	\$61,276
<ul style="list-style-type: none"> • short grain veneer direction • base CC8NPC2-32174 • plinth base • top is 1 1/4" thick and in two sections • anodized aluminum center console 160" long • laminate worksurface, no charge if standard laminate is selected • base front arc panel, add \$692 to list, arc is only outside bases • glass worksurface with reverse bevel edge, (see page CC4) • aluminum edge available on veneer and laminate tops, specify and add \$7,081 list 											

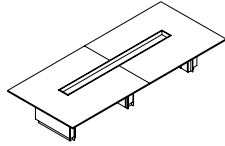
COLLECTIVE CONFERENCE

Description	① Model	D	L	H	Seat Capacity	Top Pieces	Bases Required	CTN WT	CU FT	Veneer	Glass Top
Rectangular Table with Panel Base and Center Console	CC8JRP-60192	60	192	29	16	2	3	692	46	\$33,086	\$50,520



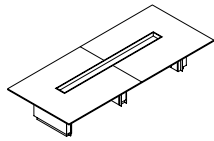
- short grain veneer direction
- base CC8NPC2-32156
- plinth base
- top is 1 1/4" thick and in two sections
- anodized aluminum center console 144" long
- laminate worksurface, no charge if standard laminate is selected
- base front arc panel, add \$692 to list, arc is only outside bases
- glass worksurface with reverse bevel edge, (see page CC4)
- aluminum edge available on veneer and laminate tops, specify and add \$6,467 list

Rectangular Table with Panel Base and Center Console	CC8JRP-60168	60	168	29	14	2	3	631	42	\$29,336	\$44,593
--	---------------------	----	-----	----	----	---	---	-----	----	----------	----------



- short grain veneer direction
- base CC8NPC2-32132
- plinth base
- top is 1 1/4" thick and in two sections
- anodized aluminum center console 120" long
- laminate worksurface, no charge if standard laminate is selected
- base front arc panel, add \$692 to list, arc is only outside bases
- glass worksurface with reverse bevel edge, (see page CC4)
- aluminum edge available on veneer and laminate tops, specify and add \$5,853 list

Rectangular Table with Panel Base and Center Console	CC8JRP-60144	60	144	29	10	2	3	578	39	\$26,129	\$39,206
--	---------------------	----	-----	----	----	---	---	-----	----	----------	----------



- short grain veneer direction
- base CC8NPC2-32108
- plinth base
- top is 1 1/4" thick and in two sections
- anodized aluminum center console 96" long
- laminate worksurface, no charge if standard laminate is selected
- base front arc panel, add \$692 to list, arc is only outside bases
- glass worksurface with reverse bevel edge, (see page CC4)
- aluminum edge available on veneer and laminate tops, specify and add \$5,236 list

To Order, Specify:

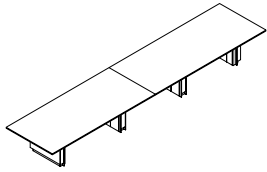
Rectangular Table

- ① Model Number
- ② Wood Species
- ③ Finish Scheme
 - A. Accent Surround - Veneer or Paint
 - B. Base Pedestal - Veneer or Paint
(see page CC8 - apron follows base pedestal)
- ④ Worksurface Option
 - A. Veneer
 - B. Laminate
 - C. Glossy Low Iron White Back Painted Glass
 - D. Frosted Low Iron White Back Painted Glass
(see page CC4)
- ⑤ Power and Data Options (see [accessories price list](#))
- ⑥ Other Product Options

Rectangular Table with Center Console

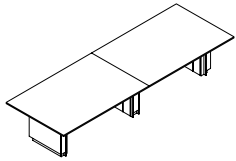
- ① Model Number
- ② Wood Species
- ③ Finish Scheme
 - A. Accent Surround - Veneer or Paint
 - B. Base Pedestal - Veneer or Paint
(see page 312 - apron follows base pedestal)
- ④ Worksurface Option
 - A. Veneer
 - B. Laminate
 - C. Glossy Low Iron White Back Painted Glass
 - D. Frosted Low Iron White Back Painted Glass
(see page CC4)
- ⑤ Power and Data Options (see [accessories price list](#))
- ⑥ Other Product Option
- ⑦ Center Console Accessories (see pages CC86-CC87 - order separately)

Description	① Model	D	L	H	Seat Capacity	Top Pieces	Bases Required	CTN WT	CU FT	Veneer	Glass Top
Rectangular Table with Panel Base	CC8JRP2-48216	48	216	29	16	2	4	702	38	\$28,780	\$44,472



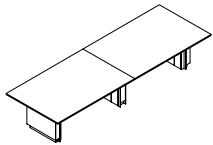
- short grain veneer direction
- base CC8NPC2-27174
- plinth base
- top is 1 1/4" thick and in two sections
- laminate worksurface, no charge if standard laminate is selected
- base front arc panel, add \$692 to list, arc is only outside bases
- glass worksurface with reverse bevel edge, (see page [CC4](#))
- aluminum edge available on veneer and laminate tops, specify and add \$6,775 list

Rectangular Table with Panel Base	CC8JRP2-48192	48	192	29	14	2	3	581	32	\$22,117	\$36,065
-----------------------------------	----------------------	----	-----	----	----	---	---	-----	----	----------	----------



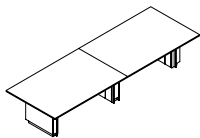
- short grain veneer direction
- base CC8NPC2-27156
- plinth base
- top is 1 1/4" thick and in two sections
- laminate worksurface, no charge if standard laminate is selected
- base front arc panel, add \$692 to list, arc is only outside bases
- glass worksurface with reverse bevel edge, (see page [CC4](#))
- aluminum edge available on veneer and laminate tops, specify and add \$6,160 list

Rectangular Table with Panel Base	CC8JRP2-48168	48	168	29	12	2	3	538	29	\$19,921	\$32,127
-----------------------------------	----------------------	----	-----	----	----	---	---	-----	----	----------	----------



- short grain veneer direction
- base CC8NPC2-27132
- plinth base
- top is 1 1/4" thick and in two sections
- laminate worksurface, no charge if standard laminate is selected
- base front arc panel, add \$692 to list, arc is only outside bases
- glass worksurface with reverse bevel edge, (see page [CC4](#))
- aluminum edge available on veneer and laminate tops, specify and add \$5,546 list

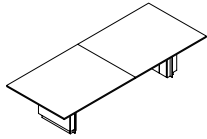
Rectangular Table with Panel Base	CC8JRP2-48144	48	144	29	8	2	3	497	27	\$18,243	\$28,707
-----------------------------------	----------------------	----	-----	----	---	---	---	-----	----	----------	----------



- short grain veneer direction
- base CC8NPC2-27108
- plinth base
- top is 1 1/4" thick and in two sections
- laminate worksurface, no charge if standard laminate is selected
- base front arc panel, add \$692 to list, arc is only outside bases
- glass worksurface with reverse bevel edge, (see page [CC4](#))
- aluminum edge available on veneer and laminate tops, specify and add \$4,928 list

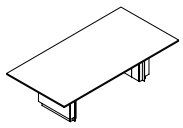
Description	① Model	D	L	H	Seat Capacity	Top Pieces	Bases Required	CTN WT	CU FT	Veneer	Glass Top
Rectangular Table with Panel Base	CC8JRP2-48120	48	120	29	6	2	2	375	20	\$11,861	\$20,059

- short grain veneer direction
- base CC8NPC2-2784
- plinth base
- top is 1 1/4" thick and in two sections
- laminate worksurface, no charge if standard laminate is selected
- base front arc panel, add \$692 to list, arc is only outside bases
- glass worksurface with reverse bevel edge, (see page [CC4](#))
- aluminum edge available, specify and add \$4,313 list



Rectangular Table with Panel Base	CC8JRP2-4896	48	96	29	6	1	2	334	18	\$9,986	\$16,546
-----------------------------------	---------------------	----	----	----	---	---	---	-----	----	---------	----------

- long grain veneer direction
- base CC8NPC2-2760
- plinth base
- top is 1 1/4" thick
- laminate worksurface, no charge if standard laminate is selected
- base front arc panel, add \$692 to list, arc is only outside bases
- glass worksurface with reverse bevel edge, (see page [CC4](#))
- aluminum edge available, specify and add \$3,699 list

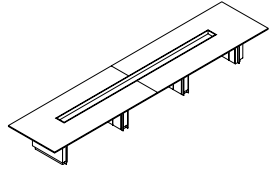


COLLECTIVE CONFERENCE

To Order, Specify:

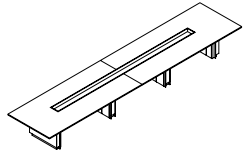
- ① Model Number
- ② Wood Species
- ③ Finish Scheme
 - A. Accent Surround - Veneer or Paint
 - B. Base Pedestal - Veneer or Paint
 (see page [CC8](#) - apron follows base pedestal)
- ④ Edge Detail
 - A. Straight
 - B. Aluminum Trim
- ⑤ Worksurface Option
 - A. Veneer
 - B. Laminate
 - C. Glossy Low Iron White Back Painted Glass
 - D. Frosted Low Iron White Back Painted Glass
 (see page [CC4](#))
- ⑥ Power and Data Options (see [accessories price list](#))
- ⑦ Other Product Options

Description	Model	D	L	H	Seat Capacity	Top Pieces	Bases Required	CTN WT	CU FT	Veneer	Glass Top
-------------	-------	---	---	---	---------------	------------	----------------	--------	-------	--------	-----------



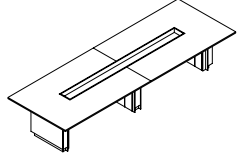
- short grain veneer direction
- base CC8NPC2-27174
- plinth base
- top is 1 1/4" thick and in two sections
- anodized aluminum center console 160" long
- laminate worksurface, no charge if standard laminate is selected
- base front arc panel, add \$692 to list, arc is only outside bases
- glass worksurface with reverse bevel edge, (see page [CC4](#))
- aluminum edge available, specify and add \$6,775 list

Rectangular Table with Panel Base and Center Console	CC8JRP-48192	48	192	29	14	2	4	581	37	\$28,831	\$42,780
--	---------------------	----	-----	----	----	---	---	-----	----	----------	----------



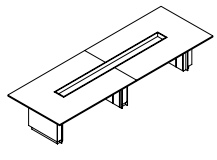
- short grain veneer direction
- base CC8NPC2-27156
- plinth base
- top is 1 1/4" thick and in two sections
- anodized aluminum center console 144" long
- laminate worksurface, no charge if standard laminate is selected
- base front arc panel, add \$692 to list, arc is only outside bases
- glass worksurface with reverse bevel edge, (see page [CC4](#))
- aluminum edge available, specify and add \$6,160 list

Rectangular Table with Panel Base and Center Console	CC8JRP-48168	48	168	29	12	2	4	539	34	\$25,572	\$37,778
--	---------------------	----	-----	----	----	---	---	-----	----	----------	----------



- short grain veneer direction
- base CC8NPC2-27132
- plinth base
- top is 1 1/4" thick and in two sections
- anodized aluminum center console 120" long
- laminate worksurface, no charge if standard laminate is selected
- base front arc panel, add \$692 to list, arc is only outside bases
- glass worksurface with reverse bevel edge, (see page [CC4](#))
- aluminum edge available, specify and add \$5,546 list

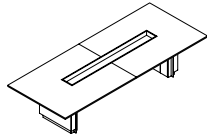
Rectangular Table with Panel Base and Center Console	CC8JRP-48144	48	144	29	8	2	3	497	31	\$22,838	\$33,299
--	---------------------	----	-----	----	---	---	---	-----	----	----------	----------



- short grain veneer direction
- base CC8NPC2-27108
- plinth base
- top is 1 1/4" thick and in two sections
- anodized aluminum center console 96" long
- laminate worksurface, no charge if standard laminate is selected
- base front arc panel, add \$692 to list, arc is only outside bases
- glass worksurface with reverse bevel edge, (see page [CC4](#))
- aluminum edge available, specify and add \$4,928 list

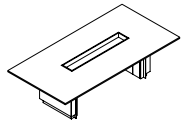
COLLECTIVE CONFERENCE

Description	① Model	D	L	H	Seat Capacity	Top Pieces	Bases Required	CTN WT	CU FT	Veneer	Glass Top
Rectangular Table with Panel Base and Center Console	CC8JRPM-48120	48	120	29	6	2	2	376	24	\$15,398	\$23,596



- short grain veneer direction
- base CC8NPC2-2784
- plinth base
- top is 1 1/4" thick and in two sections
- anodized aluminum center console 72" long
- laminate worksurface, no charge if standard laminate is selected
- base front arc panel, add \$692 to list, arc is only outside bases
- glass worksurface with reverse bevel edge, (see page [CC4](#))
- aluminum edge available, specify and add \$4,313 list

Rectangular Table with Panel Base and Center Console	CC8JRPM-4896	48	96	29	6	1	2	334	21	\$12,464	\$19,022
--	---------------------	----	----	----	---	---	---	-----	----	----------	----------



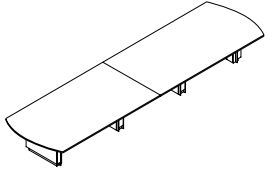
- long grain veneer direction
- base CC8NPC2-2760
- plinth base
- top is 1 1/4" thick
- anodized aluminum center console 48" long
- laminate worksurface, no charge if standard laminate is selected
- base front arc panel, add \$692 to list, arc is only outside bases
- glass worksurface with reverse bevel edge, (see page [CC4](#))
- aluminum edge available, specify and add \$3,699 list

To Order, Specify:

- ① Model Number
- ② Wood Species
- ③ Finish Scheme
 - A. Accent Surround - Veneer or Paint
 - B. Base Pedestal - Veneer or Paint
 (see page [CC8](#) - apron follows base pedestal)
- ④ Edge Detail
 - A. Straight
 - B. Aluminum Trim
- ⑤ Worksurface Option
 - A. Veneer
 - B. Laminate
 - C. Glossy Low Iron White Back Painted Glass
 - D. Frosted Low Iron White Back Painted Glass
 (see page [CC4](#))
- ⑥ Power and Data Options (see [accessories price list](#))
- ⑦ Other Product Options
- ⑧ Center Console Accessories (see pages [CC86-CC87](#) - order separately)

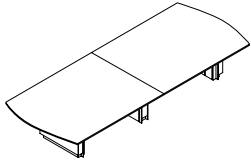
Description	Model	D	L	H	Seat Capacity	Top Pieces	Bases Required	CTN WT	CU FT	Veneer	Glass Top
-------------	-------	---	---	---	---------------	------------	----------------	--------	-------	--------	-----------

Arc End Table with Panel Base	CC8JAP2-60216	60	216	29	16	2	4	813	47	\$34,859	\$54,473
-------------------------------	----------------------	----	-----	----	----	---	---	-----	----	----------	----------



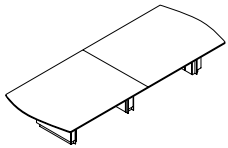
- short grain veneer direction
- base CC8NPC2-32174
- plinth base
- top is 1 ¼" thick and in two sections
- laminate worksurface, no charge if standard laminate is selected
- base front arc panel, add \$692 to list, arc is only outside bases
- glass worksurface with reverse bevel edge, (see page [CC4](#))

Arc End Table with Panel Base	CC8JAP2-60192	60	192	29	14	2	3	682	39	\$27,219	\$44,914
-------------------------------	----------------------	----	-----	----	----	---	---	-----	----	----------	----------



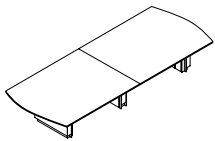
- short grain veneer direction
- base CC8NPC2-32156
- plinth base
- top is 1 ¼" thick and in two sections
- laminate worksurface, no charge if standard laminate is selected
- base front arc panel, add \$692 to list, arc is only outside bases
- glass worksurface with reverse bevel edge, (see page [CC4](#))

Arc End Table with Panel Base	CC8JAP2-60168	60	168	29	14	2	3	630	36	\$24,404	\$39,659
-------------------------------	----------------------	----	-----	----	----	---	---	-----	----	----------	----------



- short grain veneer direction
- base CC8NPC2-32132
- plinth base
- top is 1 ¼" thick and in two sections
- laminate worksurface, no charge if standard laminate is selected
- base front arc panel, add \$692 to list, arc is only outside bases
- glass worksurface with reverse bevel edge, (see page [CC4](#))

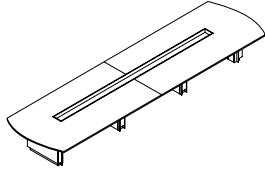
Arc End Table with Panel Base	CC8JAP2-60144	60	144	29	12	2	3	578	33	\$22,144	\$35,220
-------------------------------	----------------------	----	-----	----	----	---	---	-----	----	----------	----------



- short grain veneer direction
- base CC8NPC2-32108
- plinth base
- top is 1 ¼" thick and in two sections
- laminate worksurface, no charge if standard laminate is selected
- base front arc panel, add \$692 to list, arc is only outside bases
- glass worksurface with reverse bevel edge, (see page [CC4](#))

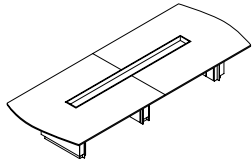
Description	① Model	D	L	H	Seat Capacity	Top Pieces	Bases Required	CTN WT	CU FT	Veneer	Glass Top
Arc End Table with Panel Base and Center Console	CC8JAPM-60216	60	216	29	18	2	4	814	55	\$42,628	\$62,246

- short grain veneer direction
- base CC8NPC2-32174
- plinth base
- top is 1 1/4" thick and in two sections
- anodized aluminum center console 160" long
- laminate worksurface, no charge if standard laminate is selected
- base front arc panel, add \$692 to list, arc is only outside bases
- glass worksurface with reverse bevel edge, (see page [CC4](#))



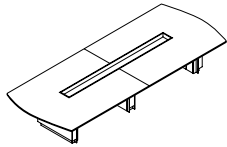
Arc End Table with Panel Base and Center Console	CC8JAPM-60192	60	192	29	16	2	3	682	46	\$33,930	\$51,365
--	----------------------	----	-----	----	----	---	---	-----	----	----------	----------

- short grain veneer direction
- base CC8NPC2-32156
- plinth base
- top is 1 1/4" thick and in two sections
- anodized aluminum center console 144" long
- laminate worksurface, no charge if standard laminate is selected
- base front arc panel, add \$692 to list, arc is only outside bases
- glass worksurface with reverse bevel edge, (see page [CC4](#))



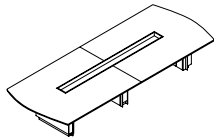
Arc End Table with Panel Base and Center Console	CC8JAPM-60168	60	168	29	14	2	3	631	42	\$30,058	\$45,315
--	----------------------	----	-----	----	----	---	---	-----	----	----------	----------

- short grain veneer direction
- base CC8NPC2-32132
- plinth base
- top is 1 1/4" thick and in two sections
- anodized aluminum center console 120" long
- laminate worksurface, no charge if standard laminate is selected
- base front arc panel, add \$692 to list, arc is only outside bases
- glass worksurface with reverse bevel edge, (see page [CC4](#))



Arc End Table with Panel Base and Center Console	CC8JAPM-60144	60	144	29	10	2	3	578	39	\$26,733	\$39,809
--	----------------------	----	-----	----	----	---	---	-----	----	----------	----------

- short grain veneer direction
- base CC8NPC2-32108
- plinth base
- top is 1 1/4" thick and in two sections
- anodized aluminum center console 96" long
- laminate worksurface, no charge if standard laminate is selected
- base front arc panel, add \$692 to list, arc is only outside bases
- glass worksurface with reverse bevel edge, (see page [CC4](#))



To Order, Specify:

Arc End Table

- ① Model Number
- ② Wood Species
- ③ Finish Scheme
 - A. Accent Surround - Veneer or Paint
 - B. Base Pedestal - Veneer or Paint
(see page [CC8](#) - apron follows base pedestal)
- ④ Worksurface Option
 - A. Veneer
 - B. Laminate
 - C. Glossy Low Iron White Back Painted Glass
 - D. Frosted Low Iron White Back Painted Glass
(see page [CC4](#))
- ⑤ Power and Data Options (see [accessories price list](#))
- ⑥ Other Product Options

Arc End Table with Center Console

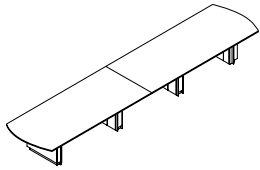
- ① Model Number
- ② Wood Species
- ③ Finish Scheme
 - A. Accent Surround - Veneer or Paint
 - B. Base Pedestal - Veneer or Paint
(see page [CC8](#) - apron follows base pedestal)
- ④ Worksurface Option
 - A. Veneer
 - B. Laminate
 - C. Glossy Low Iron White Back Painted Glass
 - D. Frosted Low Iron White Back Painted Glass
(see page [CC4](#))
- ⑤ Power and Data Options (see [accessories price list](#))
- ⑥ Other Product Options
- ⑦ Center Console Accessories (see pages [CC86-CC87](#) - order separately)

Collective Conference



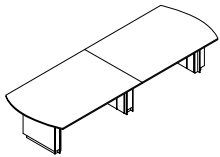
Description	Model	D	L	H	Seat Capacity	Top Pieces	Bases Required	CTN WT	CU FT	Veneer	Glass Top
-------------	-------	---	---	---	---------------	------------	----------------	--------	-------	--------	-----------

Arc End Table with Panel Base	CC8JAP2-48216	48	216	29	16	2	4	702	38	\$29,523	\$45,218
-------------------------------	----------------------	----	-----	----	----	---	---	-----	----	----------	----------



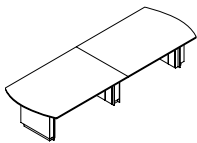
- short grain veneer direction
- base CC8NPC2-27174
- plinth base
- top is 1 ¼" thick and in two sections
- laminate worksurface, no charge if standard laminate is selected
- base front arc panel, add \$692 to list, arc is only outside bases
- glass worksurface with reverse bevel edge, (see page [CC4](#))

Arc End Table with Panel Base	CC8JAP2-48192	48	192	29	16	2	3	581	32	\$22,762	\$36,713
-------------------------------	----------------------	----	-----	----	----	---	---	-----	----	----------	----------



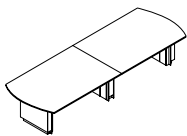
- short grain veneer direction
- base CC8NPC2-27156
- plinth base
- top is 1 ¼" thick and in two sections
- laminate worksurface, no charge if standard laminate is selected
- base front arc panel, add \$692 to list, arc is only outside bases
- glass worksurface with reverse bevel edge, (see page [CC4](#))

Arc End Table with Panel Base	CC8JAP2-48168	48	168	29	14	2	3	538	29	\$20,477	\$32,683
-------------------------------	----------------------	----	-----	----	----	---	---	-----	----	----------	----------



- short grain veneer direction
- base CC8NPC2-27132
- plinth base
- top is 1 ¼" thick and in two sections
- laminate worksurface, no charge if standard laminate is selected
- base front arc panel, add \$692 to list, arc is only outside bases
- glass worksurface with reverse bevel edge, (see page [CC4](#))

Arc End Table with Panel Base	CC8JAP2-48144	48	144	29	10	2	3	497	27	\$18,708	\$29,172
-------------------------------	----------------------	----	-----	----	----	---	---	-----	----	----------	----------

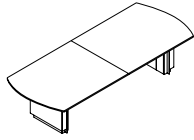


- short grain veneer direction
- base CC8NPC2-27108
- plinth base
- top is 1 ¼" thick and in two sections
- laminate worksurface, no charge if standard laminate is selected
- base front arc panel, add \$692 to list, arc is only outside bases
- glass worksurface with reverse bevel edge, (see page [CC4](#))

COLLECTIVE CONFERENCE

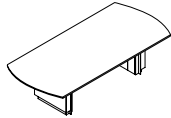
Description	① Model	D	L	H	Seat Capacity	Top Pieces	Bases Required	CTN WT	CU FT	Veneer	Glass Top
-------------	---------	---	---	---	---------------	------------	----------------	--------	-------	--------	-----------

Arc End Table with Panel Base	CC8JAP2-48120	48	120	29	6	2	2	375	20	\$12,241	\$20,441
-------------------------------	----------------------	----	-----	----	---	---	---	-----	----	----------	----------



- short grain veneer direction
- base CC8NPC2-2784
- plinth base
- top is 1 1/4" thick and in two sections
- laminate worksurface, no charge if standard laminate is selected
- base front arc panel, add \$692 to list, arc is only outside bases
- glass worksurface with reverse bevel edge, (see page [CC4](#))

Arc End Table with Panel Base	CC8JAP2-4896	48	96	29	6	1	2	334	18	\$10,261	\$16,820
-------------------------------	---------------------	----	----	----	---	---	---	-----	----	----------	----------



- long grain veneer direction
- base CC8NPC2-2760
- plinth base
- top is 1 1/4" thick
- laminate worksurface, no charge if standard laminate is selected
- base front arc panel, add \$692 to list, arc is only outside bases
- glass worksurface with reverse bevel edge, (see page [CC4](#))

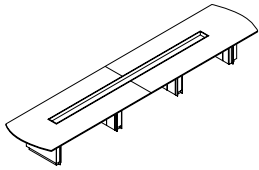
To Order, Specify

- ① Model Number
- ② Wood Species
- ③ Finish Scheme
 - A. Accent Surround - Veneer or Paint
 - B. Base Pedestal - Veneer or Paint
(see page [CC8](#) - apron follows base pedestal)
- ④ Worksurface Option
 - A. Veneer
 - B. Laminate
 - C. Glossy Low Iron White Back Painted Glass
 - D. Frosted Low Iron White Back Painted Glass
(see page [CC4](#))
- ⑤ Power and Data Options (see [accessories price list](#))
- ⑥ Other Product Options

Collective Conference

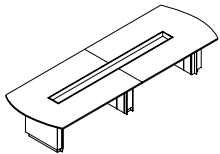


Description	Model	D	L	H	Seat Capacity	Top Pieces	Bases Required	CTN WT	CU FT	Veneer	Glass Top
Arc End Table with Panel Base and Center Console	CC8JAPM-48216	48	216	29	16	2	4	702	44	\$37,293	\$52,988



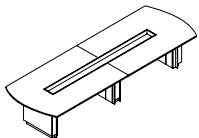
- short grain veneer direction
- base CC8NPC2-27174
- plinth base
- top is 1 1/4" thick and in two sections
- anodized aluminum center console 160" long
- laminate worksurface, no charge if standard laminate is selected
- base front arc panel, add \$692 to list, arc is only outside bases
- glass worksurface with reverse bevel edge, (see page [CC4](#))

Arc End Table with Panel Base and Center Console	CC8JAPM-48192	48	192	29	16	2	3	581	37	\$29,475	\$43,426
--	----------------------	----	-----	----	----	---	---	-----	----	----------	----------



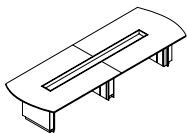
- short grain veneer direction
- base CC8NPC2-27156
- plinth base
- top is 1 1/4" thick and in two sections
- anodized aluminum center console 144" long
- laminate worksurface, no charge if standard laminate is selected
- base front arc panel, add \$692 to list, arc is only outside bases
- glass worksurface with reverse bevel edge, (see page [CC4](#))

Arc End Table with Panel Base and Center Console	CC8JAPM-48168	48	168	29	14	2	3	539	34	\$26,128	\$38,334
--	----------------------	----	-----	----	----	---	---	-----	----	----------	----------



- short grain veneer direction
- base CC8NPC2-27132
- plinth base
- top is 1 1/4" thick and in two sections
- anodized aluminum center console 120" long
- laminate worksurface, no charge if standard laminate is selected
- base front arc panel, add \$692 to list, arc is only outside bases
- glass worksurface with reverse bevel edge, (see page [CC4](#))

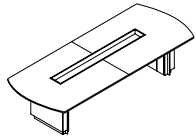
Arc End Table with Panel Base and Center Console	CC8JAPM-48144	48	144	29	10	2	3	497	31	\$23,300	\$33,761
--	----------------------	----	-----	----	----	---	---	-----	----	----------	----------



- short grain veneer direction
- base CC8NPC2-27108
- plinth base
- top is 1 1/4" thick and in two sections
- anodized aluminum center console 96" long
- laminate worksurface, no charge if standard laminate is selected
- base front arc panel, add \$692 to list, arc is only outside bases
- glass worksurface with reverse bevel edge, (see page [CC4](#))

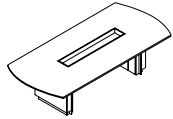
COLLECTIVE CONFERENCE

Description	① Model	D	L	H	Seat Capacity	Top Pieces	Bases Required	CTN WT	CU FT	Veneer	Glass Top
Arc End Table with Panel Base and Center Console	CC8JAPM-48120	48	120	29	6	2	2	376	24	\$15,774	\$23,972



- short grain veneer direction
- base CC8NPC2-2784
- plinth base
- top is 1 1/4" thick and in two sections
- anodized aluminum center console 72" long
- laminate worksurface, no charge if standard laminate is selected
- base front arc panel, add \$692 to list, arc is only outside bases
- glass worksurface with reverse bevel edge, (see page [CC4](#))

Arc End Table with Panel Base and Center Console	CC8JAPM-4896	48	96	29	6	1	2	334	21	\$12,732	\$19,292
--	---------------------	----	----	----	---	---	---	-----	----	----------	----------

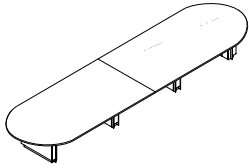


- long grain veneer direction
- base CC8NPC2-2760
- plinth base
- top is 1 1/4" thick
- anodized aluminum center console 48" long
- laminate worksurface, no charge if standard laminate is selected
- base front arc panel, add \$692 to list, arc is only outside bases
- glass worksurface with reverse bevel edge, (see page [CC4](#))

To Order, Specify

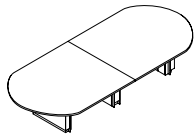
- ① Model Number
- ② Wood Species
- ③ Finish Scheme
 - A. Accent Surround - veneer or paint
 - B. Base Pedestal - veneer or paint
(see page [CC8](#) - apron follows base pedestal)
- ④ Worksurface Option
 - A. Veneer
 - B. Laminate
 - C. Glossy Low Iron White Back Painted Glass
 - D. Frosted Low Iron White Back Painted Glass
(see page [CC4](#))
- ⑤ Power and Data Options (see [accessories price list](#))
- ⑥ Other Product Options
- ⑦ Center Console Accessories (see pages [CC86-CC87](#) - order separately)

Description	① Model	D	L	H	Seat Capacity	Top Pieces	Bases Required	CTN WT	CU FT	Veneer	Glass Top
Racetrack Table with Panel Base	CC8JOP2-60216	60	216	29	18	2	4	788	47	\$35,183	\$54,800



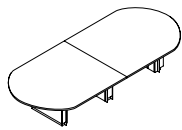
- short grain veneer direction
- base CC8NPC2-32174
- plinth base
- top is 1 1/4" thick and in two sections
- laminate worksurface, no charge if standard laminate is selected
- base front arc panel, add \$692 to list, arc is only outside bases
- glass worksurface with reverse bevel edge, (see page [CC4](#))

Racetrack Table with Panel Base	CC8JOP2-60192	60	192	29	14	2	3	657	39	\$27,499	\$44,933
---------------------------------	----------------------	----	-----	----	----	---	---	-----	----	----------	----------



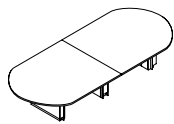
- short grain veneer direction
- base CC8NPC2-32156
- plinth base
- top is 1 1/4" thick and in two sections
- laminate worksurface, no charge if standard laminate is selected
- base front arc panel, add \$692 to list, arc is only outside bases
- glass worksurface with reverse bevel edge, (see page [CC4](#))

Racetrack Table with Panel Base	CC8JOP2-60168	60	168	29	12	2	3	605	36	\$24,646	\$39,904
---------------------------------	----------------------	----	-----	----	----	---	---	-----	----	----------	----------



- short grain veneer direction
- base CC8NPC2-32132
- plinth base
- top is 1 1/4" thick and in two sections
- laminate worksurface, no charge if standard laminate is selected
- base front arc panel, add \$692 to list, arc is only outside bases
- glass worksurface with reverse bevel edge, (see page [CC4](#))

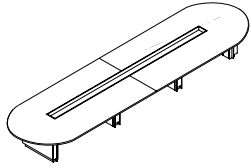
Racetrack Table with Panel Base	CC8JOP2-60144	60	144	29	8	2	3	553	33	\$22,340	\$20,566
---------------------------------	----------------------	----	-----	----	---	---	---	-----	----	----------	----------



- short grain veneer direction
- base CC8NPC2-32108
- plinth base
- top is 1 1/4" thick and in two sections
- laminate worksurface, no charge if standard laminate is selected
- base front arc panel, add \$692 to list, arc is only outside bases
- glass worksurface with reverse bevel edge, (see page [CC4](#))

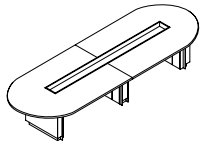
Description	Model	D	L	H	Seat Capacity	Top Pieces	Bases Required	CTN WT	CU FT	Veneer	Glass Top
Racetrack Table with Panel Base and Center Console	CC8JOPM-60216	60	216	29	18	2	4	789	55	\$42,952	\$62,569

- short grain veneer direction
- base CC8NPC2-32174
- plinth base
- top is 1 1/4" thick and in two sections
- anodized aluminum center console 160" long
- laminate worksurface, no charge if standard laminate is selected
- base front arc panel, add \$692 to list, arc is only outside bases
- glass worksurface with reverse bevel edge, (see page [CC4](#))



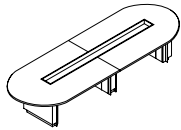
Racetrack Table with Panel Base and Center Console	CC8JOPM-60192	60	192	29	16	2	3	657	46	\$34,750	\$52,185
--	----------------------	----	-----	----	----	---	---	-----	----	----------	----------

- short grain veneer direction
- base CC8NPC2-32156
- plinth base
- top is 1 1/4" thick and in two sections
- anodized aluminum center console 144" long
- laminate worksurface, no charge if standard laminate is selected
- base front arc panel, add \$692 to list, arc is only outside bases
- glass worksurface with reverse bevel edge, (see page [CC4](#))



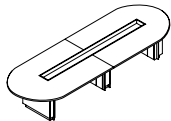
Racetrack Table with Panel Base and Center Console	CC8JOPM-60168	60	168	29	14	2	3	606	42	\$30,297	\$45,554
--	----------------------	----	-----	----	----	---	---	-----	----	----------	----------

- short grain veneer direction
- base CC8NPC2-32132
- plinth base
- top is 1 1/4" thick and in two sections
- anodized aluminum center console 120" long
- laminate worksurface, no charge if standard laminate is selected
- base front arc panel, add \$692 to list, arc is only outside bases
- glass worksurface with reverse bevel edge, (see page [CC4](#))



Racetrack Table with Panel Base and Center Console	CC8JOPM-60144	60	144	29	10	2	3	553	39	\$26,937	\$40,013
--	----------------------	----	-----	----	----	---	---	-----	----	----------	----------

- short grain veneer direction
- base CC8NPC2-32108
- plinth base
- top is 1 1/4" thick and in two sections
- anodized aluminum center console 96" long
- laminate worksurface, no charge if standard laminate is selected
- base front arc panel, add \$692 to list, arc is only outside bases
- glass worksurface with reverse bevel edge, (see page [CC4](#))



To Order, Specify:

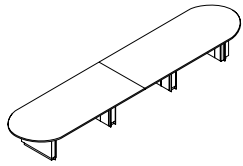
Racetrack Table

- 1 Model Number
- 2 Wood Species
- 3 Finish Scheme
 - A. Accent Surround - Veneer or Paint
 - B. Base Pedestal - Veneer or Paint
(see page [CC8](#) - apron follows base pedestal)
- 4 Worksurface Option
 - A. Veneer
 - B. Laminate
 - C. Glossy Low Iron White Back Painted Glass
 - D. Frosted Low Iron White Back Painted Glass
(see page [CC4](#))
- 5 Power and Data Options (see [accessories price list](#))
- 6 Other Product Options

Racetrack Table with Center Console

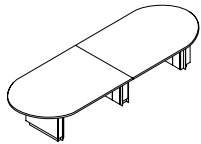
- 1 Model Number
- 2 Wood Species
- 3 Finish Scheme
 - A. Accent Surround - Veneer or Paint
 - B. Base Pedestal - Veneer or Paint
(see page [CC8](#) - apron follows base pedestal)
- 4 Worksurface Option
 - A. Veneer
 - B. Laminate
 - C. Glossy Low Iron White Back Painted Glass
 - D. Frosted Low Iron White Back Painted Glass
(see page [CC4](#))
- 5 Power and Data Options (see [accessories price list](#))
- 6 Other Product Options
- 7 Center Console Accessories (see pages [CC86-CC87](#) - order separately)

Description	① Model	D	L	H	Seat Capacity	Top Pieces	Bases Required	CTN WT	CU FT	Veneer	Glass Top
Racetrack Table with Panel Base	CC8JOP2-48216	48	216	29	16	2	4	694	38	\$29,772	\$45,465



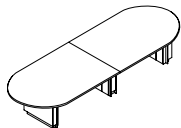
- short grain veneer direction
- base CC8NPC2-27174
- plinth base
- top is 1 1/4" thick and in two sections
- laminate worksurface, no charge if standard laminate is selected
- base front arc panel, add \$692 to list, arc is only outside bases
- glass worksurface with reverse bevel edge, (see page [CC4](#))

Racetrack Table with Panel Base	CC8JOP2-48192	48	192	29	14	2	3	565	32	\$28,037	\$41,986
---------------------------------	----------------------	----	-----	----	----	---	---	-----	----	----------	----------



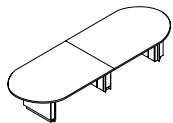
- short grain veneer direction
- base CC8NPC2-27156
- plinth base
- top is 1 1/4" thick and in two sections
- laminate worksurface, no charge if standard laminate is selected
- base front arc panel, add \$692 to list, arc is only outside bases
- glass worksurface with reverse bevel edge, (see page [CC4](#))

Racetrack Table with Panel Base	CC8JOP2-48168	48	168	29	12	2	3	531	29	\$20,663	\$32,869
---------------------------------	----------------------	----	-----	----	----	---	---	-----	----	----------	----------



- short grain veneer direction
- base CC8NPC2-27132
- plinth base
- top is 1 1/4" thick and in two sections
- laminate worksurface, no charge if standard laminate is selected
- base front arc panel, add \$692 to list, arc is only outside bases
- glass worksurface with reverse bevel edge, (see page [CC4](#))

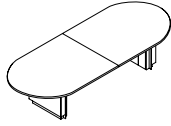
Racetrack Table with Panel Base	CC8JOP2-48144	48	144	29	8	2	3	481	27	\$18,863	\$29,324
---------------------------------	----------------------	----	-----	----	---	---	---	-----	----	----------	----------



- short grain veneer direction
- base CC8NPC2-27108
- plinth base
- top is 1 1/4" thick and in two sections
- laminate worksurface, no charge if standard laminate is selected
- base front arc panel, add \$692 to list, arc is only outside bases
- glass worksurface with reverse bevel edge, (see page [CC4](#))

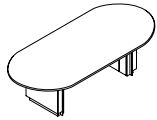
Description	① Model	D	L	H	Seat Capacity	Top Pieces	Bases Required	CTN WT	CU FT	Veneer	Glass Top
Racetrack Table with Panel Base	CC8JOP2-48120	48	120	29	6	2	2	359	20	\$12,367	\$20,566

- short grain veneer direction
- base CC8NPC2-2784
- plinth base
- top is 1 ¼" thick and in two sections
- laminate worksurface, no charge if standard laminate is selected
- base front arc panel, add \$692 to list, arc is only outside bases
- glass worksurface with reverse bevel edge, (see page [CC4](#))



Racetrack Table with Panel Base	CC8JOP2-4896	48	96	29	6	1	2	309	18	\$10,353	\$16,914
---------------------------------	---------------------	----	----	----	---	---	---	-----	----	----------	----------

- long grain veneer direction
- base CC8NPC2-2760
- plinth base
- top is 1 ¼" thick
- laminate worksurface, no charge if standard laminate is selected
- base front arc panel, add \$692 to list, arc is only outside bases
- glass worksurface with reverse bevel edge, (see page [CC4](#))

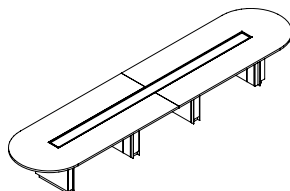


To Order, Specify:

- ① Model Number
- ② Wood Species
- ③ Finish Scheme
 - A. Accent Surround - Veneer or Paint
 - B. Base Pedestal - Veneer or Paint
(see page [CC8](#) - apron follows base pedestal)
- ④ Worksurface Option
 - A. Veneer
 - B. Laminate
 - C. Glossy Low Iron White Back Painted Glass
 - D. Frosted Low Iron White Back Painted Glass
(see page [CC4](#))
- ⑤ Power and Data Options (see [accessories price list](#))
- ⑥ Other Product Options

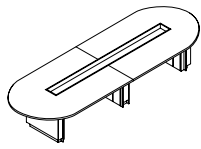
Description	① Model	D	L	H	Seat Capacity	Top Pieces	Bases Required	CTN WT	CU FT	Veneer	Glass Top
-------------	---------	---	---	---	---------------	------------	----------------	--------	-------	--------	-----------

Racetrack Table with Panel Base and Center Console	CC8JOPM-48216	48	216	29	16	2	4	694	44	\$37,544	\$53,235
--	----------------------	----	-----	----	----	---	---	-----	----	----------	----------



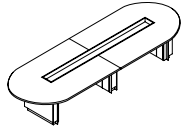
- short grain veneer direction
- base CC8NPC2-27174
- plinth base
- top is 1 1/4" thick and in two sections
- anodized aluminum center console 160" long
- laminate worksurface, no charge if standard laminate is selected
- base front arc panel, add \$692 to list, arc is only outside bases
- glass worksurface with reverse bevel edge, (see page [CC4](#))

Racetrack Table with Panel Base and Center Console	CC8JOPM-48192	48	192	29	14	2	3	566	37	\$29,692	\$43,641
--	----------------------	----	-----	----	----	---	---	-----	----	----------	----------



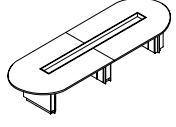
- short grain veneer direction
- base CC8NPC2-27156
- plinth base
- top is 1 1/4" thick and in two sections
- anodized aluminum center console 144" long
- laminate worksurface, no charge if standard laminate is selected
- base front arc panel, add \$692 to list, arc is only outside bases
- glass worksurface with reverse bevel edge, (see page [CC4](#))

Racetrack Table with Panel Base and Center Console	CC8JOPM-48168	48	168	29	12	2	3	531	34	\$26,316	\$38,522
--	----------------------	----	-----	----	----	---	---	-----	----	----------	----------



- short grain veneer direction
- base CC8NPC2-27132
- plinth base
- top is 1 1/4" thick and in two sections
- anodized aluminum center console 120" long
- laminate worksurface, no charge if standard laminate is selected
- base front arc panel, add \$692 to list, arc is only outside bases
- glass worksurface with reverse bevel edge, (see page [CC4](#))

Racetrack Table with Panel Base and Center Console	CC8JOPM-48144	48	144	29	8	2	3	482	31	\$23,456	\$33,918
--	----------------------	----	-----	----	---	---	---	-----	----	----------	----------

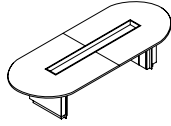


- short grain veneer direction
- base CC8NPC2-27108
- plinth base
- top is 1 1/4" thick and in two sections
- anodized aluminum center console 96" long
- laminate worksurface, no charge if standard laminate is selected
- base front arc panel, add \$692 to list, arc is only outside bases
- glass worksurface with reverse bevel edge, (see page [CC4](#))

COLLECTIVE CONFERENCE

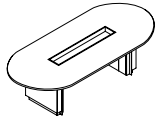
Description	① Model	D	L	H	Seat Capacity	Top Pieces	Bases Required	CTN WT	CU FT	Veneer	Glass Top
Racetrack Table with Panel Base and Center Console	CC8JOPM-48120	48	120	29	6	2	2	360	24	\$15,899	\$24,098

- short grain veneer direction
- base CC8NPC2-2784
- plinth base
- top is 1 1/4" thick and in two sections
- anodized aluminum center console 72" long
- laminate worksurface, no charge if standard laminate is selected
- base front arc panel, add \$692 to list, arc is only outside bases
- glass worksurface with reverse bevel edge, (see page [CC4](#))



Racetrack Table with Panel Base and Center Console	CC8JOPM-4896	48	96	29	6	1	2	310	21	\$12,824	\$19,383
--	---------------------	----	----	----	---	---	---	-----	----	----------	----------

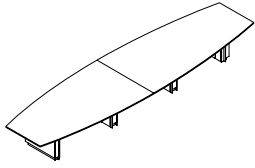
- long grain veneer direction
- base CC8NPC2-2760
- plinth base
- top is 1 1/4" thick
- anodized aluminum center console 48" long
- laminate worksurface, no charge if standard laminate is selected
- base front arc panel, add \$692 to list, arc is only outside bases
- glass worksurface with reverse bevel edge, (see page [CC4](#))



To Order, Specify:

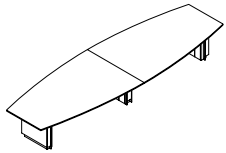
- ① Model Number
- ② Wood Species
- ③ Finish Scheme
 - A. Accent Surround - Veneer or Paint
 - B. Base Pedestal - Veneer or Paint
 (see page [CC8](#) - apron follows base pedestal)
- ④ Worksurface Option
 - A. Veneer
 - B. Laminate
 - C. Glossy Low Iron White Back Painted Glass
 - D. Frosted Low Iron White Back Painted Glass
 (see page [CC4](#))
- ⑤ Power and Data Options (see [accessories price list](#))
- ⑥ Other Product Options
- ⑦ Center Console Accessories (see pages [CC86-CC87](#) - order separately)

Description	① Model	D	L	H	Seat Capacity	Top Pieces	Bases Required	CTN WT	CU FT	Veneer	Glass Top
Boat Shape Table with Panel Base	CC8JBP2-60216	60	216	29	16	2	4	736	47	\$33,986	\$53,601



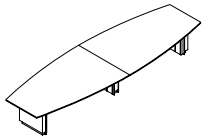
- short grain veneer direction
- base CC8NPC2-32174
- plinth base
- top is 1 ¼" thick and in two sections
- laminate worksurface, no charge if standard laminate is selected
- base front arc panel, add \$692 to list, arc is only outside bases
- glass worksurface with reverse bevel edge, (see page [CC4](#))

Boat Shape Table with Panel Base	CC8JBP2-60192	60	192	29	14	2	3	613	39	\$26,591	\$44,026
----------------------------------	----------------------	----	-----	----	----	---	---	-----	----	----------	----------



- short grain veneer direction
- base CC8NPC2-32156
- plinth base
- top is 1 ¼" thick and in two sections
- laminate worksurface, no charge if standard laminate is selected
- base front arc panel, add \$692 to list, arc is only outside bases
- glass worksurface with reverse bevel edge, (see page [CC4](#))

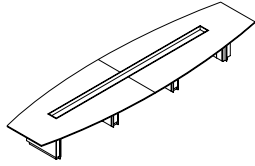
Boat Shape Table with Panel Base	CC8JBP2-60168	60	168	29	12	2	3	570	36	\$23,908	\$39,164
----------------------------------	----------------------	----	-----	----	----	---	---	-----	----	----------	----------



- short grain veneer direction
- base CC8NPC2-32132
- plinth base
- top is 1 ¼" thick and in two sections
- laminate worksurface, no charge if standard laminate is selected
- base front arc panel, add \$692 to list, arc is only outside bases
- glass worksurface with reverse bevel edge, (see page [CC4](#))

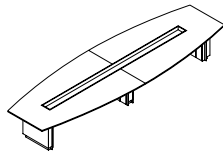
Description	① Model	D	L	H	Seat Capacity	Top Pieces	Bases Required	CTN WT	CU FT	Veneer	Glass Top
Boat Shape Table with Panel Base and Center Console	CC8JBPM-60216	60	216	29	16	2	4	737	55	\$41,760	\$61,376

- short grain veneer direction
- base CC8NPC2-32174
- plinth base
- top is 1 1/4" thick and in two sections
- anodized aluminum center console 160" long
- laminate worksurface, no charge if standard laminate is selected
- base front arc panel, add \$692 to list, arc is only outside bases
- glass worksurface with reverse bevel edge, (see page [CC4](#))



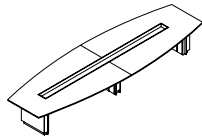
Boat Shape Table with Panel Base and Center Console	CC8JBPM-60192	60	192	29	14	2	3	613	46	\$33,301	\$50,735
---	----------------------	----	-----	----	----	---	---	-----	----	----------	----------

- short grain veneer direction
- base CC8NPC2-32156
- plinth base
- top is 1 1/4" thick and in two sections
- anodized aluminum center console 144" long
- laminate worksurface, no charge if standard laminate is selected
- base front arc panel, add \$692 to list, arc is only outside bases
- glass worksurface with reverse bevel edge, (see page [CC4](#))



Boat Shape Table with Panel Base and Center Console	CC8JBPM-60168	60	168	29	12	2	3	571	42	\$29,562	\$44,821
---	----------------------	----	-----	----	----	---	---	-----	----	----------	----------

- short grain veneer direction
- base CC8NPC2-32132
- plinth base
- top is 1 1/4" thick and in two sections
- anodized aluminum center console 120" long
- laminate worksurface, no charge if standard laminate is selected
- base front arc panel, add \$692 to list, arc is only outside bases
- glass worksurface with reverse bevel edge, (see page [CC4](#))



To Order, Specify:

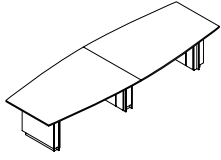
Boat Shape Table

- ① Model Number
- ② Wood Species
- ③ Finish Scheme
 - A. Accent Surround - Veneer or Paint
 - B. Base Pedestal - Veneer or Paint
(see page [CC8](#) - apron follows base pedestal)
- ④ Worksurface Option
 - A. Veneer
 - B. Laminate
 - C. Glossy Low Iron White Back Painted Glass
 - D. Frosted Low Iron White Back Painted Glass
(see page [CC4](#))
- ⑤ Power and Data Options (see [accessories price list](#))
- ⑥ Other Product Options

Boat Shape Table with Center Console

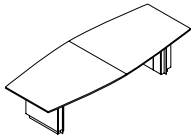
- ① Model Number
- ② Wood Species
- ③ Finish Scheme
 - A. Accent Surround - Veneer or Paint
 - B. Base Pedestal - Veneer or Paint
(see page [CC8](#) - apron follows base pedestal)
- ④ Worksurface Option
 - A. Veneer
 - B. Laminate
 - C. Glossy Low Iron White Back Painted Glass
 - D. Frosted Low Iron White Back Painted Glass
(see page [CC4](#))
- ⑤ Power and Data Options (see [accessories price list](#))
- ⑥ Other Product Options
- ⑦ Center Console Accessories (see pages [CC86-CC87](#) - order separately)

Description	① Model	D	L	H	Seat Capacity	Top Pieces	Bases Required	CTN WT	CU FT	Veneer	Glass Top
Boat Shape Table with Panel Base	CC8JBP2-48144	48	144	29	8	2	3	469	27	\$21,762	\$32,222



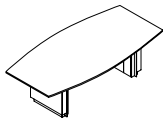
- short grain veneer direction
- base CC8NPC2-27108
- plinth base
- top is 1 ¼" thick and in two sections
- laminate worksurface, no charge if standard laminate is selected
- base front arc panel, add \$692 to list, arc is only outside bases
- glass worksurface with reverse bevel edge, (see page [CC4](#))

Boat Shape Table with Panel Base	CC8JBP2-48120	48	120	29	6	2	2	352	20	\$13,910	\$22,108
----------------------------------	----------------------	----	-----	----	---	---	---	-----	----	----------	----------



- short grain veneer direction
- base CC8NPC2-2784
- plinth base
- top is 1 ¼" thick and in two sections
- laminate worksurface, no charge if standard laminate is selected
- base front arc panel, add \$692 to list, arc is only outside bases
- glass worksurface with reverse bevel edge, (see page [CC4](#))

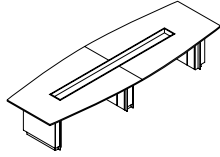
Boat Shape Table with Panel Base	CC8JBP2-4896	48	96	29	6	1	2	315	18	\$11,510	\$18,070
----------------------------------	---------------------	----	----	----	---	---	---	-----	----	----------	----------



- long grain veneer direction
- base CC8NPC2-2760
- plinth base
- top is 1 ¼" thick
- laminate worksurface, no charge if standard laminate is selected
- base front arc panel, add \$692 to list, arc is only outside bases
- glass worksurface with reverse bevel edge, (see page [CC4](#))

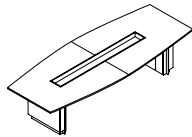
Description	① Model	D	L	H	Seat Capacity	Top Pieces	Bases Required	CTN WT	CU FT	Veneer	Glass Top
Boat Shape Table with Panel Base and Center Console	CC8JBPM-48144	48	144	29	8	2	3	470	31	\$26,353	\$36,816

- short grain veneer direction
- base CC8NPC2-27108
- plinth base
- top is 1 1/4" thick and in two sections
- anodized aluminum center console 96" long
- laminate worksurface, no charge if standard laminate is selected
- base front arc panel, add \$692 to list, arc is only outside bases
- glass worksurface with reverse bevel edge, (see page [CC4](#))



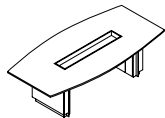
Boat Shape Table with Panel Base and Center Console	CC8JBPM-48120	48	120	29	6	2	2	353	24	\$17,442	\$25,638
---	----------------------	----	-----	----	---	---	---	-----	----	----------	----------

- short grain veneer direction
- base CC8NPC2-2784
- plinth base
- top is 1 1/4" thick and in two sections
- anodized aluminum center console 72" long
- laminate worksurface, no charge if standard laminate is selected
- base front arc panel, add \$692 to list, arc is only outside bases
- glass worksurface with reverse bevel edge, (see page [CC4](#))



Boat Shape Table with Panel Base and Center Console	CC8JBPM-4896	48	96	29	6	1	2	316	21	\$13,979	\$20,540
---	---------------------	----	----	----	---	---	---	-----	----	----------	----------

- long grain veneer direction
- base CC8NPC2-2760
- plinth base
- top is 1 1/4" thick
- anodized aluminum center console 48" long
- laminate worksurface, no charge if standard laminate is selected
- base front arc panel, add \$692 to list, arc is only outside bases
- glass worksurface with reverse bevel edge, (see page [CC4](#))



To Order, Specify:

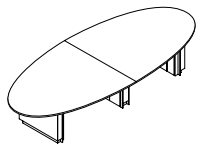
Boat Shape Table

- ① Model Number
- ② Wood Species
- ③ Finish Scheme
 - A. Accent Surround - Veneer or Paint
 - B. Base Pedestal - Veneer or Paint
(see page [CC8](#) - apron follows base pedestal)
- ④ Worksurface Option
 - A. Veneer
 - B. Laminate
 - C. Glossy Low Iron White Back Painted Glass
 - D. Frosted Low Iron White Back Painted Glass
(see page [CC4](#))
- ⑤ Power and Data Options (see [accessories price list](#))
- ⑥ Other Product Options

Boat Shape Table with Center Console

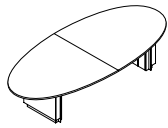
- ① Model Number
- ② Wood Species
- ③ Finish Scheme
 - A. Accent Surround - Veneer or Paint
 - B. Base Pedestal - Veneer or Paint
(see page [CC8](#) - apron follows base pedestal)
- ④ Worksurface Option
 - A. Veneer
 - B. Laminate
 - C. Glossy Low Iron White Back Painted Glass
 - D. Frosted Low Iron White Back Painted Glass
(see page [CC4](#))
- ⑤ Power and Data Options (see [accessories price list](#))
- ⑥ Other Product Options
- ⑦ Center Console Accessories (see pages [CC86-CC87](#) - order separately)

Description	① Model	D	L	H	Seat Capacity	Top Pieces	Bases Required	CTN WT	CU FT	Veneer	Glass Top
-------------	---------	---	---	---	---------------	------------	----------------	--------	-------	--------	-----------



- short grain veneer direction
- base CC8NPC2-32108
- plinth base
- top is 1 1/4" thick and in two sections
- laminate worksurface, no charge if standard laminate is selected
- base front arc panel, add \$692 to list, arc is only outside bases
- glass worksurface with reverse bevel edge, (see page [CC4](#))

Ellipse Table with Panel Base	CC8JEP2-54120	54	120	29	8	2	2	348	22	\$17,758	\$26,981
-------------------------------	----------------------	----	-----	----	---	---	---	-----	----	----------	----------



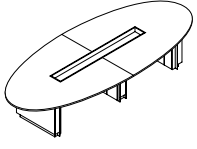
- short grain veneer direction
- base CC8NPC2-2784
- plinth base
- top is 1 1/4" thick and in two sections
- laminate worksurface, no charge if standard laminate is selected
- base front arc panel, add \$692 to list, arc is only outside bases
- glass worksurface with reverse bevel edge, (see page [CC4](#))

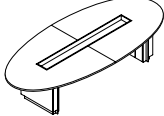
Ellipse Table with Panel Base	CC8JEP2-4896	48	96	29	6	1	2	297	18	\$12,046	\$18,605
-------------------------------	---------------------	----	----	----	---	---	---	-----	----	----------	----------

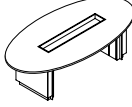


- long grain veneer direction
- base CC8NPC2-2760
- plinth base
- top is 1 1/4" thick
- laminate worksurface, no charge if standard laminate is selected
- base front arc panel, add \$692 to list, arc is only outside bases
- glass worksurface with reverse bevel edge, (see page [CC4](#))

COLLECTIVE CONFERENCE

Description	① Model	D	L	H	Seat Capacity	Top Pieces	Bases Required	CTN WT	CU FT	Veneer	Glass Top
Ellipse Table with Panel Base and Center Console 	CC8JEPM-60144	60	144	29	10	2	3	508	39	\$30,648	\$43,726
<ul style="list-style-type: none"> • short grain veneer direction • base CC8NPC2-32108 • plinth base • top is 1 ¼" thick and in two sections • anodized aluminum center console 96" long • laminate worksurface, no charge if standard laminate is selected • base front arc panel, add \$692 to list, arc is only outside bases • glass worksurface with reverse bevel edge, (see page CC4) 											

Ellipse Table with Panel Base and Center Console 	CC8JEPM-54120	54	120	29	8	2	2	349	26	\$21,289	\$30,510
<ul style="list-style-type: none"> • short grain veneer direction • base CC8NPC2-2784 • plinth base • top is 1 ¼" thick and in two sections • anodized aluminum center console 72" long • laminate worksurface, no charge if standard laminate is selected • base front arc panel, add \$692 to list, arc is only outside bases • glass worksurface with reverse bevel edge, (see page CC4) 											

Ellipse Table with Panel Base and Center Console 	CC8JEPM-4896	48	96	29	6	1	2	298	21	\$14,332	\$20,889
<ul style="list-style-type: none"> • long grain veneer direction • base CC8NPC2-2760 • plinth base • top is 1 ¼" thick • anodized aluminum center console 48" long • laminate worksurface, no charge if standard laminate is selected • base front arc panel, add \$692 to list, arc is only outside bases • glass worksurface with reverse bevel edge, (see page CC4) 											

To Order, Specify:

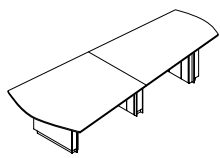
Ellipse Tables

- ① Model Number
- ② Wood Species
- ③ Finish Scheme
 - A. Accent Surround - Veneer or Paint
 - B. Base Pedestal - Veneer or Paint
(see page [CC8](#) - apron follows base pedestal)
- ④ Worksurface Option
 - A. Veneer
 - B. Laminate
 - C. Glossy Low Iron White Back Painted Glass
 - D. Frosted Low Iron White Back Painted Glass
(see page [CC4](#))
- ⑤ Power and Data Options (see [accessories price list](#))
- ⑥ Other Product Options

Ellipse Table with Center Console

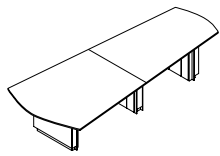
- ① Model Number
- ② Wood Species
- ③ Finish Scheme
 - A. Accent Surround - Veneer or Paint
 - B. Base Pedestal - Veneer or Paint
(see page [CC8](#) - apron follows base pedestal)
- ④ Worksurface Option
 - A. Veneer
 - B. Laminate
 - C. Glossy Low Iron White Back Painted Glass
 - D. Frosted Low Iron White Back Painted Glass
(see page [CC4](#))
- ⑤ Power and Data Options (see [accessories price list](#))
- ⑥ Other Product Options
- ⑦ Center Console Accessories (see pages [CC86-CC87](#) - order separately)

Description	① Model	D	L	H	Seat Capacity	Top Pieces	Bases Required	CTN WT	CU FT	Veneer	Glass Top
-------------	---------	---	---	---	---------------	------------	----------------	--------	-------	--------	-----------



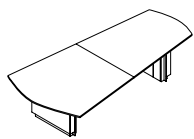
- short grain veneer direction
- base CC8NPC9-32168
- plinth base
- top is 1 1/4" thick and in two sections
- laminate worksurface, no charge if standard laminate is selected
- glass worksurface with reverse bevel edge, (see page [CC4](#))
- top size: 168"w x 40/60"d

View Table with Panel Base	CC8JVP2-60144	60	144	29	11	2	3	516	31	\$22,477	\$35,551
----------------------------	----------------------	----	-----	----	----	---	---	-----	----	----------	----------



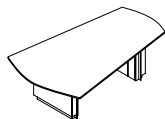
- short grain veneer direction
- base CC8NPC9-32144
- plinth base
- top is 1 1/4" thick and in two sections
- laminate worksurface, no charge if standard laminate is selected
- glass worksurface with reverse bevel edge, (see page [CC4](#))
- top size: 144"w x 40/60"d

View Table with Panel Base	CC8JVP2-60120	60	120	29	9	2	2	394	24	\$14,399	\$24,646
----------------------------	----------------------	----	-----	----	---	---	---	-----	----	----------	----------



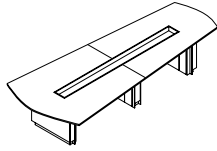
- short grain veneer direction
- base CC8NPC9-32120
- plinth base
- top is 1 1/4" thick and in two sections
- laminate worksurface, no charge if standard laminate is selected
- glass worksurface with reverse bevel edge, (see page [CC4](#))
- top size: 120"w x 40/60"d

View Table with Panel Base	CC8JVP2-6096	60	96	29	7	1	2	350	21	\$11,966	\$20,166
----------------------------	---------------------	----	----	----	---	---	---	-----	----	----------	----------



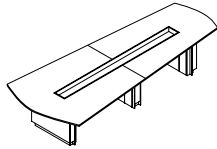
- long grain veneer direction
- base CC8NPC9-3296
- plinth base
- top is 1 1/4" thick
- laminate worksurface, no charge if standard laminate is selected
- glass worksurface with reverse bevel edge, (see page [CC4](#))
- top size: 96"w x 40/60"d

Description	① Model	D	L	H	Seat Capacity	Top Pieces	Bases Required	CTN WT	CU FT	Veneer	Glass Top
View Table with Panel Base and Center Console	CC8JVPM-60168	60	168	29	11	2	3	561	40	\$30,453	\$45,709



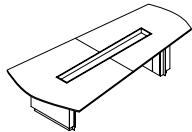
- short grain veneer direction
- base CC8NPC9-32168
- plinth base
- top is 1 1/4" thick and in two sections
- anodized aluminum center console 120" long
- laminate worksurface, no charge if standard laminate is selected
- glass worksurface with reverse bevel edge, (see page [CC4](#))
- top size: 168"w x 40/60"d

View Table with Panel Base and Center Console	CC8JVPM-60144	60	144	29	11	2	3	516	37	\$27,069	\$40,146
---	----------------------	----	-----	----	----	---	---	-----	----	----------	----------



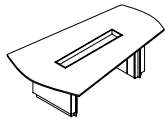
- short grain veneer direction
- base CC8NPC9-32144
- plinth base
- top is 1 1/4" thick and in two sections
- anodized aluminum center console 96" long
- laminate worksurface, no charge if standard laminate is selected
- glass worksurface with reverse bevel edge, (see page [CC4](#))
- top size: 144"w x 40/60"d

View Table with Panel Base and Center Console	CC8JVPM-60120	60	120	29	9	2	2	394	29	\$17,928	\$28,176
---	----------------------	----	-----	----	---	---	---	-----	----	----------	----------



- short grain veneer direction
- base CC8NPC9-32120
- plinth base
- top is 1 1/4" thick and in two sections
- anodized aluminum center console 72" long
- laminate worksurface, no charge if standard laminate is selected
- glass worksurface with reverse bevel edge, (see page [CC4](#))
- top size: 120"w x 40/60"d

View Table with Panel Base and Center Console	CC8JVPM-6096	60	96	29	7	1	2	350	25	\$14,441	\$22,638
---	---------------------	----	----	----	---	---	---	-----	----	----------	----------

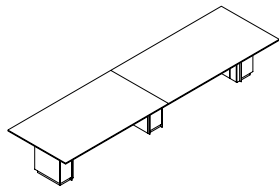


- long grain veneer direction
- base CC8NPC9-3296
- plinth base
- top is 1 1/4" thick
- anodized aluminum center console 48" long
- laminate worksurface, no charge if standard laminate is selected
- glass worksurface with reverse bevel edge, (see page [CC4](#))
- top size: 96"w x 40/60"d

To Order, Specify:

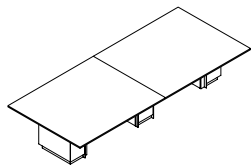
- ① Model Number
- ② Wood Species
- ③ Finish Scheme
 - A. Accent Surround - Veneer or Paint
 - B. Base Pedestal - Veneer or Paint
(see page [CC8](#) - apron follows base pedestal)
- ④ Worksurface Option
 - A. Veneer
 - B. Laminate
 - C. Glossy Low Iron White Back Painted Glass
 - D. Frosted Low Iron White Back Painted Glass
(see page [CC4](#))
- ⑤ Power and Data Options (see [accessories price list](#))
- ⑥ Other Product Options

Description	Model	D	L	H	Seat Capacity	Top Pieces	Bases Required	CTN WT	CU FT	Veneer	Glass Top
Rectangular Table with Rectangular Base	CC8JRR2-60216	60	216	29	18	2	3	787	42	\$37,137	\$56,753



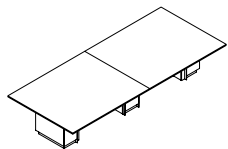
- short grain veneer direction
- base CC8NRC2-27174
- plinth base
- top is 1 1/4" thick and in two sections
- laminate worksurface, no charge if standard laminate is selected
- glass worksurface with reverse bevel edge, (see page [CC4](#))
- aluminum edge available, specify and add \$7,081 list

Rectangular Table with Rectangular Base	CC8JRR2-60192	60	192	29	16	2	3	737	39	\$28,814	\$46,249
---	----------------------	----	-----	----	----	---	---	-----	----	----------	----------



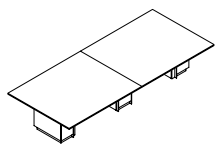
- short grain veneer direction
- base CC8NRC2-27156
- plinth base
- top is 1 1/4" thick and in two sections
- laminate worksurface, no charge if standard laminate is selected
- glass worksurface with reverse bevel edge, (see page [CC4](#))
- aluminum edge available, specify and add \$6,467 list

Rectangular Table with Rectangular Base	CC8JRR2-60168	60	168	29	14	2	3	683	36	\$26,122	\$41,378
---	----------------------	----	-----	----	----	---	---	-----	----	----------	----------



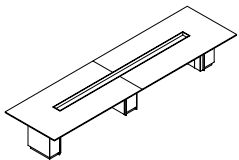
- short grain veneer direction
- base CC8NRC2-27132
- plinth base
- top is 1 1/4" thick and in two sections
- laminate worksurface, no charge if standard laminate is selected
- glass worksurface with reverse bevel edge, (see page [CC4](#))
- aluminum edge available, specify and add \$5,853 list

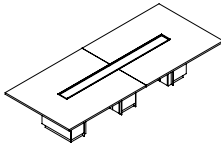
Rectangular Table with Rectangular Base	CC8JRR2-60144	60	144	29	10	2	3	632	33	\$23,977	\$37,055
---	----------------------	----	-----	----	----	---	---	-----	----	----------	----------

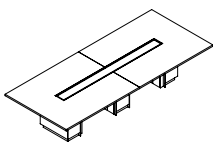


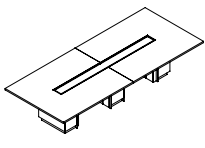
- short grain veneer direction
- base CC8NRC2-27108
- plinth base
- top is 1 1/4" thick and in two sections
- laminate worksurface, no charge if standard laminate is selected
- glass worksurface with reverse bevel edge, (see page [CC4](#))
- aluminum edge available, specify and add \$5,236 list

COLLECTIVE CONFERENCE

Description	Model	D	L	H	Seat Capacity	Top Pieces	Bases Required	CTN WT	CU FT	Veneer	Glass Top
Rectangular Table with Rectangular Base and Center Console 	CC8JRRM-60216	60	216	29	18	2	3	788	50	\$44,909	\$64,524
<ul style="list-style-type: none"> • short grain veneer direction • base CC8NRC2-27174 • plinth base • top is 1 1/4" thick and in two sections • anodized aluminum center console 160" long • laminate worksurface, no charge if standard laminate is selected • glass worksurface with reverse bevel edge, (see page CC4) • aluminum edge available, specify and add \$7,081 list 											

Rectangular Table with Rectangular Base and Center Console 	CC8JRRM-60192	60	192	29	16	2	3	737	46	\$35,524	\$52,959
<ul style="list-style-type: none"> • short grain veneer direction • base CC8NRC2-27156 • plinth base • top is 1 1/4" thick and in two sections • anodized aluminum center console 144" long • laminate worksurface, no charge if standard laminate is selected • glass worksurface with reverse bevel edge, (see page CC4) • aluminum edge available, specify and add \$6,467 list 											

Rectangular Table with Rectangular Base and Center Console 	CC8JRRM-60168	60	168	29	14	2	3	684	42	\$31,772	\$47,029
<ul style="list-style-type: none"> • short grain veneer direction • base CC8NRC2-27132 • plinth base • top is 1 1/4" thick and in two sections • anodized aluminum center console 120" long • laminate worksurface, no charge if standard laminate is selected • glass worksurface with reverse bevel edge, (see page CC4) • aluminum edge available, specify and add \$5,853 list 											

Rectangular Table with Rectangular Base and Center Console 	CC8JRRM-60144	60	144	29	10	2	3	632	39	\$28,568	\$41,645
<ul style="list-style-type: none"> • short grain veneer direction • base CC8NRC2-27108 • plinth base • top is 1 1/4" thick and in two sections • anodized aluminum center console 96" long • laminate worksurface, no charge if standard laminate is selected • glass worksurface with reverse bevel edge, (see page CC4) • aluminum edge available, specify and add \$5,236 list 											

To Order, Specify:

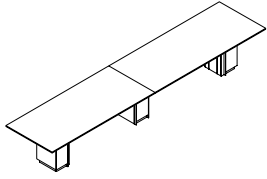
Rectangular Table

- 1 Model Number
- 2 Wood Species
- 3 Finish Scheme
 - A. Accent Surround - Veneer or Paint
 - B. Base Pedestal - Veneer or Paint
(see page [CC8](#) - apron follows base pedestal)
- 4 Worksurface Option
 - A. Veneer
 - B. Laminate
 - C. Glossy Low Iron White Back Painted Glass
 - D. Frosted Low Iron White Back Painted Glass
(see page [CC4](#))
- 5 Power and Data Options (see [accessories price list](#))
- 6 Other Product Options

Rectangular Table with Center Console

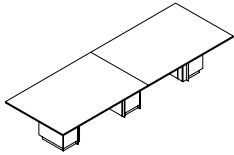
- 1 Model Number
- 2 Wood Species
- 3 Finish Scheme
 - A. Accent Surround - Veneer or Paint
 - B. Base Pedestal - Veneer or Paint
(see page [CC8](#) - apron follows base pedestal)
- 4 Worksurface Option
 - A. Veneer
 - B. Laminate
 - C. Glossy Low Iron White Back Painted Glass
 - D. Frosted Low Iron White Back Painted Glass
(see page [CC4](#))
- 5 Power and Data Options (see [accessories price list](#))
- 6 Other Product Options
- 7 Center Console Accessories (see pages [CC86-CC87](#) - order separately)

Description	Model	D	L	H	Seat Capacity	Top Pieces	Bases Required	CTN WT	CU FT	Veneer	Glass Top
Rectangular Table with Rectangular Base	CC8JRR2-48216	48	216	29	16	2	3	654	37	\$31,620	\$47,315



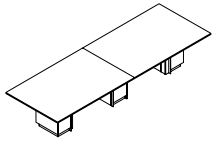
- short grain veneer direction
- base CC8NRC2-21174
- plinth base
- top is 1 ¼" thick and in two sections
- laminate worksurface, no charge if standard laminate is selected
- glass worksurface with reverse bevel edge, (see page [CC4](#))
- aluminum edge available, specify and add \$6,775 list

Rectangular Table with Rectangular Base	CC8JRR2-48192	48	192	29	14	2	3	612	35	\$24,249	\$38,198
---	----------------------	----	-----	----	----	---	---	-----	----	----------	----------



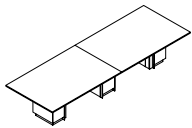
- short grain veneer direction
- base CC8NRC2-21156
- plinth base
- top is 1 ¼" thick and in two sections
- laminate worksurface, no charge if standard laminate is selected
- glass worksurface with reverse bevel edge, (see page [CC4](#))
- aluminum edge available, specify and add \$6,160 list

Rectangular Table with Rectangular Base	CC8JRR2-48168	48	168	29	12	2	3	567	32	\$22,055	\$34,261
---	----------------------	----	-----	----	----	---	---	-----	----	----------	----------



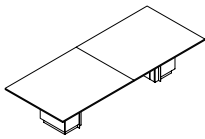
- short grain veneer direction
- base CC8NRC2-21132
- plinth base
- top is 1 ¼" thick and in two sections
- laminate worksurface, no charge if standard laminate is selected
- glass worksurface with reverse bevel edge, (see page [CC4](#))
- aluminum edge available, specify and add \$5,546 list

Rectangular Table with Rectangular Base	CC8JRR2-48144	48	144	29	8	2	3	525	30	\$20,378	\$30,841
---	----------------------	----	-----	----	---	---	---	-----	----	----------	----------



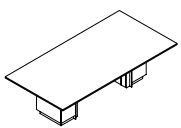
- short grain veneer direction
- base CC8NRC2-21108
- plinth base
- top is 1 ¼" thick and in two sections
- laminate worksurface, no charge if standard laminate is selected
- glass worksurface with reverse bevel edge, (see page [CC4](#))
- aluminum edge available, specify and add \$4,928 list

Description	① Model	D	L	H	Seat Capacity	Top Pieces	Bases Required	CTN WT	CU FT	Veneer	Glass Top
Rectangular Table with Rectangular Base	CC8JRR2-48120	48	120	29	6	2	2	393	22	\$13,287	\$21,485



- short grain veneer direction
- base CC8NRC2-2184
- plinth base
- top is 1 1/4" thick and in two sections
- laminate worksurface, no charge if standard laminate is selected
- glass worksurface with reverse bevel edge, (see page [CC4](#))
- aluminum edge available, specify and add \$4,313 list

Rectangular Table with Rectangular Base	CC8JRR2-4896	48	96	29	6	1	2	355	20	\$11,409	\$17,967
---	---------------------	----	----	----	---	---	---	-----	----	----------	----------



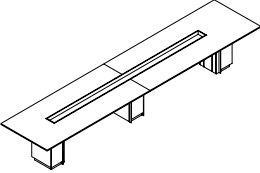
- long grain veneer direction
- base CC8NRC2-2160
- plinth base
- top is 1 1/4" thick
- laminate worksurface, no charge if standard laminate is selected
- glass worksurface with reverse bevel edge, (see page [CC4](#))
- aluminum edge available, specify and add \$3,699 list

COLLECTIVE CONFERENCE

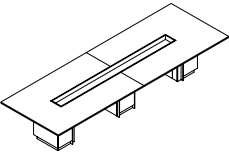
To Order, Specify:

- ① Model Number
- ② Wood Species
- ③ Finish Scheme
 - A. Accent Surround - Veneer or Paint
 - B. Base Pedestal - Veneer or Paint
 (see page [CC8](#) - apron follows base pedestal)
- ④ Worksurface Option
 - A. Veneer
 - B. Laminate
 - C. Glossy Low Iron White Back Painted Glass
 - D. Frosted Low Iron White Back Painted Glass
 (see page [CC4](#))
- ⑤ Power and Data Options (see [accessories price list](#))
- ⑥ Other Product Options

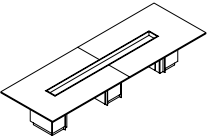
Description	Model	D	L	H	Seat Capacity	Top Pieces	Bases Required	CTN WT	CU FT	Veneer	Glass Top
-------------	-------	---	---	---	---------------	------------	----------------	--------	-------	--------	-----------

Rectangular Table with Rectangular Base and Center Console 	CC8JRRM-48216	48	216	29	18	2	3	654	43	\$39,396	\$55,088
---	----------------------	----	-----	----	----	---	---	-----	----	----------	----------

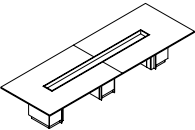
- short grain veneer direction
- base CC8NRC2-21174
- plinth base
- top is 1 ¼" thick and in two sections
- anodized aluminum center console 120" long
- laminate worksurface, no charge if standard laminate is selected
- glass worksurface with reverse bevel edge, (see page [CC4](#))
- aluminum edge available, specify and add \$6,775 list

Rectangular Table with Rectangular Base and Center Console 	CC8JRRM-48192	48	192	29	16	2	3	612	40	\$30,963	\$44,912
---	----------------------	----	-----	----	----	---	---	-----	----	----------	----------

- short grain veneer direction
- base CC8NRC2-21156
- plinth base
- top is 1 ¼" thick and in two sections
- anodized aluminum center console 144" long
- laminate worksurface, no charge if standard laminate is selected
- glass worksurface with reverse bevel edge, (see page [CC4](#))
- aluminum edge available, specify and add \$6,160 list

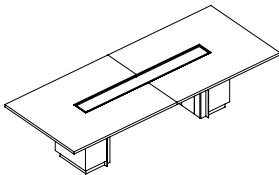
Rectangular Table with Rectangular Base and Center Console 	CC8JRRM-48168	48	168	29	14	2	3	568	37	\$27,709	\$39,915
---	----------------------	----	-----	----	----	---	---	-----	----	----------	----------

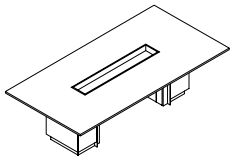
- short grain veneer direction
- base CC8NRC2-21132
- plinth base
- top is 1 ¼" thick and in two sections
- anodized aluminum center console 120" long
- laminate worksurface, no charge if standard laminate is selected
- glass worksurface with reverse bevel edge, (see page [CC4](#))
- aluminum edge available, specify and add \$5,546 list

Rectangular Table with Rectangular Base and Center Console 	CC8JRRM-48144	48	144	29	10	2	3	525	34	\$24,972	\$35,432
---	----------------------	----	-----	----	----	---	---	-----	----	----------	----------

- short grain veneer direction
- base CC8NRC2-21108
- plinth base
- top is 1 ¼" thick and in two sections
- anodized aluminum center console 96" long
- laminate worksurface, no charge if standard laminate is selected
- glass worksurface with reverse bevel edge, (see page [CC4](#))
- aluminum edge available, specify and add \$4,928 list

COLLECTIVE CONFERENCE

Description	① Model	D	L	H	Seat Capacity	Top Pieces	Bases Required	CTN WT	CU FT	Veneer	Glass Top
Rectangular Table with Rectangular Base and Center Console 	CC8JRRM-48120	48	120	29	6	2	2	394	26	\$16,820	\$25,018
	<ul style="list-style-type: none"> · short grain veneer direction · base CC8NRC2-2184 · plinth base · top is 1 1/4" thick and in two sections · anodized aluminum center console 72" long · laminate worksurface, no charge if standard laminate is selected · glass worksurface with reverse bevel edge, (see page CC4) · aluminum edge available, specify and add \$4,313 list 										

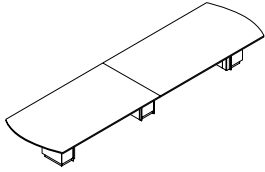
Rectangular Table with Rectangular Base and Center Console 	CC8JRRM-4896	48	96	29	6	1	2	355	23	\$13,883	\$20,442
	<ul style="list-style-type: none"> · long grain veneer direction · base CC8NRC2-2160 · plinth base · top is 1 1/4" thick · anodized aluminum center console 48" long · laminate worksurface, no charge if standard laminate is selected · glass worksurface with reverse bevel edge, (see page CC4) · aluminum edge available, specify and add \$3,699 list 										

COLLECTIVE CONFERENCE

To Order, Specify:

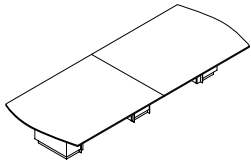
- ① Model Number
- ② Wood Species
- ③ Finish Scheme
 - A. Accent Surround - Veneer or Paint
 - B. Base Pedestal - Veneer or Paint
 (see page [CC8](#) - apron follows base pedestal)
- ④ Worksurface Option
 - A. Veneer
 - B. Laminate
 - C. Glossy Low Iron White Back Painted Glass
 - D. Frosted Low Iron White Back Painted Glass
 (see page [CC4](#))
- ⑤ Power and Data Options (see [accessories price list](#))
- ⑥ Other Product Options
- ⑦ Center Console Accessories (see pages [CC86-CC87](#) - order separately)

Description	① Model	D	L	H	Seat Capacity	Top Pieces	Bases Required	CTN WT	CU FT	Veneer	Glass Top
Arc End Table with Rectangular Base	CC8JAR2-60216	60	216	29	16	2	3	787	42	\$38,110	\$57,725



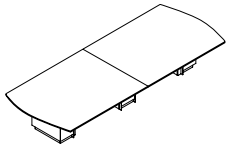
- short grain veneer direction
- base CC8NRC2-27174
- plinth base
- top is 1 ¼" thick and in two sections
- laminate worksurface, no charge if standard laminate is selected
- glass worksurface with reverse bevel edge, (see page [CC4](#))

Arc End Table with Rectangular Base	CC8JAR2-60192	60	192	29	14	2	3	737	39	\$29,656	\$47,092
-------------------------------------	----------------------	----	-----	----	----	---	---	-----	----	----------	----------



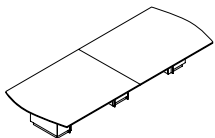
- short grain veneer direction
- base CC8NRC2-27156
- plinth base
- top is 1 ¼" thick and in two sections
- laminate worksurface, no charge if standard laminate is selected
- glass worksurface with reverse bevel edge, (see page [CC4](#))

Arc End Table with Rectangular Base	CC8JAR2-60168	60	168	29	12	2	3	683	36	\$26,844	\$44,912
-------------------------------------	----------------------	----	-----	----	----	---	---	-----	----	----------	----------



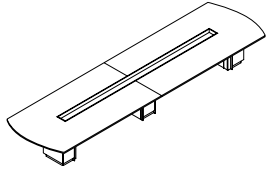
- short grain veneer direction
- base CC8NRC2-27132
- plinth base
- top is 1 ¼" thick and in two sections
- laminate worksurface, no charge if standard laminate is selected
- glass worksurface with reverse bevel edge, (see page [CC4](#))

Arc End Table with Rectangular Base	CC8JAR2-60144	60	144	29	10	2	3	632	33	\$24,576	\$37,653
-------------------------------------	----------------------	----	-----	----	----	---	---	-----	----	----------	----------



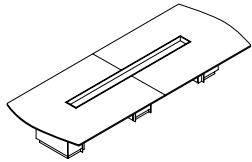
- short grain veneer direction
- base CC8NRC2-27108
- plinth base
- top is 1 ¼" thick and in two sections
- laminate worksurface, no charge if standard laminate is selected
- glass worksurface with reverse bevel edge, (see page [CC4](#))

Description	Model	D	L	H	Seat Capacity	Top Pieces	Bases Required	CTN WT	CU FT	Veneer	Glass Top
Arc End Table with Rectangular Base and Center Console	CC8JARM-60216	60	216	29	16	2	3	788	50	\$45,878	\$65,495



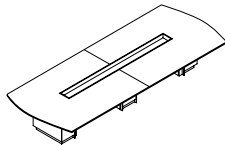
- short grain veneer direction
- base CC8NRC2-27174
- plinth base
- top is 1 1/4" thick and in two sections
- anodized aluminum center console 160" long
- laminate worksurface, no charge if standard laminate is selected
- glass worksurface with reverse bevel edge, (see page [CC4](#))

Arc End Table with Rectangular Base and Center Console	CC8JARM-60192	60	192	29	14	2	3	737	46	\$36,369	\$53,807
--	---------------	----	-----	----	----	---	---	-----	----	----------	----------



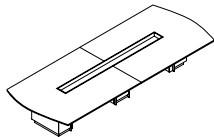
- short grain veneer direction
- base CC8NRC2-27156
- plinth base
- top is 1 1/4" thick and in two sections
- anodized aluminum center console 144" long
- laminate worksurface, no charge if standard laminate is selected
- glass worksurface with reverse bevel edge, (see page [CC4](#))

Arc End Table with Rectangular Base and Center Console	CC8JARM-60168	60	168	29	12	2	3	684	42	\$32,496	\$47,752
--	---------------	----	-----	----	----	---	---	-----	----	----------	----------



- short grain veneer direction
- base CC8NRC2-27132
- plinth base
- top is 1 1/4" thick and in two sections
- anodized aluminum center console 120" long
- laminate worksurface, no charge if standard laminate is selected
- glass worksurface with reverse bevel edge, (see page [CC4](#))

Arc End Table with Rectangular Base and Center Console	CC8JARM-60144	60	144	29	10	2	3	632	39	\$29,168	\$42,245
--	---------------	----	-----	----	----	---	---	-----	----	----------	----------



- short grain veneer direction
- base CC8NRC2-27108
- plinth base
- top is 1 1/4" thick and in two sections
- anodized aluminum center console 96" long
- laminate worksurface, no charge if standard laminate is selected
- glass worksurface with reverse bevel edge, (see page [CC4](#))

To Order, Specify:

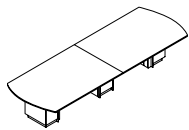
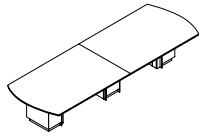
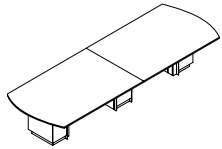
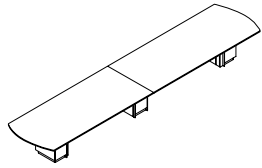
Arc End Table

- Model Number
- Wood Species
- Finish Scheme
 - Accent Surround - Veneer or Paint
 - Base Pedestal - Veneer or Paint
(see page [CC8](#) - apron follows base pedestal)
- Worksurface Option
 - Veneer
 - Laminate
 - Glossy Low Iron White Back Painted Glass
 - Frosted Low Iron White Back Painted Glass
(see page [CC4](#))
- Power and Data Options (see [accessories price list](#))
- Other Product Options

Arc End Table with Center Console

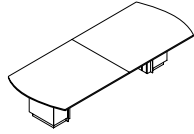
- Model Number
- Wood Species
- Finish Scheme
 - Accent Surround - Veneer or Paint
 - Base Pedestal - Veneer or Paint
(see page [CC8](#) - apron follows base pedestal)
- Worksurface Option
 - Veneer
 - Laminate
 - Glossy Low Iron White Back Painted Glass
 - Frosted Low Iron White Back Painted Glass
(see page [CC4](#))
- Power and Data Options (see [accessories price list](#))
- Other Product Options
- Center Console Accessories (see pages [CC86-CC87](#) - order separately)

Description	① Model	D	L	H	Seat Capacity	Top Pieces	Bases Required	CTN WT	CU FT	Veneer	Glass Top
Arc End Table with Rectangular Base	CC8JAR2-48216	48	216	29	16	2	3	654	37	\$32,370	\$52,233
	<ul style="list-style-type: none"> · short grain veneer direction · base CC8NRC2-21174 · plinth base · top is 1 ¼" thick and in two sections · laminate worksurface, no charge if standard laminate is selected · glass worksurface with reverse bevel edge, (see page CC4) 										
Arc End Table with Rectangular Base	CC8JAR2-48192	48	192	29	14	2	3	612	35	\$24,899	\$38,847
	<ul style="list-style-type: none"> · short grain veneer direction · base CC8NRC2-21156 · plinth base · top is 1 ¼" thick and in two sections · laminate worksurface, no charge if standard laminate is selected · glass worksurface with reverse bevel edge, (see page CC4) 										
Arc End Table with Rectangular Base	CC8JAR2-48168	48	168	29	12	2	3	567	32	\$22,613	\$34,821
	<ul style="list-style-type: none"> · short grain veneer direction · base CC8NRC2-21132 · plinth base · top is 1 ¼" thick and in two sections · laminate worksurface, no charge if standard laminate is selected · glass worksurface with reverse bevel edge, (see page CC4) 										
Arc End Table with Rectangular Base	CC8JAR2-48144	48	144	29	10	2	3	525	30	\$20,841	\$33,078
	<ul style="list-style-type: none"> · short grain veneer direction · base CC8NRC2-21108 · plinth base · top is 1 ¼" thick and in two sections · laminate worksurface, no charge if standard laminate is selected · glass worksurface with reverse bevel edge, (see page CC4) 										



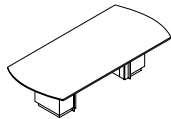
COLLECTIVE CONFERENCE

Description	① Model	D	L	H	Seat Capacity	Top Pieces	Bases Required	CTN WT	CU FT	Veneer	Glass Top
Arc End Table with Rectangular Base	CC8JAR2-48120	48	120	29	6	2	2	393	22	\$13,663	\$21,860



- short grain veneer direction
- base CC8NRC2-2184
- plinth base
- top is 1 1/4" thick and in two sections
- laminate worksurface, no charge if standard laminate is selected
- glass worksurface with reverse bevel edge, (see page [CC4](#))

Arc End Table with Rectangular Base	CC8JAR2-4896	48	96	29	6	1	2	355	20	\$11,685	\$18,243
-------------------------------------	---------------------	----	----	----	---	---	---	-----	----	----------	----------



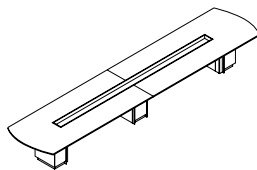
- long grain veneer direction
- base CC8NRC2-2160
- plinth base
- top is 1 1/4" thick
- laminate worksurface, no charge if standard laminate is selected
- glass worksurface with reverse bevel edge, (see page [CC4](#))

To Order, Specify

- ① Model Number
- ② Wood Species
- ③ Finish Scheme
 - A. Accent Surround - Veneer or Paint
 - B. Base Pedestal - Veneer or Paint
 - (see page [CC8](#) - apron follows base pedestal)
- ④ Worksurface Option
 - A. Veneer
 - B. Laminate
 - C. Glossy Low Iron White Back Painted Glass
 - D. Frosted Low Iron White Back Painted Glass
 - (see page [CC4](#))
- ⑤ Power and Data Options (see [accessories price list](#))
- ⑥ Other Product Options

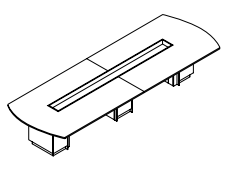
Description	① Model	D	L	H	Seat Capacity	Top Pieces	Bases Required	CTN WT	CU FT	Veneer	Glass Top
-------------	---------	---	---	---	---------------	------------	----------------	--------	-------	--------	-----------

Arc End Table with Rectangular Base and Center Console	CC8JARM-48216	48	216	29	16	2	3	654	43	\$40,142	\$55,834
--	----------------------	----	-----	----	----	---	---	-----	----	----------	----------



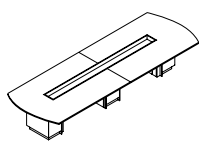
- short grain veneer direction
- base CC8NRC2-21174
- plinth base
- top is 1 1/4" thick and in two sections
- anodized aluminum center console 160" long
- laminate worksurface, no charge if standard laminate is selected
- glass worksurface with reverse bevel edge, (see page [CC4](#))

Arc End Table with Rectangular Base and Center Console	CC8JARM-48192	48	192	29	14	2	3	612	40	\$31,613	\$54,090
--	----------------------	----	-----	----	----	---	---	-----	----	----------	----------



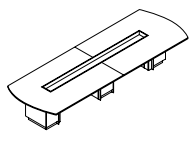
- short grain veneer direction
- base CC8NRC2-21156
- plinth base
- top is 1 1/4" thick and in two sections
- anodized aluminum center console 144" long
- laminate worksurface, no charge if standard laminate is selected
- glass worksurface with reverse bevel edge, (see page [CC4](#))

Arc End Table with Rectangular Base and Center Console	CC8JARM-48168	48	168	29	12	2	3	568	37	\$28,265	\$40,471
--	----------------------	----	-----	----	----	---	---	-----	----	----------	----------



- short grain veneer direction
- base CC8NRC2-21132
- plinth base
- top is 1 1/4" thick and in two sections
- anodized aluminum center console 120" long
- laminate worksurface, no charge if standard laminate is selected
- glass worksurface with reverse bevel edge, (see page [CC4](#))

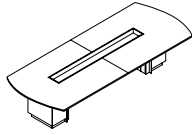
Arc End Table with Rectangular Base and Center Console	CC8JARM-48144	48	144	29	10	2	3	525	34	\$25,435	\$35,897
--	----------------------	----	-----	----	----	---	---	-----	----	----------	----------



- short grain veneer direction
- base CC8NRC2-21108
- plinth base
- top is 1 1/4" thick and in two sections
- anodized aluminum center console 96" long
- laminate worksurface, no charge if standard laminate is selected
- glass worksurface with reverse bevel edge, (see page [CC4](#))

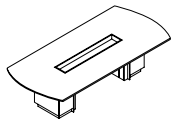
COLLECTIVE CONFERENCE

Description	① Model	D	L	H	Seat Capacity	Top Pieces	Bases Required	CTN WT	CU FT	Veneer	Glass Top
Arc End Table with Rectangular Base and Center Console	CC8JARM-48120	48	120	29	6	2	2	394	26	\$17,196	\$25,394



- short grain veneer direction
- base CC8NRC2-2184
- plinth base
- top is 1 1/4" thick and in two sections
- anodized aluminum center console 72" long
- laminate worksurface, no charge if standard laminate is selected
- glass worksurface with reverse bevel edge, (see page [CC4](#))

Arc End Table with Rectangular Base and Center Console	CC8JARM-4896	48	96	29	6	1	2	355	23	\$14,157	\$20,716
--	---------------------	----	----	----	---	---	---	-----	----	----------	----------



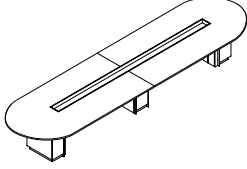
- long grain veneer direction
- base CC8NRC2-2160
- plinth base
- top is 1 1/4" thick
- anodized aluminum center console 48" long
- laminate worksurface, no charge if standard laminate is selected
- glass worksurface with reverse bevel edge, (see page [CC4](#))

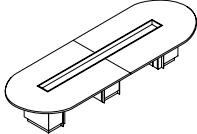
To Order, Specify

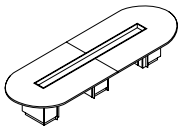
- ① Model Number
- ② Wood Species
- ③ Finish Scheme
 - A. Accent Surround - Veneer or Paint
 - B. Base Pedestal - Veneer or Paint
 - (see page [CC8](#) - apron follows base pedestal)
- ④ Worksurface Option
 - A. Veneer
 - B. Laminate
 - C. Glossy Low Iron White Back Painted Glass
 - D. Frosted Low Iron White Back Painted Glass
 - (see page [CC4](#))
- ⑤ Power and Data Options (see [accessories price list](#))
- ⑥ Other Product Options
- ⑦ Center Console Accessories (see pages [CC86-CC87](#) - order separately)

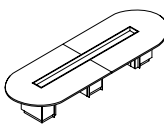
Description	① Model	D	L	H	Seat Capacity	Top Pieces	Bases Required	CTN WT	CU FT	Veneer	Glass Top
Racetrack Table with Rectangular Base 	CC8JOR2-60216	60	216	29	18	2	3	762	42	\$38,430	\$58,048
<ul style="list-style-type: none"> · short grain veneer direction · base CC8NRC2-27174 · plinth base · top is 1 ¼" thick and in two sections · laminate worksurface, no charge if standard laminate is selected · glass worksurface with reverse bevel edge, (see page CC4) 											
Racetrack Table with Rectangular Base 	CC8JOR2-60192	60	192	29	16	2	3	712	39	\$29,939	\$47,374
<ul style="list-style-type: none"> · short grain veneer direction · base CC8NRC2-27156 · plinth base · top is 1 ¼" thick and in two sections · laminate worksurface, no charge if standard laminate is selected · glass worksurface with reverse bevel edge, (see page CC4) 											
Racetrack Table with Rectangular Base 	CC8JOR2-60168	60	168	29	14	2	3	658	36	\$27,083	\$42,339
<ul style="list-style-type: none"> · short grain veneer direction · base CC8NRC2-27132 · plinth base · top is 1 ¼" thick and in two sections · laminate worksurface, no charge if standard laminate is selected · glass worksurface with reverse bevel edge, (see page CC4) 											
Racetrack Table with Rectangular Base 	CC8JOR2-60144	60	144	29	10	2	3	607	33	\$24,777	\$37,854
<ul style="list-style-type: none"> · short grain veneer direction · base CC8NRC2-27108 · plinth base · top is 1 ¼" thick and in two sections · laminate worksurface, no charge if standard laminate is selected · glass worksurface with reverse bevel edge, (see page CC4) 											

COLLECTIVE CONFERENCE

Description	Model	D	L	H	Seat Capacity	Top Pieces	Bases Required	CTN WT	CU FT	Veneer	Glass Top
Racetrack Table with Rectangular Base and Center Console 	CC8JORM-60216	60	216	29	18	2	3	763	50	\$46,205	\$65,821
	<ul style="list-style-type: none"> • short grain veneer direction • base CC8NRC2-27174 • plinth base • top is 1 1/4" thick and in two sections • anodized aluminum center console 160" long • laminate worksurface, no charge if standard laminate is selected • glass worksurface with reverse bevel edge, (see page CC4) 										

Racetrack Table with Rectangular Base and Center Console 	CC8JORM-60192	60	192	29	16	2	3	712	46	\$36,650	\$54,086
	<ul style="list-style-type: none"> • short grain veneer direction • base CC8NRC2-27156 • plinth base • top is 1 1/4" thick and in two sections • anodized aluminum center console 144" long • laminate worksurface, no charge if standard laminate is selected • glass worksurface with reverse bevel edge, (see page CC4) 										

Racetrack Table with Rectangular Base and Center Console 	CC8JORM-60168	60	168	29	14	2	3	659	42	\$32,735	\$47,993
	<ul style="list-style-type: none"> • short grain veneer direction • base CC8NRC2-27132 • plinth base • top is 1 1/4" thick and in two sections • anodized aluminum center console 120" long • laminate worksurface, no charge if standard laminate is selected • glass worksurface with reverse bevel edge, (see page CC4) 										

Racetrack Table with Rectangular Base and Center Console 	CC8JORM-60144	60	144	29	10	2	3	607	39	\$29,372	\$42,447
	<ul style="list-style-type: none"> • short grain veneer direction • base CC8NRC2-27108 • plinth base • top is 1 1/4" thick and in two sections • anodized aluminum center console 96" long • laminate worksurface, no charge if standard laminate is selected • glass worksurface with reverse bevel edge, (see page CC4) 										

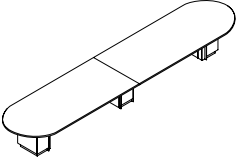
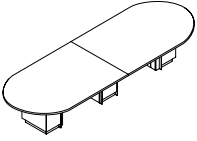
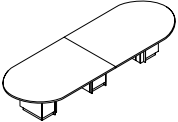
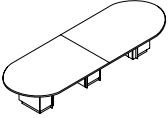
To Order, Specify:

Racetrack Table

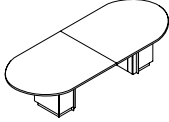
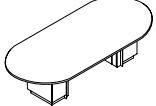
- 1 Model Number
- 2 Wood Species
- 3 Finish Scheme
 - A. Accent Surround - Veneer or Paint
 - B. Base Pedestal - Veneer or Paint
(see page [CC8](#) - apron follows base pedestal)
- 4 Worksurface Option
 - A. Veneer
 - B. Laminate
 - C. Glossy Low Iron White Back Painted Glass
 - D. Frosted Low Iron White Back Painted Glass
(see page [CC4](#))
- 5 Power and Data Options (see [accessories price list](#))
- 6 Other Product Options

Racetrack Table with Center Console

- 1 Model Number
- 2 Wood Species
- 3 Finish Scheme
 - A. Accent Surround - Veneer or Paint
 - B. Base Pedestal - Veneer or Paint
(see page [CC8](#) - apron follows base pedestal)
- 4 Worksurface Option
 - A. Veneer
 - B. Laminate
 - C. Glossy Low Iron White Back Painted Glass
 - D. Frosted Low Iron White Back Painted Glass
(see page [CC4](#))
- 5 Power and Data Options (see [accessories price list](#))
- 6 Other Product Options
- 7 Center Console Accessories (see pages [CC86-CC87](#)- order separately)

Description	① Model	D	L	H	Seat Capacity	Top Pieces	Bases Required	CTN WT	CU FT	Veneer	Glass Top
Racetrack Table with Rectangular Base 	CC8JOR2-48216	48	216	29	16	2	3	646	37	\$32,619	\$48,311
	<ul style="list-style-type: none"> · short grain veneer direction · base CC8NRC2-21174 · plinth base · top is 1 ¼" thick and in two sections · laminate worksurface, no charge if standard laminate is selected · glass worksurface with reverse bevel edge, (see page CC4) 										
Racetrack Table with Rectangular Base 	CC8JOR2-48192	48	192	29	14	2	3	596	35	\$25,116	\$39,066
	<ul style="list-style-type: none"> · short grain veneer direction · base CC8NRC2-21156 · plinth base · top is 1 ¼" thick and in two sections · laminate worksurface, no charge if standard laminate is selected · glass worksurface with reverse bevel edge, (see page CC4) 										
Racetrack Table with Rectangular Base 	CC8JOR2-48168	48	168	29	12	2	3	560	32	\$22,797	\$35,002
	<ul style="list-style-type: none"> · short grain veneer direction · base CC8NRC2-21132 · plinth base · top is 1 ¼" thick and in two sections · laminate worksurface, no charge if standard laminate is selected · glass worksurface with reverse bevel edge, (see page CC4) 										
Racetrack Table with Rectangular Base 	CC8JOR2-48144	48	144	29	8	2	3	509	30	\$20,997	\$31,462
	<ul style="list-style-type: none"> · short grain veneer direction · base CC8NRC2-21108 · plinth base · top is 1 ¼" thick and in two sections · laminate worksurface, no charge if standard laminate is selected · glass worksurface with reverse bevel edge, (see page CC4) 										

COLLECTIVE CONFERENCE

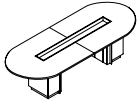
Description	① Model	D	L	H	Seat Capacity	Top Pieces	Bases Required	CTN WT	CU FT	Veneer	Glass Top
Racetrack Table with Rectangular Base 	CC8JOR2-48120	48	120	29	6	2	2	377	22	\$13,788	\$21,985
	<ul style="list-style-type: none"> • short grain veneer direction • base CC8NRC2-2184 • plinth base • top is 1 ¼" thick and in two sections • laminate worksurface, no charge if standard laminate is selected • glass worksurface with reverse bevel edge, (see page CC4) 										
Racetrack Table with Rectangular Base 	CC8JOR2-4896	48	96	29	6	1	2	330	20	\$11,776	\$18,337
	<ul style="list-style-type: none"> • long grain veneer direction • base CC8NRC2-2160 • plinth base • top is 1 ¼" thick • laminate worksurface, no charge if standard laminate is selected • glass worksurface with reverse bevel edge, (see page CC4) 										

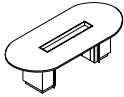
To Order, Specify:

- ① Model Number
- ② Wood Species
- ③ Finish Scheme
 - A. Accent Surround - Veneer or Paint
 - B. Base Pedestal - Veneer or Paint
 (see page [CC8](#) - apron follows base pedestal)
- ④ Worksurface Option
 - A. Veneer
 - B. Laminate
 - C. Glossy Low Iron White Back Painted Glass
 - D. Frosted Low Iron White Back Painted Glass
 (see page [CC4](#))
- ⑤ Power and Data Options (see [accessories price list](#))
- ⑥ Other Product Options

Description	Model	D	L	H	Seat Capacity	Top Pieces	Bases Required	CTN WT	CU FT	Veneer	Glass Top
Racetrack Table with Rectangular Base and Center Console 	CC8JORM-48216	48	216	29	18	2	3	646	43	\$40,389	\$56,081
	<ul style="list-style-type: none"> · short grain veneer direction · base CC8NRC2-21174 · plinth base · top is 1 ¼" thick and in two sections · anodized aluminum center console 160" long · laminate worksurface, no charge if standard laminate is selected · glass worksurface with reverse bevel edge, (see page CC4) 										
Racetrack Table with Rectangular Base and Center Console 	CC8JORM-48192	48	192	29	16	2	3	597	40	\$31,830	\$45,778
	<ul style="list-style-type: none"> · short grain veneer direction · base CC8NRC2-21156 · plinth base · top is 1 ¼" thick and in two sections · anodized aluminum center console 144" long · laminate worksurface, no charge if standard laminate is selected · glass worksurface with reverse bevel edge, (see page CC4) 										
Racetrack Table with Rectangular Base and Center Console 	CC8JORM-48168	48	168	29	14	2	3	560	37	\$28,449	\$40,655
	<ul style="list-style-type: none"> · short grain veneer direction · base CC8NRC2-21132 · plinth base · top is 1 ¼" thick and in two sections · anodized aluminum center console 120" long · laminate worksurface, no charge if standard laminate is selected · glass worksurface with reverse bevel edge, (see page CC4) 										
Racetrack Table with Rectangular Base and Center Console 	CC8JORM-48144	48	144	29	10	2	3	510	34	\$25,591	\$36,051
	<ul style="list-style-type: none"> · short grain veneer direction · base CC8NRC2-21108 · plinth base · top is 1 ¼" thick and in two sections · anodized aluminum center console 96" long · laminate worksurface, no charge if standard laminate is selected · glass worksurface with reverse bevel edge, (see page CC4) 										

COLLECTIVE CONFERENCE

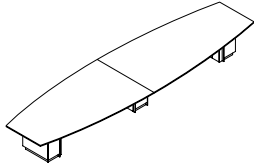
Description	① Model	D	L	H	Seat Capacity	Top Pieces	Bases Required	CTN WT	CU FT	Veneer	Glass Top
Racetrack Table with Rectangular Base and Center Console 	CC8JORM-48120	48	120	29	6	2	2	378	26	\$17,325	\$25,523
	<ul style="list-style-type: none"> · short grain veneer direction · base CC8NRC2-2184 · plinth base · top is 1 ¼" thick and in two sections · anodized aluminum center console 72" long · laminate worksurface, no charge if standard laminate is selected · glass worksurface with reverse bevel edge, (see page CC4) 										

Racetrack Table with Rectangular Base and Center Console 	CC8JORM-4896	48	96	29	6	1	2	331	23	\$14,248	\$20,805
	<ul style="list-style-type: none"> · long grain veneer direction · base CC8NRC2-2160 · plinth base · top is 1 ¼" thick · anodized aluminum center console 48" long · laminate worksurface, no charge if standard laminate is selected · glass worksurface with reverse bevel edge, (see page CC4) 										

To Order, Specify:

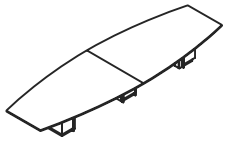
- ① Model Number
- ② Wood Species
- ③ Finish Scheme
 - A. Accent Surround - Veneer or Paint
 - B. Base Pedestal - Veneer or Paint
 (see page [CC8](#) - apron follows base pedestal)
- ④ Worksurface Option
 - A. Veneer
 - B. Laminate
 - C. Glossy Low Iron White Back Painted Glass
 - D. Frosted Low Iron White Back Painted Glass
 (see page [CC4](#))
- ⑤ Power and Data Options (see [accessories price list](#))
- ⑥ Other Product Options
- ⑦ Center Console Accessories (see pages [CC86-CC87](#) - order separately)

Description	① Model	D	L	H	Seat Capacity	Top Pieces	Bases Required	CTN WT	CU FT	Veneer	Glass Top
Boat Shape Table with Rectangular Base	CC8JBR2-60216	60	216	29	16	2	3	710	42	\$37,237	\$55,412



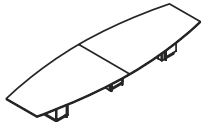
- short grain veneer direction
- base CC8NRC2-27174
- plinth base
- top is 1 ¼" thick and in two sections
- laminate worksurface, no charge if standard laminate is selected
- glass worksurface with reverse bevel edge, (see page [CC4](#))

Boat Shape Table with Rectangular Base	CC8JBR2-60192	60	192	29	14	2	3	668	39	\$28,555	\$45,989
--	----------------------	----	-----	----	----	---	---	-----	----	----------	----------

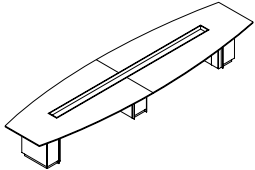
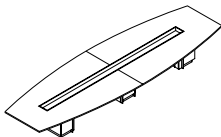
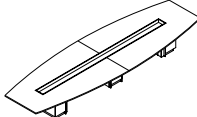


- short grain veneer direction
- base CC8NRC2-27156
- plinth base
- top is 1 ¼" thick and in two sections
- laminate worksurface, no charge if standard laminate is selected
- glass worksurface with reverse bevel edge, (see page [CC4](#))

Boat Shape Table with Rectangular Base	CC8JBR2-60168	60	168	29	12	2	3	623	36	\$26,348	\$41,606
--	----------------------	----	-----	----	----	---	---	-----	----	----------	----------



- short grain veneer direction
- base CC8NRC2-27132
- plinth base
- top is 1 ¼" thick and in two sections
- laminate worksurface, no charge if standard laminate is selected
- glass worksurface with reverse bevel edge, (see page [CC4](#))

Description	① Model	D	L	H	Seat Capacity	Top Pieces	Bases Required	CTN WT	CU FT	Veneer	Glass Top
Boat Shape Table with Rectangular Base and Center Console 	CC8JBRM-60216	60	216	29	16	2	3	711	50	\$45,007	\$64,624
	<ul style="list-style-type: none"> • short grain veneer direction • base CC8NRC2-27174 • plinth base • top is 1 ¼" thick and in two sections • anodized aluminum center console 160" long • laminate worksurface, no charge if standard laminate is selected • glass worksurface with reverse bevel edge, (see page CC4) 										
Boat Shape Table with Rectangular Base and Center Console 	CC8JBRM-60192	60	192	29	14	2	3	668	46	\$35,267	\$52,702
	<ul style="list-style-type: none"> • short grain veneer direction • base CC8NRC2-27156 • plinth base • top is 1 ¼" thick and in two sections • anodized aluminum center console 144" long • laminate worksurface, no charge if standard laminate is selected • glass worksurface with reverse bevel edge, (see page CC4) 										
Boat Shape Table with Rectangular Base and Center Console 	CC8JBRM-60168	60	168	29	12	2	3	624	42	\$31,997	\$47,256
	<ul style="list-style-type: none"> • short grain veneer direction • base CC8NRC2-27132 • plinth base • top is 1 ¼" thick and in two sections • anodized aluminum center console 120" long • laminate worksurface, no charge if standard laminate is selected • glass worksurface with reverse bevel edge, (see page CC4) 										

To Order, Specify:

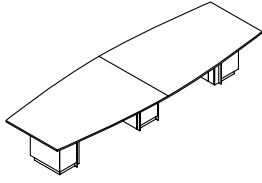
Boat Shape Table

- ① Model Number
- ② Wood Species
- ③ Finish Scheme
 - A. Accent Surround - Veneer or Paint
 - B. Base Pedestal - Veneer or Paint
(see page [CC8](#) - apron follows base pedestal)
- ④ Worksurface Option
 - A. Veneer
 - B. Laminate
 - C. Glossy Low Iron White Back Painted Glass
 - D. Frosted Low Iron White Back Painted Glass
(see page [CC4](#))
- ⑤ Power and Data Options (see [accessories price list](#))
- ⑥ Other Product Options

Boat Shape Table with Center Console

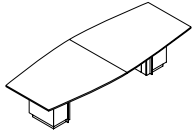
- ① Model Number
- ② Wood Species
- ③ Finish Scheme
 - A. Accent Surround - Veneer or Paint
 - B. Base Pedestal - Veneer or Paint
(see page [CC8](#) - apron follows base pedestal)
- ④ Worksurface Option
 - A. Veneer
 - B. Laminate
 - C. Glossy Low Iron White Back Painted Glass
 - D. Frosted Low Iron White Back Painted Glass
(see page [CC4](#))
- ⑤ Power and Data Options (see [accessories price list](#))
- ⑥ Other Product Options
- ⑦ Center Console Accessories (see pages [CC86-CC87](#) - order separately)

Description	① Model	D	L	H	Seat Capacity	Top Pieces	Bases Required	CTN WT	CU FT	Veneer	Glass Top
Boat Shape Table with Rectangular Base	CC8JBR2-48144	48	144	29	8	2	3	497	30	\$24,197	\$34,658



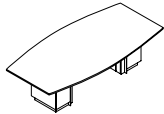
- short grain veneer direction
- base CC8NRC2-21108
- plinth base
- top is 1 ¼" thick and in two sections
- laminate worksurface, no charge if standard laminate is selected
- glass worksurface with reverse bevel edge, (see page [CC4](#))

Boat Shape Table with Rectangular Base	CC8JBR2-48120	48	120	29	6	2	2	370	22	\$15,332	\$23,531
--	----------------------	----	-----	----	---	---	---	-----	----	----------	----------

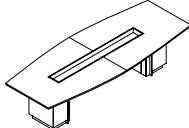


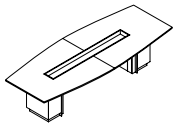
- short grain veneer direction
- base CC8NRC2-2184
- plinth base
- top is 1 ¼" thick and in two sections
- laminate worksurface, no charge if standard laminate is selected
- glass worksurface with reverse bevel edge, (see page [CC4](#))

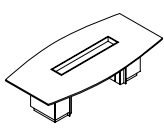
Boat Shape Table with Rectangular Base	CC8JBR2-4896	48	96	29	6	1	2	336	20	\$12,932	\$19,492
--	---------------------	----	----	----	---	---	---	-----	----	----------	----------



- long grain veneer direction
- base CC8NRC2-2160
- plinth base
- top is 1 ¼" thick
- laminate worksurface, no charge if standard laminate is selected
- glass worksurface with reverse bevel edge, (see page [CC4](#))

Description	① Model	D	L	H	Seat Capacity	Top Pieces	Bases Required	CTN WT	CU FT	Veneer	Glass Top
Boat Shape Table with Rectangular Base and Center Console 	CC8JBRM-48144	48	144	29	8	2	3	498	34	\$28,788	\$39,249
<ul style="list-style-type: none"> · short grain veneer direction · base CC8NRC2-21108 · plinth base · top is 1 1/4" thick and in two sections · anodized aluminum center console 96" long · laminate worksurface, no charge if standard laminate is selected · glass worksurface with reverse bevel edge, (see page CC4) 											

Boat Shape Table with Rectangular Base and Center Console 	CC8JBRM-48120	48	120	29	6	2	2	371	26	\$18,863	\$27,061
<ul style="list-style-type: none"> · short grain veneer direction · base CC8NRC2-2184 · plinth base · top is 1 1/4" thick and in two sections · anodized aluminum center console 72" long · laminate worksurface, no charge if standard laminate is selected · glass worksurface with reverse bevel edge, (see page CC4) 											

Boat Shape Table with Rectangular Base and Center Console 	CC8JBRM-4896	48	96	29	6	1	2	337	23	\$15,403	\$21,963
<ul style="list-style-type: none"> · long grain veneer direction · base CC8NRC2-2160 · plinth base · top is 1 1/4" thick · anodized aluminum center console 48" long · laminate worksurface, no charge if standard laminate is selected · glass worksurface with reverse bevel edge, (see page CC4) 											

COLLECTIVE CONFERENCE

To Order, Specify:

Boat Shape Table

- ① Model Number
- ② Wood Species
- ③ Finish Scheme
 - A. Accent Surround - Veneer or Paint
 - B. Base Pedestal - Veneer or Paint
(see page [CC8](#) - apron follows base pedestal)
- ④ Worksurface Option
 - A. Veneer
 - B. Laminate
 - C. Glossy Low Iron White Back Painted Glass
 - D. Frosted Low Iron White Back Painted Glass
(see page [CC4](#))
- ⑤ Power and Data Options (see [accessories price list](#))
- ⑥ Other Product Options

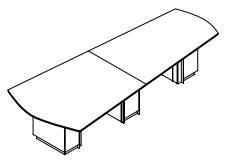
Boat Shape Table with Center Console

- ① Model Number
- ② Wood Species
- ③ Finish Scheme
 - A. Accent Surround - Veneer or Paint
 - B. Base Pedestal - Veneer or Paint
(see page [CC8](#) - apron follows base pedestal)
- ④ Worksurface Option
 - A. Veneer
 - B. Laminate
 - C. Glossy Low Iron White Back Painted Glass
 - D. Frosted Low Iron White Back Painted Glass
(see page [CC4](#))
- ⑤ Power and Data Options (see [accessories price list](#))
- ⑥ Other Product Options
- ⑦ Center Console Accessories (see pages [CC86-CC87](#) - order separately)

Collective Conference

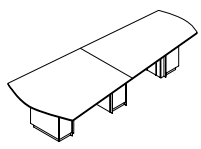


Description	Model	D	L	H	Seat Capacity	Top Pieces	Bases Required	CTN WT	CU FT	Veneer	Glass Top
-------------	-------	---	---	---	---------------	------------	----------------	--------	-------	--------	-----------



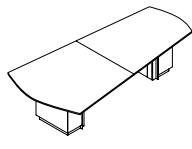
- short grain veneer direction
- base CC8NRC9-27168
- plinth base
- top is 1 1/4" thick and in two sections
- laminate worksurface, no charge if standard laminate is selected
- glass worksurface with reverse bevel edge, (see page [CC4](#))
- top size: 168"w x 40/60"d

View Table with Rectangular Base	CC8JVR2-60144	60	144	29	10	2	3	585	33	\$24,877	\$37,954
----------------------------------	----------------------	----	-----	----	----	---	---	-----	----	----------	----------



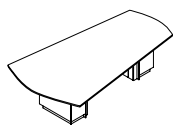
- short grain veneer direction
- base CC8NRC9-27144
- plinth base
- top is 1 1/4" thick and in two sections
- laminate worksurface, no charge if standard laminate is selected
- glass worksurface with reverse bevel edge, (see page [CC4](#))
- top size: 144"w x 40/60"d

View Table with Rectangular Base	CC8JVR2-60120	60	120	29	9	2	2	424	25	\$15,839	\$26,085
----------------------------------	----------------------	----	-----	----	---	---	---	-----	----	----------	----------



- short grain veneer direction
- base CC8NRC9-27120
- plinth base
- top is 1 1/4" thick and in two sections
- laminate worksurface, no charge if standard laminate is selected
- glass worksurface with reverse bevel edge, (see page [CC4](#))
- top size: 120"w x 40/60"d

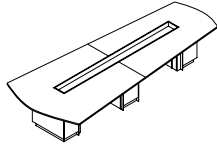
View Table with Rectangular Base	CC8JVR2-6096	60	96	29	7	1	2	380	22	\$13,163	\$21,362
----------------------------------	---------------------	----	----	----	---	---	---	-----	----	----------	----------



- long grain veneer direction
- base CC8NRC9-2796
- plinth base
- top is 1 1/4" thick
- laminate worksurface, no charge if standard laminate is selected
- glass worksurface with reverse bevel edge, (see page [CC4](#))
- top size: 96"w x 40/60"d

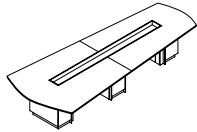
COLLECTIVE CONFERENCE

Description	① Model	D	L	H	Seat Capacity	Top Pieces	Bases Required	CTN WT	CU FT	Veneer	Glass Top
View Table with Rectangular Base and Center Console	CC8JVRM-60168	60	168	29	11	2	3	630	42	\$35,164	\$50,419



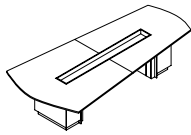
- short grain veneer direction
- base CC8NRC9-27168
- plinth base
- top is 1 1/4" thick and in two sections
- anodized aluminum center console 120" long
- laminate worksurface, no charge if standard laminate is selected
- glass worksurface with reverse bevel edge, (see page [CC4](#))
- top size: 168"w x 40/60"d

View Table with Rectangular Base and Center Console	CC8JVRM-60144	60	144	29	11	2	3	585	39	\$29,470	\$42,548
---	----------------------	----	-----	----	----	---	---	-----	----	----------	----------



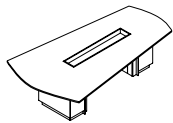
- short grain veneer direction
- base CC8NRC9-27144
- plinth base
- top is 1 1/4" thick and in two sections
- anodized aluminum center console 96" long
- laminate worksurface, no charge if standard laminate is selected
- glass worksurface with reverse bevel edge, (see page [CC4](#))
- top size: 144"w x 40/60"d

View Table with Rectangular Base and Center Console	CC8JVRM-60120	60	120	29	9	2	2	424	30	\$19,369	\$29,617
---	----------------------	----	-----	----	---	---	---	-----	----	----------	----------



- short grain veneer direction
- base CC8NRC9-27120
- plinth base
- top is 1 1/4" thick and in two sections
- anodized aluminum center console 72" long
- laminate worksurface, no charge if standard laminate is selected
- glass worksurface with reverse bevel edge, (see page [CC4](#))
- top size: 120"w x 40/60"d

View Table with Rectangular Base and Center Console	CC8JVRM-6096	60	96	29	7	1	2	380	26	\$15,638	\$23,837
---	---------------------	----	----	----	---	---	---	-----	----	----------	----------



- long grain veneer direction
- base CC8NRC9-2796
- plinth base
- top is 1 1/4" thick
- anodized aluminum center console 48" long
- laminate worksurface, no charge if standard laminate is selected
- glass worksurface with reverse bevel edge, (see page [CC4](#))
- top size: 96"w x 40/60"d

To Order, Specify:

View Table

- ① Model Number
- ② Wood Species
- ③ Finish Scheme
 - A. Accent Surround - Veneer or Paint
 - B. Base Pedestal - Veneer or Paint
(see page [CC8](#) - apron follows base pedestal)
- ④ Worksurface Option
 - A. Veneer
 - B. Laminate
 - C. Glossy Low Iron White Back Painted Glass
 - D. Frosted Low Iron White Back Painted Glass
(see page [CC4](#))
- ⑤ Power and Data Options (see [accessories price list](#))
- ⑥ Other Product Options

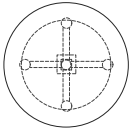
View Table with Center Console

- ① Model Number
- ② Wood Species
- ③ Finish Scheme
 - A. Accent Surround - Veneer or Paint
 - B. Base Pedestal - Veneer or Paint
(see page [CC8](#) - apron follows base pedestal)
- ④ Worksurface Option
 - A. Veneer
 - B. Laminate
 - C. Glossy Low Iron White Back Painted Glass
 - D. Frosted Low Iron White Back Painted Glass
(see page [CC4](#))
- ⑤ Power and Data Options (see [accessories price list](#))
- ⑥ Other Product Options
- ⑦ Center Console Accessories (see pages [CC86-CC87](#) - order separately)

Meeting Tables

Description	① Model	D	L	H	Seat Capacity	Top Pieces	Bases Required	CTN WT	CU FT	List Price
Solid Glass Meeting Table with Column/Disc Base	CC8JDDG-0048	48	48	29	3 to 4	1	1	175	20	\$9,322
	CC8JDDG-0042	42	42	29	3 to 4	1	1	154	19	\$8,481
	CC8JDDG-0036	36	36	29	3 to 4	1	1	136	18	\$7,703

- top is solid 1/2" tempered frosted glass underside, see page [CC9](#) for additional information
- 26" dia. disk base is Arctic Silver powder coated aluminum with veneer column



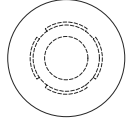
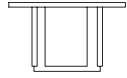
Veneer Meeting Table with Column/Disc Base	CC8JDD1-0048	48	48	29	3 to 4	1	1	150	5	\$7,832
	CC8JDD1-0042	42	42	29	3 to 4	1	1	135	4	\$7,087
	CC8JDD1-0036	36	36	29	3 to 4	1	1	122	3	\$6,315
	CC8JDD1-0030	30	30	29	3 to 4	1	1	110	3	\$5,690

- 26" dia. disk base is Arctic Silver powder coated aluminum with veneer column
- laminate worksurface, no charge if standard laminate is selected
- see page [CC9](#) for additional information



Meeting Tables

Description	① Model	D	L	H	Seat Capacity	Top Pieces	Bases Required	CTN WT	CU FT	List Price
Veneer Meeting Table with Cylinder Base	CC8JDC1-0048	48	48	29	4	1	1	141	17	\$5,561
	CC8JDC1-0042	42	42	29	4	1	1	126	16	\$5,215



- 24" dia. base has 4 accent panels
- laminate worksurface, no charge if standard laminate is selected
- drum style construction
- see page [CC9](#) for additional information

COLLECTIVE CONFERENCE

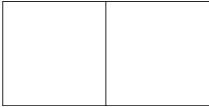
To Order, Specify:

Round Table with Column/Disc Base


- ① Model Number
- ② Wood Species
- ③ Finish Color

Round Table with Cylinder Disc


- ① Model Number
- ② Wood Species
- ③ Finish Scheme
 - A. Cylinder Base - Veneer or Paint
 - B. Accent Panel - Veneer or Paint
 (see page [CC9](#) - apron follows base pedestal)

Description	① Model	W	L	H	Seat Capacity	Top Pieces	CTN WT	CU FT	Veneer	Glass Top
Rectangular Top 	CC8CTR1-60216	60	216	1 ¼	18	2	460	25	\$16,494	\$36,110
	CC8CTR1-60192	60	192	1 ¼	16	2	409	23	\$14,361	\$31,796
	CC8CTR1-60168	60	168	1 ¼	14	2	358	20	\$12,289	\$27,544
	CC8CTR1-60144	60	144	1 ¼	10	2	308	17	\$10,293	\$23,368


- short grain veneer direction
- top is 1 ¼" thick and in two sections
- laminate worksurface, no charge if standard laminate is selected
- glass worksurface with reverse bevel edge, (see page [CC4](#))
- aluminum edge available, specify and add \$7,081 list for CC8CTR1-60216, \$6,467 list for CC8CTR1-60192, \$5,853 list for CC8CTR1-60168 and \$5,236 list for CC8CTR1-60144

Rectangular Top 	CC8CTR1-48216	48	216	1 ¼	16	2	370	21	\$12,693	\$28,387
	CC8CTR1-48192	48	192	1 ¼	14	2	330	18	\$11,038	\$24,986
	CC8CTR1-48168	48	168	1 ¼	13	2	289	16	\$9,463	\$21,667
	CC8CTR1-48144	48	144	1 ¼	8	2	248	14	\$7,930	\$18,391
	CC8CTR1-48120	48	120	1 ¼	6	2	207	11	\$6,442	\$14,640

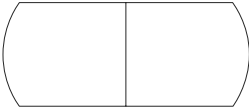
- short grain veneer direction
- top is 1 ¼" thick and in two sections
- laminate worksurface, no charge if standard laminate is selected
- glass worksurface with reverse bevel edge, (see page [CC4](#))
- aluminum edge available, specify and add \$6,775 list for CC8CTR1-48216, \$6,160 list for CC8CTR1-48192, \$5,546 list for CC8CTR1-48168, \$4,928 list for CC8CTR1-48144 and \$4,313 list for CC8CTR1-48120

Rectangular Top 	CC8CTR1-4896	48	96	1 ¼	6	1	160	9	\$4,716	\$11,276
---	---------------------	----	----	-----	---	---	-----	---	---------	----------


- long grain veneer direction
- top is 1 ¼" thick
- laminate worksurface, no charge if standard laminate is selected
- glass worksurface with reverse bevel edge, (see page [CC4](#))
- aluminum edge available, specify and add \$3,699 list for CC8CTR1-4896

Rectangular Top 	CC8CTR1-4284	42	84	1 ¼	4	1	123	7	\$3,429	\$8,451
	CC8CTR1-3672	36	72	1 ¼	4	1	91	5	\$2,528	\$6,216


- long grain veneer direction
- top is 1 ¼" thick
- laminate worksurface, no charge if standard laminate is selected
- glass worksurface with reverse bevel edge, (see page [CC4](#))
- aluminum edge available, specify and add \$3,237 list for CC8CTR1-4284 and \$2,775 list for CC8CTR1-3672

Description	① Model	W	L	H	Seat Capacity	Top Pieces	CTN WT	CU FT	Veneer	Glass Top
Arc End Top 	CC8CTA1-60216	60	216	1 ¼	16	2	460	25	\$17,462	\$37,078
	CC8CTA1-60192	60	192	1 ¼	14	2	409	23	\$15,203	\$32,641
	CC8CTA1-60168	60	168	1 ¼	12	2	358	20	\$13,011	\$28,268
	CC8CTA1-60144	60	144	1 ¼	10	2	308	17	\$10,892	\$23,969


- short grain veneer direction
- top is 1 ¼" thick and in two sections
- laminate worksurface, no charge if standard laminate is selected
- glass worksurface with reverse bevel edge, (see page [CC4](#))

Arc End Top 	CC8CTA1-48216	48	216	1 ¼	16	2	370	21	\$13,402	\$29,096
	CC8CTA1-48192	48	192	1 ¼	14	2	330	18	\$11,687	\$25,635
	CC8CTA1-48168	48	168	1 ¼	12	2	289	16	\$10,019	\$22,222
	CC8CTA1-48144	48	144	1 ¼	8	2	248	14	\$8,396	\$18,858
	CC8CTA1-48120	48	120	1 ¼	6	2	207	11	\$6,817	\$15,015

- short grain veneer direction
- top is 1 ¼" thick and in two sections
- laminate worksurface, no charge if standard laminate is selected
- glass worksurface with reverse bevel edge, (see page [CC4](#))

Arc End Top 	CC8CTA1-4896	48	96	1 ¼	6	1	160	9	\$4,990	\$11,547
--	---------------------	----	----	-----	---	---	-----	---	---------	----------

- long grain veneer direction
- top is 1 ¼" thick
- laminate worksurface, no charge if standard laminate is selected
- glass worksurface with reverse bevel edge, (see page [CC4](#))

Arc End Top 	CC8CTA1-4284	42	84	1 ¼	4	1	123	7	\$3,626	\$8,650
	CC8CTA1-3672	36	72	1 ¼	6	1	91	5	\$2,670	\$6,359

- long grain veneer direction
- top is 1 ¼" thick
- laminate worksurface, no charge if standard laminate is selected
- glass worksurface with reverse bevel edge, (see page [CC4](#))

To Order, Specify:

Rectangular Top


- ① Model Number
- ② Wood Species
- ③ Finish Color
- ④ Edge Detail
 - A. Straight
 - B. Aluminum Trim
- ⑤ Worksurface Option
 - A. Veneer
 - B. Laminate
 - C. Glossy Low Iron White Back Painted Glass
 - D. Frosted Low Iron White Back Painted Glass
 (see page [CC4](#))
- ⑥ Power and Data Options (see [accessories price list](#))
- ⑦ Other Product Options

Arc Top


- ① Model Number
- ② Wood Species
- ③ Finish Color
- ④ Worksurface Option
 - A. Veneer
 - B. Laminate
 - C. Glossy Low Iron White Back Painted Glass
 - D. Frosted Low Iron White Back Painted Glass
 (see page [CC4](#))
- ⑤ Power and Data Options (see [accessories price list](#))
- ⑥ Other Product Options

Collective Conference




Description	Model	W	L	H	Seat Capacity	Top Pieces	CTN WT	CU FT	Veneer	Glass Top
	CC8CT01-60216	60	216	1 ¼	18	2	435	25	\$17,789	\$37,404
	CC8CT01-60192	60	192	1 ¼	16	2	384	23	\$15,485	\$32,920
	CC8CT01-60168	60	168	1 ¼	14	2	333	20	\$13,253	\$28,508
	CC8CT01-60144	60	144	1 ¼	10	2	283	17	\$11,093	\$24,169


- short grain veneer direction
- top is 1 ¼" thick and in two sections
- laminate worksurface, no charge if standard laminate is selected
- glass worksurface with reverse bevel edge, (see page [CC4](#))

	CC8CT01-48216	48	216	1 ¼	16	2	363	21	\$13,650	\$29,344
	CC8CT01-48192	48	192	1 ¼	14	2	314	18	\$11,900	\$25,849
	CC8CT01-48168	48	168	1 ¼	12	2	281	16	\$10,203	\$22,409
	CC8CT01-48144	48	144	1 ¼	8	2	232	14	\$8,547	\$19,011
	CC8CT01-48120	48	120	1 ¼	6	2	191	11	\$6,944	\$15,144

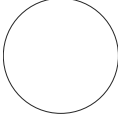
- short grain veneer direction
- top is 1 ¼" thick and in two sections
- laminate worksurface, no charge if standard laminate is selected
- glass worksurface with reverse bevel edge, (see page [CC4](#))

	CC8CT01-4896	48	96	1 ¼	6	1	135	9	\$5,077	\$11,637
--	---------------------	----	----	-----	---	---	-----	---	---------	----------

- long grain veneer direction
- top is 1 ¼" thick
- laminate worksurface, no charge if standard laminate is selected
- glass worksurface with reverse bevel edge, (see page [CC4](#))


	CC8CT01-4284	42	84	1 ¼	4	1	110	7	\$3,691	\$8,712
	CC8CT01-3672	36	72	1 ¼	4	1	82	5	\$2,719	\$6,407

- long grain veneer direction
- top is 1 ¼" thick
- laminate worksurface, no charge if standard laminate is selected
- glass worksurface with reverse bevel edge, (see page [CC4](#))


	CC8CTD1-0048	48	48	1 ¼	4	1	81	5	\$4,721	\$7,999
	CC8CTD1-0042	42	42	1 ¼	4	1	62	4	\$4,340	\$6,850

- short grain veneer direction
- top is 1 ¼" thick
- laminate worksurface, no charge if standard laminate is selected
- glass worksurface with reverse bevel edge, (see page [CC4](#))


COLLECTIVE CONFERENCE

Description	① Model	W	L	H	Seat Capacity	Top Pieces	CTN WT	CU FT	Veneer	Glass Top
Boat Shape Top 	CC8CTB1-60216	38/60	216	1 ¼	18	2	460	25	\$16,538	\$36,156
	CC8CTB1-60192	38/60	192	1 ¼	16	2	409	23	\$14,516	\$31,952
	CC8CTB1-60168	36/60	168	1 ¼	14	2	358	20	\$12,439	\$27,695

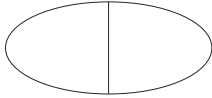
- short grain veneer direction
- top is 1 ¼" thick and in two sections
- laminate worksurface, no charge if standard laminate is selected
- glass worksurface with reverse bevel edge, (see page [CC4](#))

Boat Shape Top 	CC8CTB1-48144	36/48	144	1 ¼	8	2	248	14	\$10,437	\$20,901
	CC8CTB1-48120	36/48	120	1 ¼	6	2	207	11	\$8,487	\$16,683


- short grain veneer direction
- top is 1 ¼" thick and in two sections
- laminate worksurface, no charge if standard laminate is selected
- glass worksurface with reverse bevel edge, (see page [CC4](#))

Boat Shape Top 	CC8CTB1-4896	34/48	96	1 ¼	6	1	160	9	\$6,235	\$12,794
--	---------------------	-------	----	-----	---	---	-----	---	---------	----------

- long grain veneer direction
- top is 1 ¼" thick
- laminate worksurface, no charge if standard laminate is selected
- glass worksurface with reverse bevel edge, (see page [CC4](#))

Ellipse Shape Top 	CC8CTE1-60144	60	144	1 ¼	10	2	238	17	\$14,807	\$27,883
	CC8CTE1-54120	54	120	1 ¼	8	2	181	13	\$9,515	\$18,866

- short grain veneer direction
- top is 1 ¼" thick and in two sections
- laminate worksurface, no charge if standard laminate is selected
- glass worksurface with reverse bevel edge, (see page [CC4](#))

Ellipse Shape Top 	CC8CTE1-4896	48	96	1 ¼	6	2	123	9	\$7,020	\$13,580
---	---------------------	----	----	-----	---	---	-----	---	---------	----------

- long grain veneer direction
- top is 1 ¼" thick
- laminate worksurface, no charge if standard laminate is selected
- glass worksurface with reverse bevel edge, (see page [CC4](#))

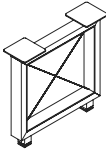
To Order, Specify:

- ① Model Number
- ② Wood Species
- ③ Finish Color
- ④ Worksurface Option
 - A. Veneer
 - B. Laminate
 - C. Glossy Low Iron White Back Painted Glass
 - D. Frosted Low Iron White Back Painted Glass (see page [CC4](#))
- ⑤ Power and Data Options (see [accessories price list](#))
- ⑥ Other Product Options

Collective Conference

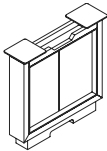
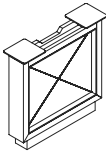


Description	D	W	H	CTN WT	CU FT	① Model	List Price
Open Cable Base	3½	27	27⅞	67	3	CC8NCO1-0427	\$4,717
	3½	23	27⅞	57	57	CC8NCO1-0423	\$4,195



- X-shaped stainless steel cable accent
- wood surround
- Silver powder coated inner metal frame
- telescopic feet are anodized aluminum
- not for use with 60"d tops

Closed Cable Base	5	27	27⅞	77	4	CC8NCC1-0527	\$5,583
	5	23	27⅞	67	3	CC8NCC1-0523	\$5,206

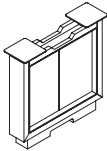
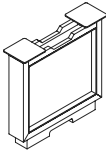


side 1

side 2

- X-shaped stainless steel cable accent
- wood surround
- Silver powder coated inner metal frame
- wood panel one side; hinged doors with 3" opening on top for wire management and touch latch
- not for use with 60"d tops

Closed Cable Middle Base	5	27	15¾	86	4	CC8NCM1-0527	\$4,147
--------------------------	---	----	-----	----	---	--------------	---------

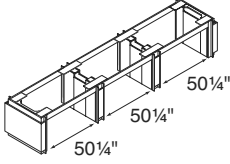
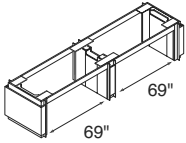
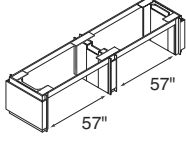
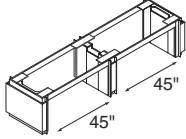


side 1

side 2

- wood surround
- Silver powder coated inner metal frame
- wood panel one side; hinged doors with 3" opening on top for wire management and touch latch
- plinth base with cut-out in bottom 2" x 6"
- not for use with 60"d tops

COLLECTIVE CONFERENCE

Description	D	W	H	CTN WT	CU FT	① Model	List Price
32" Panel Base with Apron Rails and Center Bases 	32 1/4	174	27 3/4	398	20	CC8NPC2-32174	\$17,703
<ul style="list-style-type: none"> use with 216" x 60" table top anodized aluminum trim hinged doors one side with touch latch; outside bases have 3" opening on top of hinged door side for wire management; middle bases have 3" opening on top both sides for wire management adjustable glides arc or flat panel front - add \$692 for arc end panel front, arc only on outside panels 							
32" Panel Base with Apron Rails and Center Base 	32 1/4	156	27 3/4	301	15	CC8NPC2-32156	\$12,021
<ul style="list-style-type: none"> use with 192" x 60" table top anodized aluminum trim hinged doors one side with touch latch; outside bases have 3" opening on top of hinged door side for wire management; middle bases have 3" opening on top both sides for wire management adjustable glides arc or flat panel front - add \$692 for arc end panel front, arc only on outside panels 							
32" Panel Base with Apron Rails and Center Base 	32 1/4	132	27 3/4	298	15	CC8NPC2-32132	\$11,664
<ul style="list-style-type: none"> use with 168" x 60" table top anodized aluminum trim hinged doors one side with touch latch; outside bases have 3" opening on top of hinged door side for wire management; middle bases have 3" opening on top both sides for wire management adjustable glides arc or flat panel front - add \$692 for arc end panel front, arc only on outside panels 							
32" Panel Base with Apron Rails and Center Base 	32 1/4	108	27 3/4	295	15	CC8NPC2-32108	\$11,123
<ul style="list-style-type: none"> use with 144" x 60" table top anodized aluminum trim hinged doors one side with touch latch; outside bases have 3" opening on top of hinged door side for wire management; middle bases have 3" opening on top both sides for wire management adjustable glides arc or flat panel front - add \$692 for arc end panel front, arc only on outside panels 							

To Order, Specify:

Open Cable Base

- ① Model Number
- ② Wood Species
- ③ Finish Color
- ④ Other Product Options

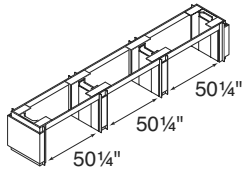
Closed Cable Base

- ① Model Number
- ② Wood Species
- ③ Finish Scheme
 - A. Outer Frame & Plinth - Veneer only
 - B. Inner Panel/Door - Veneer or Paint
 (see page [CC7](#))
- ④ Other Product Options

Panel Base with Apron Rails and Center Bases

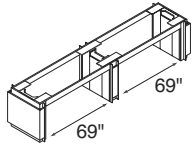
- ① Model Number
- ② Wood Species
- ③ Base Front Panel
 - A. Arc
 - B. Flat
 (see page [CC8](#))
- ④ Finish Scheme
 - A. Outer Frame & Plinth - Veneer only
 - B. Inner Panel/Door - Veneer or Paint
 (see page [CC8](#))
- ④ Other Product Options

Description	D	W	H	CTN WT	CU FT	① Model	List Price
27" Panel Base with Apron Rails and Center Bases	27 ¼	174	27 ¾	365	16	CC8NPC2-27174	\$10,987



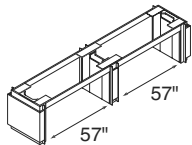
- use with 216" x 48" table top
- anodized aluminum trim
- hinged doors one side with touch latch; outside bases have 3" opening on top of hinged door side for wire management; middle bases have 3" opening on top both sides for wire management
- adjustable glides
- arc or flat panel front - add \$692 for arc end panel front, arc only on outside panels

27" Panel Base with Apron Rails and Center Base	27 ¼	156	27 ¾	279	12	CC8NPC2-27156	\$11,084
---	------	-----	------	-----	----	---------------	----------



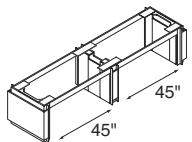
- use with 192" x 48" table top
- anodized aluminum trim
- hinged doors one side with touch latch; outside bases have 3" opening on top of hinged door side for wire management; middle base has 3" opening on top both sides for wire management
- adjustable glides
- arc or flat panel front - add \$692 for arc end panel front, arc only on outside panels

27" Panel Base with Apron Rails and Center Base	27 ¼	132	27 ¾	276	12	CC8NPC2-27132	\$10,657
---	------	-----	------	-----	----	---------------	----------



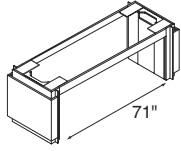
- use with 168" x 48" table top
- anodized aluminum trim
- hinged doors one side with touch latch; outside bases have 3" opening on top of hinged door side for wire management; middle base has 3" opening on top both sides for wire management
- adjustable glides
- arc or flat panel front - add \$692 for arc end panel front, arc only on outside panels

27" Panel Base with Apron Rails and Center Base	27 ¼	108	27 ¾	274	12	CC8NPC2-27108	\$10,491
---	------	-----	------	-----	----	---------------	----------



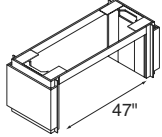
- use with 144" x 48" table top
- anodized aluminum trim
- hinged doors one side with touch latch; outside bases have 3" opening on top of hinged door side for wire management; middle base has 3" opening on top both sides for wire management
- adjustable glides
- arc or flat panel front - add \$692 for arc end panel front, arc only on outside panels

Description	D	W	H	CTN WT	CU FT	① Model	List Price
27" Panel Base with Apron Rails	27 1/4	84	27 3/4	187	8	CC8NPC2-2784	\$5,579



- use with 120" x 48" table top
- anodized aluminum trim
- hinged doors one side with touch latch; 3" opening on top of hinged door side for wire management
- adjustable glides
- arc or flat panel front - add \$692 for arc end panel front, arc only on outside panels

27" Panel Base with Apron Rails	27 1/4	60	27 3/4	184	8	CC8NPC2-2760	\$5,411
---------------------------------	--------	----	--------	-----	---	--------------	---------

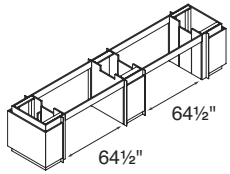


- use with 96" x 48" table top
- anodized aluminum trim
- hinged doors one side with touch latch; 3" opening on top of hinged door side for wire management
- adjustable glides
- arc or flat panel front - add \$692 for arc end panel front, arc only on outside panels

To Order, Specify:

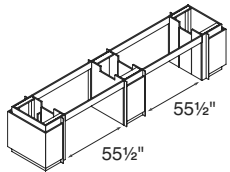
- ① Model Number
- ② Wood Species
- ③ Base Front Panel
 - A. Arc
 - B. Flat
 (see page [CC8](#))
- ④ Finish Scheme
 - A. Outer Frame & Plinth - veneer only
 - B. Inner Panel/Door - Veneer or Paint
 (see page [CC8](#))
- ④ Other Product Options

Description	D	W	H	CTN WT	CU FT	① Model	List Price
27" Rectangular Base with Apron Rails and Center Base	27 ¼	174	27 ¾	354	15	CC8NRC2-27174	\$15,585



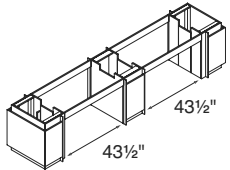
- use with 216" x 60" table top
- anodized aluminum trim
- hinged doors one side with touch latch; outside bases have 3" opening on top of hinged door side for wire management; middle base has 3" opening on top both sides for wire management
- adjustable glides

27" Rectangular Base with Apron Rails and Center Base	27 ¼	156	27 ¾	352	15	CC8NRC2-27156	\$11,898
---	------	-----	------	-----	----	---------------	----------



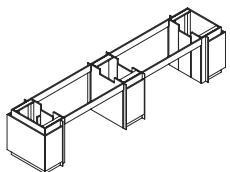
- use with 192" x 60" table top
- anodized aluminum trim
- hinged doors one side with touch latch; outside bases have 3" opening on top of hinged door side for wire management; middle base has 3" opening on top both sides for wire management
- adjustable glides

27" Rectangular Base with Apron Rails and Center Base	27 ¼	132	27 ¾	350	15	CC8NRC2-27132	\$11,732
---	------	-----	------	-----	----	---------------	----------



- use with 168" x 60" table top
- anodized aluminum trim
- hinged doors one side with touch latch; outside bases have 3" opening on top of hinged door side for wire management; middle base has 3" opening on top both sides for wire management
- adjustable glides

27" Rectangular Base with Apron Rails and Center Base	27 ¼	108	27 ¾	347	15	CC8NRC2-27108	\$11,565
---	------	-----	------	-----	----	---------------	----------

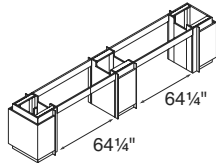


- use with 144" x 60" table top
- anodized aluminum trim
- hinged doors one side with touch latch; outside bases have 3" opening on top of hinged door side for wire management; middle base has 3" opening on top both sides for wire management
- adjustable glides

COLLECTIVE CONFERENCE

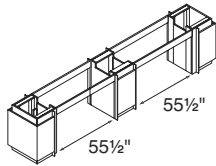
Description	D	W	H	CTN WT	CU FT	① Model	List Price
-------------	---	---	---	--------	-------	---------	------------

21" Rectangular Base with Apron Rails and Center Base



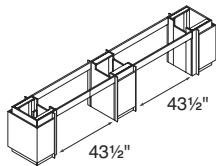
- use with 216" x 48" table top
- anodized aluminum trim
- hinged doors one side with touch latch; outside bases have 3" opening on top of hinged door side for wire management; middle base has 3" opening on top both sides for wire management
- adjustable glides

21" Rectangular Base with Apron Rails and Center Base



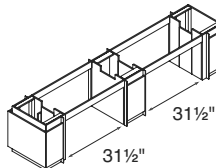
- use with 192" x 48" table top
- anodized aluminum trim
- hinged doors one side with touch latch; outside bases have 3" opening on top of hinged door side for wire management; middle base has 3" opening on top both sides for wire management
- adjustable glides

21" Rectangular Base with Apron Rails and Center Base



- use with 168" x 48" table top
- anodized aluminum trim
- hinged doors one side with touch latch; outside bases have 3" opening on top of hinged door side for wire management; middle base has 3" opening on top both sides for wire management
- adjustable glides

21" Rectangular Base with Apron Rails and Center Base

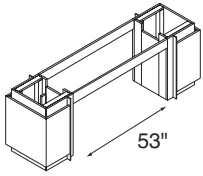


- use with 144" x 48" table top
- anodized aluminum trim
- hinged doors one side with touch latch; outside bases have 3" opening on top of hinged door side for wire management; middle base has 3" opening on top both sides for wire management
- adjustable glides

To Order, Specify:

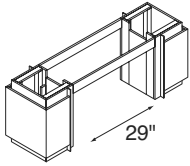
- ① Model Number
- ② Wood Species
- ③ Finish Scheme
 - A. Outer Frame & Plinth - veneer only
 - B. Inner Panel/Door - veneer or paint
 (see page [CC8](#))
- ④ Other Product Options

Description	D	W	H	CTN WT	CU FT	① Model	List Price
21" Rectangular Base with Apron Rails	21 ¼	84	27 ¾	212	10	CC8NRC2-2184	\$7,002



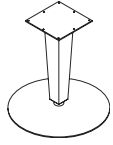
- use with 120" x 48" table top
- anodized aluminum trim
- hinged doors one side with touch latch; 3" opening on top of hinged door side for wire management
- adjustable glides

21" Rectangular Base with Apron Rails	21 ¼	60	27 ¾	208	10	CC8NRC2-2160	\$6,834
---------------------------------------	------	----	------	-----	----	--------------	---------



- use with 96" x 48" table top
- anodized aluminum trim
- hinged doors one side with touch latch; 3" opening on top of hinged door side for wire management
- adjustable glides

Description	D	W	H	CTN WT	CU FT	① Model	List Price
26" Dia. Base	26	26	27 ¾	93	13	CC8NCD1-0026	\$3,888



- 26" dia. disk base is Silver powder coated aluminum with veneer column

Cylinder Base	24	24	27 ¾	89	11	CC8NCY9-0024	\$3,940
---------------	----	----	------	----	----	--------------	---------



- 24" dia. base has 4 accent panels

To Order, Specify:

21" Rectangular Base with Apron Rails

- ① Model Number
- ② Wood Species
- ③ Finish Scheme
 - A. Outer Frame & Plinth - veneer only
 - B. Inner Panel/Door - Veneer or Paint
 (see page [CC8](#))
- ④ Other Product Options

26" Dia. Base

- ① Model Number
- ② Wood Species
- ③ Finish Color
- ④ Other Product Options

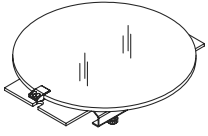
Cylinder Base

- ① Model Number
- ② Wood Species
- ③ Finish Scheme
 - A. Chassis Frame - veneer only
 - B. Accent Panel - Veneer or Paint
 (see page [CC9](#))
- ④ Other Product Options

Collective Conference

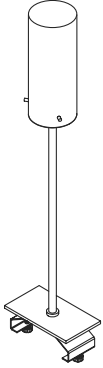


Description	D	W	H	CTN WT	CU FT	① Model	List Price
Accessory Shelf	15	16		13	2	CC9CNA1-1516	\$2,448



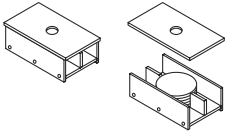
- 15" dia. glass shelf; not designed to rotate
- anodized aluminum
- frosted glass with screen print on underside

Lamp	6 ¾	4	30	10	1	CC9CNL1-0704	\$1,662
------	-----	---	----	----	---	--------------	---------



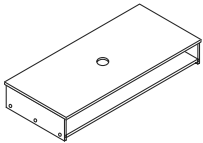
- anodized aluminum

Coaster	6 ¾	4		6	1	CC9CNC1-0704	\$1,787
---------	-----	---	--	---	---	--------------	---------



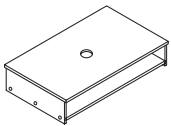
- includes (5) anodized aluminum coasters; finger lift lid

Storage	6 ¾	16	1 ¾	7	1	CC9CNS1-0716	\$1,101
---------	-----	----	-----	---	---	--------------	---------



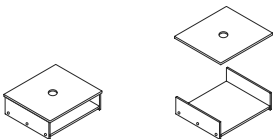
- storage - use for pens, notepads, and etc.
- anodized aluminum

Storage	6 ¾	12	1 ¾	7	1	CC9CNS1-0712	\$976
---------	-----	----	-----	---	---	--------------	-------



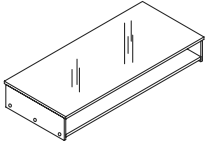
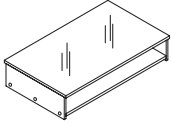
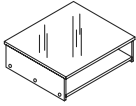
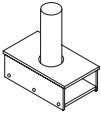
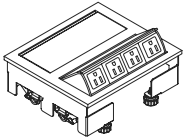
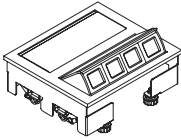
- storage - use for pens, notepads, and etc.
- anodized aluminum

Storage	6 ¾	8	1 ¾	6	1	CC9CNS1-0708	\$864
---------	-----	---	-----	---	---	--------------	-------



- storage - use for pens, notepads, and etc.
- anodized aluminum

COLLECTIVE CONFERENCE

Description	D	W	H	CTN WT	CU FT	① Model	List Price
Glass Panel  <ul style="list-style-type: none"> · glass surface; not for use as storage · anodized aluminum · frosted glass with screen print on underside 	6 ¾	16	1 ¾	7	1	CC9CNG1-0716	\$941
Glass Panel  <ul style="list-style-type: none"> · glass surface; not for use as storage · anodized aluminum · frosted glass with screen print on underside 	6 ¾	12	1 ¾	6	1	CC9CNG1-0712	\$884
Glass Panel  <ul style="list-style-type: none"> · glass surface; not for use as storage · anodized aluminum · frosted glass with screen print on underside 	6 ¾	8	1 ¾	6	1	CC9CNG1-0708	\$849
Vase  <ul style="list-style-type: none"> · 7" vase (6" visible); clear glass · anodized aluminum 	6 ¾	4		5	1	CC9CNV1-0704	\$950
Power Data Module  <p>electrical side</p>  <p>voice/data side</p> <ul style="list-style-type: none"> · anodized aluminum; one touch accessibility; (4) electrical one side; (4) voice/data ports opposite side; voice/data adapter kit; voice/data jacks & couples sold separately; 10 ft., 15 amp cord with plug; UL listed · accepts up to four type 3 telecom jacks (see page GP17) · NOTE: Use for consoles only 	7 ½	8		6	1	CC9CNE1-0708	\$1,718

To Order, Specify:

- ① Model Number

Collective Conference Tables Product Information

COLLECTIVE CONFERENCE

Collective Conference Tables Product Information

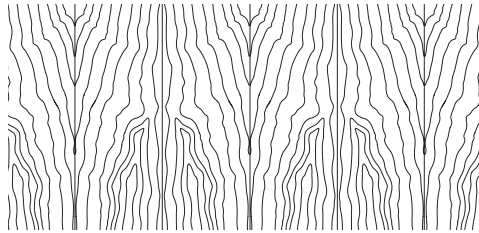


COLLECTIVE CONFERENCE

Collective Conference Tables Product Information

Exterior Wood Materials

Exterior surfaces are made from the finest selected veneers to achieve clarity and consistency in the Collective Conference Storage product line. To attain a pleasing, symmetrical pattern, all veneers in Collective Conference Storage are book-matched. All exterior solid lumber is matched to coordinate with the veneer.



Book Matched Example

Alternating pieces of veneer are flipped over so they face each other like the pages within a book

Collective Conference Storage is available in flat cut cherry, maple, and walnut veneer.

Solid painted finishes on MDF are also offered on drawer and door fronts to provide an accent to the Collective Conference Storage product.

Work Surface Construction

Tops are 3-ply balanced construction, 1½" thick with solid matching hardwood 1.5mm rims.

Matching or coordinating high pressure laminate in a veneer grain can be applied to the top surface and is available at no additional charge for some finishes.

Case Construction

Outside panels are 1¾" and joined together by mortise and tenon construction. In addition to mortise and tenon joint construction, pedestal joints are reinforced with screws, cleats, brackets and glue. Tops are secured to the chassis with top fastening cleats screwed to the inside of the panels.

Cabinet doors have 110° swing hinges to allow adequate access into the interior of the cabinet.

Leveling glides are provided in both plinth base or telescopic foot.

Extruded Aluminum Components

Telescopic Feet, Valance Rails, Tool Rails, and Spacers all are made from an alloy aluminum compound, made up of 10% post consumer scrap, 60% post industrial scrap and 30% primary aluminum. The aluminum meets or exceeds the guidelines of USGBC - LEED V2.2. The parts are precisely machined and then processed in a clear anodized finish for a natural aluminum appearance.

Fabricated or Casted Metal Components

The metal is laser cut, bended and robotically welded to the exact specifications, polished and powder coated to blend with the anodized aluminum.

Access Kneespace Panel

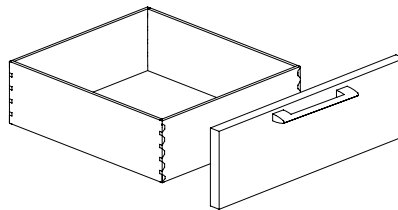
Wall stud construction style frame is made from 16-gauge steel, stamped and laser cut. Pop-riquets are used to combine frames and create various widths. Frames are coated with silver powder coat. The back is open and is designed to sit up against a wall, to allow for wiring access.

Aluminum Glass Doors

Aluminum glass doors and modesty panels have extruded aluminum frames with 4mm thick with three glass options: frosted with acid etch front, frosted low iron white back painted glass (matte) and glossy low iron white back painted glass (shiny).

Drawer Box Construction

The 9ply unidirectional hardwood sides of the drawer box are 7/16" thick assembled with English dovetail construction at each corner of the box. The drawer bottom panel is ¼" thick fitting into a groove machined into the side of the box. Interiors are sanded and coated with a clear U.V. finish to protect against shrinking, swelling or warping, and to provide a clean, smooth feel and appearance.



Drawer Suspension

The high quality black drawer suspensions carry a lifetime warranty. Slides feature steel ball bearings for longer life with cushioned in/out stops. File and box drawers have 100% full extension with over travel.

Collective Conference Tables Product Information

Locking

Credenzas feature door locking option to provide maximum security and flexibility.

Units are shipped randomly keyed as standard (units tagged in the grouping are keyed alike). Keyed alike units are available if requested at no upcharge. Removable cores for in-field re-keying are standard.

Finish - Stain/Colors

We offer a wide variety of wood stains and paint colors on the Collective Conference Storage. Please see the chart below. Samples are available upon request, through our website or by contacting Customer Service.

CH1 Cherry	<i>Flat Cut Veneer</i>	
BBM Bourbon Medium		CLL Collectors
BRM Brighton Medium		HRV Harvest
CLA Classic		PRL Praline

MA1 Maple	<i>Flat Cut Veneer</i>	
ALM Ale Medium		FLX Flax
BUT Butterscotch		VEN Venetian

WA1 Walnut	<i>Flat Cut Veneer</i>	
ESP Espresso		TRF Truffle
MCH Mocha		UMB Umber
SIE Sienna		

PNT Paint		
BKD Backdrop		GRV Greek Villa
BFX Black Fox		NET Network Gray
CGP Cargo Pants		NWH Nonchalant White
CHT Chatroom		TRC Tricorn Black
FRR French Roast		

Protective Top Coat

DuraTex™ offers exceptional hardness along with abrasion and impact resistance, it has been formulated to eliminate hazardous and harmful gases that are normally associated with wood finish.

DuraTex™ Features

Safety - Significantly reduces hazardous formaldehyde emissions which help improve the quality of the of the indoor air we breathe.

Quality - Developed to be tough and durable with special attention to appearance. The DuraTex™ finish preserves the natural beauty of wood.

Durability - Designed to meet a wide range of demanding performance and environmental standards to withstand even the highest wear and tear.

Product Modification

Laminate Tops

Work surface only, no additional upcharge if Collective's coordinating wood grain laminate is specified. Contact Customer Service for any other laminate request.

CH1 Cherry	<i>Flat Cut Veneer</i>
CLL Collectors	
HRV Harvest	
PRL Praline	

WA1 Walnut	<i>Flat Cut Veneer</i>
MCH Mocha	TRF Truffle
SIE Sienna	UMB Umber

Special Finishes

Special finishes can be requested by following the instruction in the general introduction section, page 3. There is a one time charge of \$372 list per order.

Finish Sheen

All veneer finishes, for Collective, are standard in 35-sheen. All other finishes can have their sheen modified with a 15% upcharge added to the list price of each item.

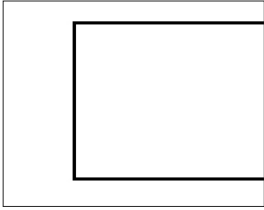
Species Change

For species changes contact customer service for a quote.

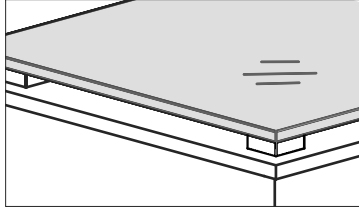
Collective Conference Tables Product Information

Edge Profile Hardware

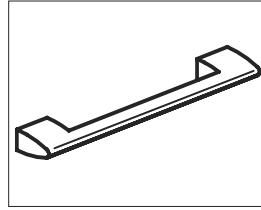
Collective Conference Storage utilizes a clean cut straight edge profile with a 1.5mm veneer rim. The Elite hardware is made of anodized aluminum. Longer versions of pull are available for other applications



Straight Edge Profile



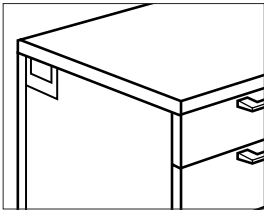
Floating Frosted Glass Top - screen print film
(wood sub-top with aluminum spacers)



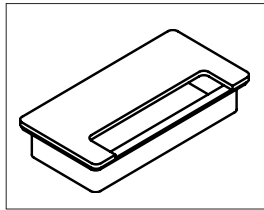
Elite Pull (PK)
Anodized Aluminum Finish

End Panel Grommet

Collective Conference Storage credenzas feature a brushed stainless steel 4" x 2" end panel grommet to allow for wire management. The end panel grommet is optional on other items; see pricing pages for more information.



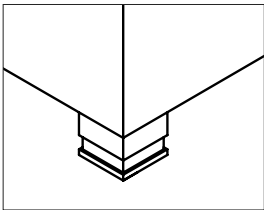
Grommet Location



Grommet (G7C)
Brush Stainless Steel

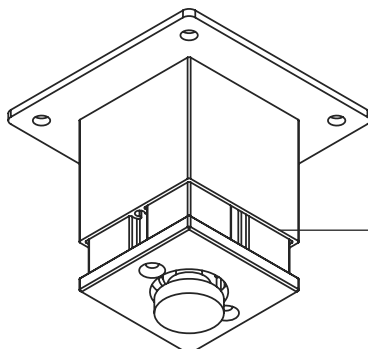
Foot/Plinth Style Base

The Collective Conference Storage features an anodized aluminum foot. Plinth base feature is not available on conference storage product, so adequate ventilation can be achieved for technology.



Foot Style
Anodized Aluminum Finish

Foot Leveling Details

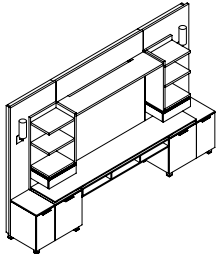


Telescopic cover can slide up to provide access for adjustment

Collective Conference Tables Product Information

Wall Options

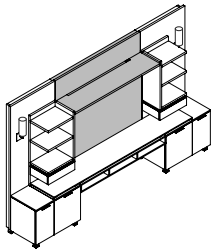
Collective Conference Storage addresses today's information and presentation environments. Collective Conference Storage consists of modular components, Media Walls to build various technology applications. Walls require specification of left and right end panels or towers, and a center wall panel to complete a configuration.



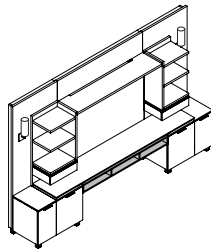
Media Wall

Media Wall Components

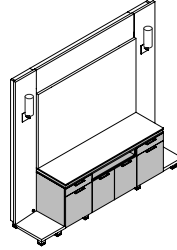
The Media Wall supports technology applications to support large screen viewing and interactive video conferencing. The Media Wall creates 86" and 71" heights and includes a center wall panel, technology niche storage with back panel, technology credenza, end towers, glass and wood tops. Panels and towers are always wall mounted.



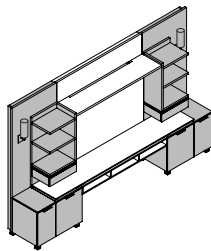
Center Wall Panel



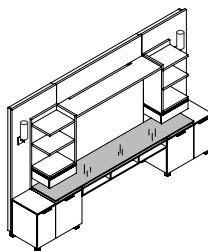
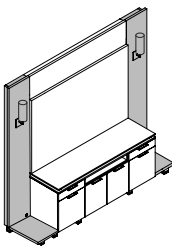
Technology Console



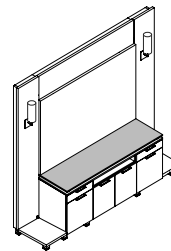
Technology Credenza



End Towers



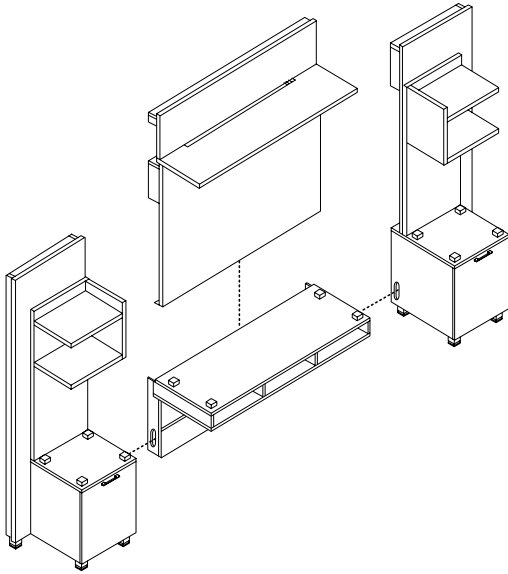
Glass and Wood Tops



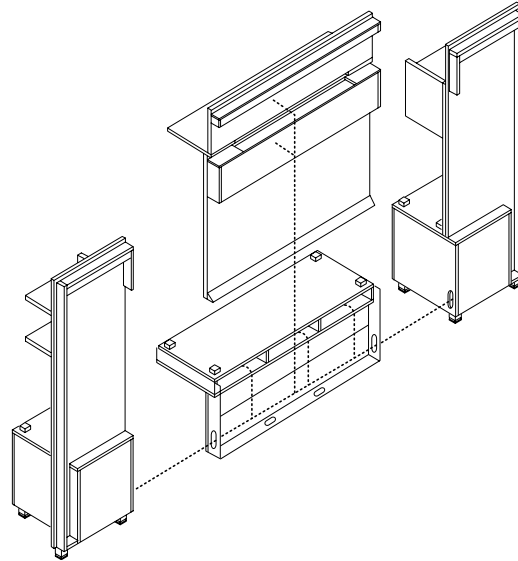
Collective Conference Tables Product Information

Center Access Panel

The Media Wall below shows how wires feed down the center wall panel into the technology niche storage with access panel and out to the end towers.



Media Wall with Technology Cubby
(Front View)

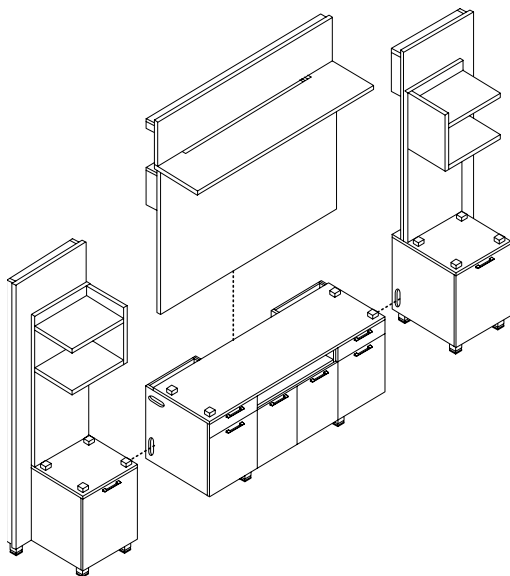


Media Wall with Technology Cubby
(Back View)

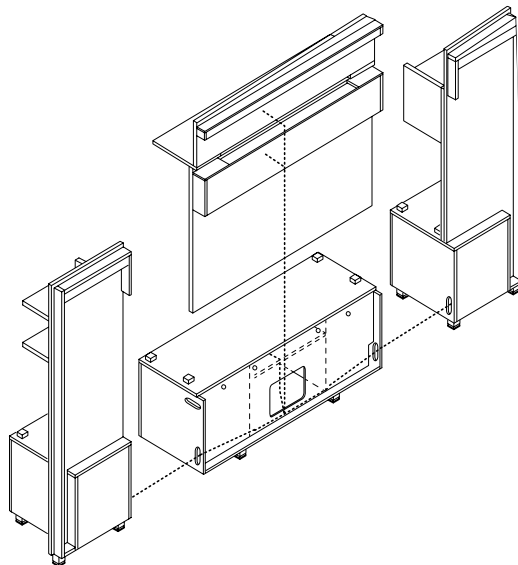
COLLECTIVE CONFERENCE

Center Technology Credenza

The diagram below shows the Media Wall with wire management routed down the center wall panel into the technology credenza and out to the end towers.



Media Wall with Technology Credenza
(Front View)

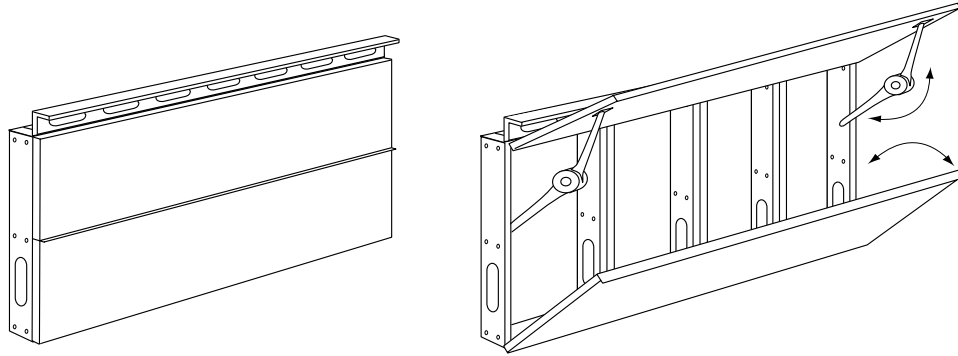


Media Wall with Technology Credenza
(Front View)

Collective Conference Tables Product Information

Access Panel Wiring

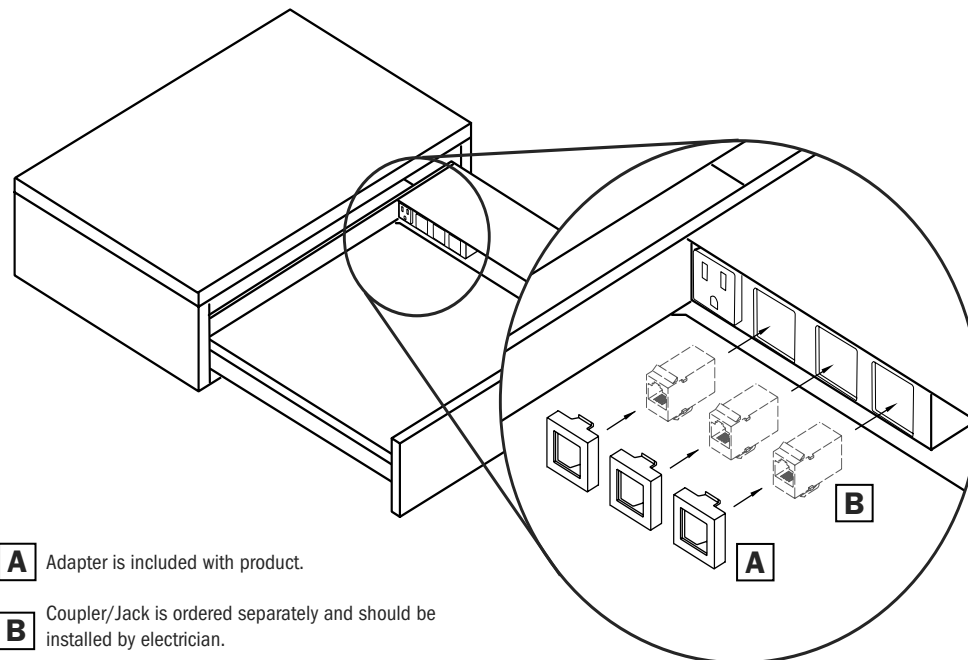
The access panel consist of two hinged panels with a lid stay mechanism on upper panel. The panel allows access to building power and communication and features concealed lay-in cable channel, and optional modular power distribution system.



Installation of the Data Adapter Kit & Base Plate

1. Select the appropriate adapter.
2. Snap jack into adapter following the instructions provided with the jack.
3. Once assembled, snap adapter into the notched, square holes in the orientation shown.
4. If provided, snap adapter into any 1 $\frac{3}{8}$ " x 2 $\frac{3}{4}$ " opening.

Note: Verify fit of jack in adapter before ordering large quantities as manufacturer designs may change without notice.



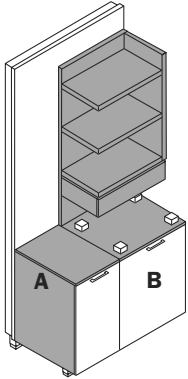
A Adapter is included with product.

B Coupler/Jack is ordered separately and should be installed by electrician.

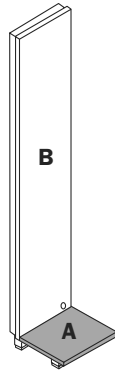
Collective Conference Tables Product Information

Material Options and Finish Schemes

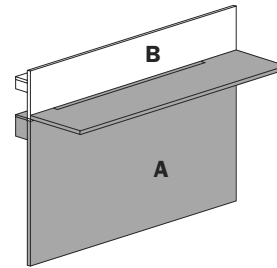
Collective Conference Storage uses a mix of materials: paint, veneer, and aluminum. Veneer choices are cherry, maple, and walnut. Eleven paint colors are available; see page [CC91](#). Wood worksurface tops or rims on laminate worksurface top, are available in veneer finishes only.



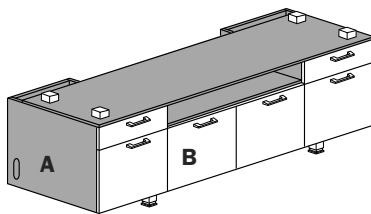
Media Wall End Tower



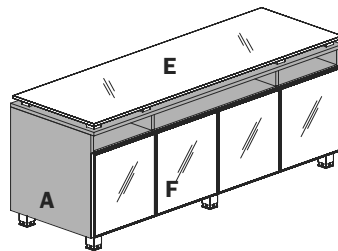
Media Wall Speaker Tower



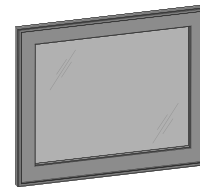
Media Wall Center Wall Panel



Media Wall Technology Credenza



Freestanding Media Credenza



Aluminum Frame Door with
 Frosted Tempered Glass
 Frosted Bright White Back Painted Glass (matte)
 Glossy Frosted Bright White Back Painted Glass (shiny)

(clear anodized aluminum frame)

Material Key

- A veneer finish only
- B veneer or paint
- C fabric tackable surface (aluminum tool rail between panels)
- D dry erase marker board (marker/eraser tray)
- E frosted glass top - screen print film
- F aluminum frame glass doors

COLLECTIVE CONFERENCE

Collective Conference Tables Product Information

Finish and Product Reference Codes

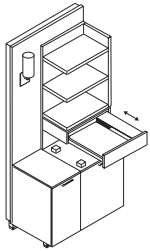
Select	Code	Select	Code	Select	Code
Veneer		Walnut Finishes		Laminate Coordinates	
Cherry Flat Cut	CH1	Espresso	ESP	Cherry Wood Grain Patterns	
Maple Flat Cut	MA1	Mocha	MCH	Collectors	CLL
Walnut Flat Cut	WA1	Sienna	SIE	Harvest	HRV
		Truffle	TRF	Praline	PRL
		Umber	UMB		
Finish		Paint Finishes		Walnut Wood Grain Patterns	
Cherry		Backdrop	BKD	Mocha	MCH
Bourbon Medium	BBM	Black Fox	BFX	Sienna	SIE
Brighton Medium	BRM	Bright White	BWH	Truffle	TRF
Classic	CLA	Cargo Pants	CGP	Umber	UMB
Collectors	CLL	Chatroom	CHT		
Harvest	HRV	French Roast	FRR	Metal Finish	
Praline	PRL	Greek Villa	GRV	Arctic Silver	ASL
		Network Gray	NET	Anodized Clear Aluminum	AAL
Maple Finishes		Nonchalant White	NWH		
Ale Medium	ALM	Storm	STM		
Butterscotch	BUT	Tricorn Black	TRC		
Flax	FLX				
Venetian	VEN				

Order Check List:

Specify:

- 1. Model Number
- 2. Finish Scheme/Color (see page [CC96](#))
- 3. Wood Species - cherry - maple - walnut
- 4. Top Options - standard veneer - laminate surface (see page [CC91](#))
- 5. Other Product Options
- 6. Power and Data Accessories (*drawing showing location and orientation must accompany order*)
- 7. Side Mark Information (*i.e. room number, East Conference Room*)
- 8. Shipping Address (*contact name and phone number*)
- 9. Special Delivery Instructions (*i.e. call before delivery, deliver to job site*)

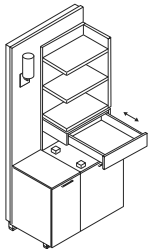
Description	D	W	H	CTN WT	CU FT	① Model	List Price
86" h Storage Tower with Laptop Drawer	24	34 1/2	86 1/4	316	48	MDOQDTAR-2435	\$11,160
	24	34 1/2	86 1/4	316	48	MDOQDTAL-2435	\$11,160



left shown with optional sconce

- use with 18 1/2" d top
- three open fixed shelves
- laptop drawer with power port
- three blanks (for future data use)
- two adapter kits to fit coupler/jacks
- aluminum spacers included
- 20 1/2" w storage compartment with one adjustable shelf and cut-out for wall access
- 14" w storage compartment with a concealed storage drawer
- wire management cut-out in pedestal opposite door hinge
- telescopic feet
- locking doors available, specify and add \$284 list
- pull-out shelf in large compartment available, specify and add \$330 list
- wall sconce available, specify and add \$468 list

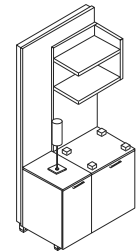
86" h Storage Tower with Drawer	24	34 1/2	86 1/4	304	48	MDOQDTBR-2435	\$10,215
	24	34 1/2	86 1/4	304	48	MDOQDTBL-2435	\$10,215



left shown with optional sconce

- use with 18 1/2" d top
- three open fixed shelves and drawer
- aluminum spacers included
- 20 1/2" w storage compartment with one adjustable shelf and cut-out for wall access
- 14" w storage compartment with a concealed storage drawer
- wire management cut-out in pedestal opposite door hinge
- telescopic feet
- locking doors available, specify and add \$284 list
- pull-out shelf in large compartment available, specify and add \$330 list
- wall sconce available, specify and add \$468 list

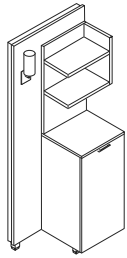
86" h Storage Tower	24	34 1/2	86 1/4	273	48	MDOQDT1R-2435	\$8,722
	24	34 1/2	86 1/4	273	48	MDOQDT1L-2435	\$8,722



left shown with optional lamp

- use with 18 1/2" d top
- two open fixed shelves and drawer
- aluminum spacers included
- 20 1/2" w storage compartment with one adjustable shelf and cut-out for wall access
- 14" w storage compartment with a concealed storage drawer
- wire management cut-out in pedestal opposite door hinge
- telescopic feet
- locking doors available, specify and add \$284 list
- pull-out shelf in large compartment available, specify and add \$330 list
- credenza lamp available, specify and add \$538 list

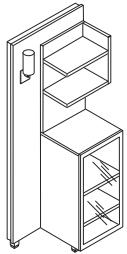
Description	D	W	H	CTN WT	CU FT	① Model	List Price
86" h Wood Door Storage Tower	24	34 ½	86 ¼	247	48	MDOQTT1R-2435	\$9,753
	24	34 ½	86 ¼	247	48	MDOQTT1L-2435	\$9,753



left shown with optional sconce

- two open fixed shelves
- storage compartment with two adjustable shelves and cut-out for wall access
- wire management cut-out in pedestal opposite door hinge
- telescopic feet
- locking door available, specify and add \$142 list
- pull-out shelf in closed compartment available, specify and add \$330 list
- wall sconce available, specify and add \$468 list

86" h Glass Door Storage Tower	24	34 ½	86 ¼	244	48	MDOQTTGR-2435	\$9,500
	24	34 ½	86 ¼	244	48	MDOQTTGL-2435	\$9,500



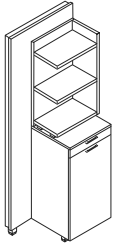
left shown with optional sconce

- two open fixed shelves
- glass door is touch latch
- storage compartment with two adjustable shelves and cut-out for wall access
- telescopic feet
- locking not available
- pull-out shelf in closed compartment available, specify and add \$330 list
- wall sconce available, specify and add \$468 list

To Order, Specify:

- ① Model Number
- ② Wood Species on Top/Chassis/Shelves -
Cherry (CH1), Maple (MA1) or Walnut (WA1)
(see page [CC91](#))
- ③ Finish Color for Top/Chassis/Shelves (see page [CC96](#))
- ④ Finish Color for Back Panel and Door Fronts
 - A. Same as Top
 - B. Paint Color (see page [CC91](#))
- ⑤ Glass Door Option (see page [CC96](#))

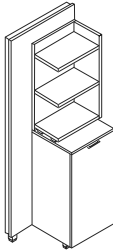
Description	D	W	H	CTN WT	CU FT	① Model	List Price
86"h Refreshment/Storage Tower	24	30	86 ¼	268	41	MDOQRT1R-2430	\$9,171
	24	30	86 ¼	268	41	MDOQRT1L-2430	\$9,171



left shown

- three open fixed shelves
- aluminum spacers included
- storage drawer
- storage compartment with cut-out for ventilation or wall access
- wire management cut-out in pedestal opposite door hinge
- telescopic feet
- locking door available, specify and add \$142 list
- open interior space: 22 ½"d x 22 ½"w x 31"h

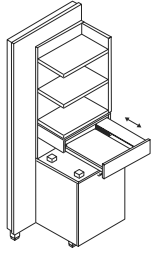
86"h Garage Tower	24	30	86 ¼	254	42	MDOQGT1R-2430	\$8,092
	24	30	86 ¼	254	42	MDOQGT1L-2430	\$8,092



left shown

- three open fixed shelves
- aluminum spacers included
- stores mobile technology cart, see page [CC115](#) (order separately)
- wire management cut-out in pedestal opposite door hinge
- telescopic feet
- locking door available, specify and add \$142 list
- open bottom: 20 ¾"d x 17"w

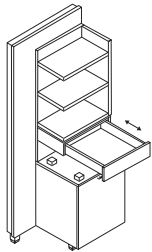
Description	D	W	H	CTN WT	CU FT	① Model	List Price
86" h Storage Tower with Laptop Drawer	24	26 ½	86 ¼	239	37	MDOQSTAR-2427	\$8,791
	24	26 ½	86 ¼	239	37	MDOQSTAL-2427	\$8,791



left shown

- use with 18 ½" d top
- three open fixed shelves
- laptop drawer with power port
- three blanks (for future data use)
- two adaptor kits to fit coupler/jacks
- aluminum spacers included
- 20 ½" w storage compartment with one adjustable shelf and cut-out for wall access
- wire management cut-out in pedestal opposite door hinge
- telescopic feet
- locking door available, specify and add \$142 list
- pull-out shelf in closed compartment available, specify and add \$330 list

86" h Storage Tower with Drawer	24	26 ½	86 ¼	239	37	MDOQSTBR-2427	\$7,844
	24	26 ½	86 ¼	239	37	MDOQSTBL-2427	\$7,844



left shown

- use with 18 ½" d top
- three open fixed shelves and drawer
- aluminum spacers included
- 20 ½" w storage compartment with one adjustable shelf and cut-out for wall access
- wire management cut-out in pedestal opposite door hinge
- telescopic feet
- locking door available, specify and add \$142 list
- pull-out shelf in closed compartment available, specify and add \$330 list

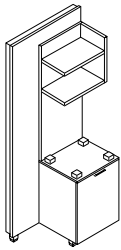
To Order, Specify:

- ① Model Number
- ② Wood Species on Top/Chassis/Shelves -
Cherry (CH1), Maple (MA1) or Walnut (WA1)
(see page [CC91](#))
- ③ Finish Color for Top/Chassis/Shelves (see page [CC96](#))
- ④ Finish Color for Back Panel and Door Fronts
 - A. Same as Top
 - B. Paint Color (see page [CC91](#))

Collective Conference



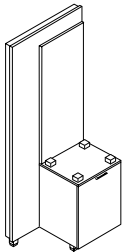
Description	D	W	H	CTN WT	CU FT	① Model	List Price
86"h Storage Tower	24	26½	86¼	197	37	MDOQST1R-2427	\$6,697
	24	26½	86¼	197	37	MDOQST1L-2427	\$6,697



left shown

- use with 18½"d top
- two open fixed shelves
- aluminum spacers included
- 20½"w storage compartment with one adjustable shelf and cut-out for wall access
- wire management cut-out in pedestal opposite door hinge
- telescopic feet
- locking door available, specify and add \$142 list
- pull-out shelf in closed compartment available, specify and add \$330 list
- credenza lamp available, specify and add \$538 list

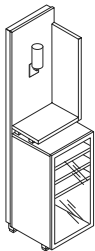
86"h Storage Tower	24	27	86¼	163	38	MDOQSTZR-2427	\$6,608
	24	27	86¼	163	38	MDOQSTZL-2427	\$6,608



left shown

- use with 18½"d top
- aluminum spacers included
- 20½"w storage compartment with one adjustable shelf and cut-out for wall access
- wire management cut-out in pedestal opposite door hinge
- telescopic feet
- locking door available, specify and add \$142 list
- pull-out shelf in closed compartment available, specify and add \$330 list
- credenza lamp available, specify and add \$538 list

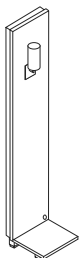
86"h Glass Door Storage Tower	24	20½	86¼	214	30	MDOQNT1R-2421	\$7,598
	24	20½	86¼	214	30	MDOQNT1L-2421	\$7,598



left shown with optional sconce

- one open fixed shelf
- aluminum spacers included
- glass door is touch latch
- storage compartment with two adjustable shelves and cut out for wall access
- wire management cut-out in pedestal opposite door hinge
- telescopic feet
- locking not available
- pull-out shelf in closed compartment available, specify and add \$330 list
- wall sconce available, specify and add \$468 list

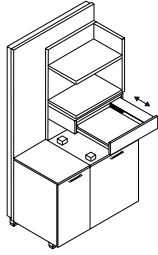
86"h Speaker Tower	24	14	86¼	63	21	MDOQHT1R-2414	\$4,199
	24	14	86¼	63	21	MDOQHT1L-2414	\$4,199



left shown with optional sconce

- 1¼"d grommet installed on attaching side of back panel
- position on media wall determines left or right
- telescopic feet
- wall sconce available, specify and add \$468 list

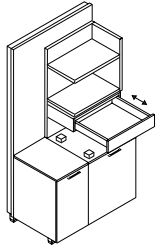
Description	D	W	H	CTN WT	CU FT	① Model	List Price
71" h Storage Tower with Laptop Drawer	24	34 ½	71 ¼	276	43	MDOQDSAR-2435	\$9,212
	24	34 ½	71 ¼	276	43	MDOQDSAL-2435	\$9,212



left shown

- use with 18 ½" d top
- two open fixed shelves
- laptop drawer with power port
- three blanks (for future data use)
- two adaptor kits to fit coupler/jacks
- aluminum spacers included
- 20 ½" w storage compartment with one adjustable shelf and cut-out for wall access
- 14" w storage compartment with a concealed storage drawer
- one power port
- wire management cut-out in pedestal opposite door hinge
- telescopic feet
- locking doors available, specify and add \$284 list
- pull-out shelf in large compartment available, specify and add \$330 list

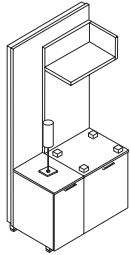
71" h Storage Tower with Drawer	24	34 ½	71 ¼	264	43	MDOQDSBR-2435	\$8,266
	24	34 ½	71 ¼	264	43	MDOQDSBL-2435	\$8,266



left shown

- use with 18 ½" d top
- two open fixed shelves and drawer
- aluminum spacers included
- 20 ½" w storage compartment with one adjustable shelf and cut-out for wall access
- 14" w storage compartment with a concealed storage drawer
- telescopic feet
- locking doors available, specify and add \$284 list
- pull-out shelf in large compartment available, specify and add \$330 list

71" h Storage Tower	24	34 ½	71 ¼	233	43	MDOQDS1R-2435	\$7,939
	24	34 ½	71 ¼	233	43	MDOQDS1L-2435	\$7,939



left shown

- use with 18 ½" d top
- one open fixed shelf
- aluminum spacers included
- 20 ½" w storage compartment with one adjustable shelf and cut-out for wall access
- 14" w storage compartment with a concealed storage drawer
- wire management cut-out in pedestal opposite door hinge
- telescopic feet
- locking doors available, specify and add \$284 list
- pull-out shelf in large compartment available, specify and add \$330 list
- credenza lamp available, specify and add \$538 list

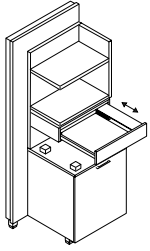
To Order, Specify:

- ① Model Number
- ② Wood Species on Top/Chassis/Shelves -
Cherry (CH1), Maple (MA1) or Walnut (WA1)
(see page [CC91](#))
- ③ Finish Color for Top/Chassis/Shelves (see page [CC96](#))
- ④ Finish Color for Back Panel and Door Fronts
 - A. Same as Top
 - B. Paint Color (see page [CC91](#))
- ⑤ Glass Door Option (see page [CC96](#))

Collective Conference



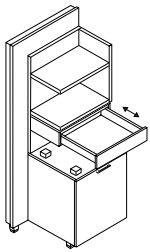
Description	D	W	H	CTN WT	CU FT	① Model	List Price
71" h Storage Tower with Laptop Drawer	24	26½	71¼	203	33	MDOQSSAR-2427	\$8,618
	24	26½	71¼	203	33	MDOQSSAL-2427	\$8,618



left shown

- use with 18½" d top
- two open fixed shelves
- laptop drawer with one power port
- three blanks (for future data use)
- two adaptor kits to fit coupler/jacks
- aluminum spacers included
- 20½" w storage compartment with one adjustable shelf and cut-out for wall access
- wire management cut-out in pedestal opposite door hinge
- telescopic feet
- locking doors available, specify and add \$142 list
- pull-out shelf in large compartment available, specify and add \$330 list

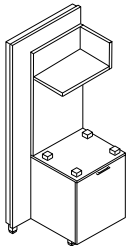
71" h Storage Tower with Drawer	24	26½	71¼	203	33	MDOQSSBR-2427	\$7,674
	24	26½	71¼	203	33	MDOQSSBL-2427	\$7,674



left shown

- use with 18½" d top
- two open fixed shelves and drawer
- aluminum spacers included
- 20½" w storage compartment with one adjustable shelf and cut-out for wall access
- wire management cut-out in pedestal opposite door hinge
- telescopic feet
- locking doors available, specify and add \$142 list
- pull-out shelf in large compartment available, specify and add \$330 list

71" h Storage Tower	24	26½	71¼	161	33	MDOQSS1R-2427	\$5,302
	24	26½	71¼	161	33	MDOQSS1L-2427	\$5,302

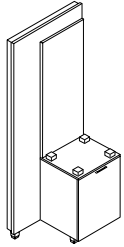


left shown

- use with 18½" d top
- one open fixed shelf
- aluminum spacers included
- 20½" w storage compartment with one adjustable shelf and cut-out for wall access
- wire management cut-out in pedestal opposite door hinge
- telescopic feet
- locking doors available, specify and add \$142 list
- pull-out shelf in large compartment available, specify and add \$330 list
- credenza lamp available, specify and add \$538 list

COLLECTIVE CONFERENCE

Description	D	W	H	CTN WT	CU FT	① Model	List Price
71" Storage Tower	24	27	71 ¼	148	33	MDOQSSZR-2427	\$4,546
	24	27	71 ¼	148	33	MDOQSSZL-2427	\$4,546



left shown

- use with 18 ½" d top
- aluminum spacers included
- 20 ½" w storage compartment with one adjustable shelf and cut-out for wall access
- wire management cut-out in pedestal opposite door hinge
- telescopic feet
- locking door available, specify and add \$142 list
- pull-out shelf in closed compartment available, specify and add \$330 list
- credenza lamp available, specify and add \$538 list

71" Speaker Tower	24	14	71 ¼	55	14	MDOQHS1R-2414	\$3,606
	24	14	71 ¼	55	14	MDOQHS1L-2414	\$3,606

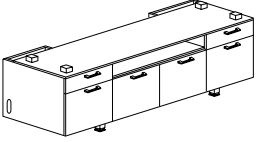


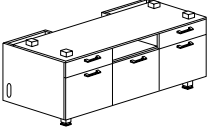
left shown with optional sconce

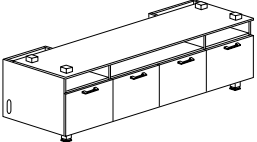
- 1 ¼" grommet installed on attaching side of back panel
- position on media wall determines left or right
- telescopic feet
- wall sconce available, specify and add \$468 list

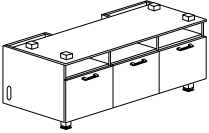
To Order, Specify:

- ① Model Number
- ② Wood Species on Top/Chassis/Shelves -
Cherry (CH1), Maple (MA1) or Walnut (WA1)
(see page [CC91](#))
- ③ Finish Color for Top/Chassis/Shelves (see page [CC96](#))
- ④ Finish Color for Back Panel and Door Front
 - A. Same as Top
 - B. Paint Color (see page [CC91](#))

Description	D	W	H	CTN WT	CU FT	① Model	List Price
	24	72	26½	238	32	MDOTCRD-2472	\$8,496
	24	66	26½	234	29	MDOTCRD-2466	\$8,220
<ul style="list-style-type: none"> · unhanded · not freestanding · order top separately, see next page · 2 pencil/hinge pedestals with adjustable shelves each end, 18"w · 2 hinge/door pedestals center, 18"w · technology cubby, 36"w · wire management cut-outs in back panel · aluminum spacers included · telescopic feet · locking drawers not available · locking doors available, specify and add \$426 list · pull-out shelf (on outside hinged doors) available, specify and add \$330 list each 							

	24	54	26½	194	24	MDOTCRD-2454	\$7,447
<ul style="list-style-type: none"> · unhanded · not freestanding · order top separately, see next page · 2 pencil/hinge pedestals with adjustable shelves each end, 18"w · 1 hinge/door pedestal center, 18"w · technology cubby, 18"w · wire management cut-outs in back panel · aluminum spacers included · telescopic feet · locking drawers not available · locking doors available, specify and add \$426 list · pull-out shelf (on outside hinged doors) available, specify and add \$330 list each 							

	24	72	26½	225	32	MDOTCRO-2472	\$6,903
	24	66	26½	210	29	MDOTCRO-2466	\$6,742
<ul style="list-style-type: none"> · unhanded · not freestanding · order top separately, see next page · 4 hinge door pedestals, 18"w · outer hinge door pedestals with adjustable shelves · 2 technology cubbies, 18"w · 1 technology cubby, 36"w · wire management cut-outs in back panel · aluminum spacers included · telescopic feet · locking doors available, specify and add \$426 list · pull-out shelf (on outside hinged doors) available, specify and add \$330 list each 							

	24	54	26½	182	24	MDOTCRO-2454	\$5,557
<ul style="list-style-type: none"> · unhanded · not freestanding · order top separately, see next page · 3 hinge door pedestals, 18"w · outer hinge door pedestals with adjustable shelves · 3 technology niches, 18"w · wire management cut-outs in back panel · mount to end units for support · aluminum spacers included · telescopic feet · locking doors available, specify and add \$426 list · pull-out shelf (on outside hinged doors) available, specify and add \$330 list each 							

Description	D	W	H	CTN WT	CU FT	① Model	List Price
Wood Tops 	18½	113	1¼	68	4	MD7WTU1-19113	\$3,208
	18½	107	1¼	65	4	MD7WTU1-19107	\$3,070
	18½	101	1¼	61	4	MD7WTU1-19101	\$2,900
	18½	95	1¼	57	4	MD7WTU1-1995	\$2,728
	18½	72	1¼	43	3	MD7WTU1-1972	\$1,476
	18½	66	1¼	40	3	MD7WTU1-1966	\$1,417
	18½	60	1¼	36	2	MD7WTU1-1960	\$1,292
	18½	54	1¼	33	2	MD7WTU1-1954	\$1,083
	18½	20½	1¼	12	1	MD7WTU1-1921	\$635

· long grain veneer direction

Description	D	W	H	CTN WT	CU FT	① Model	List Price
Glass Tops 	18½	113	¾	102	4	MD7WTUG-19113	\$4,695
	18½	107	¾	96	3	MD7WTUG-19107	\$4,553
	18½	101	¾	91	3	MD7WTUG-19101	\$4,302
	18½	95	¾	85	3	MD7WTUG-1995	\$4,048
	18½	72	¾	65	2	MD7WTUG-1972	\$2,345
	18½	66	¾	59	2	MD7WTUG-1966	\$2,258
	18½	60	¾	54	2	MD7WTUG-1960	\$2,054
	18½	54	¾	49	2	MD7WTUG-1954	\$1,855
	18½	20½	¾	18	1	MD7WTUG-1921	\$1,011

- frosted glass top - screen print on underside
- eased edges
- fingerprint resisting coating on underside

To Order, Specify:

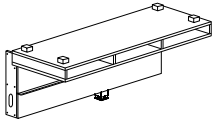
Credenzas

- ① Model Number
- ② Wood Species on Top/Chassis/Cubby- Cherry (CH1), Maple (MA1) or Walnut (WA1), (see page [CC91](#))
- ③ Finish Color for Top/Chassis (see page [CC96](#))
- ④ Finish Color for Door/Drawer Fronts
 - A. Same as Top
 - B. Paint Color (see page [CC91](#))

Wood Tops

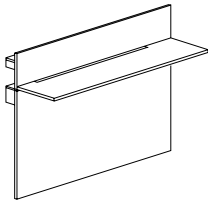
- ① Model Number
- ② Wood Species - Cherry (CH1), Maple (MA1) or Walnut (WA1), (see page [CC91](#))
- ③ Finish Color (see page [CC91](#))

Description	D	W	H	CTN WT	CU FT	① Model	List Price
Technology Cubby Storage with Access Panel	21 ¾	72	26 ½	125	17	MDOTNS1-2272	\$5,054
	21 ¾	66	26 ½	115	15	MDOTNS1-2266	\$4,735
	21 ¾	60	26 ½	106	14	MDOTNS1-2260	\$4,347
	21 ¾	54	26 ½	96	13	MDOTNS1-2254	\$3,911



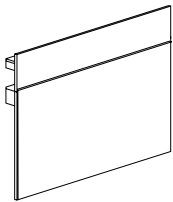
- unhandled
- not freestanding
- mount to end units for support
- use below credenza top
- panels open top up and bottom down for wire access

Center Wall Panel with Technology Shelf	19 ½	72	59 ¾	212	28	MDOTPT1-2072	\$4,884
	19 ½	66	59 ¾	195	26	MDOTPT1-2066	\$4,480
	19 ½	60	59 ¾	144	24	MDOTPT1-2060	\$4,132
	19 ½	54	59 ¾	162	21	MDOTPT1-2054	\$3,796



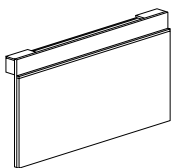
- use with 86" h ends
- unhandled
- 42" x 1 ¼" wire management opening (center shelf)
- -2072 TV dimension not to exceed 70" w x 40" h to allow proper mounting clearance and air circulation
- -2066 TV dimension not to exceed 64" w x 40" h to allow proper mounting clearance and air circulation
- -2060 TV dimension not to exceed 58" w x 40" h to allow proper mounting clearance and air circulation
- -2054 TV dimension not to exceed 52" w x 40" h to allow proper mounting clearance and air circulation

Center Wall Panel	5 ½	72	59 ½	184	20	MDOTPTZ-2072	\$4,238
	5 ½	66	59 ½	168	18	MDOTPTZ-2066	\$4,050
	5 ½	60	59 ½	153	17	MDOTPTZ-2060	\$3,746
	5 ½	54	59 ½	140	17	MDOTPTZ-2054	\$3,541



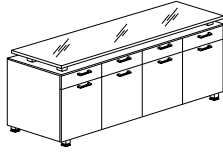
- use with 86" h ends
- unhandled
- -2072 TV dimension not to exceed 70" w x 40" h to allow proper mounting clearance
- -2066 TV dimension not to exceed 64" w x 40" h to allow proper mounting clearance
- -2060 TV dimension not to exceed 58" w x 40" h to allow proper mounting clearance
- -2054 TV dimension not to exceed 52" w x 40" h to allow proper mounting clearance

Center Wall Panel	5 ½	72	44 ¾	146	15	MDOTPS1-0672	\$2,667
	5 ½	66	44 ¾	135	14	MDOTPS1-0666	\$2,448
	5 ½	60	44 ¾	129	13	MDOTPS1-0660	\$2,258
	5 ½	54	44 ¾	111	11	MDOTPS1-0654	\$2,089



- use with 71" h ends
- unhandled
- -0672 TV dimension not to exceed 70" w x 36 ½" h to allow proper mounting clearance
- -0666 TV dimension not to exceed 64" w x 36 ½" h to allow proper mounting clearance
- -0660 TV dimension not to exceed 58" w x 36 ½" h to allow proper mounting clearance
- -0654 TV dimension not to exceed 52" w x 36 ½" h to allow proper mounting clearance

Description	D	W	H	CTN WT	CU FT	① Model	List Price
Serving Height Credenza	24	72	36 1/8	411	47	MD2BCR1-2472	\$10,393



- freestanding
- frosted glass top - screen print on underside
- 4 pencil/hinge pedestal with adjustable shelves, 18"w
- aluminum spacers included
- telescopic feet
- locking drawers not available
- locking doors available, specify and add \$426 list
- wood top, deduct \$372 list - species and finish will match chassis

To Order, Specify:

Access Panel

- ① Model Number
- ② Wood Species on Top/Chassis- Cherry (CH1), Maple (MA1) or Walnut (WA1), (see page [CC91](#))

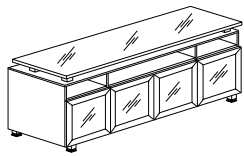
Center Wall Panels

- ① Model Number
- ② Wood Species on Lower Panel/Shelf - Cherry (CH1), Maple (MA1) or Walnut (WA1), (see page [CC91](#))
- ③ Finish Color for Lower Panel/Shelf (see page [CC91](#))
- ④ Finish Color for Upper Center Panel
 - A. Same as Lower Panel/Shelf
 - B. Paint Color (see page [CC91](#))

Credenzas

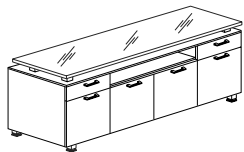
- ① Model Number
- ② Wood Species on Chassis- Cherry (CH1), Maple (MA1) or Walnut (WA1), (see page [CC91](#))
- ③ Finish Color for Chassis (see page [CC91](#))
- ④ Finish Color for Door/Drawer Fronts
 - A. Same as Chassis
 - B. Paint Color (see page [CC91](#))

Description	D	W	H	CTN WT	CU FT	① Model	List Price
-------------	---	---	---	-----------	----------	---------	------------



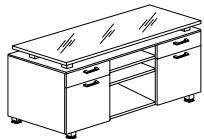
- freestanding
- 23 1/4" d frosted glass top - screen print on underside
- 4 glass hinge door pedestals, 18" w
- outer hinge door pedestals with adjustable shelves
- 2 technology cubbies, 18" w
- 1 technology cubby, 36" w
- wire management cut-outs in back panel
- aluminum spacers included
- locking not available
- wood top, deduct \$372 list - species and finish will match chassis

72" w Technology Credenza	24	72	29	374	39	MDOFCRD-2472	\$8,366
---------------------------	----	----	----	-----	----	--------------	---------



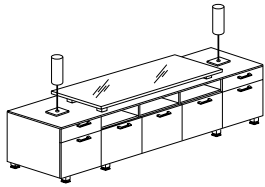
- freestanding
- 23 1/4" d frosted glass top - screen print on underside
- 2 pencil/hinge door pedestals with adjustable shelves each end, 18" w
- 2 hinge door pedestals center, 18" w
- technology cubby 36" w
- wire management cut-outs in back panel
- aluminum spacers included
- telescopic feet
- locking drawers not available
- locking doors available, specify and add \$426 list
- wood top, deduct \$372 list - species and finish will match chassis

60" w Technology Credenza	24	60	29	302	33	MDOFCRE-2460	\$7,554
---------------------------	----	----	----	-----	----	--------------	---------



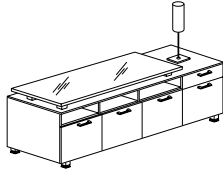
- freestanding
- 23 1/4" d frosted glass top - screen print on underside
- 2 pencil/hinge door pedestals with adjustable shelves each end, 18" w
- open center, 24" w
- technology cubby 24" w
- wire management cut-outs in back panel
- adjustable shelf per compartment
- aluminum spacers included
- telescopic feet
- locking drawers not available
- locking doors available, specify and add \$284 list
- wood top, deduct \$310 list - species and finish will match chassis

Description	D	W	H	CTN WT	CU FT	① Model	List Price
90"w Technology Console	24	90	24 ¾	348	42	MDOFCSD-2490	\$9,355



- freestanding
- 23 ¼"d frosted glass top - screen print on underside
- 2 pencil/hinge door pedestals with adjustable shelves each end, 18"w
- 3 hinge door pedestals center, 18"w
- 3 technology cubbies center, 18"w
- wire management cut-outs in back panel
- aluminum spacers included
- two credenza lamps
- telescopic feet
- locking drawers not available
- locking doors available, specify and add \$568 list
- wood top, deduct \$280 list - species and finish will match chassis

72"w Asymmetric Technology Console	24	72	24 ¾	251	34	MDOACSDR-2472	\$8,746
	24	72	24 ¾	251	34	MDOACSDL-2472	\$8,746



right shown

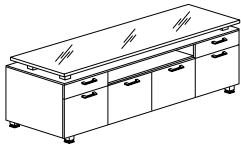
- freestanding
- 23 ¼"d frosted glass top - screen print on underside
- 1 pencil/hinge door pedestal with adjustable shelf, 18"w
- 3 hinge door pedestals center, 18"w
- 3 technology cubbies, 18"w
- wire management cut-outs in back panel
- aluminum spacers included
- credenza lamp
- telescopic feet
- locking drawer not available
- locking doors available, specify and add \$426 list
- wood top, deduct \$280 list - species and finish will match chassis

To Order, Specify:

- ① Model Number
- ② Wood Species on Chassis- Cherry (CH1), Maple (MA1) or Walnut (WA1), (see page [CC91](#))
- ③ Finish Color for Chassis (see page [CC91](#))
- ④ Finish Color for Door/Drawer Fronts
 - A. Same as Chassis
 - B. Paint Color (see page [CC91](#))
- ⑤ Glass Door Option (see page [CC96](#))

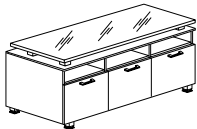
Description	D	W	H	CTN WT	CU FT	① Model	List Price
-------------	---	---	---	-----------	----------	---------	------------

72" w Technology Console	24	72	24 3/4	270	34	MD0FCSD-2472	\$8,083
---------------------------------	----	----	--------	-----	----	---------------------	----------------



- freestanding
- 23 1/4" d frosted glass top - screen print on underside
- 2 pencil/hinge door pedestals with adjustable shelves, 18" w
- 2 hinge door pedestals center, 18" w
- 1 technology cubby, 18" w
- wire management cut-outs in back panel
- aluminum spacers included
- telescopic feet
- locking drawers not available
- locking doors available, specify and add \$426 list
- wood top, deduct \$372 list - species and finish will match chassis

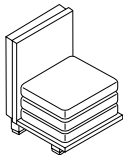
54" w Technology Console	24	54	24 3/4	216	26	MD0FCSOR-2454	\$7,311
---------------------------------	----	----	--------	-----	----	----------------------	----------------



left shown

- | | | | | | | | |
|--|----|----|--------|-----|----|----------------------|----------------|
| | 24 | 54 | 24 3/4 | 216 | 26 | MD0FCSOL-2454 | \$7,311 |
|--|----|----|--------|-----|----|----------------------|----------------|
- freestanding
 - 23 1/4" d frosted glass top - screen print on underside
 - 3 hinge door pedestals, 18" w
 - 3 technology cubbies 18" w
 - wire management cut-outs in back panel
 - aluminum spacers included
 - telescopic feet
 - locking doors available, specify and add \$426 list
 - wood top, deduct \$280 list - species and finish will match chassis

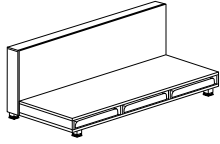
Low Platform	24	24	26 1/2	53	11	MD0SOL1R-2424	\$2,494
---------------------	----	----	--------	----	----	----------------------	----------------



shown with optional cushions

- | | | | | | | | |
|--|----|----|--------|----|----|----------------------|----------------|
| | 24 | 24 | 26 1/2 | 53 | 11 | MD0SOL1L-2424 | \$2,494 |
|--|----|----|--------|----|----|----------------------|----------------|
- freestanding
 - telescopic feet
 - attachment determines left or right
 - cushions available, see next page

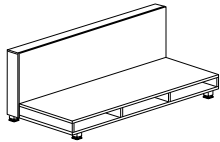
Description	D	W	H	CTN WT	CU FT	① Model	List Price
Low Technology Console	24	72	26 ½	175	27	MDOFCLO-2472	\$6,336



shown with optional cushions

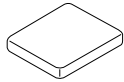
- freestanding
- 3 technology cubbies
- wire management cut-outs
- telescopic feet
- cushions available, see below

Low Technology Console	24	66	26 ½	162	25	MDOFCLO-2466	\$5,760
	24	60	26 ½	148	22	MDOFCLO-2460	\$4,837



- freestanding
- 3 technology cubbies
- wire management cut-outs
- telescopic feet
- cushions available (will fit two cushions with a space in between), see below

Description	D	W	H	CTN WT	CU FT	① Model	List Price Per Grade
Cushion for Low Console	19 ¼	21 ¾	4	12	2	COL2424CUSH	COM \$477
							A \$495
							B \$525
							COL/C \$581
							D \$651
							E \$725
							F \$838
							G \$958
							H \$1,083
							I \$1,285
							J \$1,521
							L1 \$1,046
							L2 \$1,189



- com ydg: 1
- col sq ft: 18

To Order, Specify:

Low Console

- ① Model Number
- ② Wood Species on Chassis- Cherry (CH1), Maple (MA1) or Walnut (WA1), (see page [CC91](#))
- ③ Finish Color for Chassis (see page [CC91](#))
- ④ Finish Color for Door/Drawer Fronts
 - A. Same as Chassis
 - B. Paint Color (see page [CC91](#))

Low Platform and Low Technology Console

- ① Model Number
- ② Wood Species on Top - Cherry (CH1), Maple (MA1) or Walnut (WA1), (see page [CC91](#))
- ③ Finish Color for Top (see page [CC91](#))
- ④ Finish Color for Back Panel
 - A. Same as Top
 - B. Paint Color (see page [CC91](#))

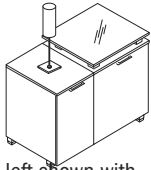
Cushion

- ① Model Number
- ② Fabric - vendor, pattern, color

Collective Conference



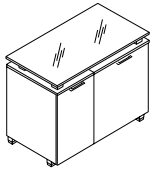
Description	D	W	H	CTN WT	CU FT	① Model	List Price
Asymmetric Hinged Door Storage	24	34½	29	172	19	MDOAHD1R-2435	\$3,309
	24	34½	29	172	19	MDOAHD1L-2435	\$3,309



left shown with optional lamp

- freestanding
- 23 ¼" d frosted glass top - screen print on underside
- credenza lamp
- lamp end determines left or right
- wire management cut-out in pedestal opposite door hinge
- telescopic feet
- locking doors available, specify and add \$284 list
- wood top, deduct \$191 - species and finish will match chassis

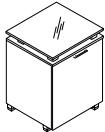
34 ½" w Hinged Door Storage	24	34½	29	179	19	MDOFHD1R-2435	\$2,923
	24	34½	29	179	19	MDOFHD1L-2435	\$2,923



left shown

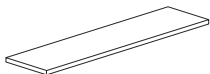
- freestanding
- 23 ¼" d frosted glass top - screen print on underside
- wire management cut-out in pedestal opposite door hinge
- telescopic feet
- locking doors available, specify and add \$284 list
- wood top, deduct \$249 - species and finish will match chassis

20 ½" w Hinged Door Storage	24	20½	29	130	12	MDOFHD1R-2420	\$2,292
	24	20½	29	130	12	MDOFHD1L-2420	\$2,292

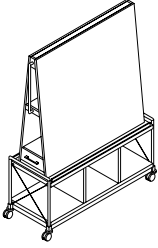



- freestanding
- 23 ¼" d frosted glass top - screen print on underside
- wire management cut-out in pedestal opposite door hinge
- hinge determines left or right
- telescopic feet
- locking door available, specify and add \$142 list
- wood top, deduct \$191 - species and finish will match chassis

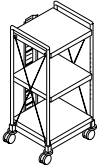
Wall Mount Storage Shelves	8	72	1 ¼	20	1	MDOWSS1-0872	\$1,612
	8	66	1 ¼	19	1	MDOWSS1-0866	\$1,499
	8	60	1 ¼	17	1	MDOWSS1-0860	\$1,342
	8	54	1 ¼	16	1	MDOWSS1-0854	\$1,129



- mounting hardware included

Description	D	W	H	CTN WT	CU FT	① Model	List Price Per Grade
Mobile Marker Board	20	51 ½	71 ¾	227	50	MDOMMB1-2052	COM \$14,756
 <ul style="list-style-type: none"> · 48" x 48" porcelain enamel marker board · 48" x 48" tackable surface · handles for easy mobility · thumbs screws for flip chart · frame is arctic silver · 8 ½" x 16" wood drawer boxes on each side · three lower open compartments · X-shaped steel cables on sides · two locking/two non-locking casters · com ydg: 1 ¾ 	A						\$14,785
	B						\$14,835
	C						\$14,926
	D						\$15,047
	E						\$15,165
	F						\$15,349
	G						\$15,544
	H						\$15,760
	I						\$16,086
	J						\$16,480

Description	D	W	H	CTN WT	CU FT	① Model	List Price
Mobile Serving Cart	19	35 ⅝	38 ¼	88	18	MDOMCS1-1936	\$10,039
 <ul style="list-style-type: none"> · handles for easy mobility · frame is arctic silver · top and bottom fixed shelves · one adjustable shelf · X-shaped steel cables on sides · two locking/two non-locking casters 							

Description	D	W	H	CTN WT	CU FT	① Model	List Price
Mobile Technology Cart	15	17 ⅜	38 ¼	32	8	MDOMCT1-1517	\$9,037
 <ul style="list-style-type: none"> · handles for easy mobility · frame is arctic silver · top and bottom fixed shelves · one adjustable shelf · vertical wire management channel on back · X-shaped steel cables on sides · two locking/two non-locking casters 							

To Order, Specify:

Storage Units

- ① Model Number
- ② Wood Species on Top/Chassis- Cherry (CH1), Maple (MA1) or Walnut (WA1), (see page [CC91](#))
- ③ Finish Color for Top/Chassis (see page [CC91](#))
- ④ Finish Color for Door Fronts
 - A. Same as Top
 - B. Paint Color (see page [CC91](#))

End Display Unit

- ① Model Number
- ② Wood Species - Cherry (CH1), Maple (MA1) or Walnut (WA1), (see page [CC91](#))
- ③ Finish Color (see page [CC91](#))
- ④ Fabric - vendor, pattern, color



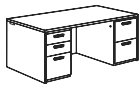
Desks	FN20
Modesty Panels	FN20
Returns and Bridges	FN28
Credenzas	FN33
Overhead Cabinets.	FN36
Tackboards	FN40
Tool Rail Accessories.	FN46
Wall Mount Storage	FN47
Storage Towers.	FN56
Transaction Counters.	FN65
Bookcases.	FN66
Lateral Files	FN67
Vertical Storage Units	FN68
Freestanding Tables	FN72

Finale - Overview

Desks



Bow Front Double Pedestal Desk
Page [FN20](#)



Double Pedestal Desk
Page [FN20](#)

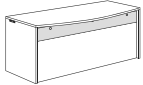


Electric Adjustable Height Table Desk
Page [FN22](#)

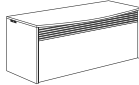


Pneumatic Adjustable Height Table Desk
Page [FN22](#)

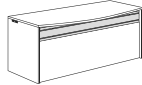
Modesty Panels



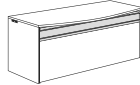
Glass Trim Modesty Panel
Page [FN20](#)



Metal Trim Modesty Panel
Page [FN20](#)



Metal/Glass Trim Modesty Panel
Page [FN21](#)



Metal/Veneer Trim Modesty Panel
Page [FN21](#)



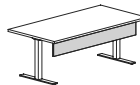
Metal Trim Modesty Panel
Page [FN24](#)



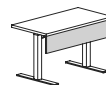
Metal/Glass Trim Modesty Panel
Page [FN24](#)



Metal/Veneer Trim Modesty Panel
Page [FN24](#)



Adjustable Height Table Modesty Panel
Page [FN22](#)



Adjustable Height Bridge Modesty Panel
Page [FN32](#)

Table Desks



Metal Frame Table Desk with Glass Top
Page [FN23](#)



Metal Frame Table Desk with Veneer Top
Page [FN23](#)



Metal Frame Table Desk for COM Top
Page [FN23](#)

Desk Applications

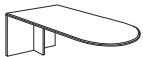


Bow Front Single Pedestal Desk
Page [FN25](#)

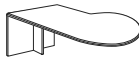


Single Pedestal Desk
Page [FN25](#)

Peninsula Desks

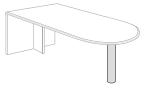


Bullet Peninsula Desk
Page [FN26](#)

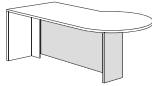


P-Top Peninsula Desk
Page [FN26](#)

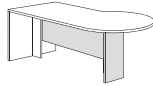
Peninsula Desk Bases and Modesty Panels



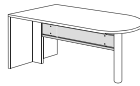
Column Base
Page [FN27](#)



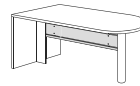
Full Modesty Panel
Page [FN27](#)



3/4 Modesty Panel
Page [FN27](#)



Metal/Glass Trim Modesty Panel
Page [FN27](#)



Metal/Veneer Trim Modesty Panel
Page [FN27](#)

Finale - Overview

Return Applications



File/File Return
Page [FN28](#)



Lateral File Return
Page [FN28](#)



Multi-File Return
Page [FN28](#)



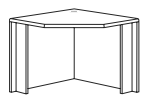
File/File Corner
Return
Page [FN30](#)



Lateral File Corner
Return
Page [FN30](#)

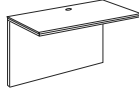


Multi-File Corner
Return
Page [FN30](#)

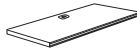


Executive Corner
Unit
Page [FN29](#)

Bridge Applications



Bridge with Modesty Panel
Page [FN31](#)



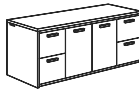
Bridge Top
Page [FN31](#)

Adjustable Height Bridge

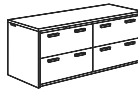


Electric Adjustable
Height Bridge
Page [FN32](#)

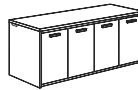
Credenza and Lateral Files



Storage Credenza
Page [FN33](#)



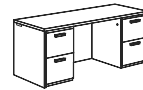
Lateral File Credenza
Page [FN33](#)



Four Door Credenza
Page [FN33](#)



Two Door Credenza
Page [FN33](#)



Kneespace Credenza
Page [FN34](#)



Buffet Credenza
Page [FN34](#)



Pedestal Credenza
Page [FN34](#)



File/File Reception
Credenza
Page [FN34](#)



Lateral Pedestal
Credenza
Page [FN35](#)



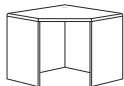
Multi-File Pedestal
Credenza
Page [FN35](#)

Printer Stand



Printer Stand
Page [FN35](#)

Corner Unit



Corner Unit
Page [FN35](#)

Finale - Overview

Overhead Cabinets



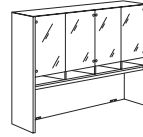
Double Height Storage Overhead Cabinet with Four Doors
Page [FN36](#)



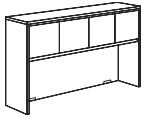
Double Height Storage Overhead Cabinet with Four Glass Doors
Page [FN36](#)



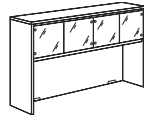
Double Height Storage Overhead Cabinet with Four Doors and Cubbies
Page [FN37](#)



Double Height Storage Overhead Cabinet with Four Glass Doors and Cubbies
Page [FN37](#)



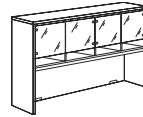
Storage Overhead Cabinet with Four Doors
Page [FN38](#)



Storage Overhead Cabinet with Four Glass Doors
Page [FN38](#)



Storage Overhead Cabinet with Four Doors and Cubbies
Page [FN39](#)



Storage Overhead Cabinet with Four Glass Doors and Cubbies
Page [FN39](#)

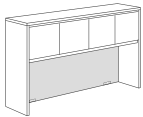


Open Storage Overhead Cabinet
Page [FN38](#)

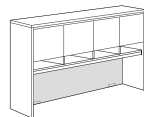


Open Storage Overhead Cabinet with Cubbies
Page [FN39](#)

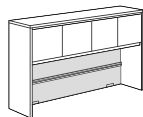
Tackboards



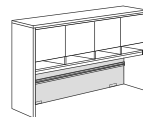
Tackboard for Storage Overhead Cabinet
Page [FN40](#)



Tackboard for Storage Overhead Cabinet with Cubbies
Page [FN41-FN42](#)

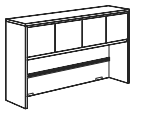


Accessory Rail Tackboards for Storage Overhead Cabinets
Page [FN43](#)



Accessory Rail Tackboards for Storage Overhead Cabinets with Cubbies
Page [FN44](#)

Accessories



Accessory rail
Page [FN45](#)



Upright tray
Page [FN46](#)



Small tray
Page [FN46](#)



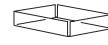
Pencil tray
Page [FN46](#)



Paper tray
Page [FN46](#)



File hanger
Page [FN46](#)

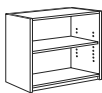


Acrylic Accessory Tray
Page [FN46](#)



Center drawer
Page [FN76](#)

Wall Mount Storage



Double Height Wall Mount Open Overhead Cabinet
Page [FN47](#)



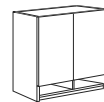
Double Height Wall Mount Overhead Cabinet with Two Doors
Page [FN47](#)



Double Height Wall Mount Overhead Cabinet with Two Glass Doors
Page [FN47](#)



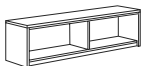
Double Height Wall Mount Open Overhead Cabinet with Cubbies
Page [FN48](#)



Double Height Wall Mount Overhead with Two Doors and Cubbies
Page [FN48](#)



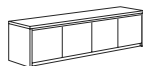
Double Height Wall Mount Overhead with Two Glass Doors and Cubbies
Page [FN48](#)



Wall Mount Open Overhead
Page [FN49](#)



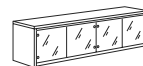
Wall Mount Open Overhead
Page [FN49](#)



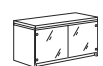
Wall Mount Overhead Cabinet with Four Doors
Page [FN49](#)



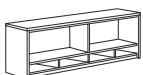
Wall Mount Overhead Cabinet with Two Doors
Page [FN49](#)



Wall Mount Overhead Cabinet with Four Glass Doors
Page [FN50](#)



Wall Mount Overhead Cabinet with Two Glass Doors
Page [FN50](#)



Wall Mount Open Overhead with Cubbies
Page [FN50](#)



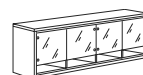
Wall Mount Open Overhead with Cubbies
Page [FN50](#)



Wall Mount Overhead Cabinet with Four Doors and Cubbies
Page [FN51](#)



Wall Mount Overhead Cabinet with Two Doors and Cubbies
Page [FN51](#)



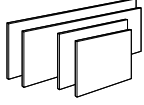
Wall Mount Overhead Cabinet with Four Glass Doors and Cubbies
Page [FN51](#)



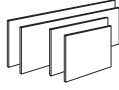
Wall Mount Overhead Cabinet with Two Glass Doors and Cubbies
Page [FN51](#)

Finale - Overview

Tackboards



Wall Mount Tackboards
Pages [FN52-FN53](#)



Wall Mount Tackboards for
Overhead Cabinets with Cubbies
Pages [FN54-FN55](#)

Storage Towers



Double Height Open
Storage Tower
Page [FN56](#)



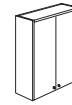
Double Height Storage
Tower with 54" h Door
Page [FN56](#)



Double Height Storage
Tower with 54" h
Glass Door
Page [FN56](#)



Double Height Open
Storage Tower
Page [FN57](#)



Double Height Storage
Tower with Two 54" h
Doors
Page [FN57](#)



Double Height Storage
Tower with Two 54" h
Glass Doors
Page [FN57](#)



Open Storage Tower
Page [FN58](#)



Storage Tower with
42" h Door
Page [FN58](#)



Storage Tower with
42" h Glass Door
Page [FN58](#)



Open Storage Tower
Page [FN59](#)



Storage Tower with Two
42" h Doors
Page [FN59](#)



Storage Tower with Two
42" h Glass Doors
Page [FN59](#)



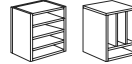
Bookcase Overhead
Page [FN60](#)



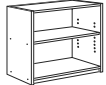
Storage Tower
Page [FN60](#)



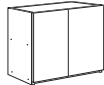
Glass Door Storage
Tower
Page [FN60](#)



Storage Tower
Page [FN58](#)



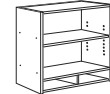
Double Height Bridge
Mount Open Overhead
Cabinet
Page [FN61](#)



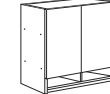
Double Height Bridge
Mount Overhead
Cabinet with Two Doors
Page [FN61](#)



Double Height Bridge
Mount Overhead Cabinet
with Two Glass Doors
Page [FN61](#)



Double Height Bridge
Mount Open Overhead
Cabinet and Cubbies
Page [FN62](#)



Double Height Bridge
Mount Overhead Cabinet
with Two Doors and Cubbies
Page [FN62](#)



Double Height Bridge Mount
Overhead Cabinet with Two
Glass Doors and Cubbies
Page [FN62](#)



Bridge Mount
Open Overhead
Page [FN63](#)



Bridge Mount Overhead
Cabinet with Two Doors
Page [FN63](#)



Bridge Mount Overhead
Cabinet with Two
Glass Doors
Page [FN63](#)



Bridge Mount Open
Overhead with Cubbies
Page [FN64](#)



Bridge Mount Overhead
Cabinet with Two Doors
and Cubbies
Page [FN64](#)

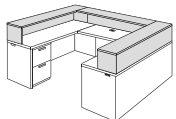


Bridge Mount Overhead
Cabinet with Two Glass
Doors and Cubbies
Page [FN64](#)

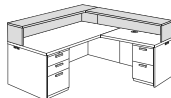


Modular Cabinet Top
Page [FN64](#)

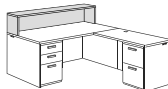
Transaction Counters



Transaction Counter
Page [FN65](#)



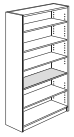
Transaction Counter
Page [FN65](#)



Transaction Counter
Page [FN65](#)

Finale - Overview

Bookcases



Bookcase
Page [FN66](#)



Bookcase
Page [FN66](#)

Lateral Files

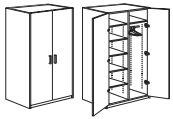


Lateral File
Page [FN67](#)

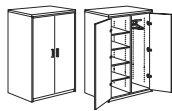


Mobile Pedestal
Page [FN67](#)

Storage Cabinets



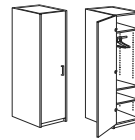
84" h Wardrobe
Page [FN68](#)



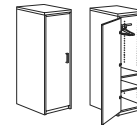
72" h Wardrobe
Page [FN68](#)



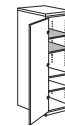
Hanging Bar to Shelves
Conversion Kit
Page [FN68](#)



84" h Wardrobe
Page [FN69](#)



72" h Wardrobe
Page [FN69](#)



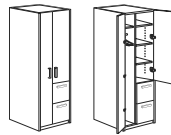
Hanging Bar to Shelves
Conversion Kit
Page [FN69](#)



84" h File/File Lateral
Storage Cabinet
Page [FN70](#)



72" h File/File Lateral
Storage Cabinet
Page [FN70](#)



84" h File/File
Storage Wardrobe
Page [FN70](#)



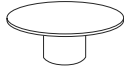
72" h File/File
Storage Wardrobe
Page [FN70](#)



Modular Wardrobe Top
Page [FN71](#)

Finale - Overview

Magazine Table



Round Magazine Table
Page [FN72](#)

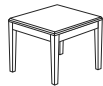
Tables



Sofa Table
Page [FN73](#)



Magazine Table
Page [FN73](#)



End Table
Page [FN73](#)



End Table
Page [FN73](#)



Metal Frame End Table with Glass Top
Page [FN74](#)



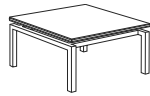
Metal Frame End Table with Veneer Top
Page [FN74](#)



Metal Frame End Table for COM Top
Page [FN74](#)



Metal Frame Magazine Table with Glass Top
Page [FN75](#)



Metal Frame Magazine Table with Veneer Top
Page [FN75](#)



Metal Frame Magazine Table for COM Top
Page [FN75](#)



Metal Frame Magazine Table with Glass Top
Page [FN76](#)



Metal Frame Magazine Table with Veneer Top
Page [FN76](#)

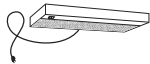


Metal Frame Magazine Table for COM Top
Page [FN76](#)



Corner Table
Page [FN73](#)

Task Lights



Task Light



LED Task Light

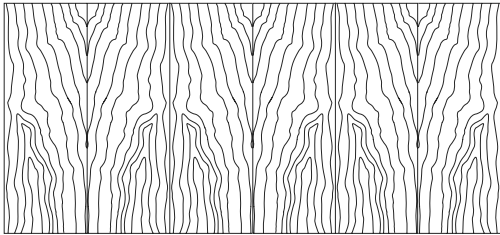


Motion Sensor for Task Lights

Finale Product Information

Exterior Wood Materials

Exterior surfaces are made from the finest selected veneers to achieve clarity and consistency in the Finale product line. To attain a pleasing, symmetrical pattern, all veneers in Finale are book-matched. All exterior solid lumber is matched to coordinate with the veneer.



Book Matched Example

Alternating pieces of veneer are flipped over so they face each other like the pages within a book

Finale is available in flat cut cherry, maple and walnut veneer. A wide range of wood stains have been formulated to enhance the beauty of the veneer.

Work Surface Construction

Tops are 5-ply balanced construction, 1 3/4" thick with solid matching hardwood edges. Surfaces are available in wood veneer or high pressure laminate. No additional charge for using our coordinating high pressure laminate with a veneer grain pattern.

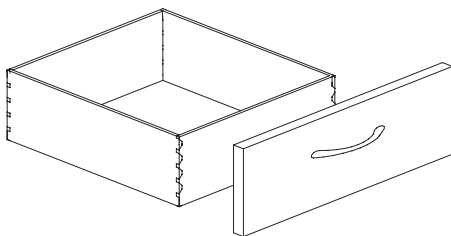
Case Construction

Outside panels are 1 3/4" and joined together by mortise and tenon construction. In addition to mortise and tenon joint construction, pedestal joints are reinforced with screws, cleats, brackets and glue. Leveling glides are set into solid hardwood blocks with t-nut inserts, which helps to prevent the leveling glide from tear out. Tops are secured to the chassis with top fastening cleats screwed to the inside of the panels.

Cabinet doors have 110° swing hinges to allow adequate access into the interior of the cabinet.

Drawers

The 9ply unidirectional hardwood sides of the drawer box are 7/16" thick assembled with English dovetail construction at each corner of the box. The drawer bottom panel is 1/4" thick fitting into a groove machined the into side of the box. Interiors are sanded and coated with clear U.V. finish to protect against shrinking, swelling or warping, and to provide a clean, smooth feel and appearance.



Drawer Suspension

The high quality black drawer suspensions carry a lifetime warranty. Slides feature steel ball bearings for longer life with cushioned in /out stops. File and box drawers have 100% full extension with over travel.

Filing Hardware

All file drawers are constructed with a custom designed filing system in place to allow for hanging folders. Filing diagram on pages [FN17-FN19](#).

Locking

All desks, credenzas and returns feature pedestal locking and lateral files feature central locking to provide maximum security and flexibility.

Units are shipped randomly keyed as standard (units in the grouping are keyed alike). Keyed alike units available if requested at no upcharge. Removable cores for in-field re-keying are standard.

Finish - Stain/Colors

We offer a variety of wood stains and paint colors on Finale. Please see the chart below. Samples are available upon request.

CH1	Cherry	<i>Flat Cut Veneer</i>		
BBM	Bourbon Medium		CLL	Collectors
BRM	Brighton Medium		HRV	Harvest
CLA	Classic		PRL	Praline
MA1	Maple	<i>Flat Cut Veneer</i>		
ALM	Ale Medium		FLX	Flax
BUT	Butterscotch		VEN	Venetian
WA1	Walnut	<i>Flat Cut Veneer</i>		
ESP	Espresso		TRF	Truffle
MCH	Mocha		UMB	Umber
SIE	Sienna			

Protective Top Coat

DuraTex™ offers exceptional hardness along with abrasion and impact resistance, it has been formulated to eliminate hazardous and harmful gases that are normally associated with wood finish.

DuraTex™ Features

Safety - Significantly reduces hazardous formaldehyde emissions which help improve the quality of the of the indoor air we breathe.

Quality - Developed to be tough and durable with special attention to appearance. The DuraTex™ finish preserves the natural beauty of wood.

Durability - Designed to meet a wide range of demanding performance and environmental standards to withstand even the highest wear and tear.

Finale Product Information

Product Modification

Laminate Tops

Worksurface only, no additional upcharge if coordinating wood grain laminate is specified. Contact Customer Service for any other laminate request. Listed below are finishes that have coordinating wood grain HPL laminates.

CH1 Cherry *Flat Cut Veneer*

- CLL Collectors
- HRV Harvest
- PRL Praline

WA1 Walnut *Flat Cut Veneer*

- MCH Mocha TRF Truffle
- SIE Sienna UMB Umber

Special Finishes

Special finishes can be requested by following the instruction in the general introduction section. There is a one time charge of \$372 list per order.

Finish Sheen

All veneer finishes, for Finale, are standard in 35-sheen. All other finishes can have their sheen modified with a 15% upcharge added to the list price of each item.

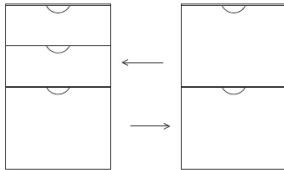
Species Change

For species changes contact customer service for a quote.

Pedestal Configuration Change

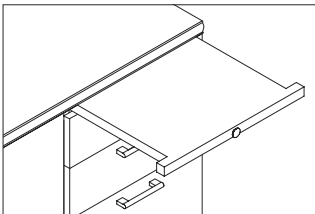
Box-box-file configuration is standard on all desks and file-file configuration is standard on all return units.

Finale drawer configuration on pedestals 27" to 30" high can be switched out either to a box-box-file or file-file configuration, but must be specified at the time of order with an additional \$192 list per pedestal.



Writing Shelf - Pullout (Arm Slide)

Desk Pedestals in Finale can have an optional pullout shelf above the top drawer for additional writing surface. Add \$369 to the list for each pedestal.



Special Sizes from Standard Offering

The following chart contains pricing for general modifications to Finale.

All modifications still must be approved by JSI manufacturing, please contact Customer Service to verify any of the modifications listed in the chart below. More complex modification to standard product may be possible, please refer to page 5 for additional details.

This chart does not apply to glass doors, glass tops or to metal components; such as modesty trims panels, and structural support. Any changes to file drawers will affect filing capabilities.

Increasing Dimensions - Add On to the list Per 6" Occurrence

Overhead	
Increasing width	\$1,032
Increasing depth	\$1,760
Increasing width with doors	\$1,221
Increasing depth with doors	\$1,882

Any Pedestal	
Increasing width	\$1,463
Increasing depth	\$1,305

Any Panel	
Increasing width	\$334

Any Top	
Increasing width	\$434
Increasing depth	\$614

Decreasing Dimensions Add On to the list Per 6" Occurrence

Overhead	
Decreasing width	\$253
Decreasing depth	\$253
Decreasing width with doors	\$346
Decreasing depth with doors	\$346

Any Pedestal	
Decreasing width	\$1,094
Decreasing depth	\$977

Any Panel	
Decreasing width	\$129

Any Top	
Decreasing width	\$190
Decreasing depth	\$190

Example 1

Increasing open corner credenza width by 11", from 72" to 83".
 Add Top Width (\$434 × 2) [\$434 for each 6" increment]
 Add Panel Width (\$334 × 2) [\$334 for each 6" increment]
 Total Modification = \$1,536

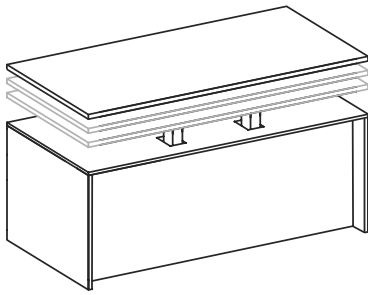
Example 2

Increasing a desk pedestal depth from 36" to 40" & increase the width of the same pedestal by 8"
 Add Pedestal Depth \$1,305
 Add Pedestal Width (\$1,463 × 2) [\$1,463 for each 6" increment]
 Total Modification = \$4,231

Example 3

Decreasing an overhead from 60" to 58" width & increasing the depth by 3"
 Decrease Overhead Width \$253
 Add Overhead Depth \$1,760
 Total Modification = \$1,507

Finale Product Information



ERGO Adjustable Work Height Mechanism

Our proprietary adjustable work height mechanism can be specified on many of the models in Finale.

ERGO mechanism allows height adjustability to be added to the worksurface. Our solution uses a standardized design that minimizes the modifications required to standard desk, bridge or credenza models. The mechanism and control box are neatly concealed to maintain the appearance of the original elegance of the product. A push button activates the electric powered lifting columns for adjustability from sitting height to a standing height. A $\frac{3}{4}$ " thick finished sub top is added to the top of the desk chassis for a clean appearance when the surface is in the raised position. In the lowered position, please note that ERGO adds $\frac{3}{4}$ " to the standard height of the desk and the installation will decrease kneespace depth by 8".

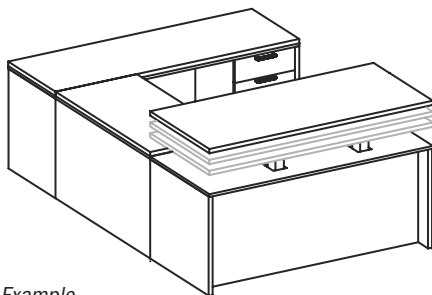
Automatic Collision Control is built in to each mechanism as a standard feature. When the system senses an obstacle obstructing the movement, the mechanism will reverse direction and retreat by 1".

When ERGO is added to a worksurface in an "L" or "U" group, all units in the configuration need to have a sub top added. These units are considered to be ERGO ADJACENT units. ERGO ADJACENT units must have a fixed height worksurface that matches the lowest position of the ERGO mechanism and the top. This is accomplished by adding a $\frac{3}{4}$ " sub top between the chassis and the worksurface. This feature can also be specified for cabinets which may sit next to a unit with the ERGO mechanism.

Height adjustment starts at $30\frac{1}{4}$ ", to a standing height of $49\frac{3}{4}$ ", a range of $19\frac{1}{2}$ ".

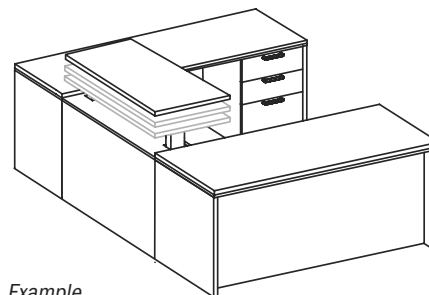
Note: The kneespace depth is decreased when the ERGO mechanism is specified. Contact Customer Service for dimension information.

The Ergo mechanism and controls are warranted for a period of (1) year. The rest of the casegood unit(s) are warranted under the Lifetime Warranty.



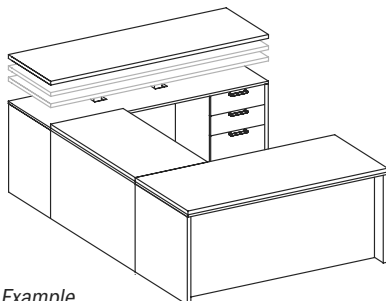
Example

FN3672LD (with ERGO option) add \$4,835 to list
 FN2448EB (with ERGO ADJACENT option) add \$606 to list
 FN2472RC (with ERGO ADJACENT option) add \$711 to list



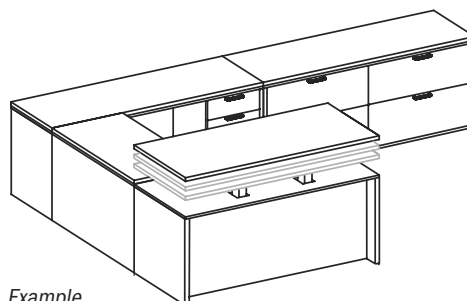
Example

FN3672LD (with ERGO ADJACENT option) add \$711 to list
 FN2448EB (with ERGO option) add \$4,835 to list
 FN2472RC (with ERGO ADJACENT option) add \$711 to list



Example

FN3672LD (with ERGO ADJACENT option) add \$711 to list
 FN2448EB (with ERGO ADJACENT option) add \$606 to list
 FN2472RC (with ERGO option) add \$4,835 to list



Example

FN3672LD (with ERGO option) add \$4,835 to list
 FN2448EB (with ERGO ADJACENT option) add \$606 to list
 FN2472RC (with ERGO ADJACENT option) add \$711 to list
 FN2472LFC (with ERGO ADJACENT option) add \$711 to list

Finale Product Information

Availability of Finale Units with the Mechanism

The following models are available with the ERGO Adjustable Work Height Mechanism.

Freestanding Units - Units below do not require adjacent products; select ERGO option and add \$4,835 to the list price.

<u>Double Pedestal Desk</u>	<u>Credenzas</u>
FN4272BD	FN2472KC
FN3672DD	FN2466KC
FN3072DD	
FN3066DD	
FN3060DD	

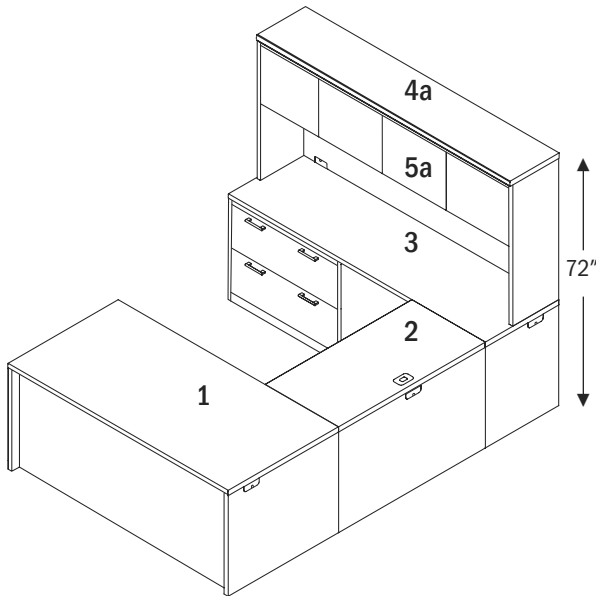
Adjacent Connecting Units - Select ERGO option for the model you wish to have height adjustment and add \$4,835 to the list price. For units, from this list, that are connecting to the ERGO model, you must select ERGO ADJACENT on each of these connecting models and add \$711 list to each model. *If the connecting model is 24"x 48" or less, add \$606 list.

<u>Single Pedestal Desk</u>	<u>Returns</u>	<u>Bridges</u>	<u>Credenzas</u>	<u>Corner Units</u>
FN4272RBD	FN2448ERR*	FN2448EB*	FN2472RC	FN4242ERC
FN4272LBD	FN2448ELR*	FN2442EB*	FN2472LC	FN4242ELCU
FN3672RD	FN2442ERR*	FN2436EB*	FN2466RC	FN4242CU
FN3672LD	FN2442ELR*		FN2466LC	
FN3072RD	FN2448ERC*			
FN3072LD	FN2448ELC*			
FN3066RD	FN2442ERC*			
FN3066LD	FN2442ELC*			

Finale Product Information

Layouts

Two heights of storage overheads are available in Finale.

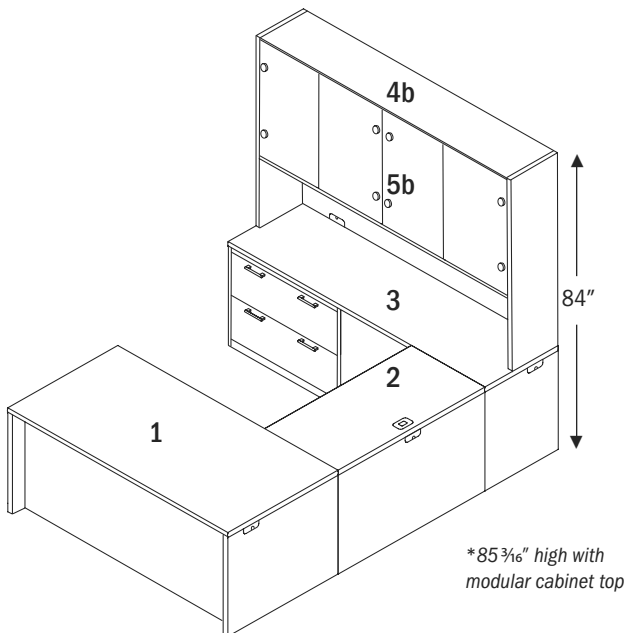


Finale is an easily specified contemporary product line, with standard office furniture sizes.

Easily specified and setup while providing well established layouts in the office environment.

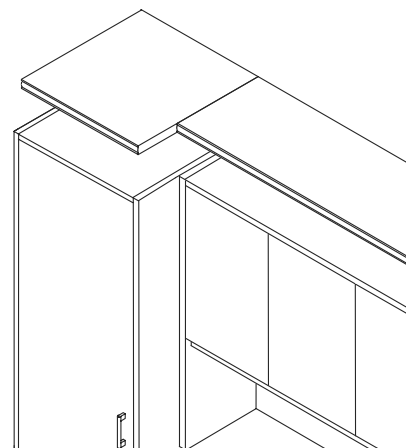
- 1 Single Pedestal Desk**, with the standard box, box, file pedestal configuration and side locking. Standard side grommet keeps the desk top clean from wires, while still having convenient wire management.
- 2 Bridge** standard with top and back panel grommet and mounting hardware.
- 3 Lateral File Credenza** available with fixed back panel.
- 4a Cabinet Top** is a standard feature on 42" high overhead cabinets.
- 4b Modular Cabinet Top** (not shown in diagram) is an option on 54" high overhead cabinet. These tops are ordered separately.
- 5a Overhead Cabinet** height is 42" for an overall height 72" Standard with left and right grommets on the back panel. Models are available with frameless glass doors in white back painted. (Locks and pulls are not available with glass doors). Models with installed cubbies are also available.
- 5b Overhead Cabinet** height is 54" for an overall height 84" (add 1 3/16" if specifying modular cabinet tops). Standard with left and right grommets on the back panel. Shown with frameless white back painted glass doors. (Locks and pulls are not available with glass doors) Models are also available in wood doors.

Note: Tackboard or panels can be ordered for the inside back of the overhead cabinet, along with the accessory rails.



Modular Cabinet Tops

Overhead Cabinets 54" tall do not come with modular cabinet tops. Tops can be specified and ordered separately. To maintain the same finish height on all units, specify tops for **ALL** adjacent units.



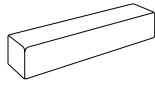
Frameless opaque glass doors in white back painted brings a nice aesthetic to the Finale product line.

Finale Product Information

Pull Style and Color Options



Arch
Matte Black (MBK)
Matte Silver (MSL)



Block
Matte Nickel (MNK)

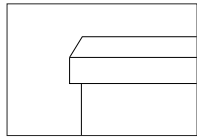


Curve
Matte Nickel (MNK)

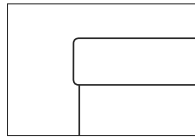


Twist
Matte Nickel (MNK)

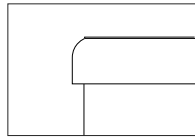
Top Edge Details



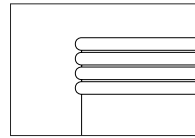
Bevel (B)



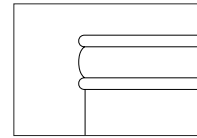
Eased (R4)



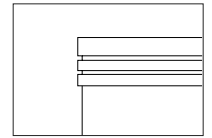
Gael (G)



Reeded (H)

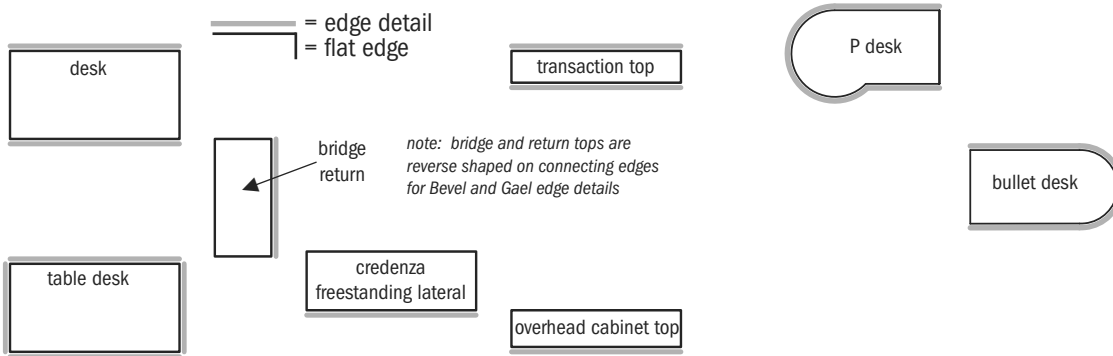


Transitional (C)

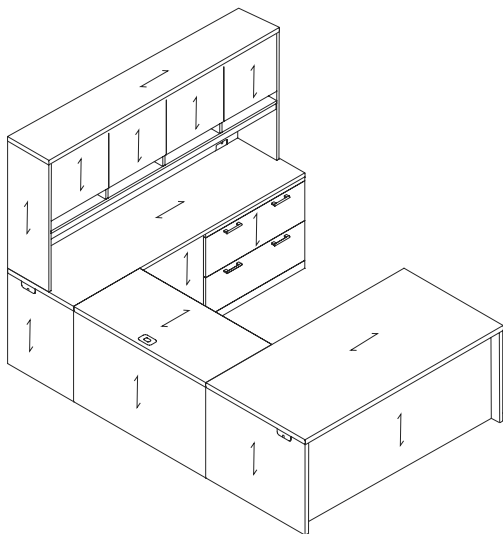


Triad (F)

Top Edge Detail Location



Standard Grain Direction

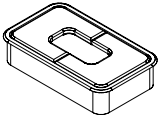


Note:
Grain direction on Return and Bridge units run short grain.

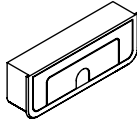
Grain on valance rails on overhead cabinet run vertical.

Finale Product Information

Grommet and Color Options



Worksurface Grommet
Matte Black (MBK)
Stardust Silver (STS)



End Panel Grommet
Matte Black (MBK)
Stardust Silver (STS)

Worksurface Grommet Locations

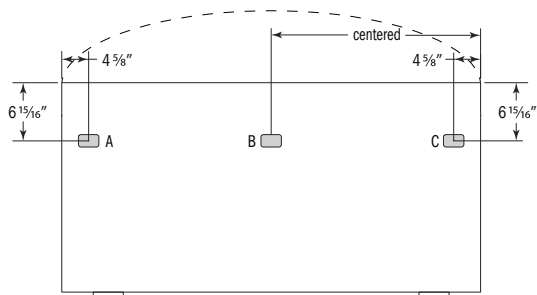
Additional worksurface grommets can be specified on desk, bridges, returns and credenzas. Grommet locations are indicated below with an (A) for left, (B) for center, (C) for right and (D) for center end.

Add \$114 to the list for each additional grommet.

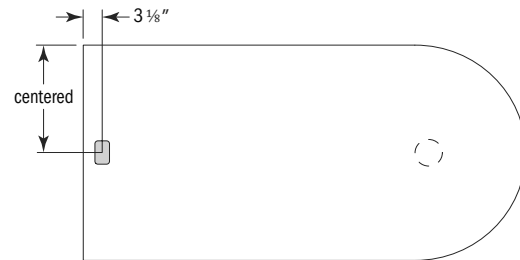
Grommet color must be specified, select Matte Black or Stardust Silver choose one color for all grommets. If no color is selected, grommet color will coordinate with the pull color. Lock cores will coordinate with grommet color

Matte Black (MBK)
Stardust Silver (STS)

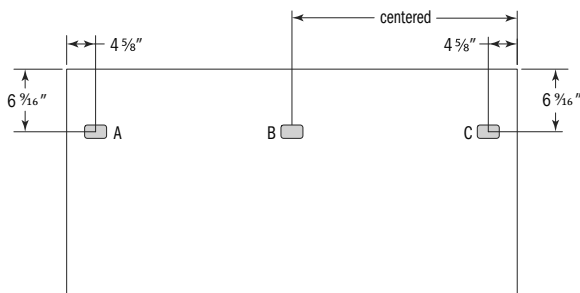
36" d Pedestal Desk



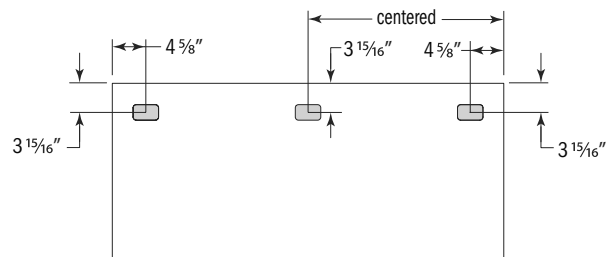
Support End and Run-Off Desk



30" d Pedestal Desk

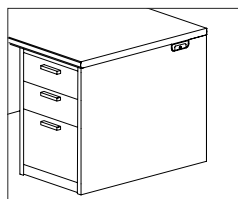


Bridges, Returns and Credenzas

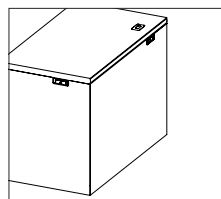


End/Back Panel Grommet

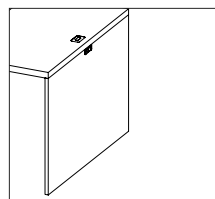
Finale features grommets and wire pass thru on all of the cabinets. This allows wiring to move from unit to unit or from unit to the data or power source. The end/back panel grommets are standard, for any special consideration contact Customer Service.



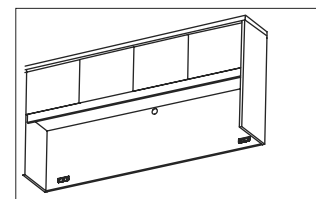
Desks - Credenza
End Panel Grommet



Returns
Work Surface Grommet
End Panel Grommet
Back Panel Grommet



Bridge
Work Surface Grommet
Back Panel Grommet

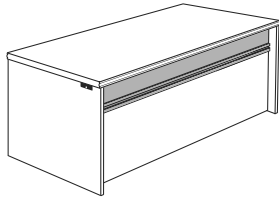


Overhead Cabinet
Back Panel Grommet
Back Center Pass Thru

Note: See the accessory section in this price list for additional wiring and power/data options.

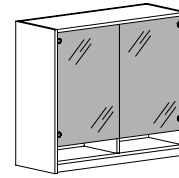
Finale Product Information

Product Trim Features and Options



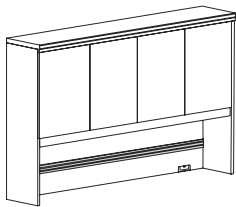
Trim Modesty Panel

- Decorative metal in 3 finishes
 - Black Sandtex (BSX)
 - Soft Nickel (SNK)
 - Stardust Silver (STS)
- Top panel in
 - Veneer
 - White Back Painted Glass (not low iron)
- Available on
 - Recess Modesty Desks
 - Table Desks
 - Bullet Desk
 - P Style Desk



Glass Doors

- Frameless Tempered Glass
 - Puck Style Hinges
 - Aluminum Color
- Back Painted Glass
 - White (not low iron)
- Available on
 - Overhead Cabinets
 - Storage Towers



Aluminum Accessory Rail

- Anodized Aluminum Finish
- Accessory Tools (see page [FN46](#))
 - Upright Tray
 - Small Tray
 - Pencil Tray
 - Paper Tray
 - File Hanger

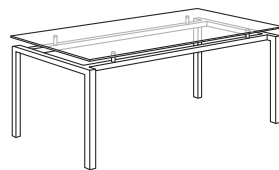
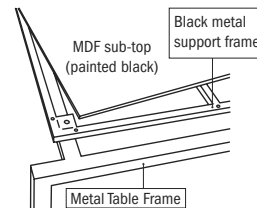


Table Desk

- Top Surface
 - Clear Glass
 - White Back Painted Glass (not low iron)
 - Veneer
 - COM (*right diagram*)
- Frame Finishes
 - Black Sandtex (BSX)
 - Soft Nickel (SNK)
 - Stardust Silver (STS)



Customer Supplies Top (COM)

- Table Frame with Support
- Allows for Unique Materials
- Frame Finishes
 - Black Sandtex (BSX)
 - Soft Nickel (SNK)
 - Stardust Silver (STS)

Finale Product Information

Finish and Reference Codes - Summary

Select	Code
Veneer	
Cherry	CH1
Maple	MA1
Walnut	WA1
Finish	
Cherry Finishes	
Bourbon Medium	BBM
Brighton Medium	BRM
Classic	CLA
Collectors	CLL
Harvest	HRV
Praline	PRL
Maples Finishes	
Ale Medium	ALM
Butterscotch	BUT
Flax	FLX
Venetian	VEN
Walnut Finishes	
Espresso	ESP
Mocha	MCH
Sienna	SIE
Truffle	TRF
Umber	UMB

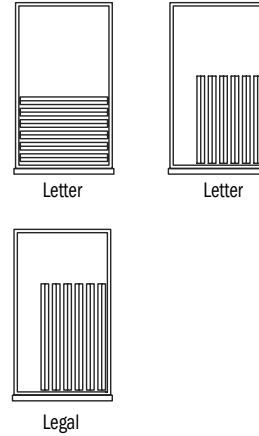
Select	Code
Edge Profile	
Bevel	B
Eased	R4
Gael	G
Reeded	H
Transitional	C
Triad	F
Pull Style and Color	
Arc - Matte Black	MBK
Arc - Matte Silver	MSL
Block - Matte Nickel	MNK
Curve - Matte Nickel	MNK
Twist - Matte Nickel	MNK
Grommet Color	
Matte Black	MBK
Stardust Silver	STS
Metal Color	
Black Sandtex	BSX
Soft Nickel	SNK
Stardust Silver	STS
Glass Color	
Clear Glass	
White Back Painted	

Finale Product Information

Desk		Drawer Configuration (User Side)	
Model	Description	Left Pedestal	Right Pedestal
FN4272BD	Double Pedestal Bow Desk	Box/Box/File	File/File
FN3672DD	Double Pedestal Desk	Box/Box/File	File/File
FN3072DD	Double Pedestal Desk	Box/Box/File	File/File
FN3066DD	Double Pedestal Desk	Box/Box/File	File/File
FN3060DD	Double Pedestal Desk	Box/Box/File	File/File
FN4272RBD	Right Pedestal Bow Desk		Box/Box/File
FN4272LBD	Left Pedestal Bow Desk	Box/Box/File	
FN3672RD	Right Pedestal Desk		Box/Box/File
FN3672LD	Left Pedestal Desk	Box/Box/File	
FN3072RD	Right Pedestal Desk		Box/Box/File
FN3072LD	Left Pedestal Desk	Box/Box/File	
FN3066RD	Right Pedestal Desk		Box/Box/File
FN3066LD	Left Pedestal Desk	Box/Box/File	

Interior Drawer Dimensions	Depth	Width	Height
Box	21"	11 7/8"	4 1/4"
File	21"	11 7/8"	9 3/8"

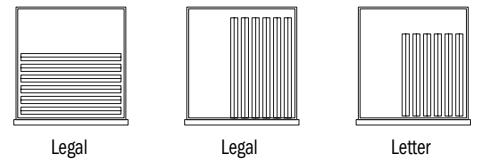
Filing Options



Mobile Pedestals		Drawer Configuration
Model	Description	Single Pedestal Width
FN1820MP	Mobile Pedestal	Box/Box/File

Interior Drawer Dimensions	Depth	Width	Height
Box	21"	14 7/8"	4 1/4"
File	15 1/4"	14 7/8"	9 3/8"

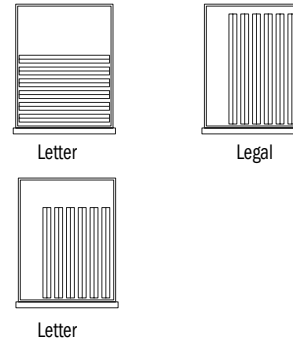
Filing Options



Executive Returns		Drawer Configuration (User Side)	
Model	Description	Left Pedestal	Right Pedestal
FN2448ERR	Right Executive Return		File/File
FN2448ELR	Left Executive Return	File/File	
FN2442ERR	Right Executive Return		File/File
FN2442ELR	Left Executive Return	File/File	
FN2448ERCR	Right Executive Return		File/File
FN2448ELCR	Left Executive Return	File/File	
FN2442ERCR	Right Executive Return		File/File
FN2442ELCR	Left Executive Return	File/File	

Interior Drawer Dimensions	Depth	Width	Height
File	15 1/4"	11 7/8"	9 3/8"

Filing Options

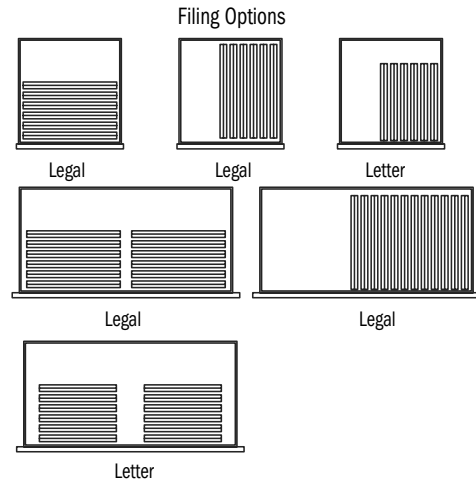


Finale Product Information

Executive Returns with Lateral File

Model	Description	Drawer Configuration (User Side)	
		Left Pedestal	Right Pedestal
FN2448LRR	Right Lateral Return		2 Lateral Drawers
FN2448LLR	Left Lateral Return	2 Lateral Drawers	
FN2448MRR	Right Multi-File Return		2 Box /File Lateral Drawers
FN2448MLR	Left Multi-File Return	2 Box /File Lateral Drawers	
FN2448LRCR	Right Lateral Return		2 Lateral Drawers
FN2448LLCR	Left Lateral Return	2 Lateral Drawers	
FN2448MRCR	Right Multi-File Return		2 Box /File Lateral Drawers
FN2448MLCR	Left Multi-File Return	2 Box /File Lateral Drawers	

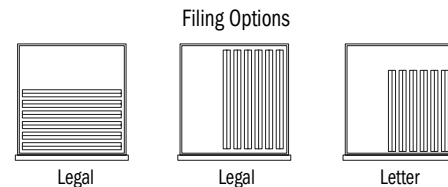
Interior Drawer Dimensions	Depth	Width	Height
Box	15 1/4"	13 7/8"	4 1/4"
File	15 1/4"	14 7/8"	9 3/8"
Lateral File	15 1/4"	31 3/8"	9 3/8"



Credenza

Model	Description	Drawer Configuration (User Side)	
		Left Pedestal	Right Pedestal
FN2472SC	Storage Credenza ¹	File/File	File/File
FN2466SC	Storage Credenza ¹	File/File	File/File
FN2472KC	Kneespace Credenza	File/File	File/File
FN2466KC	Kneespace Credenza	File/File	File/File
FN2472RC	Right Pedestal Credenza		File/File
FN2472LC	Left Pedestal Credenza	File/File	
FN2466RC	Right Pedestal Credenza		File/File
FN2466LC	Left Pedestal Credenza	File/File	
FN2472RCR	Right Pedestal Credenza		File/File
FN2472LCR	Left Pedestal Credenza	File/File	

Interior Drawer Dimensions	Depth	Width	Height
File	15 1/4"	14 7/8"	9 3/8"

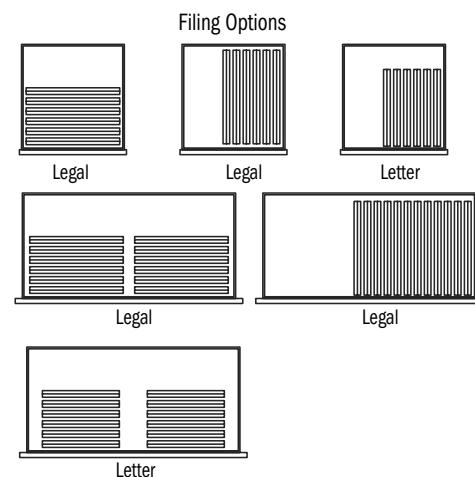


¹Center Section - Hinge Door Storage

Credenza - Lateral

Model	Description	Drawer Configuration (User Side)	
		Left Pedestal	Right Pedestal
FN2472LFC	Lateral File Credenza	2 Lateral Drawers	2 Lateral Drawers
FN2472LRC	Right Lateral File	2 Lateral Drawers	
FN2472LLC	Left Lateral File		2 Lateral Drawers
FN2472MRC	Right Multi-File Credenza		2 Box /File/Lateral
FN2472MLC	Right Multi-File Credenza		2 Box /File/Lateral

Interior Drawer Dimensions	Depth	Width	Height
Box	15 1/4"	13 7/8"	4 1/4"
File	15 1/4"	14 7/8"	9 3/8"
Lateral File	15 1/4"	31 3/8"	9 3/8"



Finale Product Information

Buffet Credenza

Model	Description	Drawer Configuration
FN2472BSC	Buffet Credenza ²	Along the Top ² 4 Box Drawers

²Bottom Section - Hinge Door Storage

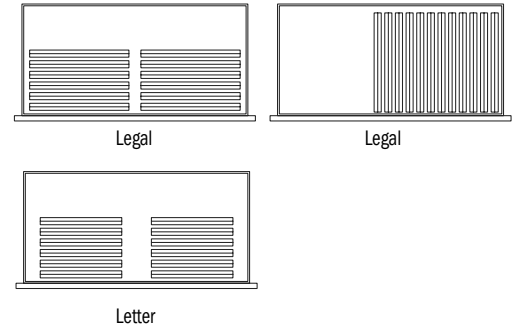
Interior Drawer Dimensions	Depth	Width	Height
Box	15 1/4"	14 3/16"	4 1/4"

Lateral File Cabinet

Model	Description	Drawer Configuration
FN3654LF	4 Drawer Lateral File Cabinet	Single Lateral Pedestal Width 4 Lateral Drawers
FN3642LF	3 Drawer Lateral File Cabinet	3 Lateral Drawers
FN3630LF	2 Drawer Lateral File Cabinet	2 Lateral Drawers

Interior Drawer Dimensions	Depth	Width	Height
Lateral File	15 1/4"	31 3/8"	9 3/8"

Filing Options

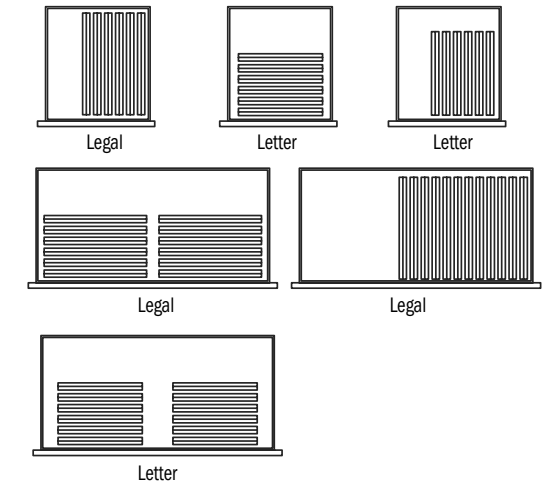


Tall Storage Cabinets

Model	Description	Drawer Configuration
FN3672SWLF	Storage Cabinet	Single Lateral Pedestal Width 2 Lower Lateral Drawers
FN2472SWR	Storage Cabinet	2 File Drawers on Lower Right
FN2472SWL	Storage Cabinet	2 File Drawers on Lower Left

Interior Drawer Dimensions	Depth	Width	Height
File	15 1/4"	11 7/8"	9 3/8"
Lateral File	15 1/4"	31 3/8"	9 3/8"

Filing Options



Additional Drawer Sizes

Center Drawer - FN1825CD
Interior Sizes - 15 1/4" d x 21 15/16" w x 2" h

Description	D	W	H	CTN WT	CU FT	① Model	List Price
-------------	---	---	---	-----------	----------	---------	------------



- box/box/file left pedestal; file/file right pedestal
- letter width pedestals
- optional center drawer, model FN1825CD. See page [FN76](#).
- pedestal locking
- top edge profile on user and approach sides
- two end panel grommets standard
- 6" overhang on approach side
- chassis - 36" x 71 3/4"
- kneespace - 38 1/2"

Double Pedestal Desk 	36	71 3/4	30	340	53	FN3672DD	\$4,635
	30	71 3/4	30	368	44	FN3072DD	\$4,562
	30	65 3/4	30	320	41	FN3066DD	\$4,495
	30	59 3/4	30	300	37	FN3060DD	\$4,423

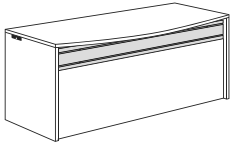
- box/box/file left pedestal; file/file right pedestal
- letter width pedestals
- optional center drawer, model FN1825CD. See page [FN76](#).
- pedestal locking
- top edge profile on user and approach sides
- two end panel grommets standard
- FN3672DD and FN3072DD kneespace - 38 1/2"
- FN3066DD kneespace - 32 1/2"
- FN3060DD kneespace - 26 1/2"

Glass Trim Modesty Panel 	3/4	68 1/2	6 1/2	13	2	FN0772AMP coordinates with: FN4272BD FN3672DD FN3072DD FN4272RBD FN3672RD FN3072RD FN4272LBD FN3672LD FN3072LD	\$697
	3/4	62 1/2	6 1/2	12	2	FN0766AMP coordinates with: FN3066DD FN3066RD FN3066LD	\$684
	3/4	56 1/2	6 1/2	11	2	FN0760AMP coordinates with: FN3060DD	\$676

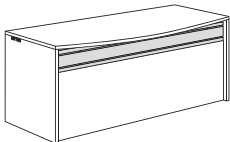
- white back painted glass panel
- field installed

Metal Trim Modesty Panel 	2	68 1/2	7	18	2	FN0772GRMP coordinates with: FN4272BD FN3672DD FN3072DD FN4272RBD FN3672RD FN3072RD FN4272LBD FN3672LD FN3072LD	\$1,354
	2	62 1/2	7	17	2	FN0766GRMP coordinates with: FN3066DD FN3066RD FN3066LD	\$1,339
	2	56 1/2	7	16	2	FN0760GRMP coordinates with: FN3060DD	\$1,320

- five metal tubes - specify metal color option: Black Sandtex, Soft Nickel or Stardust Silver
- field installed

Description	D	W	H	CTN WT	CU FT	① Model	List Price
Metal/Glass Trim Modesty Panel 	2	68 ½	7	15	2	FN0772GAMP coordinates with: FN4272BD FN3672DD FN3072DD FN4272RBD FN3672RD FN3072RD FN4272LBD FN3672LD FN3072LD	\$1,635
	2	62 ½	7	14	2	FN0766GAMP coordinates with: FN3066DD FN3066RD FN3066LD	\$1,620
	2	56 ½	7	13	2	FN0760GAMP coordinates with: FN3060DD	\$1,612

- two metal tubes - specify metal color option: Black Sandtex, Soft Nickel or Stardust Silver
- white back painted glass panel insert
- field installed

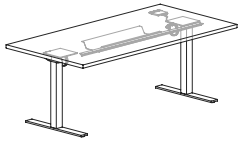
Metal/Veneer Trim Modesty Panel 	2	68 ½	7	13	2	FN0772GVMP coordinates with: FN4272BD FN3672DD FN3072DD FN4272RBD FN3672RD FN3072RD FN4272LBD FN3672LD FN3072LD	\$1,542
	2	62 ½	7	12	2	FN0766GVMP coordinates with: FN3066DD FN3066RD FN3066LD	\$1,524
	2	56 ½	7	11	2	FN0760GVMP coordinates with: FN3060DD	\$1,512

- two metal tubes - specify metal color option: Black Sandtex, Soft Nickel or Stardust Silver
- veneer panel insert - specify finish option: see page [FN16](#)
- field installed

To Order, Specify:

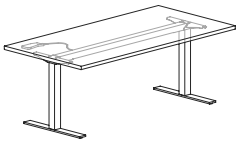
- ① Model Number
- ② Wood Species - Cherry (CH1), Maple (MA1) or Walnut (WA1)
(see page [FN16](#))
- ③ Finish Color - (see page [FN16](#))
- ④ Edge Profile - (see page [FN16](#))
- ⑤ Pull Style and Color - (see page [FN16](#))
- ⑥ Grommet Color - (see page [FN16](#))
- ⑦ Metal Color - (see page [FN16](#))
- ⑧ Other Product Options (see page [FN9](#))
- ⑨ Accessories, Power and Data Options (see [accessories price list](#))

Description	D	W	H	CTN WT	CU FT	① Model	List Price
Electric Adjustable Height Table Desk	36	72	Adj.	194	18	FN3672AHTD-EL	\$3,465
	30	72	Adj.	175	16	FN3072AHTD-EL	\$3,332
	30	66	Adj.	168	15	FN3066AHTD-EL	\$3,293
	30	60	Adj.	160	14	FN3060AHTD-EL	\$3,254
	24	72	Adj.	151	12	FN2472AHTD-EL	\$3,200
	24	66	Adj.	146	11	FN2466AHTD-EL	\$3,166
	24	60	Adj.	140	10	FN2460AHTD-EL	\$3,136



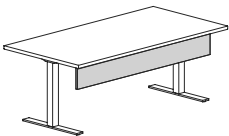
- 22 ½" - 49" height adjustment
- top edge profile on user and approach sides
- push button control pad mounted right or left
- maximum weight rating 140 lbs. (evenly distributed load)
- key pad features height display with three memory settings
- display will reference position to the nearest ½"
- 120" power cord
- specify Matte Black (MBK) or Arctic Silver (STS) base finish
- ships KD

Pneumatic Adjustable Height Table Desk	36	72	Adj.	194	18	FN3672AHTD-PN	\$6,069
	30	72	Adj.	175	16	FN3072AHTD-PN	\$5,807
	30	66	Adj.	168	15	FN3066AHTD-PN	\$5,636
	30	60	Adj.	160	14	FN3060AHTD-PN	\$5,458
	24	72	Adj.	151	12	FN2472AHTD-PN	\$5,437
	24	66	Adj.	146	11	FN2466AHTD-PN	\$5,343
	24	60	Adj.	140	10	FN2460AHTD-PN	\$5,227



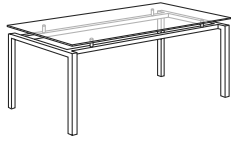
- 27 ½" - 44 ½" height adjustment
- top edge profile on user and approach sides
- release lever mounts under edge of top
- 20 lb lift force/ max weight rating 140 lbs. (evenly distributed load)
- specify Matte Black or Alloy base finish
- ships KD

Modesty Panels for Adjustable Height Tables	¾	64	9	18	3	FN0964TDM	\$811
	¾	58	9	16	2	FN0958TDM	\$785
	¾	52	9	14	2	FN0952TDM	\$758



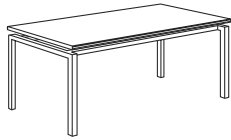
- FN0964TDM use with 72" wide adjustable height desk
- FN0958TDM use with 66" wide adjustable height desk
- FN0952TDM use with 60" wide adjustable height desk
- flat edge detail
- modesty panel bracket is available in Black Sandtex (BSX) or Stardust Silver (STS)

Description	D	W	H	CTN WT	CU FT	① Model	List Price
Metal Frame Table Desk with Glass Top	36	72	30	195	53	FN3672TDG	\$5,908



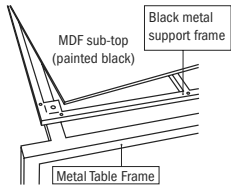
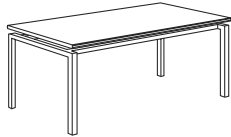
- metal 2" square tube frame - specify metal color option: Black Sandtex, Soft Nickel or Stardust Silver
- clear glass or white back painted glass top
- floor to frame knee height clearance 25 1/2"
- glass top crated for shipment
- 1/2 tempered glass top

Metal Frame Table Desk with Veneer Top	36	72	30	195	53	FN3672TDV	\$5,886
---	----	----	----	-----	----	------------------	----------------



- metal 2" square tube frame - specify metal color option: Black Sandtex, Soft Nickel or Stardust Silver
- black support for veneer top included
- floor to frame knee height clearance 25 1/2"
- wood species, finish and edge profile must be specified
- field assembly of veneer top to metal base frame

Metal Frame Table Desk for COM Top	36	72	30	195	53	FN3672TDX	\$5,844
---	----	----	----	-----	----	------------------	----------------

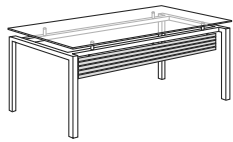


- includes: table desk frame, black metal support and black MDF sub top
- CUSTOMER MUST SUPPLY WORK SURFACE AND INSTALLATION AT FINAL DESTINATION
- metal 2" square tube frame - specify metal color option: Black Sandtex, Soft Nickel or Stardust Silver
- black support for COM top
- floor to frame knee height clearance 25 1/2"
- field assembly of COM top support to metal base frame

To Order, Specify:

- ① Model Number
- ② Wood Species - Cherry (CH1), Maple (MA1) or Walnut (WA1)
(see page FN16)
- ③ Finish Color - (see page FN16)
- ④ Glass Surface - (see page FN16)
- ⑤ Metal Color - (see page FN16)
- ⑥ Edge Profile - (see page FN16)
- ⑦ Other Product Options (see page FN9)

Description	D	W	H	CTN WT	CU FT	① Model	List Price
-------------	---	---	---	-----------	----------	---------	------------



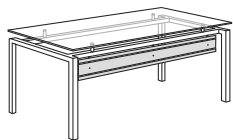
- two metal tubes - specify metal color option: Black Sandtex (BSX), Soft Nickel (SNK) or Stardust Silver (STS)
- field installed
- for use with FN3672TDG, FN3672TDV and FN3672TDX

Metal/Glass Trim Modesty Panel	2	64 ½	7	15	2	FNTD72GAMP	\$1,721
---------------------------------------	---	------	---	----	---	-------------------	----------------



- two metal tubes - specify metal color option: Black Sandtex (BSX), Soft Nickel (SNK) or Stardust Silver (STS)
- white back painted glass panel insert
- field installed
- for use with FN3672TDG, FN3672TDV and FN3672TDX

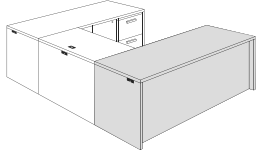
Metal/Veneer Trim Modesty Panel	2	64 ½	7	13	2	FNTD72GVMP	\$1,569
--	---	------	---	----	---	-------------------	----------------



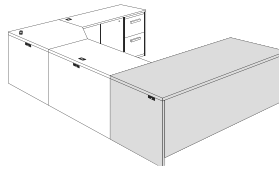
- two metal tubes - specify metal color option: Black Sandtex (BSX), Soft Nickel (SNK) or Stardust Silver (STS)
- veneer panel insert - specify finish option
- field installed
- for use with FN3672TDG, FN3672TDV and FN3672TDX

Desk Applications

Executive U



Computer U



Description	D	W	H	CTN WT	CU FT	① Model	List Price
Bow Front Single Pedestal Desk	42	71 3/4	30	400	61	FN4272RBD	\$5,108
	42	71 3/4	30	400	61	FN4272LBD	\$5,108



left shown

- box/box/file pedestal - letter width
- optional center drawer, see page FN76
- 6" overhang on approach side
- chassis - 36" x 71 3/4"
- pedestal locking
- top edge profile on user and approach side
- two end panel grommets with wire pass thru

Single Pedestal Desk	36	71 3/4	30	290	53	FN3672RD	\$4,090
	36	71 3/4	30	290	53	FN3672LD	\$4,090
	30	71 3/4	30	290	44	FN3072RD	\$3,981
	30	71 3/4	30	290	44	FN3072LD	\$3,981
	30	65 3/8	30	275	41	FN3066RD	\$3,873
	30	65 3/8	30	275	41	FN3066LD	\$3,873



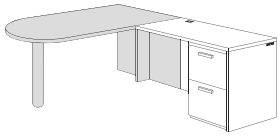
left shown

- box/box/file pedestal - letter width
- optional center drawer, see page FN76
- pedestal locking
- top edge profile on user and approach side
- two end panel grommets with wire pass thru

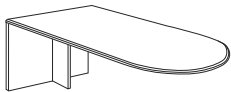
To Order, Specify:

- ① Model Number
- ② Wood Species - Cherry (CH1), Maple (MA1) or Walnut (WA1)
(see page FN16)
- ③ Finish Color - (see page FN16)
- ④ Edge Profile - (see page FN16)
- ⑤ Pull Style & Color - (see page FN16)
- ⑥ Grommet Color - (see page FN16)
- ⑦ Glass Color - (see page FN16)
- ⑧ Metal Color - (see page FN16)
- ⑨ Other Product Options (see page FN9)
- ⑩ Accessories, Power and Data Options (see accessories price list)

Peninsula Desk Applications

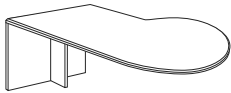


Description	D	W	H	CTN WT	CU FT	① Model	List Price
Bullet Peninsula Desk	36	72	30	135	53	FN3672B	\$3,363
	30	72	30	122	44	FN3072B	\$3,308



- edge profile on three open sides
- one end panel grommet
- trim modesty panel available, see page [FN27](#)
- non-handed
- optional center drawer available, See page [FN76](#)
- not for freestanding use
- bases must be purchased separately; see page [FN27](#) for options

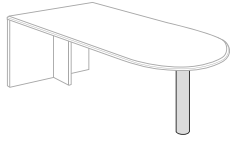
P-Top Peninsula Desk	42	72	30	155	61	FN4272RP	\$4,007
	42	72	30	155	61	FN4272LP	\$4,007



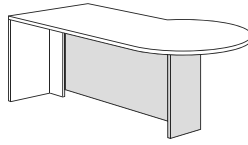
right shown

- 42" at widest point
- 36" at end panel
- edge profile on three open sides
- one end panel grommet
- trim modesty panel available, see page [FN27](#)
- optional center drawer available, See page [FN76](#)
- not for freestanding use
- bases must be purchased separately; see page [FN27](#) for options

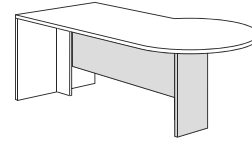
Bases Options and Modesty Panels for Peninsula Tops
(these bases must be ordered separately from the desks listed on previous page)



- Column Base**
- 04BB - Black Sandtex (BSX) \$448
 - 04NB - Soft Nickel (SNK) \$448
 - 04SB - Stardust Silver (STS) \$448



- Full Modesty Panel**
- FN2854RMP - right \$1,150
 - FN2854LMP - left \$1,150

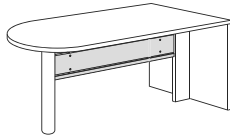


- 3/4 Modesty Panel**
- FN2154RMP - right \$1,150
 - FN2154LMP - left \$1,150

Base:

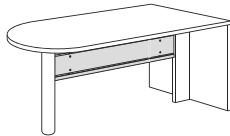
- 13 gauge steel
- 4" diameter

Description	D	W	H	CTN WT	CU FT	① Model	List Price
Trim Modesty Panel	2	42	10	10	2	FN1042GAMP	\$1,011



- two metal tubes - specify metal color option: Black Sandtex (BSX), Soft Nickel (SNK) or Stardust Silver (STS)
- white back painted glass panel insert
- field installed
- modesty panel requires special location if an optional center drawer is used

Trim Modesty Panel	2	42	10	12	2	FN1042GVMP	\$956
--------------------	---	----	----	----	---	------------	-------

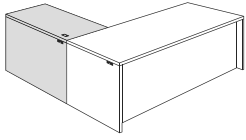


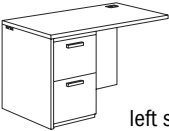
- two metal tubes - specify metal color option: Black Sandtex (BSX), Soft Nickel (SNK) or Stardust Silver (STS)
- veneer panel insert - specify finish option
- field installed
- modesty panel requires special location if an optional center drawer is used

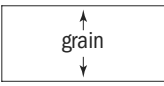
To Order, Specify:

- ① Model Number
- ② Wood Species - Cherry (CH1), Maple (MA1) or Walnut (WA1)
(see page FN16)
- ③ Finish Color - (see page FN16)
- ④ Edge Profile - (see page FN16)
- ⑤ Pull Style and Color - (see page FN16)
- ⑥ Grommet Color - (see page FN16)
- ⑦ Metal Color - (see page FN16)
- ⑧ Other Product Options (see page FN9)
- ⑨ Accessories, Power and Data Options (see accessories price list)

Return Applications - Executive L




Description	D	W	H	CTN WT	CU FT	① Model	List Price
File/File Return	23 7/8	47 7/8	30	150	25	FN2448ERR	\$3,119
	23 7/8	47 7/8	30	150	25	FN2448ELR	\$3,119
 left shown	23 7/8	41 7/8	30	140	22	FN2442ERR	\$2,813
	23 7/8	41 7/8	30	140	22	FN2442ELR	\$2,813




- top edge profile on user side
- short grain direction
- pedestal locking
- letter width file/file pedestal
- one end and back panel grommet with wire pass thru
- one surface grommet

Lateral File Return	23 7/8	47 7/8	30	170	25	FN2448LRR	\$3,895
	23 7/8	47 7/8	30	170	25	FN2448LLR	\$3,895




left shown




- top edge profile on user side
- short grain direction
- anti-tip interlock mechanism
- pedestal locking
- one end and back panel grommet with wire pass thru
- one surface grommet

Multi-File Return	23 7/8	47 7/8	30	170	25	FN2448MRR	\$4,680
	23 7/8	47 7/8	30	170	25	FN2448MLR	\$4,680

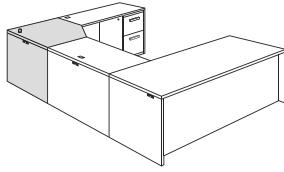



left shown



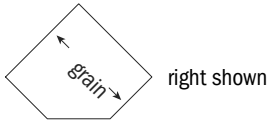
- top edge profile on user side
- short grain direction
- 36" width multi-file
- pedestal locking
- one end and back panel grommet with wire pass thru
- one surface grommet

Corner Unit Applications - Computer L



Description	D	W	H	CTN WT	CU FT	① Model	List Price
Executive Corner Unit	41 7/8	41 7/8	30	135	36	FN4242ERCU	\$3,119
	41 7/8	41 7/8	30	135	36	FN4242ELCU	\$3,119
	35 7/8	35 7/8	30	118	27	FN3636ERCU	\$2,837
	35 7/8	35 7/8	30	118	27	FN3636ELCU	\$2,837

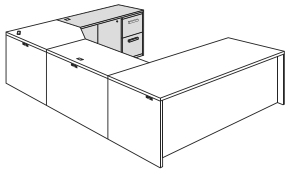
- use with corner return
- not freestanding
- one surface and two back panel grommets



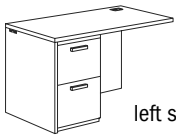
To Order, Specify:

- ① Model Number
- ② Wood Species - Cherry (CH1), Maple (MA1) or Walnut (WA1) (see page FN16)
- ③ Finish Color - (see page FN16)
- ④ Edge Profile - (see page FN16)
- ⑤ Pull Style and Color - (see page FN16)
- ⑥ Grommet Color - (see page FN16)
- ⑦ Other Product Options (see page FN9)
- ⑧ Accessories, Power and Data Options (see [accessories price list](#))

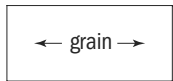
Corner Return Applications - Executive L



Description	D	W	H	CTN WT	CU FT	① Model	List Price
File/File Corner Return	23 7/8	47 7/8	30	150	25	FN2448ERCR	\$3,119
	23 7/8	47 7/8	30	150	25	FN2448ELCR	\$3,119
left shown	23 7/8	41 7/8	30	145	22	FN2442ERCR	\$2,813
	23 7/8	41 7/8	30	145	22	FN2442ELCR	\$2,813



left shown

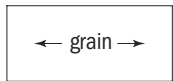


- top edge profile on user side
- long grain direction
- pedestal locking
- letter width file/file pedestal
- one end and back panel grommet with wire pass thru
- one surface grommet

Lateral File Corner Return	23 7/8	47 7/8	30	170	25	FN2448LRCR	\$3,895
	23 7/8	47 7/8	30	170	25	FN2448LLCR	\$3,895



left shown

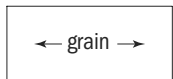


- top edge profile on user side
- long grain direction
- anti-tip interlock mechanism
- pedestal locking
- one end and back panel grommet with wire pass thru
- one surface grommet

Multi-File Corner Return	23 7/8	47 7/8	30	170	25	FN2448MRCR	\$4,680
	23 7/8	47 7/8	30	170	25	FN2448MLCR	\$4,680

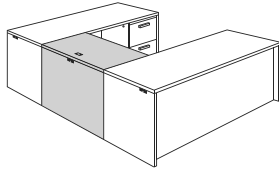


left shown

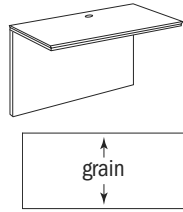


- top edge profile on user side
- long grain direction
- 36" width multi-file
- pedestal locking
- one end and back panel grommet with wire pass thru
- one surface grommet

Bridge Applications - Executive U

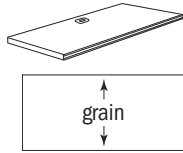


Description	D	W	H	CTN WT	CU FT	① Model	List Price
Bridge with Modesty Panel	23 ⁷ / ₈	48	30	105	5	FN2448EB	\$1,410
	23 ⁷ / ₈	42	30	85	3	FN2442EB	\$1,283
	23 ⁷ / ₈	36	30	65	3	FN2436EB	\$1,102



- top edge profile on user side
- short grain direction
- one surface grommet
- one back panel grommet

Bridge Top	23 ⁷ / ₈	48	1 ³ / ₁₆	39	4	FN4824MCT	\$1,266
	23 ⁷ / ₈	42	1 ³ / ₁₆	35	4	FN4224MCT	\$1,174
	23 ⁷ / ₈	36	1 ³ / ₁₆	29	3	FN3624MCT	\$1,040

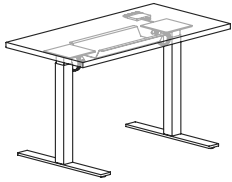


- top edge profile on user side
- short grain direction
- one surface grommet
- no modesty included; top only

To Order, Specify:

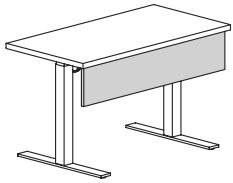
- ① Model Number
- ② Wood Species - Cherry (CH1), Maple (MA1) or Walnut (WA1)
(see page [FN16](#))
- ③ Finish Color - (see page [FN16](#))
- ④ Edge Profile - (see page [FN16](#))
- ⑤ Pull Style and Color - (see page [FN16](#))
- ⑥ Grommet Color - (see page [FN16](#))
- ⑦ Other Product Options (see page [FN9](#))
- ⑧ Accessories, Power and Data Options (see [accessories price list](#))

Description	D	W	H	CTN WT	CU FT	① Model	List Price
Electric Adjustable Height Bridge	24	46	Adj.	90	9	FN2446AHB-EL	\$3,021
	24	40	Adj.	85	8	FN2440AHB-EL	\$2,966

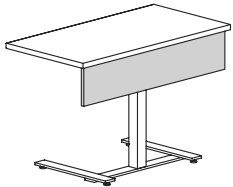


- 22 1/2" - 49" height adjustment
- top edge profile on user and approach sides
- push button control pad mounted right or left
- maximum weight rating 140 lbs. (evenly distributed load)
- key pad features height display with three memory settings
- display will reference position to the nearest 1/2"
- 120" power cord
- specify Matte Black (MBK) or Arctic Silver (STS) base finish
- ships KD

Modesty Panel for Adjustable Height Bridge	3/4	46	9	13	2	FN0946TDM	\$738
	3/4	40	9	11	2	FN0940TDM	\$716



- FN0946TDM use with 46" wide adjustable height bridge
- FN0940TDM use with 40" wide adjustable height bridge
- modesty panel bracket is available in Black Sandtex (BSX) or Stardust Silver (STS)
- flat edge detail



Description	D	W	H	CTN WT	CU FT	① Model	List Price
Storage Credenza	24	71 ¾	30	290	36	FN2472SC	\$4,711
	24	65 ¾	30	270	33	FN2466SC	\$4,575



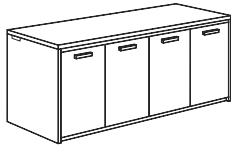
- top edge profile on user side
- file/file pedestal - legal width
- adjustable shelf in center storage
- pedestal locking
- locking doors available, specify and add \$142 list
- one back and two end panel grommets with wire pass thru

Lateral File Credenza	24	71 ¾	30	235	36	FN2472LFC	\$4,880
-----------------------	----	------	----	-----	----	-----------	---------



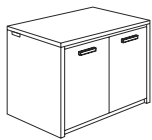
- top edge profile on user side
- two drawer lateral files side by side
- pedestal front locking
- anti-tip interlock mechanism
- two end panel grommets with wire pass thru

Four Door Credenza	24	71 ¾	30	235	36	FN2472DSC	\$4,664
--------------------	----	------	----	-----	----	-----------	---------



- top edge profile on user side
- adjustable shelves
- locking doors available, specify and add \$284 list
- two end panel grommets with wire pass thru

Two Door Credenza	24	35 ¾	30	90	19	FN3630SC	\$2,210
-------------------	----	------	----	----	----	----------	---------

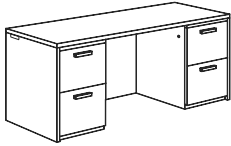


- top edge profile on user side
- one adjustable shelf
- locking doors available, specify and add \$142 list
- two end panel grommets with wire pass thru
- compatible with overhead bookcases and cabinets; see page [FN56](#)

To Order, Specify:

- ① Model Number
- ② Wood Species - Cherry (CH1), Maple (MA1) or Walnut (WA1)
(see page [FN16](#))
- ③ Finish Color - (see page [FN16](#))
- ④ Edge Profile - (see page [FN16](#))
- ⑤ Pull Style and Color - (see page [FN16](#))
- ⑥ Grommet Color - (see page [FN16](#))
- ⑦ Metal Color - (see page [FN16](#))
- ⑧ Other Product Options (see page [FN9](#))
- ⑨ Accessories, Power and Data Options (see [accessories price list](#))

Description	D	W	H	CTN WT	CU FT	① Model	List Price
Kneespace Credenza	24	71 ¾	30	270	36	FN2472KC	\$4,575
	24	65 ¾	30	255	33	FN2466KC	\$4,429



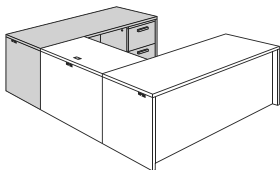
- top edge profile on user side
- file/file pedestals - legal width
- pedestal locking
- one back and two end panel grommets with wire pass thru
- kneespace for FN2472KC - 32 ½"
- kneespace for FN2466KC - 26 ½"

Buffet Credenza	24	71 ¾	36	280	43	FN2472BSC	\$6,595
-----------------	----	------	----	-----	----	-----------	---------



- top edge profile on user side
- four door credenza
- four box drawers above doors
- locking doors and drawers not available
- adjustable shelf in storage cabinet
- two end panel grommets with wire pass thru

Credenza Applications - Executive U



Description	D	W	H	CTN WT	CU FT	① Model	List Price
File/File Pedestal Credenza	23 7/8	71 ¾	30	235	36	FN2472RC	\$4,025
	23 7/8	71 ¾	30	235	36	FN2472LC	\$4,025
	23 7/8	65 ¾	30	220	33	FN2466RC	\$3,833
	23 7/8	65 ¾	30	220	33	FN2466LC	\$3,833



left shown

- top edge profile on user side
- pedestal locking
- legal width file/file pedestal
- two end panel and one back panel grommet with wire pass thru

File/File Reception Credenza	23 7/8	71 ¾	30	235	36	FN2472RCR	\$4,025
	23 7/8	71 ¾	30	235	36	FN2472LCR	\$4,025



left shown

- top edge profile on user side
- pedestal locking
- file/file pedestal - legal width
- two end panel grommets with wire pass thru
- no back panel grommets

Description	D	W	H	CTN WT	CU FT	① Model	List Price
Lateral Pedestal Credenza	23 7/8	71 3/4	30	250	36	FN2472LRC	\$4,524
	23 7/8	71 3/4	30	250	36	FN2472LLC	\$4,524



left shown

- top edge profile on user side
- pedestal locking
- anti-tip interlock mechanism
- two end panel and one back panel grommet with wire pass thru
- 36" wide lateral file

Multi-File Pedestal Credenza	23 7/8	71 3/4	30	265	36	FN2472MRC	\$4,730
	23 7/8	71 3/4	30	265	36	FN2472MLC	\$4,730

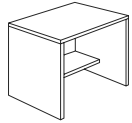


left shown

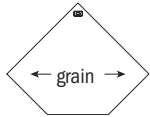
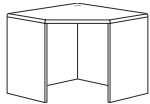
- top edge profile on user side
- pedestal locking
- 36" width multi-file
- two end panel and one back panel grommet with wire pass thru

Printer Stand	24	30	30	120	16	FN2430PS	\$2,063
---------------	----	----	----	-----	----	----------	---------

- fixed 11" deep shelf



Corner Unit	41 7/8	41 7/8	30	135	36	FN4242CU	\$3,119
	35 7/8	35 7/8	30	121	27	FN3636CU	\$2,837

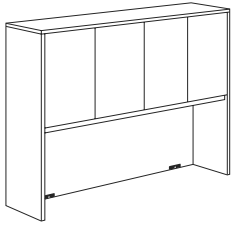


- angle grain direction on top
- one surface grommet and two back panel grommets
- freestanding
- top edge profile on user side only
- keyboard tray or mouse pad cannot be used with FN3636CU

To Order, Specify:

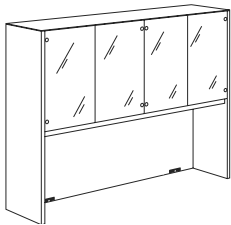
- ① Model Number
- ② Wood Species - Cherry (CH1), Maple (MA1) or Walnut (WA1)
(see page FN16)
- ③ Finish Color - (see page FN16)
- ④ Edge Profile - (see page FN16)
- ⑤ Pull Style and Color (see page FN16)
- ⑥ Grommet Color - (see page FN16)
- ⑦ Other Product Options (see page FN9)
- ⑧ Accessories, Power and Data Options (see [accessories price list](#))

Description	D	W	H	CTN WT	CU FT	① Model	List Price
Double Height Storage Overhead Cabinet with Four Doors	15 7/8	83 3/4	54	338	50	FN1684DSO	\$4,613
	15 7/8	77 3/4	54	318	47	FN1678DSO	\$4,526
	15 7/8	71 3/4	54	297	43	FN1672DSO	\$4,438
	15 7/8	65 3/4	54	262	40	FN1666DSO	\$4,254



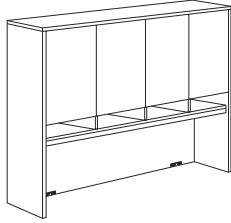
- grommet in bottom left and right and in top center of back panel
- tackboards available, see pages [FN52-FN53](#)
- task lights available, see [accessories price list](#)
- 22" vertical clearance from desk top to bottom of light soffit
- adjustable shelf
- optional modular top, see page [FN64](#)
- locking doors available, specify and add \$284 list
- no pulls
- backside of unit intended to go against wall, cabinet should be secured to wall as a safety precaution

Double Height Storage Overhead Cabinet with Four Glass Doors	15 7/8	83 3/4	54	342	50	FN1684DGSO	\$5,763
	15 7/8	77 3/4	54	323	47	FN1678DGSO	\$5,653
	15 7/8	71 3/4	54	301	43	FN1672DGSO	\$5,545
	15 7/8	65 3/4	54	266	40	FN1666DGSO	\$5,314



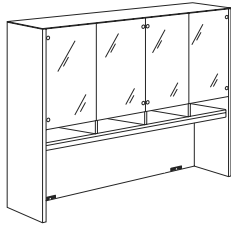
- white back painted glass doors
- grommet in bottom left and right and in top center of back panel
- tackboards available, see pages [FN52-FN53](#)
- task lights available, see [accessories price list](#)
- 22" vertical clearance from desk top to bottom of light soffit
- adjustable shelf
- optional modular top, see page [FN64](#)
- locking doors not available
- pulls not available
- backside of unit intended to go against wall, cabinet should be secured to wall as a safety precaution

Description	D	W	H	CTN WT	CU FT	① Model	List Price
Double Height Storage Overhead Cabinet with Four Doors and Cubbies	15 7/8	83 3/4	54	373	50	FN1684DSOC	\$5,562
	15 7/8	77 3/4	54	351	47	FN1678DSOC	\$5,406
	15 7/8	71 3/4	54	327	43	FN1672DSOC	\$5,287
	15 7/8	65 3/4	54	290	40	FN1666DSOC	\$5,161



- grommet in bottom left and right and in top center of back panel
- tackboards available, see pages [FN54-FN55](#)
- task lights available, see [accessories price list](#)
- 17 1/2" vertical clearance from desk top to bottom of light soffit
- adjustable shelf
- optional modular top, see page [FN64](#)
- locking doors available, specify and add \$284 list
- no pulls
- backside of unit intended to go against wall, cabinet should be secured to wall as a safety precaution

Double Height Storage Overhead Cabinet with Four Glass Doors and Cubbies	15 7/8	83 3/4	54	377	50	FN1684DGSOC	\$6,713
	15 7/8	77 3/4	54	356	47	FN1678DGSOC	\$6,536
	15 7/8	71 3/4	54	331	43	FN1672DGSOC	\$6,393
	15 7/8	65 3/4	54	294	40	FN1666DGSOC	\$6,065

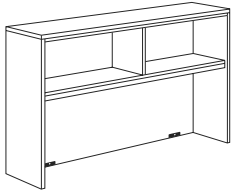


- white back painted glass doors
- grommet in bottom left and right and in top center of back panel
- tackboards available, see pages [FN54-FN55](#)
- task lights available, see [accessories price list](#)
- 17 1/2" vertical clearance from desk top to bottom of light soffit
- adjustable shelf
- optional modular top, see page [FN64](#)
- locking doors not available
- pulls not available
- backside of unit intended to go against wall, cabinet should be secured to wall as a safety precaution

To Order, Specify:

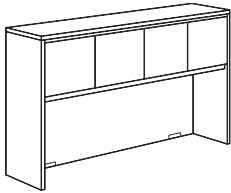
- ① Model Number
- ② Wood Species - Cherry (CH1), Maple (MA1) or Walnut (WA1)
(see page [FN16](#))
- ③ Finish Color - (see page [FN16](#))
- ④ Edge Profile - (see page [FN16](#))
- ⑤ Other Product Options (see page [FN9](#))

Description	D	W	H	CTN WT	CU FT	① Model	List Price
Open Storage Overhead Cabinet	16	83 ¾	42	238	40	FN168400	\$3,701
	16	77 ¾	42	238	37	FN167800	\$3,630
	16	71 ¾	42	228	34	FN167200	\$3,557
	16	65 ¾	42	218	32	FN166600	\$3,398



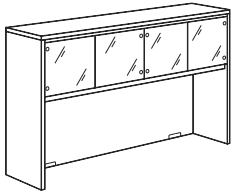
- top edge profile on user side
- grommet in bottom left and right and in top center of back panel
- tackboards available, see pages [FN52-FN53](#)
- task lights available, see [accessories price list](#)
- 22" vertical clearance from desk top to bottom of light soffit

Storage Overhead Cabinet with Four Doors	16	83 ¾	42	258	40	FN1684S0	\$3,837
	16	77 ¾	42	258	37	FN1678S0	\$3,766
	16	71 ¾	42	248	34	FN1672S0	\$3,695
	16	65 ¾	42	238	32	FN1666S0	\$3,539



- top edge profile on user side
- grommet in bottom left and right and in top center of back panel
- tackboards available, see pages [FN52-FN53](#)
- task lights available, see [accessories price list](#)
- 22" vertical clearance from desk top to bottom of light soffit
- locking doors available, specify and add \$284 list
- no pulls

Storage Overhead Cabinet with Four Glass Doors	16	83 ¾	42	258	40	FN1684GS0	\$4,418
	16	77 ¾	42	258	37	FN1678GS0	\$4,347
	16	71 ¾	42	248	34	FN1672GS0	\$4,278
	16	65 ¾	42	238	32	FN1666GS0	\$4,129



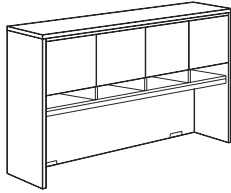
- top edge profile on user side
- white back painted glass doors
- grommet in bottom left and right and in top center of back panel
- tackboards available, see pages [FN52-FN53](#)
- task lights available, see [accessories price list](#)
- 22" vertical clearance from desk top to bottom of light soffit
- locking doors not available
- pulls not available

Description	D	W	H	CTN WT	CU FT	① Model	List Price
Open Storage Overhead Cabinet with Cubbies	16	83 ¾	42	286	40	FN168400C	\$4,653
	16	77 ¾	42	271	37	FN167800C	\$4,511
	16	71 ¾	42	258	34	FN167200C	\$4,404
	16	65 ¾	42	246	32	FN166600C	\$4,145



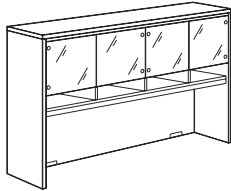
- top edge profile on user side
- grommet in bottom left and right and in top center of back panel
- tackboards available, see pages [FN54-FN55](#)
- task lights available, see [accessories price list](#)
- 17 ½" vertical clearance from desk top to bottom of light soffit

Storage Overhead Cabinet with Four Doors and Cubbies	16	83 ¾	42	306	40	FN1684S0C	\$4,789
	16	77 ¾	42	291	37	FN1678S0C	\$4,650
	16	71 ¾	42	278	34	FN1672S0C	\$4,541
	16	65 ¾	42	266	32	FN1666S0C	\$4,218



- top edge profile on user side
- grommet in bottom left and right and in top center of back panel
- tackboards available, see pages [FN54-FN55](#)
- task lights available, see [accessories price list](#)
- 17 ½" vertical clearance from desk top to bottom of light soffit
- locking doors available, specify and add \$284 list
- pulls not available

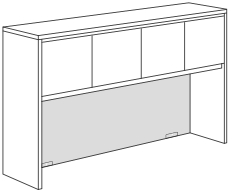
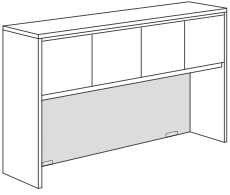
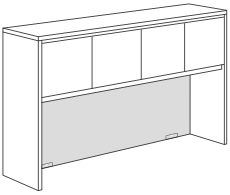
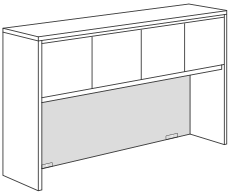
Storage Overhead Cabinet with Four Glass Doors and Cubbies	16	83 ¾	42	310	40	FN1684GS0C	\$5,365
	16	77 ¾	42	295	37	FN1678GS0C	\$5,230
	16	71 ¾	42	282	34	FN1672GS0C	\$5,126
	16	65 ¾	42	270	32	FN1666GS0C	\$4,875

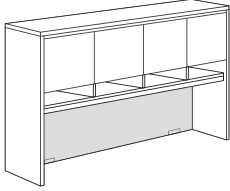


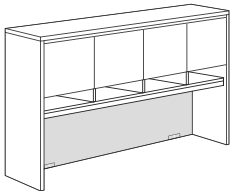
- top edge profile on user side
- white back painted glass doors
- grommet in bottom left and right and in top center of back panel
- tackboards available, see pages [FN54-FN55](#)
- task lights available, see [accessories price list](#)
- 17 ½" vertical clearance from desk top to bottom of light soffit
- adjustable shelf
- locking doors not available
- pulls not available

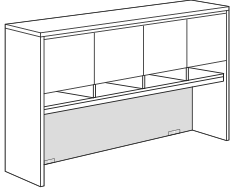
To Order, Specify:

- ① Model Number
- ② Wood Species - Cherry (CH1), Maple (MA1) or Walnut (WA1)
(see page [FN16](#))
- ③ Finish Color - (see page [FN16](#))
- ④ Edge Profile - (see page [FN16](#))
- ⑤ Knob Color - (see page [FN16](#))
- ⑥ Other Product Options (see page [FN9](#))

Description	D	W	H	CTN WT	CU FT	① Model	List Price Per Grade
Tackboard for 84" w Storage Overhead Cabinet 	¾	81 ¼	17 ⅞	3	4	FN84TK	COM \$451
							A \$493
<ul style="list-style-type: none"> · for use with 84" wide storage overhead cabinet · fabrics available; visit www.jsifurniture.com/finishes-and-materials/textiles for our textiles program · com ydg: 2 ¾ 							B \$576
							C \$721
							D \$903
							E \$1,087
							F \$1,373
							G \$1,683
							H \$2,008
							I \$2,519
							J \$3,133
	Tackboard for 78" w Storage Overhead Cabinet 	¾	75 ¼	17 ⅞	3	4	FN78TK
A \$484							
<ul style="list-style-type: none"> · for use with 78" wide storage overhead cabinet · fabrics available; visit www.jsifurniture.com/finishes-and-materials/textiles for our textiles program · com ydg: 2 ½ 							B \$559
							C \$689
							D \$857
							E \$1,024
							F \$1,283
							G \$1,561
							H \$1,860
							I \$2,324
							J \$2,884
	Tackboard for 72" w Storage Overhead Cabinet 	¾	69 ¼	17 ⅞	2	3	FN72TK
A \$453							
<ul style="list-style-type: none"> · for use with 72" wide storage overhead cabinet · fabrics available; visit www.jsifurniture.com/finishes-and-materials/textiles for our textiles program · com ydg: 2 ¼ 							B \$520
							C \$638
							D \$787
							E \$940
							F \$1,174
							G \$1,424
							H \$1,691
							I \$2,110
							J \$2,612
	Tackboard for 66" w Storage Overhead Cabinet 	¾	63 ¼	17 ⅞	2	3	FN66TK
A \$423							
<ul style="list-style-type: none"> · for use with 66" wide storage overhead cabinet · fabrics available; visit www.jsifurniture.com/finishes-and-materials/textiles for our textiles program · com ydg: 2 							B \$482
							C \$588
							D \$721
							E \$854
							F \$1,062
							G \$1,286
							H \$1,522
							I \$1,896
							J \$2,345

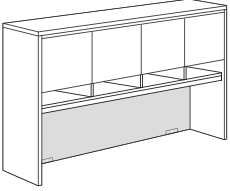
Description	D	W	H	CTN WT	CU FT	① Model	List Price Per Grade	
Tackboard for 84" w Storage Overhead Cabinet with Cubbies 	¾	81 ¼	12 ⅞	3	2	FN84TKC	COM \$451	
	<ul style="list-style-type: none"> for use with 84" wide storage overhead cabinet fabrics available; visit www.jsifurniture.com/finishes-and-materials/textiles for our textiles program com ydg: 2 ¾ 							A \$493
								B \$576
								C \$721
								D \$903
								E \$1,087
								F \$1,373
								G \$1,683
								H \$2,008
								I \$2,519
								J \$3,133

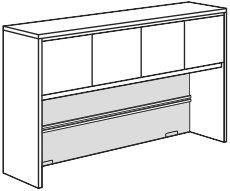
Tackboard for 78" w Storage Overhead Cabinet with Cubbies 	¾	75 ¼	12 ⅞	3	2	FN78TKC	COM \$446	
	<ul style="list-style-type: none"> for use with 78" wide storage overhead cabinet fabrics available; visit www.jsifurniture.com/finishes-and-materials/textiles for our textiles program com ydg: 2 ½ 							A \$484
								B \$559
								C \$689
								D \$857
								E \$1,024
								F \$1,283
								G \$1,561
								H \$1,860
								I \$2,324
								J \$2,884

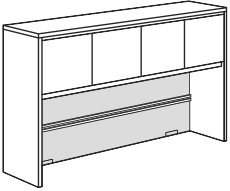
Tackboard for 72" w Storage Overhead Cabinet with Cubbies 	¾	69 ¼	12 ⅞	2	2	FN72TKC	COM \$419	
	<ul style="list-style-type: none"> for use with 72" wide storage overhead cabinet fabrics available; visit www.jsifurniture.com/finishes-and-materials/textiles for our textiles program com ydg: 2 ¼ 							A \$453
								B \$520
								C \$638
								D \$787
								E \$940
								F \$1,174
								G \$1,424
								H \$1,691
								I \$2,110
								J \$2,612

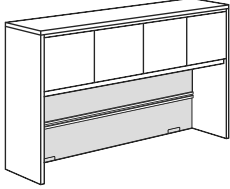
To Order, Specify:

- ① Model Number
- ② Fabric Selection: vendor, pattern color
- ③ Other Product Options (see page FN9)

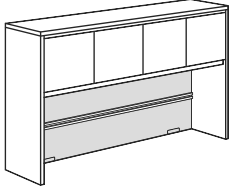
Description	D	W	H	CTN WT	CU FT	① Model	List Price Per Grade
Tackboard for 66" w Storage Overhead Cabinet with Cubbies  <ul style="list-style-type: none"> · for use with 66" wide storage overhead cabinet · fabrics available; visit www.jsifurniture.com/finishes-and-materials/textiles for our textiles program · com ydg: 2 	¾	63 ¼	12 ½	2	2	FN66TKC	COM \$394
	A \$423						
	B \$482						
	C \$588						
	D \$721						
	E \$854						
	F \$1,062						
	G \$1,286						
	H \$1,522						
	I \$1,896						
	J \$2,345						

Tackboard for Accessory Rail on 84" w Storage Overhead Cabinet  <ul style="list-style-type: none"> · tackboard panels for above and below accessory rail · not required; add-on for convenience application · fabrics available; visit www.jsifurniture.com/finishes-and-materials/textiles for our textiles program · upper tackboard height: 6 ¾ · lower tackboard height: 7 ½ · coordinates with FN1684DSO, FN1684DGSO, FN168400, FN1684SO, FN1684GSO · accessory rail sold separately, see page FN45 	¾	81 ¼		3	4	FN84TKA	COM \$503
	A \$543						
	B \$626						
	C \$770						
	D \$952						
	E \$1,136						
	F \$1,424						
	G \$1,730						
	H \$2,057						
	I \$2,570						
	J \$3,183						

Tackboard for Accessory Rail on 78" w Storage Overhead Cabinet  <ul style="list-style-type: none"> · tackboard panels for above and below accessory rail · not required; add-on for convenience application · fabrics available; visit www.jsifurniture.com/finishes-and-materials/textiles for our textiles program · upper tackboard height: 6 ¾ · lower tackboard height: 7 ½ · coordinates with FN1678DSO, FN1678DGSO, FN167800, FN1678SO, FN1678GSO · accessory rail sold separately, see page FN45 · com ydg: 2 ½ 	¾	75 ¼		3	4	FN78TKA	COM \$493
	A \$532						
	B \$605						
	C \$736						
	D \$904						
	E \$1,072						
	F \$1,331						
	G \$1,613						
	H \$1,911						
	I \$2,376						
	J \$2,932						

Description	D	W	H	CTN WT	CU FT	① Model	List Price Per Grade
Tackboard for Accessory Rail on 72" w Storage Overhead Cabinet 	3/8	69 1/4		2	3	FN72TKA	COM \$469
							A \$504
							B \$568
							C \$687
							D \$839
							E \$988
							F \$1,225
							G \$1,472
							H \$1,743
							I \$2,161
						J \$2,661	

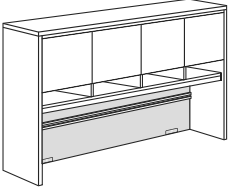
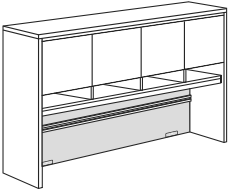
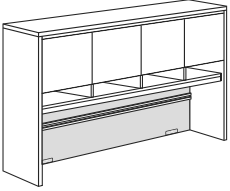
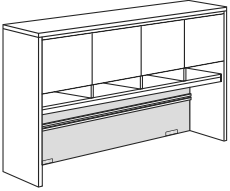
- tackboard panels for above and below accessory rail
- not required; add-on for convenience application
- fabrics available; visit www.jsifurniture.com/finishes-and-materials/textiles for our textiles program
- upper tackboard height: 6 3/8
- lower tackboard height: 7 1/2
- coordinates with FN1672DSO, FN1672DGSO, FN167200, FN1672SO, FN1672GSO
- accessory rail sold separately, see page [FN45](#)
- com ydg: 2 1/4

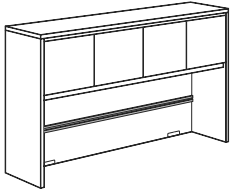
Tackboard for Accessory Rail on 66" w Storage Overhead Cabinet 	3/8	63 1/4		2	3	FN66TKA	COM \$440
							A \$472
							B \$530
							C \$634
							D \$769
							E \$902
							F \$1,111
							G \$1,334
							H \$1,570
							I \$1,943
						J \$2,391	

- tackboard panels for above and below accessory rail
- not required; add-on for convenience application
- fabrics available; visit www.jsifurniture.com/finishes-and-materials/textiles for our textiles program
- upper tackboard height: 6 3/8
- lower tackboard height: 7 1/2
- coordinates with FN1666DSO, FN1666DGSO, FN166600, FN1666SO, FN1666GSO
- accessory rail sold separately, see page [FN45](#)
- com ydg: 2

To Order, Specify:

- ① Model Number
- ② Fabric Selection: vendor, pattern color
- ③ Other Product Options (see page [FN9](#))

Description	D	W	H	CTN WT	CU FT	① Model	List Price Per Grade
Tackboard for Accessory Rail on 84" w Storage Overhead Cabinet with Cubbies	¾	81 ¼		3	2	FN84TKCA	COM \$503
							A \$543
 <ul style="list-style-type: none"> · tackboard panels for above and below accessory rail · not required; add-on for convenience application · fabrics available; visit www.jsifurniture.com/finishes-and-materials/textiles for our textiles program · upper tackboard height: 2 ¼ · lower tackboard height: 7 ½ · coordinates with FN1684DSOC, FN1684DGSOC, FN168400C, FN1684SOC, FN1684GSOC · accessory rail sold separately, see page FN45 · com ydg: 2 ¾ 							B \$626
							C \$770
							D \$952
							E \$1,136
							F \$1,424
							G \$1,730
							H \$2,057
							I \$2,570
							J \$3,183
	Tackboard for Accessory Rail on 78" w Storage Overhead Cabinet with Cubbies	¾	75 ¼		3	2	FN78TKCA
A \$532							
 <ul style="list-style-type: none"> · tackboard panels for above and below accessory rail · not required; add-on for convenience application · fabrics available; visit www.jsifurniture.com/finishes-and-materials/textiles for our textiles program · upper tackboard height: 2 ¼ · lower tackboard height: 7 ½ · coordinates with FN1678DSOC, FN1678DGSOC, FN167800C, FN1678SOC, FN1678GSOC · accessory rail sold separately, see page FN45 · com ydg: 2 ½ 							B \$605
							C \$736
							D \$904
							E \$1,072
							F \$1,331
							G \$1,613
							H \$1,911
							I \$2,376
							J \$2,932
	Tackboard for Accessory Rail on 72" w Storage Overhead Cabinet with Cubbies	¾	69 ¼		2	2	FN72TKCA
A \$504							
 <ul style="list-style-type: none"> · tackboard panels for above and below accessory rail · not required; add-on for convenience application · fabrics available; visit www.jsifurniture.com/finishes-and-materials/textiles for our textiles program · upper tackboard height: 2 ¼ · lower tackboard height: 7 ½ · coordinates with FN1672DSOC, FN1672DGSOC, FN167200C, FN1672SOC, FN1672GSOC · accessory rail sold separately, see page FN45 · com ydg: 2 ¼ 							B \$568
							C \$687
							D \$839
							E \$988
							F \$1,225
							G \$1,472
							H \$1,743
							I \$2,161
							J \$2,661
	Tackboard for Accessory Rail on 66" w Storage Overhead Cabinet with Cubbies	¾	63 ¼		2	2	FN66TKCA
A \$472							
 <ul style="list-style-type: none"> · tackboard panels for above and below accessory rail · not required; add-on for convenience application · fabrics available; visit www.jsifurniture.com/finishes-and-materials/textiles for our textiles program · upper tackboard height: 2 ¼ · lower tackboard height: 7 ½ · coordinates with FN1666DSOC, FN1666DGSOC, FN166600C, FN1666SOC, FN1666GSOC · accessory rail sold separately, see page FN45 · com ydg: 2 							B \$530
							C \$634
							D \$769
							E \$902
							F \$1,111
							G \$1,334
							H \$1,570
							I \$1,943
							J \$2,391

Description	D	W	H	CTN WT	CU FT	① Model	List Price Per Grade
Accessory Rails 	3/4	81 1/4	3 1/4	6	2	FN84AR For use on: • FN1684DGSO • FN168400 • FN1684DSO • FN1684SO • FN1684GSO	\$481
	3/4	75 1/4	3 1/4	5	2	FN78AR For use on: • FN1678DGSO • FN167800 • FN1678DSO • FN1678SO • FN1678GSO	\$457
	3/4	69 1/4	3 1/4	5	2	FN72AR For use on: • FN1672DGSO • FN167200 • FN1672DSO • FN1672SO • FN1672GSO	\$434
	3/4	63 1/4	3 1/4	4	2	FN66AR For use on: • FN1666DGSO • FN166600 • FN1666DSO • FN1666SO • FN1666GSO	\$411

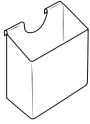
To Order, Specify:

- ① Model Number
- ② Fabric Selection: vendor, pattern color
- ③ Other Product Options (see page FN9)

FINALE

Description	D	W	H	CTN WT	CU FT	① Model	List Price
Upright Tray	1 9/16	3 1/8	3 9/16	1	1	AC203CUP	\$108

- pen and gadget cup
- Stardust Silver finish



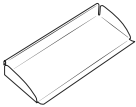
Small Tray	3 5/16	2 11/16	7/8	1	1	AC403TRAY	\$82
-------------------	--------	---------	-----	---	---	-----------	------

- tray for paper clips and other small items
- Stardust Silver finish



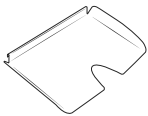
Pencil Tray	3 5/16	7 11/16	7/8	1	1	AC408TRAY	\$100
--------------------	--------	---------	-----	---	---	-----------	-------

- tray for pencils and other small items
- Stardust Silver finish



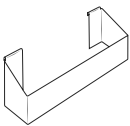
Paper Tray	9 15/16	13 3/16	7/8	2	1	AC912PAP	\$152
-------------------	---------	---------	-----	---	---	----------	-------

- tray for 8 1/2 x 11" letter paper size
- Stardust Silver finish



File Hanger	2 13/16	12 3/16	4	1	1	AC313FILE	\$144
--------------------	---------	---------	---	---	---	-----------	-------

- file hanger for 8 1/2 x 11" letter size hanging file folders
- Stardust Silver finish

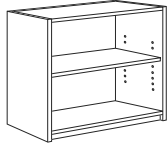


Acrylic Accessory Tray	12 1/4	9 1/4	2 1/4	5	1	ALT0912C	\$380
-------------------------------	--------	-------	-------	---	---	----------	-------

- set of 4

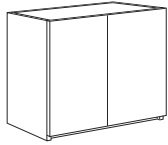


Description	D	W	H	CTN WT	CU FT	① Model	List Price
Double Height Wall Mount Open Overhead	15 7/8	41 3/4	31 1/2	125	16	FN1642DWMO	\$1,961
	15 7/8	35 3/4	31 1/2	108	14	FN1636DWMO	\$1,779
	15 7/8	29 3/4	31 1/2	99	12	FN1630DWMO	\$1,566



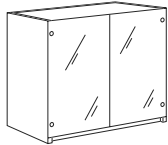
- supported by wall cleat - hardware provided by installer
- adjustable shelf
- optional modular top, see page [FN64](#)

Double Height Wall Mount Overhead Cabinet with Two Doors	15 7/8	41 3/4	31 1/2	125	16	FN1642DWMS	\$2,754
	15 7/8	35 3/4	31 1/2	113	14	FN1636DWMS	\$2,565
	15 7/8	29 3/4	31 1/2	105	12	FN1630DWMS	\$2,393



- supported by wall cleat - hardware provided by installer
- adjustable shelf
- locking doors available, specify and add \$142 list
- optional modular top, see page [FN64](#)
- no pulls

Double Height Wall Mount Overhead Cabinet with Two Glass Doors	15 7/8	41 3/4	31 1/2	135	16	FN1642DGWMS	\$3,115
	15 7/8	35 3/4	31 1/2	115	14	FN1636DGWMS	\$2,928
	15 7/8	29 3/4	31 1/2	107	12	FN1630DGWMS	\$2,759

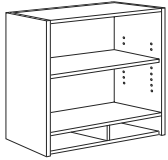


- white back painted glass doors
- supported by wall cleat - hardware provided by installer
- adjustable shelf
- optional modular top, see page [FN64](#)
- locking doors not available
- pulls not available

To Order, Specify:

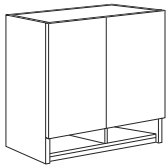
- ① Model Number
- ② Wood Species - Cherry (CH1), Maple (MA1) or Walnut (WA1) (see page [FN16](#))
- ③ Finish Color - (see page [FN16](#))
- ④ Other Product Options (see page [FN9](#))

Description	D	W	H	CTN WT	CU FT	① Model	List Price
Double Height Wall Mount Open Overhead with Cubbies	15 7/8	41 3/4	36 1/2	140	18	FN1642DWMOC	\$2,355
	15 7/8	35 3/4	36 1/2	128	16	FN1636DWMOC	\$2,173
	15 7/8	29 3/4	36 1/2	119	13	FN1630DWMOC	\$1,964



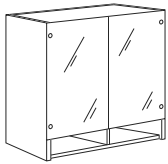
- supported by wall cleat - hardware provided by installer
- adjustable shelf
- optional modular top, see page [FN64](#)

Double Height Wall Mount Overhead Cabinet with Two Doors and Cubbies	15 7/8	41 3/4	36 1/2	150	18	FN1642DWMSC	\$3,147
	15 7/8	35 3/4	36 1/2	136	16	FN1636DWMSC	\$2,960
	15 7/8	29 3/4	36 1/2	127	13	FN1630DWMSC	\$2,789



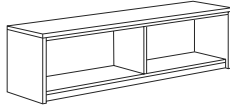
- supported by wall cleat - hardware provided by installer
- adjustable shelf
- locking doors available, specify and add \$142 list
- optional modular top, see page [FN64](#)
- no pulls

Double Height Wall Mount Overhead Cabinet with Two Glass Doors and Cubbies	15 7/8	41 3/4	36 1/2	160	18	FN1642DGMWSC	\$3,511
	15 7/8	35 3/4	36 1/2	143	16	FN1636DGMWSC	\$3,324
	15 7/8	29 3/4	36 1/2	134	13	FN1630DGMWSC	\$3,154



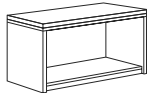
- white back painted glass doors
- supported by wall cleat - hardware provided by installer
- adjustable shelf
- optional modular top, see page [FN64](#)
- locking doors not available
- pulls not available

Description	D	W	H	CTN WT	CU FT	❶ Model	List Price
Wall Mount Open Overhead	16	71 ¾	19 ½	155	17	FN1672WMO	\$2,870
	16	65 ¾	19 ½	115	16	FN1666WMO	\$2,730



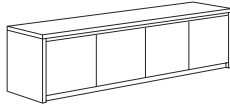
- top edge profile on user side
- supported by wall cleat - hardware provided by installer

Wall Mount Open Overhead	16	41 ¾	19 ½	95	10	FN1642WMO	\$1,569
	16	35 ¾	19 ½	80	9	FN1636WMO	\$1,426
	16	29 ¾	19 ½	65	8	FN1630WMO	\$1,255



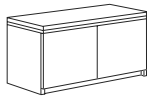
- top edge profile on user side
- supported by wall cleat - hardware provided by installer

Wall Mount Overhead Cabinet with Four Doors	16	71 ¾	19 ½	170	17	FN1672WMS	\$3,014
	16	65 ¾	19 ½	130	16	FN1666WMS	\$2,874



- top edge profile on user side
- supported by wall cleat - hardware provided by installer
- locking doors available, specify and add \$284 list
- no pulls

Wall Mount Overhead Cabinet with Two Doors	16	41 ¾	19 ½	95	10	FN1642WMS	\$2,270
	16	35 ¾	19 ½	85	9	FN1636WMS	\$2,054
	16	29 ¾	19 ½	70	8	FN1630WMS	\$1,915

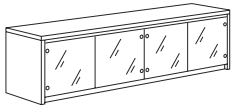


- top edge profile on user side
- supported by wall cleat - hardware provided by installer
- locking doors available, specify and add \$142 list
- no pulls

To Order, Specify:

- ❶ Model Number
- ❷ Wood Species - Cherry (CH1), Maple (MA1) or Walnut (WA1)
(see page FN16)
- ❸ Finish Color - (see page FN16)
- ❹ Edge Profile - (see page FN16)
- ❺ Other Product Options (see page FN9)

Description	D	W	H	CTN WT	CU FT	① Model	List Price
Wall Mount Overhead Cabinet with Four Glass Doors	16	71 ¾	19 ½	175	17	FN1672GWMS	\$3,740
	16	65 ¾	19 ½	135	16	FN1666GWMS	\$3,600



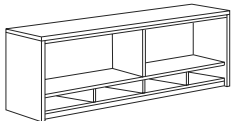
- top edge profile on user side
- supported by wall cleat - hardware provided by installer
- white back painted glass doors
- locking doors not available
- pulls not available

Wall Mount Overhead Cabinet with Two Glass Doors	16	41 ¾	19 ½	100	10	FN1642GWMS	\$2,777
	16	35 ¾	19 ½	86	9	FN1636GWMS	\$2,416
	16	29 ¾	19 ½	72	8	FN1630GWMS	\$2,278



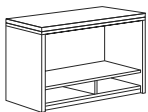
- top edge profile on user side
- supported by wall cleat - hardware provided by installer
- white back painted glass doors
- locking doors not available
- pulls not available

Wall Mount Open Overhead with Cubbies	16	71 ¾	24 ½	182	21	FN1672WMOC	\$3,264
	16	65 ¾	24 ½	170	19	FN1666WMOC	\$3,122



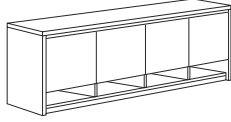
- top edge profile on user side
- supported by wall cleat - hardware provided by installer

Wall Mount Open Overhead with Cubbies	16	41 ¾	24 ½	120	12	FN1642WMOC	\$1,966
	16	35 ¾	24 ½	98	11	FN1636WMOC	\$1,823
	16	29 ¾	24 ½	85	9	FN1630WMOC	\$1,650



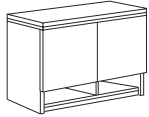
- top edge profile on user side
- supported by wall cleat - hardware provided by installer

Description	D	W	H	CTN WT	CU FT	① Model	List Price
Wall Mount Overhead Cabinet with Four Doors and Cubbies	16	71 ¾	24 ½	201	21	FN1672WMSC	\$3,407
	16	65 ¾	24 ½	188	19	FN1666WMSC	\$3,270



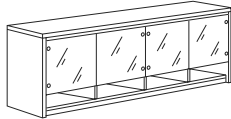
- top edge profile on user side
- supported by wall cleat - hardware provided by installer
- locking doors available, specify and add \$284 list
- no pulls

Wall Mount Overhead Cabinet with Two Doors and Cubbies	16	41 ¾	24 ½	120	12	FN1642WMSC	\$2,666
	16	35 ¾	24 ½	108	11	FN1636WMSC	\$2,448
	16	29 ¾	24 ½	92	9	FN1630WMSC	\$2,308



- top edge profile on user side
- supported by wall cleat - hardware provided by installer
- locking doors available, specify and add \$142 list
- no pulls

Wall Mount Overhead Cabinet with Four Glass Doors and Cubbies	16	71 ¾	24 ½	206	21	FN1672GWMSC	\$4,136
	16	65 ¾	24 ½	193	19	FN1666GWMSC	\$3,993



- top edge profile on user side
- supported by wall cleat - hardware provided by installer
- white back painted glass doors
- locking doors not available
- pulls not available

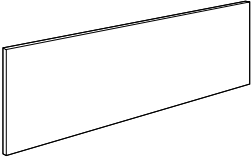
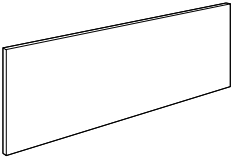
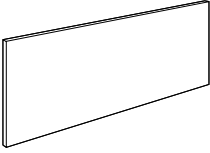
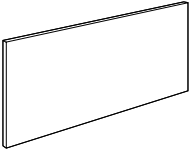
Wall Mount Overhead Cabinet with Two Glass Doors and Cubbies	16	41 ¾	24 ½	125	12	FN1642GWMSC	\$3,176
	16	35 ¾	24 ½	112	11	FN1636GWMSC	\$2,809
	16	29 ¾	24 ½	96	9	FN1630GWMSC	\$2,675

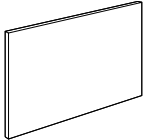


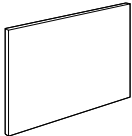
- top edge profile on user side
- supported by wall cleat - hardware provided by installer
- white back painted glass doors
- locking doors not available
- pulls not available

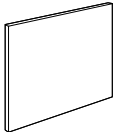
To Order, Specify:

- ① Model Number
- ② Wood Species - Cherry (CH1), Maple (MA1) or Walnut (WA1)
(see page FN16)
- ③ Finish Color - (see page FN16)
- ④ Edge Profile - (see page FN16)
- ⑤ Other Product Options (see page FN9)

Description	D	W	H	CTN WT	CU FT	① Model	List Price Per Grade
84" w Wall Mount Tackboard  <ul style="list-style-type: none"> · fabrics available; visit www.jsifurniture.com/finishes-and-materials/textiles for our textiles program · com ydg: 2 ¾ 	1 ½	83 ¾	21 ½	2	4	FN8420WT	COM \$541 A \$585 B \$665 C \$810 D \$991 E \$1,177 F \$1,464 G \$1,772 H \$2,099 I \$2,609 J \$3,224
78" w Wall Mount Tackboard  <ul style="list-style-type: none"> · fabrics available; visit www.jsifurniture.com/finishes-and-materials/textiles for our textiles program · com ydg: 2 ½ 	1 ½	77 ¾	21 ½	2	4	FN7820WT	COM \$536 A \$573 B \$648 C \$780 D \$947 E \$1,113 F \$1,372 G \$1,654 H \$1,951 I \$2,417 J \$2,972
72" w Wall Mount Tackboard  <ul style="list-style-type: none"> · fabrics available; visit www.jsifurniture.com/finishes-and-materials/textiles for our textiles program · com ydg: 2 ¼ 	1 ½	71 ¾	21 ½	2	3	FN7220WT	COM \$510 A \$544 B \$610 C \$731 D \$879 E \$1,032 F \$1,264 G \$1,515 H \$1,783 I \$2,201 J \$2,704
66" w Wall Mount Tackboard  <ul style="list-style-type: none"> · fabrics available; visit www.jsifurniture.com/finishes-and-materials/textiles for our textiles program · com ydg: 2 	1 ½	65 ¾	21 ½	2	3	FN6620WT	COM \$482 A \$512 B \$571 C \$676 D \$810 E \$944 F \$1,152 G \$1,373 H \$1,614 I \$1,986 J \$2,430

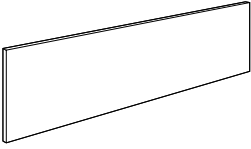
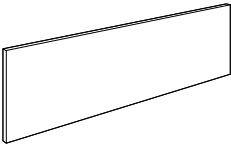
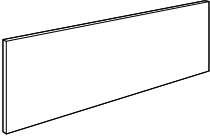
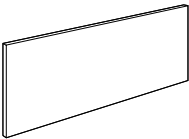
Description	D	W	H	CTN WT	CU FT	① Model	List Price Per Grade
42" w Wall Mount Tackboard	1 1/2	41 3/4	21 1/2	2	2	FN4220WT	COM \$414
 <ul style="list-style-type: none"> · fabrics available; visit www.jsifurniture.com/finishes-and-materials/textiles for our textiles program · com ydg: 1 1/2 							A \$439
							B \$482
							C \$560
							D \$660
							E \$759
							F \$917
							G \$1,085
							H \$1,263
							I \$1,543
							J \$1,877

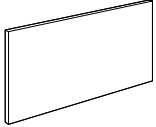
36" w Wall Mount Tackboard	1 1/2	35 3/4	21 1/2	2	2	FN3620WT	COM \$379
 <ul style="list-style-type: none"> · fabrics available; visit www.jsifurniture.com/finishes-and-materials/textiles for our textiles program · com ydg: 1 1/4 							A \$399
							B \$438
							C \$503
							D \$588
							E \$671
							F \$797
							G \$941
							H \$1,088
							I \$1,320
							J \$1,597

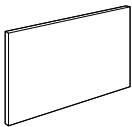
30" w Wall Mount Tackboard	1 1/2	29 3/4	21 1/2	2	2	FN3020WT	COM \$351
 <ul style="list-style-type: none"> · fabrics available; visit www.jsifurniture.com/finishes-and-materials/textiles for our textiles program · com ydg: 1 							A \$369
							B \$397
							C \$448
							D \$517
							E \$585
							F \$687
							G \$797
							H \$917
							I \$1,106
							J \$1,328

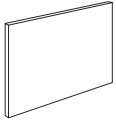
To Order, Specify:

- ① Model Number
- ② Fabric Selection: vendor, pattern color
- ③ Other Product Options (see page FN9)

Description	D	W	H	CTN WT	CU FT	① Model	List Price Per Grade
84" w Wall Mount Tackboard for Overhead Cabinet with Cubbies 	1 1/2	83 3/4	16 1/2	3	3	FN84WTC	COM \$541 A \$585 B \$665 C \$810 D \$991 E \$1,177 F \$1,464 G \$1,772 H \$2,099 I \$2,609 J \$3,224
<ul style="list-style-type: none"> · fabrics available; visit www.jsifurniture.com/finishes-and-materials/textiles for our textiles program · com ydg: 2 3/4 							
78" w Wall Mount Tackboard for Overhead Cabinet with Cubbies 	1 1/2	77 3/4	16 1/2	3	3	FN78WTC	COM \$536 A \$573 B \$648 C \$780 D \$947 E \$1,113 F \$1,372 G \$1,654 H \$1,951 I \$2,417 J \$2,972
<ul style="list-style-type: none"> · fabrics available; visit www.jsifurniture.com/finishes-and-materials/textiles for our textiles program · com ydg: 2 1/2 							
72" w Wall Mount Tackboard for Overhead Cabinet with Cubbies 	1 1/2	71 3/4	16 1/2	2	2	FN72WTC	COM \$510 A \$544 B \$610 C \$731 D \$879 E \$1,032 F \$1,264 G \$1,515 H \$1,783 I \$2,201 J \$2,704
<ul style="list-style-type: none"> · fabrics available; visit www.jsifurniture.com/finishes-and-materials/textiles for our textiles program · com ydg: 2 1/4 							
66" w Wall Mount Tackboard for Overhead Cabinet with Cubbies 	1 1/2	65 3/4	16 1/2	2	2	FN66WTC	COM \$482 A \$512 B \$571 C \$676 D \$810 E \$944 F \$1,152 G \$1,373 H \$1,614 I \$1,986 J \$2,430
<ul style="list-style-type: none"> · fabrics available; visit www.jsifurniture.com/finishes-and-materials/textiles for our textiles program · com ydg: 2 							

Description	D	W	H	CTN WT	CU FT	① Model	List Price Per Grade	
42" w Wall Mount Tackboard for Overhead Cabinet with Cubbies 	1 ½	41 ¾	16 ½	2	2	FN42WTC	COM \$414	
	<ul style="list-style-type: none"> · fabrics available; visit www.jsifurniture.com/finishes-and-materials/textiles for our textiles program · com ydg: 1 ½ 							A \$439
								B \$482
								C \$560
								D \$660
								E \$759
								F \$917
								G \$1,085
								H \$1,263
								I \$1,543
								J \$1,877

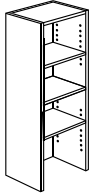
36" w Wall Mount Tackboard for Overhead Cabinet with Cubbies 	1 ½	35 ¾	16 ½	2	2	FN36WTC	COM \$379	
	<ul style="list-style-type: none"> · fabrics available; visit www.jsifurniture.com/finishes-and-materials/textiles for our textiles program · com ydg: 1 ¼ 							A \$399
								B \$438
								C \$503
								D \$588
								E \$671
								F \$797
								G \$941
								H \$1,088
								I \$1,320
								J \$1,597

30" w Wall Mount Tackboard for Overhead Cabinet with Cubbies 	1 ½	29 ¾	16 ½	2	2	FN30WTC	COM \$351	
	<ul style="list-style-type: none"> · fabrics available; visit www.jsifurniture.com/finishes-and-materials/textiles for our textiles program · com ydg: 1 							A \$369
								B \$397
								C \$448
								D \$517
								E \$585
								F \$687
								G \$797
								H \$917
								I \$1,106
								J \$1,328

To Order, Specify:

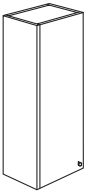
- ① Model Number
- ② Fabric Selection: vendor, pattern color
- ③ Other Product Options (see page FN9)

Description	D	W	H	CTN WT	CU FT	① Model	List Price
Double Height Open Storage Tower	15 7/8	18	54	126	12	FN1618DSO	\$1,747



- fixed center shelf, two adjustable shelves
- one back panel grommet
- optional modular top, see page [FN64](#)
- cannot be wall mounted

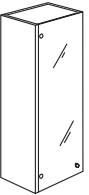
Double Height Storage Tower with 54" h Door	15 7/8	18	54	145	12	FN1618DSDR	\$1,887
	15 7/8	18	54	145	12	FN1618DSDL	\$1,887



left shown

- one fixed shelf, two adjustable shelves
- one back panel grommet
- locking door available, specify and add \$142 list
- optional modular top, see page [FN64](#)
- pull knob
- cannot be wall mounted

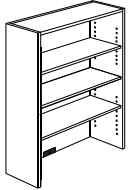
Double Height Storage Tower with 54" h Glass Door	15 7/8	18	54	147	12	FN1618DGSDR	\$2,249
	15 7/8	18	54	147	12	FN1618DGS DL	\$2,249



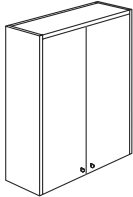
left shown

- white back painted glass doors
- one fixed shelf, two adjustable shelves
- one back panel grommet
- locking door not available
- optional modular top, see page [FN64](#)
- pull knob
- cannot be wall mounted

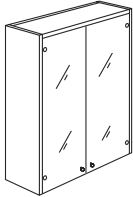
Description	D	W	H	CTN WT	CU FT	① Model	List Price
-------------	---	---	---	-----------	----------	---------	------------

Double Height Open Storage Tower 	15 ⁷ / ₈	35 ⁷ / ₈	54	175	23	FN1636DSO	\$1,815
--	--------------------------------	--------------------------------	----	-----	----	------------------	----------------

- fixed center shelf, two adjustable shelves
- one back panel grommet
- optional modular top, see page [FN64](#)
- not to be used with lateral file or storage cabinet
- to be used with credenza
- cannot be wall mounted

Double Height Storage Tower with 54" h Doors 	15 ⁷ / ₈	35 ⁷ / ₈	54	210	23	FN1636DSD	\$2,987
--	--------------------------------	--------------------------------	----	-----	----	------------------	----------------

- one fixed shelf, two adjustable shelves
- one back panel grommet
- locking doors available, specify and add \$142 list
- optional modular top, see page [FN64](#)
- pull knob
- not to be used with lateral file or storage cabinet
- to be used with credenza
- cannot be wall mounted

Double Height Storage Tower with 54" h Glass Doors 	15 ⁷ / ₈	35 ⁷ / ₈	54	212	23	FN1636DGS	\$3,349
--	--------------------------------	--------------------------------	----	-----	----	------------------	----------------

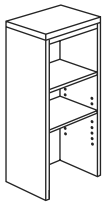
- white back painted glass doors
- one fixed shelf, two adjustable shelves
- one back panel grommet
- locking doors not available
- optional modular top, see page [FN64](#)
- pull knob
- not to be used with lateral file or storage cabinet
- to be used with credenza
- cannot be wall mounted

To Order, Specify:

- ① Model Number
- ② Wood Species - Cherry (CH1), Maple (MA1) or Walnut (WA1)
(see page [FN16](#))
- ③ Finish Color - (see page [FN16](#))
- ④ Knob Color - (see page [FN16](#))
- ⑤ Other Product Options (see page [FN9](#))

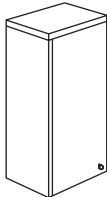
Description	D	W	H	CTN WT	CU FT	① Model	List Price
-------------	---	---	---	-----------	----------	---------	------------

Open Storage Tower	16	18	42	98	10	FN1618SO	\$1,398
---------------------------	----	----	----	----	----	-----------------	----------------



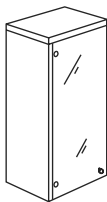
- top edge profile on user side
- fixed top shelf, one adjustable shelf
- one back panel grommet
- cannot be wall mounted

Storage Tower with 42" h Door	16	18	42	113	10	FN1618SDR	\$1,509
	16	18	42	113	10	FN1618SDL	\$1,509



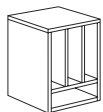
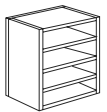
- top edge profile on user side
- one fixed shelf, one adjustable shelf
- one back panel grommet
- locking door available, specify and add \$142 list
- pull knob
- cannot be wall mounted

Storage Tower with 42" h Glass Door	16	18	42	114	10	FN1618GSDR	\$1,876
	16	18	42	114	10	FN1618GSDL	\$1,876



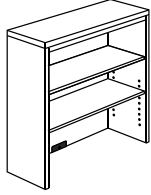
- top edge profile on user side
- white back painted glass doors
- one fixed shelf, one adjustable shelf
- one back panel grommet
- locking door not available
- pull knob
- cannot be wall mounted

Storage Tower	14	15 3/4	21	18	4	FN2116ST	\$1,277
----------------------	----	--------	----	----	---	-----------------	----------------



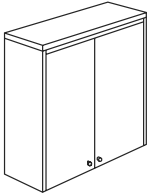
- veneer unit, not available in laminate
- paper management slots can be configured horizontally or with three vertical slots
- can be installed in storage tower or under storage overhead cabinet
- cannot be used with cubbies

Description	D	W	H	CTN WT	CU FT	① Model	List Price
Open Storage Tower	16	35 7/8	42	136	18	FN1636SO	\$1,453



- top edge profile on user side
- fixed top shelf, one adjustable shelf
- one back panel grommet
- not to be used with lateral file or storage cabinet
- to be used with credenza
- cannot be wall mounted

Storage Tower with 42" h Doors	16	35 7/8	42	166	18	FN1636SD	\$2,391
--------------------------------	----	--------	----	-----	----	----------	---------



- top edge profile on user side
- one fixed shelf, one adjustable shelf
- one back panel grommet
- locking doors available, specify and add \$142 list
- pull knob
- not to be used with lateral file or storage cabinet
- to be used with credenza
- cannot be wall mounted

Storage Tower with 42" h Glass Doors	16	35 7/8	42	168	18	FN1636GSD	\$2,755
--------------------------------------	----	--------	----	-----	----	-----------	---------



- top edge profile on user side
- white back painted glass doors
- one fixed shelf, one adjustable shelf
- one back panel grommet
- locking doors not available
- pull knob
- not to be used with lateral file or storage cabinet
- to be used with credenza
- cannot be wall mounted

To Order, Specify:

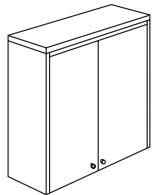
- ① Model Number
- ② Wood Species - Cherry (CH1), Maple (MA1) or Walnut (WA1)
(see page FN16)
- ③ Finish Color - (see page FN16)
- ④ Edge Profile - (see page FN16)
- ⑤ Knob Color - (see page FN16)
- ⑥ Other Product Options (see page FN9)

Description	D	W	H	CTN WT	CU FT	① Model	List Price
-------------	---	---	---	-----------	----------	---------	------------



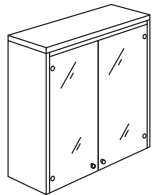
- top edge profile on user side
- one back panel grommet
- compatible with FN3630SC and FN3630LF; see pages [FN33](#) and [FN67](#)

Storage Tower	16	35 3/8	42	166	18	FN1636BD	\$2,274
----------------------	----	--------	----	-----	----	-----------------	----------------



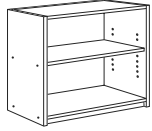
- top edge profile on user side
- one fixed shelf, one adjustable shelf
- one back panel grommet
- locking doors available, specify and add \$142 list
- pull knob
- compatible with FN3630SC and FN3630LF; see pages [FN33](#) and [FN67](#)

Glass Door Storage Tower	16	35 3/8	42	168	18	FN1636GBD	\$2,647
---------------------------------	----	--------	----	-----	----	------------------	----------------



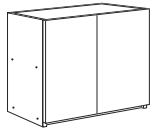
- top edge profile on user side
- white back painted glass doors
- one fixed shelf, one adjustable shelf
- one back panel grommet
- locking doors not available
- pull knob
- compatible with FN3630SC and FN3630LF; see pages [FN33](#) and [FN67](#)

Description	D	W	H	CTN WT	CU FT	① Model	List Price
Double Height Bridge Mount Open Overhead	15 7/8	35 3/4	31 1/2	108	13	FN1636DBMO	\$1,779
	15 7/8	29 3/4	31 1/2	99	12	FN1630DBMO	\$1,566



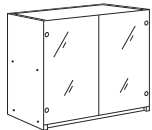
- supported by two storage towers
- adjustable shelf
- optional modular top, see page [FN64](#)
- cannot be wall mounted

Double Height Bridge Mount Overhead Cabinet with Two Doors	15 7/8	35 3/4	31 1/2	113	14	FN1636DBMS	\$2,565
	15 7/8	29 3/4	31 1/2	105	12	FN1630DBMS	\$2,393



- supported by two storage towers
- adjustable shelf
- locking doors available, specify and add \$142 list
- optional modular top, see page [FN64](#)
- no pulls
- cannot be wall mounted

Double Height Bridge Mount Overhead Cabinet with Two Glass Doors	15 7/8	35 3/4	31 1/2	115	14	FN1636DGBMS	\$2,928
	15 7/8	29 3/4	31 1/2	107	12	FN1630DGBMS	\$2,759



- white back painted glass doors
- supported by two storage towers
- adjustable shelf
- optional modular top, see page [FN64](#)
- locking doors not available
- pulls not available
- cannot be wall mounted

To Order, Specify:

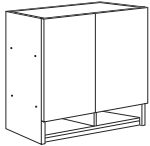
- ① Model Number
- ② Wood Species - Cherry (CH1), Maple (MA1) or Walnut (WA1)
(see page [FN16](#))
- ③ Finish Color - (see page [FN16](#))
- ④ Edge Profile - (see page [FN16](#))
- ⑤ Knob Color - (see page [FN16](#))
- ⑥ Other Product Options (see page [FN9](#))

Description	D	W	H	CTN WT	CU FT	① Model	List Price
Double Height Bridge Mount Open Overhead with Cubbies	15 7/8	35 3/4	36 1/2	128	14	FN1636DBMOC	\$2,173
	15 7/8	29 3/4	36 1/2	119	12	FN1630DBMOC	\$1,896



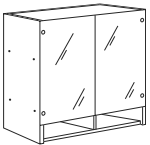
- supported by two storage towers
- adjustable shelf
- optional modular top, see page [FN64](#)
- cannot be wall mounted

Double Height Bridge Mount Overhead Cabinet with Two Doors and Cubbies	15 7/8	35 3/4	36 1/2	136	16	FN1636DBMSC	\$2,960
	15 7/8	29 3/4	36 1/2	127	13	FN1630DBMSC	\$2,722



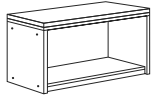
- supported by two storage towers
- adjustable shelf
- locking doors available, specify and add \$142 list
- optional modular top, see page [FN64](#)
- no pulls
- cannot be wall mounted

Double Height Bridge Mount Overhead Cabinet with Two Glass Doors and Cubbies	15 7/8	35 3/4	36 1/2	143	16	FN1636DGBMSC	\$3,324
	15 7/8	29 3/4	36 1/2	134	13	FN1630DGBMSC	\$3,154



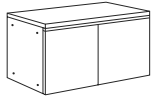
- white back painted glass doors
- supported by two storage towers
- adjustable shelf
- optional modular top, see page [FN64](#)
- locking doors not available
- pulls not available
- cannot be wall mounted

Description	D	W	H	CTN WT	CU FT	① Model	List Price
Bridge Mount Open Overhead	16	35 ¾	19 ½	80	9	FN1636BMO	\$1,426
	16	29 ¾	19 ½	65	8	FN1630BMO	\$1,255



- top edge profile on user side
- supported by two storage towers
- cannot be wall mounted

Bridge Mount Overhead Cabinet with Two Doors	16	35 ¾	19 ½	85	9	FN1636BMS	\$2,054
	16	29 ¾	19 ½	70	8	FN1630BMS	\$1,915



- top edge profile on user side
- supported by two storage towers
- locking doors available, specify and add \$142 list
- no pulls
- cannot be wall mounted

Bridge Mount Overhead Cabinet with Two Glass Doors	16	35 ¾	19 ½	86	9	FN1636GBMS	\$2,416
	16	29 ¾	19 ½	72	8	FN1630GBMS	\$2,278



- top edge profile on user side
- white back painted glass doors
- supported by two storage towers
- locking doors not available
- pulls not available
- cannot be wall mounted

To Order, Specify:

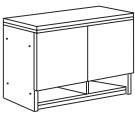
- ① Model Number
- ② Wood Species - Cherry (CH1), Maple (MA1) or Walnut (WA1)
(see page FN16)
- ③ Finish Color - (see page FN16)
- ④ Knob Color - (see page FN16)
- ⑤ Other Product Options (see page FN9)

Description	D	W	H	CTN WT	CU FT	① Model	List Price
Bridge Mount Open Overhead with Cubbies	16	35 3/4	24 1/2	102	11	FN1636BMOC	\$1,823
	16	29 3/4	24 1/2	86	9	FN1630BMOC	\$1,585



- top edge profile on user side
- supported by two storage towers
- cannot be wall mounted

Bridge Mount Overhead Cabinet with Two Doors and Cubbies	16	35 3/4	24 1/2	108	11	FN1636BMSC	\$2,448
	16	29 3/4	24 1/2	92	9	FN1630BMSC	\$2,244



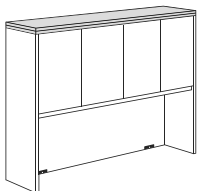
- top edge profile on user side
- supported by two storage towers
- locking doors available, specify and add \$142 list
- no pulls
- cannot be wall mounted

Bridge Mount Overhead Cabinet with Two Glass Doors and Cubbies	16	35 3/4	24 1/2	112	11	FN1636GBMSC	\$2,809
	16	29 3/4	24 1/2	96	9	FN1630GBMSC	\$2,675



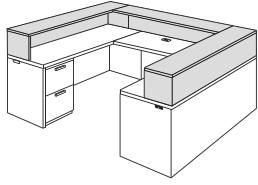
- top edge profile on user side
- white back painted glass doors
- supported by two storage towers
- locking doors not available
- pulls not available
- cannot be wall mounted

Modular Cabinet Top	16	83 3/4	1 3/16	94	6	FN1684MCT	\$1,997
	16	77 3/4	1 3/16	85	5	FN1678MCT	\$1,949
	16	71 3/4	1 3/16	76	5	FN1672MCT	\$1,898
	16	65 3/4	1 3/16	63	5	FN1666MCT	\$1,799
	16	41 3/4	1 3/16	40	3	FN1642MCT	\$1,307
	16	35 3/4	1 3/16	35	3	FN1636MCT	\$1,238
	16	29 3/4	1 3/16	29	3	FN1630MCT	\$1,184
	16	17 15/16	1 3/16	18	2	FN1618MCT	\$1,135



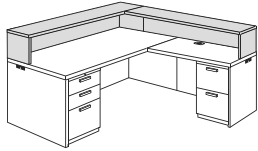
- top edge profile on user side
- field installed
- to be used with double height units only

Description	D	W	H	CTN WT	CU FT	① Model	List Price
Transaction Counter for U Unit	13	89 3/4	17 3/16	115	41	FN13186TC coordinates with FN2472RCR, FN2472LCR, and FN2442EB	\$2,598



- for U units
- 16" vertical clearance from desk to bottom of transaction top

Transaction Counter for L Unit	13	65 3/4	17 3/16	100	20	FN13114RTC coordinates with FN3066LD and FN2448ERR	\$2,113
---------------------------------------	----	--------	---------	-----	----	---	---------

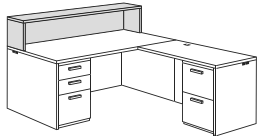


right shown

	13	65 3/4	17 3/16	100	20	FN13114LTC coordinates with FN3066RD and FN2448ELR	\$2,113
--	----	--------	---------	-----	----	---	---------

- for L units
- 16" vertical clearance from desk to bottom of transaction top

Transaction Counter	13	71 3/4	17 3/16	87	12	FN1372TC coordinates with a 71 3/4" surface	\$1,619
----------------------------	----	--------	---------	----	----	---	---------



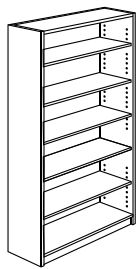
	13	65 3/4	17 3/16	79	11	FN1366TC coordinates with a 65 3/4" surface	\$1,553
--	----	--------	---------	----	----	---	---------

- 16" vertical clearance from desk to bottom of transaction top

To Order, Specify:

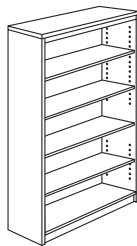
- ① Model Number
- ② Wood Species - Cherry (CH1), Maple (MA1) or Walnut (WA1)
(see page FN16)
- ③ Finish Color - (see page FN16)
- ④ Knob Color - (see page FN16)
- ⑤ Other Product Options (see page FN9)

Description	D	W	H	CTN WT	CU FT	① Model	List Price
-------------	---	---	---	-----------	----------	---------	------------



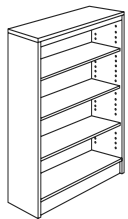
- one fixed shelf
- four adjustable shelves
- we recommend this product be mounted to the floor or wall
- optional modular top, see page [FN64](#)

Bookcase	16	36	72	150	30	FN3672BC	\$2,661
----------	----	----	----	-----	----	----------	---------



- top edge profile on user side
- one fixed shelf
- three adjustable shelves

Bookcase	16	36	54	125	23	FN3654BC	\$2,063
----------	----	----	----	-----	----	----------	---------



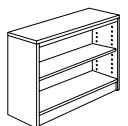
- top edge profile on user side
- three adjustable shelves

Bookcase	16	36	42	105	18	FN3642BC	\$1,756
----------	----	----	----	-----	----	----------	---------



- top edge profile on user side
- two adjustable shelves

Bookcase	16	36	30	85	13	FN3630BC	\$1,467
----------	----	----	----	----	----	----------	---------



- top edge profile on user side
- one adjustable shelf

Description	D	W	H	CTN WT	CU FT	① Model	List Price
-------------	---	---	---	-----------	----------	---------	------------

Lateral File	24	35 3/8	54	300	32	FN3654LF	\$4,129
--------------	----	--------	----	-----	----	----------	---------



- top edge profile on user side
- four drawers
- anti-tip interlock mechanism
- central locking

Lateral File	24	35 3/8	42	260	25	FN3642LF	\$3,370
--------------	----	--------	----	-----	----	----------	---------



- top edge profile on user side
- three drawers
- anti-tip interlock mechanism
- central locking

Lateral File	24	35 3/8	30	175	19	FN3630LF	\$2,724
--------------	----	--------	----	-----	----	----------	---------



- top edge profile on user side
- two drawers
- anti-tip interlock mechanism
- central locking
- two end panel grommets with wire pass thru
- for overhead bookcases and cabinets; see page [FN60](#)

Mobile Pedestal	22	18 1/16	28 1/4	95	9	FN1820MP	\$2,345
-----------------	----	---------	--------	----	---	----------	---------

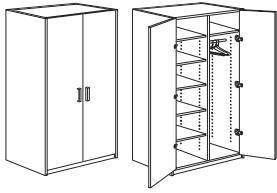


- box/box/file only
- legal width pedestal
- pedestal locking
- casters

To Order, Specify:

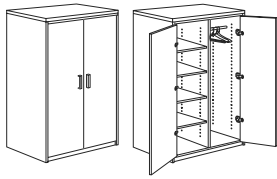
- ① Model Number
- ② Wood Species - Cherry (CH1), Maple (MA1) or Walnut (WA1)
(see page [FN16](#))
- ③ Finish Color - (see page [FN16](#))
- ④ Knob Color - (see page [FN16](#))
- ⑤ Other Product Options (see page [FN9](#))

Description	D	W	H	CTN WT	CU FT	① Model	List Price
84" h Wardrobe	23 ⁷ / ₈	35 ³ / ₈	84	335	50	FN3684W	\$5,082



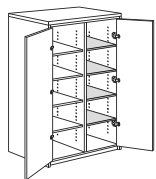
- chrome hanging bar on right
- one fixed shelf second from bottom on left
- locking doors available; specify and add \$284 list
- optional modular top, see page [FN67](#)

72" h Wardrobe	24	35 ³ / ₈	72	360	41	FN3672W	\$4,236
-----------------------	----	--------------------------------	----	-----	----	----------------	----------------

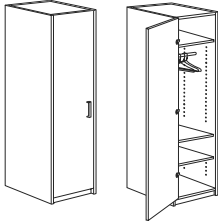


- top edge profile on user side
- chrome hanging bar on right
- one fixed shelf second from bottom on left
- locking doors available; specify and add \$284 list

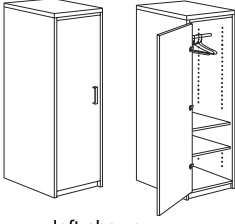
Hanging Bar to Shelves Conversion Kit	24	18	³ / ₄	56	2	FN1824SK	\$971
--	----	----	-----------------------------	----	---	-----------------	--------------



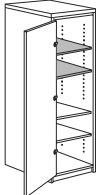
- four shelves
- for 36" wide wardrobe

Description	D	W	H	CTN WT	CU FT	① Model	List Price
84" h Wardrobe	23 7/8	17 3/4	84	260	25	FN1884WR	\$4,258
	23 7/8	17 3/4	84	260	25	FN1884WL	\$4,258
<ul style="list-style-type: none"> · chrome hanging bar at top · one fixed shelf 26 1/2" from cabinet floor · one adjustable shelf · locking door available; specify and add \$142 list · optional modular top, see page FN64 							

left shown

72" h Wardrobe	24	18	72	233	23	FN1872WR	\$3,547
	24	18	72	233	23	FN1872WL	\$3,547
<ul style="list-style-type: none"> · top edge profile on user side · chrome hanging bar at top · one fixed shelf 26 1/2" from cabinet floor · one adjustable shelf · locking door available; specify and add \$142 list 							

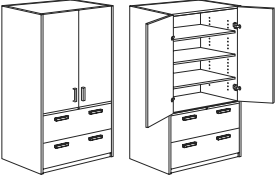
left shown

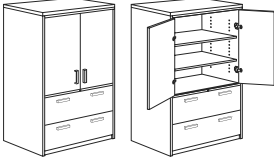
Hanging Bar to Shelves Conversion Kit	24	16	3/4	50	2	FN1624SK	\$769
	<ul style="list-style-type: none"> · two shelves · for 18" wide wardrobe 						

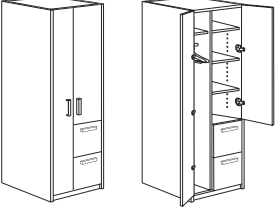
To Order, Specify:

- ① Model Number
- ② Wood Species - Cherry (CH1), Maple (MA1) or Walnut (WA1)
(see page [FN16](#))
- ③ Finish Color - (see page [FN16](#))
- ④ Edge Profile - (see page [FN16](#))
- ⑤ Pull Style and Color - (see page [FN16](#))
- ⑥ Other Product Options (see page [FN9](#))
- ⑦ Accessories, Power and Data Options (see [accessories price list](#))

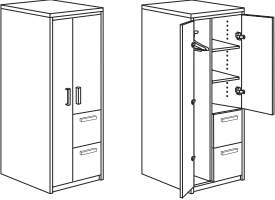
Description	D	W	H	CTN WT	CU FT	① Model	List Price
-------------	---	---	---	-----------	----------	---------	------------

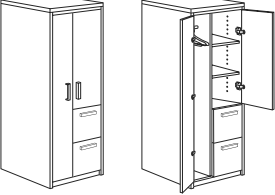
84" h File/File Lateral Storage Cabinet 	23 7/8	35 3/8	84	370	50	FN3684SWLF	\$6,556
	<ul style="list-style-type: none"> · three adjustable shelves · locking doors available; specify and add \$142 list · file/file lateral · pedestal locking · optional modular top, see page FN67 						

72" h File/File Lateral Storage Cabinet 	24	35 3/8	72	360	43	FN3672SWLF	\$5,464
	<ul style="list-style-type: none"> · two adjustable shelves · locking doors available; specify and add \$142 list · top edge profile on user side only · file/file lateral · pedestal locking 						


84" h File/File Storage Wardrobe 	23 7/8	23 5/8	84	315	34	FN2484SWR	\$4,787
	23 7/8	23 5/8	84	315	34	FN2484SWL	\$4,787

	<ul style="list-style-type: none"> · chrome hanging bar · three adjustable shelves · file/file pedestal · locking not available · optional modular top, see page FN67 						
	<p>left shown</p>						

72" h File/File Storage Wardrobe 	24	23 5/8	72	340	29	FN2472SWR	\$3,989
	24	23 5/8	72	340	29	FN2472SWL	\$3,989

	<ul style="list-style-type: none"> · top edge profile on user side · chrome hanging bar · two adjustable shelves · file/file pedestal · locking not available 						
	<p>left shown</p>						

FINALE

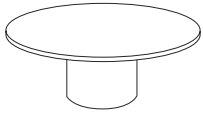
Description	D	W	H	CTN WT	CU FT	① Model	List Price
Modular Wardrobe Top 	24	35 3/8	1 3/16	38	3	FN2436MTC coordinates with: FN3684W and FN3684SWLF	\$781
	24	23 5/8	1 3/16	28	2	FN2424MTC coordinates with: FN2484SWL and FN2484SWR	\$698
	24	17 7/8	1 3/16	21	2	FN2418MTC coordinates with: FN1884WL and FN1884WR	\$653

- top edge profile on user side
- field installed
- to be used with 84" height wardrobe units only

To Order, Specify:

- ① Model Number
- ② Wood Species - Cherry (CH1), Maple (MA1) or Walnut (WA1)
(see page [FN16](#))
- ③ Finish Color - (see page [FN16](#))
- ④ Glass Surface - Clear or White Back Painted - (see page [FN16](#))
- ⑤ Metal Color - (see page [FN16](#))
- ⑥ Edge Profile - (see page [FN16](#))
- ⑦ Other Product Options (see page [FN9](#))

Description	D	W	H	CTN WT	CU FT	① Model	List Price
42" dia. Round Magazine Table	42	42	16			FN42MTD	\$2,848

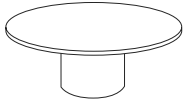


Consists of:

				56	5	FN42TT - Table Top	\$1,698
				68	5	FN18-16RB - Round Base	\$1,150

· ships KD in two cartons

36" dia. Round Magazine Table	36	36	16			FN36MTD	\$2,645
-------------------------------	----	----	----	--	--	----------------	----------------



Consists of:

				42	4	FN36TT - Table Top	\$1,495
				68	5	FN18-16RB - Round Base	\$1,150

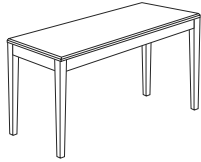
· ships KD in two cartons

Description	D	W	H	CTN WT	CU FT	① Model	List Price
Corner Table	36	36	17	79	5	FN3636CT	\$1,342



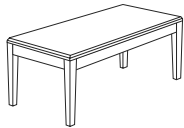
· ships KD in one carton

Sofa Table	18	60	30	66	4	FN1860ST	\$1,364
-------------------	----	----	----	----	---	-----------------	----------------



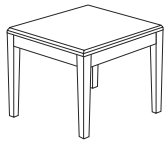
· ships KD in one carton

Magazine Table	20	42	16	51	4	FN2042MT	\$1,152
-----------------------	----	----	----	----	---	-----------------	----------------



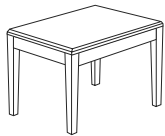
· ships KD in one carton

End Table	24	24	20	35	3	FN2424ET	\$974
------------------	----	----	----	----	---	-----------------	--------------



· ships KD in one carton

End Table	20	28	20	35	3	FN2028ET	\$971
------------------	----	----	----	----	---	-----------------	--------------

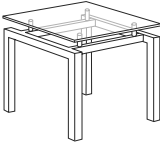


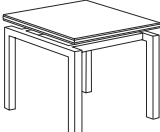
· ships KD in one carton

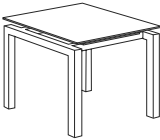
To Order, Specify:

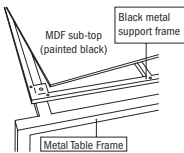
- ① Model Number
- ② Wood Species - Cherry (CH1), Maple (MA1) or Walnut (WA1)
(see page [FN16](#))
- ③ Finish Color - (see page [FN16](#))
- ④ Edge Profile - (see page [FN16](#))
- ⑤ Knob Color - (see page [FN16](#))
- ⑥ Other Product Options (see page [FN9](#))

Description	D	W	H	CTN WT	CU FT	① Model	List Price
-------------	---	---	---	-----------	----------	---------	------------

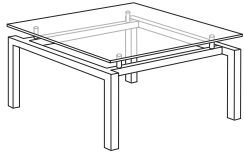
Metal Frame End Table with Glass Top  <ul style="list-style-type: none"> metal 1 1/2" square tube frame - specify metal color option: Black Sandtex (BSX), Soft Nickel (SNK) or Stardust Silver (STS) clear glass or white back painted glass top glass top crated for shipment 1/2" tempered glass top field assembly of glass top to metal base frame 	24	24	20	51	9	FN2424G-20	\$2,825
--	----	----	----	----	---	-------------------	----------------

Metal Frame End Table with Veneer Top  <ul style="list-style-type: none"> metal 1 1/2" square tube frame - specify metal color option: Black Sandtex (BSX), Soft Nickel (SNK) or Stardust Silver (STS) black support for veneer top wood species, finish and edge profile must be specified field assembly of veneer top to metal base frame 	24	24	20	51	10	FN2424V-20	\$2,799
--	----	----	----	----	----	-------------------	----------------

Metal Frame End Table for COM Top  <ul style="list-style-type: none"> includes: table frame, black metal support and black MDF sub top CUSTOMER MUST SUPPLY WORK SURFACE AND INSTALLATION AT FINAL DESTINATION metal 1 1/2" square tube frame - specify metal color option: Black Sandtex (BSX), Soft Nickel (SNK) or Stardust Silver (STS) black support for COM top field assembly of COM top support to metal base frame 	24	24	20	51	10	FN2424X-20	\$2,768
---	----	----	----	----	----	-------------------	----------------

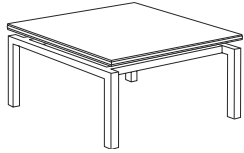


Description	D	W	H	CTN WT	CU FT	① Model	List Price
Metal Frame Magazine Table with Glass Top	36	36	17	80	16	FN3636G-17	\$3,494



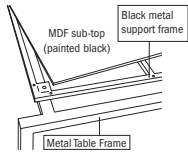
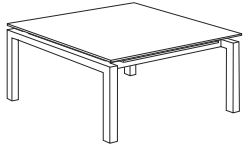
- metal 1 1/2" square tube frame - specify metal color option: Black Sandtex (BSX), Soft Nickel (SNK) or Stardust Silver (STS)
- clear glass or white back painted glass top
- glass top crated for shipment
- 1/2" tempered glass top
- field assembly of glass top to metal base frame

Metal Frame Magazine Table with Veneer Top	36	36	17	80	16	FN3636V-17	\$3,463
---	----	----	----	----	----	-------------------	----------------



- metal 1 1/2" square tube frame - specify metal color option: Black Sandtex (BSX), Soft Nickel (SNK) or Stardust Silver (STS)
- black support for veneer top
- wood species, finish and edge profile must be specified
- field assembly of veneer top to metal base frame

Metal Frame Magazine Table for COM Top	36	36	17	80	16	FN3636X-17	\$3,429
---	----	----	----	----	----	-------------------	----------------

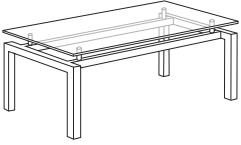


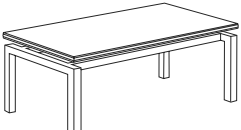
- includes: table frame, black metal support and black MDF sub top
- CUSTOMER MUST SUPPLY WORK SURFACE AND INSTALLATION AT FINAL DESTINATION
- metal 1 1/2" square tube frame - specify metal color option: Black Sandtex (BSX), Soft Nickel (SNK) or Stardust Silver (STS)
- black support for COM top
- field assembly of COM top support to metal base frame

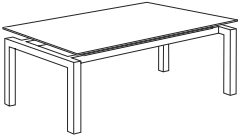
To Order, Specify:

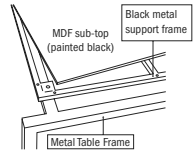
- ① Model Number
- ② Wood Species - Cherry (CH1), Maple (MA1) or Walnut (WA1)
(see page FN16)
- ③ Finish Color - (see page FN16)
- ④ Glass Surface - Clear or White Back Painted - (see page FN16)
- ⑤ Metal Color - (see page FN16)
- ⑥ Edge Profile - (see page FN16)
- ⑦ Other Product Options (see page FN9)

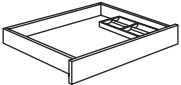
Description	D	W	H	CTN WT	CU FT	① Model	List Price
-------------	---	---	---	-----------	----------	---------	------------

Metal Frame Magazine Table with Glass Top  <ul style="list-style-type: none"> metal 1 1/2" square tube frame - specify metal color option: Black Sandtex (BSX), Soft Nickel (SNK) or Stardust Silver (STS) clear glass or white back painted glass top glass top crated for shipment 1/2" tempered glass top field assembly of glass top to metal base frame 	24	48	17	81	15	FN2448G-17	\$3,304
---	----	----	----	----	----	-------------------	----------------

Metal Frame Magazine Table with Veneer Top  <ul style="list-style-type: none"> metal 1 1/2" square tube frame - specify metal color option: Black Sandtex (BSX), Soft Nickel (SNK) or Stardust Silver (STS) black support for veneer top wood species, finish and edge profile must be specified field assembly of veneer top to metal base frame 	24	48	17	81	15	FN2448V-17	\$3,270
---	----	----	----	----	----	-------------------	----------------

Metal Frame Magazine Table for COM Top  <ul style="list-style-type: none"> includes: table frame, black metal support and black MDF sub top CUSTOMER MUST SUPPLY WORK SURFACE AND INSTALLATION AT FINAL DESTINATION metal 1 1/2" square tube frame - specify metal color option: Black Sandtex (BSX), Soft Nickel (SNK) or Stardust Silver (STS) black support for COM top field assembly of COM top support to metal base frame 	24	48	17	81	15	FN2448X-17	\$3,237
--	----	----	----	----	----	-------------------	----------------



Center Drawer  <ul style="list-style-type: none"> non-locking 	16	25	3	12	2	FN1825CD	\$477
--	----	----	---	----	---	-----------------	--------------

o Order, Specify:

- ① Model Number
- ② Wood Species - Cherry (CH1), Maple (MA1) or Walnut (WA1) (see page FN16)
- ③ Finish Color - (see page FN16)
- ④ Glass Surface - Clear or White Back Painted - (see page FN16)
- ⑤ Metal Color - (see page FN16)
- ⑥ Edge Profile - (see page FN16)
- ⑦ Other Product Options (see page FN9)

Finale Product Information

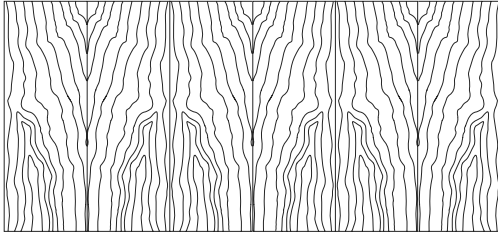


FINALE

Finale Product Information

Exterior Wood Materials

Exterior surfaces are made from the finest selected veneers to achieve clarity and consistency in the Finale product line. To attain a pleasing, symmetrical pattern, all veneers in Finale are book-matched. All exterior solid lumber is matched to coordinate with the veneer.



Book Matched Example

Alternating pieces of veneer are flipped over so they face each other like the pages within a book.

Finale is available in flat cut cherry, maple and walnut veneer. A wide range of wood stains have been formulated to enhance the beauty of the veneer.

Solid painted finishes on the veneer are also offered to provide an accent to the Finale product.

Work Surface Construction

Tops are 5-ply balanced construction, 1 3/16" thick with solid matching hardwood edges. Tops are available in six edge profile.

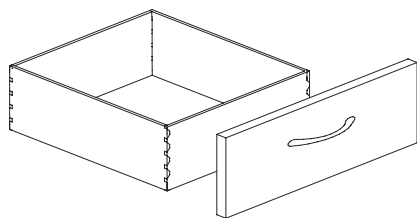
Matching or coordinating high pressure laminate in a veneer grain can be applied to the top surface and is available at no additional charge.

Base Construction

Panels are joined together by mortise and tenon construction. In addition to mortise and tenon joint construction. Leveling glides are set into solid hardwood with t-nut inserts, which helps to prevent the leveling glide from tear out. Tops are secured to the bases with top fastening cleats screwed to the inside of the panels.

Drawers

The 9ply unidirectional hardwood sides of the drawer box are 7/16" thick assembled with English dovetail construction at each corner of the box. The drawer bottom panel is 1/4" thick fitting into a groove machined into the side of the box. Interiors are sanded and coated with clear U.V. finish to protect against shrinking, swelling or warping, and to provide a clean, smooth feel and appearance.



Drawer Suspension

The high quality black drawer suspensions carry a lifetime warranty. Slides feature steel ball bearings for longer life with cushioned in/out stops. File and box drawers have 100% full extension with over travel.

Finish - Stain/Colors

We offer a variety of wood stains and paint colors on Finale. Please see the chart below. Samples are available upon request.

CH1 Cherry	<i>Flat Cut Veneer</i>		
BBM Bourbon Medium		CLL Collectors	
BRM Brighton Medium		HRV Harvest	
CLA Classic		PRL Praline	

MA1 Maple	<i>Flat Cut Veneer</i>		
ALM Ale Medium		FLX Flax	
BUT Butterscotch		VEN Venetian	

WA1 Walnut	<i>Flat Cut Veneer</i>		
ESP Espresso		TRF Truffle	
MCH Mocha		UMB Umber	
SIE Sienna			

Protective Top Coat

DuraTex™ offers exceptional hardness along with abrasion and impact resistance, it has been formulated to eliminate hazardous and harmful gases that are normally associated with wood finish.

DuraTex™ Features

Safety - Significantly reduces hazardous formaldehyde emissions, which help improve the quality of the of the indoor air we breathe.

Quality - Developed to be tough and durable with special attention to appearance. The DuraTex™ finish preserves the natural beauty of wood.

Durability - Designed to meet a wide range of demanding performance and environmental standards to withstand even the highest wear and tear.

Finale Product Information

Product Modification

Laminate Tops

Worksurface only, no additional upcharge if coordinating wood grain laminate is specified. Contact Customer Service for any other laminate request. Listed below are finishes that have coordinating wood grain HPL laminates.

CH1 Cherry *Flat Cut Veneer*

CLL Collectors

HRV Harvest

PRL Praline

WA1 Walnut *Flat Cut Veneer*

MCH Mocha TRF Truffle

SIE Sienna UMB Umber

Special Finishes

Special finishes can be requested by following the instruction in the general introduction section, page 5. There is a one time charge of \$372 list per order.

Finish Sheen

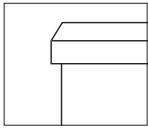
All veneer finishes for Finale are standard in 35-sheen. All other finishes can have their sheen modified with a 15% upcharge added to the list price of each item.

Species Change

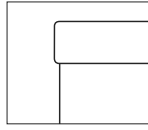
For species changes contact customer service for a quote.

Finale Product Information

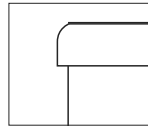
Top Edge Details



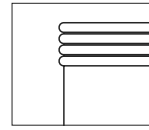
Bevel (B)



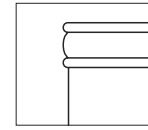
Eased (R4)



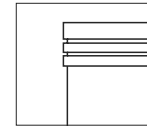
Gael (G)



Reeded (H)



Transitional (C)



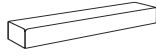
Triad (F)

Drawer Style Color Options

Finish Color MBK = Matte Black MNK = Matte Nickel MSL = Matte Silver



Arch
(MBK or MSL)



Block
(MNK)



Curve
(MNK)

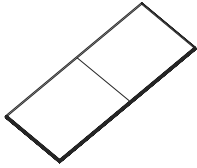


Twist
(MNK)

Top Shapes - size - base requirement - seating capacity

top sizes 108" through 192" are 2 pieces

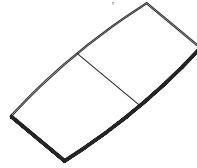
top sizes above 192" are 3 pieces



Size	Base Requirement	Seating Capacity
264" x 60"	4 bases	seats 24
240" x 60"	4 bases	seats 22
216" x 60"	4 bases	seats 20
192" x 60"	3 bases	seats 18
264" x 54"	4 bases	seats 22
240" x 54"	4 bases	seats 20
216" x 54"	4 bases	seats 18
192" x 54"	3 bases	seats 16
264" x 48"	4 bases	seats 22
240" x 48"	4 bases	seats 20
216" x 48"	4 bases	seats 18
192" x 48"	3 bases	seats 16
168" x 48"	3 bases	seats 14
144" x 48"	3 bases	seats 12
120" x 48"	2-3* bases	seats 8
120" x 42"	2-3* bases	seats 8
108" x 42"	2 bases	seats 8
96" x 48"	2 bases	seats 8
96" x 42"	2 bases	seats 8
84" x 42"	2 bases	seats 8
72" x 36"	2 bases	seats 6



Size	Base Requirement	Seating Capacity
264" x 60"	4 bases	seats 24
240" x 60"	4 bases	seats 22
216" x 60"	4 bases	seats 20
192" x 60"	3 bases	seats 18
264" x 54"	4 bases	seats 22
240" x 54"	4 bases	seats 20
216" x 54"	4 bases	seats 18
192" x 54"	3 bases	seats 16
264" x 48"	4 bases	seats 22
240" x 48"	4 bases	seats 20
216" x 48"	4 bases	seats 18
192" x 48"	3 bases	seats 16
168" x 48"	3 bases	seats 14
144" x 48"	3 bases	seats 12
120" x 48"	2-3* bases	seats 8
120" x 42"	2-3* bases	seats 8
108" x 42"	2 bases	seats 8
96" x 48"	2 bases	seats 8
96" x 42"	2 bases	seats 8
84" x 42"	2 bases	seats 8
72" x 36"	2 bases	seats 6

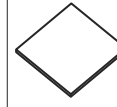


Size	Base Requirement	Seating Capacity
264" x 60"	4 bases	seats 24
240" x 60"	4 bases	seats 22
216" x 60"	4 bases	seats 20
192" x 60"	3 bases	seats 18
264" x 54"	4 bases	seats 22
240" x 54"	4 bases	seats 20
216" x 54"	4 bases	seats 18
192" x 54"	3 bases	seats 16
264" x 48"	4 bases	seats 22
240" x 48"	4 bases	seats 20
216" x 48"	4 bases	seats 18
192" x 48"	3 bases	seats 16
168" x 48"	3 bases	seats 14
144" x 48"	3 bases	seats 12
120" x 48"	2-3* bases	seats 8
120" x 42"	2-3* bases	seats 8
108" x 42"	2 bases	seats 8
96" x 48"	2 bases	seats 8
96" x 42"	2 bases	seats 8
84" x 42"	2 bases	seats 8
72" x 36"	2 bases	seats 6



Size	Base Requirement	Seating Capacity
60" dia.	Seats 6	
54" dia.	Seats 6	
48" dia.	Seats 4	
42" dia.	Seats 4	
36" dia.	Seats 4	

*requires 1 base

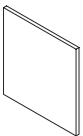


Size	Base Requirement	Seating Capacity
60" sq.	seats 8	
54" sq.	seats 6	
48" sq.	seats 4	
42" sq.	seats 4	
36" sq.	seats 4	
30" sq.	seats 4	

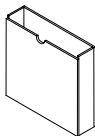
*requires 1 base

* When ordering bases for 120" x 48" and 120" x 42" size tops, three (3) bases are required for Panel and Rectangle bases, two (2) bases are required for all other.

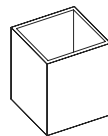
Base (units with access panel in the base for wire management are available, order this feature with the appropriate model number.)



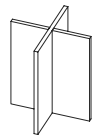
panel base
30" and 24" width



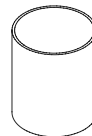
rectangle base
30" and 24" width



square base
24" and 18" width



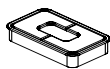
cross base
24" and 18" width



round base
24", 20" and 18" dia.



half-round base
24", 20 and 18" dia.



Worksurface Grommet

Additional worksurface grommets can be specified on veneer/laminate worksurfaces. The grommet location must be approved by JSI manufacturing, contact Customer Service. Add \$114 to the list for each additional grommet.

Grommet color must be specified, select Matte Black or Stardust Silver. Lock cores will match grommet color Matte Black (MBK) or Stardust Silver (STS).



End/Back Panel Grommet

The end/back panel grommets are standard, for any special consideration contact Customer Service.

Finale Product Information

Finish and Product Reference Codes

Select	Code
--------	------

Veneer

Cherry Flat Cut	CH1
Maple Flat Cut	MA1
Walnut Flat Cut	WA1

Finish

Cherry Finishes

Bourbon Medium	BBM
Brighton Medium	BRM
Classic	CLA
Collectors	CLL
Harvest	HRV
Praline	PRL

Maple Finishes

Ale Medium	ALM
Butterscotch	BUT
Flax	FLX
Venetian	VEN

Select	Code
--------	------

Walnut Finishes

Espresso	ESP
Mocha	MCH
Sienna	SIE
Truffle	TRF
Umber	UMB

Top Edge Details

Bevel	B
Eased	R4
Gael	G
Reeded	H
Transitional	C
Triad	F

Pull & Finish Codes

Arch - Matte Black	MBK
Arch - Matte Silver	MSL
Block - Matte Nickel	MNK
Curve - Matte Nickel	MNK
Twist - Matte Nickel	MNK

Select	Code
--------	------

Laminate Coordinates

Cherry Wood Grain Patterns

Collectors	CLL
Harvest	HRV
Praline	PRL

Walnut Wood Grain Patterns

Mocha	MCH
Sienna	SIE
Truffle	TRF
Umber	UMB

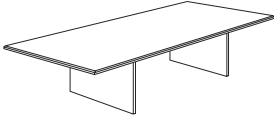
Metal Finish *(grommet)*

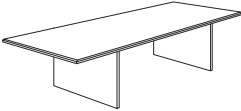
Matte Black	MBK
Stardust Silver	STS

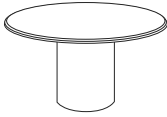
Order Check List:

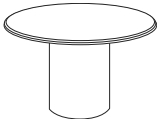
Specify:

- 1. Model Number
- 2. Finish
- 3. Wood Species - cherry - makore - maple - walnut
- 4. Top Options - standard veneer - laminate surface (see page FN79)
- 5. Other Product Options
- 6. Power and Data Accessories (*drawing showing location and orientation must accompany order*)
- 7. Side Mark Information (*i.e. room number, East Conference Room*)
- 8. Shipping Address (*contact name and phone number*)
- 9. Special Delivery Instructions (*i.e. call before delivery, deliver to job site*)

Description	D	W	H	CTN WT	CU FT	① Model	List Price
Conference Table	42	96	30			FN4296CTP	\$6,037
	Consists of:						
				172	15	FN4296TT - Table Top	\$4,431
				54 ea.	4 ea.	FN2428PB - Panel Bases	\$803 ea.
<ul style="list-style-type: none"> · ships KD in four cartons · one piece top · price reflects two bases · price includes one FN0655SP stretcher panel · must order (2) panel bases 							

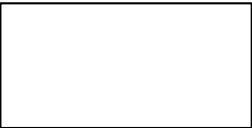
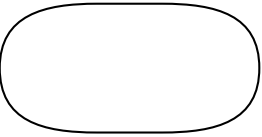
Conference Table	36	72	30			FN3672CTP	\$4,457
	Consists of:						
				110	10	FN3672TT - Table Top	\$2,851
				54 ea.	4 ea.	FN2428PB - Panel Bases	\$803 ea.
<ul style="list-style-type: none"> · ships KD in four cartons · one piece top · price reflects two bases · price includes one FN0631SP stretcher panel · must order (2) panel bases 							

Description	D	W	H	CTN WT	CU FT	① Model	List Price
Round Conference Table	48	48	30			FN48CTD	\$3,451
	Consists of:						
				73	7	FN48TT - Table Top	\$2,221
				71	9	FN20RB - Round Base	\$1,230
· ships KD in two cartons							

Round Conference Table	42	42	30			FN42CTD	\$2,928
	Consists of:						
				56	5	FN42TT - Table Top	\$1,698
				71	9	FN20RB - Round Base	\$1,230
· ships KD in two cartons							


To Order, Specify:

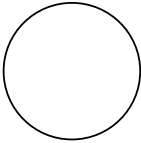
- ① Model Number
- ② Wood Species
 - A. Work Surface
 - B. Chassis
- ③ Finish Color
 - A. Work Surface
 - B. Chassis
- ④ Edge Profile
- ⑤ Power and Data Options (see [accessories price list](#))
- ⑥ Other Product Options

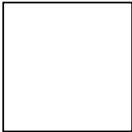
Description	① Model	W	L	Seat Capacity	Top Pieces	Bases Required	CTN WT	CU FT	List Price
Rectangular Tops 	FN60264TT	60	264	24	3	4	673	57	\$18,699
	FN60240TT	60	240	22	3	4	613	51	\$17,000
	FN60216TT	60	216	20	3	4	552	48	\$15,305
	FN60192TT	60	192	18	2	3	490	42	\$13,600
	FN54264TT	54	264	22	3	4	609	52	\$15,585
	FN54240TT	54	240	20	3	4	554	50	\$14,168
	FN54216TT	54	216	18	3	4	498	43	\$12,755
	FN54192TT	54	192	16	2	3	441	38	\$11,336
	FN48264TT	48	264	22	3	4	548	47	\$13,858
	FN48240TT	48	240	20	3	4	498	43	\$12,599
	FN48216TT	48	216	18	3	4	447	38	\$11,336
	FN48192TT	48	192	16	2	3	396	33	\$10,080
	FN48168TT	48	168	14	2	3	346	30	\$8,820
	FN48144TT	48	144	12	2	3	296	28	\$7,561
	FN48120TT**	48	120	8	2	2-3**	245	22	\$6,304
	FN4896TT	48	96	8	1	2	197	17	\$5,064
	FN42120TT**	42	120	8	2	2-3**	217	19	\$5,516
	FN42108TT	42	108	8	2	2	195	17	\$4,968
FN4296TT	42	96	8	1	2	172	15	\$4,431	
FN4284TT	42	84	8	1	2	151	13	\$3,858	
FN3672TT	36	72	6	1	2	110	10	\$2,851	
Racetrack Tops 	FN60264RT	60	264	24	3	4	646	57	\$22,098
	FN60240RT	60	240	22	3	4	589	51	\$20,089
	FN60216RT	60	216	20	3	4	530	48	\$18,084
	FN60192RT	60	192	18	2	3	471	42	\$16,076
	FN54264RT	54	264	22	3	4	586	52	\$18,414
	FN54240RT	54	240	20	3	4	530	50	\$16,743
	FN54216RT	54	216	18	3	4	474	43	\$15,070
	FN54192RT	54	192	16	2	3	417	38	\$13,396
	FN48264RT	48	264	22	3	4	529	47	\$16,370
	FN48240RT	48	240	20	3	4	479	43	\$14,884
	FN48216RT	48	216	18	3	4	428	38	\$13,396
	FN48192RT	48	192	16	2	3	377	33	\$11,908
	FN48168RT	48	168	14	2	3	327	30	\$10,294
	FN48144RT	48	144	12	2	3	277	28	\$8,934
	FN48120RT**	48	120	8	2	2-3**	226	22	\$7,451
	FN4896RT	48	96	8	1	2	185	17	\$5,962
	FN42120RT**	42	120	8	2	2-3**	203	19	\$6,518
	FN42108RT	42	108	8	2	2	180	17	\$5,866
FN4296RT	42	96	8	1	2	157	15	\$5,214	
FN4284RT	42	84	8	1	2	142	13	\$4,584	
FN3672RT	36	72	6	1	2	100	10	\$3,360	

**When ordering RECTANGLE or PANEL BASES - FN48120 and FN42120 require (3) panel bases and additional stretchers. Stretchers will be included as required.

**When ordering RECTANGLE or PANEL BASES - FN48120 and FN42120 require (3) panel bases and additional stretchers. Stretchers will be included as required.

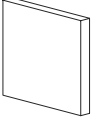
Description	① Model	W	L	Seat Capacity	Top Pieces	Bases Required	CTN WT	CU FT	List Price
Boat Shape Tops  · boat shape top end dimension is 6" less than center dimension **When ordering RECTANGLE or PANEL BASES - FN48120 and FN42120 require (3) panel bases and additional stretchers. Stretchers will be included as required.	FN60264BT	60	264	24	3	4	646	57	\$22,098
	FN60240BT	60	240	22	3	4	589	51	\$20,089
	FN60216BT	60	216	20	3	4	530	48	\$18,084
	FN60192BT	60	192	18	2	3	471	42	\$16,076
	FN54264BT	54	264	22	3	4	586	52	\$18,414
	FN54240BT	54	240	20	3	4	530	50	\$16,743
	FN54216BT	54	216	18	3	4	474	43	\$15,070
	FN54192BT	54	192	16	2	3	417	38	\$13,396
	FN48264BT	48	264	22	3	4	529	47	\$16,370
	FN48240BT	48	240	20	3	4	479	43	\$14,884
	FN48216BT	48	216	18	3	4	428	38	\$13,396
	FN48192BT	48	192	16	2	3	377	33	\$11,908
	FN48168BT	48	168	14	2	3	327	30	\$10,294
	FN48144BT	48	144	12	2	3	277	28	\$8,934
	FN48120BT**	48	120	8	2	2-3**	226	22	\$7,451
	FN4896BT	48	96	8	1	2	185	17	\$5,962
	FN42120BT**	42	120	8	2	2-3**	203	19	\$6,518
	FN42108BT	42	108	8	2	2	180	17	\$5,866
	FN4296BT	42	96	8	1	2	157	15	\$5,214
FN4284BT	42	84	8	1	2	142	13	\$4,584	
FN3672BT	36	72	6	1	2	100	10	\$3,360	



Round Tops	① Model	W	L	Seat Capacity	Top Pieces	Bases Required	CTN WT	CU FT	List Price
	FN60TT	60	N/A	6	1	1	112	10	\$3,751
	FN54TT	54	N/A	6	1	1	92	8	\$2,817
	FN48TT	48	N/A	4	1	1	73	7	\$2,221
	FN42TT	42	N/A	4	1	1	56	5	\$1,698
	FN36TT	36	N/A	3	1	1	42	4	\$1,495
	FN30TT	30	N/A	3	1	1	30	3	\$1,318


Square Tops	① Model	W	L	Seat Capacity	Top Pieces	Bases Required	CTN WT	CU FT	List Price
	FN6060TT	60	60	8	1	1	154	10	\$3,437
	FN5454TT	54	54	6	1	1	125	8	\$2,603
	FN4848TT	48	48	4	1	1	99	7	\$2,055
	FN4242TT	42	42	4	1	1	77	5	\$1,577
	FN3636TT	36	36	4	1	1	56	4	\$1,422
	FN3030TT	30	30	4	1	1	39	3	\$989




To Order, Specify:

- ① Model Number
- ② Wood Species
- ③ Finish Color
- ④ Edge Profile
- ⑤ Power and Data Options (see [accessories price list](#))
- ⑥ Other Product Options

Description	D	W	H	CTN WT	CU FT	① Model	List Price
Panel Base 	2 5/16	36	28 3/4	83	6	FN3628PB · for use with 60" width top	\$965
	2 5/16	30	28 3/4	68	5	FN3028PB · for use with 54" width top	\$888
	2 5/16	24	28 3/4	54	4	FN2428PB · for use with 36", 42" and 48" width top · (3) bases are required when ordering FN48120 or FN42120	\$803

Description	D	W	H	CTN WT	CU FT	① Model	List Price
Rectangular Base   side 1 side 2	7 5/8	36	28 3/4	69	7	FN3628PBA · for use with 60" width top · access panel	\$1,630
	7 5/8	30	28 3/4	60	6	FN3028PBA · for use with 54" width top · access panel	\$1,549
	7 5/8	24	28 3/4	52	5	FN2428PBA · for use with 36", 42" and 48" width top · access panel · (3) bases are required when ordering FN48120 or FN42120	\$1,463

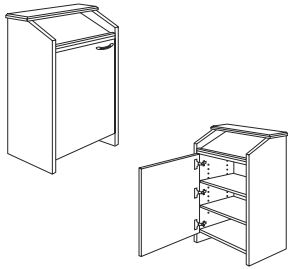
Description	D	W	H	CTN WT	CU FT	① Model	List Price
Round Base 	24	n/a	28 3/4	74	12	FN24RB · for use with 54" and 60" width top	\$1,398
	24	n/a	28 3/4	37	12	FN24RBA · for use with 54" and 60" width top · access panel	\$1,559
	20	n/a	28 3/4	71	9	FN20RB · for use with 42" and 48" width top	\$1,230
	20	n/a	28 3/4	34	9	FN20RBA · for use with 42" and 48" width top · access panel	\$1,392
	18	n/a	28 3/4	68	7	FN18RB · for use with 36" width top	\$1,150
	18	n/a	28 3/4	31	7	FN18RBA · for use with 36" width top · access panel	\$1,314

Description	D	W	H	CTN WT	CU FT	① Model	List Price	
Half Round Base 	12	24	28 ¾	35	6	FN24HRB · for use with 54" width top	\$1,056	
	12	24	28 ¾	33	6	FN24HRBA · for use with 54" width top · access panel	\$1,243	
	10	20	28 ¾	30	5	FN20HRB · for use with 42" and 48" width top	\$963	
	10	20	28 ¾	28	5	FN20HRBA · for use with 42" and 48" width top · access panel	\$1,153	
	9	18	28 ¾	27	4	FN18HRB · for use with 36" width top	\$925	
	9	18	28 ¾	26	4	FN18HRBA · for use with 36" width top · access panel	\$1,116	
	<hr/>							
	Square Base 	30	30	28 ¾	83	6	FN30SB · for use with 60" width top	\$1,320
30		30	28 ¾	68	16	FN30SBA · for use with 60" width top · access panel	\$1,486	
24		24	28 ¾	68	12	FN24SB · for use with 54" width top	\$1,166	
24		24	28 ¾	68	12	FN24SBA · for use with 54" width top · access panel	\$1,330	
18		18	28 ¾	39	7	FN18SB · for use with 36", 42" and 48" width top	\$1,007	
18		18	28 ¾	39	7	FN18SBA · for use with 36", 48" and 48" width top · access panel	\$1,170	
<hr/>								
Cross Base 		30	30	28 ¾	80	16	FN30XB · for use with 60" width top	\$1,094
	24	24	28 ¾	80	12	FN24XB · for use with 48" and 54" width top	\$985	
	18	18	28 ¾	50	7	FN18XB · for use with 30", 36" and 42" width top	\$879	

To Order, Specify:

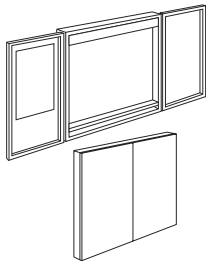
- ① Model Number
- ② Wood Species
- ③ Finish Color
- ④ Edge Profile
- ⑤ Power and Data Options (see [accessories price list](#))
- ⑥ Other Product Options

Description	D	W	H	CTN WT	CU FT	① Model	List Price
Conference Lectern	23	27	48	250	23	FN2622LEC	\$3,730



- two adjustable shelves
- four concealed, locking casters
- door non-locking
- standard door is hinged on left
- round grommet in bottom panel
- notches in adjustable shelves allow wires to pass through

Visual Board	3 1/2	48	48	125	8	FN4848VB	\$4,329
---------------------	-------	----	----	-----	---	-----------------	----------------



- corkboard on right and left doors; paper pad on left only
- marker board in center
- four markers and eraser included
- optional face applied pulls
- locking not available

Buffet Credenza	24	71 1/2	36	280	43	FN2472BSC	\$6,595
------------------------	----	--------	----	-----	----	------------------	----------------



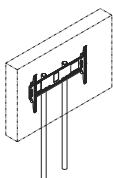
- top edge profile on user side
- four door credenza
- four box drawers above doors
- locking doors and drawers not available
- adjustable shelf in storage cabinet
- two end panel grommets with wire pass thru
- back panel includes cord exit grommets

Buffet Credenza - Flat Screen Support	24	71 1/2	36	280	43	FN2472BSCT	\$7,159
--	----	--------	----	-----	----	-------------------	----------------



- top edge profile on user side
- four door credenza
- four box drawers above doors
- locking doors and drawers not available
- adjustable shelf in storage cabinet
- two end panel grommets with wire pass thru
- flat screen mounting grommets in top
- back panel includes cord exit grommets

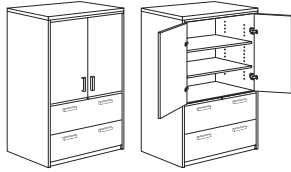
Flat Screen Mounting Frame	2	14	55	35	4	FSTV	\$1,716
-----------------------------------	---	----	----	----	---	-------------	----------------



- round 2" tube frame with cable management to inside of credenza
- mounting bracket for TV provided
- available in black (B) or silver (S)
- TV not included
- TV dimension not to exceed 70"w x 38"h to allow proper mounting clearance
- coordinates with FN2472BSCT

Description	D	W	H	CTN WT	CU FT	① Model	List Price
-------------	---	---	---	-----------	----------	---------	------------

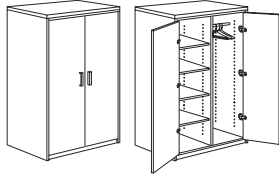
72" h File/File Lateral Storage Cabinet



- two adjustable shelves
- locking doors available; specify and add \$142 list
- top edge profile on user side only
- file/file lateral
- pedestal locking

	24	35 ³ / ₈	72	360	43	FN3672SWLF	\$5,464
--	----	--------------------------------	----	-----	----	-------------------	----------------

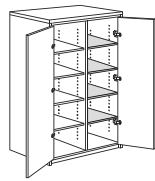
72" h Wardrobe



- top edge profile on user side
- chrome hanging bar on right
- one fixed shelf second from bottom on left
- locking doors available; specify and add \$284 list

	24	18	3 ⁴ / ₄	56	2	FN1824SK	\$971
--	----	----	-------------------------------	----	---	-----------------	--------------

Hanging Bar to Shelves Conversion Kit

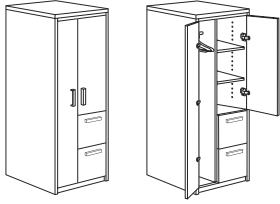


- four shelves
- for 36" wide wardrobe

To Order, Specify:

- ① Model Number
- ② Wood Species
- ③ Finish Color
- ④ Edge Profile
- ⑤ Pull (style and color)
- ⑥ Grommet Color
- ⑦ Power and Data Options (see [accessories price list](#))
- ⑧ Other Product Options

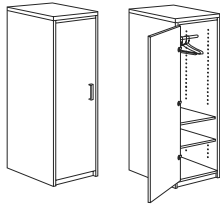
Description	D	W	H	CTN WT	CU FT	① Model	List Price
72" h File/File	24	23 5/8	72	340	29	FN2472SWR	\$3,989
Storage Wardrobe	24	23 5/8	72	340	29	FN2472SWL	\$3,989



left shown

- top edge profile on user side
- chrome hanging bar
- two adjustable shelves
- file/file pedestal
- locking not available

Description	D	W	H	CTN WT	CU FT	① Model	List Price
72" h Wardrobe	24	18	72	233	23	FN1872WR	\$3,547
	24	18	72	233	23	FN1872WL	\$3,547



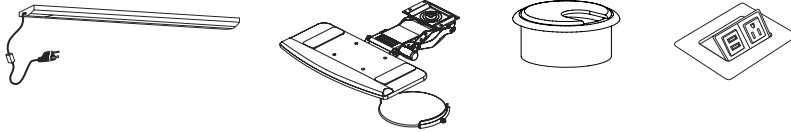
left shown

- top edge profile on user side
- chrome hanging bar at top
- one fixed shelf 26 1/2" from cabinet floor
- one adjustable shelf
- locking doors available; specify and add \$142 list

Accessories/ Keyboard/ Tasklights

For a list of electrical units, grommets, keyboards, wire management, monitor arms & telecom jacks, please see our [accessories price list](#)

Contact your customer service representative for specific questions regarding which units can be used with Finale



To Order, Specify:

- ① Model Number
- ② Wood Species
- ③ Finish Color
- ④ Edge Profile
- ⑤ Pull (style and color)
- ⑥ Grommet Color
- ⑦ Power and Data Options (see [accessories price list](#))
- ⑧ Other Product Options

Lincoln Tables Order Check List:



Top core material is 1 1/8" thick with 45 lb. density industrial grade particle board. The face is wood veneer or horizontal grade high pressure laminate (HPL). A backer is bonded to bottom side to ensure balanced construction. All tops have internal solid lumber bands with overlay laminate or veneer.

Specify:

- 1. Model Number
- 2. Top Material - Veneer (W) or Laminate (L)
- 3. Wood Species - Cherry (CH1), Maple (MA1), Red Oak (OK1) or Walnut (WA1)
- 4. Wood Finish/Color
- 5. Edge profile
- 6. Leg Style - Straight Wood (S), Tapered Wood (T); no upcharge or Metal (M); add \$469 list for 4 metal legs or \$583 list for 5 metal legs
- 7. Wood Leg Attachment
 - A. Corner Block with 3" high straight apron (CBSA)
 - B. Corner Block with 3" high arched apron (CBAA)
 - C. Plate and Barrel Nut with 1" high straight apron (PBSA)
- 8. Optional Metal Leg Wire Management
 - A. Wire management in one leg, \$24 list upcharge (1)
 - B. Wire management in two legs, \$48 list upcharge (2)
- 9. Optional Premium or Specialty Laminate Tops Available - contact customer service for pricing.

Example:

LI4848-29 (model #)	W (top material)	OK1 (wood species)	HEN (finish)	B (edge)	S (leg style)	CBSA (wood leg attachment)
------------------------	---------------------	-----------------------	-----------------	-------------	------------------	-------------------------------

1. Model Number

2. Top Material - Veneer (W) or Laminate (L) - Finishes below with an asterisk (*) have a coordinating laminate available.

3. Wood Species - Cherry (CH1), Maple (MA1), Red Oak (OK1) or Walnut (WA1)

4. Wood Finish/Color Options:

CH1 Cherry *Flat Cut Veneer*

BBM Bourbon Medium	CLL Collectors*
BRM Brighton Medium	HRV Harvest*
CLA Classic	PRL Praline*

MA1 Maple *Flat Cut Veneer*

ALM Ale Medium	FLX Flax
BUT Butterscotch	VEN Venetian

WA1 Walnut *Flat Cut Veneer*

ESP Espresso	TRF Truffle*
MCH Mocha*	UMB Umber*
SIE Sienna*	

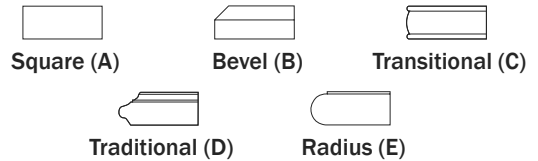
OK1 Red Oak Veneer

BRW Brownie	ECU Ecu
CAN Canyon	HEN Henna
CIT Citron	HNY Honey
DES Desert	NUT Nut Brown

Paint Color - Add \$45 list per item

BKD Backdrop	GRV Greek Villa
BFX Black Fox	GLF Gulf Stream
BWH Bright White	HTB Heartthrob
CGP Cargo Pants	NET Network Gray
CHT Chatroom	NWH Nonchalant White
DSY Daisy	PAR Paradise
DRG Daring	QXP Quixotic Plum
DYN Dynamo	RBZ Relic Bronze
ENG Enigma	SND Sandbank
FRR French Roast	STM Storm
GBY Georgian Bay	TRC Tricorn Black

5. Edge Profile Options:



6. Leg Style - Straight Wood (S), Tapered Wood (T); no upcharge or Metal (M); add \$469 list for 4 metal legs or \$583 list for 5 metal legs.

NOTE: Metal leg uses plate and barrel nut attachment and tops have 1" high straight apron.



Metal legs

7. Wood Leg Attachment:

- A. Corner block with 3" high straight apron (CBSA)
- B. Corner block with 3" high arch apron (CBAA)
- C. Plate and barrel nut with 1" high straight apron (PBSA)

NOTE: CBAA or PBSA recommended for ADA applications



Corner Block



Plate and Barrel Nut



8. Optional Metal Leg Wire Management:

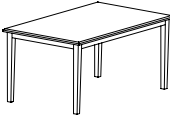
- Wire management in one leg, \$24 list upcharge (1)
- Wire management in two legs, \$48 list upcharge (2)



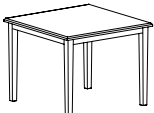
Metal leg with
wire management


9. Optional Premium or Specialty Laminate Tops Available - contact customer service for pricing.

See * for which finishes are available with Laminate top

Description	D	W	H	CTN WT	CU FT	① Model	List Price
	24	36	29	55	4	LI2436-29	\$825
	30	42	29	60	5	LI3042-29	\$1,012
	30	60	29	95	7	LI3060-29	\$1,187
	36	60	29	105	9	LI3660-29	\$1,315
	36	72	29	125	10	LI3672-29	\$1,543
	36	90	29	133	13	LI3690-29*	\$2,097
	42	78	29	140	13	LI4278-29	\$2,126
	42	84	29	150	14	LI4284-29	\$2,231

* 90" table has an additional leg in center for support

Description	D	W	H	CTN WT	CU FT	Model	List Price
	24	24	29	50	3	LI2424-29	\$747
	36	36	29	70	6	LI3636-29	\$1,067
	42	42	29	80	7	LI4242-29	\$1,270
	48	48	29	90	9	LI4848-29	\$1,486

Description	D	W	H	CTN WT	CU FT	Model	List Price
	36	N/A	29	42	6	LI36R-29	\$1,220
	42	N/A	29	80	7	LI42R-29	\$1,437
	48	N/A	29	95	9	LI48R-29	\$1,557

To Order, Specify:

- ① Model Number
- ② Top Material - Veneer (W) or Laminate (L)
- ③ Wood Species - Cherry (CH1), Maple (MA1), Red Oak (OK1) or Walnut (WA1)
- ④ Wood Finish/Color [See Wood Finish/Color Options](#)
- ⑤ Edge Profile
- ⑥ Leg Style - Metal (M); add \$469 list for 4-leg table or \$583 list for 5-leg table, Straight Wood (S) or Tapered Wood (T), no upcharge
- ⑦ Wood Leg Attachment
 - A. Corner block with 3" high straight apron (CBSA)
 - B. Corner block with 3" high arched apron (CBAA)
 - C. Plate and Barrel Nut with 1" high straight apron (PBSA)
- ⑧ Optional Metal Leg Wire Management -
 - A. Wire management in one leg (1) - add \$24 list.
 - B. Wire management in two legs (2) - add \$48 list.
- ⑨ Optional Premium or Specialty Laminate Tops
Available - contact customer service for pricing

Specifications

- Wood species - Cherry, Maple, or Walnut.
- Top core material is 1 1/8" thick with 45 lb. density industrial grade particle board.
- Face is wood veneer or horizontal grade HPL.
- Backer is bonded to bottom side to ensure balanced construction.
- All tops have internal solid lumber bands with overlay laminate or veneer.

Lincoln Lounge Tables Order Check List:



Specify:

- 1. Model Number
- 2. Top Material - Veneer (W) or Laminate (L)
- 3. Wood Species - Cherry (CH1), Maple (MA1), Red Oak (OK1) or Walnut (WA1)
- 4. Wood Finish/Color
- 5. Edge Profile
- 6. Leg Style - Straight Wood (S) or Tapered Wood (T)
- 7. Optional Premium or Specialty Laminate Tops Available - contact customer service for pricing

Top core material is 1 1/8" thick with 45 lb. density industrial grade particle board. The face is wood veneer or horizontal grade high pressure laminate (HPL). A backer is bonded to bottom side to ensure balanced construction. All tops have internal solid lumber bands with overlay laminate or veneer. Legs use a corner block application with a 3" straight apron.

Examples:

LI2042-16 | W | MA1 | MC | B | T
 (model #) | (top material) | (wood species) | (finish) | (edge) | (leg style)

1. Model Number

2. Top Material - Veneer (W) or Laminate (L) - Finishes with an asterisk (*) have a coordinating laminate available.

3. Wood Species - Cherry (CH1), Maple (MA1), Red Oak (OK1) or Walnut (WA1)

4. Wood Finish/Color Options:

- CH1 Cherry** *Flat Cut Veneer*
- BBM Bourbon Medium CLL Collectors*
 - BRM Brighton Medium HRV Harvest*
 - CLA Classic PRL Praline*

- MA1 Maple** *Flat Cut Veneer*
- ALM Ale Medium FLX Flax
 - BUT Butterscotch VEN Venetian

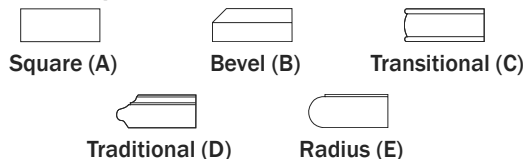
- WA1 Walnut** *Flat Cut Veneer*
- ESP Espresso TRF Truffle*
 - MCH Mocha* UMB Umber*
 - SIE Sienna*

- OK1 Red Oak Veneer**
- BRW Brownie ECU Ecu
 - CAN Canyon HEN Henna
 - CIT Citron HNY Honey
 - DES Desert NUT Nut Brown

Paint Color - Add \$45 list per item

- | | |
|------------------|----------------------|
| BKD Backdrop | GRV Greek Villa |
| BFX Black Fox | GLF Gulf Stream |
| BWH Bright White | HTB Heartthrob |
| CGP Cargo Pants | NET Network Gray |
| CHT Chatroom | NWH Nonchalant White |
| DSY Daisy | PAR Paradise |
| DRG Daring | QXP Quixotic Plum |
| DYN Dynamo | RBZ Relic Bronze |
| ENG Enigma | SND Sandbank |
| FRR French Roast | STM Storm |
| GBY Georgian Bay | TRC Tricorn Black |

5. Edge Profile Options:



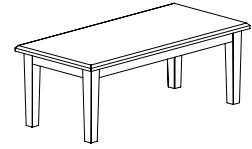
6. Leg Style - Straight Wood (S) or Tapered Wood (T)

NOTE: Legs use a corner block application with a 3" straight apron.

7. Optional Premium or Specialty Laminate Tops Available - contact customer service for pricing.

LINCOLN

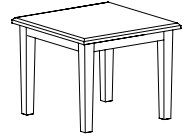
Description	D	W	H	CTN WT	CU FT	① Model	List Price
-------------	---	---	---	-----------	----------	---------	------------



Rectangular Table	20	42	16	75	4	LI2042-16	\$817
-------------------	----	----	----	----	---	-----------	-------

	20	28	20	65	3	LI2028-20	\$672
--	----	----	----	----	---	-----------	-------

Square Table	24	24	20	48	3	LI2424-20	\$747
--------------	----	----	----	----	---	-----------	-------



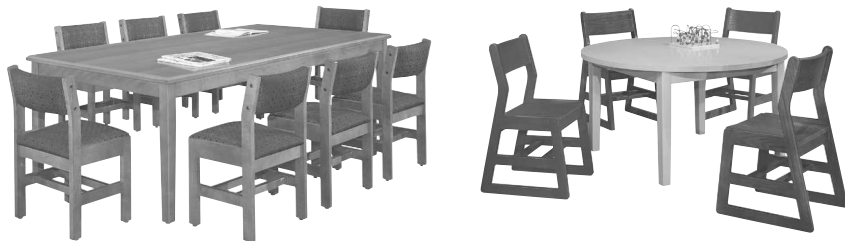
To Order, Specify:

- ① Model Number
- ② Top Material - Veneer (W) or Laminate (L)
- ③ Wood Species - Cherry (CH1), Maple (MA1), Red Oak (OK1) or Walnut (WA1)
- ④ Wood Finish/Color [See Wood Finish/Color Options](#)
- ⑤ Edge Profile
- ⑥ Leg Style - Straight Wood (S) or Tapered Wood (T)
- ⑦ Optional Premium or Specialty Laminate Tops
Available - contact customer service for pricing

Specifications

- Wood species - Cherry, Maple, or Walnut.
- Top core material is 1 1/8" thick with 45 lb. density industrial grade particle board.
- Face is wood veneer or horizontal grade HPL.
- Backer is bonded to bottom side to ensure balanced construction.
- All tops have internal solid lumber bands with overlay laminate or veneer.

Lincoln Juvenile and Children's Tables Order Check List:



Specify:

- 1. Model Number
- 2. Top Material - Veneer (W) or Laminate (L)
- 3. Wood Species - Cherry (CH1), Maple (MA1), Red Oak (OK1) or Walnut (WA1)
- 4. Wood Finish/Color
- 5. Edge Profile
- 6. Leg Style - Straight Wood (S) or Tapered Wood (T)
- 7. Leg Attachment
 - A. Corner Block with 3" high straight apron (CBSA)
 - B. Corner Block with 3" high arched apron (CBAA)
 - C. Plate and Barrel Nut with 1" high straight apron (PBSA)
- 8. Optional Premium or Specialty Laminate Tops Available - contact customer service for pricing

Example:

LI3636-27 | W | OK1 | HEN | C | S | CBMA
 (model #) | (top material) | (wood species) | (finish) | (edge) | (leg style) | (leg attachment)

1. Model Number

2. Top Material - Veneer (W) or Laminate (L) - Finishes below with an asterisk (*) have a coordinating laminate available

3. Wood Species - Cherry (CH1), Maple (MA1), Red Oak (OK1) or Walnut (WA1)

4. Wood Finish/Color Options:

CH1 Cherry	<i>Flat Cut Veneer</i>	
BBM Bourbon Medium	CLL Collectors*	
BRM Brighton Medium	HRV Harvest*	
CLA Classic	PRL Praline*	

MA1 Maple	<i>Flat Cut Veneer</i>	
ALM Ale Medium	FLX Flax	
BUT Butterscotch	VEN Venetian	

WA1 Walnut	<i>Flat Cut Veneer</i>	
ESP Espresso	TRF Truffle*	
MCH Mocha*	UMB Umber*	
SIE Sienna*		

OK1 Red Oak Veneer

BRW Brownie	ECU Ecur
CAN Canyon	HEN Henna
CIT Citron	HNY Honey
DES Desert	NUT Nut Brown

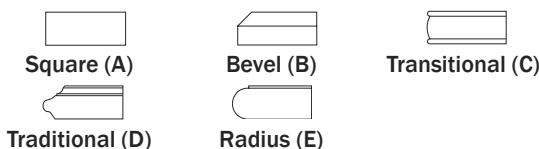
Paint Color - Add \$45 list per item

BKD Backdrop	GRV Greek Villa
BFX Black Fox	GLF Gulf Stream
BWH Bright White	HTB Heartthrob
CGP Cargo Pants	NET Network Gray
CHT Chatroom	NWH Nonchalant White

Paint Color - Add \$45 list per item

DSY Daisy	PAR Paradise
DRG Daring	QXP Quixotic Plum
DYN Dynamo	RBZ Relic Bronze
ENG Enigma	SND Sandbank
FRR French Roast	STM Storm
GBY Georgian Bay	TRC Tricorn Black

5. Edge Profile Options:



Top construction core material is 1 1/8" thick with 45 lb. density industrial grade particle board. The face is wood veneer or horizontal grade high pressure laminate (HPL). A backer is bonded to bottom side to ensure balanced construction. All tops have mitered corner external solid lumbar bands with inset laminate or veneer.

6. Leg Style - Straight Wood (S) or Tapered Wood (T)

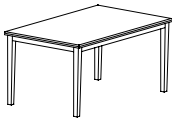
7. Leg Attachment:

- Corner Block with 3" high straight apron (CBSA)
- Corner Block with 3" high arched apron (CBAA)
- Plate and Barrel Nut with 1" high straight apron (PBSA)
- NOTE: CBAA and PBSA recommended for ADA applications.**

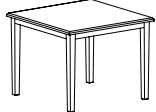



Corner Block | Plate and Barrel Nut

8. Optional Premium or Specialty Laminate Tops Available - contact customer service for pricing.

Description	D	W	H	CTN WT	CU FT	① Model	List Price
	20	28	27	40	3	LI2028-27	\$672
	20	42	27	46	4	LI2042-27	\$817
	24	36	27	52	4	LI2436-27	\$825
	30	42	27	57	5	LI3042-27	\$1,012
	30	60	27	92	7	LI3060-27	\$1,187
	36	60	27	103	9	LI3660-27	\$1,315
	36	72	27	123	10	LI3672-27	\$1,543
	36	90	27	130	13	LI3690-27*	\$2,097
	42	78	27	137	13	LI4278-27	\$2,126
42	84	27	147	14	LI4284-27	\$2,231	

* 90" table has an additional leg in center for support

Description	D	W	H	CTN WT	CU FT	① Model	List Price
	24	24	27	47	3	LI2424-27	\$747
	36	36	27	67	6	LI3636-27	\$1,067
	42	42	27	77	7	LI4242-27	\$1,270
	48	48	27	87	9	LI4848-27	\$1,486

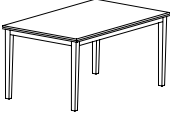
Description	D	W	H	CTN WT	CU FT	① Model	List Price
	36	N/A	27	39	6	LI36R-27	\$1,220
	42	N/A	27	77	7	LI42R-27	\$1,437
	48	N/A	27	92	9	LI48R-27	\$1,557

To Order, Specify:

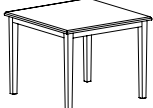
- ① Model Number
- ② Top Material - Veneer (W) or Laminate (L)
- ③ Wood Species - Cherry (CH1), Maple (MA1), Red Oak (OK1) or Walnut (WA1)
- ④ Wood Finish/Color [See Wood Finish/Color Options](#)
- ⑤ Edge Profile
- ⑥ Leg Style - Straight Wood (S) or Tapered Wood (T)
- ⑦ Leg Attachment
 - A. Corner block with 3" high straight apron (CBSA)
 - B. Corner block with 3" high arched apron (CBAA)
 - C. Plate and Barrel Nut with 1" high straight apron (PBSA)
- ⑧ Optional Premium or Specialty Laminate Tops
Available - contact customer service for pricing


Specifications

- Wood species - Cherry, Maple, or Walnut.
- Top core material is 1 1/8" thick with 45 lb. density industrial grade particle board.
- Backer is bonded to bottom side to ensure balanced construction.
- All tops have internal solid lumber bands with overlay laminate or veneer.
- Standard with adjustable rubber cushion metal glides.

Description	D	W	H	CTN WT	CU FT	① Model	List Price
	20	28	25	38	3	LI2028-25	\$672
	20	42	25	44	4	LI2042-25	\$817
	24	36	25	49	4	LI2436-25	\$825
	30	42	25	54	5	LI3042-25	\$1,012
	30	60	25	89	7	LI3060-25	\$1,187
	36	60	25	99	9	LI3660-25	\$1,315
	36	72	25	119	10	LI3672-25	\$1,543
	36	90	25	127	13	LI3690-25*	\$2,097
	42	78	25	134	13	LI4278-25	\$2,126
	42	84	25	144	14	LI4284-25	\$2,231

* 90" table has an additional leg in center for support

Description	D	W	H	CTN WT	CU FT	① Model	List Price
	24	24	25	44	3	LI2424-25	\$747
	36	36	25	64	6	LI3636-25	\$1,067
	42	42	25	74	7	LI4242-25	\$1,270
	48	48	25	84	9	LI4848-25	\$1,486

Description	D	W	H	CTN WT	CU FT	① Model	List Price
	36	N/A	25	36	6	LI36R-25	\$1,220
	42	N/A	25	74	7	LI42R-25	\$1,437
	48	N/A	25	89	9	LI48R-25	\$1,557

To Order, Specify:

- ① Model Number
- ② Top Material - Veneer (W) or Laminate (L)
- ③ Wood Species - Cherry (CH1), Maple (MA1), Red Oak (OK1) or Walnut (WA1)
- ④ Wood Finish/Color [See Wood Finish/Color Options](#)
- ⑤ Edge Profile
- ⑥ Leg Style - Straight Wood (S) or Tapered Wood (T)
- ⑦ Leg Attachment
 - A. Corner block with 3" high straight apron (CBSA)
 - B. Corner block with 3" high arched apron (CBAA)
 - C. Plate and Barrel Nut with 1" high straight apron (PBSA)
- ⑧ Optional Premium or Specialty Laminate Tops
Available - contact customer service for pricing

Specifications

- Wood species - Cherry, Maple, or Walnut.
- Top core material is 1 1/8" thick with 45 lb. density industrial grade particle board.
- Backer is bonded to bottom side to ensure balanced construction.
- All tops have internal solid lumber bands with overlay laminate or veneer.
- Standard with adjustable rubber cushion metal glides.



General Information	NA2	Table with Panel Bases.	NA32
Material Offering.	NA3	Table with Box Bases.	NA52
Table Surface Material	NA4	Table with Height Adjustable Bases.	NA72
Top Sizes and Shapes	NA6	Table with X Base	NA80
Bases	NA7	Peninsula Table with Open Loop Base	NA82
Applied Materials	NA8	Peninsula Table with Panel Base	NA88
Product Information	NA10	Credenzas	NA94
Technology	NA14	Runoff Table with Open Loop Base	NA102
Table with Open Loop Bases	NA18	Runoff Table with Panel Base.	NA108
		Media Wall Space Divider	NA114
		Towers.	NA118
		Hospitality Cart	NA120
		Open Shelves	NA120
		Mobile Lecterns	NA121
		Mobile Boards.	NA122
		Coffee Tables	NA123
		Benches.	NA123
		Power and Wire Management.	NA124

Native General Information

Wood Materials

Exterior surfaces are made from the finest selected veneers. Matching solid lumber wood species are used to coordinate with the veneer. High quality MDF is used on the painted surfaces.

Native is available in Cherry, Maple, Walnut, Black Oak Flat Cut, or Double Cut veneer.

Case Construction

All Models

Cabinets are constructed with dowels reinforced with screws, cleats and metal fasteners for increased stability. The metal glide housing inside the base provides for accurate leveling. Cabinets, with the exception of the waste credenza and hospitality carts, have sliding doors.

Laminate Models

Panels for chassis consist of a $\frac{3}{4}$ " thick substrate with TFL surfaces and PVC bands on exposed edges.

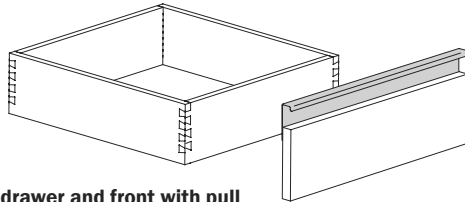
Veneer Models

Panels for chassis are $\frac{3}{4}$ " thick.

Drawer Construction

Drawers are assembled using a four corner dovetail box and $\frac{3}{4}$ " thick drawer bottom panel construction. The exterior front is attached separately. Sides and backs are approximately $\frac{1}{2}$ " thick solid hardwood. Drawer components have a UV finish to protect against shrinking, swelling, or warping and to provide a clean smooth feel and appearance. Lateral files have reinforced bottoms.

The exterior front panel is 3-ply and $\frac{3}{4}$ " thick. The front is attached to the assembled drawer box. The anodized aluminum pull runs along the top edge of the drawer front.



box drawer and front with pull
wood drawer box - DRW

Protective Top Coat

DuraTex™ offers exceptional hardness along with abrasion and impact resistance, it has been formulated to eliminate hazardous and harmful gases that are normally associated with wood finish.

Finish - Stain/Colors

We offer a variety of wood stains and paint colors on Native. Please see the chart below. Samples are available upon request.

DuraTex™ Features

Safety - Significantly reduces hazardous formaldehyde emissions which help improve the quality of the indoor air we breathe. **Quality** - Developed to be tough and durable with special attention to appearance. The DuraTex™ finish preserves the natural beauty of wood. **Durability** - Designed to meet a wide range of demanding performance and environmental standards to withstand even the highest wear and tear.

Special Finishes

Special finishes can be requested by following the instructions in the conferencing general order section, page 3. There is a one time charge of \$372 list per order. This applies to the veneer surfaces, and not the solid wood plank top option.

Native Standard Laminate Offering

The chart below lists the laminates available on Native.

Laminate Options

HPL Wood Grain Pattern Laminates

ALL Ale Light	MIN Mineral
BOL Bourbon Light	OAT Oatmeal Cookie
BZW Brazilwood	PIN Pinnacle Walnut
BGL Brighton Light	STU Studio Teak
CLL Collectors	UMB Umber
FAW Fawn	VAL Valley
FLO Florence Walnut	VIN Vintage
GRH Graphite	WEA Weathered Ash

HPL Solid Laminates

ALB Alabaster	DWH Designer White
BLK Black	SHD Shadow
BBL Bridal Blanco	SLG Slate Grey

Veneer Chassis with Laminate Tops

Worksurface only, no additional upcharge if Native's coordinating wood grain laminate is specified. Contact Customer Service for any other laminate request. Listed below are finishes with coordinating wood grain HPL laminates.

CH1 Cherry Flat Cut Veneer

CLL Collectors
HRV Harvest
PRL Praline

WA1 Walnut Flat Cut Veneer

MCH Mocha	TRF Truffle
SIE Sienna	UMB Umber

DC1 Double Cut Veneer

FAW Fawn	VAL Valley
MIN Mineral - Oak Pattern	

Finish Sheen

All veneer finishes are standard in 35-sheen, with the exception of Raven. Raven is only offered in 15 sheen. All other finishes can have their sheen modified with a 15% upcharge added to the list price of each item.

Native Material Offering

Native Standard Veneer Finish Offering

The charts below list the veneer stains and paints available on Native. Finishes with an asterisk (*) have coordinating laminate tops.

Finish/Stain Colors

CH1 Cherry <i>Flat Cut Veneer</i>			
BBM	Bourbon Medium	CLL	Collectors*
BRM	Brighton Medium	HRV	Harvest*
CLA	Classic	PRL	Praline*

MA1 Maple <i>Flat Cut Veneer</i>			
ALM	Ale Medium	FLX	Flax
BUT	Butterscotch	VEN	Venetian

WA1 Walnut <i>Flat Cut Veneer</i>			
ESP	Espresso	TRF	Truffle*
MCH	Mocha*	UMB	Umber*
SIE	Sienna*		

B01 Black Oak <i>Flat Cut Veneer</i>			
RAV	Raven		

DC1 Double Cut Veneer			
BAR	Barrel - Oak Pattern	KHK	Khaki
BUF	Buff - Oak Pattern	MIN	Mineral - Oak Pattern*
CND	Cinder - Oak Pattern	RYE	Rye - Oak Pattern
COF	Coffee	SAB	Sable - Oak Pattern
EGR	Egret - Oak Pattern	SAD	Saddle - Oak Pattern
FAW	Fawn*	STU	Studio Teak
GRH	Graphite	VAL	Valley*

Solid Surface	
S	Solid Surfaces
ARM	Armadillo
BLP	Black Pearl
PEB	Pebble Pearl
PUR	Pure White

Glass	
G	Glass - Back Painted White
G	Glossy Finish
M	Matte Finish

Wood Plank Ash	
W	Wood Plank Ash - Clear Coat

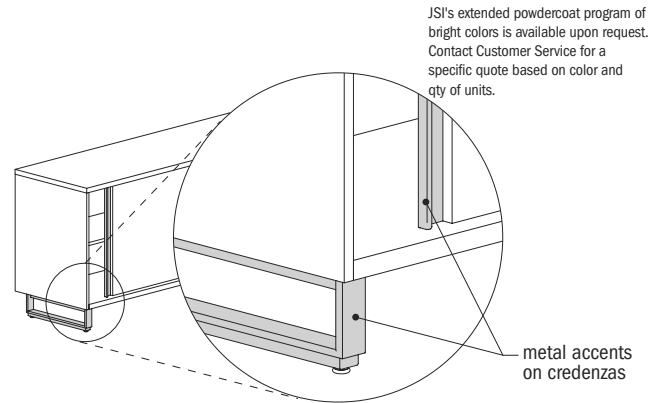
Customer Choice	
B	Base and Subtop Only

Paint Colors

PNT	Paint (Maple Flat Cut Veneer)
BKD	Backdrop
BFX	Black Fox
BWH	Bright White
CGP	Cargo Pants
CHT	Chatroom
FRR	French Roast
GRV	Greek Villa
NET	Network Gray
NWH	Nonchalant White
STM	Storm
TRC	Tricorn Black

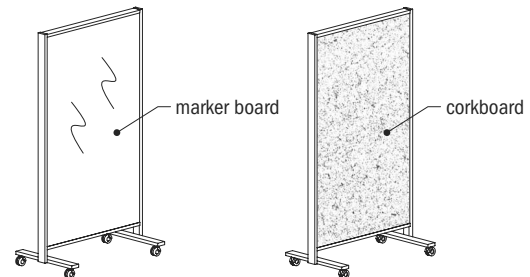
Metal Finishes - Accent Colors

ABZ	Aged Bronze	MBK	Matte Black
ASL	Arcitic Silver	PEW	Pewter
BWH	Bright White	RML	Raw Metal
CHR	Chrome	SBZ	Soft Bronze
GLD	Gold	SNK	Soft Nickel



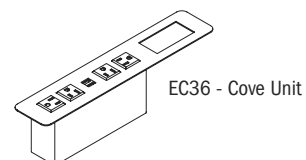
Alternative Surfaces

Mobile Boards	
WMB	White Marker Board Surface
CKB	Corkboard Surface



Cove Electrical Finishes

B	Black
S	Silver
W	White



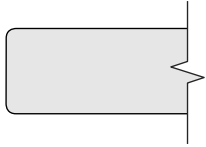
Native Table Surface Materials

NAT - Table Models

The NAT prefix is used to designate laminate material.

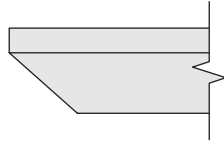
Laminate Tops

HPL tops are 1 3/16" thick, 3 ply construction. The laminate face is horizontal grain, or solid, high pressure laminate. Particle board core and a phenolic backer sheet complete the balanced construction.



Eased Edge (R3)

Standard on worksurface tops



Reverse Bevel (E1)

PVC on top of Painted MDF

Native Standard Laminates

HPL Wood Grain Pattern Laminates

ALL Ale Light	MIN Mineral
BOL Bourbon Light	OAT Oatmeal Cookie
BZW Brazilwood	PIN Pinnacle Walnut
BGL Brighton Light	STU Studio Teak
CLL Collectors	UMB Umber
FAW Fawn	VAL Valley
FLO Florence Walnut	VIN Vintage
GRH Graphite	WEA Weathered Ash

HPL Solid Laminates

ALB Alabaster	DWH Designer White
BLK Black	SHD Shadow
BBL Bridal Blanco	SLG Slate Grey

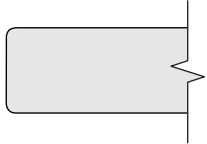
Native Table Surface Materials

NAV - Table Models

The NAV prefix is used to designate non-laminate material. Choose between Veneer - Flat Cut, Veneer - Double Cut, Solid Surface, Glass, Wood plank, or Customer Choice Material for NAV models.

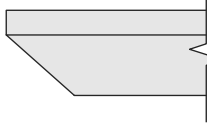
Veneer Tops

Tops are 1 3/16" thick, 3-ply balanced construction. Flat cut is book match for cherry, maple, walnut or black oak veneer. Double cut is a processed product that has at least two cuttings to create the final veneers. These cuts of veneer strands are dyed and layered into a block to create the pattern.



Eased Edge (R3)

External 3mm Veneer Band



Reverse Bevel (E1)

Veneer Band on Stained MDF

Finish - Stain/Colors

CH1 Cherry	<i>Flat Cut Veneer</i>	
BBM Bourbon Medium	CLL Collectors	
BRM Brighton Medium	HRV Harvest	
CLA Classic	PRL Praline	

MA1 Maple	<i>Flat Cut Veneer</i>	
ALM Ale Medium	FLX Flax	
BUT Butterscotch	VEN Venetian	

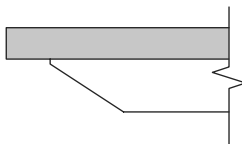
WA1 Walnut	<i>Flat Cut Veneer</i>	
ESP Espresso	TRF Truffle	
MCH Mocha	UMB Umber	
SIE Sienna		

B01 Black Oak	<i>Flat Cut Veneer</i>	
RAV Raven		

DC1 Double Cut Veneer		
BAR Barrel - Oak Pattern	KHK Khaki	
BUF Buff - Oak Pattern	MIN Mineral - Oak Pattern	
CND Cinder - Oak Pattern	RYE Rye - Oak Pattern	
COF Coffee	SAB Sable - Oak Pattern	
EGR Egret - Oak Pattern	SAD Saddle - Oak Pattern	
FAW Fawn	STU Studio Teak	
GRH Graphite	VAL Valley	

Premier Tops

Solid Surface Tops

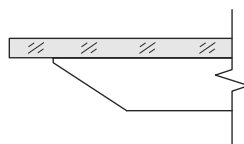


Solid Surface Tops are 1 7/16" thick constructed of 3/16" thick solid surface on top of a 1" MDF sub top. Sub top has an under cut bevel profile and is painted in a coordinated color to match the solid surface.

Solid Surfaces

- ARM** Armadillo
- BLP** Black Pearl
- PEB** Pebble Pearl
- PUR** Pure White

Glass Tops

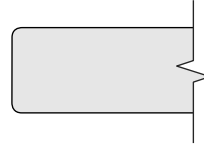


Glass Tops are 1 5/16" thick constructed of 1/4" thick glass surface on top of a 1" MDF sub top. Sub top has an under cut bevel profile and is always painted white, to match the back painted glass. Glass sits on top of the sub top with 1/16" bumpers.

Glass Selection

- G** White Glossy
- M** White Matte

Wood Plank Ash Tops

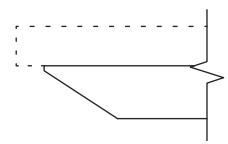


Wood Plank Ash Tops are a solid 1 3/16" thick plank of ash. Tops are finished with a clear coat.

Solid Wood Plank

- W** Wood Plank Ash - Clear Coat

Customer Choice Tops



Sub tops are 1" thick and have an under cut bevel profile. Sub top is always painted in black. Customer is responsible for determining the best attachment method for their custom top. Weight of custom top not to exceed 13 lbs per square foot.

Customer Choice

- B** Base and Subtop Only

Native Tops Sizes & Seating Capacity

Native Top Shapes and Sizes

Native offers six table top shapes with multiple sizes. The round and square come with an X base. All others available with Open Loop, Panel, or Box Base.

One piece top shapes and sizes:



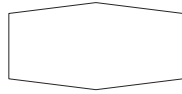
rectangular

54" x 120" Seats 8
 48" x 120" Seats 8
 48" x 108" Seats 8
 48" x 96" Seats 8
 48" x 84" Seats 8
 48" x 72" Seats 6



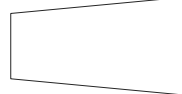
arc end

54" x 120" Seats 8
 48" x 120" Seats 8
 48" x 108" Seats 8
 48" x 96" Seats 8
 48" x 84" Seats 8
 48" x 72" Seats 6
 42" x 120" Seats 8
 42" x 108" Seats 8
 42" x 96" Seats 8
 42" x 84" Seats 8
 42" x 72" Seats 6
 36" x 84" Seats 8
 36" x 72" Seats 6



boat

48" x 120" Seats 8
 48" x 108" Seats 8
 48" x 96" Seats 8
 48" x 84" Seats 8
 42" x 72" Seats 6



view

60" x 120" Seats 8
 60" x 108" Seats 8
 54" x 96" Seats 8
 54" x 84" Seats 8
 48" x 72" Seats 6



square

60" x 60" Seats 8
 54" x 54" Seats 6
 48" x 48" Seats 4

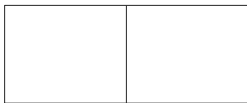


round

60" x 60" Seats 8
 54" x 54" Seats 6
 48" x 48" Seats 4

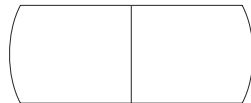
PRODUCT INFORMATION

Two piece top shapes and sizes:



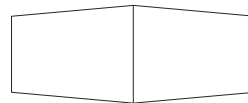
rectangular

60" x 240" Seats 20/22
 60" x 216" Seats 18/20
 60" x 192" Seats 16/18
 60" x 168" Seats 14/16
 60" x 144" Seats 10/12
 54" x 240" Seats 18/20
 54" x 216" Seats 16/18
 54" x 192" Seats 14/16
 54" x 168" Seats 12/14
 54" x 144" Seats 10/12
 54" x 132" Seats 8/10
 48" x 192" Seats 14/16
 48" x 168" Seats 12/14
 48" x 144" Seats 8/10
 48" x 132" Seats 6/8



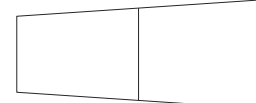
arc end

60" x 240" Seats 18/20
 60" x 216" Seats 16/18
 60" x 192" Seats 14/16
 60" x 168" Seats 12/14
 60" x 144" Seats 10/12
 54" x 240" Seats 18/20
 54" x 216" Seats 16/18
 54" x 192" Seats 14/16
 54" x 168" Seats 12/14
 54" x 144" Seats 10/12
 54" x 132" Seats 8/10
 48" x 192" Seats 14/16
 48" x 168" Seats 12/14
 48" x 144" Seats 8/10
 48" x 132" Seats 6/8



boat

60" x 240" Seats 16/18
 60" x 216" Seats 14/16
 60" x 192" Seats 12/14
 54" x 168" Seats 10/12
 54" x 144" Seats 8/10
 54" x 132" Seats 6/8



view

60" x 240" Seats 16/18
 60" x 216" Seats 14/16
 60" x 192" Seats 12/14
 60" x 168" Seats 10/12
 60" x 144" Seats 8/10
 60" x 132" Seats 6/8

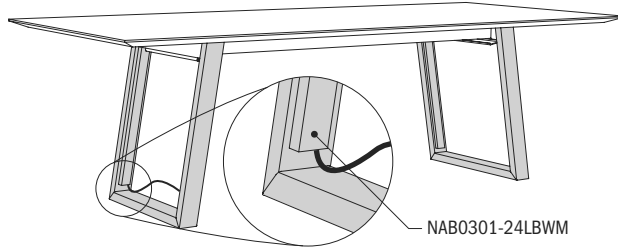
Native Bases

Native's array of base styles allow users the option of a raw open aesthetic or a closed, polish function.

Open Loop Base

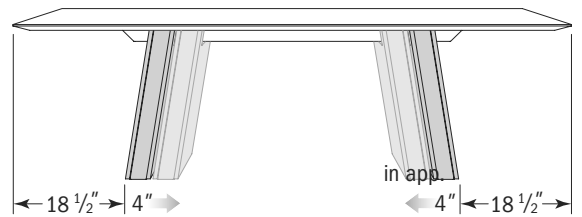
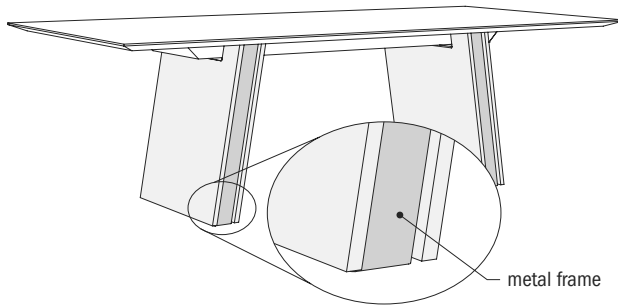
Welded steel frame. Use NAB0301-24LBWM for magnetically attached wire management.

**Note: NAB0301-19CLBWM is required when a top requires three bases.



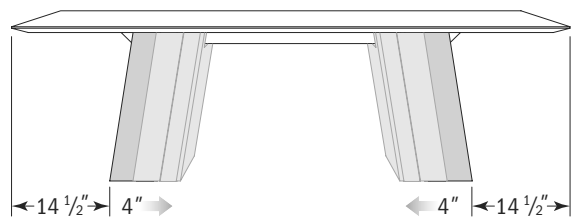
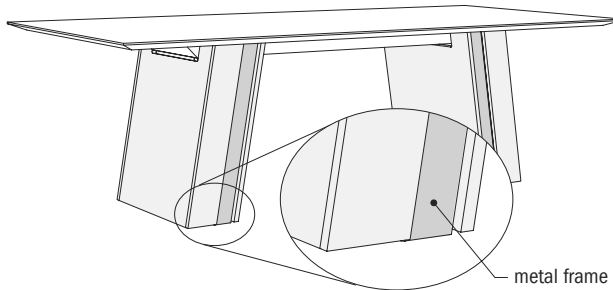
Panel Base

Panel encloses welded steel frame. "T" models: Choose any laminate for panel. "V" models: Choose matching veneer or painted panel. Design allows horizontal adjustment.



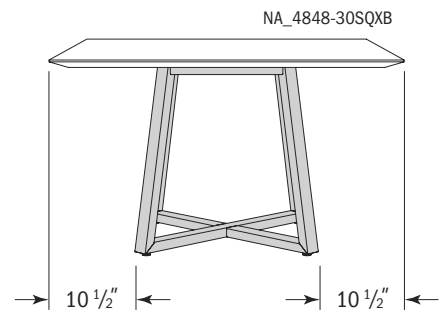
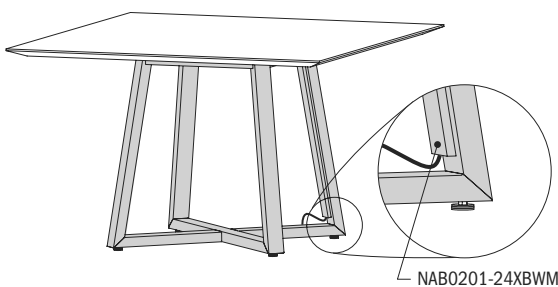
Box Base

Box encloses welded steel frame. "T" models: Choose any laminate for panel. "V" models: Choose matching veneer or painted box. Design allows horizontal adjustment.



X Base

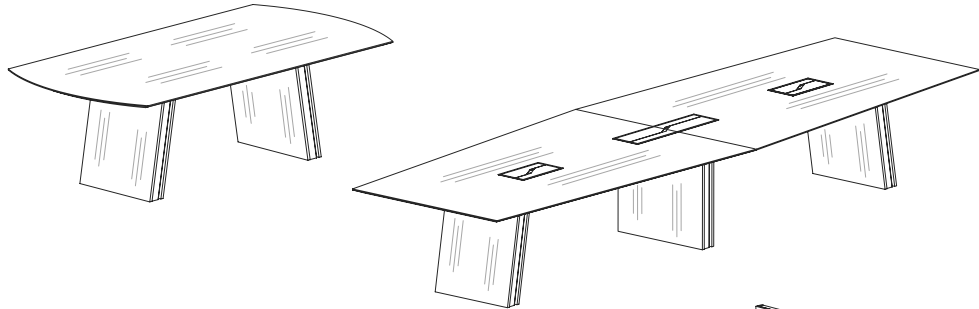
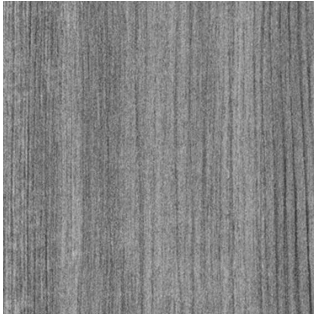
Welded steel frame. For round and square tables only. Use NAB0201-24XBWM for magnetically attached wire management.



Native Applied Materials

Laminate Grain Direction

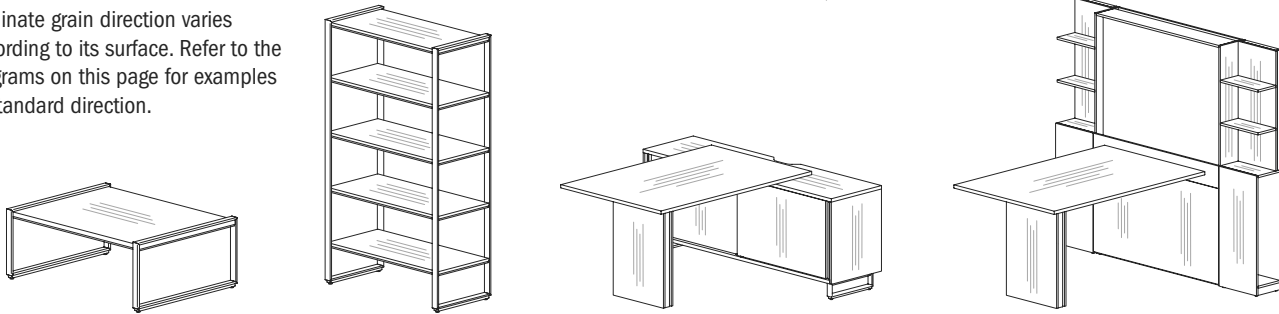
Laminate grain runs vertical as standard on all vertical surfaces. Worksurfaces run long grain. Below are examples of laminate grain direction.



PRODUCT INFORMATION

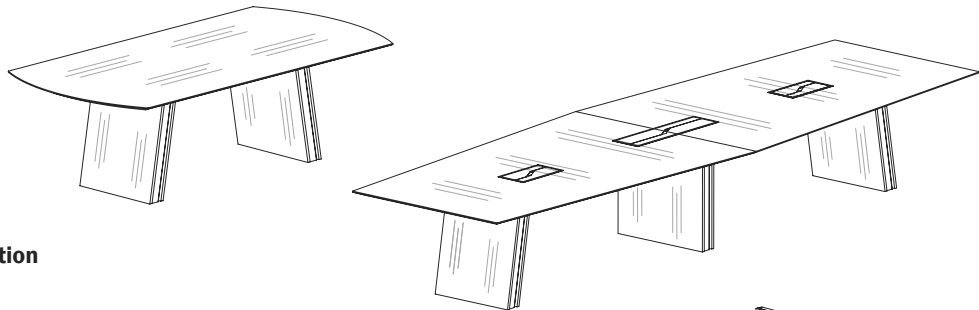
Laminate Grain

Laminate grain direction varies according to its surface. Refer to the diagrams on this page for examples of standard direction.



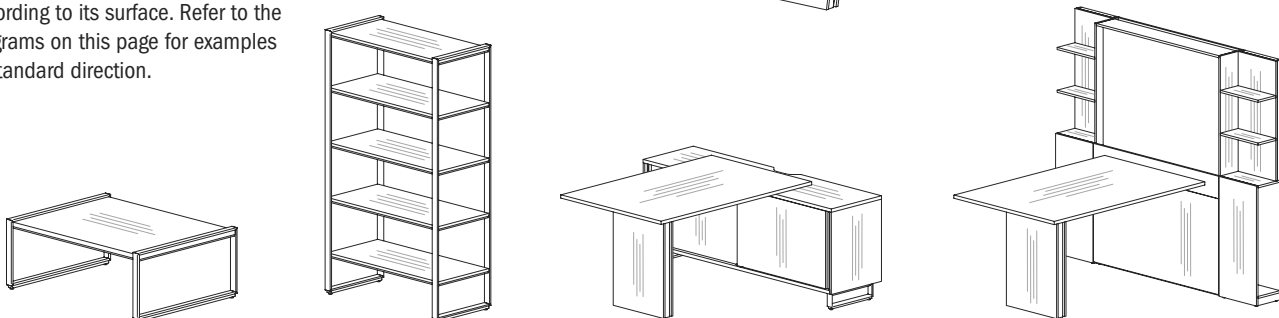
Flat Cut & Double Cut Grain Direction

Veneer grains runs vertical as standard on all vertical surfaces. 1-piece tables, runoffs, peninsula tables will run long grain. 2-piece tables will run short grain. Below are examples of veneer grain direction.



Flat Cut & Double Cut Grain Direction

Veneer grain direction varies according to its surface. Refer to the diagrams on this page for examples of standard direction.



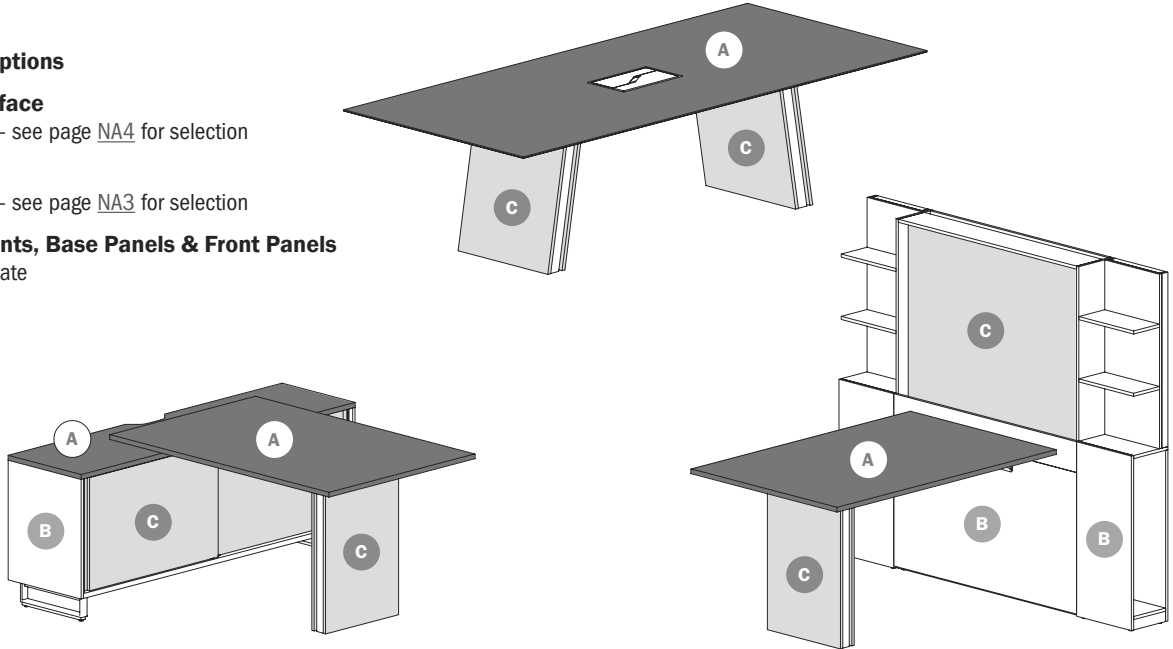
Native Applied Materials

Native Color Scheme

Native offers the flexibility to specify contrasting door fronts, or a contrasting base panels, separate from the worksurface selection. See the options available below, depending on whether a NAT or NAV model specified.

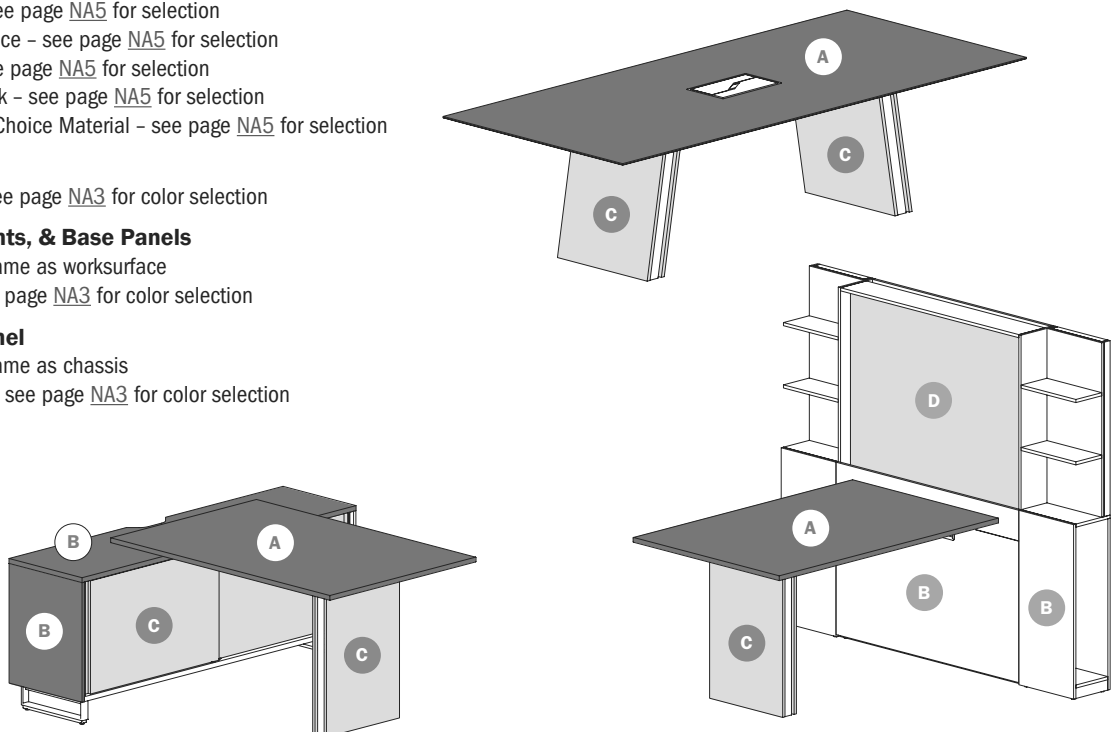
NAT Surface Options

- A = Worksurface**
Laminate – see page [NA4](#) for selection
- B = Chassis**
Laminate – see page [NA3](#) for selection
- C = Door Fronts, Base Panels & Front Panels**
Any Laminate



NAV Surface Options

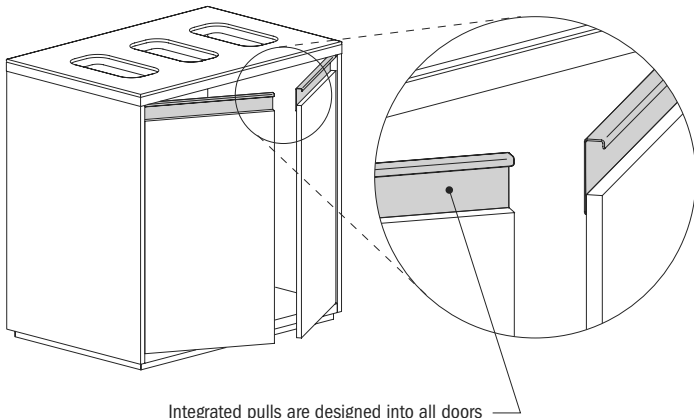
- A = Worksurface**
Veneer – see page [NA5](#) for selection
Solid Surface – see page [NA5](#) for selection
Glass – see page [NA5](#) for selection
Wood Plank – see page [NA5](#) for selection
Customer Choice Material – see page [NA5](#) for selection
- B = Chassis**
Veneer – see page [NA3](#) for color selection
- C = Door Fronts, & Base Panels**
Veneer – same as worksurface
Paint – see page [NA3](#) for color selection
- D = Front Panel**
Veneer – same as chassis
Laminate – see page [NA3](#) for color selection



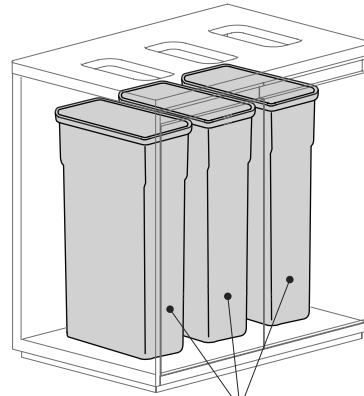
Native Product Information

PRODUCT INFORMATION

Waste Credenza



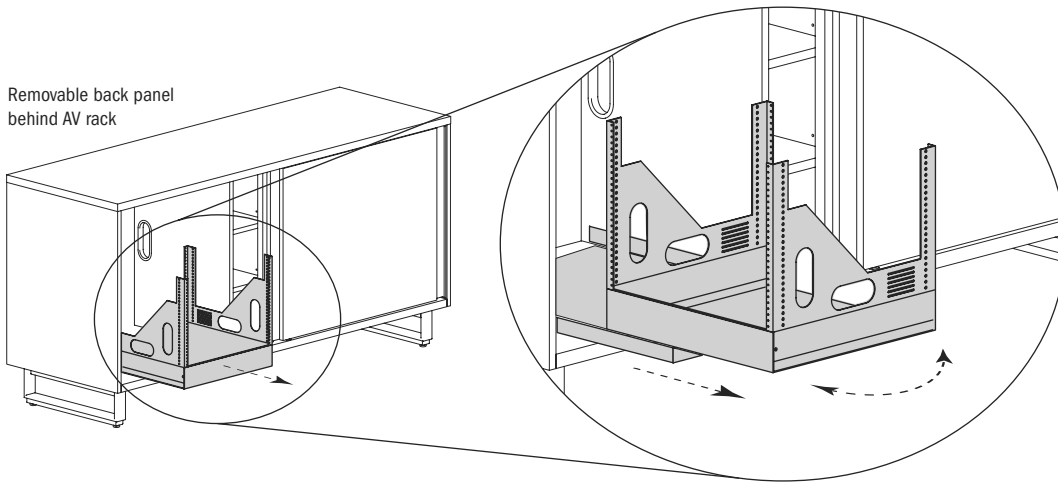
Integrated pulls are designed into all doors and drawers of Native Credenzas and are available in a variety of metal finish accents, see page [NA3](#)



Waste Credenzas accommodate three Uline Thin #H-5148 (23 gallon) trash cans, not included

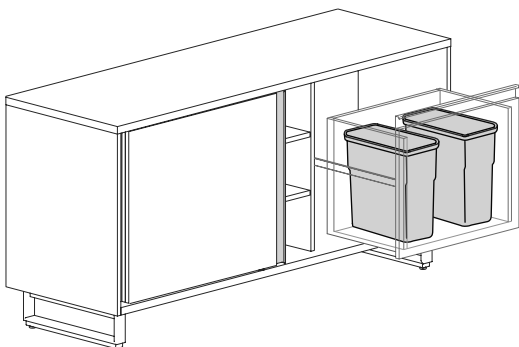
AV Credenza

Removable back panel behind AV rack



Pull-out and rotating AV rack is designed so you can access equipment and wiring. Rack can rotate 90° in either direction and can be locked in the rotated position.

Credenza Waste Drawer

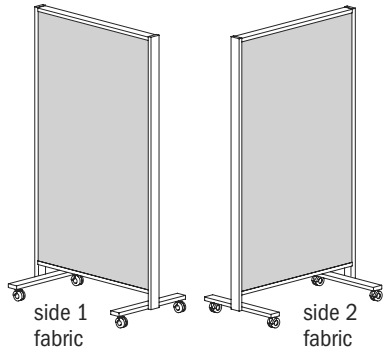


Waste drawer accommodates two Uline #S-13527 (10 gallon) trash cans, not included

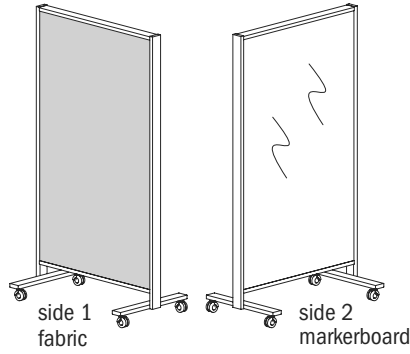
Native Product Information

Mobile Boards

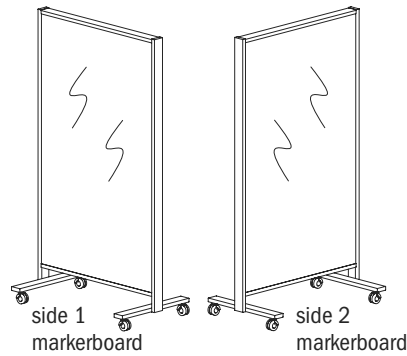
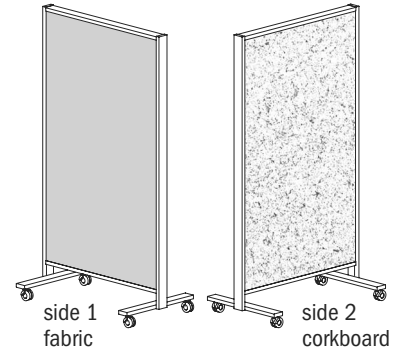
Multi-functional mobile boards can double as portable working space or serve to define boundaries within the office area. With three (3) material selections (markerboard, tackboard, and corkboard), Native mobile boards offer a variety of panel configurations to fit your needs.



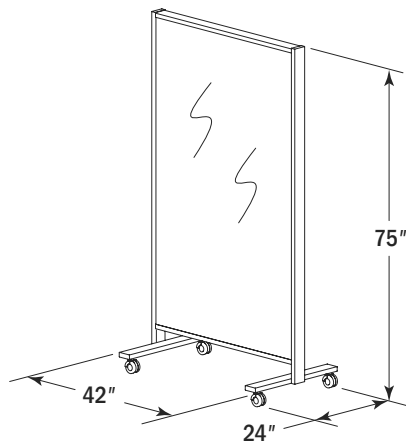
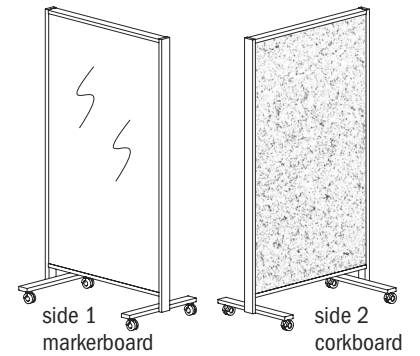
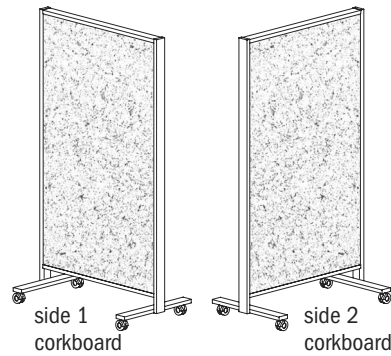
NAB2442-75MTKD
Tackboard on both sides.



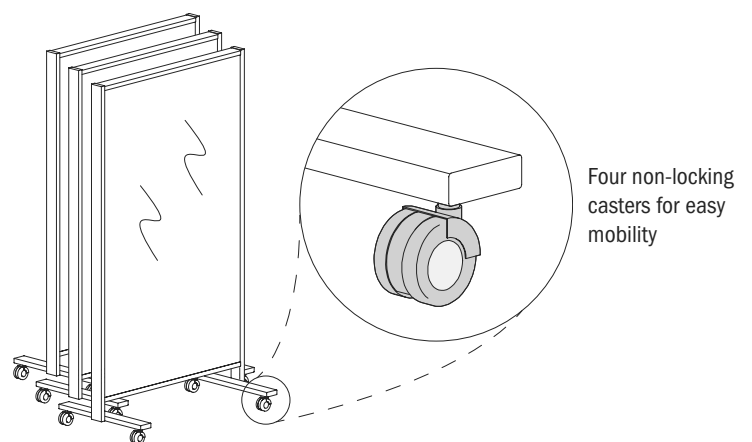
NAB2442-75MTKS
Tackboard on one side, choice of markerboard or corkboard on reverse side; specify when ordering.



NAB2442-75MMB
Markerboard both sides, corkboard both sides, or combination markerboard and corkboard; specify when ordering.



Overall dimensions
Wide base for stability



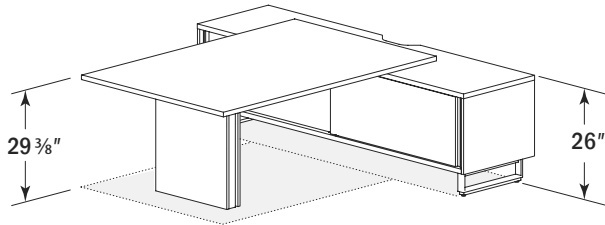
Offset Nesting
Provides for organized storage

Native Product Information

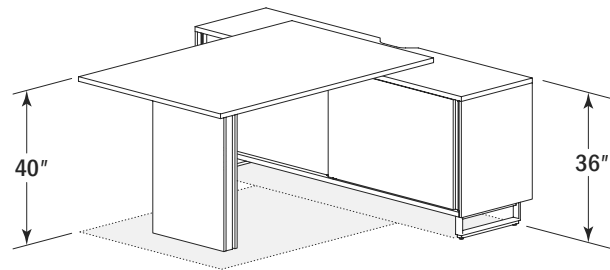
Peninsula Tables with Credenza

Peninsula tables with credenza applications are offered at standard desk height and standing height. See below for overall unit heights.

PRODUCT INFORMATION



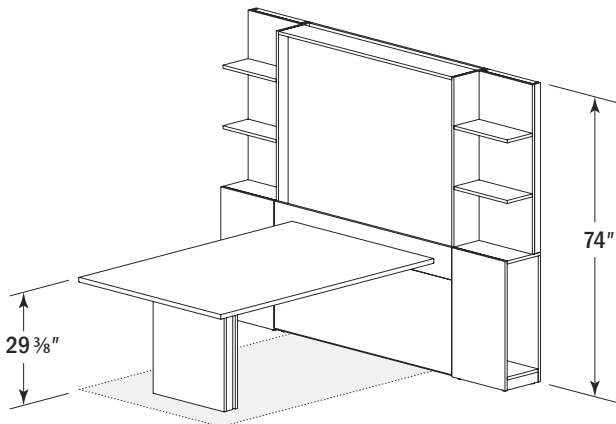
Standard Desk Height Peninsula Table
Connects to a 26"h Credenza



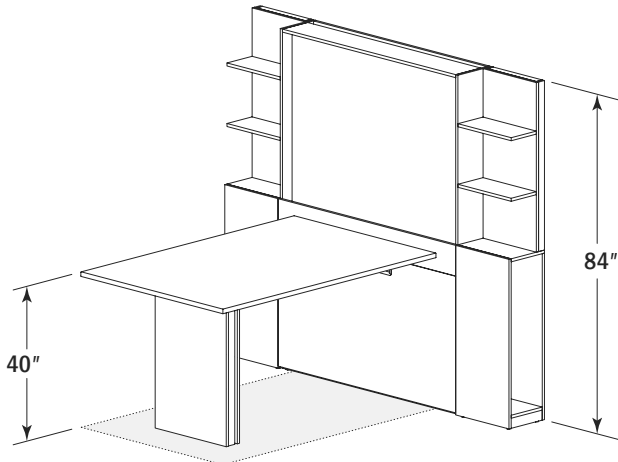
Standing Height Peninsula Table
Connects to a 36"h Credenza

Runoff Tables with Media Walls

Runoff tables with media wall applications are offered at standard desk height and standing height. See below for overall unit heights.

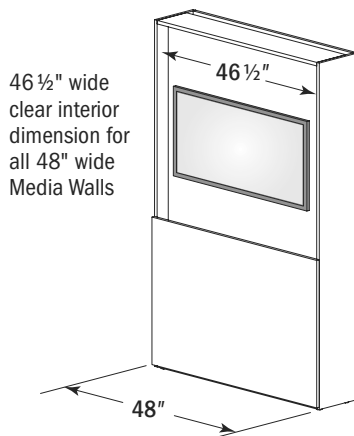


Standard Desk Height Runoff Table
Connects to a 74"h Media Wall

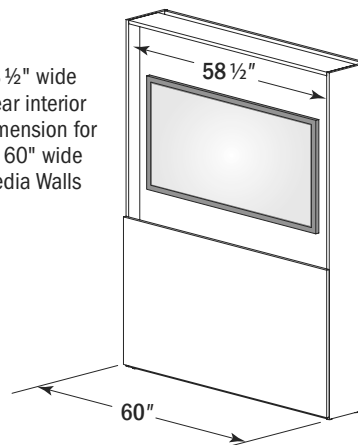


Standing Height Runoff Table
Connects to a 84"h Media Wall

TV/Monitor Sizes for Media Walls



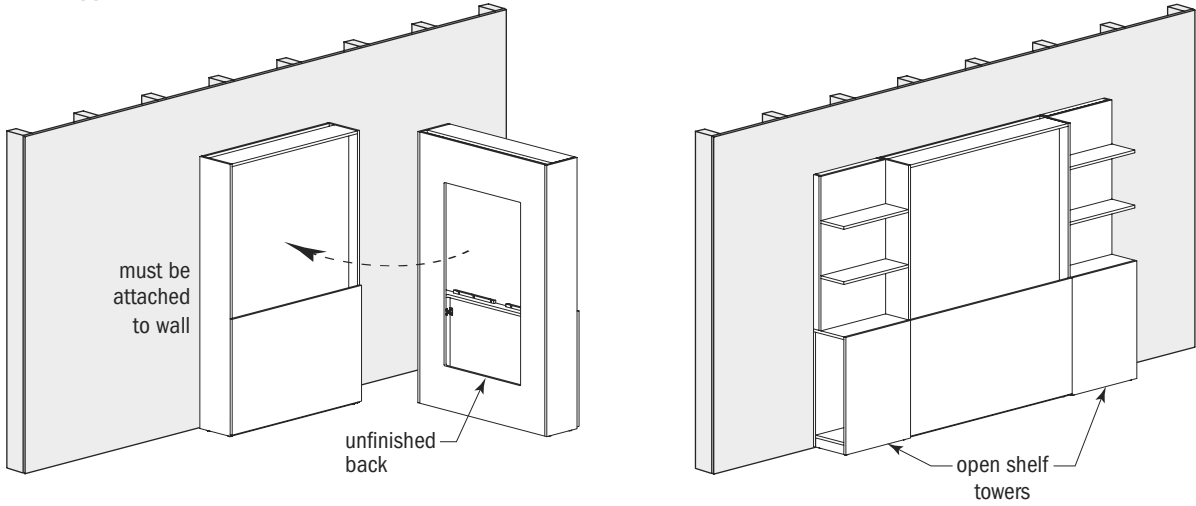
46 1/2" wide clear interior dimension for all 48" wide Media Walls



58 1/2" wide clear interior dimension for all 60" wide Media Walls

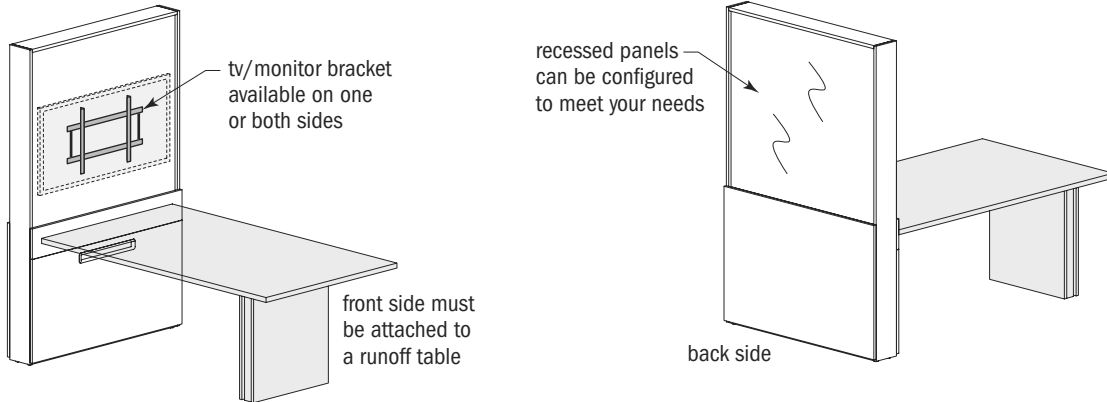
Native Product Information

Media Wall Applications



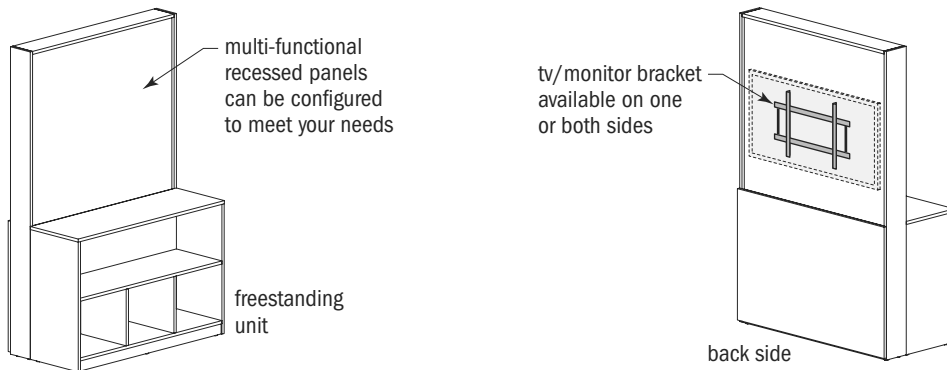
Media Wall - Wall Dependent

Media Walls have unfinished backs and are designed to be attached to a wall. Open Shelf and Side Access Wardrobe Towers are available and attach to Media Walls.



Media Wall Space Divider - Media Back

Media Wall Space Dividers with Media Back must be attach to a Runoff Table for support. The recessed panels on these dual sided units can be mixed and matched with contrasting laminates or veneers, and markerboards. TV brackets also available on one or both sides. Units not to be used with Open Shelf or Side Access Wardrobe Towers.



Media Wall Space Divider with Media Shelf - Media Back

Media Wall Space Divider with Media Shelf is a freestanding unit. Runoff Tables can be attached to the back side of unit but is not necessary. The recessed panels on these dual sided units can be mixed and matched with contrasting laminates or veneers, and markerboards. TV brackets also available on one or both sides. Units not to be used with Open Shelf or Side Access Wardrobe Towers.

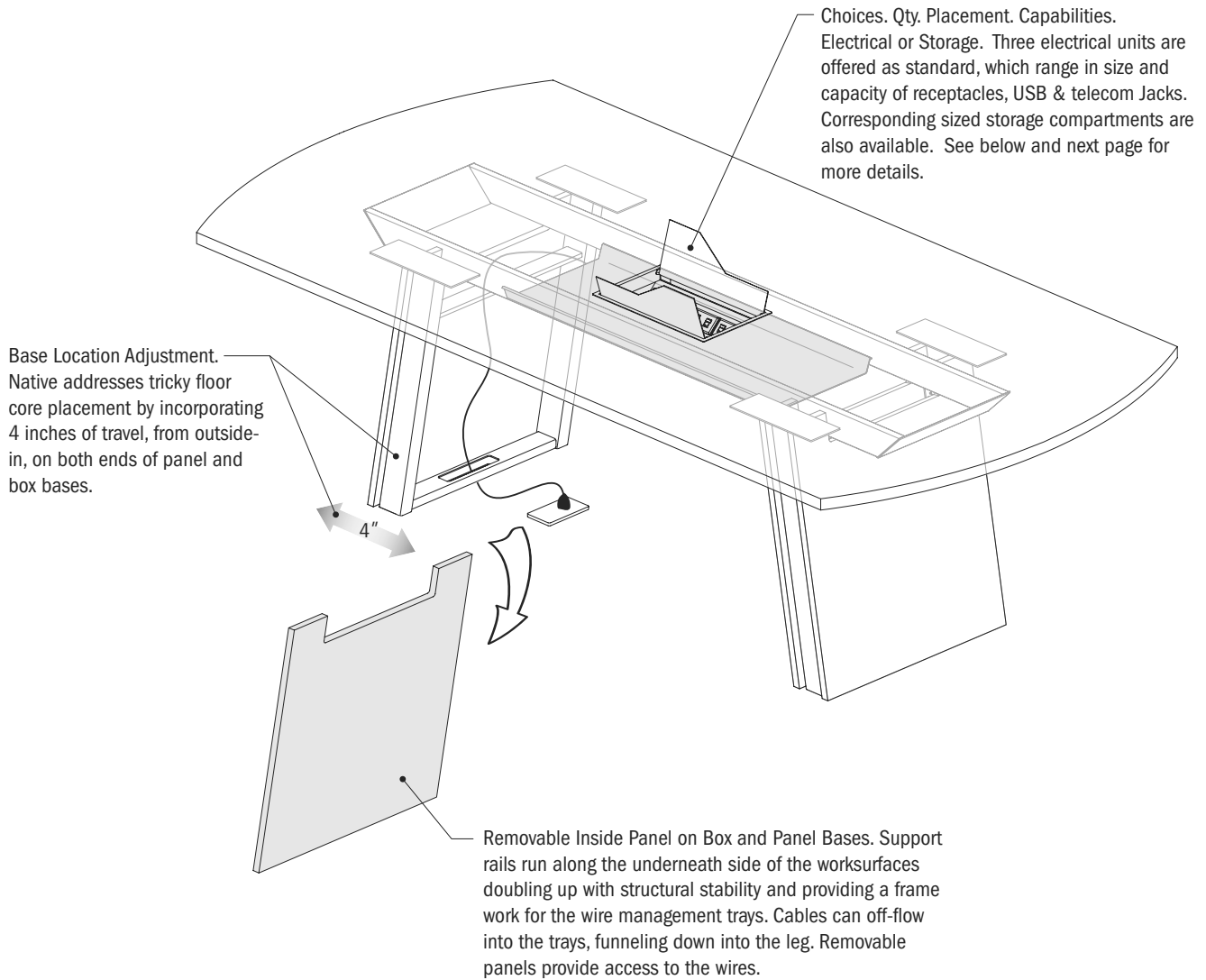
PRODUCT INFORMATION

Native Technology

Wire Management

Native accommodated wire management needs in a variety of ways, from ample technology choices to innovative adjustments.

PRODUCT INFORMATION



Worksurface Power Units and Storage Compartments

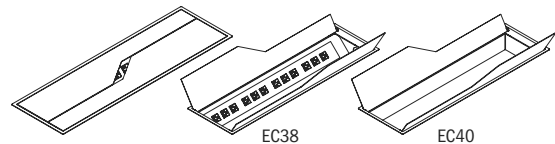
(See chart on next page for cutout code configurations)



EC36 - Cove Power Unit
Cutout Code C
Available in silver, black, or white




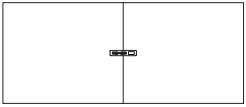
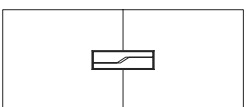

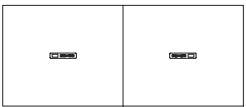
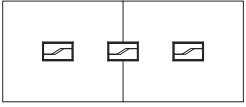

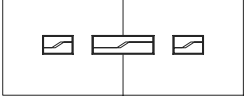
EC37 - Oasis Mini Power Unit
EC39 - Small Storage Compartment
Cutout Code M
Available in arctic silver, bright white, matte black, pewter, or soft nickel



EC38 - Oasis Power Unit
EC40 - Large Storage Compartment
Cutout Code O
Available in arctic silver, bright white, matte black, pewter, or soft nickel

Native Technology

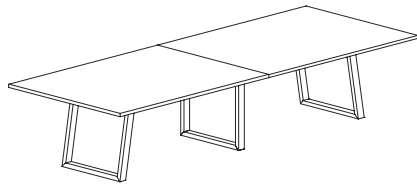
Power Unit and Storage Compartment Worksurface Cutout Code Configurations

Cutout Code	Width	Square & Round Tables			1 Piece Tables, All Shapes					2 Piece Tables, All Shapes					
		48"	54"	60"	72"	84"	96"	108"	120"	132"	144"	168"	192"	216"	240"
C1M  1 Cutout: Oasis Mini		✓	✓	✓	✓	✓	✓	✓	✓	✓	✓	✓	✓	✓	✓
C1C  1 Cutout: Cove		✓	✓	✓	✓	✓	✓	✓	✓	✓	✓	✓	✓	✓	✓
O1C  1 Cutout: Oasis									✓	✓	✓	✓	✓	✓	✓
C2M  2 Cutouts: both Oasis Mini							✓	✓	✓	✓	✓	✓	✓	✓	✓
C2C  2 Cutouts: both Cove							✓	✓	✓	✓	✓	✓	✓	✓	✓
C3M  3 Cutouts: all Oasis Mini									✓	✓	✓	✓	✓	✓	✓
C3C  3 Cutouts: all Cove									✓	✓	✓	✓	✓	✓	✓
COM3M  3 Cutouts: Mini, Oasis, Mini									✓	✓	✓	✓	✓	✓	✓

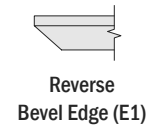
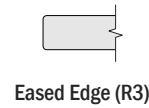
PRODUCT INFORMATION

Description

Rectangular 2pc Table with 3 Open Loop Bases



Laminate Tops "NAT" Models



Features:

- three metal, open loop bases with structural support rails
- two-piece top
- glass top has additional seams

Options:

- metal frame available in powder coat, no upcharge, or chrome, add list upcharge: for 48" wide - \$2,855, for 54" & 60" wide - \$3,267
- worksurface power & storage available, specify cutout code and order power units separately, see pages [NA14-NA15](#)
- magnetic wire manager available: order separately see page [NA124](#)

D	W	H	CTN WT	CU FT	① Model	HPL	HPL
60	192	29 ³ / ₈	555	130	NAT60192-30TTLB	\$12,600	\$13,138
60	168	29 ³ / ₈	490	116	NAT60168-30TTLB	\$10,634	\$11,171
60	144	29 ³ / ₈	440	104	NAT60144-30TTLB	\$9,377	\$9,914
54	192	29 ³ / ₈	510	124	NAT54192-30TTLB	\$12,331	\$12,868
54	168	29 ³ / ₈	449	110	NAT54168-30TTLB	\$9,873	\$10,410
54	144	29 ³ / ₈	401	98	NAT54144-30TTLB	\$8,920	\$9,456
54	132	29 ³ / ₈	376	84	NAT54132-30TTLB	\$8,545	\$9,082
48	192	29 ³ / ₈	464	116	NAT48192-30TTLB	\$10,492	\$11,029
48	168	29 ³ / ₈	408	90	NAT48168-30TTLB	\$9,387	\$9,926
48	144	29 ³ / ₈	366	84	NAT48144-30TTLB	\$8,415	\$8,953
48	132	29 ³ / ₈	344	78	NAT48132-30TTLB	\$8,135	\$8,672

To Order, Specify:

① Laminate Model #	② Top/Base Laminate	③ Top Edge	④ Metal Color	⑤ Electrical
Laminate (NAT)	See Top/Base Laminate Options	See Top Edge Options	Metal Color Options	Cutout Codes: N all tables C1M 132" - 192" wide C1C 132" - 192" wide C1O 132" - 192" wide C2M 132" - 192" wide C2C 132" - 192" wide C3C 132" - 192" wide C3M 132" - 192" wide C3MOM 132" - 192" wide

Description

Rectangular 2pc Table with 3 Open Loop Bases
(continued)

						Veneer Tops "NAV" Models				Premier Tops "NAV" Models			
						Eased Edge (R3)		Reverse Bevel Edge (E1)		Solid Surface/Glass Reverse Bevel Edge		Wood Plank Ash	
D	W	H	CTN WT	CU FT	Model	Flat Cut	Double Cut	Flat Cut	Double Cut	Solid Surface	Glass	Wood Plank Ash	Sub-Top with Base
60	192	29 3/8	555	130	NAV60192-30TTLB	\$16,817	\$19,057	\$17,091	\$19,334	\$35,603	\$33,730	--	\$15,962
60	168	29 3/8	490	116	NAV60168-30TTLB	\$13,812	\$15,534	\$14,087	\$15,809	\$30,309	\$28,612	--	\$13,180
60	144	29 3/8	440	104	NAV60144-30TTLB	\$12,265	\$13,860	\$12,540	\$14,135	\$26,474	\$24,949	--	\$11,704
54	192	29 3/8	510	124	NAV54192-30TTLB	\$16,457	\$18,228	\$16,733	\$18,504	\$33,417	\$31,680	--	\$15,629
54	168	29 3/8	449	110	NAV54168-30TTLB	\$12,917	\$14,274	\$13,191	\$14,549	\$27,815	\$26,236	--	\$12,331
54	144	29 3/8	401	98	NAV54144-30TTLB	\$11,714	\$12,975	\$11,991	\$13,251	\$24,551	\$23,133	--	\$11,182
54	132	29 3/8	376	84	NAV54132-30TTLB	\$11,238	\$12,455	\$11,513	\$12,731	\$23,005	\$21,704	--	\$10,726
48	192	29 3/8	464	116	NAV48192-30TTLB	\$14,300	\$16,017	\$14,577	\$16,293	\$29,430	\$27,831	--	\$13,576
48	168	29 3/8	408	90	NAV48168-30TTLB	\$12,345	\$13,686	\$12,620	\$13,962	\$25,644	\$24,185	--	\$11,785
48	144	29 3/8	366	84	NAV48144-30TTLB	\$11,127	\$12,372	\$11,402	\$12,647	\$22,594	\$21,274	--	\$10,623
48	132	29 3/8	344	78	NAV48132-30TTLB	\$10,755	\$11,961	\$11,031	\$12,236	\$21,269	\$20,058	--	\$10,269

NATIVE

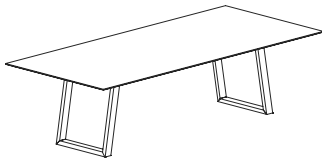
To Order, Specify:

1 Veneer Model #	2 Wood Species	3 Top Wood Finish	4 Top Edge	5 Metal Color	6 Electrical
Veneer (NAV)	Flat Cut B01 Black Oak CH1 Cherry MA1 Maple WA1 Walnut	See Flat Cut Top Wood Finish Options	See Top Edge Options	See Metal Color Options	Cutout Codes: N all tables C1M 132" - 192" wide C1C 132" - 192" wide C1O 132" - 192" wide C2M 132" - 192" wide C2C 132" - 192" wide C3C 132" - 192" wide C3M 132" - 192" wide C3MOM 132" - 192" wide See chart on page NA15 for cutout codes
	Double Cut DC1 Double Cut	3 Top Wood Finish See Double Cut Top Wood Finish Options			

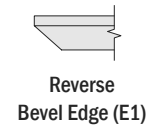
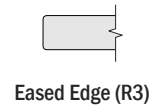
1 Specialty Top Model #	2 Top Surface Selection	3 Metal Color	4 Electrical
Solid Surface (NAV)	See Solid Surface Top Surface Selection	See Metal Color Options	Cutout Codes: N all tables C1M 132" - 192" wide C1C 132" - 192" wide C1O 132" - 192" wide C2M 132" - 192" wide C2C 132" - 192" wide C3C 132" - 192" wide C3M 132" - 192" wide C3MOM 132" - 192" wide
Glass Surface (NAV)	See Glass Top Surface Selection		
Wood Plank (NAV)	See Wood Plank Top Surface Selection		
Sub-Top w/Base (NAV)	B (Table Ships with Sub-Top, Customer applies custom Top)		

Description

Rectangular Table with Open Loop Base



Laminate Tops "NAT" Models



Features:

- two metal, open loop bases with structural support rails
- one-piece top
- glass top has additional seams

Options:

- metal base frame available in powder coat, no upcharge, or chrome, add list upcharge: for 36" wide - \$1,894, for 42" & 48" wide - \$2,197, for 54" wide - \$2,514
- worksurface power & storage available, specify cutout code and order power units separately, see pages [NA14-NA15](#)
- magnetic wire manager available: order separately see page [NA124](#)

D	W	H	CTN WT	CU FT	① Model	HPL	HPL
54	120	29 ³ / ₈	312	78	NAT54120-30TTLB	\$5,941	\$6,366
48	120	29 ³ / ₈	283	76	NAT48120-30TTLB	\$5,651	\$6,078
48	108	29 ³ / ₈	247	70	NAT48108-30TTLB	\$5,385	\$5,812
48	96	29 ³ / ₈	241	63	NAT4896-30TTLB	\$4,875	\$5,303
48	84	29 ³ / ₈	221	57	NAT4884-30TTLB	\$4,658	\$5,083
48	72	29 ³ / ₈	194	53	NAT4872-30TTLB	\$4,325	\$4,750
42	120	29 ³ / ₈	247	72	NAT42120-30TTLB	\$5,561	\$5,988
42	108	29 ³ / ₈	247	68	NAT42108-30TTLB	\$5,216	\$5,642
42	96	29 ³ / ₈	241	62	NAT4296-30TTLB	\$4,725	\$5,150
42	84	29 ³ / ₈	204	61	NAT4284-30TTLB	\$4,526	\$4,950
42	72	29 ³ / ₈	179	51	NAT4272-30TTLB	\$4,279	\$4,705
36	84	29 ³ / ₈	183	53	NAT3684-30TTLB	\$4,473	\$4,899
36	72	29 ³ / ₈	164	49	NAT3672-30TTLB	\$4,235	\$4,660

To Order, Specify:

① Laminate Model #	② Top/Base Laminate	③ Top Edge	④ Metal Color	⑤ Electrical
Laminate (NAT)	See Top/Base Laminate Options	See Top Edge Options	Metal Color Options	Cutout Codes: N all tables C1M 72" - 120" wide C1C 72" - 120" wide C1O 120" wide C2M 96" - 120" wide C2C 96" - 120" wide C3M 120" wide C3C 120" wide C3MOM 120" wide

Description

Rectangular Table with Open Loop Base
(continued)

							Veneer Tops "NAV" Models				Premier Tops "NAV" Models			
							Eased Edge (R3)		Reverse Bevel Edge (E1)		Solid Surface/Glass Reverse Bevel Edge		Wood Plank Ash	
D	W	H	CTN WT	CU FT	1 Model	Flat Cut	Double Cut	Flat Cut	Double Cut	Solid Surface	Glass	Wood Plank Ash	Sub-Top with Base	
54	120	29 3/8	312	78	NAV54120-30TTLB	\$8,162	\$9,027	\$8,327	\$9,191	\$18,939	\$17,677	--	\$7,796	
48	120	29 3/8	283	76	NAV48120-30TTLB	\$7,804	\$8,578	\$7,968	\$8,742	\$17,438	\$16,260	\$13,812	\$7,452	
48	108	29 3/8	247	70	NAV48108-30TTLB	\$7,434	\$8,135	\$7,598	\$8,300	\$16,150	\$15,047	\$12,843	\$7,101	
48	96	29 3/8	241	63	NAV4896-30TTLB	\$6,733	\$7,358	\$6,897	\$7,520	\$14,462	\$13,499	\$11,540	\$6,429	
48	84	29 3/8	221	57	NAV4884-30TTLB	\$6,429	\$6,980	\$6,594	\$7,145	\$13,250	\$12,351	\$10,637	\$6,142	
48	72	29 3/8	194	53	NAV4872-30TTLB	\$5,970	\$6,446	\$6,136	\$6,610	\$11,878	\$11,046	\$9,577	\$5,705	
42	120	29 3/8	247	72	NAV42120-30TTLB	\$7,679	\$8,356	\$7,842	\$8,520	\$16,109	\$15,078	\$12,935	\$7,333	
42	108	29 3/8	247	68	NAV42108-30TTLB	\$7,199	\$7,813	\$7,365	\$7,978	\$14,828	\$13,860	\$11,933	\$6,875	
42	96	29 3/8	241	62	NAV4296-30TTLB	\$6,523	\$7,075	\$6,687	\$7,239	\$13,343	\$12,443	\$10,730	\$6,228	
42	84	29 3/8	204	61	NAV4284-30TTLB	\$6,249	\$6,734	\$6,413	\$6,898	\$12,270	\$11,428	\$9,929	\$5,967	
42	72	29 3/8	179	51	NAV4272-30TTLB	\$5,908	\$6,328	\$6,073	\$6,492	\$11,130	\$10,348	\$9,061	\$5,643	
36	84	29 3/8	183	53	NAV3684-30TTLB	\$6,176	\$6,598	\$6,338	\$6,762	\$11,398	\$10,616	\$9,330	\$5,898	
36	72	29 3/8	164	49	NAV3672-30TTLB	\$5,844	\$6,210	\$6,010	\$6,373	\$10,384	\$9,652	\$8,549	\$5,583	

NATIVE

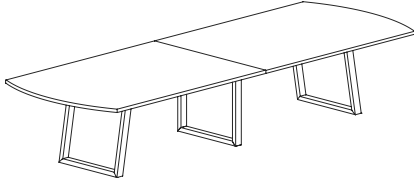
To Order, Specify:

1 Veneer Model #	2 Wood Species	3 Top Wood Finish	4 Top Edge	5 Metal Color	6 Electrical
Veneer (NAV)	Flat Cut B01 Black Oak CH1 Cherry MA1 Maple WA1 Walnut	See Flat Cut Top Wood Finish Options	See Top Edge Options	See Metal Color Options	Cutout Codes: N all tables C1M 72" - 120" wide C1C 72" - 120" wide C1O 120" wide C2M 96" - 120" wide C2C 96" - 120" wide C3M 120" wide C3C 120" wide C3MOM 120" wide See chart on page NA15 for cutout codes and power and storage unit configurations
	Double Cut DC1 Double Cut	3 Top Wood Finish See Double Cut Top Wood Finish Options			

1 Specialty Top Model #	2 Top Surface Selection	3 Metal Color	4 Electrical
Solid Surface (NAV)	See Solid Surface Top Surface Selection	See Metal Color Options	Cutout Codes: N all tables C1M 72" - 120" wide C1C 72" - 120" wide C1O 120" wide C2M 96" - 120" wide C2C 96" - 120" wide C3M 120" wide C3C 120" wide C3MOM 120" wide
Glass Surface (NAV)	See Glass Top Surface Selection		
Wood Plank (NAV)	See Wood Plank Top Surface Selection		
Sub-Top w/Base (NAV)	B (Table Ships with Sub-Top, Customer applies custom Top)		

Description

Arc End 2pc Table with 3 Open Loop Bases



Laminate Tops "NAT" Models



Eased Edge (R3)



Reverse Bevel Edge (E1)

Features:

- three metal, open loop bases with structural support rails
- two-piece top
- glass top has additional seams

Options:

- metal frame available in powder coat, no upcharge, or chrome, add list upcharge: for 48" wide - \$2,855, for 54" & 60" wide - \$3,267
- worksurface power & storage available, specify cutout code and order power units separately, see pages [NA14-NA15](#)
- magnetic wire manager available: order separately see page [NA124](#)

D	W	H	CTN WT	CU FT	① Model	HPL	HPL
60	192	29 3/8	547	130	NAT60192-30ARLB	\$12,600	\$13,138
60	168	29 3/8	482	116	NAT60168-30ARLB	\$10,634	\$11,171
60	144	29 3/8	431	104	NAT60144-30ARLB	\$9,377	\$9,914
54	192	29 3/8	503	124	NAT54192-30ARLB	\$12,331	\$12,868
54	168	29 3/8	442	110	NAT54168-30ARLB	\$9,873	\$10,410
54	144	29 3/8	394	98	NAT54144-30ARLB	\$8,920	\$9,456
54	132	29 3/8	370	84	NAT54132-30ARLB	\$8,545	\$9,082
48	192	29 3/8	459	116	NAT48192-30ARLB	\$10,492	\$11,029
48	168	29 3/8	403	90	NAT48168-30ARLB	\$9,387	\$9,926
48	144	29 3/8	360	84	NAT48144-30ARLB	\$8,415	\$8,953
48	132	29 3/8	339	78	NAT48132-30ARLB	\$8,135	\$8,672

To Order, Specify:

① Laminate Model #	② Top/Base Laminate	③ Top Edge	④ Metal Color	⑤ Electrical
Laminate (NAT)	See Top/Base Laminate Options	See Top Edge Options	Metal Color Options	Cutout Codes: N all tables C1M 132" - 192" wide C1C 132" - 192" wide C1O 132" - 192" wide C2M 132" - 192" wide C2C 132" - 192" wide C3C 132" - 192" wide C3M 132" - 192" wide C3MOM 132" - 192" wide

Description

Arc End 2pc Table with 3 Open Loop Bases
(continued)

						Veneer Tops "NAV" Models				Premier Tops "NAV" Models			
						Eased Edge (R3)		Reverse Bevel Edge (E1)		Solid Surface/Glass Reverse Bevel Edge			
D	W	H	CTN WT	CU FT	① Model	Flat Cut	Double Cut	Flat Cut	Double Cut	Solid Surface	Glass	Wood Plank Ash	Sub-Top with Base
60	192	29 3/8	547	130	NAV60192-30ARLB	\$16,817	\$19,057	\$17,091	\$19,334	\$35,603	\$33,730	--	\$15,962
60	168	29 3/8	482	116	NAV60168-30ARLB	\$13,812	\$15,534	\$14,087	\$15,809	\$30,309	\$28,612	--	\$13,180
60	144	29 3/8	431	104	NAV60144-30ARLB	\$12,265	\$13,860	\$12,540	\$14,135	\$26,474	\$24,949	--	\$11,704
54	192	29 3/8	503	124	NAV54192-30ARLB	\$16,457	\$18,228	\$16,733	\$18,504	\$33,417	\$31,680	--	\$15,629
54	168	29 3/8	442	110	NAV54168-30ARLB	\$12,917	\$14,274	\$13,191	\$14,549	\$27,815	\$26,236	--	\$12,331
54	144	29 3/8	394	98	NAV54144-30ARLB	\$11,714	\$12,975	\$11,991	\$13,251	\$24,551	\$23,133	--	\$11,182
54	132	29 3/8	370	84	NAV54132-30ARLB	\$11,238	\$12,455	\$11,513	\$12,731	\$23,005	\$21,704	--	\$10,726
48	192	29 3/8	459	116	NAV48192-30ARLB	\$14,300	\$16,017	\$14,577	\$16,293	\$29,430	\$27,831	--	\$13,576
48	168	29 3/8	403	90	NAV48168-30ARLB	\$12,345	\$13,686	\$12,620	\$13,962	\$25,644	\$24,185	--	\$11,785
48	144	29 3/8	360	84	NAV48144-30ARLB	\$11,127	\$12,372	\$11,402	\$12,647	\$22,594	\$21,274	--	\$10,623
48	132	29 3/8	339	78	NAV48132-30ARLB	\$10,755	\$11,961	\$11,031	\$12,236	\$21,269	\$20,058	--	\$10,269

NATIVE

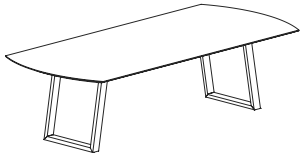
To Order, Specify:

① Veneer Model #	② Wood Species	③ Top Wood Finish	④ Top Edge	⑤ Metal Color	⑥ Electrical
Veneer (NAV)	Flat Cut B01 Black Oak CH1 Cherry MA1 Maple WA1 Walnut	See Flat Cut Top Wood Finish Options	See Top Edge Options	See Metal Color Options	Cutout Codes: N all tables C1M 132" - 192" wide C1C 132" - 192" wide C1O 132" - 192" wide C2M 132" - 192" wide C2C 132" - 192" wide C3C 132" - 192" wide C3M 132" - 192" wide C3MOM 132" - 192" wide See chart on page NA15 for cutout codes
	Double Cut DC1 Double Cut	See Double Cut Top Wood Finish Options			

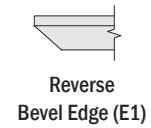
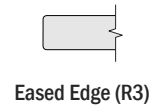
① Specialty Top Model #	② Top Surface Selection	③ Metal Color	④ Electrical
Solid Surface (NAV)	See Solid Surface Top Surface Selection	See Metal Color Options	Cutout Codes: N all tables C1M 132" - 192" wide C1C 132" - 192" wide C1O 132" - 192" wide C2M 132" - 192" wide C2C 132" - 192" wide C3C 132" - 192" wide C3M 132" - 192" wide C3MOM 132" - 192" wide
Glass Surface (NAV)	See Glass Top Surface Selection		
Wood Plank (NAV)	See Wood Plank Top Surface Selection		
Sub-Top w/Base (NAV)	B (Table Ships with Sub-Top, Customer applies custom Top)		

Description

Arc End Table with Open Loop Base



Laminate Tops "NAT" Models



Features:

- two metal, open loop bases with structural support rails
- one-piece top
- glass top has additional seams

Options:

- metal base frame available in powder coat, no upcharge, or chrome, add list upcharge: for 36" wide - \$1,894, for 42" & 48" wide - \$2,197, for 54" wide - \$2,514
- worksurface power & storage available, specify cutout code and order power units separately, see pages [NA14-NA15](#)
- magnetic wire manager available: order separately see page [NA124](#)

D	W	H	CTN WT	CU FT	① Model	HPL	HPL
54	120	29 ³ / ₈	305	78	NAT54120-30ARLB	\$4,112	\$4,538
48	120	29 ³ / ₈	277	76	NAT48120-30ARLB	\$5,651	\$6,078
48	108	29 ³ / ₈	263	70	NAT48108-30ARLB	\$5,385	\$5,812
48	96	29 ³ / ₈	195	63	NAT4896-30ARLB	\$4,875	\$5,303
48	84	29 ³ / ₈	216	57	NAT4884-30ARLB	\$4,658	\$5,083
48	72	29 ³ / ₈	140	29	NAT4872-30ARLB	\$4,325	\$4,750
42	120	29 ³ / ₈	254	72	NAT42120-30ARLB	\$5,561	\$5,988
42	108	29 ³ / ₈	254	68	NAT42108-30ARLB	\$5,216	\$5,642
42	96	29 ³ / ₈	207	62	NAT4296-30ARLB	\$4,725	\$5,150
42	84	29 ³ / ₈	199	61	NAT4284-30ARLB	\$4,526	\$4,950
42	72	29 ³ / ₈	119	51	NAT4272-30ARLB	\$4,279	\$4,705
36	84	29 ³ / ₈	179	53	NAT3684-30ARLB	\$4,473	\$4,899
36	72	29 ³ / ₈	111	49	NAT3672-30ARLB	\$4,235	\$4,660

To Order, Specify:

① Laminate Model #	② Top/Base Laminate	③ Top Edge	④ Metal Color	⑤ Electrical
Laminate (NAT)	See Top/Base Laminate Options	See Top Edge Options	Metal Color Options	Cutout Codes: N all tables C1M 72" - 120" wide C1C 72" - 120" wide C1O 120" wide C2M 96" - 120" wide C2C 96" - 120" wide C3M 120" wide C3C 120" wide C3MOM 120" wide

Description

Arc End Table with Open Loop Base
(continued)

						Veneer Tops "NAV" Models				Premier Tops "NAV" Models			
						Eased Edge (R3)		Reverse Bevel Edge (E1)		Solid Surface/Glass Reverse Bevel Edge			
D	W	H	CTN WT	CU FT	1 Model	Flat Cut	Double Cut	Flat Cut	Double Cut	Solid Surface	Glass	Wood Plank Ash	Sub-Top with Base
54	120	29 3/8	305	78	NAV54120-30ARLB	\$5,648	\$6,512	\$5,814	\$6,676	\$16,427	\$15,162	--	\$5,395
48	120	29 3/8	277	76	NAV48120-30ARLB	\$7,804	\$8,578	\$7,968	\$8,742	\$17,438	\$16,260	--	\$7,452
48	108	29 3/8	263	70	NAV48108-30ARLB	\$7,434	\$8,135	\$7,598	\$8,300	\$16,150	\$15,047	--	\$7,101
48	96	29 3/8	195	63	NAV4896-30ARLB	\$6,733	\$7,358	\$6,897	\$7,520	\$14,462	\$13,499	--	\$6,429
48	84	29 3/8	216	57	NAV4884-30ARLB	\$6,429	\$6,980	\$6,594	\$7,145	\$13,250	\$12,351	--	\$6,142
48	72	29 3/8	140	29	NAV4872-30ARLB	\$5,970	\$6,446	\$6,136	\$6,610	\$11,878	\$11,046	--	\$5,705
42	120	29 3/8	254	72	NAV42120-30ARLB	\$7,679	\$8,356	\$7,842	\$8,520	\$16,109	\$15,078	--	\$7,333
42	108	29 3/8	254	68	NAV42108-30ARLB	\$7,199	\$7,813	\$7,365	\$7,978	\$14,828	\$13,860	--	\$6,875
42	96	29 3/8	207	62	NAV4296-30ARLB	\$6,523	\$7,075	\$6,687	\$7,239	\$13,343	\$12,443	--	\$6,228
42	84	29 3/8	199	61	NAV4284-30ARLB	\$6,249	\$6,734	\$6,413	\$6,898	\$12,270	\$11,428	--	\$5,967
42	72	29 3/8	119	51	NAV4272-30ARLB	\$5,908	\$6,328	\$6,073	\$6,492	\$11,130	\$10,348	--	\$5,643
36	84	29 3/8	179	53	NAV3684-30ARLB	\$6,176	\$6,598	\$6,338	\$6,762	\$11,398	\$10,616	--	\$5,898
36	72	29 3/8	111	49	NAV3672-30ARLB	\$5,844	\$6,210	\$6,010	\$6,373	\$10,384	\$9,652	--	\$5,583

NATIVE

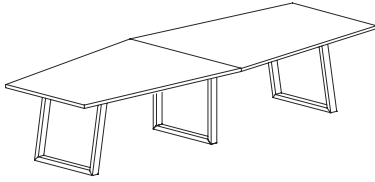
To Order, Specify:

1 Veneer Model #	2 Wood Species	3 Top Wood Finish	4 Top Edge	5 Metal Color	6 Electrical
Veneer (NAV)	<p>Flat Cut B01 Black Oak CH1 Cherry MA1 Maple WA1 Walnut</p> <p>Double Cut DC1 Double Cut</p>	<p>See Flat Cut Top Wood Finish Options</p> <p>3 Top Wood Finish See Double Cut Top Wood Finish Options</p>	See Top Edge Options	See Metal Color Options	<p>Cutout Codes: N all tables C1M 72" - 120" wide C1C 72" - 120" wide C1O 120" wide C2M 96" - 120" wide C2C 96" - 120" wide C3M 120" wide C3C 120" wide C3MOM 120" wide</p> <p>See chart on page NA15 for cutout codes</p>

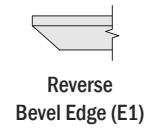
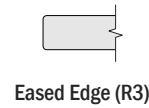
1 Specialty Top Model #	2 Top Surface Selection	3 Metal Color	4 Electrical
Solid Surface (NAV)	See Solid Surface Top Surface Selection	See Metal Color Options	<p>Cutout Codes: N all tables C1M 72" - 120" wide C1C 72" - 120" wide C1O 120" wide C2M 96" - 120" wide C2C 96" - 120" wide C3M 120" wide C3C 120" wide C3MOM 120" wide</p>
Glass Surface (NAV)	See Glass Top Surface Selection		
Wood Plank (NAV)	See Wood Plank Top Surface Selection		
Sub-Top w/Base (NAV)	B (Table Ships with Sub-Top, Customer applies custom Top)		

Description

Boat Shape 2pc Table with 3 Open Loop Bases



Laminate Tops "NAT" Models



Features:

- three metal, open loop bases with structural support rails
- two-piece top
- glass top has additional seams

Options:

- narrow end of 60" wide table is 48"d; narrow end of 54" wide table is 42"d
- metal frame available in powder coat, no upcharge, or chrome, add list upcharge: for 54" & 60" wide - \$3,267
- worksurface power & storage available, specify cutout code and order power units separately, see pages [NA14-NA15](#)
- magnetic wire manager available: order separately see page [NA124](#)

D	W	H	CTN WT	CU FT	① Model	HPL	HPL
60	192	29 ³ / ₈	510	130	NAT60192-30BTLB	\$12,557	\$13,094
54	168	29 ³ / ₈	411	110	NAT54168-30BTLB	\$9,834	\$10,371
54	144	29 ³ / ₈	368	98	NAT54144-30BTLB	\$8,881	\$9,418
54	132	29 ³ / ₈	346	84	NAT54132-30BTLB	\$8,508	\$9,046

NATIVE

To Order, Specify:

① Laminate Model #	② Top/Base Laminate	③ Top Edge	④ Metal Color	⑤ Electrical
Laminate (NAT)	See Top/Base Laminate Options	See Top Edge Options	Metal Color Options	Cutout Codes: N all tables C1M 132" - 192" wide C1C 132" - 192" wide C1O 132" - 192" wide C2M 132" - 192" wide C2C 132" - 192" wide C3C 132" - 192" wide C3M 132" - 192" wide C3MOM 132" - 192" wide

Description

Boat Shape 2pc Table with 3 Open Loop Bases
(continued)

						Veneer Tops "NAV" Models				Premier Tops "NAV" Models			
						Eased Edge (R3)		Reverse Bevel Edge (E1)		Solid Surface/Glass Reverse Bevel Edge		Wood Plank Ash	
D	W	H	CTN WT	CU FT	1 Model	Flat Cut	Double Cut	Flat Cut	Double Cut	Solid Surface	Glass	Wood Plank Ash	Sub-Top with Base
60	192	29 3/8	510	130	NAV60192-30BTLB	\$16,758	\$18,547	\$17,035	\$18,824	\$35,545	\$33,674	--	\$15,907
54	168	29 3/8	411	110	NAV54168-30BTLB	\$12,866	\$14,219	\$13,142	\$14,495	\$27,765	\$26,186	--	\$12,281
54	144	29 3/8	368	98	NAV54144-30BTLB	\$11,665	\$12,919	\$11,941	\$13,194	\$24,502	\$23,081	--	\$11,134
54	132	29 3/8	346	84	NAV54132-30BTLB	\$11,191	\$12,402	\$11,465	\$12,679	\$22,958	\$21,657	--	\$10,682

NATIVE

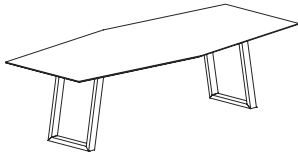
To Order, Specify:

1 Veneer Model #	2 Wood Species	3 Top Wood Finish	4 Top Edge	5 Metal Color	6 Electrical
Veneer (NAV)	Flat Cut B01 Black Oak CH1 Cherry MA1 Maple WA1 Walnut	See Flat Cut Top Wood Finish Options	See Top Edge Options	See Metal Color Options	Cutout Codes: N all tables C1M 132" - 192" wide C1C 132" - 192" wide C1O 132" - 192" wide C2M 132" - 192" wide C2C 132" - 192" wide C3C 132" - 192" wide C3M 132" - 192" wide C3MOM 132" - 192" wide See chart on page NA15 for cutout codes
	Double Cut DC1 Double Cut	3 Top Wood Finish See Double Cut Top Wood Finish Options			

1 Specialty Top Model #	2 Top Surface Selection	3 Metal Color	4 Electrical
Solid Surface (NAV)	See Solid Surface Top Surface Selection	See Metal Color Options	Cutout Codes: N all tables C1M 132" - 192" wide C1C 132" - 192" wide C1O 132" - 192" wide C2M 132" - 192" wide C2C 132" - 192" wide C3C 132" - 192" wide C3M 132" - 192" wide C3MOM 132" - 192" wide
Glass Surface (NAV)	See Glass Top Surface Selection		
Wood Plank (NAV)	See Wood Plank Top Surface Selection		
Sub-Top w/Base (NAV)	B (Table Ships with Sub-Top, Customer applies custom Top)		

Description

Boat Shape Table with Open Loop Base



Laminate Tops "NAT" Models



Eased Edge (R3)



Reverse Bevel Edge (E1)

Features:

- two metal, open loop bases with structural support rails
- one-piece top
- narrow end of table is 36"d
- glass top has additional seams

Options:

- metal base frame available in powder coat, no upcharge, or chrome, add list upcharge: for 42" & 48" wide - \$2,197
- worksurface power & storage available, specify cutout code and order power units separately, see pages [NA14-NA15](#)
- magnetic wire manager available: order separately see page [NA124](#)

D	W	H	CTN WT	CU FT	① Model	HPL	HPL
48	120	29 ³ / ₈	283	76	NAT48120-30BTLB	\$5,651	\$6,078
48	108	29 ³ / ₈	243	71	NAT48108-30BTLB	\$5,385	\$5,812
48	96	29 ³ / ₈	218	63	NAT4896-30BTLB	\$4,787	\$5,214
48	84	29 ³ / ₈	200	57	NAT4884-30BTLB	\$4,618	\$5,046
42	72	29 ³ / ₈	168	60	NAT4272-30BTLB	\$4,279	\$4,705

NATIVE

To Order, Specify:

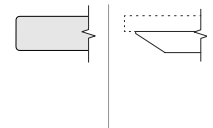
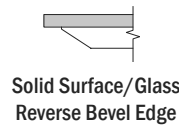
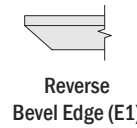
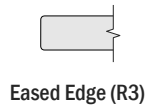
① Laminate Model #	② Top/Base Laminate	③ Top Edge	④ Metal Color	⑤ Electrical
Laminate (NAT)	See Top/Base Laminate Options	See Top Edge Options	Metal Color Options	Cutout Codes: N all tables C1M 72" - 120" wide C1C 72" - 120" wide C1O 120" wide C2M 96" - 120" wide C2C 96" - 120" wide C3M 120" wide C3C 120" wide C3MOM 120" wide

Description

Boat Shape Table with Open Loop Base
(continued)

Veneer Tops "NAV" Models

Premier Tops "NAV" Models



D	W	H	CTN WT	CU FT	① Model	Veneer Tops "NAV" Models		Premier Tops "NAV" Models					
						Flat Cut	Double Cut	Flat Cut	Double Cut	Solid Surface	Glass	Wood Plank Ash	Sub-Top with Base
48	120	29 3/8	283	76	NAV48120-30BTLB	\$7,804	\$8,578	\$7,968	\$8,742	\$17,438	\$16,260	--	\$7,452
48	108	29 3/8	243	71	NAV48108-30BTLB	\$7,434	\$8,135	\$7,598	\$8,300	\$16,150	\$15,047	--	\$7,101
48	96	29 3/8	218	63	NAV4896-30BTLB	\$6,610	\$7,234	\$6,773	\$7,399	\$14,342	\$13,377	--	\$6,313
48	84	29 3/8	200	57	NAV4884-30BTLB	\$6,377	\$6,927	\$6,541	\$7,091	\$13,196	\$12,296	--	\$6,091
42	72	29 3/8	168	60	NAV4272-30BTLB	\$5,908	\$6,328	\$6,073	\$6,492	\$11,130	\$10,348	--	\$5,643

NATIVE

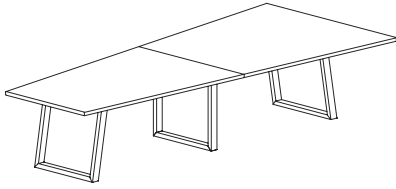
To Order, Specify:

① Veneer Model #	② Wood Species	③ Top Wood Finish	④ Top Edge	⑤ Metal Color	⑥ Electrical
Veneer (NAV)	Flat Cut B01 Black Oak CH1 Cherry MA1 Maple WA1 Walnut	See Flat Cut Top Wood Finish Options	See Top Edge Options	See Metal Color Options	Cutout Codes: N all tables C1M 72" - 120" wide C1C 72" - 120" wide C1O 120" wide C2M 96" - 120" wide C2C 96" - 120" wide C3C 120" wide C3M 120" wide C3MOM 120" wide See chart on page NA15 for cutout codes
	Double Cut DC1 Double Cut	③ Top Wood Finish See Double Cut Top Wood Finish Options			

① Specialty Top Model #	② Top Surface Selection	③ Metal Color	④ Electrical
Solid Surface (NAV)	See Solid Surface Top Surface Selection	See Metal Color Options	Cutout Codes: N all tables C1M 72" - 120" wide C1C 72" - 120" wide C1O 120" wide C2M 96" - 120" wide C2C 96" - 120" wide C3C 120" wide C3M 120" wide C3MOM 120" wide
Glass Surface (NAV)	See Glass Top Surface Selection		
Wood Plank (NAV)	See Wood Plank Top Surface Selection		
Sub-Top w/Base (NAV)	B (Table Ships with Sub-Top, Customer applies custom Top)		

Description

View 2pc Table with 3 Open Loop Bases



Laminate Tops "NAT" Models



Eased Edge (R3)



Reverse Bevel Edge (E1)

Features:

- three metal, open loop bases with structural support rails
- two-piece top
- glass top has additional seams

Options:

- narrow end of table is 36"d
- metal frame available in powder coat, no upcharge, or chrome, add list upcharge: for 54" & 60" wide - \$3,267
- worksurface power & storage available, specify cutout code and order power units separately, see pages [NA14-NA15](#)
- magnetic wire manager available: order separately see page [NA124](#)

D	W	H	CTN WT	CU FT	① Model	HPL	HPL
60	192	29 ³ / ₈	465	130	NAT60192-30VTLB	\$13,115	\$13,653
60	168	29 ³ / ₈	410	116	NAT60168-30VTLB	\$11,044	\$11,580
60	144	29 ³ / ₈	366	104	NAT60144-30VTLB	\$9,778	\$10,315
60	132	29 ³ / ₈	344	92	NAT60132-30VTLB	\$8,329	\$8,867

NATIVE

To Order, Specify:

① Laminate Model #	② Top/Base Laminate	③ Top Edge	④ Metal Color	⑤ Electrical
Laminate (NAT)	See Top/Base Laminate Options	See Top Edge Options	Metal Color Options	Cutout Codes: N all tables C1M 132" - 192" wide C1C 132" - 192" wide C1O 132" - 192" wide C2M 132" - 192" wide C2C 132" - 192" wide C3M 132" - 192" wide C3C 132" - 192" wide C3MOM 132" - 192" wide

Description

View 2pc Table with 3 Open Loop Bases
(continued)

						Veneer Tops "NAV" Models				Premier Tops "NAV" Models			
						Eased Edge (R3)		Reverse Bevel Edge (E1)		Solid Surface/Glass Reverse Bevel Edge			
D	W	H	CTN WT	CU FT	1 Model	Flat Cut	Double Cut	Flat Cut	Double Cut	Solid Surface	Glass	Wood Plank Ash	Sub-Top with Base
60	192	29 3/8	465	130	NAV60192-30VTLB	\$17,377	\$19,643	\$17,653	\$19,918	\$36,165	\$34,293	--	\$16,514
60	168	29 3/8	410	116	NAV60168-30VTLB	\$14,273	\$16,021	\$14,547	\$16,297	\$30,769	\$29,072	--	\$13,633
60	144	29 3/8	366	104	NAV60144-30VTLB	\$12,717	\$14,337	\$12,992	\$14,614	\$26,925	\$25,402	--	\$12,145
60	132	29 3/8	344	92	NAV60132-30VTLB	\$10,854	\$12,257	\$11,131	\$12,533	\$23,881	\$22,484	--	\$10,367

NATIVE

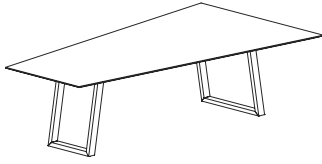
To Order, Specify:

1 Veneer Model #	2 Wood Species	3 Top Wood Finish	4 Top Edge	5 Metal Color	6 Electrical
Veneer (NAV)	Flat Cut B01 Black Oak CH1 Cherry MA1 Maple WA1 Walnut	See Flat Cut Top Wood Finish Options	See Top Edge Options	See Metal Color Options	Cutout Codes: N all tables C1M 132" - 192" wide C1C 132" - 192" wide C1O 132" - 192" wide C2M 132" - 192" wide C2C 132" - 192" wide C3M 132" - 192" wide C3C 132" - 192" wide C3MOM 132" - 192" wide See chart on page NA15 for cutout codes
	Double Cut DC1 Double Cut	3 Top Wood Finish See Double Cut Top Wood Finish Options			

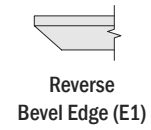
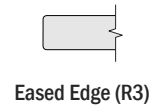
1 Specialty Top Model #	2 Top Surface Selection	3 Metal Color	4 Electrical
Solid Surface (NAV)	See Solid Surface Top Surface Selection	See Metal Color Options	Cutout Codes: N all tables C1M 132" - 192" wide C1C 132" - 192" wide C1O 132" - 192" wide C2M 132" - 192" wide C2C 132" - 192" wide C3M 132" - 192" wide C3C 132" - 192" wide C3MOM 132" - 192" wide
Glass Surface (NAV)	See Glass Top Surface Selection		
Wood Plank (NAV)	See Wood Plank Top Surface Selection		
Sub-Top w/Base (NAV)	B (Table Ships with Sub-Top, Customer applies custom Top)		

Description

View Table with Open Loop Base



Laminate Tops "NAT" Models



Features:

- two metal, open loop bases with structural support rails
- one-piece top
- narrow end of table is 36"d
- glass top has additional seams

Options:

- metal base frame available in powder coat, no upcharge, or chrome, add list upcharge: for 48" wide - \$2,197, for 54" & 60" wide - \$2,514
- worksurface power & storage available, specify cutout code and order power units separately, see pages [NA14-NA15](#)
- magnetic wire manager available: order separately see page [NA124](#)

D	W	H	CTN WT	CU FT	① Model	HPL	HPL
60	120	29 ³ / ₈	283	104	NAT60120-30VTLB	\$6,230	\$6,658
60	108	29 ³ / ₈	269	92	NAT60108-30VTLB	\$5,835	\$6,262
54	96	29 ³ / ₈	231	86	NAT5496-30VTLB	\$5,009	\$5,435
54	84	29 ³ / ₈	213	80	NAT5484-30VTLB	\$4,787	\$5,214
48	72	29 ³ / ₈	140	116	NAT4872-30VTLB	\$4,325	\$4,750

NATIVE

To Order, Specify:

① Laminate Model #	② Top/Base Laminate	③ Top Edge	④ Metal Color	⑤ Electrical
Laminate (NAT)	See Top/Base Laminate Options	See Top Edge Options	Metal Color Options	Cutout Codes: N all tables C1M 72" - 120" wide C1C 72" - 120" wide C1O 120" wide C2M 96" - 120" wide C2C 96" - 120" wide C3M 120" wide C3C 120" wide C3MOM 120" wide

Description

View Table with Open Loop Base
(continued)

						Veneer Tops "NAV" Models				Premier Tops "NAV" Models			
						Eased Edge (R3)		Reverse Bevel Edge (E1)		Solid Surface/Glass Reverse Bevel Edge			
D	W	H	CTN WT	CU FT	① Model	Flat Cut	Double Cut	Flat Cut	Double Cut	Solid Surface	Glass	Wood Plank Ash	Sub-Top with Base
60	120	29 3/8	283	104	NAV60120-30VTLB	\$8,521	\$9,477	\$8,686	\$9,640	\$20,441	\$19,092	--	\$8,138
60	108	29 3/8	269	92	NAV60108-30VTLB	\$8,001	\$8,860	\$8,164	\$9,023	\$18,728	\$17,514	--	\$7,641
54	96	29 3/8	231	86	NAV5496-30VTLB	\$6,880	\$7,578	\$7,045	\$7,742	\$15,525	\$14,494	--	\$6,573
54	84	29 3/8	213	80	NAV5484-30VTLB	\$6,576	\$7,197	\$6,740	\$7,363	\$14,248	\$13,237	--	\$6,284
48	72	29 3/8	140	116	NAV4872-30VTLB	\$5,970	\$6,446	\$6,136	\$6,610	\$11,878	\$11,046	--	\$5,705

NATIVE

To Order, Specify:

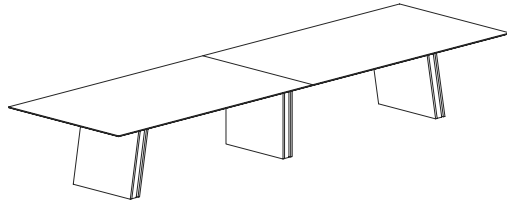
① Veneer Model #	② Wood Species	③ Top Wood Finish	④ Top Edge	⑤ Metal Color	⑥ Electrical
Veneer (NAV)	Flat Cut B01 Black Oak CH1 Cherry MA1 Maple WA1 Walnut	See Flat Cut Top Wood Finish Options	See Top Edge Options	See Metal Color Options	Cutout Codes: N all tables C1M 72" - 120" wide C1C 72" - 120" wide C1O 120" wide C2M 96" - 120" wide C2C 96" - 120" wide C3C 120" wide C3M 120" wide C3MOM 120" wide See chart on page NA15 for cutout codes
	Double Cut DC1 Double Cut	③ Top Wood Finish See Double Cut Top Wood Finish Options			

① Specialty Top Model #	② Top Surface Selection	③ Metal Color	④ Electrical
Solid Surface (NAV)	See Solid Surface Top Surface Selection	See Metal Color Options	Cutout Codes: N all tables C1M 72" - 120" wide C1C 72" - 120" wide C1O 120" wide C2M 96" - 120" wide C2C 96" - 120" wide C3C 120" wide C3M 120" wide C3MOM 120" wide
Glass Surface (NAV)	See Glass Top Surface Selection		
Wood Plank (NAV)	See Wood Plank Top Surface Selection		
Sub-Top w/Base (NAV)	B (Table Ships with Sub-Top, Customer applies custom Top)		

Description

Rectangular 2pc Table with 3 Panel Bases

Laminate Tops "NAT" Models



Eased Edge (R3)



Reverse Bevel Edge (E1)

Features:

- three panel bases with structural support rails
- two-piece top
- glass top has additional seams

Options:

- metal frame available in powder coat, no upcharge, or chrome, add list upcharge: for 48" wide - \$2,855, for 54" & 60" wide - \$3,267
- worksurface power & storage available, specify cutout code and order power units separately, see pages [NA14-NA15](#)

D	W	H	CTN WT	CU FT	① Model	HPL	HPL
60	240	29 ³ / ₈	730	182	NAT60240-30TTPB	\$17,437	\$17,973
60	216	29 ³ / ₈	674	157	NAT60216-30TTPB	\$15,901	\$16,440
60	192	29 ³ / ₈	614	130	NAT60192-30TTPB	\$14,787	\$15,324
54	240	29 ³ / ₈	681	145	NAT54240-30TTPB	\$16,630	\$17,168
54	216	29 ³ / ₈	670	140	NAT54216-30TTPB	\$15,148	\$15,685
54	192	29 ³ / ₈	575	124	NAT54192-30TTPB	\$14,287	\$14,825
48	192	29 ³ / ₈	518	116	NAT48192-30TTPB	\$12,317	\$12,854

NATIVE

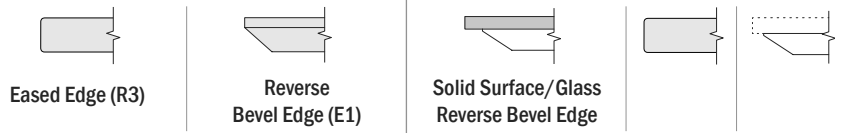
To Order, Specify:

① Laminate Model #	② Top/Base Laminate	③ Top Edge	④ Metal Color	⑤ Electrical
Laminate (NAT)	See Top/Base Laminate Options	See Top Edge Options	Metal Color Options	Cutout Codes: N all tables C1M 192" - 240" wide C1C 192" - 240" wide C1O 192" - 240" wide C2M 192" - 240" wide C2C 192" - 240" wide C3M 192" - 240" wide C3C 192" - 240" wide C3MOM 192" - 240" wide

Description

Rectangular 2pc Table with 3 Panel Bases
(continued)

Veneer Tops "NAV" Models Premier Tops "NAV" Models



D	W	H	CTN WT	CU FT	① Model	Veneer Tops "NAV" Models		Premier Tops "NAV" Models					
						Flat Cut	Double Cut	Flat Cut	Double Cut	Solid Surface	Glass	Wood Plank Ash	Sub-Top with Base
60	240	29 3/8	730	182	NAV60240-30TTPB	\$22,117	\$24,489	\$22,394	\$24,763	\$45,678	\$43,260	--	\$21,124
60	216	29 3/8	674	157	NAV60216-30TTPB	\$20,330	\$22,641	\$20,606	\$22,916	\$41,589	\$39,358	--	\$19,415
60	192	29 3/8	614	130	NAV60192-30TTPB	\$19,003	\$21,244	\$19,278	\$21,520	\$37,790	\$35,916	--	\$18,148
54	240	29 3/8	681	145	NAV54240-30TTPB	\$21,176	\$23,046	\$21,452	\$23,321	\$42,439	\$40,204	--	\$20,225
54	216	29 3/8	670	140	NAV54216-30TTPB	\$19,450	\$21,273	\$19,726	\$21,549	\$38,639	\$36,577	--	\$18,576
54	192	29 3/8	575	124	NAV54192-30TTPB	\$18,414	\$20,184	\$18,690	\$20,458	\$35,372	\$33,637	--	\$17,585
48	192	29 3/8	518	116	NAV48192-30TTPB	\$16,125	\$17,842	\$16,402	\$18,117	\$31,255	\$29,656	--	\$15,400

NATIVE

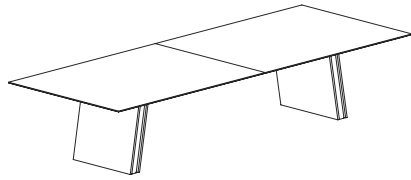
To Order, Specify:

① Veneer Model #	② Wood Species	③ Top Wood Finish	④ Base Finish	⑤ Top Edge	⑥ Metal Color	⑦ Electrical
Veneer (NAV)	Flat Cut B01 Black Oak CH1 Cherry MA1 Maple WA1 Walnut	See Top Wood Finish Options	See Base Finish Options	See Top Edge Options	See Metal Color Options	Cutout Codes: N all tables C1M 192" - 240"w C1C 192" - 240"w C1O 192" - 240"w C2M 192" - 240"w C2C 192" - 240"w C3M 192" - 240"w C3C 192" - 240"w C3MOM 192" - 240"w See chart on page NA15 for cutout codes and power and storage unit configurations
	Double Cut DC1 Double Cut	③ Top Wood Finish See Top Wood Finish Options				

① Specialty Top Model #	② Top Surface Selection	③ Base Wood Species	④a Base Wood Finish	④b Base Paint	⑤ Metal Color	⑥ Electrical
Solid Surface (NAV)	See Solid Surface Top Surface Selection	Flat Cut B01 Black Oak CH1 Cherry MA1 Maple WA1 Walnut	See Wood Base Finish Options	See Base Paint Options	See Metal Color Options	Cutout Codes: N all tables C1M 192" - 240"w C1C 192" - 240"w C1O 192" - 240"w C2M 192" - 240"w C2C 192" - 240"w C3M 192" - 240"w C3C 192" - 240"w C3MOM 192" - 240"w
Glass Surface (NAV)	See Glass Top Surface Selection					
Wood Plank (NAV)	See Wood Plank Top Surface Selection					
Sub-Top w/Base (NAV)	B (Table Ships with Sub-Top, Customer applies custom Top)	Double Cut DC1 Double Cut				

Description

Rectangular 2pc Table with 2 Panel Bases



Features:

- two panel bases with structural support rails
- two-piece top
- glass top has additional seams

Options:

- metal base frame available in powder coat, no upcharge, or chrome, add list upcharge: for 48" wide - \$2,197, for 54" & 60" wide - \$2,514
- worksurface power & storage available, specify cutout code and order power units separately, see pages [NA14-NA15](#)

Laminate Tops "NAT" Models



Eased Edge (R3)



Reverse Bevel Edge (E1)

D	W	H	CTN WT	CU FT	① Model	HPL	HPL
60	168	29 ³ / ₈	509	116	NAT60168-30TPB	\$10,873	\$11,411
60	144	29 ³ / ₈	450	104	NAT60144-30TPB	\$9,616	\$10,153
54	168	29 ³ / ₈	475	110	NAT54168-30TPB	\$9,995	\$10,532
54	144	29 ³ / ₈	420	98	NAT54144-30TPB	\$9,042	\$9,578
54	132	29 ³ / ₈	390	84	NAT54132-30TPB	\$8,667	\$9,204
48	168	29 ³ / ₈	429	90	NAT48168-30TPB	\$9,470	\$10,009
48	144	29 ³ / ₈	379	84	NAT48144-30TPB	\$8,499	\$9,036
48	132	29 ³ / ₈	351	78	NAT48132-30TPB	\$8,218	\$8,756

To Order, Specify:

① Laminate Model #	② Top/Base Laminate	③ Top Edge	④ Metal Color	⑤ Electrical
Laminate (NAT)	See Top/Base Laminate Options	See Top Edge Options	Metal Color Options	Cutout Codes: N all tables C1M 132" - 168" wide C1C 132" - 168" wide C1O 132" - 168" wide C2M 132" - 168" wide C2C 132" - 168" wide C3M 132" - 168" wide C3C 132" - 168" wide C3MOM 132" - 168" wide

Description

Rectangular 2pc Table with 2 Panel Bases
(continued)

						Veneer Tops "NAV" Models				Premier Tops "NAV" Models			
						Eased Edge (R3)		Reverse Bevel Edge (E1)		Solid Surface/Glass Reverse Bevel Edge		Wood Plank Ash	
D	W	H	CTN WT	CU FT	1 Model	Flat Cut	Double Cut	Flat Cut	Double Cut	Solid Surface	Glass	Wood Plank Ash	Sub-Top with Base
60	168	29 3/8	509	116	NAV60168-30TTPB	\$14,050	\$15,772	\$14,326	\$16,048	\$30,548	\$28,850	--	\$13,420
60	144	29 3/8	450	104	NAV60144-30TTPB	\$12,503	\$14,098	\$12,779	\$14,373	\$26,713	\$25,188	--	\$11,944
54	168	29 3/8	475	110	NAV54168-30TTPB	\$13,038	\$14,396	\$13,314	\$14,672	\$27,938	\$26,358	--	\$12,454
54	144	29 3/8	420	98	NAV54144-30TTPB	\$11,837	\$13,097	\$12,113	\$13,372	\$24,674	\$23,254	--	\$11,305
54	132	29 3/8	390	84	NAV54132-30TTPB	\$11,357	\$12,575	\$11,634	\$12,853	\$23,127	\$21,826	--	\$10,848
48	168	29 3/8	429	90	NAV48168-30TTPB	\$12,427	\$13,770	\$12,703	\$14,045	\$25,727	\$24,267	--	\$11,868
48	144	29 3/8	379	84	NAV48144-30TTPB	\$11,208	\$12,455	\$11,485	\$12,730	\$22,677	\$21,357	--	\$10,706
48	132	29 3/8	351	78	NAV48132-30TTPB	\$10,838	\$12,043	\$11,114	\$12,319	\$21,351	\$20,141	--	\$10,350

NATIVE

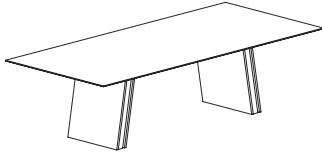
To Order, Specify:

1 Veneer Model #	2 Wood Species	3 Top Wood Finish	4 Base Finish	5 Top Edge	6 Metal Color	7 Electrical
Veneer (NAV)	Flat Cut B01 Black Oak CH1 Cherry MA1 Maple WA1 Walnut	See Top Wood Finish Options	See Base Finish Options	See Top Edge Options	See Metal Color Options	Cutout Codes: N all tables C1M 132" - 168"w C1C 132" - 168"w C1O 132" - 168"w C2M 132" - 168"w C2C 132" - 168"w C3M 132" - 168"w C3C 132" - 168"w C3MOM 132" - 168"w See chart on page NA15 for cutout codes and power and storage unit configurations
	Double Cut DC1 Double Cut	3 Top Wood Finish See Top Wood Finish Options				

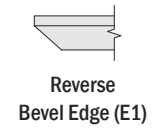
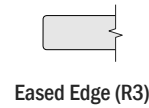
1 Specialty Top Model #	2 Top Surface Selection	3 Base Wood Species	4a Base Wood Finish	4b Base Paint	5 Metal Color	6 Electrical
Solid Surface (NAV)	See Solid Surface Top Surface Selection	Flat Cut B01 Black Oak CH1 Cherry MA1 Maple WA1 Walnut	See Wood Base Finish Options	See Base Paint Options	See Metal Color Options	Cutout Codes: N all tables C1M 132" - 168"w C1C 132" - 168"w C1O 132" - 168"w C2M 132" - 168"w C2C 132" - 168"w C3M 132" - 168"w C3C 132" - 168"w C3MOM 132" - 168"w
Glass Surface (NAV)	See Glass Top Surface Selection					
Wood Plank (NAV)	See Wood Plank Top Surface Selection					
Sub-Top w/Base (NAV)	B (Table Ships with Sub-Top, Customer applies custom Top)	Double Cut DC1 Double Cut				

Description

Rectangular Table with Panel Base



Laminate Tops "NAT" Models



Features:

- two panel bases with structural support rails
- one-piece top
- glass top has additional seams

Options:

- metal base frame available in powder coat, no upcharge, or chrome, add list upcharge: for 36" wide - \$1,894, for 42" & 48" wide - \$2,197, for 54" wide - \$2,514
- worksurface power & storage available, specify cutout code and order power units separately, see pages [NA14-NA15](#)

D	W	H	CTN WT	CU FT	① Model	HPL	HPL
54	120	29 ³ / ₈	366	78	NAT54120-30TTPB	\$7,398	\$7,823
48	120	29 ³ / ₈	329	72	NAT48120-30TTPB	\$7,025	\$7,451
48	108	29 ³ / ₈	311	69	NAT48108-30TTPB	\$6,541	\$6,968
48	96	29 ³ / ₈	287	62	NAT4896-30TTPB	\$6,250	\$6,675
48	84	29 ³ / ₈	264	57	NAT4884-30TTPB	\$5,985	\$6,412
48	72	29 ³ / ₈	238	52	NAT4872-30TTPB	\$5,460	\$5,887
42	120	29 ³ / ₈	305	68	NAT42120-30TTPB	\$6,935	\$7,361
42	108	29 ³ / ₈	289	66	NAT42108-30TTPB	\$6,297	\$6,723
42	96	29 ³ / ₈	268	63	NAT4296-30TTPB	\$6,179	\$6,605
42	84	29 ³ / ₈	247	67	NAT4284-30TTPB	\$5,920	\$6,346
42	72	29 ³ / ₈	204	50	NAT4272-30TTPB	\$5,520	\$5,947
36	84	29 ³ / ₈	219	53	NAT3684-30TTPB	\$5,503	\$5,928
36	72	29 ³ / ₈	198	45	NAT3672-30TTPB	\$5,355	\$5,781

To Order, Specify:

① Laminate Model #	② Top/Base Laminate	③ Top Edge	④ Metal Color	⑤ Electrical
Laminate (NAT)	See Top/Base Laminate Options	See Top Edge Options	Metal Color Options	Cutout Codes: N all tables C1M 72" - 120" wide C1C 72" - 120" wide C1O 120" wide C2M 96" - 120" wide C2C 96" - 120" wide C3M 120" wide C3C 120" wide C3MOM 120" wide

Description

Rectangular Table with Panel Base
(continued)

						Veneer Tops "NAV" Models				Premier Tops "NAV" Models			
						Eased Edge (R3)		Reverse Bevel Edge (E1)		Solid Surface/Glass Reverse Bevel Edge		Wood Plank Ash	
D	W	H	CTN WT	CU FT	1 Model	Flat Cut	Double Cut	Flat Cut	Double Cut	Solid Surface	Glass	Wood Plank Ash	Sub-Top with Base
54	120	29 3/8	366	78	NAV54120-30TPB	\$10,164	\$11,262	\$10,328	\$11,426	\$20,941	\$19,678	--	\$9,706
48	120	29 3/8	329	72	NAV48120-30TPB	\$9,701	\$10,779	\$9,866	\$10,944	\$19,336	\$18,158	\$15,710	\$9,265
48	108	29 3/8	311	69	NAV48108-30TPB	\$9,032	\$10,036	\$9,197	\$10,200	\$17,750	\$16,644	\$14,441	\$8,626
48	96	29 3/8	287	62	NAV4896-30TPB	\$8,628	\$9,588	\$8,794	\$9,751	\$16,361	\$15,396	\$13,436	\$8,241
48	84	29 3/8	264	57	NAV4884-30TPB	\$8,263	\$9,182	\$8,428	\$9,346	\$15,082	\$14,183	\$12,470	\$7,893
48	72	29 3/8	238	52	NAV4872-30TPB	\$7,538	\$8,376	\$7,702	\$8,541	\$13,443	\$12,611	\$11,143	\$7,198
42	120	29 3/8	305	68	NAV42120-30TPB	\$9,575	\$10,639	\$9,739	\$10,805	\$18,007	\$16,974	\$14,832	\$9,146
42	108	29 3/8	289	66	NAV42108-30TPB	\$8,696	\$9,662	\$8,861	\$9,827	\$16,325	\$15,356	\$13,429	\$8,305
42	96	29 3/8	268	63	NAV4296-30TPB	\$8,528	\$9,480	\$8,695	\$9,642	\$15,352	\$14,452	\$12,737	\$8,148
42	84	29 3/8	247	67	NAV4284-30TPB	\$8,174	\$9,082	\$8,339	\$9,246	\$14,195	\$13,354	\$11,855	\$7,807
42	72	29 3/8	204	50	NAV4272-30TPB	\$7,621	\$8,471	\$7,787	\$8,633	\$12,845	\$12,063	\$10,777	\$7,280
36	84	29 3/8	219	53	NAV3684-30TPB	\$7,596	\$8,440	\$7,762	\$8,606	\$12,821	\$12,036	\$10,750	\$7,255
36	72	29 3/8	198	45	NAV3672-30TPB	\$7,396	\$8,217	\$7,559	\$8,380	\$11,934	\$11,202	\$10,100	\$7,062

NATIVE

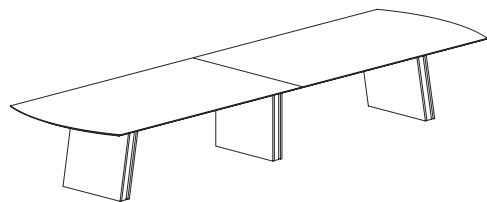
To Order, Specify:

1 Veneer Model #	2 Wood Species	3 Top Wood Finish	4 Base Finish	5 Top Edge	6 Metal Color	7 Electrical
Veneer (NAV)	Flat Cut B01 Black Oak CH1 Cherry MA1 Maple WA1 Walnut	See Top Wood Finish Options	See Base Finish Options	See Top Edge Options	See Metal Color Options	Cutout Codes: N all tables C1M 72" - 120"w C1C 72" - 120"w C1O 120"w C2M 96" - 120"w C2C 96" - 120"w C3C 120"w C3M 120"w C3MOM 120"w See chart on page NA15 for cutout codes and power and storage unit configurations
	Double Cut DC1 Double Cut	Top Wood Finish See Top Wood Finish Options				

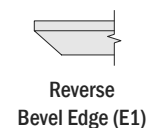
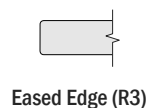
1 Specialty Top Model #	2 Top Surface Selection	3 Base Wood Species	4a Base Wood Finish	4b Base Paint	5 Metal Color	6 Electrical
Solid Surface (NAV)	See Solid Surface Top Surface Selection	Flat Cut B01 Black Oak CH1 Cherry MA1 Maple WA1 Walnut	See Wood Base Finish Options	See Base Paint Options	See Metal Color Options	Cutout Codes: N all tables C1M 72" - 120"w C1C 72" - 120"w C1O 120"w C2M 96" - 120"w C2C 96" - 120"w C3C 120"w C3M 120"w C3MOM 120"w
Glass Surface (NAV)	See Glass Top Surface Selection					
Wood Plank (NAV)	See Wood Plank Top Surface Selection					
Sub-Top w/Base (NAV)	B (Table Ships with Sub-Top, Customer applies custom Top)	Double Cut DC1 Double Cut				

Description

Arc End 2pc Table with 3 Panel Bases



Laminate Tops "NAT" Models



Features:

- three panel bases with structural support rails
- two-piece top
- glass top has additional seams

Options:

- metal frame available in powder coat, no upcharge, or chrome, add list upcharge: for 48" wide - \$2,855, for 54" & 60" wide - \$3,267
- worksurface power & storage available, specify cutout code and order power units separately, see pages [NA14-NA15](#)

D	W	H	CTN WT	CU FT	① Model	HPL	HPL
60	240	29 ³ / ₈	722	182	NAT60240-30ARPB	\$17,437	\$17,973
60	216	29 ³ / ₈	667	157	NAT60216-30ARPB	\$15,901	\$16,440
60	192	29 ³ / ₈	607	130	NAT60192-30ARPB	\$14,787	\$15,324
54	240	29 ³ / ₈	674	145	NAT54240-30ARPB	\$16,630	\$17,168
54	216	29 ³ / ₈	624	140	NAT54216-30ARPB	\$15,148	\$15,685
54	192	29 ³ / ₈	568	124	NAT54192-30ARPB	\$14,287	\$14,825
48	192	29 ³ / ₈	512	116	NAT48192-30ARPB	\$12,317	\$12,854

To Order, Specify:

① Laminate Model #	② Top/Base Laminate	③ Top Edge	④ Metal Color	⑤ Electrical
Laminate (NAT)	See Top/Base Laminate Options	See Top Edge Options	Metal Color Options	Cutout Codes: N all tables C1M 192" - 240" wide C1C 192" - 240" wide C1O 192" - 240" wide C2M 192" - 240" wide C2C 192" - 240" wide C3M 192" - 240" wide C3C 192" - 240" wide C3MOM 192" - 240" wide

Description

Arc End 2pc Table with 3 Panel Bases
(continued)

						Veneer Tops "NAV" Models				Premier Tops "NAV" Models			
						Eased Edge (R3)		Reverse Bevel Edge (E1)		Solid Surface/Glass Reverse Bevel Edge			
D	W	H	CTN WT	CU FT	Model	Flat Cut	Double Cut	Flat Cut	Double Cut	Solid Surface	Glass	Wood Plank Ash	Sub-Top with Base
60	240	29 3/8	722	182	NAV60240-30ARPB	\$22,117	\$24,489	\$22,394	\$24,763	\$45,678	\$43,260	--	\$21,124
60	216	29 3/8	667	157	NAV60216-30ARPB	\$20,330	\$22,641	\$20,606	\$22,916	\$41,589	\$39,358	--	\$19,415
60	192	29 3/8	607	130	NAV60192-30ARPB	\$19,003	\$21,244	\$19,278	\$21,520	\$37,790	\$35,916	--	\$18,148
54	240	29 3/8	674	145	NAV54240-30ARPB	\$21,176	\$23,046	\$21,452	\$23,321	\$42,439	\$40,204	--	\$20,225
54	216	29 3/8	624	140	NAV54216-30ARPB	\$19,450	\$21,273	\$19,726	\$21,549	\$38,639	\$36,577	--	\$18,576
54	192	29 3/8	568	124	NAV54192-30ARPB	\$18,414	\$20,184	\$18,690	\$20,458	\$35,372	\$33,637	--	\$17,585
48	192	29 3/8	512	116	NAV48192-30ARPB	\$16,125	\$17,842	\$16,402	\$18,117	\$31,255	\$29,656	--	\$15,400

NATIVE

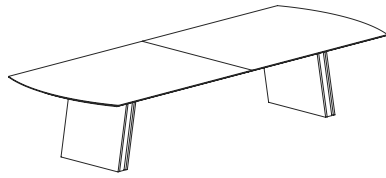
To Order, Specify:

1 Veneer Model #	2 Wood Species	3 Top Wood Finish	4 Base Finish	5 Top Edge	6 Metal Color	7 Electrical
Veneer (NAV)	Flat Cut B01 Black Oak CH1 Cherry MA1 Maple WA1 Walnut	See Top Wood Finish Options	See Base Finish Options	See Top Edge Options	See Metal Color Options	Cutout Codes: N all tables C1M 192" - 240"w C1C 192" - 240"w C1O 192" - 240"w C2M 192" - 240"w C2C 192" - 240"w C3M 192" - 240"w C3C 192" - 240"w C3MOM 192" - 240"w See chart on page NA15 for cutout codes and power and storage unit configurations
	Double Cut DC1 Double Cut	3 Top Wood Finish See Top Wood Finish Options				

1 Specialty Top Model #	2 Top Surface Selection	3 Base Wood Species	4a Base Wood Finish	4b Base Paint	5 Metal Color	6 Electrical
Solid Surface (NAV)	See Solid Surface Top Surface Selection	Flat Cut B01 Black Oak CH1 Cherry MA1 Maple WA1 Walnut	See Wood Base Finish Options	See Base Paint Options	See Metal Color Options	Cutout Codes: N all tables C1M 192" - 240"w C1C 192" - 240"w C1O 192" - 240"w C2M 192" - 240"w C2C 192" - 240"w C3M 192" - 240"w C3C 192" - 240"w C3MOM 192" - 240"w
Glass Surface (NAV)	See Glass Top Surface Selection					
Wood Plank (NAV)	See Wood Plank Top Surface Selection					
Sub-Top w/Base (NAV)	B (Table Ships with Sub-Top, Customer applies custom Top)	Double Cut DC1 Double Cut				

Description

Arc End 2pc Table with 2 Panel Bases



Features:

- two panel bases with structural support rails
- two-piece top
- glass top has additional seams

Options:

- metal base frame available in powder coat, no upcharge, or chrome, add list upcharge: for 48" wide - \$2,197, for 54" & 60" wide - \$2,514
- worksurface power & storage available, specify cutout code and order power units separately, see pages [NA14-NA15](#)

Laminate Tops "NAT" Models



Eased Edge (R3)



Reverse Bevel Edge (E1)

D	W	H	CTN WT	CU FT	① Model	HPL	HPL
60	168	29 ³ / ₈	509	116	NAT60168-30ARPB	\$10,873	\$11,411
60	144	29 ³ / ₈	442	104	NAT60144-30ARPB	\$8,747	\$9,284
54	168	29 ³ / ₈	469	110	NAT54168-30ARPB	\$9,995	\$10,532
54	144	29 ³ / ₈	414	98	NAT54144-30ARPB	\$9,042	\$9,578
54	132	29 ³ / ₈	383	84	NAT54132-30ARPB	\$7,846	\$8,384
48	168	29 ³ / ₈	423	90	NAT48168-30ARPB	\$9,470	\$10,009
48	144	29 ³ / ₈	346	84	NAT48144-30ARPB	\$8,499	\$9,036
48	132	29 ³ / ₈	346	78	NAT48132-30ARPB	\$8,218	\$8,756

To Order, Specify:

① Laminate Model #	② Top/Base Laminate	③ Top Edge	④ Metal Color	⑤ Electrical
Laminate (NAT)	See Top/Base Laminate Options	See Top Edge Options	Metal Color Options	Cutout Codes: N all tables C1M 132" - 168" wide C1C 132" - 168" wide C1O 132" - 168" wide C2M 132" - 168" wide C2C 132" - 168" wide C3M 132" - 168" wide C3C 132" - 168" wide C3MOM 132" - 168" wide

Description

Arc End 2pc Table with 2 Panel Bases
(continued)

						Veneer Tops "NAV" Models				Premier Tops "NAV" Models			
						Eased Edge (R3)		Reverse Bevel Edge (E1)		Solid Surface/Glass Reverse Bevel Edge		Wood Plank Ash	
D	W	H	CTN WT	CU FT	① Model	Flat Cut	Double Cut	Flat Cut	Double Cut	Solid Surface	Glass	Wood Plank Ash	Sub-Top with Base
60	168	29 3/8	509	116	NAV60168-30ARPB	\$14,050	\$15,772	\$14,326	\$16,048	\$30,548	\$28,850	--	\$13,420
60	144	29 3/8	442	104	NAV60144-30ARPB	\$11,374	\$12,823	\$11,649	\$13,100	\$25,581	\$24,058	--	\$10,861
54	168	29 3/8	469	110	NAV54168-30ARPB	\$13,038	\$14,396	\$13,314	\$14,672	\$27,938	\$26,358	--	\$12,454
54	144	29 3/8	414	98	NAV54144-30ARPB	\$11,837	\$13,097	\$12,113	\$13,372	\$24,674	\$23,254	--	\$11,305
54	132	29 3/8	383	84	NAV54132-30ARPB	\$10,282	\$11,386	\$10,559	\$11,662	\$22,050	\$20,750	--	\$9,822
48	168	29 3/8	423	90	NAV48168-30ARPB	\$12,427	\$13,770	\$12,703	\$14,045	\$25,727	\$24,267	--	\$11,868
48	144	29 3/8	346	84	NAV48144-30ARPB	\$11,208	\$12,455	\$11,485	\$12,730	\$22,677	\$21,357	--	\$10,706
48	132	29 3/8	346	78	NAV48132-30ARPB	\$10,838	\$12,043	\$11,114	\$12,319	\$21,351	\$20,141	--	\$10,350

NATIVE

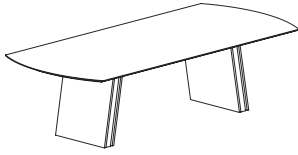
To Order, Specify:

① Veneer Model #	② Wood Species	③ Top Wood Finish	④ Base Finish	⑤ Top Edge	⑥ Metal Color	⑦ Electrical
Veneer (NAV)	Flat Cut B01 Black Oak CH1 Cherry MA1 Maple WA1 Walnut	See Top Wood Finish Options	See Base Finish Options	See Top Edge Options	See Metal Color Options	Cutout Codes: N all tables C1M 132" - 168"w C1C 132" - 168"w C1O 132" - 168"w C2M 132" - 168"w C2C 132" - 168"w C3M 132" - 168"w C3C 132" - 168"w C3MOM 132" - 168"w See chart on page NA15 for cutout codes and power and storage unit configurations
	Double Cut DC1 Double Cut	③ Top Wood Finish See Top Wood Finish Options				

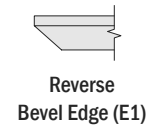
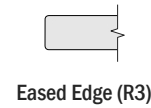
① Specialty Top Model #	② Top Surface Selection	③ Base Wood Species	④a Base Wood Finish	④b Base Paint	⑤ Metal Color	⑥ Electrical
Solid Surface (NAV)	See Solid Surface Top Surface Selection	Flat Cut B01 Black Oak CH1 Cherry MA1 Maple WA1 Walnut	See Wood Base Finish Options	See Base Paint Options	See Metal Color Options	Cutout Codes: N all tables C1M 132" - 168"w C1C 132" - 168"w C1O 132" - 168"w C2M 132" - 168"w C2C 132" - 168"w C3M 132" - 168"w C3C 132" - 168"w C3MOM 132" - 168"w
Glass Surface (NAV)	See Glass Top Surface Selection					
Wood Plank (NAV)	See Wood Plank Top Surface Selection					
Sub-Top w/Base (NAV)	B (Table Ships with Sub-Top, Customer applies custom Top)	Double Cut DC1 Double Cut				

Description

Arc End Table with Panel Base



Laminate Tops "NAT" Models



Features:

- two panel bases with structural support rails
- one-piece top
- glass top has additional seams

Options:

- metal base frame available in powder coat, no upcharge, or chrome, add list upcharge: for 36" wide - \$1,894, for 42" & 48" wide - \$2,197, for 54" wide - \$2,514
- worksurface power & storage available, specify cutout code and order power units separately, see pages [NA14-NA15](#)

D	W	H	CTN WT	CU FT	① Model	HPL	HPL
54	120	29 3/8	359	78	NAT54120-30ARPB	\$7,398	\$7,823
48	120	29 3/8	324	72	NAT48120-30ARPB	\$7,025	\$7,451
48	108	29 3/8	305	69	NAT48108-30ARPB	\$6,541	\$6,968
48	96	29 3/8	281	62	NAT4896-30ARPB	\$6,250	\$6,675
48	84	29 3/8	258	57	NAT4884-30ARPB	\$5,985	\$6,412
48	72	29 3/8	188	52	NAT4872-30ARPB	\$5,576	\$6,001
42	120	29 3/8	300	68	NAT42120-30ARPB	\$6,935	\$7,361
42	108	29 3/8	221	66	NAT42108-30ARPB	\$6,297	\$6,723
42	96	29 3/8	263	63	NAT4296-30ARPB	\$6,179	\$6,605
42	84	29 3/8	242	67	NAT4284-30ARPB	\$5,920	\$6,346
42	72	29 3/8	204	50	NAT4272-30ARPB	\$5,520	\$5,947
36	84	29 3/8	215	53	NAT3684-30ARPB	\$5,503	\$5,928
36	72	29 3/8	181	45	NAT3672-30ARPB	\$5,340	\$5,764

To Order, Specify:

① Laminate Model #	② Top/Base Laminate	③ Top Edge	④ Metal Color	⑤ Electrical
Laminate (NAT)	See Top/Base Laminate Options	See Top Edge Options	Metal Color Options	Cutout Codes: N all tables C1M 72" - 120" wide C1C 72" - 120" wide C1O 120" wide C2M 96" - 120" wide C2C 96" - 120" wide C3M 120" wide C3C 120" wide C3MOM 120" wide

Description

Arc End Table with Panel Base
(continued)

						Veneer Tops "NAV" Models				Premier Tops "NAV" Models			
						Eased Edge (R3)		Reverse Bevel Edge (E1)		Solid Surface/Glass Reverse Bevel Edge		Wood Plank Ash	
D	W	H	CTN WT	CU FT	1 Model	Flat Cut	Double Cut	Flat Cut	Double Cut	Solid Surface	Glass	Wood Plank Ash	Sub-Top with Base
54	120	29 3/8	359	78	NAV54120-30ARP	\$10,164	\$11,262	\$10,328	\$11,426	\$20,941	\$19,678	--	\$9,706
48	120	29 3/8	324	72	NAV48120-30ARP	\$9,701	\$10,779	\$9,866	\$10,944	\$19,336	\$18,158	--	\$9,265
48	108	29 3/8	305	69	NAV48108-30ARP	\$9,032	\$10,036	\$9,197	\$10,200	\$17,750	\$16,644	--	\$8,626
48	96	29 3/8	281	62	NAV4896-30ARP	\$8,628	\$9,588	\$8,794	\$9,751	\$16,361	\$15,396	--	\$8,241
48	84	29 3/8	258	57	NAV4884-30ARP	\$8,263	\$9,182	\$8,428	\$9,346	\$15,082	\$14,183	--	\$7,893
48	72	29 3/8	188	52	NAV4872-30ARP	\$7,698	\$8,553	\$7,862	\$8,718	\$13,603	\$12,771	--	\$7,352
42	120	29 3/8	300	68	NAV42120-30ARP	\$9,575	\$10,639	\$9,739	\$10,805	\$18,007	\$16,974	--	\$9,146
42	108	29 3/8	221	66	NAV42108-30ARP	\$8,696	\$9,662	\$8,861	\$9,827	\$16,325	\$15,356	--	\$8,305
42	96	29 3/8	263	63	NAV4296-30ARP	\$8,528	\$9,480	\$8,695	\$9,642	\$15,352	\$14,452	--	\$8,148
42	84	29 3/8	242	67	NAV4284-30ARP	\$8,174	\$9,082	\$8,339	\$9,246	\$14,195	\$13,354	--	\$7,807
42	72	29 3/8	204	50	NAV4272-30ARP	\$7,621	\$8,471	\$7,787	\$8,633	\$12,845	\$12,063	--	\$7,280
36	84	29 3/8	215	53	NAV3684-30ARP	\$7,596	\$8,440	\$7,762	\$8,606	\$12,821	\$12,036	--	\$7,255
36	72	29 3/8	181	45	NAV3672-30ARP	\$7,370	\$8,190	\$7,535	\$8,354	\$11,911	\$11,177	--	\$7,039

NATIVE

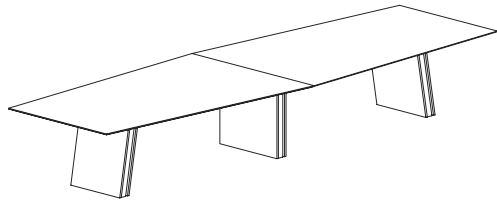
To Order, Specify:

1 Veneer Model #	2 Wood Species	3 Top Wood Finish	4 Base Finish	5 Top Edge	6 Metal Color	7 Electrical
Veneer (NAV)	Flat Cut B01 Black Oak CH1 Cherry MA1 Maple WA1 Walnut	See Top Wood Finish Options	See Base Finish Options	See Top Edge Options	See Metal Color Options	Cutout Codes: N all tables C1M 72" - 120"w C1C 72" - 120"w C1O 120"w C2M 96" - 120"w C2C 96" - 120"w C3C 120"w C3M 120"w C3MOM 120"w See chart on page NA15 for cutout codes and power and storage unit configurations
	Double Cut DC1 Double Cut	3 Top Wood Finish See Top Wood Finish Options				

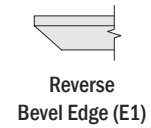
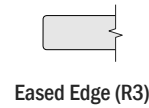
1 Specialty Top Model #	2 Top Surface Selection	3 Base Wood Species	4a Base Wood Finish	4b Base Paint	5 Metal Color	6 Electrical
Solid Surface (NAV)	See Solid Surface Top Surface Selection	Flat Cut B01 Black Oak CH1 Cherry MA1 Maple WA1 Walnut	See Wood Base Finish Options	See Base Paint Options	See Metal Color Options	Cutout Codes: N all tables C1M 72" - 120"w C1C 72" - 120"w C1O 120"w C2M 96" - 120"w C2C 96" - 120"w C3C 120"w C3M 120"w C3MOM 120"w
Glass Surface (NAV)	See Glass Top Surface Selection					
Wood Plank (NAV)	See Wood Plank Top Surface Selection					
Sub-Top w/Base (NAV)	B (Table Ships with Sub-Top, Customer applies custom Top)	Double Cut DC1 Double Cut				

Description

Boat Shape 2pc Table with 3 Panel Bases



Laminate Tops "NAT" Models



Features:

- three panel bases with structural support rails
- two-piece top
- narrow ends of table are 48"d
- glass top has additional seams

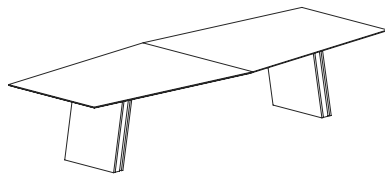
D	W	H	CTN WT	CU FT	① Model	HPL	HPL
60	240	29 3/8	669	170	NAT60240-30BTPB	\$17,619	\$18,156
60	216	29 3/8	618	145	NAT60216-30BTPB	\$15,859	\$16,397
60	192	29 3/8	572	133	NAT60192-30BTPB	\$14,743	\$15,280

Options:

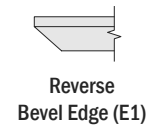
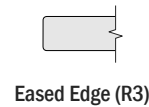
- metal base frame available in powder coat, no upcharge, or chrome, add \$3,267 list upcharge for 60" wide
- worksurface power & storage available, specify cutout code and order power units separately, see pages [NA14-NA15](#)

Description

Boat Shape 2pc Table with 2 Panel Bases



Laminate Tops "NAT" Models



Features:

- two panel bases with structural support rails
- two-piece top
- narrow ends of table are 42"d
- glass top has additional seams

D	W	H	CTN WT	CU FT	① Model	HPL	HPL
54	168	29 3/8	429	98	NAT54168-30BTPB	\$9,955	\$10,493
54	144	29 3/8	379	98	NAT54144-30BTPB	\$9,004	\$9,541
54	132	29 3/8	352	83	NAT54132-30BTPB	\$8,630	\$9,167

Options:

- metal base frame available in powder coat, no upcharge, or chrome, add \$2,514 list upcharge for 54" wide
- worksurface power & storage available, specify cutout code and order power units separately, see pages [NA14-NA15](#)

To Order, Specify:

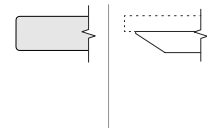
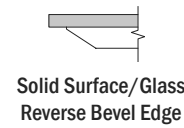
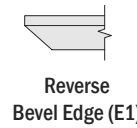
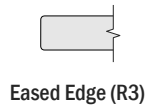
① Laminate Model #	② Top/Base Laminate	③ Top Edge	④ Metal Color	⑤ Electrical
Laminate (NAT)	See Top/Base Laminate Options	See Top Edge Options	Metal Color Options	Cutout Codes: N all tables C1M 132" - 240" wide C1C 132" - 240" wide C1O 132" - 240" wide C2M 132" - 240" wide C2C 132" - 240" wide C3M 132" - 240" wide C3C 132" - 240" wide C3MOM 132" - 240" wide

Description

Boat Shape 2pc Table with 3 Panel Bases
(continued)

Veneer Tops "NAV" Models

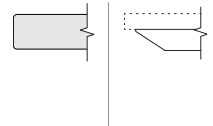
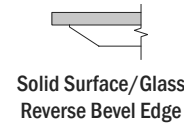
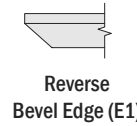
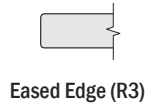
Premier Tops "NAV" Models



D	W	H	CTN WT	CU FT	① Model	Veneer Tops "NAV" Models		Veneer Tops "NAV" Models		Premier Tops "NAV" Models		Wood Plank Ash	Sub-Top with Base
						Flat Cut	Double Cut	Flat Cut	Double Cut	Solid Surface	Glass		
60	240	29 3/8	669	170	NAV60240-30BTPB	\$22,349	\$24,264	\$22,624	\$24,539	\$45,908	\$43,491	--	\$21,343
60	216	29 3/8	618	145	NAV60216-30BTPB	\$20,275	\$22,117	\$20,551	\$22,394	\$41,531	\$39,302	--	\$19,364
60	192	29 3/8	572	133	NAV60192-30BTPB	\$18,946	\$20,734	\$19,221	\$21,010	\$37,732	\$35,860	--	\$18,094

Description

Boat Shape 2pc Table with 2 Panel Bases
(continued)



D	W	H	CTN WT	CU FT	① Model	Veneer Tops "NAV" Models		Veneer Tops "NAV" Models		Premier Tops "NAV" Models		Wood Plank Ash	Custom Sub-Base
						Flat Cut	Double Cut	Flat Cut	Double Cut	Solid Surface	Glass		
54	168	29 3/8	429	98	NAV54168-30BTPB	\$12,988	\$14,342	\$13,263	\$14,616	\$27,887	\$26,308	--	\$12,402
54	144	29 3/8	379	98	NAV54144-30BTPB	\$11,786	\$13,041	\$12,062	\$13,316	\$24,623	\$23,204	--	\$11,256
54	132	29 3/8	352	83	NAV54132-30BTPB	\$11,312	\$12,525	\$11,588	\$12,802	\$23,079	\$21,779	--	\$10,805

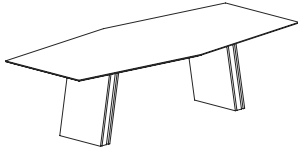
To Order, Specify:

① Veneer Model #	② Wood Species	③ Top Wood Finish	④ Base Finish	⑤ Top Edge	⑥ Metal Color	⑦ Electrical
Veneer (NAV)	Flat Cut B01 Black Oak CH1 Cherry MA1 Maple WA1 Walnut	See Top Wood Finish Options	See Base Finish Options	See Top Edge Options	See Metal Color Options	Cutout Codes: N all tables C1M 132" - 240"w C1C 132" - 240"w C1O 132" - 240"w C2M 132" - 240"w C2C 132" - 240"w C3M 132" - 240"w C3C 132" - 240"w C3MOM 132" - 240"w See chart on page NA15 for cutout codes and power and storage unit configurations
	Double Cut DC1 Double Cut	③ Top Wood Finish See Top Wood Finish Options				

① Specialty Top Model #	② Top Surface Selection	③ Base Wood Species	4a Base Wood Finish	4b Base Paint	⑤ Metal Color	⑥ Electrical
Solid Surface (NAV)	See Solid Surface Top Surface Selection	Flat Cut B01 Black Oak CH1 Cherry MA1 Maple WA1 Walnut	See Wood Base Finish Options	See Base Paint Options	See Metal Color Options	Cutout Codes: N all tables C1M 132" - 240"w C1C 132" - 240"w C1O 132" - 240"w C2M 132" - 240"w C2C 132" - 240"w C3M 132" - 240"w C3C 132" - 240"w C3MOM 132" - 240"w
Glass Surface (NAV)	See Glass Top Surface Selection					
Wood Plank (NAV)	See Wood Plank Top Surface Selection					
Sub-Top w/Base (NAV)	B (Table Ships with Sub-Top, Customer applies custom Top)	Double Cut DC1 Double Cut				

Description

Boat Shape Table with Panel Base



Laminate Tops "NAT" Models



Eased Edge (R3)



Reverse Bevel Edge (E1)

Features:

- two panel bases with structural support rails
- one-piece top
- narrow ends of table are 36"d
- glass top has additional seams

Options:

- metal base frame available in powder coat, no upcharge, or chrome, add \$2,197 list upcharge for 42" & 48" wide
- worksurface power & storage available, specify cutout code and order power units separately, see pages [NA14-NA15](#)

D	W	H	CTN WT	CU FT	① Model	HPL	HPL
48	120	29 ³ / ₈	295	70	NAT48120-30BTPB	\$6,991	\$7,415
48	108	29 ³ / ₈	279	69	NAT48108-30BTPB	\$6,289	\$6,715
48	96	29 ³ / ₈	236	59	NAT4896-30BTPB	\$6,337	\$6,763
48	84	29 ³ / ₈	236	55	NAT4884-30BTPB	\$6,080	\$6,505
42	72	29 ³ / ₈	171	60	NAT4272-30BTPB	\$5,484	\$5,912

NATIVE

To Order, Specify:

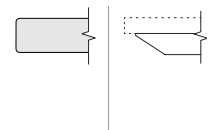
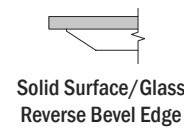
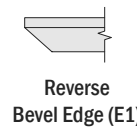
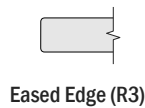
① Laminate Model #	② Top/Base Laminate	③ Top Edge	④ Metal Color	⑤ Electrical
Laminate (NAT)	See Top/Base Laminate Options	See Top Edge Options	Metal Color Options	Cutout Codes: N all tables C1M 72" - 120" wide C1C 72" - 120" wide C1O 120" wide C2M 96" - 120" wide C2C 96" - 120" wide C3C 120" wide C3M 120" wide C3MOM 120" wide

Description

Boat Shape Table with Panel Base
(continued)

Veneer Tops "NAV" Models

Premier Tops "NAV" Models



D	W	H	CTN WT	CU FT	① Model	Eased Edge (R3)		Reverse Bevel Edge (E1)		Solid Surface/ Glass Reverse Bevel Edge		Wood Plank Ash	Sub-Top with Base
						Flat Cut	Double Cut	Flat Cut	Double Cut	Solid Surface	Glass		
48	120	29 3/8	295	70	NAV48120-30BTPB	\$9,654	\$10,725	\$9,818	\$10,890	\$19,286	\$18,109	--	\$9,220
48	108	29 3/8	279	69	NAV48108-30BTPB	\$8,684	\$9,650	\$8,847	\$9,812	\$17,400	\$16,296	--	\$8,293
48	96	29 3/8	236	59	NAV4896-30BTPB	\$8,752	\$9,725	\$8,916	\$9,889	\$16,482	\$15,519	--	\$8,358
48	84	29 3/8	236	55	NAV4884-30BTPB	\$8,395	\$9,329	\$8,559	\$9,492	\$15,215	\$14,316	--	\$8,018
42	72	29 3/8	171	60	NAV4272-30BTPB	\$7,575	\$8,416	\$7,739	\$8,582	\$12,797	\$12,016	--	\$7,234

NATIVE

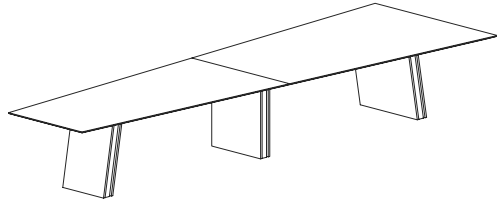
To Order, Specify:

① Veneer Model #	② Wood Species	③ Top Wood Finish	④ Base Finish	⑤ Top Edge	⑥ Metal Color	⑦ Electrical
Veneer (NAV)	Flat Cut B01 Black Oak CH1 Cherry MA1 Maple WA1 Walnut	See Top Wood Finish Options	See Base Finish Options	See Top Edge Options	See Metal Color Options	Cutout Codes: N all tables C1M 72" - 120" wide C1C 72" - 120" wide C1O 120" wide C2M 96" - 120" wide C2C 96" - 120" wide C3C 120" wide C3M 120" wide C3MOM 120" wide See chart on page NA15 for cutout codes and power and storage unit configurations
	Double Cut DC1 Double Cut	③ Top Wood Finish See Top Wood Finish Options				

① Specialty Top Model #	② Top Surface Selection	③ Base Wood Species	④a Base Wood Finish	④b Base Paint	⑤ Metal Color	⑥ Electrical
Solid Surface (NAV)	See Solid Surface Top Surface Selection	Flat Cut B01 Black Oak CH1 Cherry MA1 Maple WA1 Walnut	See Wood Base Finish Options	See Base Paint Options	See Metal Color Options	Cutout Codes: N all tables C1M 72" - 120" wide C1C 72" - 120" wide C1O 120" wide C2M 96" - 120" wide C2C 96" - 120" wide C3C 120" wide C3M 120" wide C3MOM 120" wide
Glass Surface (NAV)	See Glass Top Surface Selection					
Wood Plank (NAV)	See Wood Plank Top Surface Selection					
Sub-Top w/Base (NAV)	B (Table Ships with Sub-Top, Customer applies custom Top)	Double Cut DC1 Double Cut				

Description

View 2pc Table with 3 Panel Bases



Features:

- three panel bases with structural support rails
- two-piece top
- narrow end of table is 36"d
- glass top has additional seams

Options:

- metal base frame available in powder coat, no upcharge, or chrome, add \$3,267 list upcharge for 60" wide
- worksurface power & storage available, specify cutout code and order power units separately, see pages [NA14-NA15](#)

Laminate Tops "NAT" Models



Eased Edge (R3)



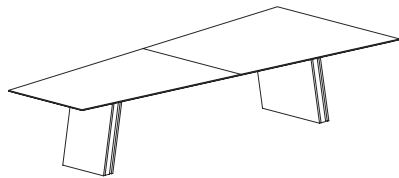
Reverse Bevel Edge (E1)

D	W	H	CTN WT	CU FT	① Model	HPL	HPL
60	240	29 3/8	614	173	NAT60240-30VTPB	\$17,614	\$18,152
60	216	29 3/8	568	94	NAT60216-30VTPB	\$15,834	\$16,371
60	192	29 3/8	518	133	NAT60192-30VTPB	\$14,944	\$15,482

NATIVE

Description

View 2pc Table with 2 Panel Bases



Features:

- two panel bases with structural support rails
- two-piece top
- narrow end of table is 36"d
- glass top has additional seams

Options:

- metal base frame available in powder coat, no upcharge, or chrome, add \$2,514 list upcharge for 60" wide
- worksurface power & storage available, specify cutout code and order power units separately, see pages [NA14-NA15](#)

Laminate Tops "NAT" Models



Eased Edge (R3)



Reverse Bevel Edge (E1)

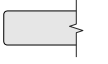
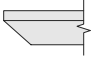

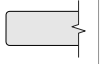

D	W	H	CTN WT	CU FT	① Model	HPL	HPL
60	168	29 3/8	430	109	NAT60168-30VTPB	\$11,045	\$11,582
60	144	29 3/8	380	97	NAT60144-30VTPB	\$9,779	\$10,316
60	132	29 3/8	352	91	NAT60132-30VTPB	\$8,330	\$8,868

To Order, Specify:

① Laminate Model #	② Top/Base Laminate	③ Top Edge	④ Metal Color	⑤ Electrical
Laminate (NAT)	See Top/Base Laminate Options	See Top Edge Options	Metal Color Options	Cutout Codes: N all tables C1M 132" - 240" wide C1C 132" - 240" wide C1O 132" - 240" wide C2M 132" - 240" wide C2C 132" - 240" wide C3M 132" - 240" wide C3C 132" - 240" wide C3MOM 132" - 240" wide


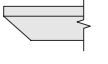



Description

View 2pc Table with 3 Panel Bases
(continued)

						Veneer Tops "NAV" Models				Premier Tops "NAV" Models			
						 Eased Edge (R3)		 Reverse Bevel Edge (E1)		 Solid Surface/Glass Reverse Bevel Edge		 	
D	W	H	CTN WT	CU FT	1 Model	Flat Cut	Double Cut	Flat Cut	Double Cut	Solid Surface	Glass	Wood Plank Ash	Sub-Top with Base
60	240	29 3/8	614	173	NAV60240-30VTPB	\$22,343	\$24,738	\$22,618	\$25,013	\$45,902	\$43,486	--	\$21,338
60	216	29 3/8	568	94	NAV60216-30VTPB	\$20,243	\$22,542	\$20,519	\$22,819	\$41,500	\$39,271	--	\$19,334
60	192	29 3/8	518	133	NAV60192-30VTPB	\$19,207	\$21,470	\$19,482	\$21,746	\$37,992	\$36,120	--	\$18,342

Description

View 2pc Table with 2 Panel Bases
(continued)

						Veneer Tops "NAV" Models				Premier Tops "NAV" Models			
						 Eased Edge (R3)		 Reverse Bevel Edge (E1)		 Solid Surface/Glass Reverse Bevel Edge		 	
D	W	H	CTN WT	CU FT	1 Model	Flat Cut	Double Cut	Flat Cut	Double Cut	Solid Surface	Glass	Wood Plank Ash	Custom Sub-Base
60	168	29 3/8	430	109	NAV60168-30VTPB	\$14,274	\$16,022	\$14,548	\$16,298	\$30,770	\$29,074	--	\$13,634
60	144	29 3/8	380	97	NAV60144-30VTPB	\$12,718	\$14,340	\$12,993	\$14,615	\$26,926	\$25,403	--	\$12,146
60	132	29 3/8	352	91	NAV60132-30VTPB	\$10,855	\$12,258	\$11,132	\$12,534	\$23,882	\$22,485	--	\$10,368

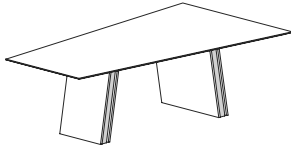
To Order, Specify:

1 Veneer Model #	2 Wood Species	3 Top Wood Finish	4 Base Finish	5 Top Edge	6 Metal Color	7 Electrical
Veneer (NAV)	Flat Cut B01 Black Oak CH1 Cherry MA1 Maple WA1 Walnut	See Top Wood Finish Options	See Base Finish Options	See Top Edge Options	See Metal Color Options	Cutout Codes: N all tables C1M 132" - 240"w C1C 132" - 240"w C1O 132" - 240"w C2M 132" - 240"w C2C 132" - 240"w C3M 132" - 240"w C3C 132" - 240"w C3MOM 132" - 240"w See chart on page NA15 for cutout codes and power and storage unit configurations
	Double Cut DC1 Double Cut	3 Top Wood Finish See Top Wood Finish Options				

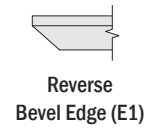
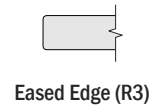
1 Specialty Top Model #	2 Top Surface Selection	3 Base Wood Species	4a Base Wood Finish	4b Base Paint	5 Metal Color	6 Electrical
Solid Surface (NAV)	See Solid Surface Top Surface Selection	Flat Cut B01 Black Oak CH1 Cherry MA1 Maple WA1 Walnut	See Wood Base Finish Options	See Base Paint Options	See Metal Color Options	Cutout Codes: N all tables C1M 132" - 240"w C1C 132" - 240"w C1O 132" - 240"w C2M 132" - 240"w C2C 132" - 240"w C3M 132" - 240"w C3C 132" - 240"w C3MOM 132" - 240"w
Glass Surface (NAV)	See Glass Top Surface Selection					
Wood Plank (NAV)	See Wood Plank Top Surface Selection					
Sub-Top w/Base (NAV)	B (Table Ships with Sub-Top, Customer applies custom Top)	Double Cut DC1 Double Cut				

Description

View Table with Panel Base



Laminate Tops "NAT" Models



Features:

- two panel bases with structural support rails
- one-piece top
- narrow end of table is 36"d
- glass top has additional seams

Options:

- metal base frame available in powder coat, no upcharge, or chrome, add list upcharge: for 48" wide - \$2,197, for 54" & 60" wide - \$2,514
- worksurface power & storage available, specify cutout code and order power units separately, see pages [NA14-NA15](#)

D	W	H	CTN WT	CU FT	① Model	HPL	HPL
60	120	29 ³ / ₈	330	94	NAT60120-30VTPB	\$7,943	\$8,371
60	108	29 ³ / ₈	311	76	NAT60108-30VTPB	\$7,506	\$7,932
54	96	29 ³ / ₈	278	69	NAT5496-30VTPB	\$6,614	\$7,039
54	84	29 ³ / ₈	256	62	NAT5484-30VTPB	\$7,087	\$7,514
48	72	29 ³ / ₈	177	52	NAT4872-30VTPB	\$5,733	\$6,161

NATIVE

To Order, Specify:

① Laminate Model #	② Top/Base Laminate	③ Top Edge	④ Metal Color	⑤ Electrical
Laminate (NAT)	See Top/Base Laminate Options	See Top Edge Options	Metal Color Options	Cutout Codes: N all tables C1M 72" - 120" wide C1C 72" - 120" wide C1O 120" wide C2M 96" - 120" wide C2C 96" - 120" wide C3M 120" wide C3C 120" wide C3MOM 120" wide

Description

View Table with Panel Base
(continued)

						Veneer Tops "NAV" Models				Premier Tops "NAV" Models			
						Eased Edge (R3)		Reverse Bevel Edge (E1)		Solid Surface/Glass Reverse Bevel Edge		Wood Plank Ash	
D	W	H	CTN WT	CU FT	1 Model	Flat Cut	Double Cut	Flat Cut	Double Cut	Solid Surface	Glass	Wood Plank Ash	Sub-Top with Base
60	120	29 3/8	330	94	NAV60120-30VTPB	\$10,864	\$12,288	\$11,027	\$12,454	\$22,782	\$21,434	--	\$10,376
60	108	29 3/8	311	76	NAV60108-30VTPB	\$10,285	\$11,655	\$10,450	\$11,820	\$21,016	\$19,800	--	\$9,826
54	96	29 3/8	278	69	NAV5496-30VTPB	\$9,086	\$10,067	\$9,252	\$10,233	\$17,730	\$16,700	--	\$8,679
54	84	29 3/8	256	62	NAV5484-30VTPB	\$9,737	\$10,787	\$9,901	\$10,952	\$17,409	\$16,397	--	\$9,298
48	72	29 3/8	177	52	NAV4872-30VTPB	\$7,917	\$8,797	\$8,082	\$8,961	\$13,823	\$12,992	--	\$7,562

NATIVE

To Order, Specify:

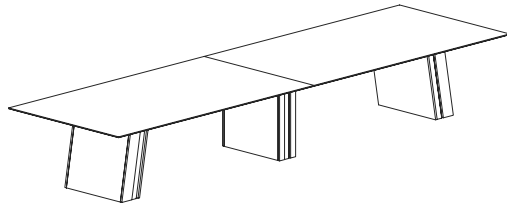
1 Veneer Model #	2 Wood Species	3 Top Wood Finish	4 Base Finish	5 Top Edge	6 Metal Color	7 Electrical
Veneer (NAV)	Flat Cut B01 Black Oak CH1 Cherry MA1 Maple WA1 Walnut	See Top Wood Finish Options	See Base Finish Options	See Top Edge Options	See Metal Color Options	Cutout Codes: N all tables C1M 72" - 120" wide C1C 72" - 120" wide C1O 120" wide C2M 96" - 120" wide C2C 96" - 120" wide C3C 120" wide C3M 120" wide C3MOM 120" wide See chart on page NA15 for cutout codes and power and storage unit configurations
	Double Cut DC1 Double Cut	3 Top Wood Finish See Top Wood Finish Options				

1 Specialty Top Model #	2 Top Surface Selection	3 Base Wood Species	4a Base Wood Finish	4b Base Paint	5 Metal Color	6 Electrical
Solid Surface (NAV)	See Solid Surface Top Surface Selection	Flat Cut B01 Black Oak CH1 Cherry MA1 Maple WA1 Walnut	See Wood Base Finish Options	See Base Paint Options	See Metal Color Options	Cutout Codes: N all tables C1M 72" - 120" wide C1C 72" - 120" wide C1O 120" wide C2M 96" - 120" wide C2C 96" - 120" wide C3C 120" wide C3M 120" wide C3MOM 120" wide
Glass Surface (NAV)	See Glass Top Surface Selection					
Wood Plank (NAV)	See Wood Plank Top Surface Selection					
Sub-Top w/Base (NAV)	B (Table Ships with Sub-Top, Customer applies custom Top)	Double Cut DC1 Double Cut				

Description

Rectangular 2pc Table with 3 Box Bases

Laminate Tops "NAT" Models



Eased Edge (R3)



Reverse Bevel Edge (E1)

Features:

- three box bases with structural support rails
- two-piece top
- glass top has additional seams

Options:

- metal frame available in powder coat, no upcharge, or chrome, add list upcharge: for 48" wide - \$2,855, for 54" & 60" wide - \$3,267
- worksurface power & storage available, specify cutout code and order power units separately, see pages [NA14-NA15](#)

D	W	H	CTN WT	CU FT	① Model	HPL	HPL
60	240	29 ³ / ₈	750	176	NAT60240-30TTBB	\$17,634	\$18,171
60	216	29 ³ / ₈	704	150	NAT60216-30TTBB	\$15,862	\$16,400
60	192	29 ³ / ₈	644	133	NAT60192-30TTBB	\$14,758	\$15,297
54	240	29 ³ / ₈	701	149	NAT54240-30TTBB	\$16,734	\$17,272
54	216	29 ³ / ₈	660	141	NAT54216-30TTBB	\$15,115	\$15,652
54	192	29 ³ / ₈	605	159	NAT54192-30TTBB	\$14,263	\$14,801
48	192	29 ³ / ₈	547	118	NAT48192-30TTBB	\$12,502	\$13,040

NATIVE

To Order, Specify:

① Laminate Model #	② Top/Base Laminate	③ Top Edge	④ Metal Color	⑤ Electrical
Laminate (NAT)	See Top/Base Laminate Options	See Top Edge Options	Metal Color Options	Cutout Codes: N all tables C1M 192" - 240" wide C1C 192" - 240" wide C1O 192" - 240" wide C2M 192" - 240" wide C2C 192" - 240" wide C3M 120" - 240" wide C3C 120" - 240" wide C3MOM 120" - 240" wide

Description

Rectangular 2pc Table with 3 Box Bases
(continued)

						Veneer Tops "NAV" Models				Premier Tops "NAV" Models			
						Eased Edge (R3)		Reverse Bevel Edge (E1)		Solid Surface/Glass Reverse Bevel Edge		Wood Plank Ash	
D	W	H	CTN WT	CU FT	1 Model	Flat Cut	Double Cut	Flat Cut	Double Cut	Solid Surface	Glass	Wood Plank Ash	Sub-Top with Base
60	240	29 3/8	750	176	NAV60240-30TTBB	\$22,884	\$25,335	\$23,158	\$25,610	\$46,442	\$44,026	--	\$21,855
60	216	29 3/8	704	150	NAV60216-30TTBB	\$20,746	\$23,106	\$21,022	\$23,381	\$42,003	\$39,774	--	\$19,813
60	192	29 3/8	644	133	NAV60192-30TTBB	\$19,403	\$21,693	\$19,678	\$21,966	\$38,189	\$36,316	--	\$18,529
54	240	29 3/8	701	149	NAV54240-30TTBB	\$21,799	\$23,721	\$22,074	\$23,998	\$43,061	\$40,825	--	\$20,818
54	216	29 3/8	660	141	NAV54216-30TTBB	\$19,853	\$21,714	\$20,128	\$21,991	\$39,042	\$36,978	--	\$18,960
54	192	29 3/8	605	159	NAV54192-30TTBB	\$18,805	\$20,614	\$19,082	\$20,889	\$35,764	\$34,029	--	\$17,958
48	192	29 3/8	547	118	NAV48192-30TTBB	\$16,745	\$18,526	\$17,020	\$18,802	\$31,876	\$30,275	--	\$15,994

NATIVE

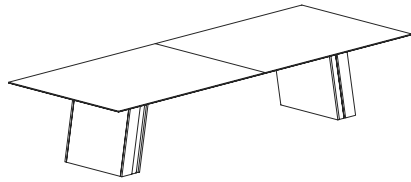
To Order, Specify:

1 Veneer Model #	2 Wood Species	3 Top Wood Finish	4 Base Finish	5 Top Edge	6 Metal Color	7 Electrical
Veneer (NAV)	Flat Cut B01 Black Oak CH1 Cherry MA1 Maple WA1 Walnut	See Top Wood Finish Options	See Base Finish Options	See Top Edge Options	See Metal Color Options	Cutout Codes: N all tables C1M 192" - 240"w C1C 192" - 240"w C1O 192" - 240"w C2M 192" - 240"w C2C 192" - 240"w C3M 120" - 240"w C3C 120" - 240"w C3MOM 120" - 240"w See chart on page NA15 for cutout codes and power and storage unit configurations
	Double Cut DC1 Double Cut	3 Top Wood Finish See Top Wood Finish Options				

1 Specialty Top Model #	2 Top Surface Selection	3 Base Wood Species	4a Base Wood Finish	4b Base Paint	5 Metal Color	6 Electrical
Solid Surface (NAV)	See Solid Surface Top Surface Selection	Flat Cut B01 Black Oak CH1 Cherry MA1 Maple WA1 Walnut	See Wood Base Finish Options	See Base Paint Options	See Metal Color Options	Cutout Codes: N all tables C1M 192" - 240"w C1C 192" - 240"w C1O 192" - 240"w C2M 192" - 240"w C2C 192" - 240"w C3M 120" - 240"w C3C 120" - 240"w C3MOM 120" - 240"w
Glass Surface (NAV)	See Glass Top Surface Selection					
Wood Plank (NAV)	See Wood Plank Top Surface Selection					
Sub-Top w/Base (NAV)	B (Table Ships with Sub-Top, Customer applies custom Top)	Double Cut DC1 Double Cut				

Description

Rectangular 2pc Table with 2 Box Bases



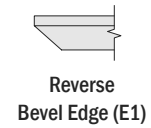
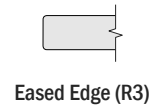
Features:

- two box bases with structural support rails
- two-piece top
- glass top has additional seams

Options:

- metal base frame available in powder coat, no upcharge, or chrome, add list upcharge: for 48" wide - \$2,197, for 54" & 60" wide - \$2,514
- worksurface power & storage available, specify cutout code and order power units separately, see pages [NA14-NA15](#)

Laminate Tops "NAT" Models



D	W	H	CTN WT	CU FT	① Model	HPL	HPL
60	168	29 ³ / ₈	522	108	NAT60168-30TTBB	\$11,051	\$11,588
60	144	29 ³ / ₈	469	97	NAT60144-30TTBB	\$8,954	\$9,491
54	168	29 ³ / ₈	495	96	NAT54168-30TTBB	\$10,164	\$10,703
54	144	29 ³ / ₈	440	94	NAT54144-30TTBB	\$9,223	\$9,762
54	132	29 ³ / ₈	410	91	NAT54132-30TTBB	\$8,854	\$9,392
48	168	29 ³ / ₈	448	90	NAT48168-30TTBB	\$9,592	\$10,130
48	144	29 ³ / ₈	398	84	NAT48144-30TTBB	\$8,631	\$9,168
48	132	29 ³ / ₈	371	78	NAT48132-30TTBB	\$8,410	\$8,947

NATIVE

To Order, Specify:

① Laminate Model #	② Top/Base Laminate	③ Top Edge	④ Metal Color	⑤ Electrical
Laminate (NAT)	See Top/Base Laminate Options	See Top Edge Options	Metal Color Options	Cutout Codes: N all tables C1M 132" - 168" wide C1C 132" - 168" wide C1O 132" - 168" wide C2M 132" - 168" wide C2C 132" - 168" wide C3M 132" - 168" wide C3C 132" - 168" wide C3MOM 132" - 168" wide

Description

Rectangular 2pc Table with 2 Box Bases
(continued)

						Veneer Tops "NAV" Models				Premier Tops "NAV" Models			
						Eased Edge (R3)		Reverse Bevel Edge (E1)		Solid Surface/Glass Reverse Bevel Edge		Wood Plank Ash	
D	W	H	CTN WT	CU FT	① Model	Flat Cut	Double Cut	Flat Cut	Double Cut	Solid Surface	Glass	Wood Plank Ash	Sub-Top with Base
60	168	29 3/8	522	108	NAV60168-30TTBB	\$14,610	\$16,402	\$14,887	\$16,677	\$31,106	\$29,411	--	\$13,955
60	144	29 3/8	469	97	NAV60144-30TTBB	\$11,911	\$13,430	\$12,186	\$13,707	\$26,119	\$24,596	--	\$11,376
54	168	29 3/8	495	96	NAV54168-30TTBB	\$13,565	\$14,979	\$13,841	\$15,255	\$28,467	\$26,885	--	\$12,956
54	144	29 3/8	440	94	NAV54144-30TTBB	\$12,352	\$13,666	\$12,628	\$13,940	\$25,188	\$23,767	--	\$11,797
54	132	29 3/8	410	91	NAV54132-30TTBB	\$11,871	\$13,143	\$12,147	\$13,419	\$23,638	\$22,338	--	\$11,338
48	168	29 3/8	448	90	NAV48168-30TTBB	\$12,878	\$14,267	\$13,152	\$14,543	\$26,178	\$24,718	--	\$12,298
48	144	29 3/8	398	84	NAV48144-30TTBB	\$11,644	\$12,938	\$11,921	\$13,214	\$23,112	\$21,793	--	\$11,121
48	132	29 3/8	371	78	NAV48132-30TTBB	\$11,345	\$12,606	\$11,622	\$12,881	\$21,858	\$20,648	--	\$10,836

NATIVE

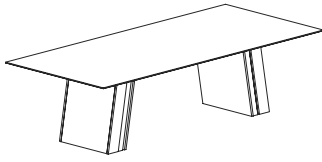
To Order, Specify:

① Veneer Model #	② Wood Species	③ Top Wood Finish	④ Base Finish	⑤ Top Edge	⑥ Metal Color	⑦ Electrical
Veneer (NAV)	Flat Cut B01 Black Oak CH1 Cherry MA1 Maple WA1 Walnut	See Top Wood Finish Options	See Base Finish Options	See Top Edge Options	See Metal Color Options	Cutout Codes: N all tables C1M 132" - 168"w C1C 132" - 168"w C1O 132" - 168"w C2M 132" - 168"w C2C 132" - 168"w C3M 132" - 168"w C3C 132" - 168"w C3MOM 132" - 168"w See chart on page NA15 for cutout codes and power and storage unit configurations
	Double Cut DC1 Double Cut	③ Top Wood Finish See Top Wood Finish Options				

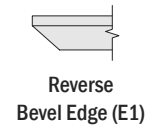
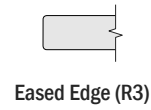
① Specialty Top Model #	② Top Surface Selection	③ Base Wood Species	④a Base Wood Finish	④b Base Paint	⑤ Metal Color	⑥ Electrical
Solid Surface (NAV)	See Solid Surface Top Surface Selection	Flat Cut B01 Black Oak CH1 Cherry MA1 Maple WA1 Walnut	See Wood Base Finish Options	See Base Paint Options	See Metal Color Options	Cutout Codes: N all tables C1M 132" - 168"w C1C 132" - 168"w C1O 132" - 168"w C2M 132" - 168"w C2C 132" - 168"w C3M 132" - 168"w C3C 132" - 168"w C3MOM 132" - 168"w
Glass Surface (NAV)	See Glass Top Surface Selection					
Wood Plank (NAV)	See Wood Plank Top Surface Selection					
Sub-Top w/Base (NAV)	B (Table Ships with Sub-Top, Customer applies custom Top)	Double Cut DC1 Double Cut				

Description

Rectangular Table with Box Base



Laminate Tops "NAT" Models



Features:

- two box bases with structural support rails
- one-piece top
- glass top has additional seams

Options:

- metal base frame available in powder coat, no upcharge, or chrome, add list upcharge: for 42" & 48" wide - \$2,197, for 54" wide - \$2,514
- worksurface power & storage available, specify cutout code and order power units separately, see pages [NA14-NA15](#)

D	W	H	CTN WT	CU FT	① Model	HPL	HPL
54	120	29 $\frac{3}{8}$	385	82	NAT54120-30TTBB	\$7,584	\$8,012
48	120	29 $\frac{3}{8}$	349	72	NAT48120-30TTBB	\$7,220	\$7,645
48	108	29 $\frac{3}{8}$	330	66	NAT48108-30TTBB	\$6,673	\$7,099
48	96	29 $\frac{3}{8}$	307	66	NAT4896-30TTBB	\$6,462	\$6,888
42	120	29 $\frac{3}{8}$	324	68	NAT42120-30TTBB	\$7,130	\$7,557
42	108	29 $\frac{3}{8}$	308	63	NAT42108-30TTBB	\$6,508	\$6,935
42	96	29 $\frac{3}{8}$	287	63	NAT4296-30TTBB	\$6,391	\$6,819

To Order, Specify:

① Laminate Model #	② Top/Base Laminate	③ Top Edge	④ Metal Color	⑤ Electrical
Laminate (NAT)	See Top/Base Laminate Options	See Top Edge Options	Metal Color Options	Cutout Codes: N all tables C1M 96" - 120" wide C1C 96" - 120" wide C1O 120" wide C2M 96" - 120" wide C2C 96" - 120" wide C3M 120" wide C3C 120" wide C3MOM 120" wide

Description

Rectangular Table with Box Base
(continued)

						Veneer Tops "NAV" Models				Premier Tops "NAV" Models			
						Eased Edge (R3)		Reverse Bevel Edge (E1)		Solid Surface/Glass Reverse Bevel Edge		Wood Plank Ash	
D	W	H	CTN WT	CU FT	1 Model	Flat Cut	Double Cut	Flat Cut	Double Cut	Solid Surface	Glass	Wood Plank Ash	Sub-Top with Base
54	120	29 3/8	385	82	NAV54120-30TTBB	\$10,673	\$11,825	\$10,838	\$11,990	\$21,451	\$20,188	--	\$10,195
48	120	29 3/8	349	72	NAV48120-30TTBB	\$10,208	\$11,343	\$10,372	\$11,506	\$19,842	\$18,665	\$16,217	\$9,749
48	108	29 3/8	330	66	NAV48108-30TTBB	\$9,438	\$10,485	\$9,601	\$10,649	\$18,155	\$17,049	\$14,846	\$9,014
48	96	29 3/8	307	66	NAV4896-30TTBB	\$9,136	\$10,153	\$9,301	\$10,316	\$16,869	\$15,904	\$13,945	\$8,726
42	120	29 3/8	324	68	NAV42120-30TTBB	\$10,083	\$11,204	\$10,247	\$11,369	\$18,514	\$17,483	\$15,340	\$9,630
42	108	29 3/8	308	63	NAV42108-30TTBB	\$9,203	\$10,227	\$9,368	\$10,390	\$16,832	\$15,863	\$13,936	\$8,791
42	96	29 3/8	287	63	NAV4296-30TTBB	\$9,037	\$10,041	\$9,202	\$10,206	\$15,858	\$14,957	\$13,243	\$8,631

NATIVE

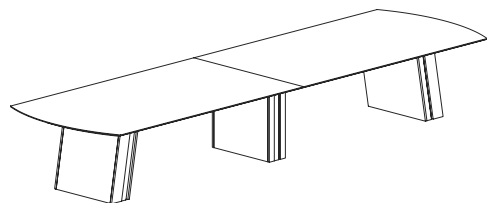
To Order, Specify:

1 Veneer Model #	2 Wood Species	3 Top Wood Finish	4 Base Finish	5 Top Edge	6 Metal Color	7 Electrical
Veneer (NAV)	Flat Cut B01 Black Oak CH1 Cherry MA1 Maple WA1 Walnut	See Top Wood Finish Options	See Base Finish Options	See Top Edge Options	See Metal Color Options	Cutout Codes: N all tables C1M 96" - 120" wide C1C 96" - 120" wide C1O 120" wide C2M 96" - 120" wide C2C 96" - 120" wide C3M 120" wide C3C 120" wide C3MOM 120" wide See chart on page NA15 for cutout codes and power and storage unit configurations
	Double Cut DC1 Double Cut	Top Wood Finish See Top Wood Finish Options				

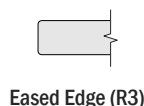
1 Specialty Top Model #	2 Top Surface Selection	3 Base Wood Species	4a Base Wood Finish	4b Base Paint	5 Metal Color	6 Electrical
Solid Surface (NAV)	See Solid Surface Top Surface Selection	Flat Cut B01 Black Oak CH1 Cherry MA1 Maple WA1 Walnut	See Wood Base Finish Options	See Base Paint Options	See Metal Color Options	Cutout Codes: N all tables C1M 96" - 120"w C1C 96" - 120"w C1O 120"w C2M 96" - 120"w C2C 96" - 120"w C3M 120"w C3C 120"w C3MOM 120"w
Glass Surface (NAV)	See Glass Top Surface Selection					
Wood Plank (NAV)	See Wood Plank Top Surface Selection					
Sub-Top w/Base (NAV)	B (Table Ships with Sub-Top, Customer applies custom Top)	Double Cut DC1 Double Cut				

Description

Arc End 2pc Table with 3 Box Bases



Laminate Tops "NAT" Models



Eased Edge (R3)



Reverse Bevel Edge (E1)

Features:

- three box bases with structural support rails
- two-piece top
- glass top has additional seams

Options:

- metal frame available in powder coat, no upcharge, or chrome, add list upcharge: for 48" wide - \$2,855, for 54" & 60" wide - \$3,267
- worksurface power & storage available, specify cutout code and order power units separately, see pages [NA14-NA15](#)

D	W	H	CTN WT	CU FT	① Model	HPL	HPL
60	240	29 ³ / ₈	742	176	NAT60240-30ARBB	\$17,634	\$18,171
60	216	29 ³ / ₈	696	150	NAT60216-30ARBB	\$15,862	\$16,400
60	192	29 ³ / ₈	636	133	NAT60192-30ARBB	\$14,758	\$15,297
54	240	29 ³ / ₈	653	150	NAT54240-30ARBB	\$16,734	\$17,272
54	216	29 ³ / ₈	654	141	NAT54216-30ARBB	\$15,115	\$15,652
54	192	29 ³ / ₈	598	134	NAT54192-30ARBB	\$14,263	\$14,801
48	192	29 ³ / ₈	341	116	NAT48192-30ARBB	\$12,502	\$13,040

NATIVE

To Order, Specify:

① Laminate Model #	② Top/Base Laminate	③ Top Edge	④ Metal Color	⑤ Electrical
Laminate (NAT)	See Top/Base Laminate Options	See Top Edge Options	Metal Color Options	Cutout Codes: N all tables C1M 192" - 240" wide C1C 192" - 240" wide C1O 192" - 240" wide C2M 192" - 240" wide C2C 192" - 240" wide C3M 192" - 240" wide C3C 192" - 240" wide C3MOM 192" - 240" wide

Description

Arc End 2pc Table with 3 Box Bases
(continued)

						Veneer Tops "NAV" Models				Premier Tops "NAV" Models			
						Eased Edge (R3)		Reverse Bevel Edge (E1)		Solid Surface/Glass Reverse Bevel Edge		Wood Plank Ash	
D	W	H	CTN WT	CU FT	① Model	Flat Cut	Double Cut	Flat Cut	Double Cut	Solid Surface	Glass	Wood Plank Ash	Sub-Top with Base
60	240	29 3/8	742	176	NAV60240-30ARBB	\$22,884	\$25,335	\$23,158	\$25,610	\$46,442	\$44,026	--	\$21,855
60	216	29 3/8	696	150	NAV60216-30ARBB	\$20,746	\$23,106	\$21,022	\$23,381	\$42,003	\$39,774	--	\$19,813
60	192	29 3/8	636	133	NAV60192-30ARBB	\$19,403	\$21,693	\$19,678	\$21,966	\$38,189	\$36,316	--	\$18,529
54	240	29 3/8	653	150	NAV54240-30ARBB	\$21,799	\$23,721	\$22,074	\$23,998	\$43,061	\$40,825	--	\$20,818
54	216	29 3/8	654	141	NAV54216-30ARBB	\$19,853	\$21,714	\$20,128	\$21,991	\$39,042	\$36,978	--	\$18,960
54	192	29 3/8	598	134	NAV54192-30ARBB	\$18,805	\$20,614	\$19,082	\$20,889	\$35,764	\$34,029	--	\$17,958
48	192	29 3/8	341	116	NAV48192-30ARBB	\$16,745	\$18,526	\$17,020	\$18,802	\$31,876	\$30,275	--	\$15,994

NATIVE

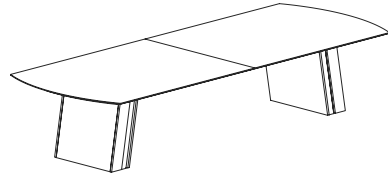
To Order, Specify:

① Veneer Model #	② Wood Species	③ Top Wood Finish	④ Base Finish	⑤ Top Edge	⑥ Metal Color	⑦ Electrical
Veneer (NAV)	Flat Cut B01 Black Oak CH1 Cherry MA1 Maple WA1 Walnut	See Top Wood Finish Options	See Base Finish Options	See Top Edge Options	See Metal Color Options	Cutout Codes: N all tables C1M 192" - 240"w C1C 192" - 240"w C1O 192" - 240"w C2M 192" - 240"w C2C 192" - 240"w C3M 192" - 240"w C3C 192" - 240"w C3MOM 192" - 240"w See chart on page NA15 for cutout codes and power and storage unit configurations
	Double Cut DC1 Double Cut	③ Top Wood Finish See Top Wood Finish Options				

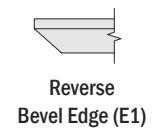
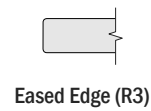
① Specialty Top Model #	② Top Surface Selection	③ Base Wood Species	④a Base Wood Finish	④b Base Paint	⑤ Metal Color	⑥ Electrical
Solid Surface (NAV)	See Solid Surface Top Surface Selection	Flat Cut B01 Black Oak CH1 Cherry MA1 Maple WA1 Walnut	See Wood Base Finish Options	See Base Paint Options	See Metal Color Options	Cutout Codes: N all tables C1M 192" - 240"w C1C 192" - 240"w C1O 192" - 240"w C2M 192" - 240"w C2C 192" - 240"w C3M 192" - 240"w C3C 192" - 240"w C3MOM 192" - 240"w
Glass Surface (NAV)	See Glass Top Surface Selection					
Wood Plank (NAV)	See Wood Plank Top Surface Selection					
Sub-Top w/Base (NAV)	B (Table Ships with Sub-Top, Customer applies custom Top)	Double Cut DC1 Double Cut				

Description

Arc End 2pc Table with 2 Box Bases



Laminate Tops "NAT" Models



Features:

- two box bases with structural support rails
- two-piece top
- glass top has additional seams

Options:

- metal base frame available in powder coat, no upcharge, or chrome, add list upcharge: for 48" wide - \$2,197, for 54" & 60" wide - \$2,514
- worksurface power & storage available, specify cutout code and order power units separately, see pages [NA14-NA15](#)

D	W	H	CTN WT	CU FT	① Model	HPL	HPL
60	168	29 ³ / ₈	529	108	NAT60168-30ARBB	\$11,051	\$11,588
60	144	29 ³ / ₈	462	97	NAT60144-30ARBB	\$8,954	\$9,491
54	168	29 ³ / ₈	489	104	NAT54168-30ARBB	\$10,164	\$10,703
54	144	29 ³ / ₈	434	92	NAT54144-30ARBB	\$9,223	\$9,762
54	132	29 ³ / ₈	303	86	NAT54132-30ARBB	\$8,051	\$8,588
48	168	29 ³ / ₈	341	90	NAT48168-30ARBB	\$9,592	\$10,130
48	144	29 ³ / ₈	365	84	NAT48144-30ARBB	\$8,685	\$9,222
48	132	29 ³ / ₈	365	78	NAT48132-30ARBB	\$8,357	\$8,894

To Order, Specify:

① Laminate Model #	② Top/Base Laminate	③ Top Edge	④ Metal Color	⑤ Electrical
Laminate (NAT)	See Top/Base Laminate Options	See Top Edge Options	Metal Color Options	Cutout Codes: N all tables C1M 132" - 168" wide C1C 132" - 168" wide C1O 132" - 168" wide C2M 132" - 168" wide C2C 132" - 168" wide C3M 132" - 168" wide C3C 132" - 168" wide C3MOM 132" - 168" wide

Description

Arc End 2pc Table with 2 Box Bases
(continued)

						Veneer Tops "NAV" Models				Premier Tops "NAV" Models			
						Eased Edge (R3)		Reverse Bevel Edge (E1)		Solid Surface/Glass Reverse Bevel Edge			
D	W	H	CTN WT	CU FT	① Model	Flat Cut	Double Cut	Flat Cut	Double Cut	Solid Surface	Glass	Wood Plank Ash	Sub-Top with Base
60	168	29 3/8	529	108	NAV60168-30ARBB	\$14,610	\$16,402	\$14,887	\$16,677	\$31,106	\$29,411	--	\$13,955
60	144	29 3/8	462	97	NAV60144-30ARBB	\$11,911	\$13,430	\$12,186	\$13,707	\$26,119	\$24,596	--	\$11,376
54	168	29 3/8	489	104	NAV54168-30ARBB	\$13,565	\$14,979	\$13,841	\$15,255	\$28,467	\$26,885	--	\$12,956
54	144	29 3/8	434	92	NAV54144-30ARBB	\$12,352	\$13,666	\$12,628	\$13,940	\$25,188	\$23,767	--	\$11,797
54	132	29 3/8	303	86	NAV54132-30ARBB	\$10,796	\$11,952	\$11,070	\$12,228	\$22,563	\$21,262	--	\$10,309
48	168	29 3/8	341	90	NAV48168-30ARBB	\$12,878	\$14,267	\$13,152	\$14,543	\$26,178	\$24,718	--	\$12,298
48	144	29 3/8	365	84	NAV48144-30ARBB	\$11,715	\$13,018	\$11,991	\$13,294	\$23,183	\$21,865	--	\$11,190
48	132	29 3/8	365	78	NAV48132-30ARBB	\$11,277	\$12,529	\$11,551	\$12,805	\$21,789	\$20,579	--	\$10,769

NATIVE

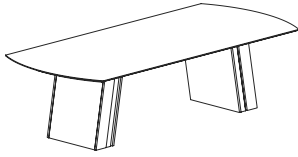
To Order, Specify:

① Veneer Model #	② Wood Species	③ Top Wood Finish	④ Base Finish	⑤ Top Edge	⑥ Metal Color	⑦ Electrical
Veneer (NAV)	Flat Cut B01 Black Oak CH1 Cherry MA1 Maple WA1 Walnut	See Top Wood Finish Options	See Base Finish Options	See Top Edge Options	See Metal Color Options	Cutout Codes: N all tables C1M 132" - 168"w C1C 132" - 168"w C1O 132" - 168"w C2M 132" - 168"w C2C 132" - 168"w C3M 132" - 168"w C3C 132" - 168"w C3MOM 132" - 168"w See chart on page NA15 for cutout codes and power and storage unit configurations
	Double Cut DC1 Double Cut	③ Top Wood Finish See Top Wood Finish Options				

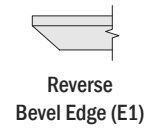
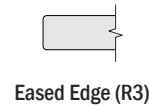
① Specialty Top Model #	② Top Surface Selection	③ Base Wood Species	4a Base Wood Finish	4b Base Paint	⑤ Metal Color	⑥ Electrical
Solid Surface (NAV)	See Solid Surface Top Surface Selection	Flat Cut B01 Black Oak CH1 Cherry MA1 Maple WA1 Walnut	See Wood Base Finish Options	See Base Paint Options	See Metal Color Options	Cutout Codes: N all tables C1M 132" - 168"w C1C 132" - 168"w C1O 132" - 168"w C2M 132" - 168"w C2C 132" - 168"w C3M 132" - 168"w C3C 132" - 168"w C3MOM 132" - 168"w
Glass Surface (NAV)	See Glass Top Surface Selection					
Wood Plank (NAV)	See Wood Plank Top Surface Selection					
Sub-Top w/Base (NAV)	B (Table Ships with Sub-Top, Customer applies custom Top)	Double Cut DC1 Double Cut				

Description

Arc End Table with Box Base



Laminate Tops "NAT" Models



Features:

- two box bases with structural support rails
- one-piece top
- glass top has additional seams

Options:

- metal base frame available in powder coat, no upcharge, or chrome, add list upcharge: for 42" & 48" wide - \$2,197, for 54" wide - \$2,514
- worksurface power & storage available, specify cutout code and order power units separately, see pages [NA14-NA15](#)

D	W	H	CTN WT	CU FT	① Model	HPL	HPL
54	120	29 ³ / ₈	379	80	NAT54120-30ARBB	\$7,584	\$8,012
48	120	29 ³ / ₈	343	74	NAT48120-30ARBB	\$7,220	\$7,645
48	108	29 ³ / ₈	325	68	NAT48108-30ARBB	\$6,673	\$7,099
48	96	29 ³ / ₈	301	63	NAT4896-30ARBB	\$6,462	\$6,888
42	120	29 ³ / ₈	319	70	NAT42120-30ARBB	\$7,130	\$7,557
42	108	29 ³ / ₈	304	66	NAT42108-30ARBB	\$6,508	\$6,935
42	96	29 ³ / ₈	282	63	NAT4296-30ARBB	\$6,470	\$6,897

NATIVE

To Order, Specify:

① Laminate Model #	② Top/Base Laminate	③ Top Edge	④ Metal Color	⑤ Electrical
Laminate (NAT)	See Top/Base Laminate Options	See Top Edge Options	Metal Color Options	Cutout Codes: N all tables C1M 96" - 120" wide C1C 96" - 120" wide C1O 120" wide C2M 96" - 120" wide C2C 96" - 120" wide C3M 120" wide C3C 120" wide C3MOM 120" wide

Description

Arc End Table with Box Base
(continued)

						Veneer Tops "NAV" Models				Premier Tops "NAV" Models			
						Eased Edge (R3)		Reverse Bevel Edge (E1)		Solid Surface/Glass Reverse Bevel Edge		Wood Plank Ash	
D	W	H	CTN WT	CU FT	1 Model	Flat Cut	Double Cut	Flat Cut	Double Cut	Solid Surface	Glass	Wood Plank Ash	Sub-Top with Base
54	120	29 3/8	379	80	NAV54120-30ARBB	\$10,673	\$11,825	\$10,838	\$11,990	\$21,451	\$20,188	--	\$10,195
48	120	29 3/8	343	74	NAV48120-30ARBB	\$10,208	\$11,343	\$10,372	\$11,506	\$19,842	\$18,665	--	\$9,749
48	108	29 3/8	325	68	NAV48108-30ARBB	\$9,438	\$10,485	\$9,601	\$10,649	\$18,155	\$17,049	--	\$9,014
48	96	29 3/8	301	63	NAV4896-30ARBB	\$9,136	\$10,153	\$9,301	\$10,316	\$16,869	\$15,904	--	\$8,726
42	120	29 3/8	319	70	NAV42120-30ARBB	\$10,083	\$11,204	\$10,247	\$11,369	\$18,514	\$17,483	--	\$9,630
42	108	29 3/8	304	66	NAV42108-30ARBB	\$9,203	\$10,227	\$9,368	\$10,390	\$16,832	\$15,863	--	\$8,791
42	96	29 3/8	282	63	NAV4296-30ARBB	\$9,151	\$10,166	\$9,315	\$10,332	\$15,971	\$15,070	--	\$8,739

NATIVE

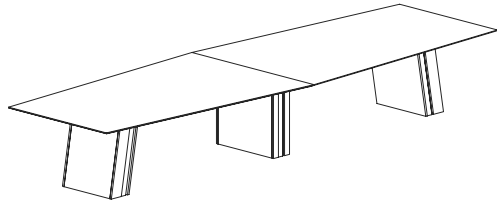
To Order, Specify:

1 Veneer Model #	2 Wood Species	3 Top Wood Finish	4 Base Finish	5 Top Edge	6 Metal Color	7 Electrical
Veneer (NAV)	Flat Cut B01 Black Oak CH1 Cherry MA1 Maple WA1 Walnut	See Top Wood Finish Options	See Base Finish Options	See Top Edge Options	See Metal Color Options	Cutout Codes: N all tables C1M 96" - 120" wide C1C 96" - 120" wide C1O 120" wide C2M 96" - 120" wide C2C 96" - 120" wide C3M 120" wide C3C 120" wide C3MOM 120" wide See chart on page NA15 for cutout codes and power and storage unit configurations
	Double Cut DC1 Double Cut	3 Top Wood Finish See Top Wood Finish Options				

1 Specialty Top Model #	2 Top Surface Selection	3 Base Wood Species	4a Base Wood Finish	4b Base Paint	5 Metal Color	6 Electrical
Solid Surface (NAV)	See Solid Surface Top Surface Selection	Flat Cut B01 Black Oak CH1 Cherry MA1 Maple WA1 Walnut	See Wood Base Finish Options	See Base Paint Options	See Metal Color Options	Cutout Codes: N all tables C1M 96" - 120" wide C1C 96" - 120" wide C1O 120" wide C2M 96" - 120" wide C2C 96" - 120" wide C3M 120" wide C3C 120" wide C3MOM 120" wide
Glass Surface (NAV)	See Glass Top Surface Selection					
Wood Plank (NAV)	See Wood Plank Top Surface Selection					
Sub-Top w/Base (NAV)	B (Table Ships with Sub-Top, Customer applies custom Top)	Double Cut DC1 Double Cut				

Description

Boat Shape 2pc Table with 3 Box Bases



Laminate Tops "NAT" Models



Eased Edge (R3)



Reverse Bevel Edge (E1)

Features:

- three box bases with structural support rails
- two-piece top
- narrow ends of table are 48"d
- glass top has additional seams

D	W	H	CTN WT	CU FT	① Model	HPL	HPL
60	240	29 ³ / ₈	698	169	NAT60240-30BTBB	\$17,535	\$18,072
60	216	29 ³ / ₈	647	144	NAT60216-30BTBB	\$15,794	\$16,331
60	192	29 ³ / ₈	592	133	NAT60192-30BTBB	\$14,691	\$15,228

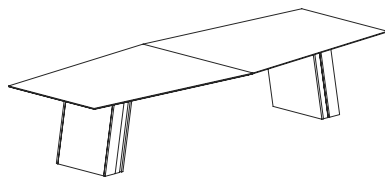
Options:

- metal base frame available in powder coat, no upcharge, or chrome, add \$3,267 list upcharge for 60" wide
- worksurface power & storage available, specify cutout code and order power units separately, see pages [NA14-NA15](#)

NATIVE

Description

Boat Shape 2pc Table with 2 Box Bases



Laminate Tops "NAT" Models



Eased Edge (R3)



Reverse Bevel Edge (E1)

Features:

- two box bases with structural support rails
- two-piece top
- narrow ends of table are 42"d
- glass top has additional seams

D	W	H	CTN WT	CU FT	① Model	HPL	HPL
54	168	29 ³ / ₈	448	96	NAT54168-30BTBB	\$9,958	\$10,495
54	144	29 ³ / ₈	371	92	NAT54144-30BTBB	\$9,022	\$9,559
54	132	29 ³ / ₈	371	80	NAT54132-30BTBB	\$8,655	\$9,192

Options:

- metal base frame available in powder coat, no upcharge, or chrome, add \$2,514 list upcharge for 54" wide
- worksurface power & storage available, specify cutout code and order power units separately, see pages [NA14-NA15](#)

To Order, Specify:

① Laminate Model #	② Top/Base Laminate	③ Top Edge	④ Metal Color	⑤ Electrical
Laminate (NAT)	See Top/Base Laminate Options	See Top Edge Options	Metal Color Options	Cutout Codes: N all tables C1M 132" - 240" wide C1C 132" - 240" wide C1O 132" - 240" wide C2M 132" - 240" wide C2C 132" - 240" wide C3M 132" - 240" wide C3C 132" - 240" wide C3MOM 132" - 240" wide

Description

Boat Shape 2pc Table with 3 Box Bases
(continued)

						Veneer Tops "NAV" Models				Premier Tops "NAV" Models			
						Eased Edge (R3)		Reverse Bevel Edge (E1)		Solid Surface/Glass Reverse Bevel Edge		Wood Plank Ash	
D	W	H	CTN WT	CU FT	1 Model	Flat Cut	Double Cut	Flat Cut	Double Cut	Solid Surface	Glass	Wood Plank Ash	Sub-Top with Base
60	240	29 3/8	698	169	NAV60240-30BTBB	\$22,752	\$25,191	\$23,028	\$25,468	\$46,311	\$43,895	--	\$21,730
60	216	29 3/8	647	144	NAV60216-30BTBB	\$20,656	\$23,006	\$20,932	\$23,281	\$41,914	\$39,684	--	\$19,728
60	192	29 3/8	592	133	NAV60192-30BTBB	\$19,314	\$21,592	\$19,588	\$21,867	\$38,099	\$36,228	--	\$18,444

Description

Boat Shape 2pc Table with 2 Box Bases
(continued)

						Veneer Tops "NAV" Models				Premier Tops "NAV" Models			
						Eased Edge (R3)		Reverse Bevel Edge (E1)		Solid Surface/Glass Reverse Bevel Edge		Wood Plank Ash	
D	W	H	CTN WT	CU FT	1 Model	Flat Cut	Double Cut	Flat Cut	Double Cut	Solid Surface	Glass	Wood Plank Ash	Sub-Top with Base
54	168	29 3/8	448	96	NAV54168-30BTBB	\$13,291	\$14,675	\$13,565	\$14,951	\$28,189	\$26,611	--	\$12,694
54	144	29 3/8	371	92	NAV54144-30BTBB	\$12,083	\$13,368	\$12,358	\$13,643	\$24,919	\$23,499	--	\$11,540
54	132	29 3/8	371	80	NAV54132-30BTBB	\$11,605	\$12,847	\$11,880	\$13,125	\$23,372	\$22,070	--	\$11,084

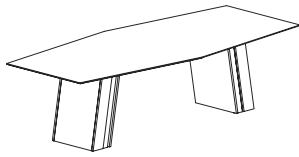
To Order, Specify:

1 Veneer Model #	2 Wood Species	3 Top Wood Finish	4 Base Finish	5 Top Edge	6 Metal Color	7 Electrical
Veneer (NAV)	Flat Cut B01 Black Oak CH1 Cherry MA1 Maple WA1 Walnut	See Top Wood Finish Options	See Base Finish Options	See Top Edge Options	See Metal Color Options	Cutout Codes: N all tables C1M 132" - 240"w C1C 132" - 240"w C1O 132" - 240"w C2M 132" - 240"w C2C 132" - 240"w C3M 132" - 240"w C3C 132" - 240"w C3MOM 132" - 240"w See chart on page NA15 for cutout codes and power and storage unit configurations
	Double Cut DC1 Double Cut	3 Top Wood Finish See Top Wood Finish Options				

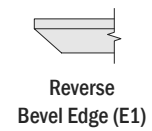
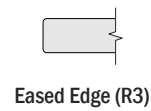
1 Specialty Top Model #	2 Top Surface Selection	3 Base Wood Species	4a Base Wood Finish	4b Base Paint	5 Metal Color	6 Electrical
Solid Surface (NAV)	See Solid Surface Top Surface Selection	Flat Cut B01 Black Oak CH1 Cherry MA1 Maple WA1 Walnut	See Wood Base Finish Options	See Base Paint Options	See Metal Color Options	Cutout Codes: N all tables C1M 132" - 240"w C1C 132" - 240"w C1O 132" - 240"w C2M 132" - 240"w C2C 132" - 240"w C3M 132" - 240"w C3C 132" - 240"w C3MOM 132" - 240"w
Glass Surface (NAV)	See Glass Top Surface Selection					
Wood Plank (NAV)	See Wood Plank Top Surface Selection					
Sub-Top w/Base (NAV)	B (Table Ships with Sub-Top, Customer applies custom Top)	Double Cut DC1 Double Cut				

Description

Boat Shape Table with Box Base



Laminate Tops "NAT" Models



Features:

- two box bases with structural support rails
- one-piece top
- narrow ends of table are 36"d
- glass top has additional seams

D	W	H	CTN WT	CU FT	① Model	HPL	HPL
48	120	29 ³ / ₈	297	70	NAT48120-30BTBB	\$7,191	\$7,616
48	108	29 ³ / ₈	297	65	NAT48108-30BTBB	\$6,504	\$6,932
48	96	29 ³ / ₈	275	60	NAT4896-30BTBB	\$6,890	\$7,315

Options:

- metal base frame available in powder coat, no upcharge, or chrome, add \$2,197 list upcharge for 48" wide
- worksurface power & storage available, specify cutout code and order power units separately, see pages [NA14-NA15](#)

NATIVE

To Order, Specify:

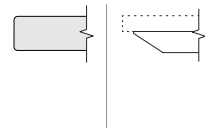
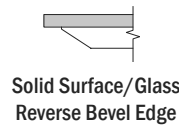
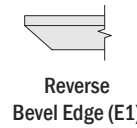
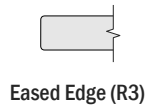
① Laminate Model #	② Top/Base Laminate	③ Top Edge	④ Metal Color	⑤ Electrical
Laminate (NAT)	See Top/Base Laminate Options	See Top Edge Options	Metal Color Options	Cutout Codes: N all tables C1M 96" - 120" wide C1C 96" - 120" wide C1O 120" wide C2M 96" - 120" wide C2C 96" - 120" wide C3M 120" wide C3C 120" wide C3MOM 120" wide

Description

Boat Shape Table with Box Base
(continued)

Veneer Tops "NAV" Models

Premier Tops "NAV" Models



D	W	H	CTN WT	CU FT	1 Model	Veneer Tops "NAV" Models		Premier Tops "NAV" Models					
						Flat Cut	Double Cut	Flat Cut	Double Cut	Solid Surface	Glass	Wood Plank Ash	Sub-Top with Base
48	120	29 3/8	297	70	NAV48120-30BTBB	\$10,166	\$11,297	\$10,332	\$11,461	\$19,800	\$18,624	--	\$9,709
48	108	29 3/8	297	65	NAV48108-30BTBB	\$9,198	\$10,220	\$9,363	\$10,384	\$17,915	\$16,810	--	\$8,785
48	96	29 3/8	275	60	NAV4896-30BTBB	\$9,741	\$10,822	\$9,906	\$10,988	\$17,474	\$16,508	--	\$9,304

NATIVE

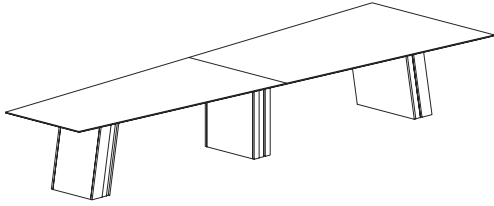
To Order, Specify:

1 Veneer Model #	2 Wood Species	3 Top Wood Finish	4 Base Finish	5 Top Edge	6 Metal Color	7 Electrical
Veneer (NAV)	Flat Cut B01 Black Oak CH1 Cherry MA1 Maple WA1 Walnut	See Top Wood Finish Options	See Base Finish Options	See Top Edge Options	See Metal Color Options	Cutout Codes: N all tables C1M 96" - 120" wide C1C 96" - 120" wide C1O 120" wide C2M 96" - 120" wide C2C 96" - 120" wide C3M 120" wide C3C 120" wide C3MOM 120" wide See chart on page NA15 for cutout codes and power and storage unit configurations
	Double Cut DC1 Double Cut	3 Top Wood Finish See Top Wood Finish Options				

1 Specialty Top Model #	2 Top Surface Selection	3 Base Wood Species	4a Base Wood Finish	4b Base Paint	5 Metal Color	6 Electrical
Solid Surface (NAV)	See Solid Surface Top Surface Selection	Flat Cut B01 Black Oak CH1 Cherry MA1 Maple WA1 Walnut	See Wood Base Finish Options	See Base Paint Options	See Metal Color Options	Cutout Codes: N all tables C1M 96" - 120" wide C1C 96" - 120" wide C1O 120" wide C2M 96" - 120" wide C2C 96" - 120" wide C3M 120" wide C3C 120" wide C3MOM 120" wide
Glass Surface (NAV)	See Glass Top Surface Selection					
Wood Plank (NAV)	See Wood Plank Top Surface Selection					
Sub-Top w/Base (NAV)	B (Table Ships with Sub-Top, Customer applies custom Top)	Double Cut DC1 Double Cut				

Description

View 2pc Table with 3 Box Bases



Features:

- three box bases with structural support rails
- two-piece top
- narrow end of table is 36"d
- glass top has additional seams

Options:

- metal base frame available in powder coat, no upcharge, or chrome, add \$3,267 list upcharge for 60" wide
- worksurface power & storage available, specify cutout code and order power units separately, see pages [NA14-NA15](#)

Laminate Tops "NAT" Models



Eased Edge (R3)



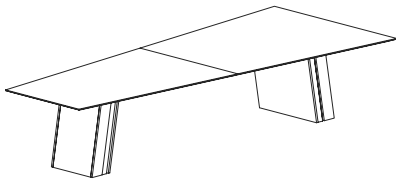
Reverse Bevel Edge (E1)

D	W	H	CTN WT	CU FT	① Model	HPL	HPL
60	240	29 ³ / ₈	643	90	NAT60240-30VTBB	\$18,294	\$18,831
60	216	29 ³ / ₈	597	84	NAT60216-30VTBB	\$16,486	\$17,024
60	192	29 ³ / ₈	547	133	NAT60192-30VTBB	\$15,371	\$15,908

NATIVE

Description

View 2pc Table with 2 Box Bases



Features:

- two box bases with structural support rails
- two-piece top
- narrow end of table is 36"d
- glass top has additional seams

Options:

- metal base frame available in powder coat, no upcharge, or chrome, add \$2,514 list upcharge for 60" wide
- worksurface power & storage available, specify cutout code and order power units separately, see pages [NA14-NA15](#)

Laminate Tops "NAT" Models



Eased Edge (R3)



Reverse Bevel Edge (E1)

D	W	H	CTN WT	CU FT	① Model	HPL	HPL
60	168	29 ³ / ₈	449	74	NAT60168-30VTBB	\$11,647	\$12,184
60	144	29 ³ / ₈	399	95	NAT60144-30VTBB	\$9,393	\$9,930
60	132	29 ³ / ₈	371	63	NAT60132-30VTBB	\$8,943	\$9,480

To Order, Specify:

① Laminate Model #	② Top/Base Laminate	③ Top Edge	④ Metal Color	⑤ Electrical
Laminate (NAT)	See Top/Base Laminate Options	See Top Edge Options	Metal Color Options	Cutout Codes: N all tables C1M 132" - 240" wide C1C 132" - 240" wide C1O 132" - 240" wide C2M 132" - 240" wide C2C 132" - 240" wide C3M 132" - 240" wide C3C 132" - 240" wide C3MOM 132" - 240" wide

Description

View 2pc Table with 3 Box Bases
(continued)

						Veneer Tops "NAV" Models				Premier Tops "NAV" Models			
						Eased Edge (R3)		Reverse Bevel Edge (E1)		Solid Surface/Glass Reverse Bevel Edge		Wood Plank Ash	
D	W	H	CTN WT	CU FT	1 Model	Flat Cut	Double Cut	Flat Cut	Double Cut	Solid Surface	Glass	Wood Plank Ash	Sub-Top with Base
60	240	29 3/8	643	90	NAV60240-30VTBB	\$23,738	\$26,284	\$24,014	\$26,558	\$47,296	\$44,880	--	\$22,671
60	216	29 3/8	597	84	NAV60216-30VTBB	\$21,562	\$24,013	\$21,838	\$24,289	\$42,819	\$40,589	--	\$20,592
60	192	29 3/8	547	133	NAV60192-30VTBB	\$20,208	\$22,593	\$20,485	\$22,868	\$38,996	\$37,123	--	\$19,300

Description

View 2pc Table with 2 Box Bases
(continued)

						Veneer Tops "NAV" Models				Premier Tops "NAV" Models			
						Eased Edge (R3)		Reverse Bevel Edge (E1)		Solid Surface/Glass Reverse Bevel Edge		Wood Plank Ash	
D	W	H	CTN WT	CU FT	1 Model	Flat Cut	Double Cut	Flat Cut	Double Cut	Solid Surface	Glass	Wood Plank Ash	Sub-Top with Base
60	168	29 3/8	449	74	NAV60168-30VTBB	\$15,398	\$17,285	\$15,674	\$17,560	\$31,894	\$30,197	--	\$14,707
60	144	29 3/8	399	95	NAV60144-30VTBB	\$12,672	\$14,431	\$12,947	\$14,708	\$26,881	\$25,357	--	\$12,102
60	132	29 3/8	371	63	NAV60132-30VTBB	\$11,921	\$13,463	\$12,197	\$13,738	\$24,945	\$23,548	--	\$11,385

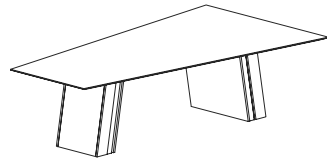
To Order, Specify:

1 Veneer Model #	2 Wood Species	3 Top Wood Finish	4 Base Finish	5 Top Edge	6 Metal Color	7 Electrical
Veneer (NAV)	Flat Cut B01 Black Oak CH1 Cherry MA1 Maple WA1 Walnut	See Top Wood Finish Options	See Base Finish Options	See Top Edge Options	See Metal Color Options	Cutout Codes: N all tables C1M 132" - 240"w C1C 132" - 240"w C1O 132" - 240"w C2M 132" - 240"w C2C 132" - 240"w C3M 132" - 240"w C3C 132" - 240"w C3MOM 132" - 240"w See chart on page NA15 for cutout codes and power and storage unit configurations
	Double Cut DC1 Double Cut	3 Top Wood Finish See Top Wood Finish Options				

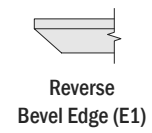
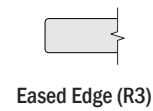
1 Specialty Top Model #	2 Top Surface Selection	3 Base Wood Species	4a Base Wood Finish	4b Base Paint	5 Metal Color	6 Electrical
Solid Surface (NAV)	See Solid Surface Top Surface Selection	Flat Cut B01 Black Oak CH1 Cherry MA1 Maple WA1 Walnut	See Wood Base Finish Options	See Base Paint Options	See Metal Color Options	Cutout Codes: N all tables C1M 132" - 240"w C1C 132" - 240"w C1O 132" - 240"w C2M 132" - 240"w C2C 132" - 240"w C3M 132" - 240"w C3C 132" - 240"w C3MOM 132" - 240"w
Glass Surface (NAV)	See Glass Top Surface Selection					
Wood Plank (NAV)	See Wood Plank Top Surface Selection					
Sub-Top w/Base (NAV)	B (Table Ships with Sub-Top, Customer applies custom Top)	Double Cut DC1 Double Cut				

Description

View Table with Box Base



Laminate Tops "NAT" Models



Features:

- two box bases with structural support rails
- one-piece top
- narrow end of table is 36"d
- glass top has additional seams

D	W	H	CTN WT	CU FT	① Model	HPL	HPL
60	120	29 $\frac{3}{8}$	349	70	NAT60120-30VTBB	\$7,954	\$8,380
60	108	29 $\frac{3}{8}$	331	66	NAT60108-30VTBB	\$7,782	\$8,208
54	96	29 $\frac{3}{8}$	297	63	NAT5496-30VTBB	\$7,184	\$7,610

Options:

- metal base frame available in powder coat, no upcharge, or chrome, add list upcharge: for 54" & 60" wide - \$2,514
- worksurface power & storage available, specify cutout code and order power units separately, see pages [NA14-NA15](#)

NATIVE

To Order, Specify:

① Laminate Model #	② Top/Base Laminate	③ Top Edge	④ Metal Color	⑤ Electrical
Laminate (NAT)	See Top/Base Laminate Options	See Top Edge Options	Metal Color Options	Cutout Codes: N all tables C1M 96" - 120" wide C1C 96" - 120" wide C1O 120" wide C2M 96" - 120" wide C2C 96" - 120" wide C3M 120" wide C3C 120" wide C3MOM 120" wide

Description

View Table with Box Base
(continued)

						Veneer Tops "NAV" Models				Premier Tops "NAV" Models			
						Eased Edge (R3)		Reverse Bevel Edge (E1)		Solid Surface/Glass Reverse Bevel Edge			
D	W	H	CTN WT	CU FT	1 Model	Flat Cut	Double Cut	Flat Cut	Double Cut	Solid Surface	Glass	Wood Plank Ash	Sub-Top with Base
60	120	29 3/8	349	70	NAV60120-30VTBB	\$11,247	\$12,810	\$11,413	\$12,975	\$23,167	\$21,818	--	\$10,742
60	108	29 3/8	331	66	NAV60108-30VTBB	\$10,923	\$12,376	\$11,089	\$12,541	\$21,655	\$20,439	--	\$10,434
54	96	29 3/8	297	63	NAV5496-30VTBB	\$10,105	\$11,197	\$10,271	\$11,362	\$18,748	\$17,719	--	\$9,653

NATIVE

To Order, Specify:

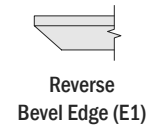
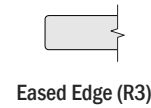
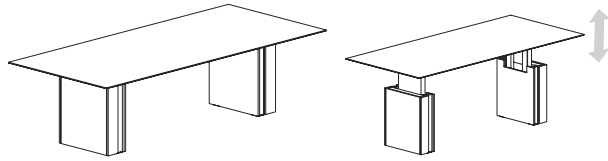
1 Veneer Model #	2 Wood Species	3 Top Wood Finish	4 Base Finish	5 Top Edge	6 Metal Color	7 Electrical
Veneer (NAV)	Flat Cut B01 Black Oak CH1 Cherry MA1 Maple WA1 Walnut	See Top Wood Finish Options	See Base Finish Options	See Top Edge Options	See Metal Color Options	Cutout Codes: N all tables C1M 96" - 120" wide C1C 96" - 120" wide C1O 120" wide C2M 96" - 120" wide C2C 96" - 120" wide C3M 120" wide C3C 120" wide C3MOM 120" wide See chart on page NA15 for cutout codes and power and storage unit configurations
	Double Cut DC1 Double Cut	3 Top Wood Finish See Top Wood Finish Options				

1 Specialty Top Model #	2 Top Surface Selection	3 Base Wood Species	4a Base Wood Finish	4b Base Paint	5 Metal Color	6 Electrical
Solid Surface (NAV)	See Solid Surface Top Surface Selection	Flat Cut B01 Black Oak CH1 Cherry MA1 Maple WA1 Walnut	See Wood Base Finish Options	See Base Paint Options	See Metal Color Options	Cutout Codes: N all tables C1M 96" - 120" wide C1C 96" - 120" wide C1O 120" wide C2M 96" - 120" wide C2C 96" - 120" wide C3M 120" wide C3C 120" wide C3MOM 120" wide
Glass Surface (NAV)	See Glass Top Surface Selection					
Wood Plank (NAV)	See Wood Plank Top Surface Selection					
Sub-Top w/Base (NAV)	B (Table Ships with Sub-Top, Customer applies custom Top)	Double Cut DC1 Double Cut				

Description

Rectangular Table with Height Adjustable Base

Laminate Tops "NAT" Models



Features:

- height adjustable bases with structural support rails
- 30" to 40" height adjustment with digital controller; 10' power cord
- maximum weight rating 300lbs (evenly distributed load)
- one-piece top

Options:

- metal base frame available in powder coat, no upcharge, or chrome, add list upcharge: for 36" wide - \$2,216, 42" & 48" wide - \$2,514, for 54" wide - \$2,827
- worksurface power & storage available, specify cutout code and order power units separately, see pages [NA14-NA15](#)

D	W	H	CTN WT	CU FT	① Model	HPL	HPL
54	120	Adj.	428	89	NAT54120-30TTAH	\$12,408	\$12,843
48	120	Adj.	387	81	NAT48120-30TTAH	\$11,905	\$12,342
48	108	Adj.	373	71	NAT48108-30TTAH	\$11,444	\$11,881
48	96	Adj.	346	65	NAT4896-30TTAH	\$11,342	\$11,778
48	84	Adj.	318	61	NAT4884-30TTAH	\$11,098	\$11,534
48	72	Adj.	232	56	NAT4872-30TTAH	\$10,885	\$11,322
42	120	Adj.	366	77	NAT42120-30TTAH	\$11,806	\$12,242
42	108	Adj.	349	69	NAT42108-30TTAH	\$11,259	\$11,695
42	96	Adj.	326	64	NAT4296-30TTAH	\$11,178	\$11,615
42	84	Adj.	301	50	NAT4284-30TTAH	\$10,954	\$11,390
42	72	Adj.	278	47	NAT4272-30TTAH	\$10,779	\$11,216
36	84	Adj.	268	47	NAT3684-30TTAH	\$10,784	\$11,221
36	72	Adj.	249	43	NAT3672-30TTAH	\$10,673	\$11,108

To Order, Specify:

① Laminate Model #	② Top/Base Laminate	③ Top Edge	④ Metal Color	⑤ Electrical
Laminate (NAT)	See Top/Base Laminate Options	See Top Edge Options	Metal Color Options	Cutout Codes: N all tables C1M 72" - 120" wide C1C 72" - 120" wide C1O 120" wide C2M 96" - 120" wide C2C 96" - 120" wide C3M 120" wide C3C 120" wide C3MOM 120" wide

Description

Rectangular Table with Height Adjustable Base
(continued)

						Veneer Tops "NAV" Models				Premier Tops "NAV" Models			
						Eased Edge (R3)		Reverse Bevel Edge (E1)		Solid Surface/Glass Reverse Bevel Edge		Wood Plank Ash	
D	W	H	CTN WT	CU FT	① Model	Flat Cut	Double Cut	Flat Cut	Double Cut	Solid Surface	Glass	Wood Plank Ash	Sub-Top with Base
54	120	Adj.	428	89	NAV54120-30TTAH	\$16,561	\$17,596	\$16,729	\$17,764	\$27,601	--	--	\$15,816
48	120	Adj.	387	81	NAV48120-30TTAH	\$15,959	\$16,986	\$16,130	\$17,156	\$25,830	--	\$22,118	\$15,244
48	108	Adj.	373	71	NAV48108-30TTAH	\$15,344	\$16,331	\$15,513	\$16,500	\$24,273	--	\$20,885	\$14,656
48	96	Adj.	346	65	NAV4896-30TTAH	\$15,209	\$16,186	\$15,378	\$16,355	\$23,128	--	\$20,134	\$14,525
48	84	Adj.	318	61	NAV4884-30TTAH	\$14,879	\$15,838	\$15,048	\$16,005	\$21,865	--	\$19,189	\$14,211
48	72	Adj.	232	56	NAV4872-30TTAH	\$14,594	\$15,533	\$14,762	\$15,702	\$20,646	--	\$18,288	\$13,939
42	120	Adj.	366	77	NAV42120-30TTAH	\$15,829	\$16,847	\$15,997	\$17,017	\$24,467	--	\$21,216	\$15,117
42	108	Adj.	349	69	NAV42108-30TTAH	\$15,097	\$16,069	\$15,265	\$16,237	\$22,911	--	\$19,946	\$14,418
42	96	Adj.	326	64	NAV4296-30TTAH	\$14,988	\$15,952	\$15,156	\$16,120	\$21,975	--	\$19,297	\$14,314
42	84	Adj.	301	50	NAV4284-30TTAH	\$14,686	\$15,631	\$14,855	\$15,800	\$20,853	--	\$18,457	\$14,024
42	72	Adj.	278	47	NAV4272-30TTAH	\$14,455	\$15,384	\$14,624	\$15,554	\$19,806	--	\$17,686	\$13,804
36	84	Adj.	268	47	NAV3684-30TTAH	\$14,458	\$15,389	\$14,628	\$15,557	\$19,811	--	\$17,691	\$13,807
36	72	Adj.	249	43	NAV3672-30TTAH	\$14,310	\$15,230	\$14,479	\$15,399	\$18,959	--	\$17,081	\$13,666

NATIVE

To Order, Specify:

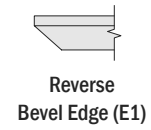
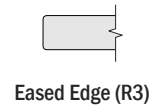
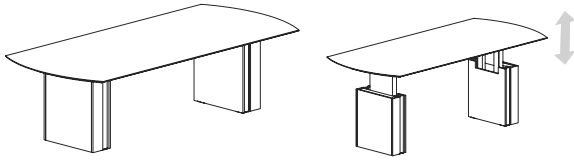
① Veneer Model #	② Wood Species	③ Top Wood Finish	④ Base Finish	⑤ Top Edge	⑥ Metal Color	⑦ Electrical
Veneer (NAV)	Flat Cut B01 Black Oak CH1 Cherry MA1 Maple WA1 Walnut	See Top Wood Finish Options	See Base Finish Options	See Top Edge Options	See Metal Color Options	Cutout Codes: N all tables C1M 72" - 120" wide C1C 72" - 120" wide C1O 120" wide C2M 96" - 120" wide C2C 96" - 120" wide C3M 120" wide C3C 120" wide C3MOM 120" wide See chart on page NA15 for cutout codes and power and storage unit configurations
	Double Cut DC1 Double Cut	③ Top Wood Finish See Top Wood Finish Options				

① Specialty Top Model #	② Top Surface Selection	③ Base Wood Species	④a Base Wood Finish	④b Base Paint	⑤ Metal Color	⑥ Electrical
Solid Surface (NAV)	See Solid Surface Top Surface Selection	Flat Cut B01 Black Oak CH1 Cherry MA1 Maple WA1 Walnut	See Wood Base Finish Options	See Base Paint Options	See Metal Color Options	Cutout Codes: N all tables C1M 72" - 120" wide C1C 72" - 120" wide C1O 120" wide C2M 96" - 120" wide C2C 96" - 120" wide C3M 120" wide C3C 120" wide C3MOM 120" wide
Glass Surface (NAV)	See Glass Top Surface Selection					
Wood Plank (NAV)	See Wood Plank Top Surface Selection					
Sub-Top w/Base (NAV)	B (Table Ships with Sub-Top, Customer applies custom Top)	Double Cut DC1 Double Cut				

Description

Arc End Table with Height Adjustable Base

Laminate Tops "NAT" Models



Features:

- height adjustable bases with structural support rails
- 30" to 40" height adjustment with digital controller; 10' power cord
- maximum weight rating 300lbs (evenly distributed load)
- one-piece top

Options:

- metal base frame available in powder coat, no upcharge, or chrome, add list upcharge: for 36" wide - \$2,216, 42" & 48" wide - \$2,514, for 54" wide - \$2,827
- worksurface power & storage available, specify cutout code and order power units separately, see pages [NA14-NA15](#)

D	W	H	CTN WT	CU FT	① Model	HPL	HPL
54	120	Adj.	352	89	NAT54120-30ARAH	\$12,408	\$12,843
48	120	Adj.	381	81	NAT48120-30ARAH	\$11,905	\$12,342
48	108	Adj.	367	71	NAT48108-30ARAH	\$11,444	\$11,881
48	96	Adj.	385	65	NAT4896-30ARAH	\$11,342	\$11,778
48	84	Adj.	313	61	NAT4884-30ARAH	\$11,098	\$11,534
48	72	Adj.	292	56	NAT4872-30ARAH	\$10,885	\$11,322
42	120	Adj.	358	77	NAT42120-30ARAH	\$11,806	\$12,242
42	108	Adj.	353	69	NAT42108-30ARAH	\$11,259	\$11,695
42	96	Adj.	319	64	NAT4296-30ARAH	\$11,178	\$11,615
42	84	Adj.	312	50	NAT4284-30ARAH	\$9,384	\$9,822
42	72	Adj.	278	47	NAT4272-30ARAH	\$10,833	\$11,271
36	84	Adj.	264	47	NAT3684-30ARAH	\$10,784	\$11,221
36	72	Adj.	156	43	NAT3672-30ARAH	\$10,673	\$11,108

To Order, Specify:

① Laminate Model #	② Top/Base Laminate	③ Top Edge	④ Metal Color	⑤ Electrical
Laminate (NAT)	See Top/Base Laminate Options	See Top Edge Options	Metal Color Options	Cutout Codes: N all tables C1M 72" - 120" wide C1C 72" - 120" wide C1O 120" wide C2M 96" - 120" wide C2C 96" - 120" wide C3M 120" wide C3C 120" wide C3MOM 120" wide

Description

Arc End Table with Height Adjustable Base
(continued)

						Veneer Tops "NAV" Models				Premier Tops "NAV" Models			
						Eased Edge (R3)		Reverse Bevel Edge (E1)		Solid Surface/Glass Reverse Bevel Edge			
D	W	H	CTN WT	CU FT	① Model	Flat Cut	Double Cut	Flat Cut	Double Cut	Solid Surface	Glass	Wood Plank Ash	Sub-Top with Base
54	120	Adj.	352	89	NAV54120-30ARAH	\$16,561	\$17,596	\$16,729	\$17,764	\$27,601	--	--	\$15,816
48	120	Adj.	381	81	NAV48120-30ARAH	\$15,959	\$16,986	\$16,130	\$17,156	\$25,830	--	--	\$15,244
48	108	Adj.	367	71	NAV48108-30ARAH	\$15,344	\$16,331	\$15,513	\$16,500	\$24,273	--	--	\$14,656
48	96	Adj.	385	65	NAV4896-30ARAH	\$15,209	\$16,186	\$15,378	\$16,355	\$23,128	--	--	\$14,525
48	84	Adj.	313	61	NAV4884-30ARAH	\$14,879	\$15,838	\$15,048	\$16,005	\$21,865	--	--	\$14,211
48	72	Adj.	292	56	NAV4872-30ARAH	\$14,594	\$15,533	\$14,762	\$15,702	\$20,646	--	--	\$13,939
42	120	Adj.	358	77	NAV42120-30ARAH	\$15,829	\$16,847	\$15,997	\$17,017	\$24,467	--	--	\$15,117
42	108	Adj.	353	69	NAV42108-30ARAH	\$15,097	\$16,069	\$15,265	\$16,237	\$22,911	--	--	\$14,418
42	96	Adj.	319	64	NAV4296-30ARAH	\$14,988	\$15,952	\$15,156	\$16,120	\$21,975	--	--	\$14,314
42	84	Adj.	312	50	NAV4284-30ARAH	\$14,758	\$15,673	\$14,894	\$15,842	\$20,891	--	--	\$14,062
42	72	Adj.	278	47	NAV4272-30ARAH	\$14,527	\$15,461	\$14,696	\$15,629	\$19,878	--	--	\$13,873
36	84	Adj.	264	47	NAV3684-30ARAH	\$14,458	\$15,389	\$14,628	\$15,557	\$19,811	--	--	\$13,807
36	72	Adj.	156	43	NAV3672-30ARAH	\$14,310	\$15,230	\$14,479	\$15,399	\$18,959	--	--	\$13,666

NATIVE

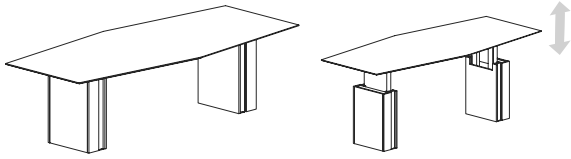
To Order, Specify:

① Veneer Model #	② Wood Species	③ Top Wood Finish	④ Base Finish	⑤ Top Edge	⑥ Metal Color	⑦ Electrical
Veneer (NAV)	Flat Cut B01 Black Oak CH1 Cherry MA1 Maple WA1 Walnut	See Top Wood Finish Options	See Base Finish Options	See Top Edge Options	See Metal Color Options	Cutout Codes: N all tables C1M 72" - 120" wide C1C 72" - 120" wide C1O 120" wide C2M 96" - 120" wide C2C 96" - 120" wide C3M 120" wide C3C 120" wide C3MOM 120" wide See chart on page NA15 for cutout codes and power and storage unit configurations
	Double Cut DC1 Double Cut	③ Top Wood Finish See Top Wood Finish Options				

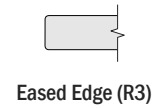
① Specialty Top Model #	② Top Surface Selection	③ Base Wood Species	④a Base Wood Finish	④b Base Paint	⑤ Metal Color	⑥ Electrical
Solid Surface (NAV)	See Solid Surface Top Surface Selection	Flat Cut B01 Black Oak CH1 Cherry MA1 Maple WA1 Walnut	See Wood Base Finish Options	See Base Paint Options	See Metal Color Options	Cutout Codes: N all tables C1M 72" - 120" wide C1C 72" - 120" wide C1O 120" wide C2M 96" - 120" wide C2C 96" - 120" wide C3M 120" wide C3C 120" wide C3MOM 120" wide
Glass Surface (NAV)	See Glass Top Surface Selection					
Wood Plank (NAV)	See Wood Plank Top Surface Selection					
Sub-Top w/Base (NAV)	B (Table Ships with Sub-Top, Customer applies custom Top)	Double Cut DC1 Double Cut				

Description

Boat Shape Table with Height Adjustable Base



Laminate Tops "NAT" Models



Eased Edge (R3)



Reverse Bevel Edge (E1)

Features:

- height adjustable bases with structural support rails
- 30" to 40" height adjustment with digital controller; 10' power cord
- maximum weight rating 300lbs (evenly distributed load)
- one-piece top
- narrow ends of table are 36"d

Options:

- metal base frame available in powder coat, no upcharge, or chrome, add \$2,514 list upcharge for 42" & 48" wide
- worksurface power & storage available, specify cutout code and order power units separately, see pages [NA14-NA15](#)

D	W	H	CTN WT	CU FT	① Model	HPL	HPL
48	120	Adj.	346	73	NAT48120-30BTAH	\$11,794	\$12,228
48	108	Adj.	335	71	NAT48108-30BTAH	\$11,700	\$12,137
48	96	Adj.	369	61	NAT4896-30BTAH	\$11,136	\$11,571
48	84	Adj.	313	59	NAT4884-30BTAH	\$10,896	\$11,334
42	72	Adj.	278	49	NAT4272-30BTAH	\$9,205	\$9,643

NATIVE

To Order, Specify:

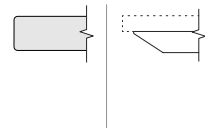
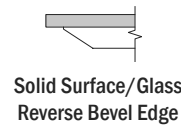
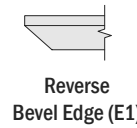
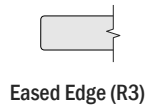
① Laminate Model #	② Top/Base Laminate	③ Top Edge	④ Metal Color	⑤ Electrical
Laminate (NAT)	See Top/Base Laminate Options	See Top Edge Options	Metal Color Options	Cutout Codes: N all tables C1M 72" - 120" wide C1C 72" - 120" wide C1O 120" wide C2M 96" - 120" wide C2C 96" - 120" wide C3M 120" wide C3C 120" wide C3MOM 120" wide

Description

Boat Shape Table with Height Adjustable Base
(continued)

Veneer Tops "NAV" Models

Premier Tops "NAV" Models



D	W	H	CTN WT	CU FT	① Model	Veneer Tops "NAV" Models		Premier Tops "NAV" Models					
						Flat Cut	Double Cut	Flat Cut	Double Cut	Solid Surface	Glass	Wood Plank Ash	Sub-Top with Base
48	120	Adj.	346	73	NAV48120-30BTAH	\$15,811	\$16,829	\$15,979	\$16,996	\$25,680	--	--	\$15,101
48	108	Adj.	335	71	NAV48108-30BTAH	\$15,690	\$16,699	\$15,857	\$16,868	\$24,619	--	--	\$14,984
48	96	Adj.	369	61	NAV4896-30BTAH	\$14,931	\$15,889	\$15,099	\$16,058	\$22,850	--	--	\$14,259
48	84	Adj.	313	59	NAV4884-30BTAH	\$14,609	\$15,550	\$14,779	\$15,716	\$21,597	--	--	\$13,953
42	72	Adj.	278	49	NAV4272-30BTAH	\$12,343	\$13,136	\$12,510	\$13,305	\$17,692	--	--	\$11,787

NATIVE

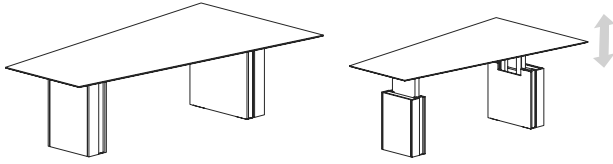
To Order, Specify:

① Veneer Model #	② Wood Species	③ Top Wood Finish	④ Base Finish	⑤ Top Edge	⑥ Metal Color	⑦ Electrical
Veneer (NAV)	Flat Cut B01 Black Oak CH1 Cherry MA1 Maple WA1 Walnut	See Top Wood Finish Options	See Base Finish Options	See Top Edge Options	See Metal Color Options	Cutout Codes: N all tables C1M 72" - 120" wide C1C 72" - 120" wide C1O 120" wide C2M 96" - 120" wide C2C 96" - 120" wide C3M 120" wide C3C 120" wide C3MOM 120" wide See chart on page NA15 for cutout codes and power and storage unit configurations
	Double Cut DC1 Double Cut	③ Top Wood Finish See Top Wood Finish Options				

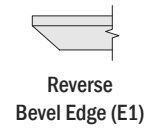
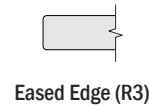
① Specialty Top Model #	② Top Surface Selection	③ Base Wood Species	④a Base Wood Finish	④b Base Paint	⑤ Metal Color	⑥ Electrical
Solid Surface (NAV)	See Solid Surface Top Surface Selection	Flat Cut B01 Black Oak CH1 Cherry MA1 Maple WA1 Walnut	See Wood Base Finish Options	See Base Paint Options	See Metal Color Options	Cutout Codes: N all tables C1M 72" - 120" wide C1C 72" - 120" wide C1O 120" wide C2M 96" - 120" wide C2C 96" - 120" wide C3M 120" wide C3C 120" wide C3MOM 120" wide
Glass Surface (NAV)	See Glass Top Surface Selection					
Wood Plank (NAV)	See Wood Plank Top Surface Selection					
Sub-Top w/Base (NAV)	B (Table Ships with Sub-Top, Customer applies custom Top)	Double Cut DC1 Double Cut				

Description

View Table with Height Adjustable Base



Laminate Tops "NAT" Models



Features:

- height adjustable bases with structural support rails
- 30" to 40" height adjustment with digital controller; 10' power cord
- maximum weight rating 300lbs (evenly distributed load)
- one-piece top
- narrow end of table is 36"d

Options:

- metal base frame available in powder coat, no upcharge, or chrome, add list upcharge: for 48" wide - \$2,514, for 54" & 60" wide - \$2,827
- worksurface power & storage available, specify cutout code and order power units separately, see pages [NA14-NA15](#)

D	W	H	CTN WT	CU FT	① Model	HPL	HPL
60	120	Adj.	386	94	NAT60120-30VTAH	\$13,351	\$13,788
60	108	Adj.	372	95	NAT60108-30VTAH	\$12,645	\$13,081
54	96	Adj.	335	100	NAT5496-30VTAH	\$12,115	\$12,553
54	84	Adj.	322	141	NAT5484-30VTAH	\$11,869	\$12,305
48	72	Adj.	292	134	NAT4872-30VTAH	\$7,634	\$8,071

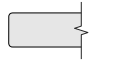

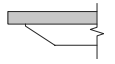


NATIVE

To Order, Specify:

① Laminate Model #	② Top/Base Laminate	③ Top Edge	④ Metal Color	⑤ Electrical
Laminate (NAT)	See Top/Base Laminate Options	See Top Edge Options	Metal Color Options	Cutout Codes: N all tables C1M 72" - 120" wide C1C 72" - 120" wide C1O 120" wide C2M 96" - 120" wide C2C 96" - 120" wide C3M 120" wide C3C 120" wide C3MOM 120" wide

Description

View Table with Height Adjustable Base
(continued)

						Veneer Tops "NAV" Models				Premier Tops "NAV" Models			
						 Eased Edge (R3)		 Reverse Bevel Edge (E1)		 Solid Surface/Glass Reverse Bevel Edge		 	
D	W	H	CTN WT	CU FT	① Model	Flat Cut	Double Cut	Flat Cut	Double Cut	Solid Surface	Glass	Wood Plank Ash	Sub-Top with Base
60	120	Adj.	386	94	NAV60120-30VTAH	\$17,743	\$19,989	\$17,910	\$20,158	\$29,953	--	--	\$16,944
60	108	Adj.	372	95	NAV60108-30VTAH	\$16,841	\$19,004	\$17,009	\$19,172	\$27,831	--	--	\$16,083
54	96	Adj.	335	100	NAV5496-30VTAH	\$16,172	\$17,857	\$16,338	\$18,024	\$25,024	--	--	\$15,445
54	84	Adj.	322	141	NAV5484-30VTAH	\$15,840	\$17,490	\$16,008	\$17,658	\$23,698	--	--	\$15,126
48	72	Adj.	292	134	NAV4872-30VTAH	\$10,237	\$11,335	\$10,406	\$11,502	\$16,287	--	--	\$9,777

NATIVE

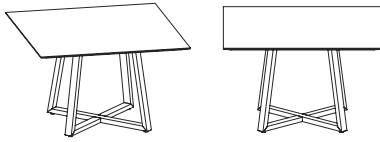
To Order, Specify:

① Veneer Model #	② Wood Species	③ Top Wood Finish	④ Base Finish	⑤ Top Edge	⑥ Metal Color	⑦ Electrical
Veneer (NAV)	Flat Cut B01 Black Oak CH1 Cherry MA1 Maple WA1 Walnut	See Top Wood Finish Options	See Base Finish Options	See Top Edge Options	See Metal Color Options	Cutout Codes: N all tables C1M 72" - 120" wide C1C 72" - 120" wide C1O 120" wide C2M 96" - 120" wide C2C 96" - 120" wide C3M 120" wide C3C 120" wide C3MOM 120" wide See chart on page NA15 for cutout codes and power and storage unit configurations
	Double Cut DC1 Double Cut	③ Top Wood Finish See Top Wood Finish Options				

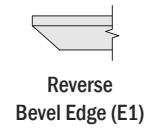
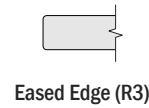
① Specialty Top Model #	② Top Surface Selection	③ Base Wood Species	④a Base Wood Finish	④b Base Paint	⑤ Metal Color	⑥ Electrical
Solid Surface (NAV)	See Solid Surface Top Surface Selection	Flat Cut B01 Black Oak CH1 Cherry MA1 Maple WA1 Walnut	See Wood Base Finish Options	See Base Paint Options	See Metal Color Options	Cutout Codes: N all tables C1M 72" - 120" wide C1C 72" - 120" wide C1O 120" wide C2M 96" - 120" wide C2C 96" - 120" wide C3M 120" wide C3C 120" wide C3MOM 120" wide
Glass Surface (NAV)	See Glass Top Surface Selection					
Wood Plank (NAV)	See Wood Plank Top Surface Selection					
Sub-Top w/Base (NAV)	B (Table Ships with Sub-Top, Customer applies custom Top)	Double Cut DC1 Double Cut				

Description

Square Table with X Base



Laminate Tops "NAT" Models



D	W	H	CTN WT	CU FT	① Model	HPL	HPL
60	60	29 3/8	176	63	NAT6060-30SQXB	\$2,929	\$3,356
54	54	29 3/8	149	59	NAT5454-30SQXB	\$2,737	\$3,163
48	48	29 3/8	123	41	NAT4848-30SQXB	\$2,611	\$3,037

Features:

- metal X-base
- glass top has additional seams

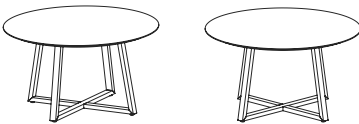
Options:

- worksurface power & storage available, specify cutout code and order power units separately, see pages [NA14-NA15](#)
- metal base frame available in powder coat, no upcharge, or chrome, add list upcharge: for 48" wide - \$1,660, for 54" wide - \$1,861, for 60" wide - \$1,918
- magnetic wire manager available; order separately, see page [NA124](#)

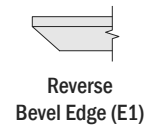
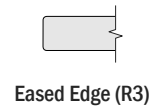
NATIVE

Description

Round Table with X Base



Laminate Tops "NAT" Models



D	W	H	CTN WT	CU FT	① Model	HPL	HPL
60	60	29 3/8	151	63	NAT6060-30RDXB	\$2,921	\$3,347
54	54	29 3/8	129	45	NAT5454-30RDXB	\$2,728	\$3,153
48	48	29 3/8	109	41	NAT4848-30RDXB	\$2,599	\$3,025

Features:

- metal X-base

Options:

- worksurface power & storage available, specify cutout code and order power units separately, see pages [NA14-NA15](#)
- metal base frame available in powder coat, no upcharge, or chrome, add list upcharge: for 48" wide - \$1,660, for 54" wide - \$1,861, for 60" wide - \$1,918
- magnetic wire manager available; order separately, see page [NA124](#)

To Order, Specify:

① Laminate Model #	② Top/Base Laminate	③ Top Edge	④ Metal Color	⑤ Electrical
Laminate (NAT)	See Top/Base Laminate Options	See Top Edge Options	Metal Color Options	Cutout Codes: N all tables C1M 48" - 60" wide C1C 48" - 60" wide See chart on page NA15 for cutout codes and power and storage unit configurations

Description

Square Table with X Base (continued)						Veneer Tops "NAV" Models				Premier Tops "NAV" Models			
						Eased Edge (R3)		Reverse Bevel Edge (E1)		Solid Surface/Glass Reverse Bevel Edge		Wood Plank Ash	
D	W	H	CTN WT	CU FT	1 Model	Flat Cut	Double Cut	Flat Cut	Double Cut	Solid Surface	Glass	Wood Plank Ash	Sub-Top with Base
60	60	29 3/8	176	63	NAV6060-30SQXB	\$4,021	\$4,512	\$4,186	\$4,677	\$10,153	\$9,305	--	\$3,841
54	54	29 3/8	149	59	NAV5454-30SQXB	\$3,777	\$4,179	\$3,940	\$4,344	\$8,827	\$8,056	--	\$3,606
48	48	29 3/8	123	41	NAV4848-30SQXB	\$3,627	\$3,952	\$3,790	\$4,114	\$7,706	\$7,008	\$6,030	\$3,463

Description

Round Table with X Base (continued)						Veneer Tops "NAV" Models				Premier Tops "NAV" Models			
						Eased Edge (R3)		Reverse Bevel Edge (E1)		Solid Surface/Glass Reverse Bevel Edge		Wood Plank Ash	
D	W	H	CTN WT	CU FT	1 Model	Flat Cut	Double Cut	Flat Cut	Double Cut	Solid Surface	Glass	Wood Plank Ash	Custom Sub-Base
60	60	29 3/8	151	63	NAV6060-30RDXB	\$4,005	\$4,498	\$4,170	\$4,663	\$10,138	\$9,292	--	\$3,827
54	54	29 3/8	129	45	NAV5454-30RDXB	\$3,764	\$4,169	\$3,929	\$4,334	\$8,817	\$8,047	--	\$3,596
48	48	29 3/8	109	41	NAV4848-30RDXB	\$3,608	\$3,933	\$3,772	\$4,099	\$7,690	\$6,994	\$6,013	\$3,448

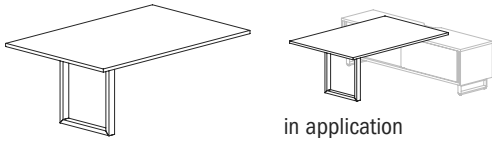
To Order, Specify:

1 Veneer Model #	2 Wood Species	3 Top Wood Finish	4 Top Edge	5 Metal Color	6 Electrical
Veneer (NAV)	Flat Cut B01 Black Oak CH1 Cherry MA1 Maple WA1 Walnut	See Flat Cut Top Wood Finish Options	See Top Edge Options	See Metal Color Options	Cutout Codes: N all tables C1M 48" - 60" wide C1C 48" - 60" wide See chart on page NA15 for cutout codes and power and storage unit configurations
	Double Cut DC1 Double Cut	3 Top Wood Finish See Double Cut Top Wood Finish Options			

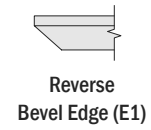
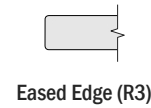
1 Specialty Top Model #	2 Top Surface Selection	3 Metal Color	4 Electrical
Solid Surface (NAV)	See Solid Surface Top Surface Selection	See Metal Color Options	Cutout Codes: N all tables C1M 48" - 60" wide C1C 48" - 60" wide See chart on page NA15 for cutout codes and power and storage unit configurations
Glass Surface (NAV)	See Glass Top Surface Selection		
Wood Plank (NAV)	See Wood Plank Top Surface Selection		
Sub-Top w/Base (NAV)	B (Table Ships with Sub-Top, Customer applies custom Top)		

Description

Rectangular Peninsula Table with Open Loop Base



Laminate Tops "NAT" Models



Features:

- must attach to 26" h Credenza, installation template included
- metal open loop base with structural support rails
- glass top has additional seams

Options:

- worksurface power & storage available, specify cutout code and order power units separately, see pages [NA14-NA15](#)
- metal base frame available in powder coat, no upcharge, or chrome, add list upcharge: for 36" wide - \$950, for 42" & 48 wide - \$1,100, for 54 wide - \$1,259
- magnetic wire manager available; order separately, see page [NA124](#)

D	W	H	CTN WT	CU FT	① Model	HPL	HPL
54	60	29 ³ / ₈	156	51	NAT5460-30TTPLB	\$3,024	\$3,450
48	84	29 ³ / ₈	186	47	NAT4884-30TTPLB	\$3,054	\$3,481
48	72	29 ³ / ₈	186	29	NAT4872-30TTPLB	\$2,982	\$3,406
48	60	29 ³ / ₈	129	37	NAT4860-30TTPLB	\$2,860	\$3,287
42	84	29 ³ / ₈	186	39	NAT4284-30TTPLB	\$3,001	\$3,428
42	72	29 ³ / ₈	151	42	NAT4272-30TTPLB	\$2,938	\$3,362
42	60	29 ³ / ₈	151	33	NAT4260-30TTPLB	\$2,798	\$3,224
36	84	29 ³ / ₈	149	42	NAT3684-30TTPLB	\$2,950	\$3,377
36	72	29 ³ / ₈	119	34	NAT3672-30TTPLB	\$2,891	\$3,318
36	60	29 ³ / ₈	114	42	NAT3660-30TTPLB	\$2,785	\$3,212

To Order, Specify:

① Laminate Model #	② Top/Base Laminate	③ Top Edge	④ Metal Color	⑤ Electrical
Laminate (NAT)	See Top/Base Laminate Options	See Top Edge Options	Metal Color Options	Cutout Codes: N all tables C1M 72" - 84" wide C1C 72" - 84" wide See chart on page NA15 for cutout codes and power and storage unit configurations

Description

Rectangular Peninsula Table
with Open Loop Base
(continued)

						Veneer Tops "NAV" Models				Premier Tops "NAV" Models			
						Eased Edge (R3)		Reverse Bevel Edge (E1)		Solid Surface/Glass Reverse Bevel Edge			
D	W	H	CTN WT	CU FT	① Model	Flat Cut	Double Cut	Flat Cut	Double Cut	Solid Surface	Glass	Wood Plank Ash	Sub-Top with Base
54	60	29 3/8	156	51	NAV5460-30TTPLB	\$3,598	\$4,080	\$3,763	\$4,244	\$9,592	\$8,356	--	\$3,437
48	84	29 3/8	186	47	NAV4884-30TTPLB	\$3,634	\$4,186	\$3,798	\$4,349	\$10,452	\$9,555	\$7,841	\$3,470
48	72	29 3/8	186	29	NAV4872-30TTPLB	\$3,547	\$4,022	\$3,711	\$4,187	\$9,454	\$8,622	\$7,154	\$3,388
48	60	29 3/8	129	37	NAV4860-30TTPLB	\$3,403	\$3,805	\$3,569	\$3,969	\$8,397	\$7,633	\$6,408	\$3,251
42	84	29 3/8	186	39	NAV4284-30TTPLB	\$3,572	\$4,058	\$3,737	\$4,222	\$9,593	\$8,754	\$7,254	\$3,413
42	72	29 3/8	151	42	NAV4272-30TTPLB	\$3,496	\$3,916	\$3,660	\$4,079	\$8,718	\$7,937	\$6,651	\$3,338
42	60	29 3/8	151	33	NAV4260-30TTPLB	\$3,330	\$3,682	\$3,494	\$3,846	\$7,753	\$7,030	\$5,958	\$3,181
36	84	29 3/8	149	42	NAV3684-30TTPLB	\$3,510	\$3,933	\$3,674	\$4,099	\$8,735	\$7,950	\$6,664	\$3,354
36	72	29 3/8	119	34	NAV3672-30TTPLB	\$3,441	\$3,806	\$3,606	\$3,970	\$7,981	\$7,248	\$6,147	\$3,288
36	60	29 3/8	114	42	NAV3660-30TTPLB	\$3,316	\$3,624	\$3,481	\$3,788	\$7,168	\$6,487	\$5,569	\$3,168

NATIVE

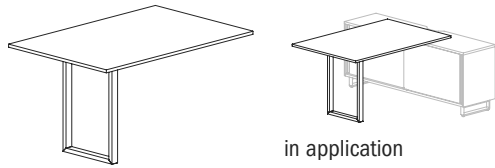
To Order, Specify:

① Veneer Model #	② Wood Species	③ Top Wood Finish	④ Top Edge	⑤ Metal Color	⑥ Electrical
Veneer (NAV)	Flat Cut B01 Black Oak CH1 Cherry MA1 Maple WA1 Walnut	See Flat Cut Top Wood Finish Options	See Top Edge Options	See Metal Color Options	Cutout Codes: N all tables C1M 72" - 84" wide C1C 72" - 84" wide See chart on page NA15 for cutout codes and power and storage unit configurations
	Double Cut DC1 Double Cut	③ Top Wood Finish See Double Cut Top Wood Finish Options			

① Specialty Top Model #	② Top Surface Selection	③ Metal Color	④ Electrical
Solid Surface (NAV)	See Solid Surface Top Surface Selection	See Metal Color Options	Cutout Codes: N all tables C1M 72" - 84" wide C1C 72" - 84" wide See chart on page NA15 for cutout codes and power and storage unit configurations
Glass Surface (NAV)	See Glass Top Surface Selection		
Wood Plank (NAV)	See Wood Plank Top Surface Selection		
Sub-Top w/Base (NAV)	B (Table Ships with Sub-Top, Customer applies custom Top)		

Description

Standing Height Rectangular Peninsula Table with Open Loop Base



in application

Features:

- must attach to 36" h Credenza, installation template included
- metal open loop base with structural support rails
- glass top has additional seams

Options:

- worksurface power & storage available, specify cutout code and order power units separately, see pages [NA14-NA15](#)
- metal base frame available in powder coat, no upcharge, or chrome, add list upcharge: for 36" wide - \$1,046, for 42" & 48" wide - \$1,210, for 54" wide - \$1,308
- magnetic wire manager available; order separately, see page [NA124](#)

Laminate Tops "NAT" Models



Eased Edge (R3)



Reverse Bevel Edge (E1)

D	W	H	CTN WT	CU FT	① Model	HPL	HPL
54	60	40	161	51	NAT5460-40TTPLB	\$2,988	\$3,416
48	84	40	192	47	NAT4884-40TTPLB	\$3,017	\$3,444
48	72	40	171	29	NAT4872-40TTPLB	\$2,946	\$3,371
48	60	40	147	36	NAT4860-40TTPLB	\$2,825	\$3,252
42	84	40	169	40	NAT4284-40TTPLB	\$2,966	\$3,393
42	72	40	156	53	NAT4272-40TTPLB	\$2,901	\$3,329
42	60	40	175	34	NAT4260-40TTPLB	\$2,791	\$3,218
36	84	40	155	34	NAT3684-40TTPLB	\$2,586	\$3,011
36	72	40	139	32	NAT3672-40TTPLB	\$2,858	\$3,285
36	60	40	119	35	NAT3660-40TTPLB	\$2,753	\$3,180

To Order, Specify:

① Laminate Model #	② Top/Base Laminate	③ Top Edge	④ Metal Color	⑤ Electrical
Laminate (NAT)	See Top/Base Laminate Options	See Top Edge Options	Metal Color Options	Cutout Codes: N all tables C1M 72" - 84" wide C1C 72" - 84" wide See chart on page NA15 for cutout codes and power and storage unit configurations

Description

Standing Height Rectangular Peninsula Table with Open Loop Base (continued)

						Veneer Tops "NAV" Models				Premier Tops "NAV" Models			
						Eased Edge (R3)		Reverse Bevel Edge (E1)		Solid Surface/Glass Reverse Bevel Edge			
D	W	H	CTN WT	CU FT	1 Model	Flat Cut	Double Cut	Flat Cut	Double Cut	Solid Surface	Glass	Wood Plank Ash	Sub-Top with Base
54	60	40	161	51	NAV5460-40TTPLB	\$3,598	\$4,080	\$3,763	\$4,244	\$9,592	\$8,356	--	\$3,437
48	84	40	192	47	NAV4884-40TTPLB	\$3,634	\$4,186	\$3,798	\$4,349	\$10,452	\$9,555	\$7,841	\$3,470
48	72	40	171	29	NAV4872-40TTPLB	\$3,547	\$4,022	\$3,711	\$4,187	\$9,454	\$8,622	\$7,154	\$3,388
48	60	40	147	36	NAV4860-40TTPLB	\$3,403	\$3,805	\$3,569	\$3,969	\$8,397	\$7,633	\$6,408	\$3,251
42	84	40	169	40	NAV4284-40TTPLB	\$3,572	\$4,058	\$3,737	\$4,222	\$9,593	\$8,754	\$7,254	\$3,413
42	72	40	156	53	NAV4272-40TTPLB	\$3,496	\$3,916	\$3,660	\$4,079	\$8,718	\$7,937	\$6,651	\$3,338
42	60	40	175	34	NAV4260-40TTPLB	\$3,360	\$3,715	\$3,525	\$3,878	\$7,785	\$7,061	\$5,991	\$3,211
36	84	40	155	34	NAV3684-40TTPLB	\$3,113	\$3,536	\$3,277	\$3,702	\$8,339	\$7,554	\$6,267	\$2,974
36	72	40	139	32	NAV3672-40TTPLB	\$3,441	\$3,806	\$3,606	\$3,970	\$7,981	\$7,248	\$6,147	\$3,288
36	60	40	119	35	NAV3660-40TTPLB	\$3,316	\$3,624	\$3,481	\$3,788	\$7,168	\$6,487	\$5,569	\$3,168

NATIVE

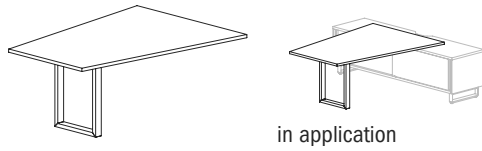
To Order, Specify:

1 Veneer Model #	2 Wood Species	3 Top Wood Finish	4 Top Edge	5 Metal Color	6 Electrical
Veneer (NAV)	Flat Cut B01 Black Oak CH1 Cherry MA1 Maple WA1 Walnut	See Flat Cut Top Wood Finish Options	See Top Edge Options	See Metal Color Options	Cutout Codes: N all tables C1M 72" - 84" wide C1C 72" - 84" wide See chart on page NA15 for cutout codes and power and storage unit configurations
	Double Cut DC1 Double Cut	3 Top Wood Finish See Double Cut Top Wood Finish Options			

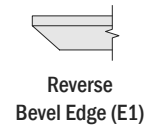
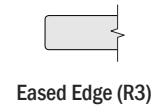
1 Specialty Top Model #	2 Top Surface Selection	3 Metal Color	4 Electrical
Solid Surface (NAV)	See Solid Surface Top Surface Selection	See Metal Color Options	Cutout Codes: N all tables C1M 72" - 84" wide C1C 72" - 84" wide See chart on page NA15 for cutout codes and power and storage unit configurations
Glass Surface (NAV)	See Glass Top Surface Selection		
Wood Plank (NAV)	See Wood Plank Top Surface Selection		
Sub-Top w/Base (NAV)	B (Table Ships with Sub-Top, Customer applies custom Top)		

Description

View Peninsula Table with Open Loop Base



Laminate Tops "NAT" Models



Features:

- must attach to 26" h Credenza, installation template included
- metal open loop base with structural support rails
- narrow end of table is 36" d
- glass top has additional seams

D	W	H	CTN WT	CU FT	① Model	HPL	HPL
54	84	29 3/8	175	52	NAT5484-30VTPLB	\$3,033	\$3,460
54	72	29 3/8	156	55	NAT5472-30VTPLB	\$2,950	\$3,377
54	60	29 3/8	138	51	NAT5460-30VTPLB	\$2,836	\$3,261

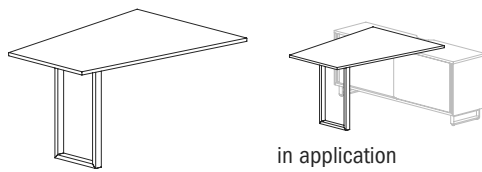
Options:

- metal base frame available in powder coat, no upcharge, or chrome, add \$1,259 list upcharge
- worksurface power & storage available, specify cutout code and order power units separately, see pages [NA14-NA15](#)
- magnetic wire manager available; order separately, see page [NA124](#)

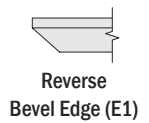
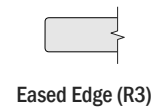
NATIVE

Description

Standing Height View Peninsula Table with Open Loop Base



Laminate Tops "NAT" Models



Features:

- must attach to 36" h Credenza, installation template included
- metal open loop base with structural support rails
- narrow end of table is 36" d
- glass top has additional seams

D	W	H	CTN WT	CU FT	① Model	HPL	HPL
54	84	40	181	52	NAT5484-40VTPLB	\$3,236	\$3,664
54	72	40	161	55	NAT5472-40VTPLB	\$3,155	\$3,582
54	60	40	139	51	NAT5460-40VTPLB	\$3,072	\$3,498

Options:

- metal base frame available in powder coat, no upcharge, or chrome, add \$1,308 list upcharge
- worksurface power & storage available, specify cutout code and order power units separately, see pages [NA14-NA15](#)
- magnetic wire manager available; order separately, see page [NA124](#)

To Order, Specify:

① Laminate Model #	② Top/Base Laminate	③ Top Edge	④ Metal Color	⑤ Electrical
Laminate (NAT)	See Top/Base Laminate Options	See Top Edge Options	Metal Color Options	Cutout Codes: N all tables C1M 72" - 84" wide C1C 72" - 84" wide See chart on page NA15 for cutout codes and power and storage unit configurations

Description

View Peninsula Table with Open Loop Base
(continued)

						Veneer Tops "NAV" Models				Premier Tops "NAV" Models			
						Eased Edge (R3)		Reverse Bevel Edge (E1)		Solid Surface/Glass Reverse Bevel Edge			
D	W	H	CTN WT	CU FT	1 Model	Flat Cut	Double Cut	Flat Cut	Double Cut	Solid Surface	Glass	Wood Plank Ash	Sub-Top with Base
54	84	29 3/8	175	52	NAV5484-30VTPLB	\$3,610	\$4,231	\$3,776	\$4,397	\$11,282	\$10,271	--	\$3,449
54	72	29 3/8	156	55	NAV5472-30VTPLB	\$3,511	\$4,066	\$3,676	\$4,230	\$10,403	\$9,221	--	\$3,355
54	60	29 3/8	138	51	NAV5460-30VTPLB	\$3,374	\$3,856	\$3,537	\$4,021	\$9,368	\$8,131	--	\$3,223

Description

Standing Height View Peninsula Table with Open Loop Base
(continued)

						Veneer Tops "NAV" Models				Premier Tops "NAV" Models			
						Eased Edge (R3)		Reverse Bevel Edge (E1)		Solid Surface/Glass Reverse Bevel Edge			
D	W	H	CTN WT	CU FT	1 Model	Flat Cut	Double Cut	Flat Cut	Double Cut	Solid Surface	Glass	Wood Plank Ash	Sub-Top with Base
54	84	40	181	52	NAV5484-40VTPLB	\$3,853	\$4,474	\$4,018	\$4,639	\$11,525	\$10,513	--	\$3,680
54	72	40	161	55	NAV5472-40VTPLB	\$3,755	\$4,308	\$3,919	\$4,473	\$10,645	\$9,463	--	\$3,586
54	60	40	139	51	NAV5460-40VTPLB	\$3,656	\$4,137	\$3,821	\$4,301	\$9,651	\$8,413	--	\$3,492

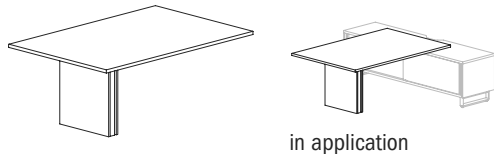
To Order, Specify:

1 Veneer Model #	2 Wood Species	3 Top Wood Finish	4 Base Finish	5 Top Edge	6 Metal Color	7 Electrical
Veneer (NAV)	Flat Cut B01 Black Oak CH1 Cherry MA1 Maple WA1 Walnut	See Top Wood Finish Options	See Base Finish Options	See Top Edge Options	See Metal Color Options	Cutout Codes: N all tables C1M 72" - 84"w C1C 72" - 84"w See chart on page NA15 for cutout codes and power and storage unit configurations
	Double Cut DC1 Double Cut	3 Top Wood Finish See Top Wood Finish Options				

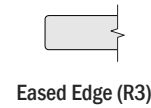
1 Specialty Top Model #	2 Top Surface Selection	3 Base Wood Species	4a Base Wood Finish	4b Base Paint	5 Metal Color	6 Electrical
Solid Surface (NAV)	See Solid Surface Top Surface Selection	Flat Cut B01 Black Oak CH1 Cherry MA1 Maple WA1 Walnut	See Wood Base Finish Options	See Base Paint Options	See Metal Color Options	Cutout Codes: N all tables C1M 72" - 84"w C1C 72" - 84"w See chart on page NA15 for cutout codes and power and storage unit configurations
Glass Surface (NAV)	See Glass Top Surface Selection					
Wood Plank (NAV)	See Wood Plank Top Surface Selection					
Sub-Top w/Base (NAV)	B (Table Ships with Sub-Top, Customer applies custom Top)	Double Cut DC1 Double Cut				

Description

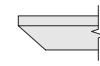
Rectangular Peninsula Table with Panel Base



Laminate Tops "NAT" Models



Eased Edge (R3)



Reverse Bevel Edge (E1)

Features:

- must attach to 26" h Credenza, installation template included
- panel base with structural support rails
- glass top has additional seams

Options:

- metal base frame available in powder coat, no upcharge, or chrome, add list upcharge: for 36" wide - \$950, for 42" & 48 wide - \$1,100, for 54 wide - \$1,259
- worksurface power & storage available, specify cutout code and order power units separately, see pages [NA14-NA15](#)

D	W	H	CTN WT	CU FT	① Model	HPL	HPL
54	60	29 ³ / ₈	180	55	NAT5460-30TTPPB	\$3,246	\$3,671
48	84	29 ³ / ₈	207	47	NAT4884-30TTPPB	\$3,268	\$3,694
48	72	29 ³ / ₈	207	40	NAT4872-30TTPPB	\$3,196	\$3,621
48	60	29 ³ / ₈	161	37	NAT4860-30TTPPB	\$3,381	\$3,806
42	84	29 ³ / ₈	190	39	NAT4284-30TTPPB	\$3,218	\$3,642
42	72	29 ³ / ₈	156	38	NAT4272-30TTPPB	\$3,152	\$3,579
42	60	29 ³ / ₈	149	33	NAT4260-30TTPPB	\$3,041	\$3,467
36	84	29 ³ / ₈	167	42	NAT3684-30TTPPB	\$2,818	\$3,246
36	72	29 ³ / ₈	151	34	NAT3672-30TTPPB	\$3,091	\$3,518
36	60	29 ³ / ₈	131	42	NAT3660-30TTPPB	\$2,961	\$3,386

To Order, Specify:

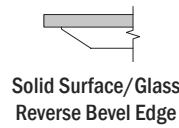
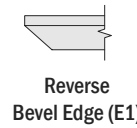
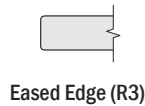
① Laminate Model #	② Top/Base Laminate	③ Top Edge	④ Metal Color	⑤ Electrical
Laminate (NAT)	See Top/Base Laminate Options	See Top Edge Options	Metal Color Options	Cutout Codes: N all tables C1M 72" - 84" wide C1C 72" - 84" wide See chart on page NA15 for cutout codes and power and storage unit configurations

Description

Rectangular Peninsula Table with Panel Base
(continued)

Veneer Tops "NAV" Models

Premier Tops "NAV" Models



D	W	H	CTN WT	CU FT	① Model	Veneer Tops "NAV" Models		Premier Tops "NAV" Models					
						Flat Cut	Double Cut	Flat Cut	Double Cut	Solid Surface	Glass	Wood Plank Ash	Sub-Top with Base
54	60	29 3/8	180	55	NAV5460-30TTPPB	\$3,908	\$4,519	\$4,072	\$4,684	\$9,902	\$8,665	--	\$3,734
48	84	29 3/8	207	47	NAV4884-30TTPPB	\$3,934	\$4,576	\$4,100	\$4,741	\$10,754	\$9,855	\$8,142	\$3,759
48	72	29 3/8	207	40	NAV4872-30TTPPB	\$3,850	\$4,476	\$4,013	\$4,641	\$9,756	\$8,923	\$7,455	\$3,677
48	60	29 3/8	161	37	NAV4860-30TTPPB	\$4,070	\$4,735	\$4,236	\$4,899	\$9,063	\$8,300	\$7,075	\$3,889
42	84	29 3/8	190	39	NAV4284-30TTPPB	\$3,875	\$4,506	\$4,039	\$4,671	\$9,897	\$9,055	\$7,555	\$3,702
42	72	29 3/8	156	38	NAV4272-30TTPPB	\$3,797	\$4,417	\$3,962	\$4,580	\$9,019	\$8,238	\$6,952	\$3,628
42	60	29 3/8	149	33	NAV4260-30TTPPB	\$3,662	\$4,258	\$3,827	\$4,424	\$8,086	\$7,363	\$6,291	\$3,498
36	84	29 3/8	167	42	NAV3684-30TTPPB	\$3,394	\$3,948	\$3,558	\$4,112	\$8,620	\$7,836	\$6,549	\$3,244
36	72	29 3/8	151	34	NAV3672-30TTPPB	\$3,722	\$4,329	\$3,888	\$4,494	\$8,262	\$7,529	\$6,427	\$3,556
36	60	29 3/8	131	42	NAV3660-30TTPPB	\$3,566	\$4,147	\$3,731	\$4,313	\$7,418	\$6,737	\$5,819	\$3,406

NATIVE

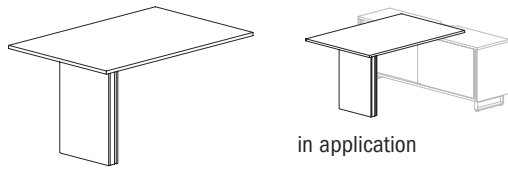
To Order, Specify:

① Veneer Model #	② Wood Species	③ Top Wood Finish	④ Base Finish	⑤ Top Edge	⑥ Metal Color	⑦ Electrical
Veneer (NAV)	Flat Cut B01 Black Oak CH1 Cherry MA1 Maple WA1 Walnut	See Top Wood Finish Options	See Base Finish Options	See Top Edge Options	See Metal Color Options	Cutout Codes: N all tables C1M 72" - 84"w C1C 72" - 84"w See chart on page NA15 for cutout codes and power and storage unit configurations
	Double Cut DC1 Double Cut	Top Wood Finish See Top Wood Finish Options				

① Specialty Top Model #	② Top Surface Selection	③ Base Wood Species	④a Base Wood Finish	④b Base Paint	⑤ Metal Color	⑥ Electrical
Solid Surface (NAV)	See Solid Surface Top Surface Selection	Flat Cut B01 Black Oak CH1 Cherry MA1 Maple WA1 Walnut	See Wood Base Finish Options	See Base Paint Options	See Metal Color Options	Cutout Codes: N all tables C1M 72" - 84"w C1C 72" - 84"w See chart on page NA15 for cutout codes and power and storage unit configurations
Glass Surface (NAV)	See Glass Top Surface Selection					
Wood Plank (NAV)	See Wood Plank Top Surface Selection					
Sub-Top w/Base (NAV)	B (Table Ships with Sub-Top, Customer applies custom Top)	Double Cut DC1 Double Cut				

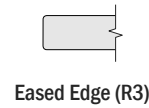
Description

Standing Height Rectangular Peninsula Table with Panel Base



in application

Laminate Tops "NAT" Models



Eased Edge (R3)



Reverse Bevel Edge (E1)

Features:

- must attach to 36" h Credenza, installation template included
- panel base with structural support rails
- glass top has additional seams

Options:

- metal base frame available in powder coat, no upcharge, or chrome, add list upcharge: for 36" wide - \$1,046, for 42" & 48 wide - \$1,210, for 54 wide - \$1,308
- worksurface power & storage available, specify cutout code and order power units separately, see pages [NA14-NA15](#)

D	W	H	CTN WT	CU FT	① Model	HPL	HPL
54	60	40	198	55	NAT5460-40TTPPB	\$3,313	\$3,740
48	84	40	206	48	NAT4884-40TTPPB	\$3,293	\$3,719
48	72	40	202	40	NAT4872-40TTPPB	\$3,221	\$3,647
48	60	40	178	36	NAT4860-40TTPPB	\$3,102	\$3,530
42	84	40	206	40	NAT4284-40TTPPB	\$3,244	\$3,669
42	72	40	187	42	NAT4272-40TTPPB	\$3,177	\$3,603
42	60	40	165	34	NAT4260-40TTPPB	\$3,064	\$3,492
36	84	40	181	34	NAT3684-40TTPPB	\$3,168	\$3,594
36	72	40	165	38	NAT3672-40TTPPB	\$3,111	\$3,536
36	60	40	146	35	NAT3660-40TTPPB	\$3,007	\$3,432

NATIVE

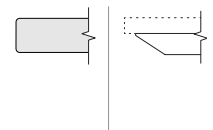
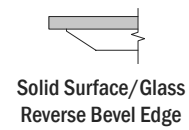
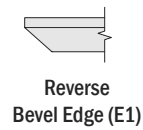
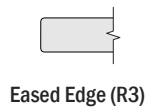
To Order, Specify:

① Laminate Model #	② Top/Base Laminate	③ Top Edge	④ Metal Color	⑤ Electrical
Laminate (NAT)	See Top/Base Laminate Options	See Top Edge Options	Metal Color Options	Cutout Codes: N all tables C1M 72" - 84" wide C1C 72" - 84" wide See chart on page NA15 for cutout codes and power and storage unit configurations

Description

Standing Height Rectangular Peninsula Table with Panel Base (continued)

Veneer Tops "NAV" Models Premier Tops "NAV" Models



D	W	H	CTN WT	CU FT	① Model	Eased Edge (R3)		Reverse Bevel Edge (E1)		Solid Surface/Glass Reverse Bevel Edge		Wood Plank Ash	Sub-Top with Base
						Flat Cut	Double Cut	Flat Cut	Double Cut	Solid Surface	Glass		
54	60	40	198	55	NAV5460-40TTPPB	\$3,992	\$4,614	\$4,155	\$4,778	\$9,985	\$8,748	--	\$3,811
48	84	40	206	48	NAV4884-40TTPPB	\$3,965	\$4,612	\$4,130	\$4,776	\$10,785	\$9,887	\$8,173	\$3,788
48	72	40	202	40	NAV4872-40TTPPB	\$3,879	\$4,512	\$4,043	\$4,677	\$9,786	\$8,954	\$7,485	\$3,706
48	60	40	178	36	NAV4860-40TTPPB	\$3,739	\$4,348	\$3,902	\$4,512	\$8,731	\$7,967	\$6,743	\$3,571
42	84	40	206	40	NAV4284-40TTPPB	\$3,905	\$4,541	\$4,069	\$4,707	\$9,927	\$9,085	\$7,584	\$3,731
42	72	40	187	42	NAV4272-40TTPPB	\$3,827	\$4,450	\$3,992	\$4,614	\$9,049	\$8,267	\$6,981	\$3,655
42	60	40	165	34	NAV4260-40TTPPB	\$3,693	\$4,294	\$3,857	\$4,460	\$8,115	\$7,393	\$6,322	\$3,528
36	84	40	181	34	NAV3684-40TTPPB	\$3,816	\$4,437	\$3,979	\$4,602	\$9,041	\$8,257	\$6,970	\$3,643
36	72	40	165	38	NAV3672-40TTPPB	\$3,747	\$4,358	\$3,911	\$4,523	\$8,287	\$7,553	\$6,451	\$3,579
36	60	40	146	35	NAV3660-40TTPPB	\$3,620	\$4,211	\$3,785	\$4,375	\$7,473	\$6,792	\$5,875	\$3,459

NATIVE

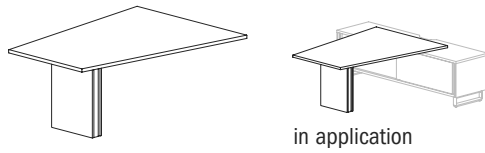
To Order, Specify:

① Veneer Model #	② Wood Species	③ Top Wood Finish	④ Base Finish	⑤ Top Edge	⑥ Metal Color	⑦ Electrical
Veneer (NAV)	Flat Cut B01 Black Oak CH1 Cherry MA1 Maple WA1 Walnut	See Top Wood Finish Options	See Base Finish Options	See Top Edge Options	See Metal Color Options	Cutout Codes: N all tables C1M 72" - 84"w C1C 72" - 84"w See chart on page NA15 for cutout codes and power and storage unit configurations
	Double Cut DC1 Double Cut	Top Wood Finish See Top Wood Finish Options				

① Specialty Top Model #	② Top Surface Selection	③ Base Wood Species	4a Base Wood Finish	4b Base Paint	⑤ Metal Color	⑥ Electrical
Solid Surface (NAV)	See Solid Surface Top Surface Selection	Flat Cut B01 Black Oak CH1 Cherry MA1 Maple WA1 Walnut	See Wood Base Finish Options	See Base Paint Options	See Metal Color Options	Cutout Codes: N all tables C1M 72" - 84"w C1C 72" - 84"w See chart on page NA15 for cutout codes and power and storage unit configurations
Glass Surface (NAV)	See Glass Top Surface Selection					
Wood Plank (NAV)	See Wood Plank Top Surface Selection					
Sub-Top w/Base (NAV)	B (Table Ships with Sub-Top, Customer applies custom Top)	Double Cut DC1 Double Cut				

Description

View Peninsula Table with Panel Base



in application

Features:

- must attach to 26" h Credenza, installation template included
- panel base with structural support rails
- narrow end of table is 36" d
- glass top has additional seams

Options:

- metal base frame available in powder coat, no upcharge, or chrome, add \$1,259 list upcharge for 54" wide
- worksurface power & storage available, specify cutout code and order power units separately, see pages [NA14-NA15](#)

Laminate Tops "NAT" Models



Eased Edge (R3)



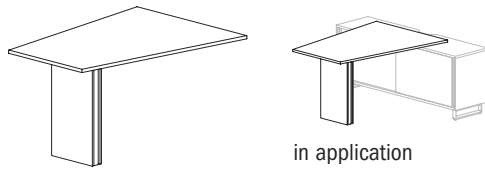
Reverse Bevel Edge (E1)

D	W	H	CTN WT	CU FT	① Model	HPL	HPL
54	84	29 3/8	192	55	NAT5484-30VTPPB	\$3,256	\$3,682
54	72	29 3/8	173	59	NAT5472-30VTPPB	\$3,175	\$3,599
54	60	29 3/8	150	55	NAT5460-30VTPPB	\$3,046	\$3,470

NATIVE

Description

Standing Height View Peninsula Table with Panel Base



in application

Features:

- must attach to 36" h Credenza, installation template included
- panel base with structural support rails
- narrow end of table is 36" d
- glass top has additional seams

Options:

- metal base frame available in powder coat, no upcharge, or chrome, add \$1,308 list upcharge for 54" wide
- worksurface power & storage available, specify cutout code and order power units separately, see pages [NA14-NA15](#)

Laminate Tops "NAT" Models



Eased Edge (R3)



Reverse Bevel Edge (E1)

D	W	H	CTN WT	CU FT	① Model	HPL	HPL
54	84	40	207	55	NAT5484-40VTPPB	\$3,476	\$3,902
54	72	40	187	59	NAT5472-40VTPPB	\$3,381	\$3,806
54	60	40	187	55	NAT5460-40VTPPB	\$3,263	\$3,690

To Order, Specify:

① Laminate Model #	② Top/Base Laminate	③ Top Edge	④ Metal Color	⑤ Electrical
Laminate (NAT)	See Top/Base Laminate Options	See Top Edge Options	Metal Color Options	Cutout Codes: N all tables C1M 72" - 84" wide C1C 72" - 84" wide See chart on page NA15 for cutout codes and power and storage unit configurations

Description

View Peninsula Table with Panel Base (continued)						Veneer Tops "NAV" Models				Premier Tops "NAV" Models			
						Eased Edge (R3)		Reverse Bevel Edge (E1)		Solid Surface/Glass Reverse Bevel Edge			
D	W	H	CTN WT	CU FT	① Model	Flat Cut	Double Cut	Flat Cut	Double Cut	Solid Surface	Glass	Wood Plank Ash	Sub-Top with Base
54	84	29 3/8	192	55	NAV5484-30VTPPB	\$3,922	\$4,536	\$4,087	\$4,701	\$11,593	\$10,583	--	\$3,747
54	72	29 3/8	173	59	NAV5472-30VTPPB	\$3,823	\$4,419	\$3,989	\$4,583	\$10,713	\$9,531	--	\$3,653
54	60	29 3/8	150	55	NAV5460-30VTPPB	\$3,668	\$4,240	\$3,831	\$4,404	\$9,661	\$8,423	--	\$3,503

Description

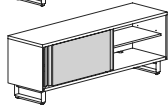
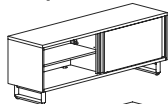
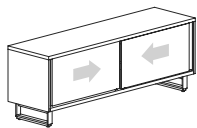
Standing Height View Peninsula Table with Panel Base (continued)						Veneer Tops "NAV" Models				Premier Tops "NAV" Models			
						Eased Edge (R3)		Reverse Bevel Edge (E1)		Solid Surface/Glass Reverse Bevel Edge			
D	W	H	CTN WT	CU FT	① Model	Flat Cut	Double Cut	Flat Cut	Double Cut	Solid Surface	Glass	Wood Plank Ash	Sub-Top with Base
54	84	40	207	55	NAV5484-40VTPPB	\$4,188	\$4,840	\$4,351	\$5,006	\$11,859	\$10,847	--	\$4,000
54	72	40	187	59	NAV5472-40VTPPB	\$4,071	\$4,708	\$4,237	\$4,872	\$10,964	\$9,780	--	\$3,890
54	60	40	187	55	NAV5460-40VTPPB	\$3,931	\$4,546	\$4,096	\$4,710	\$9,926	\$8,688	--	\$3,756

To Order, Specify:

① Veneer Model #	② Wood Species	③ Top Wood Finish	④ Base Finish	⑤ Top Edge	⑥ Metal Color	⑦ Electrical
Veneer (NAV)	Flat Cut B01 Black Oak CH1 Cherry MA1 Maple WA1 Walnut	See Top Wood Finish Options	See Base Finish Options	See Top Edge Options	See Metal Color Options	Cutout Codes: N all tables C1M 72" - 84"w C1C 72" - 84"w See chart on page NA15 for cutout codes and power and storage unit configurations
	Double Cut DC1 Double Cut	③ Top Wood Finish See Top Wood Finish Options				

① Specialty Top Model #	② Top Surface Selection	③ Base Wood Species	4a Base Wood Finish	4b Base Paint	⑤ Metal Color	⑥ Electrical
Solid Surface (NAV)	See Solid Surface Top Surface Selection	Flat Cut B01 Black Oak CH1 Cherry MA1 Maple WA1 Walnut	See Wood Base Finish Options	See Base Paint Options	See Metal Color Options	Cutout Codes: N all tables C1M 72" - 84"w C1C 72" - 84"w See chart on page NA15 for cutout codes and power and storage unit configurations
Glass Surface (NAV)	See Glass Top Surface Selection					
Wood Plank (NAV)	See Wood Plank Top Surface Selection					
Sub-Top w/Base (NAV)	B (Table Ships with Sub-Top, Customer applies custom Top)	Double Cut DC1 Double Cut				

Description	D	W	H	CTN WT	CU FT	① Model	Laminate	Flat Cut Veneer	Double Cut Veneer
Storage Credenza	20	90	26	293	31	NAT2090-26SCD	\$4,302		
	20	90	26	293	31	NAV2090-26SCD		\$5,279	\$6,139
	20	72	26	228	25	NAT2072-26SCD	\$4,113		
	20	72	26	228	25	NAV2072-26SCD		\$5,046	\$5,868



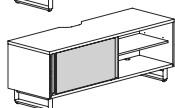
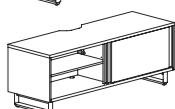
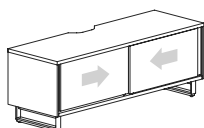
Features:

- sliding doors (non-locking)
- each compartment has one adjustable shelf

Options:

- metal available in powder coat, no upcharge, or chrome, add \$1,709 list upcharge
- laminate doors available in contrasting color, no upcharge, specify color; see page [NA9](#) for details
- veneer doors available in contrasting paint color, no upcharge, specify paint color; see page [NA9](#) for details

Power Storage Credenza	24	90	26	323	39	NAT2490-26PCD	\$5,181		
	24	90	26	323	39	NAV2490-26PCD		\$6,267	\$7,082
	24	72	26	253	32	NAT2472-26PCD	\$4,951		
	24	72	26	253	32	NAV2472-26PCD		\$6,001	\$6,785



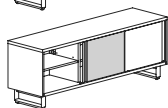
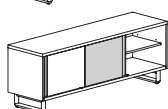
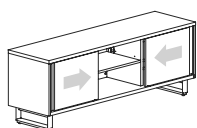
Features:

- sliding doors (non-locking)
- each compartment has one adjustable shelf
- power unit recessed in worksurface - ships installed

Options:

- metal available in powder coat, no upcharge, or chrome, add \$1,709 list upcharge
- laminate doors available in contrasting color, no upcharge, specify color; see page [NA9](#) for details
- veneer doors available in contrasting paint color, no upcharge, specify paint color; see page [NA9](#) for details

Open Storage Credenza	20	90	26	293	31	NAT2090-26SCO	\$4,357		
	20	90	26	293	31	NAV2090-26SCO		\$5,345	\$6,215
	20	72	26	228	25	NAT2072-26SCO	\$4,198		
	20	72	26	228	25	NAV2072-26SCO		\$5,148	\$5,988



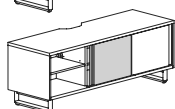
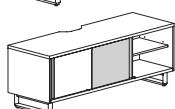
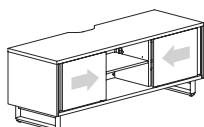
Features:

- sliding doors (non-locking) with open center compartment
- each compartment has one adjustable shelf

Options:

- metal available in powder coat, no upcharge, or chrome, add \$1,709 list upcharge
- laminate doors available in contrasting color, no upcharge, specify color; see page [NA9](#) for details
- veneer doors available in contrasting paint color, no upcharge, specify paint color; see page [NA9](#) for details

Power Open Storage Credenza	24	90	26	304	39	NAT2490-26PCO	\$5,160		
	24	90	26	304	39	NAV2490-26PCO		\$6,255	\$7,071
	24	72	26	253	32	NAT2472-26PCO	\$5,040		
	24	72	26	253	32	NAV2472-26PCO		\$6,107	\$6,905



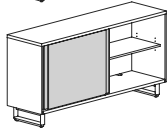
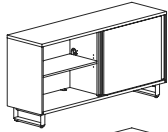
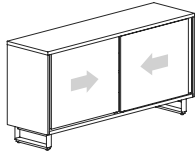
Features:

- sliding doors (non-locking) with open center compartment
- each compartment has one adjustable shelf
- power unit recessed in worksurface - ships installed

Options:

- metal available in powder coat, no upcharge, or chrome, add \$1,709 list upcharge
- laminate doors available in contrasting color, no upcharge, specify color; see page [NA9](#) for details
- veneer doors available in contrasting paint color, no upcharge, specify paint color; see page [NA9](#) for details

Description	D	W	H	CTN WT	CU FT	① Model	Laminate	Flat Cut Veneer	Double Cut Veneer
Buffet Credenza	20	90	36	346	45	NAT2090-36SCD	\$4,500		
	20	90	36	346	45	NAV2090-36SCD		\$5,485	\$6,381
	20	72	36	273	36	NAT2072-36SCD	\$4,266		
	20	72	36	273	36	NAV2072-36SCD		\$5,234	\$6,087



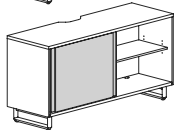
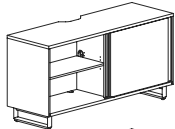
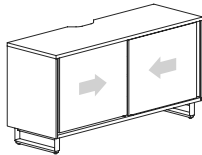
Features:

- sliding doors (non-locking)
- each compartment has one adjustable shelf

Options:

- metal available in powder coat, no upcharge, or chrome, add \$1,709 list upcharge
- laminate doors available in contrasting color, no upcharge, specify color; see page NA9 for details
- veneer doors available in contrasting paint color, no upcharge, specify paint color; see page NA9 for details

Description	D	W	H	CTN WT	CU FT	① Model	Laminate	Flat Cut Veneer	Double Cut Veneer
Power Buffet Credenza	24	90	36	378	49	NAT2490-36PCD	\$5,328		
	24	90	36	378	49	NAV2490-36PCD		\$6,459	\$7,300
	24	72	36	300	41	NAT2472-36PCD	\$5,112		
	24	72	36	300	41	NAV2472-36PCD		\$6,194	\$7,003



Features:

- sliding doors (non-locking)
- each compartment has one adjustable shelf
- power unit recessed in worksurface - ships installed

Options:

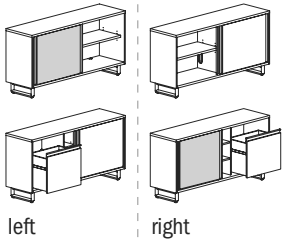
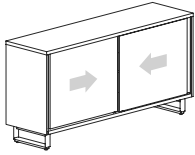
- metal available in powder coat, no upcharge, or chrome, add \$1,709 list upcharge
- laminate doors available in contrasting color, no upcharge, specify color; see page NA9 for details
- veneer doors available in contrasting paint color, no upcharge, specify paint color; see page NA9 for details

To Order, Specify:

① Laminate Model #	② Chassis/Door Front Laminate	③ Metal Color
Laminate (NAT)	See Chassis/Door Front Laminate Options	See Metal Color Options

① Veneer Model #	② Wood Species	③ Chassis Finish - Top	④ Door Front Paint	⑤ Metal Color
Veneer (NAV)	Flat Cut B01 Black Oak CH1 Cherry MA1 Maple WA1 Walnut	See Flat Cut Chassis - Top Finish Options	See Door Front Paint Color Options	See Metal Color Options
	Double Cut DC1 Double Cut	③ Wood Finish - Top See Double Cut Top Finish Options		

Description	D	W	H	CTN WT	CU FT	① Model	Laminate	Flat Cut Veneer	Double Cut Veneer
Buffet Credenza with Waste Drawer	20	90	36	380	45	NAT2090-36SCWR	\$5,459		
	20	90	36	380	45	NAV2090-36SCWR		\$6,657	\$7,741
	20	90	36	380	45	NAT2090-36SCWL	\$5,459		
	20	90	36	380	45	NAV2090-36SCWL		\$6,657	\$7,741
	20	72	36	314	36	NAT2072-36SCWR	\$5,429		
	20	72	36	314	36	NAV2072-36SCWR		\$6,619	\$7,698
	20	72	36	314	36	NAT2072-36SCWL	\$5,429		
	20	72	36	314	36	NAV2072-36SCWL		\$6,619	\$7,698



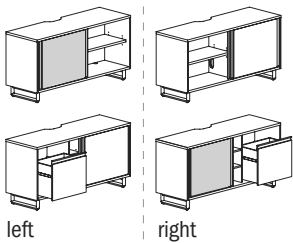
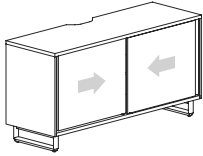
Features:

- sliding doors (non-locking)
- one side has one adjustable shelf, other side has waste drawer and cubbies (cubbies partially covered by door)
- waste drawer accommodates two Uline #S-13527 (10 gallon) trash cans, not included

Options:

- metal available in powder coat, no upcharge, or chrome, add \$1,709 list upcharge
- laminate doors available in contrasting color, no upcharge, specify color; see page [NA9](#) for details
- veneer doors available in contrasting paint color, no upcharge, specify paint color; see page [NA9](#) for details

Power Buffet Credenza with Waste Drawer	24	90	36	412	49	NAT2490-36PCWR	\$6,447		
	24	90	36	412	49	NAV2490-36PCWR		\$7,812	\$8,832
	24	90	36	412	49	NAT2490-36PCWL	\$6,447		
	24	90	36	412	49	NAV2490-36PCWL		\$7,812	\$8,832
	24	72	36	342	41	NAT2472-36PCWR	\$5,995		
	24	72	36	342	41	NAV2472-36PCWR		\$7,266	\$8,215
	24	72	36	342	41	NAT2472-36PCWL	\$5,995		
	24	72	36	342	41	NAV2472-36PCWL		\$7,266	\$8,215



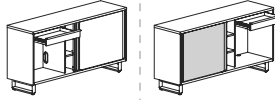
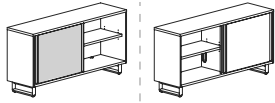
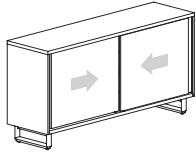
Features:

- sliding doors (non-locking)
- one side has one adjustable shelf, other side has waste drawer and cubbies (cubbies partially covered by door)
- waste drawer accommodates two Uline #S-13527 (10 gallon) trash cans, not included
- power unit recessed in worksurface - ships installed

Options:

- metal available in powder coat, no upcharge, or chrome, add \$1,709 list upcharge
- laminate doors available in contrasting color, no upcharge, specify color; see page [NA9](#) for details
- veneer doors available in contrasting paint color, no upcharge, specify paint color; see page [NA9](#) for details

Description	D	W	H	CTN WT	CU FT	1 Model	Laminate	Flat Cut Veneer	Double Cut Veneer
Buffet Credenza with Utility Drawer	20	90	36	344	45	NAT2090-36SCUR	\$5,176		
	20	90	36	344	45	NAV2090-36SCUR		\$6,312	\$7,341
	20	90	36	344	45	NAT2090-36SCUL	\$5,176		
	20	90	36	344	45	NAV2090-36SCUL		\$6,312	\$7,341
	20	72	36	284	36	NAT2072-36SCUR	\$4,976		
	20	72	36	284	36	NAV2072-36SCUR		\$6,067	\$7,057
	20	72	36	284	36	NAT2072-36SCUL	\$4,976		
	20	72	36	284	36	NAV2072-36SCUL		\$6,067	\$7,057



left right

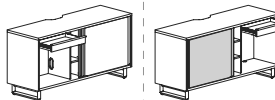
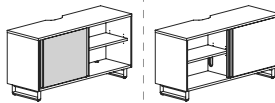
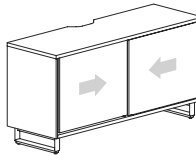
Features:

- sliding doors (non-locking)
- one side has one adjustable shelf, other side has utility drawer and cubbies (cubbies partially covered by door)

Options:

- metal available in powder coat, no upcharge, or chrome, add \$1,709 list upcharge
- laminate doors available in contrasting color, no upcharge, specify color; see page NA9 for details
- veneer doors available in contrasting paint color, no upcharge, specify paint color; see page NA9 for details

Description	D	W	H	CTN WT	CU FT	1 Model	Laminate	Flat Cut Veneer	Double Cut Veneer
Power Buffet Credenza with Utility Drawer	24	90	36	376	49	NAT2490-36PCUR	\$6,023		
	24	90	36	376	49	NAV2490-36PCUR		\$7,300	\$8,252
	24	90	36	376	49	NAT2490-36PCUL	\$6,023		
	24	90	36	376	49	NAV2490-36PCUL		\$7,300	\$8,252
	24	72	36	306	41	NAT2472-36PCUR	\$5,710		
	24	72	36	306	41	NAV2472-36PCUR		\$6,919	\$7,821
	24	72	36	306	41	NAT2472-36PCUL	\$5,710		
	24	72	36	306	41	NAV2472-36PCUL		\$6,919	\$7,821



left right

Features:

- sliding doors (non-locking)
- one side has one adjustable shelf, other side has utility drawer and cubbies (cubbies partially covered by door)
- power unit recessed in worksurface - ships installed

Options:

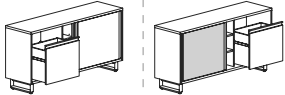
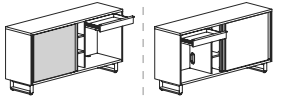
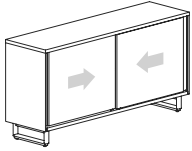
- metal available in powder coat, no upcharge, or chrome, add \$1,709 list upcharge
- laminate doors available in contrasting color, no upcharge, specify color; see page NA9 for details
- veneer doors available in contrasting paint color, no upcharge, specify paint color; see page NA9 for details

To Order, Specify:

1 Laminate Model #	2 Chassis/Door Front Laminate	3 Metal Color
Laminate (NAT)	See Chassis/Door Front Laminate Options	See Metal Color Options

1 Veneer Model #	2 Wood Species	3 Chassis Finish - Top	4 Door Front Paint	5 Metal Color
Veneer (NAV)	Flat Cut B01 Black Oak CH1 Cherry MA1 Maple WA1 Walnut	See Flat Cut Chassis - Top Finish Options	See Door Front Paint Color Options	See Metal Color Options
	Double Cut DC1 Double Cut	3 Wood Finish - Top See Double Cut Top Finish Options		

Description	D	W	H	CTN WT	CU FT	① Model	Laminate	Flat Cut Veneer	Double Cut Veneer
Buffet Credenza with Utility Drawer and Waste Drawer	20	90	36	389	50	NAT2090-36SCULWR	\$5,807		
	20	90	36	389	50	NAV2090-36SCULWR		\$7,168	\$8,105
	20	90	36	389	50	NAT2090-36SCURWL	\$5,807		
	20	90	36	389	50	NAV2090-36SCURWL		\$7,168	\$8,105
	20	72	36	314	40	NAT2072-36SCULWR	\$5,654		
	20	72	36	314	40	NAV2072-36SCULWR		\$6,980	\$7,891
	20	72	36	314	40	NAT2072-36SCURWL	\$5,654		
	20	72	36	314	40	NAV2072-36SCURWL		\$6,980	\$7,891



left

right

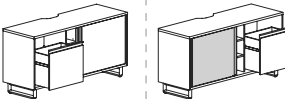
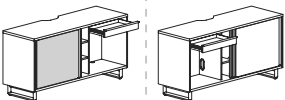
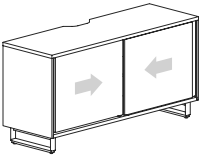
Features:

- sliding doors (non-locking)
- one side has utility drawer and cubbies, other side has waste drawer and cubbies (cubbies partially covered by door)
- waste drawer accommodates two Uline #S-13527 (10 gallon) trash cans, not included

Options:

- metal available in powder coat, no upcharge, or chrome, add \$1,709 list upcharge
- laminate doors available in contrasting color, no upcharge, specify color; see page [NA9](#) for details
- veneer doors available in contrasting paint color, no upcharge, specify paint color; see page [NA9](#) for details

Power Buffet Credenza with Utility Drawer and Waste Drawer	24	90	36	421	50	NAT2490-36PCULWR	\$6,731		
	24	90	36	421	50	NAV2490-36PCULWR		\$8,156	\$9,222
	24	90	36	421	50	NAT2490-36PCURWL	\$6,731		
	24	90	36	421	50	NAV2490-36PCURWL		\$8,156	\$9,222
	24	72	36	341	40	NAT2472-36PCULWR	\$6,534		
	24	72	36	341	40	NAV2472-36PCULWR		\$7,918	\$8,951
	24	72	36	341	40	NAT2472-36PCURWL	\$6,534		
	24	72	36	341	40	NAV2472-36PCURWL		\$7,918	\$8,951



left

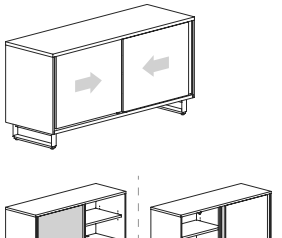
right

Features:

- sliding doors (non-locking)
- one side has utility drawer and cubbies, other side has waste drawer and cubbies (cubbies partially covered by door)
- waste drawer accommodates two Uline #S-13527 (10 gallon) trash cans, not included
- power unit recessed in worksurface - ships installed

Options:

- metal available in powder coat, no upcharge, or chrome, add \$1,709 list upcharge
- laminate doors available in contrasting color, no upcharge, specify color; see page [NA9](#) for details
- veneer doors available in contrasting paint color, no upcharge, specify paint color; see page [NA9](#) for details

Description	D	W	H	CTN WT	CU FT	① Model	Laminate	Flat Cut Veneer	Double Cut Veneer
	24	90	36	415	53	NAT2490-36AVCR	\$8,492		
	24	90	36	415	53	NAV2490-36AVCR		\$9,741	\$10,673
	24	90	36	415	53	NAT2490-36AVCL	\$8,492		
	24	90	36	415	53	NAV2490-36AVCL		\$9,741	\$10,673
	24	72	36	348	42	NAT2472-36AVCR	\$8,279		
	24	72	36	348	42	NAV2472-36AVCR		\$9,493	\$10,401
	24	72	36	348	42	NAT2472-36AVCL	\$8,279		
	24	72	36	348	42	NAV2472-36AVCL		\$9,493	\$10,401

Features:

- sliding doors (non-locking)
- one side has one adjustable shelf, other side has AV rack
- slide out and rotating AV rack included; provides easy rear access to equipment connections
- removable panel behind AV rack

Options:

- metal available in powder coat, no upcharge, or chrome, add \$1,709 list upcharge
- laminate doors available in contrasting color, no upcharge, specify color; see page [NA9](#) for details
- veneer doors available in contrasting paint color, no upcharge, specify paint color; see page [NA9](#) for details

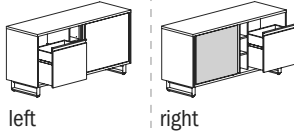
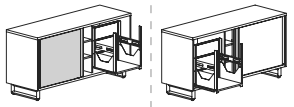
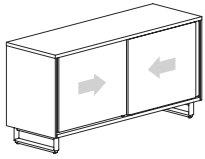
NATIVE

To Order, Specify:

① Laminate Model #	② Chassis/Door Front Laminate	③ Metal Color
Laminate (NAT)	See Chassis/Door Front Laminate Options	See Metal Color Options

① Veneer Model #	② Wood Species	③ Chassis Finish - Top	④ Door Front Paint	⑤ Metal Color
Veneer (NAV)	Flat Cut B01 Black Oak CH1 Cherry MA1 Maple WA1 Walnut	See Flat Cut Chassis - Top Finish Options	See Door Front Paint Color Options	See Metal Color Options
	Double Cut DC1 Double Cut	③ Wood Finish - Top See Double Cut Top Finish Options		

Description	D	W	H	CTN WT	CU FT	① Model	Laminate	Flat Cut Veneer	Double Cut Veneer
AV Credenza with Waste Drawer	24	90	36	443	53	NAT2490-36AVWR	\$9,207		
	24	90	36	443	53	NAV2490-36AVWR		\$10,573	\$11,592
	24	90	36	443	53	NAT2490-36AVWL	\$9,207		
	24	90	36	443	53	NAV2490-36AVWL		\$10,573	\$11,592
	24	72	36	374	42	NAT2472-36AVWR	\$8,969		
	24	72	36	374	42	NAV2472-36AVWR		\$10,297	\$11,285
	24	72	36	374	42	NAT2472-36AVWL	\$8,969		
	24	72	36	374	42	NAV2472-36AVWL		\$10,297	\$11,285



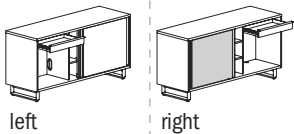
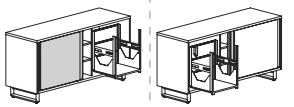
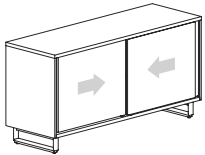
Features:

- sliding doors (non-locking)
- one side has AV rack and cubbies, other side has waste drawer and cubbies (cubbies partially covered by door)
- slide out and rotating AV rack included; provides easy rear access to equipment connections
- removable panel behind AV rack

Options:

- waste drawer accommodates two Uline #S-13527 (10 gallon) trash cans, not included
- metal available in powder coat, no upcharge, or chrome, add \$1,709 list upcharge
- laminate doors available in contrasting color, no upcharge, specify color; see page [NA9](#) for details
- veneer doors available in contrasting paint color, no upcharge, specify paint color; see page [NA9](#) for details

AV Credenza with Utility Drawer	24	90	36	407	53	NAT2490-36AVUR	\$8,910		
	24	90	36	407	53	NAV2490-36AVUR		\$10,228	\$11,209
	24	90	36	407	53	NAT2490-36AVUL	\$8,910		
	24	90	36	407	53	NAV2490-36AVUL		\$10,228	\$11,209
	24	72	36	338	42	NAT2472-36AVUR	\$8,673		
	24	72	36	338	42	NAV2472-36AVUR		\$9,952	\$10,905
	24	72	36	338	42	NAT2472-36AVUL	\$8,673		
	24	72	36	338	42	NAV2472-36AVUL		\$9,952	\$10,905



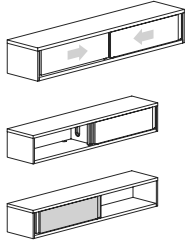
Features:

- sliding doors (non-locking)
- one side has AV rack, other side has utility drawer and cubbies (cubbies partially covered by door)
- slide out and rotating AV rack included; provides easy rear access to equipment connections
- removable panel behind AV rack

Options:

- metal available in powder coat, no upcharge, or chrome, add \$1,709 list upcharge
- laminate doors available in contrasting color, no upcharge, specify color; see page [NA9](#) for details
- veneer doors available in contrasting paint color, no upcharge, specify paint color; see page [NA9](#) for details

Description	D	W	H	CTN WT	CU FT	① Model	Laminate	Flat Cut Veneer	Double Cut Veneer
Wall Storage Credenza	15	90	12	147	13	NAT1590-12WSC	\$2,646		
	15	90	12	147	13	NAV1590-12WSC		\$3,391	\$3,832
	15	72	12	122	11	NAT1572-12WSC	\$2,590		
	15	72	12	122	11	NAV1572-12WSC		\$3,318	\$3,751



Features:

- sliding doors (non-locking)

Options:

- metal available in powder coat, no upcharge, or chrome, add \$318 list upcharge
- laminate doors available in contrasting color, no upcharge, specify color; see page [NA9](#) for details
- veneer doors available in contrasting paint color, no upcharge, specify paint color; see page [NA9](#) for details

NATIVE

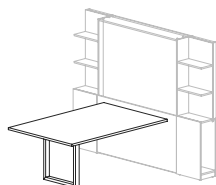
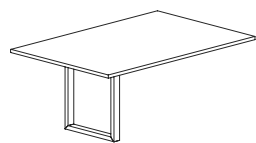
To Order, Specify:

① Laminate Model #	② Chassis/Door Front Laminate	③ Metal Color
Laminate (NAT)	See Chassis/Door Front Laminate Options	See Metal Color Options

① Veneer Model #	② Wood Species	③ Chassis Finish - Top	④ Door Front Paint	⑤ Metal Color
Veneer (NAV)	Flat Cut B01 Black Oak CH1 Cherry MA1 Maple WA1 Walnut	See Flat Cut Chassis - Top Finish Options	See Door Front Paint Color Options	See Metal Color Options
	Double Cut DC1 Double Cut	③ Wood Finish - Top See Double Cut Top Finish Options		

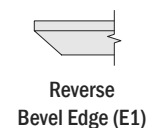
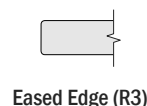
Description

Rectangular Runoff Table with Open Loop Base



in application

Laminate Tops "NAT" Models



Features:

- must attach to either a 74" Media Wall Space Divider without Media Shelf or a 74" Media Wall - Table Mount
- metal open loop base with structural support rails
- glass top has additional seams

Options:

- worksurface power & storage available, specify cutout code and order power units separately, see pages [NA14-NA15](#)
- metal base frame available in powder coat, no upcharge, or chrome, add list upcharge: for 36" wide - \$950, for 42" & 48" wide - \$1,100, for 54" wide - \$1,259
- magnetic wire manager available; order separately, see page [NA124](#)
- mounting brackets included

D	W	H	CTN WT	CU FT	① Model	HPL	HPL
54	60	29 ³ / ₈	162	52	NAT5460-30TTRLB	\$3,024	\$3,450
48	84	29 ³ / ₈	187	43	NAT4884-30TTRLB	\$3,054	\$3,481
48	72	29 ³ / ₈	166	29	NAT4872-30TTRLB	\$2,982	\$3,406
48	60	29 ³ / ₈	142	36	NAT4860-30TTRLB	\$2,860	\$3,287
42	84	29 ³ / ₈	170	37	NAT4284-30TTRLB	\$3,001	\$3,428
42	72	29 ³ / ₈	152	43	NAT4272-30TTRLB	\$2,938	\$3,362
42	60	29 ³ / ₈	129	32	NAT4260-30TTRLB	\$2,798	\$3,224
36	84	29 ³ / ₈	150	42	NAT3684-30TTRLB	\$2,950	\$3,377
36	72	29 ³ / ₈	131	34	NAT3672-30TTRLB	\$2,891	\$3,318
36	60	29 ³ / ₈	114	42	NAT3660-30TTRLB	\$2,785	\$3,212

To Order, Specify:

① Laminate Model #	② Top/Base Laminate	③ Top Edge	④ Metal Color	⑤ Electrical
Laminate (NAT)	See Top/Base Laminate Options	See Top Edge Options	Metal Color Options	Cutout Codes: N all tables C1M 72" - 84" wide C1C 72" - 84" wide See chart on page NA15 for cutout codes and power and storage unit configurations

Description

Rectangular Runoff Table
with Open Loop Base
(continued)

						Veneer Tops "NAV" Models				Premier Tops "NAV" Models			
						Eased Edge (R3)		Reverse Bevel Edge (E1)		Solid Surface/Glass Reverse Bevel Edge			
D	W	H	CTN WT	CU FT	① Model	Flat Cut	Double Cut	Flat Cut	Double Cut	Solid Surface	Glass	Wood Plank Ash	Custom Sub-Base
54	60	29 3/8	162	52	NAV5460-30TTRLB	\$3,598	\$4,080	\$3,763	\$4,244	\$9,592	\$8,356	--	\$3,437
48	84	29 3/8	187	43	NAV4884-30TTRLB	\$3,634	\$4,186	\$3,798	\$4,349	\$10,452	\$9,555	\$7,841	\$3,470
48	72	29 3/8	166	29	NAV4872-30TTRLB	\$3,547	\$4,022	\$3,711	\$4,187	\$9,454	\$8,622	\$7,154	\$3,388
48	60	29 3/8	142	36	NAV4860-30TTRLB	\$3,403	\$3,805	\$3,569	\$3,969	\$8,397	\$7,633	\$6,408	\$3,251
42	84	29 3/8	170	37	NAV4284-30TTRLB	\$3,572	\$4,058	\$3,737	\$4,222	\$9,593	\$8,754	\$7,254	\$3,413
42	72	29 3/8	152	43	NAV4272-30TTRLB	\$3,496	\$3,916	\$3,660	\$4,079	\$8,718	\$7,937	\$6,651	\$3,338
42	60	29 3/8	129	32	NAV4260-30TTRLB	\$3,330	\$3,682	\$3,494	\$3,846	\$7,753	\$7,030	\$5,958	\$3,181
36	84	29 3/8	150	42	NAV3684-30TTRLB	\$3,510	\$3,933	\$3,674	\$4,099	\$8,735	\$7,950	\$6,664	\$3,354
36	72	29 3/8	131	34	NAV3672-30TTRLB	\$3,441	\$3,806	\$3,606	\$3,970	\$7,981	\$7,248	\$6,147	\$3,288
36	60	29 3/8	114	42	NAV3660-30TTRLB	\$3,316	\$3,624	\$3,481	\$3,788	\$7,168	\$6,487	\$5,569	\$3,168

NATIVE

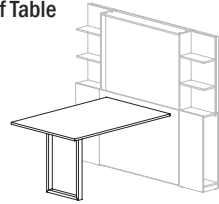
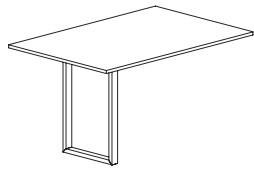
To Order, Specify:

① Veneer Model #	② Wood Species	③ Top Wood Finish	④ Top Edge	⑤ Metal Color	⑥ Electrical
Veneer (NAV)	Flat Cut B01 Black Oak CH1 Cherry MA1 Maple WA1 Walnut	See Flat Cut Top Wood Finish Options	See Top Edge Options	See Metal Color Options	Cutout Codes: N all tables C1M 72" - 84" wide C1C 72" - 84" wide See chart on page NA15 for cutout codes and power and storage unit configurations
	Double Cut DC1 Double Cut	③ Top Wood Finish See Double Cut Top Wood Finish Options			

① Specialty Top Model #	② Top Surface Selection	③ Metal Color	④ Electrical
Solid Surface (NAV)	See Solid Surface Top Surface Selection	See Metal Color Options	Cutout Codes: N all tables C1M 72" - 84" wide C1C 72" - 84" wide See chart on page NA15 for cutout codes and power and storage unit configurations
Glass Surface (NAV)	See Glass Top Surface Selection		
Wood Plank (NAV)	See Wood Plank Top Surface Selection		
Sub-Top w/Base (NAV)	B (Table Ships with Sub-Top, Customer applies custom Top)		

Description

Standing Height Rectangular Runoff Table with Open Loop Base



in application

Features:

- must attach to either a 84" Media Wall Space Divider without Media Shelf or a 84" Media Wall - Table Mount
- metal open loop base with structural support rails
- glass top has additional seams

Options:

- worksurface power & storage available, specify cutout code and order power units separately, see pages [NA14-NA15](#)
- metal base frame available in powder coat, no upcharge, or chrome, add list upcharge: for 36" wide - \$1,046, for 42" & 48" wide - \$1,210, for 54" wide - \$1,308
- magnetic wire manager available; order separately, see page [NA124](#)
- mounting brackets included

Laminate Tops "NAT" Models



Eased Edge (R3)



Reverse Bevel Edge (E1)

D	W	H	CTN WT	CU FT	① Model	HPL	HPL
54	60	40	157	52	NAT5460-40TTRLB	\$2,988	\$3,416
48	84	40	193	46	NAT4884-40TTRLB	\$3,017	\$3,444
48	72	40	177	40	NAT4872-40TTRLB	\$2,946	\$3,371
48	60	40	147	35	NAT4860-40TTRLB	\$2,825	\$3,252
42	84	40	194	38	NAT4284-40TTRLB	\$2,966	\$3,393
42	72	40	157	53	NAT4272-40TTRLB	\$2,901	\$3,329
42	60	40	135	38	NAT4260-40TTRLB	\$2,791	\$3,218
36	84	40	155	33	NAT3684-40TTRLB	\$2,586	\$3,011
36	72	40	139	32	NAT3672-40TTRLB	\$2,858	\$3,285
36	60	40	120	35	NAT3660-40TTRLB	\$2,753	\$3,180

To Order, Specify:

① Laminate Model #	② Top/Base Laminate	③ Top Edge	④ Metal Color	⑤ Electrical
Laminate (NAT)	See Top/Base Laminate Options	See Top Edge Options	Metal Color Options	Cutout Codes: N all tables C1M 72" - 84" wide C1C 72" - 84" wide See chart on page NA15 for cutout codes and power and storage unit configurations

Description

Standing Height Rectangular Runoff Table with Open Loop Base (continued)

						Veneer Tops "NAV" Models				Premier Tops "NAV" Models			
						Eased Edge (R3)		Reverse Bevel Edge (E1)		Solid Surface/Glass Reverse Bevel Edge			
D	W	H	CTN WT	CU FT	1 Model	Flat Cut	Double Cut	Flat Cut	Double Cut	Solid Surface	Glass	Wood Plank Ash	Custom Sub-Base
54	60	40	157	52	NAV5460-40TTRLB	\$3,598	\$4,080	\$3,763	\$4,244	\$9,592	\$8,356	--	\$3,437
48	84	40	193	46	NAV4884-40TTRLB	\$3,634	\$4,186	\$3,798	\$4,349	\$10,452	\$9,555	\$7,841	\$3,470
48	72	40	177	40	NAV4872-40TTRLB	\$3,547	\$4,022	\$3,711	\$4,187	\$9,454	\$8,622	\$7,154	\$3,388
48	60	40	147	35	NAV4860-40TTRLB	\$3,403	\$3,805	\$3,569	\$3,969	\$8,397	\$7,633	\$6,408	\$3,251
42	84	40	194	38	NAV4284-40TTRLB	\$3,572	\$4,058	\$3,737	\$4,222	\$9,593	\$8,754	\$7,254	\$3,413
42	72	40	157	53	NAV4272-40TTRLB	\$3,496	\$3,916	\$3,660	\$4,079	\$8,718	\$7,937	\$6,651	\$3,338
42	60	40	135	38	NAV4260-40TTRLB	\$3,360	\$3,715	\$3,525	\$3,878	\$7,785	\$7,061	\$5,991	\$3,211
36	84	40	155	33	NAV3684-40TTRLB	\$3,113	\$3,536	\$3,277	\$3,702	\$8,339	\$7,554	\$6,267	\$2,974
36	72	40	139	32	NAV3672-40TTRLB	\$3,441	\$3,806	\$3,606	\$3,970	\$7,981	\$7,248	\$6,147	\$3,288
36	60	40	120	35	NAV3660-40TTRLB	\$3,316	\$3,624	\$3,481	\$3,788	\$7,168	\$6,487	\$5,569	\$3,168

NATIVE

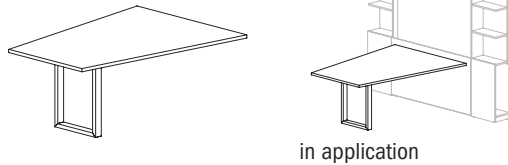
To Order, Specify:

1 Veneer Model #	2 Wood Species	3 Top Wood Finish	4 Top Edge	5 Metal Color	6 Electrical
Veneer (NAV)	Flat Cut B01 Black Oak CH1 Cherry MA1 Maple WA1 Walnut	See Flat Cut Top Wood Finish Options	See Top Edge Options	See Metal Color Options	Cutout Codes: N all tables C1M 72" - 84" wide C1C 72" - 84" wide See chart on page NA15 for cutout codes and power and storage unit configurations
	Double Cut DC1 Double Cut	3 Top Wood Finish See Double Cut Top Wood Finish Options			

1 Specialty Top Model #	2 Top Surface Selection	3 Metal Color	4 Electrical
Solid Surface (NAV)	See Solid Surface Top Surface Selection	See Metal Color Options	Cutout Codes: N all tables C1M 72" - 84" wide C1C 72" - 84" wide
Glass Surface (NAV)	See Glass Top Surface Selection		
Wood Plank (NAV)	See Wood Plank Top Surface Selection		
Sub-Top w/Base (NAV)	B (Table Ships with Sub-Top, Customer applies custom Top)		

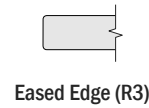
Description

View Runoff Table with Open Loop Base

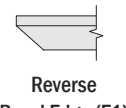


in application

Laminate Tops "NAT" Models



Eased Edge (R3)



Reverse Bevel Edge (E1)

Features:

- must attach to either a 74" Media Wall Space Divider without Media Shelf or a 74" Media Wall - Table Mount
- metal open loop base with structural support rails
- narrow end of table is 36"d
- glass top has additional seams

Options:

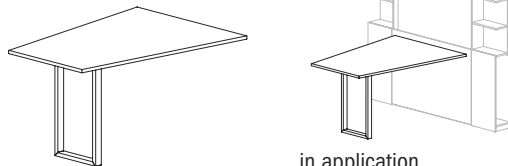
- metal base frame available in powder coat, no upcharge, or chrome, add \$1,259 list upcharge for 54" wide
- worksurface power & storage available, specify cutout code and order power units separately, see pages [NA14-NA15](#)
- mounting brackets included

D	W	H	CTN WT	CU FT	① Model	HPL	HPL
54	84	29 ³ / ₈	175	51	NAT5484-30VTRLB	\$3,033	\$3,460
54	72	29 ³ / ₈	156	40	NAT5472-30VTRLB	\$2,950	\$3,377
54	60	29 ³ / ₈	134	52	NAT5460-30VTRLB	\$2,836	\$3,261

NATIVE

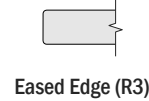
Description

Standing Height View Runoff Table with Open Loop Base

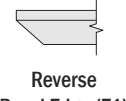


in application

Laminate Tops "NAT" Models



Eased Edge (R3)



Reverse Bevel Edge (E1)

Features:

- must attach to either a 84" Media Wall Space Divider without Media Shelf or a 84" Media Wall - Table Mount
- metal open loop base with structural support rails
- narrow end of table is 36"d
- glass top has additional seams

Options:

- metal base frame available in powder coat, no upcharge, or chrome, add \$1,308 list upcharge for 54" wide
- worksurface power & storage available, specify cutout code and order power units separately, see pages [NA14-NA15](#)
- mounting brackets included

D	W	H	CTN WT	CU FT	① Model	HPL	HPL
54	84	40	181	54	NAT5484-40VTRLB	\$3,236	\$3,664
54	72	40	163	47	NAT5472-40VTRLB	\$3,155	\$3,582
54	60	40	138	52	NAT5460-40VTRLB	\$3,072	\$3,498

To Order, Specify:

① Laminate Model #	② Top/Base Laminate	③ Top Edge	④ Metal Color	⑤ Electrical
Laminate (NAT)	See Top/Base Laminate Options	See Top Edge Options	Metal Color Options	Cutout Codes: N all tables C1M 72" - 84" wide C1C 72" - 84" wide See chart on page NA15 for cutout codes and power and storage unit configurations

Description

View Runoff Table with Open Loop Base
(continued)

						Veneer Tops "NAV" Models				Premier Tops "NAV" Models			
						Eased Edge (R3)		Reverse Bevel Edge (E1)		Solid Surface/Glass Reverse Bevel Edge			
D	W	H	CTN WT	CU FT	① Model	Flat Cut	Double Cut	Flat Cut	Double Cut	Solid Surface	Glass	Wood Plank Ash	Custom Sub-Base
54	84	29 3/8	175	51	NAV5484-30VTRLB	\$3,610	\$4,231	\$3,776	\$4,397	\$11,282	\$10,271	--	\$3,449
54	72	29 3/8	156	40	NAV5472-30VTRLB	\$3,511	\$4,066	\$3,676	\$4,230	\$10,403	\$9,221	--	\$3,355
54	60	29 3/8	134	52	NAV5460-30VTRLB	\$3,374	\$3,856	\$3,537	\$4,021	\$9,368	\$8,131	--	\$3,223

Description

Standing Height View Runoff Table with Open Loop Base
(continued)

						Veneer Tops "NAV" Models				Premier Tops "NAV" Models			
						Eased Edge (R3)		Reverse Bevel Edge (E1)		Solid Surface/Glass Reverse Bevel Edge			
D	W	H	CTN WT	CU FT	① Model	Flat Cut	Double Cut	Flat Cut	Double Cut	Solid Surface	Glass	Wood Plank Ash	Custom Sub-Base
54	84	40	181	54	NAV5484-40VTRLB	\$3,853	\$4,474	\$4,018	\$4,639	\$11,525	\$10,513	--	\$3,680
54	72	40	163	47	NAV5472-40VTRLB	\$3,755	\$4,308	\$3,919	\$4,473	\$10,645	\$9,463	--	\$3,586
54	60	40	138	52	NAV5460-40VTRLB	\$3,656	\$4,137	\$3,821	\$4,301	\$9,651	\$8,413	--	\$3,492

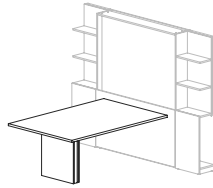
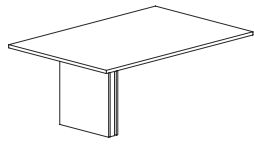
To Order, Specify:

① Veneer Model #	② Wood Species	③ Top Wood Finish	④ Base Finish	⑤ Top Edge	⑥ Metal Color	⑦ Electrical
Veneer (NAV)	Flat Cut B01 Black Oak CH1 Cherry MA1 Maple WA1 Walnut	See Top Wood Finish Options	See Base Finish Options	See Top Edge Options	See Metal Color Options	Cutout Codes: N all tables C1M 72" - 84"w C1C 72" - 84"w See chart on page NA15 for cutout codes and power and storage unit configurations
	Double Cut DC1 Double Cut	③ Top Wood Finish See Top Wood Finish Options				

① Specialty Top Model #	② Top Surface Selection	③ Base Wood Species	④a Base Wood Finish	④b Base Paint	⑤ Metal Color	⑥ Electrical
Solid Surface (NAV)	See Solid Surface Top Surface Selection	Flat Cut B01 Black Oak CH1 Cherry MA1 Maple WA1 Walnut	See Wood Base Finish Options	See Base Paint Options	See Metal Color Options	Cutout Codes: N all tables C1M 72" - 84"w C1C 72" - 84"w
Glass Surface (NAV)	See Glass Top Surface Selection					
Wood Plank (NAV)	See Wood Plank Top Surface Selection					
Sub-Top w/Base (NAV)	B (Table Ships with Sub-Top, Customer applies custom Top)	Double Cut DC1 Double Cut				

Description

Rectangular Runoff Table with Panel Base



in application

Laminate Tops "NAT" Models



Eased Edge (R3)



Reverse Bevel Edge (E1)

Features:

- must attach to either a 74" Media Wall Space Divider without Media Shelf or a 74" Media Wall - Table Mount
- panel base with structural support rails
- glass top has additional seams

Options:

- worksurface power & storage available, specify cutout code and order power units separately, see pages [NA14-NA15](#)
- metal base frame available in powder coat, no upcharge, or chrome, add list upcharge: for 36" wide - \$950, for 42" & 48 wide - \$1,100, for 54 wide - \$1,259
- mounting brackets included

D	W	H	CTN WT	CU FT	① Model	HPL	HPL
54	60	29 ³ / ₈	181	54	NAT5460-30TTRPB	\$3,246	\$3,671
48	84	29 ³ / ₈	208	43	NAT4884-30TTRPB	\$3,268	\$3,694
48	72	29 ³ / ₈	190	40	NAT4872-30TTRPB	\$3,196	\$3,621
48	60	29 ³ / ₈	162	36	NAT4860-30TTRPB	\$3,381	\$3,806
42	84	29 ³ / ₈	190	37	NAT4284-30TTRPB	\$3,218	\$3,642
42	72	29 ³ / ₈	156	38	NAT4272-30TTRPB	\$3,152	\$3,579
42	60	29 ³ / ₈	150	32	NAT4260-30TTRPB	\$3,041	\$3,467
36	84	29 ³ / ₈	167	42	NAT3684-30TTRPB	\$2,818	\$3,246
36	72	29 ³ / ₈	151	34	NAT3672-30TTRPB	\$3,091	\$3,518
36	60	29 ³ / ₈	131	42	NAT3660-30TTRPB	\$2,961	\$3,386

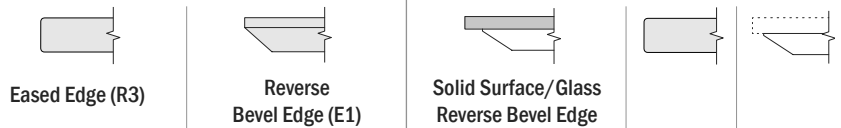
To Order, Specify:

① Laminate Model #	② Top/Base Laminate	③ Top Edge	④ Metal Color	⑤ Electrical
Laminate (NAT)	See Top/Base Laminate Options	See Top Edge Options	Metal Color Options	Cutout Codes: N all tables C1M 72" - 84" wide C1C 72" - 84" wide See chart on page NA15 for cutout codes and power and storage unit configurations

Description

Rectangular Runoff Table with Panel Base
(continued)

Veneer Tops "NAV" Models Premier Tops "NAV" Models



D	W	H	CTN WT	CU FT	① Model	Veneer Tops "NAV" Models		Premier Tops "NAV" Models					
						Flat Cut	Double Cut	Flat Cut	Double Cut	Solid Surface	Glass	Wood Plank Ash	Custom Sub-Base
54	60	29 3/8	181	54	NAV5460-30TTRPB	\$3,908	\$4,519	\$4,072	\$4,684	\$9,902	\$8,665	--	\$3,734
48	84	29 3/8	208	43	NAV4884-30TTRPB	\$3,934	\$4,576	\$4,100	\$4,741	\$10,754	\$9,855	\$8,142	\$3,759
48	72	29 3/8	190	40	NAV4872-30TTRPB	\$3,850	\$4,476	\$4,013	\$4,641	\$9,756	\$8,923	\$7,455	\$3,677
48	60	29 3/8	162	36	NAV4860-30TTRPB	\$4,070	\$4,735	\$4,236	\$4,899	\$9,063	\$8,300	\$7,075	\$3,889
42	84	29 3/8	190	37	NAV4284-30TTRPB	\$3,875	\$4,506	\$4,039	\$4,671	\$9,897	\$9,055	\$7,555	\$3,702
42	72	29 3/8	156	38	NAV4272-30TTRPB	\$3,797	\$4,417	\$3,962	\$4,580	\$9,019	\$8,238	\$6,952	\$3,628
42	60	29 3/8	150	32	NAV4260-30TTRPB	\$3,662	\$4,258	\$3,827	\$4,424	\$8,086	\$7,363	\$6,291	\$3,498
36	84	29 3/8	167	42	NAV3684-30TTRPB	\$3,394	\$3,948	\$3,558	\$4,112	\$8,620	\$7,836	\$6,549	\$3,244
36	72	29 3/8	151	34	NAV3672-30TTRPB	\$3,722	\$4,329	\$3,888	\$4,494	\$8,262	\$7,529	\$6,427	\$3,556
36	60	29 3/8	131	42	NAV3660-30TTRPB	\$3,566	\$4,147	\$3,731	\$4,313	\$7,418	\$6,737	\$5,819	\$3,406

NATIVE

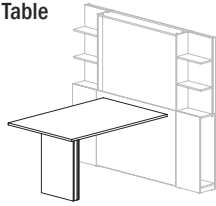
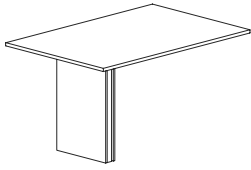
To Order, Specify:

① Veneer Model #	② Wood Species	③ Top Wood Finish	④ Base Finish	⑤ Top Edge	⑥ Metal Color	⑦ Electrical
Veneer (NAV)	Flat Cut B01 Black Oak CH1 Cherry MA1 Maple WA1 Walnut	See Top Wood Finish Options	See Base Finish Options	See Top Edge Options	See Metal Color Options	Cutout Codes: N all tables C1M 72" - 84"w C1C 72" - 84"w See chart on page NA15 for cutout codes and power and storage unit configurations
	Double Cut DC1 Double Cut	Top Wood Finish See Top Wood Finish Options				

① Specialty Top Model #	② Top Surface Selection	③ Base Wood Species	④a Base Wood Finish	④b Base Paint	⑤ Metal Color	⑥ Electrical
Solid Surface (NAV)	See Solid Surface Top Surface Selection	Flat Cut B01 Black Oak CH1 Cherry MA1 Maple WA1 Walnut	See Wood Base Finish Options	See Base Paint Options	See Metal Color Options	Cutout Codes: N all tables C1M 72" - 84"w C1C 72" - 84"w
Glass Surface (NAV)	See Glass Top Surface Selection					
Wood Plank (NAV)	See Wood Plank Top Surface Selection	Double Cut DC1 Double Cut				
Sub-Top w/Base (NAV)	B (Table Ships with Sub-Top, Customer applies custom Top)					

Description

Standing Height Rectangular Runoff Table with Panel Base



in application

Features:

- must attach to either a 84" Media Wall Space Divider without Media Shelf or a 84" Media Wall - Table Mount
- panel base with structural support rails
- glass top has additional seams

Options:

- worksurface power & storage available, specify cutout code and order power units separately, see pages [NA14-NA15](#)
- metal base frame available in powder coat, no upcharge, or chrome, add list upcharge: for 36" wide - \$1,046, for 42" & 48" wide - \$1,259, for 54" wide - \$1,308
- mounting brackets included

Laminate Tops "NAT" Models



Eased Edge (R3)



Reverse Bevel Edge (E1)

D	W	H	CTN WT	CU FT	① Model	HPL	HPL
54	60	40	199	54	NAT5460-40TTRPB	\$3,313	\$3,740
48	84	40	224	45	NAT4884-40TTRPB	\$3,293	\$3,719
48	72	40	207	41	NAT4872-40TTRPB	\$3,221	\$3,647
48	60	40	179	35	NAT4860-40TTRPB	\$3,102	\$3,530
42	84	40	207	38	NAT4284-40TTRPB	\$3,244	\$3,669
42	72	40	188	42	NAT4272-40TTRPB	\$3,177	\$3,603
42	60	40	166	33	NAT4260-40TTRPB	\$3,064	\$3,492
36	84	40	181	33	NAT3684-40TTRPB	\$3,168	\$3,594
36	72	40	166	38	NAT3672-40TTRPB	\$3,111	\$3,536
36	60	40	146	35	NAT3660-40TTRPB	\$3,007	\$3,432

NATIVE

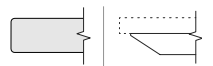
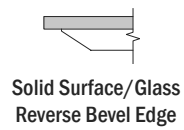
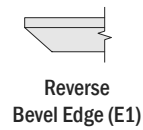
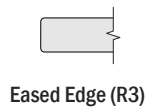
To Order, Specify:

① Laminate Model #	② Top/Base Laminate	③ Top Edge	④ Metal Color	⑤ Electrical
Laminate (NAT)	See Top/Base Laminate Options	See Top Edge Options	Metal Color Options	Cutout Codes: N all tables C1M 72" - 84" wide C1C 72" - 84" wide See chart on page NA15 for cutout codes and power and storage unit configurations

Description

Standing Height Rectangular Runoff Table with Panel Base (continued)

Veneer Tops "NAV" Models Premier Tops "NAV" Models



D	W	H	CTN WT	CU FT	① Model	Eased Edge (R3)		Reverse Bevel Edge (E1)		Solid Surface/Glass Reverse Bevel Edge			
						Flat Cut	Double Cut	Flat Cut	Double Cut	Solid Surface	Glass	Wood Plank Ash	Custom Sub-Base
54	60	40	199	54	NAV5460-40TRPB	\$3,992	\$4,614	\$4,155	\$4,778	\$9,985	\$8,748	--	\$3,811
48	84	40	224	45	NAV4884-40TRPB	\$3,965	\$4,612	\$4,130	\$4,776	\$10,785	\$9,887	\$8,173	\$3,788
48	72	40	207	41	NAV4872-40TRPB	\$3,879	\$4,512	\$4,043	\$4,677	\$9,786	\$8,954	\$7,485	\$3,706
48	60	40	179	35	NAV4860-40TRPB	\$3,739	\$4,348	\$3,902	\$4,512	\$8,731	\$7,967	\$6,743	\$3,571
42	84	40	207	38	NAV4284-40TRPB	\$3,905	\$4,541	\$4,069	\$4,707	\$9,927	\$9,085	\$7,584	\$3,731
42	72	40	188	42	NAV4272-40TRPB	\$3,827	\$4,450	\$3,992	\$4,614	\$9,049	\$8,267	\$6,981	\$3,655
42	60	40	166	33	NAV4260-40TRPB	\$3,693	\$4,294	\$3,857	\$4,460	\$8,115	\$7,393	\$6,322	\$3,528
36	84	40	181	33	NAV3684-40TRPB	\$3,816	\$4,437	\$3,979	\$4,602	\$9,041	\$8,257	\$6,970	\$3,643
36	72	40	166	38	NAV3672-40TRPB	\$3,747	\$4,358	\$3,911	\$4,523	\$8,287	\$7,553	\$6,451	\$3,579
36	60	40	146	35	NAV3660-40TRPB	\$3,620	\$4,211	\$3,785	\$4,375	\$7,473	\$6,792	\$5,875	\$3,459

NATIVE

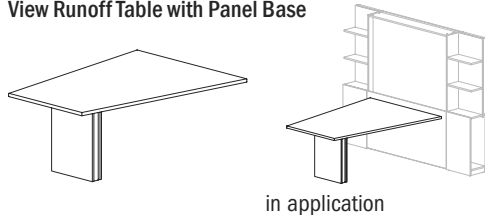
To Order, Specify:

① Veneer Model #	② Wood Species	③ Top Wood Finish	④ Base Finish	⑤ Top Edge	⑥ Metal Color	⑦ Electrical
Veneer (NAV)	Flat Cut B01 Black Oak CH1 Cherry MA1 Maple WA1 Walnut	See Top Wood Finish Options	See Base Finish Options	See Top Edge Options	See Metal Color Options	Cutout Codes: N all tables C1M 72" - 84" wide C1C 72" - 84" wide See chart on page NA15 for cutout codes and power and storage unit configurations
	Double Cut DC1 Double Cut	Top Wood Finish See Top Wood Finish Options				

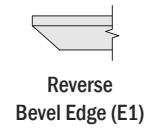
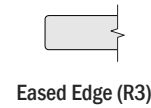
① Specialty Top Model #	② Top Surface Selection	③ Base Wood Species	④a Base Wood Finish	④b Base Paint	⑤ Metal Color	⑥ Electrical
Solid Surface (NAV)	See Solid Surface Top Surface Selection	Flat Cut B01 Black Oak CH1 Cherry MA1 Maple WA1 Walnut	See Wood Base Finish Options	See Base Paint Options	See Metal Color Options	Cutout Codes: N all tables C1M 72" - 84" wide C1C 72" - 84" wide
Glass Surface (NAV)	See Glass Top Surface Selection					
Wood Plank (NAV)	See Wood Plank Top Surface Selection					
Sub-Top w/Base (NAV)	B (Table Ships with Sub-Top, Customer applies custom Top)	Double Cut DC1 Double Cut				

Description

View Runoff Table with Panel Base



Laminate Tops "NAT" Models



Features:

- must attach to either a 74" Media Wall Space Divider without Media Shelf or a 74" Media Wall - Table Mount
- panel base with structural support rails
- narrow end of table is 36"d
- glass top has additional seams

Options:

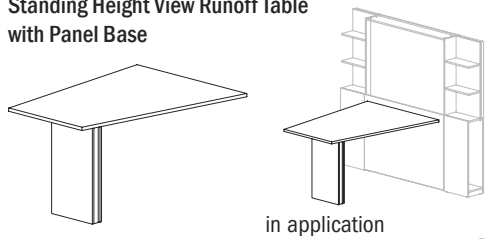
- metal base frame available in powder coat, no upcharge, or chrome, add \$1,259 list upcharge for 54" wide
- worksurface power & storage available, specify cutout code and order power units separately, see pages [NA14-NA15](#)
- mounting brackets included

D	W	H	CTN WT	CU FT	① Model	HPL	HPL
54	84	29 ³ / ₈	194	51	NAT5484-30VTRPB	\$3,256	\$3,682
54	72	29 ³ / ₈	174	42	NAT5472-30VTRPB	\$3,175	\$3,599
54	60	29 ³ / ₈	151	54	NAT5460-30VTRPB	\$3,046	\$3,470

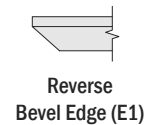
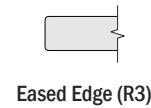
NATIVE

Description

Standing Height View Runoff Table with Panel Base



Laminate Tops "NAT" Models



Features:

- must attach to either a 84" Media Wall Space Divider without Media Shelf or a 84" Media Wall - Table Mount
- panel base with structural support rails
- narrow end of table is 36"d
- glass top has additional seams

Options:

- metal base frame available in powder coat, no upcharge, or chrome, add \$1,308 list upcharge for 54" wide
- worksurface power & storage available, specify cutout code and order power units separately, see pages [NA14-NA15](#)
- mounting brackets included

D	W	H	CTN WT	CU FT	① Model	HPL	HPL
54	84	40	208	54	NAT5484-40VTRPB	\$3,476	\$3,902
54	72	40	189	42	NAT5472-40VTRPB	\$3,381	\$3,806
54	60	40	165	54	NAT5460-40VTRPB	\$3,263	\$3,690

To Order, Specify:

① Laminate Model #	② Top/Base Laminate	③ Top Edge	④ Metal Color	⑤ Electrical
Laminate (NAT)	See Top/Base Laminate Options	See Top Edge Options	Metal Color Options	Cutout Codes: N all tables C1M 72" - 84" wide C1C 72" - 84" wide See chart on page NA15 for cutout codes and power and storage unit configurations

Description

View Runoff Table with Panel Base (continued)						Veneer Tops "NAV" Models				Premier Tops "NAV" Models			
D	W	H	CTN WT	CU FT	① Model	Eased Edge (R3)		Reverse Bevel Edge (E1)		Solid Surface/Glass Reverse Bevel Edge		Wood Plank Ash	Custom Sub-Base
						Flat Cut	Double Cut	Flat Cut	Double Cut	Solid Surface	Glass		
54	84	29 3/8	194	51	NAV5484-30VTRPB	\$3,922	\$4,536	\$4,087	\$4,701	\$11,593	\$10,583	--	\$3,747
54	72	29 3/8	174	42	NAV5472-30VTRPB	\$3,823	\$4,419	\$3,989	\$4,583	\$10,713	\$9,531	--	\$3,653
54	60	29 3/8	151	54	NAV5460-30VTRPB	\$3,668	\$4,240	\$3,831	\$4,404	\$9,661	\$8,423	--	\$3,503

Description

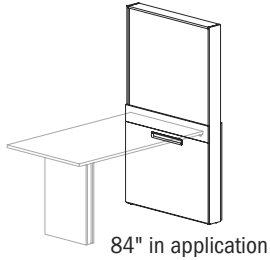
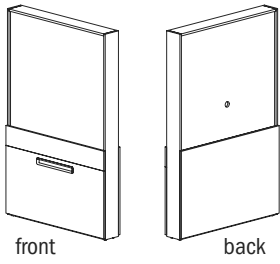
Standing Height View Runoff Table with Panel Base (continued)						Veneer Tops "NAV" Models				Premier Tops "NAV" Models			
D	W	H	CTN WT	CU FT	① Model	Eased Edge (R3)		Reverse Bevel Edge (E1)		Solid Surface/Glass Reverse Bevel Edge		Wood Plank Ash	Custom Sub-Base
						Flat Cut	Double Cut	Flat Cut	Double Cut	Solid Surface	Glass		
54	84	40	208	54	NAV5484-40VTRPB	\$4,188	\$4,840	\$4,351	\$5,006	\$11,859	\$10,847	--	\$4,000
54	72	40	189	42	NAV5472-40VTRPB	\$4,071	\$4,708	\$4,237	\$4,872	\$10,964	\$9,780	--	\$3,890
54	60	40	165	54	NAV5460-40VTRPB	\$3,931	\$4,546	\$4,096	\$4,710	\$9,926	\$8,688	--	\$3,756

To Order, Specify:

① Veneer Model #	② Wood Species	③ Top Wood Finish	④ Base Finish	⑤ Top Edge	⑥ Metal Color	⑦ Electrical
Veneer (NAV)	Flat Cut B01 Black Oak CH1 Cherry MA1 Maple WA1 Walnut	See Top Wood Finish Options	See Base Finish Options	See Top Edge Options	See Metal Color Options	Cutout Codes: N all tables C1M 72" - 84" wide C1C 72" - 84" wide See chart on page NA15 for cutout codes and power and storage unit configurations
	Double Cut DC1 Double Cut	③ Top Wood Finish See Top Wood Finish Options				

① Specialty Top Model #	② Top Surface Selection	③ Base Wood Species	④a Base Wood Finish	④b Base Paint	⑤ Metal Color	⑥ Electrical
Solid Surface (NAV)	See Solid Surface Top Surface Selection	Flat Cut B01 Black Oak CH1 Cherry MA1 Maple WA1 Walnut	See Wood Base Finish Options	See Base Paint Options	See Metal Color Options	Cutout Codes: N all tables C1M 72" - 84" wide C1C 72" - 84" wide
Glass Surface (NAV)	See Glass Top Surface Selection					
Wood Plank (NAV)	See Wood Plank Top Surface Selection					
Sub-Top w/Base (NAV)	B (Table Ships with Sub-Top, Customer applies custom Top)	Double Cut DC1 Double Cut				

Description	D	W	H	CTN WT	CU FT	① Model	Laminate	Flat Cut Veneer	Double Cut Veneer
Media Wall Space Divider -	8	60	74	251	34	NAT0860-74MRUT	\$2,178		
Media Back	8	60	74	251	34	NAV0860-74MRUT		\$3,095	\$3,598
	8	48	74	206	28	NAT0848-74MRUT	\$2,028		
	8	48	74	206	28	NAV0848-74MRUT		\$2,882	\$3,351
	8	60	84	280	39	NAT0860-84MRUT	\$2,241		
	8	60	84	280	39	NAV0860-84MRUT		\$3,185	\$3,705
	8	48	84	229	32	NAT0848-84MRUT	\$2,079		
	8	48	84	229	32	NAV0848-84MRUT		\$2,957	\$3,437



84" in application

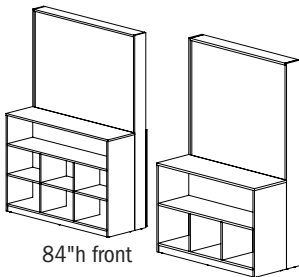
Features:

- not freestanding -must attach to Runoff Table on front side
- 84" media wall to be used with standing runoff units
- not to be used with side storage towers

Options:

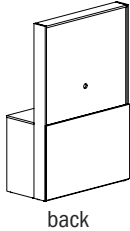
- TV bracket available on each side, specify and add \$240 list per side
- recessed panel on each side available in contrasting laminate color or markerboard, specify color and add \$180 list for veneer models, no upcharge for laminate models; also available in markerboard, specify and add \$401 list
- EC36 power available on front side, specify CO_EC36 for cut out and order EC36 separately, see page [NA124](#)

Media Wall Space Divider with Media Shelf - Media Back	23	60	74	380	76	NAT2360-74MSUT	\$3,039		
	23	60	74	380	76	NAV2360-74MSUT		\$4,322	\$5,025
	23	48	74	314	61	NAT2348-74MSUT	\$2,860		
	23	48	74	314	61	NAV2348-74MSUT		\$4,068	\$4,732
	23	60	84	454	86	NAT2360-84MSUT	\$3,313		
	23	60	84	454	86	NAV2360-84MSUT		\$4,710	\$5,478
	23	48	84	377	70	NAT2348-84MSUT	\$3,123		
	23	48	84	377	70	NAV2348-84MSUT		\$4,439	\$5,160



84"h front

74"h front



back

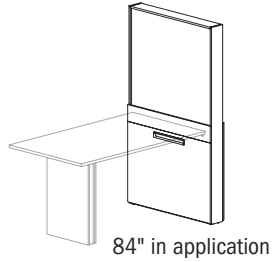
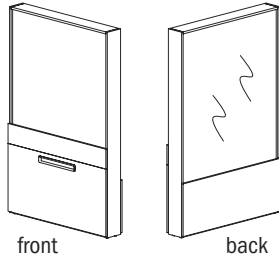
Features:

- media shelf included
- 84" media wall to be used with standing runoff units
- not to be used with side storage towers
- media shelf is always same finish as chassis

Options:

- TV bracket available on each side, specify and add \$240 list per side
- EC36 power available on front side, specify CO_EC36 for cut out and order EC36 separately, see page [NA124](#)
- recessed panel on front side available in contrasting laminate color or markerboard, specify color and add \$180 list for veneer models, no upcharge for laminate models; also available in markerboard, specify and add \$401 list

Description	D	W	H	CTN WT	CU FT	① Model	Laminate	Flat Cut Veneer	Double Cut Veneer
Media Wall Space Divider - Markerboard Back	8	60	74	251	34	NAT0860-74MRUM	\$2,361		
	8	60	74	251	34	NAV0860-74MRUM		\$3,355	\$3,902
	8	48	74	206	28	NAT0848-74MRUM	\$2,231		
	8	48	74	206	28	NAV0848-74MRUM		\$3,170	\$3,686
	8	60	84	280	39	NAT0860-84MRUM	\$2,408		
	8	60	84	280	39	NAV0860-84MRUM		\$3,423	\$3,980
	8	48	84	229	32	NAT0848-84MRUM	\$2,289		
	8	48	84	229	32	NAV0848-84MRUM		\$3,256	\$3,788



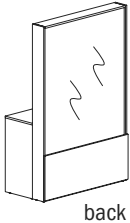
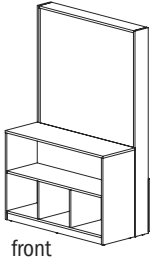
Features:

- not freestanding - must attach to Runoff Table on front side
- back panel is always markerboard
- TV bracket available on the front side, specify and add \$240 list

Options:

- not to be used with side storage towers
- EC36 power available on front side, specify CO_EC36 for cut out and order EC36 separately, see page NA124
- recessed panel on front side available in contrasting laminate color or markerboard, specify color and add \$180 list for veneer models, no upcharge for laminate models; also available in markerboard, specify and add \$401 list

Media Wall Space Divider With Media Shelf - Markerboard Back	23	60	74	380	76	NAT2360-74MSUM	\$3,176		
	23	60	74	380	76	NAV2360-74MSUM		\$4,514	\$5,250
	23	48	74	314	61	NAT2348-74MSUM	\$2,983		
	23	48	74	314	61	NAV2348-74MSUM		\$4,239	\$4,932
	23	60	84	454	86	NAT2360-84MSUM	\$3,519		
	23	60	84	454	86	NAV2360-84MSUM		\$5,002	\$5,818
	23	48	84	377	70	NAT2348-84MSUM	\$3,276		
	23	48	84	377	70	NAV2348-84MSUM		\$4,659	\$5,419



Features:

- media shelf included
- back panel is always markerboard
- media shelf is always same finish as chassis
- not to be used with side storage towers
- TV bracket available on each side, specify and add \$240 list per side

Options:

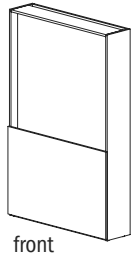
- EC36 power available on front side, specify CO_EC36 for cut out and order EC36 separately, see page NA124
- recessed panel on front side available in contrasting laminate color or markerboard, specify color and add \$180 list for veneer models, no upcharge for laminate models; also available in markerboard, specify and add \$401 list

To Order, Specify:

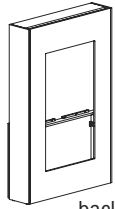
① Laminate Model #	② Chassis	③ Front Panel / ④ Back Panel	⑤ TV Brackets	⑥ Grommet
Laminate (NAT)	See Chassis Laminate Options	WMB - white markerboard laminate; specify and add \$391 or T - laminate panel; see list to left of solid and wood grain laminates	N - None FTV - TV Brkt on Front; add \$234 BTB - TV Brkt on Back; add \$234 ATV - TV Brkt on Front and Back; add \$466	N - None CO EC36 - Cutout for EC36

① Veneer Model #	② Wood Species	③ Chassis Finish	④ Front Panel / ⑤ Back Panel	⑥ TV Brackets	⑦ Grommet
Veneer (NAV)	Flat Cut B01 Black Oak CH1 Cherry MA1 Maple WA1 Walnut	See Flat Cut Chassis Finish Options	V - same Veneer as chassis or WMB - white markerboard laminate; specify and add \$391 or T - laminate panel; see list above of solid and wood grain laminates; specify and add \$175	N - None FTV - TV Brkt on Front; add \$234 BTB - TV Brkt on Back; add \$234 ATV - TV Brkt on Front and Back; add \$466	N - None CO EC36 - Cutout for EC36
	Double Cut DC1 Double Cut	See Double Cut Finish Options			

Description	D	W	H	CTN WT	CU FT	① Model	Laminate	Flat Cut Veneer	Double Cut Veneer
Media Wall	12	60	74	227	39	NAT1260-74CMUF	\$2,276		
	12	60	74	227	39	NAV1260-74CMUF		\$2,952	\$3,434
	12	48	74	193	31	NAT1248-74CMUF	\$2,167		
	12	48	74	193	31	NAV1248-74CMUF		\$2,813	\$3,271
	12	60	84	254	44	NAT1260-84CMUF	\$2,350		
	12	60	84	254	44	NAV1260-84CMUF		\$3,051	\$3,547
	12	48	84	217	35	NAT1248-84CMUF	\$2,234		
	12	48	84	217	35	NAV1248-84CMUF		\$2,898	\$3,371



front



back

NATIVE

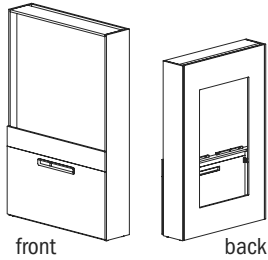
Features:

- not freestanding - must attach to wall
- unfinished back

Options:

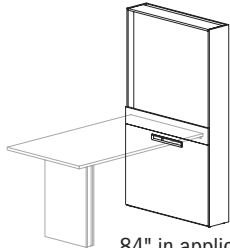
- TV bracket available on the front side, specify and add \$240 list
- EC36 power available on front side, specify CO_EC36 for cut out and order EC36 separately, see page [NA124](#)
- recessed panel on each side available in contrasting laminate color or markerboard, specify color and add \$180 list for veneer models, no upcharge for laminate models; also available in markerboard, specify and add \$401 list

Description	D	W	H	CTN WT	CU FT	① Model	Laminate	Flat Cut Veneer	Double Cut Veneer
Media Wall - Table Mount	12	60	74	229	39	NAT1260-74CMUC	\$2,330		
	12	60	74	229	39	NAV1260-74CMUC		\$3,025	\$3,519
	12	48	74	196	31	NAT1248-74CMUC	\$2,222		
	12	48	74	196	31	NAV1248-74CMUC		\$2,886	\$3,356
	12	60	84	255	44	NAT1260-84CMUC	\$2,406		
	12	60	84	255	44	NAV1260-84CMUC		\$3,123	\$3,632
	12	48	84	218	35	NAT1248-84CMUC	\$2,288		
	12	48	84	218	35	NAV1248-84CMUC		\$2,972	\$3,457



front

back



84" in application

Features:

- not freestanding - must attach to wall and Runoff Table on front side
- unfinished back
- TV bracket available on the front side, specify and add \$240 list

Options:

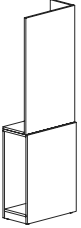
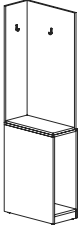
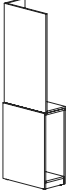
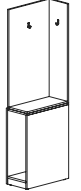
- EC36 power available on front side, specify CO_EC36 for cut out and order EC36 separately, see page NA124
- recessed panel on each side available in contrasting laminate color or markerboard, specify color and add \$180 list for veneer models, no upcharge for laminate models; also available in markerboard, specify and add \$401 list

NATIVE

To Order, Specify:

① Laminate Model #	② Chassis	③ Front Panel / ④ Back Panel	⑤ TV Brackets	⑥ Grommet
Laminate (NAT)	See Chassis Laminate Options	WMB - white markerboard laminate; specify and add \$391 or T - laminate panel; see list to left of solid and wood grain laminates	N - None FTV - TV Brkt on Front; add \$234 BTB - TV Brkt on Back; add \$234 ATV - TV Brkt on Front and Back; add \$466	N - None CO EC36 - Cutout for EC36

① Veneer Model #	② Wood Species	③ Chassis Finish	④ Front Panel / ⑤ Back Panel	⑥ TV Brackets	⑦ Grommet
Veneer (NAV)	Flat Cut B01 Black Oak CH1 Cherry MA1 Maple WA1 Walnut	See Flat Cut Chassis Finish Options	V - same Veneer as chassis or WMB - white markerboard laminate; specify and add \$391 or T - laminate panel; see list above of solid and wood grain laminates; specify and add \$175	N - None FTV - TV Brkt on Front; add \$234 BTB - TV Brkt on Back; add \$234 ATV - TV Brkt on Front and Back; add \$466	N - None CO EC36 - Cutout for EC36
	Double Cut DC1 Double Cut	See Double Cut Finish Options			

Description	D	W	H	CTN WT	CU FT	① Model	Laminate	Flat Cut Veneer	Double Cut Veneer
Side Access Wardrobe Tower	12	24	74	95	16	NAT1224-74SWUR	\$1,903		
	12	24	74	95	16	NAV1224-74SWUR		\$2,469	\$2,872
 left front	12	24	74	95	16	NAT1224-74SWUL	\$1,903		
	12	24	74	95	16	NAV1224-74SWUL		\$2,469	\$2,872
 left back	12	18	74	76	16	NAT1218-74SWUR	\$1,845		
	12	18	74	76	16	NAV1218-74SWUR		\$2,394	\$2,785
 right front	12	18	74	76	16	NAT1218-74SWUL	\$1,845		
	12	18	74	76	16	NAV1218-74SWUL		\$2,394	\$2,785
 right back	12	24	84	108	16	NAT1224-84SWUR	\$1,937		
	12	24	84	108	16	NAV1224-84SWUR		\$2,516	\$2,925
	12	24	84	108	16	NAT1224-84SWUL	\$1,937		
	12	24	84	108	16	NAV1224-84SWUL		\$2,516	\$2,925
	12	18	84	86	13	NAT1218-84SWUR	\$1,874		
	12	18	84	86	13	NAV1218-84SWUR		\$2,432	\$2,827
	12	18	84	86	13	NAT1218-84SWUL	\$1,874		
	12	18	84	86	13	NAV1218-84SWUL		\$2,432	\$2,827

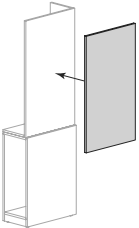
Features:

- not freestanding -must attach to Media Wall or Media Wall- Table Mount
- 74" wardrobe tower attaches to 74" media wall. 84" wardrobe attached to 84" media wall
- unfinished back

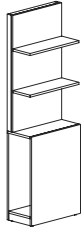
Options:

- additional choice for front panel available in markerboard laminate or corkboard, specify and add \$401 list for markerboard, \$667 list for 18" wide corkboard and \$864 for 24" wide corkboard

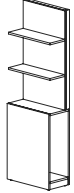
Tackboard for Side Access Wardrobe Tower	¾	24	42	1	2	NAB2442TK	COM	\$232	
	Features:							A	\$267
	· attaches to Wardrobe Tower							B	\$333
	· fabric runs railroad							C	\$449
	· com requirements: 1 yard							D	\$599
								E	\$749
								F	\$982
								G	\$1,232
								H	\$1,496
								I	\$1,911
								J	\$2,410

Tackboard for Side Access Wardrobe Tower	¾	18	42	1	2	NAB1842TK	COM	\$232	
	Features:							A	\$267
	· attaches to Wardrobe Tower							B	\$333
	· fabric runs railroad							C	\$449
	· com requirements: 1 yard							D	\$599
								E	\$749
								F	\$982
								G	\$1,232
								H	\$1,496
								I	\$1,911
								J	\$2,410

Description	D	W	H	CTN WT	CU FT	1 Model	Laminate	Flat Cut Veneer	Double Cut Veneer
Open Shelf Tower	12	24	74	96	16	NAT1224-74SSUR	\$1,997		
	12	24	74	96	16	NAV1224-74SSUR		\$2,591	\$3,014
	12	24	74	96	16	NAT1224-74SSUL	\$1,997		
	12	24	74	96	16	NAV1224-74SSUL		\$2,591	\$3,014
	12	18	74	77	13	NAT1218-74SSUR	\$1,937		
	12	18	74	77	13	NAV1218-74SSUR		\$2,516	\$2,925
	12	18	74	77	13	NAT1218-74SSUL	\$1,937		
	12	18	74	77	13	NAV1218-74SSUL		\$2,516	\$2,925
	12	24	84	109	19	NAT1224-84SSUR	\$2,032		
	12	24	84	109	19	NAV1224-84SSUR		\$2,639	\$3,068
	12	24	84	109	19	NAT1224-84SSUL	\$2,032		
	12	24	84	109	19	NAV1224-84SSUL		\$2,639	\$3,068
	12	18	84	87	14	NAT1218-84SSUR	\$1,965		
	12	18	84	87	14	NAV1218-84SSUR		\$2,551	\$2,966
	12	18	84	87	14	NAT1218-84SSUL	\$1,965		
	12	18	84	87	14	NAV1218-84SSUL		\$2,551	\$2,966



left shown



right

Features:

- not freestanding -must attach to Media Wall or Media Wall- Table Mount
- 74" wardrobe tower attaches to 74" media wall. 84" wardrobe attaches to 84" media wall
- unfinished back

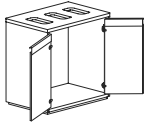
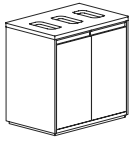
To Order, Specify:

1 Laminate Model #	2 Chasis	3 Front Panel (side access wardrobe only)
Laminate (NAT)	See Laminate Chassis Options	WMB - white markerboard laminate; specify and add \$175 or CKB - corkboard; specify and add \$650 or \$842 or T - laminate panel; see list to left of solid and wood grain laminates

1 Veneer Model #	2 Chasis Finish	3 Front Panel (side access wardrobe only)
Veneer (NAV)	See Flat Cut Chassis Finish Options	V - same Veneer as chassis or WMB - white markerboard laminate; specify and add \$175 or CKB - corkboard; specify and add \$650 or \$842
	3 Chasis Finish See Double Cut Finish Options	

1 Model Number	2 Fabric Selection
(NAB)	Vendor Pattern Color Visit www.jsifurniture.com/finishes-and-materials/textiles for our textiles program. See selection of standard and graded in manufacturers and patterns.

Description	D	W	H	CTN WT	CU FT	① Model	Laminate	Flat Cut Veneer	Double Cut Veneer
Waste Credenza	24	36	36	158	21	NAT2436-36RSC	\$3,596		
	24	36	36	158	21	NAV2436-36RSC		\$4,280	\$4,838



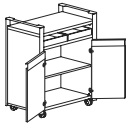
Features:

- accommodates three Uline Thin #H-5148 (23 gallon) trash cans, not included
- must specify solid surface top material, see page [NA3](#)

Options:

- locking doors available, specify and add \$142 list
- laminate doors available in contrasting color, no upcharge, specify color; see page [NA9](#) for details
- veneer doors available in contrasting paint color, no upcharge, specify paint color; see page [NA9](#) for details
- metal available in powder coat, no upcharge, or chrome, add \$318 list upcharge

Hospitality Cart	20	33	40	188	19	NAT2033-40HCD	\$4,692		
	20	33	40	188	19	NAV2033-40HCD		\$5,652	\$6,390



Features:

- four non-locking casters
- hinged door compartment has one fixed shelf

Options:

- two removable trays included, select paint color
- locking doors available, specify and add \$142 list
- metal available in powder coat, no upcharge, or chrome, add \$1,806 list upcharge

Hospitality Cart - Open	20	33	40	173	19	NAT2033-40HCO	\$3,893		
	20	33	40	173	19	NAV2033-40HCO		\$4,579	\$5,058



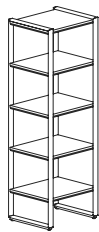
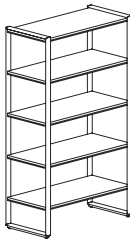
Features:

- four non-locking casters
- open compartment has one fixed shelf

Options:

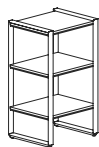
- two removable trays included, select paint color
- metal available in powder coat, no upcharge, or chrome, add \$1,806 list upcharge

Open Shelves	20	42	72	148	42	NAT2042-72SHU	\$4,016		
	20	42	72	148	42	NAV2042-72SHU		\$4,723	\$5,217
	20	24	72	104	25	NAT2024-72SHU	\$3,844		
	20	24	72	104	25	NAV2024-72SHU		\$4,523	\$4,994
	20	42	42	94	24	NAT2042-42SHU	\$3,739		
	20	42	42	94	24	NAV2042-42SHU		\$4,398	\$4,856
	20	24	42	68	14	NAT2024-42SHU	\$3,491		
	20	24	42	68	14	NAV2024-42SHU		\$4,204	\$4,642



42w X 72h

24w X 72h



42w X 42h

24w X 42h

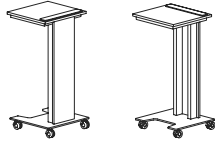
Features:

- 72" units must be loaded from bottom shelf up to be used in open areas
- wall-attachment hardware included

Options:

- metal frame available in powder coat, no upcharge. chrome not an option

Description	D	W	H	CTN WT	CU FT	① Model	Laminate	Flat Cut Veneer	Double Cut Veneer
Mobile Lectern	19	20	40 ½	135	20	NAT2019-40LEC	\$3,181		
	19	20	40 ½	135	20	NAV2019-40LEC		\$3,697	\$3,993



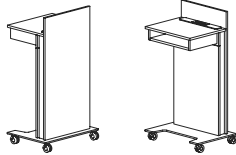
Features:

- cork tray strip on surface for coaster
- specify caster or leveling glide, glide option decreases height by 1 ½"

Options:

- metal available in powder coat, no upcharge, or chrome, add \$1,640 list upcharge

Mobile Lectern with Storage	20	26	47	140	20	NAT2026-47LES	\$4,028		
	20	26	47	140	20	NAV2026-47LES		\$4,737	\$5,211



Features:

- surface height: 40 ½"
- cork tray strip on surface for coasterpower unit standard; two power receptacles, two powered USB
- specify caster or leveling glide, glide option decreases height by 1 ½"

Options:

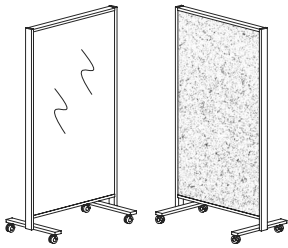
- metal available in powder coat, no upcharge, or chrome, add \$1,742 list upcharge
- microphone available, contact customer service for special quote

To Order, Specify:

① Laminate Model #	② Chassis/Door Front Laminate	③ Metal Color
Laminate (NAT)	See Chassis/Door Front Laminate Options	See Metal Color Options

① Veneer Model #	② Wood Species	③ Chassis Finish - Top	④ Door Front Paint	⑤ Metal Color
Veneer (NAV)	Flat Cut B01 Black Oak CH1 Cherry MA1 Maple WA1 Walnut	See Flat Cut Chassis - Top Finish Options	See Door Front Paint Color Options	See Metal Color Options
	Double Cut DC1 Double Cut	③ Wood Finish - Top See Double Cut Top Finish Options		

Description	D	W	H	CTN WT	CU FT	① Model	List Price
Mobile Board	24	42	75	162	58	NAB2442-75MMB	\$4,334



Features:

- four non-locking casters
- base allows for offset nesting

Options:

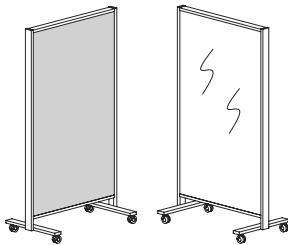
- front and back both available in markerboard or corkboard, add \$714 list for corkboard per side
- metal frame available in powder coat, no upcharge, chrome not an option

NATIVE

Description	D	W	H	CTN WT	CU FT	① Model	List Price Per Grade
-------------	---	---	---	-----------	----------	---------	-------------------------

Mobile Board - Tackboard One Side

24	42	75	1	51	NAB2442-75MTKS	COM \$4,536
----	----	----	---	----	----------------	-------------



Features:

- casters standard
- base allows for offset nesting
- back available in markerboard or corkboard, add \$714 list for corkboard
- com requirements: 1 ½ yards per side

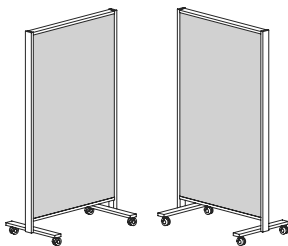
Options:

- metal frame available in powder coat, no upcharge, chrome not an option.

- A \$4,564
- B \$4,616
- C \$4,709
- D \$4,829
- E \$4,947
- F \$5,135
- G \$5,334
- H \$5,546
- I \$5,879
- J \$6,278
- L1 \$5,479
- L2 \$5,747

Mobile Board - Tackboard Both Sides

24	42	75	1	51	NAB2442-75MTKD	COM \$4,418
----	----	----	---	----	----------------	-------------



Features:

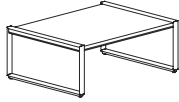
- casters standard
- base allows for offset nesting
- com requirements: 1 ½ yards
- highest grade of fabric used on either side determines cost

Options:

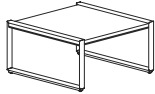
- metal frame available in powder coat, no upcharge. chrome not an option.

- A \$4,473
- B \$4,578
- C \$4,765
- D \$5,005
- E \$5,243
- F \$5,614
- G \$6,013
- H \$6,439
- I \$7,104
- J \$7,900
- L1 \$6,304
- L2 \$6,836

Description	D	W	H	CTN WT	CU FT	① Model	Laminate	Flat Cut Veneer	Double Cut Veneer
Coffee Table	36	48	19	93	24	NAT3648-19TT	\$2,480		
	36	48	19	93	24	NAV3648-19TT		\$2,917	\$3,187
	36	36	19	77	18	NAT3636-19TT	\$2,426		
	36	36	19	77	18	NAV3636-19TT		\$2,851	\$3,044



36d X 48w



36d X 36w

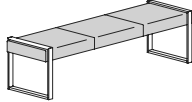
Features:

- two metal, open loop bases

Options:

- metal base frame available in powder coat, no upcharge, or chrome, add list upcharge: for 36" wide - \$2,057, for 48" wide - \$2,241

Description	D	W	H	CTN WT	CU FT	① Model	List Price Per Grade
Bench - Three Seat	20	72	19	68	20	NAB2072-19BEN	COM \$2,646
							A \$2,674
							B \$2,730
							C \$2,826
							D \$2,955
							E \$3,082
							F \$3,277
							G \$3,489
							H \$3,715
							I \$4,066
							J \$4,489
							L1 \$3,869
							L2 \$4,207



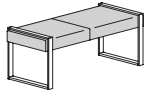
Features:

- two metal, open loop bases
- com requirements: 2 ¼ yards
- col requirements: 50 sq ft

Options:

- metal base frame available in powder coat, no upcharge, or chrome, add \$1,261 list upcharge

Bench - Two Seat	20	48	19	45	14	NAB2048-19BEN	COM \$2,240
							A \$2,258
							B \$2,299
							C \$2,362
							D \$2,448
							E \$2,529
							F \$2,662
							G \$2,803
							H \$2,952
							I \$3,186
							J \$3,468
							L1 \$3,057
							L2 \$3,283



Features:

- two metal, open loop bases
- com requirements: 1 ½ yards
- col requirements: 35 sq ft

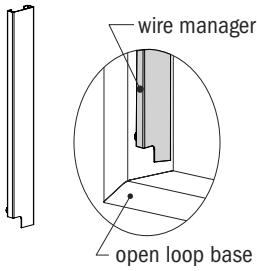
Options:

- metal base frame available in powder coat, no upcharge, or chrome, add \$1,261 list upcharge

To Order, Specify:

① Model Number	② Fabric Selection	③ Metal Color
(NAB)	Vendor Pattern Color Visit www.jsifurniture.com/finishes-and-materials/textiles for our textiles program. See selection of standard and graded in manufacturers and patterns.	See Metal Color Options

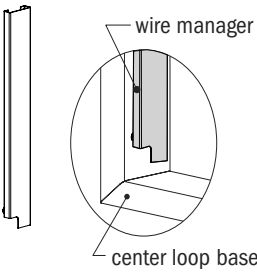
Description	D	W	H	CTN WT	CU FT	① Model	List Price
Wire Manager - Angled Loop Base	2 1/2	3/4	23 1/2	1	1	NAB0301-24LBWM	\$278



Features:

- magnetically attaches to Open Loop Base - used with angled exterior bases
- manage wires from underside of table to the floor
- interior dimensions are 2 3/8" deep x 5/8" wide

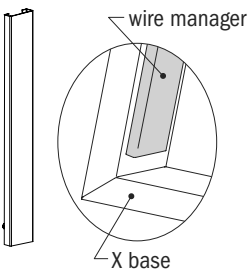
Wire Manager - Center Loop Base	2 1/2	3/4	18 1/2	1	1	NAB0301-19CLBWM	\$278
---------------------------------	-------	-----	--------	---	---	-----------------	-------



Features:

- magnetically attaches to Open Loop Base - used with upright center base
- manage wires from underside of table to the floor
- interior dimensions are 2 3/8" deep x 5/8" wide

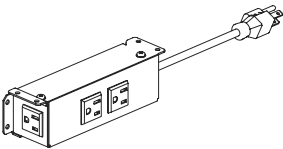
Wire Manager - X Base	2	3/4	23 5/16	1	1	NAB0201-24XBWM	\$278
-----------------------	---	-----	---------	---	---	----------------	-------



Features:

- magnetically attaches to inside of X Loop Base
- manage wires from underside of table to the floor
- interior dimensions are 1 3/4" deep x 1/2" wide

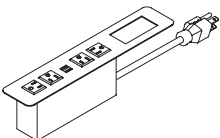
Undermount Convenience Outlet	3 1/8	7 1/8	2 1/8	1	1	EC34	\$294
-------------------------------	-------	-------	-------	---	---	------	-------



Features:

- mounts to underside of table
- Unit is always black
- 108" power cord

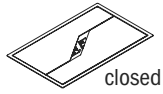
Cove Power Unit	2 1/2	12 1/2	3 1/4	1	1	EC36	\$739
-----------------	-------	--------	-------	---	---	------	-------



Features:

- surface mount power unit
- use with cutout code C; see page [NA15](#) for additional details
- four power receptacles - 120 volt, 15 amp and two powered USB
- unit ships standard with one (1) TCP 101 and one (1) TCP110 Telecom Plate
- 108" power cord

Description	D	W	H	CTN WT	CU FT	Model	List Price
Oasis Mini Power Unit	9	14 3/8	4 3/4	1	1	EC37	\$1,343



closed



open

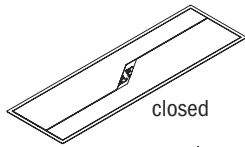
Features:

- undermount power unit with hinged lid
- use with cutout code M; see page 11 for additional details
- four power receptacles - 120 volt, 15 amp and accepts three telecom plates
- accepts Type I telecom plates/jacks, see [accessories price list](#), page GP15
- unit ships standard with three (3) TCP 101 and two (2) TCP110 Telecom Plates
- black interior
- 108" power cord
- UL listed component

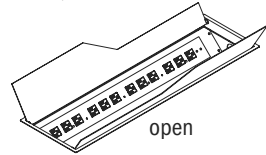
Options:

- must specify metal finish for doors and trim (raw and chrome unavailable)

Oasis Power Unit	9	29 3/8	4 3/4	1	1	EC38	\$2,224
------------------	---	--------	-------	---	---	------	---------



closed



open

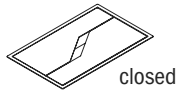
Features:

- undermount power unit with hinged lid
- use with cutout code O; see page 11 for additional details
- twelve power receptacles - 120 volt, 15 amp and accepts four telecom plates
- accepts Type I telecom plates/jacks, see [accessories price list](#), page GP15
- unit ships standard with four (4) TCP 101 and two (2) TCP110 Telecom Plates
- black interior
- two 108" power cords
- UL listed component

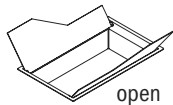
Options:

- must specify metal finish for doors and trim (raw and chrome unavailable)

Small Storage Compartment	9	14 3/8	4 3/4	1	1	EC39	\$1,034
---------------------------	---	--------	-------	---	---	------	---------



closed



open

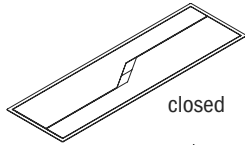
Features:

- storage compartment with hinged lid
- use with cutout code M; see page 11 for additional details
- interior dimensions: 8 1/8" x 13 3/4" x 4"H
- black interior

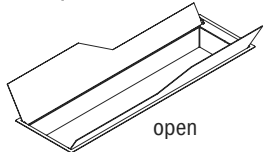
Options:

- must specify metal finish for doors and trim (raw and chrome unavailable)

Large Storage Compartment	9	29 3/8	4 3/4	1	1	EC40	\$1,164
---------------------------	---	--------	-------	---	---	------	---------



closed



open

Features:

- storage compartment with hinged lid
- use with cutout code O; see page 11 for additional details
- interior dimensions: 8 1/8" x 28 3/4" x 4"H
- black interior

Options:

- must specify metal finish for doors and trim (raw and chrome unavailable)

To Order, Specify:

Model Number

Features

Nosh Multi-Purpose tables offer an unequalled breadth of offering for every table application



Tops

- 6 Top Shapes: Rectangular, Rounded Rectangular, Round, Square, Rounded Square and Squircle
- 3 Material Options: Veneer, Laminate and Solid Surface
- 28 Veneer Finishes
- 22 Standard Laminates
- Graded In Laminate Program
- 22 PVC edge options
- 4 solid surface patterns
- 3 Edge Profiles: Eased, Square and Reverse Bevel
- Electrical options

Bases

- 6 Styles: T, X, X4, X Extended, Round Disc, Square Disc
- 5 Metal Finishes, Two-Tone available

Overview



Top Sizes and Shapes	NS3
Laminate Tops	NS4
Veneer Tops	NS11
Solid Surface Tops	NS12
Base Styles	NS13
Power Options	NS14

Tables - 29"h	NS15
Tables - 36"h	NS67
Tables - 42"h	NS115
Power & Wire Management.	NS162

NOSH

Nosh Product Information

Nosh Top Shapes and Sizes

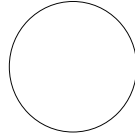
Nosh offers six table top shapes. Tables are available in 29", 36", and 42"h, with the exception of rectangular and rounded rectangular, 30" x 54" and smaller and 36" x 54" and smaller.



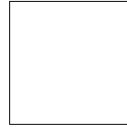
rectangular



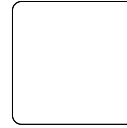
rounded rectangular



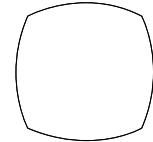
round



square



rounded square



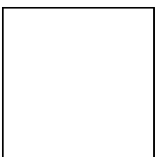
squire

29"h	29"h	29"h	29"h	29"h	29"h
36" x 72" Seats 6	36" x 72" Seats 6	60" Seats 6	60" x 60" Seats 8	60" x 60" Seats 8	60" x 60" Seats 8
36" x 66" Seats 6	36" x 66" Seats 6	54" Seats 6	54" x 54" Seats 6	54" x 54" Seats 6	54" x 54" Seats 6
36" x 60" Seats 4	36" x 60" Seats 4	48" Seats 4	48" x 48" Seats 4	48" x 48" Seats 4	48" x 48" Seats 4
36" x 54" Seats 4	36" x 54" Seats 4	42" Seats 4	42" x 42" Seats 4	42" x 42" Seats 4	42" x 42" Seats 4
36" x 48" Seats 4	36" x 48" Seats 4	36" Seats 3	36" x 36" Seats 4	36" x 36" Seats 4	36" x 36" Seats 4
		30" Seats 3	30" x 30" Seats 4	30" x 30" Seats 4	30" x 30" Seats 4
30" x 72" Seats 6	30" x 72" Seats 6				
30" x 66" Seats 4	30" x 66" Seats 4				
30" x 60" Seats 4	30" x 60" Seats 4				
30" x 54" Seats 4	30" x 54" Seats 4				
30" x 48" Seats 4	30" x 48" Seats 4				
36"h	36"h	36"h	36"h	36"h	36"h
36" x 72" Seats 6	36" x 72" Seats 6	60" Seats 6	60" x 60" Seats 8	60" x 60" Seats 8	60" x 60" Seats 8
36" x 66" Seats 6	36" x 66" Seats 6	54" Seats 6	54" x 54" Seats 6	54" x 54" Seats 6	54" x 54" Seats 6
36" x 60" Seats 4	36" x 60" Seats 4	48" Seats 4	48" x 48" Seats 4	48" x 48" Seats 4	48" x 48" Seats 4
		42" Seats 4	42" x 42" Seats 4	42" x 42" Seats 4	42" x 42" Seats 4
		36" Seats 3	36" x 36" Seats 4	36" x 36" Seats 4	36" x 36" Seats 4
		30" Seats 3	30" x 30" Seats 4	30" x 30" Seats 4	30" x 30" Seats 4
42"h	42"h	42"h	42"h	42"h	42"h
36" x 72" Seats 6	36" x 72" Seats 6	60" Seats 6	60" x 60" Seats 8	60" x 60" Seats 8	60" x 60" Seats 8
36" x 66" Seats 6	36" x 66" Seats 6	54" Seats 6	54" x 54" Seats 6	54" x 54" Seats 6	54" x 54" Seats 6
36" x 60" Seats 4	36" x 60" Seats 4	48" Seats 4	48" x 48" Seats 4	48" x 48" Seats 4	48" x 48" Seats 4
		42" Seats 4	42" x 42" Seats 4	42" x 42" Seats 4	42" x 42" Seats 4
		36" Seats 3	36" x 36" Seats 4	36" x 36" Seats 4	36" x 36" Seats 4
		30" Seats 3	30" x 30" Seats 4	30" x 30" Seats 4	30" x 30" Seats 4

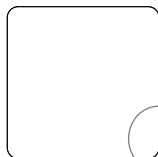
HSON

Corner Details

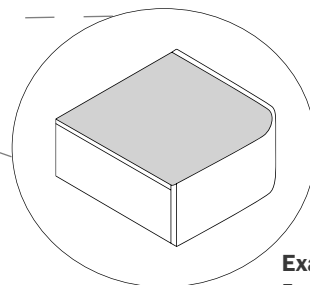
A more inviting approach can be achieved by selecting Rounded Corners on either Rectangular or Square Tables.



Square Corner



Rounded Corner



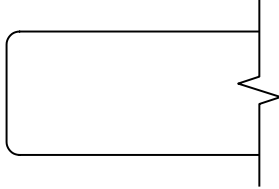
Example

Eased (R3) PVC edge laminate with rounded corner

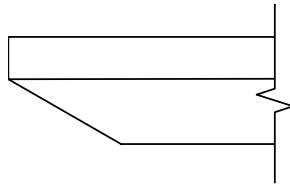
Nosh Product Information

Laminate Tops

HPL tops are 1 3/16" thick, 3 ply construction. The laminate face is horizontal grain or solid high pressure laminate. Particle board core and a phenolic backer sheet complete the balanced construction.



Eased Edge (R3)
PVC



Reverse Bevel (K9)
PVC on painted top of painted MDF

Standard PVC Edge Colors

JSI supports 22 standard PVC edge colors listed below. These coordinate with our Standard (Tier1) Laminates.

When selecting a Standard (Tier 1) Laminate, the coordinating PVC edge color is automatically applied. When selecting a Graded-In Laminate (Tier 2 or 3), you will be prompted to choose one these 22 PVC edge colors to be applied to the edge.

ALB Alabaster	MIN Mineral
ALL Ale Light	OAT Oatmeal Cookie
BLK Black	PIN Pinnacle Walnut
BOL Bourbon Light	PLT Platinum
BZW Brazilwood	SHD Shadow
BBL Bridal Blanco	SLG Slate Grey
BGL Brighton Light	STU Studio Teak
CLL Collectors	UMB Umber
DWH Designer White	VAL Valley
DOV Dove Grey	VIN Vintage
FAW Fawn	WEA Weathered Ash
GRH Graphite	

Standard Laminates

JSI Standard Laminate program consists of 22 solid and wood grain patterns, and establish our Tier 1 laminate pricing. Each has a coordinating PVC edge color that is automatically used with the Standard Laminates.

Wood Grain Laminate

ALL Ale Light	MIN Mineral
BOL Bourbon Light	OAT Oatmeal Cookie
BZW Brazilwood	PIN Pinnacle Walnut
BGL Brighton Light	STU Studio Teak
CLL Collectors	UMB Umber
FAW Fawn	VAL Valley
FLO Florence Walnut	VIN Vintage
GRH Graphite	WEA Weathered Ash

Solid Laminate

ALB Alabaster
BLK Black
BBL Bridal Blanco
DWH Designer White
SHD Shadow
SLG Slate Grey



Formica Laminate Tier

JSI offers an extensive program for laminates beyond our Standard Program. Always reference our website for the most current listing when using a [Graded-In Laminate](#), on page NS4 select the color of the PVC edge color.

NS4

Laminate	Pattern #	Tier	Laminate	Pattern #	Tier	Laminate	Pattern #	Tier
Acajou Mahogany	7008-43	2	Folkstone Grafix	507-58	2	Planked Deluxe Pear	6206-43	2
African Limba	7011-43	2	Fossil	5349-PX	3	Planked Raw Oak	7412-PG	3
Algae	8796-PG	3	Fox Teakwood	8907-NG	3	Planked Urban Oak	9312-NG	3
Almond	920-58	2	Ginger Root Maple	7288-58	2	Portico Marble	7735-58	2
Amber Maple	7012-58	2	Glamour Cherry	6208-43	2	Prestige Walnut	6209-43	2
Antique White	932-58	2	Graphite	837-58	2	Pumice	858-58	2
Ashen Ribbonwood	8839-58	2	Graphite Grafix	515-58	2	Rattan Cane	3699-58	2
Autumn Indian Slate	3687-58	2	Graphite Twill	8829-58	2	Raw Birchply	8910-NG	3
Basalt Slate	3690-34	3	Graystone	464-58	2	Raw Cedar	1545-PG	3
Beluga Beige	3698-58	2	Green Felt	4974-PA	3	Reclaimed Denim Fiber	9271-PX	3
Black	909-58	2	Green Slate	8793-58	2	Rolled Steel	8917-58	2
Black Birchply	8552-NG	3	Green Slate Birchply	8911-NG	3	Sail White	463-PX	3
Black Recycled Kraft	9685-58	2	Greige Softwood	4924-NG	3	Salvage Planked Elm	9480-58	2
Black Riftwood	6414-NG	3	Hard Rock Maple	86992-58	2	Sand Crystall	3517-58	2
Black Walnut	3485-58	2	Infinity Duotex	6448-58	2	Sarum Grey	2770-58	2
Blackened Fiberwood	8916-NG	3	Ivory Kashmir	6226-58	2	Sarum Twill	8827-58	2
Blackened Legno	8848-58	2	Jamocho Granite	7734-46	3	Seasoned Planked Elm	6477-NG	3
Blackened Steel	8918-58	2	Jarraah Legno	8847-58	2	Select Cherry	7759-43	2
Bleached Legno	8845-58	2	Just Rose	8858-PX	3	Silver Oak Herringbone	9311-58	2
Blond Cedar	8576-PG	3	Labrador Granite	3692-46	3	Silver Riftwood	6413-NG	3
Blossom Cherrywood	758-58	2	Layered Black Sand	9510-34	3	Smoky Brown Pear	5488-NT	2
Blue Felt	9320-PA	3	Layered Sand	9511-34	3	Smoky Walnut Woodline	6926-NT	2
Blush	8238-PX	3	Layered White Sand	9512-34	3	Solar Orange	8235-PX	3
Brite White	459-58	2	Lime Stone	7264-58	2	Sorrel Cherry	5886-43	2
Bronzed Steel	8919-58	2	Macchiato Walnut	6932-NT	2	Spectrum Blue	851-58	2
Bubble Art	8958-58	2	Maple Woodline	6925-NT	2	Spectrum Green	7897-58	2
Bubble Organic	8957-58	2	Marine Blue	914-58	2	Spectrum Red	845-58	2
Bubble Science	8956-58	2	Matrix Blue	8795-58	2	Stone Grafix	503-58	2
Burnt Strand	6307-58	2	MDF Solidz	7812-58	2	Stop Red	839-58	2
Butcherblock Maple	204-58	2	Millennium Oak	5887-NT	2	Storm	912-58	2
Cardboard Solidz	7813-58	2	Mineral Spa	6920-58	2	Storm Solidz	3505-SP	3
Carrara Envision	7494-58	2	Mission White	933-58	2	Storm Teakwood	8908-NG	3
Cascara Teakwood	8909-NG	3	Mojave	8751-58	2	Surf	923-58	2
Cassis	6903-58	2	Moonstone	7872-PX	3	Terril	2297-PX	3
Charcoal Boomerang	6942-58	2	Mouse	928-58	2	Thermo Walnut	6402-43	2
Charred Formwood	6416-NT	2	Natural Ash	8843-WR	3	Tinted Paper Terrazzo	8812-PA	3
Cherry Birch	7484-58	2	Natural Birch	7481-58	2	Tonal Paper Terrazzo	8813-PA	3
Cherry Riftwood	6411-NG	3	Natural Cane	6930-NT	2	Travertine	3526-58	2
Chestnut Woodline	5884-58	2	Natural Canvas	7022-58	2	Vibrant Green	6901-58	2
Chocolate Warp	5881-58	2	Natural Cherry	7737-58	2	Victorian Mahogany	7583-58	2
Chrome Yellow	1485-58	2	Natural Gray Felt	4971-PA	3	Violin Figured Annigre	7285-58	2
Citadel	1097-MC	3	Natural Maple	756-58	2	Walnut Fiberwood	8915-NG	3
Citadel Warp	5882-58	2	Natural Oak	346-58	2	Walnut Riftwood	9283-NG	3
Cocoa Maple	7739-58	2	Natural Recycled Kraft	9684-58	2	Walnut Softwood	4925-NG	3
Cognac Maple	7738-58	2	Natural Teak	8849-58	2	Washed Knotty Ash	6438-58	2
Concrete Formwood	6362-NT	2	Natural Walnut	6401-43	2	Waxed Maple	8905-58	2
Concrete Stone	7267-58	2	Navy Blue	969-58	2	Weathered Beamwood	6410-NG	3
Cream Softwood	4923-NG	3	Navy Grafix	7018-58	2	Weathered Fiberwood	8914-NG	3
Danish Maple	8906-58	2	Neutral Twill	8826-58	2	Wenge Strand	6306-58	2
Dark Chocolate	2200-SP	3	Neutral Weft	5875-58	2	Wheat Strand	6212-58	2
Denim Twill	8814-58	2	Neutral White	918-58	2	White	949-58	2
Desert Beige	899-58	2	New Burgundy	7966-58	2	White	949-MC	3
Dogbone White	5281-58	2	Night Forest	8244-58	2	White	949-SP	3
Dover White	7197-58	2	Night Shade	8243-58	2	White Ash	8841-WR	3
Earth	5342-SP	3	Nocturne	5323-58	2	White Drops	8824-58	2
Earth Wash	7213-58	2	Noir Cedar	1547-PG	3	White Ice Granite	9476-43	2
Earthen Twill	8828-58	2	Oak Fiberwood	8913-NG	3	White Painted Wood	8902-NG	3
Earthen Warp	5880-58	2	Oiled Legno	8846-58	2	White Twill	9285-58	2
Earthenware	8241-58	2	Oiled Olivewood	5481-43	2	White Washed Birchply	6372-NG	3
Ebony	9012-NT	2	Oiled Walnut	5487-NT	2	Wild Cherry	5904-43	2
Ebony Oxide	299-58	2	Orange Felt	4973-PA	3	Winter Sky	8792-58	2
Elemental Concrete	8830-58	2	Otter	3202-58	2	Winter Sky Birchply	8912-NG	3
Elemental Stone	8831-58	2	Oxidized Beamwood	9484-NG	3	Yellow Felt	4972-PA	3
Enamel	8794-58	2	Oyster Gray	929-58	2	Zebrano	9011-NT	2
Espresso Pear	5489-NT	2	Paint Scrape Sky	8995-PX	3			
Figured Annigre	7284-58	2	Paint Scrape Steel	8994-PX	3			
Finnish Oak	118-58	2	Paloma Polar	6698-58	2			
Flax Gauze	7708-58	2	Pearl	934-58	2			
Fog	961-58	2	Pecan Woodline	5883-58	2			
Folkstone	927-SP	3	Pencil Wood	7747-58	2			
Folkstone Celesta	692-58	2	Planked Coffee Oak	7413-PG	3			

Nevamar Laminate Tier

JSI offers an extensive program for laminates beyond our Standard Program. Always reference our website for the most current listing when using a [Graded-In Laminate](#), on page NS4 select the color of the PVC edge color.

Laminate	Pattern #	Tier	Laminate	Pattern #	Tier	Laminate	Pattern #	Tier
Adaptable Muse	VU6001 T	3	Crema-ARP	WZ0049 T	3	Legendary Teak	WT0004 T	3
Aged Elements	EM6001 T	3	Crema-Timberline	WZ0049 TL	3	Liberty Red-ARP	S1027 T	3
Almond-ARP	S2037 T	3	Crème Tranquility	TQ2001 T	3	Liberty Red-Linez	S1027 LZ	3
Aluminite	AM6001 T	3	Crest Mahogany	W8343 PV	3	Limeade-ARP	SV7410 T	3
Amber Pearwood	WM8342 T	3	Crown Cherry	W8294 T	3	Limeade-Fineline	SV7410 FL	3
Antique White	S7005 T	3	Cutting Edge	WZ2009 T	3	Lino Frieze	FZ2001 T	3
Antoccino	WK0022 T	3	Decadent Allusion	ALN002 T	3	Luminary Teak	WT0005T	3
Aqua Lagoon	S5059 T	3	Deep Blue	S3022 T	3	Lunaria Shadow	LU6001 T	3
Babbling Brook	WW7800 T	3	Dove Gray	S6003 T	3	Macchiato-Aged Bark	WF0011 AB	3
Bailey-ARP	WK0027 T	3	Dragonfly	WZ0062 T	3	Macchiato-ARP	WF0011 T	3
Bailey-Fineline	WK0027 FL	3	Dry Creek Plum	WZ6001 T	3	Madura Gold Granite	GR4001 T	3
Basic Black Hautelink	HLT001 T	3	Easy Elegance	VA5002 T	3	Maize Shibori	SH2002 T	3
Basic	S2110 T	3	Edenwood	WF0001 T	3	Mallow White	S7038 T	3
Beige	S2019 T	3	Eiskaffe	WZ0056 T	3	Manhattan Glamour	MH6001 T	3
Beige Renaissance	WM8258 T	3	Endless Journey	WW0900 VE	3	Manhattan Gleam	MH8001 T	3
Bethany Beige	S2069 T	3	English Lace	S2085 T	3	Manhattan Glitz	MH4001 T	3
Birch Matrix	MR6008 T	3	Extreme Green Bamboo	WZ5001 T	3	Maritime Gray	S6027 T	3
Black Lodestone	LD6001 T	3	Fiji-ARP	SB0300 T	3	Marocchino	WK0023 PV	3
Black Pearl	S6014 T	3	Fiji-Fineline	SB0300 FL	3	Marrakesh Express	KH2001 T	3
Black-ARP	S6001 T	3	Fine Sycamore	W8351 T	3	Mazagran	WZ0052 T	3
Blissful Path	AT8000 T	3	Fossil Gray	S6031 T	3	Mikado Woodprint	WZ0002 T	3
Blossom Cherry	WC5581 MG	3	Foundry	S2084 T	3	Modern Edge	WZ6004 T	3
Blue Lunaria	LU3001 T	3	Frappe	LN6001 T	3	Natural Bamboo	WZ0018 T	3
Blue Shimmer Hautelink	HLB001 T	3	French Blue matrix	MR3003 T	3	Natural Beige	S2063 T	3
Bohemian Edge	W01400 WE	3	Fresh Papaya	S8001 T	3	Navy Matrix II	MR3008 T	3
Bone White	S7032 T	3	Galao	WX0075 AB	3	Neutra Matrix	MR2003 T	3
Botanical Allusion	AL5002 T	3	Galloway Burl	WZ0017 T	3	Neutra	S7025 T	3
Brave Spirit	WU0060 T	3	Garden Mist	SG0004 T	3	Neutral Gray	S6012 T	3
Breve	WZ0054 T	3	Giant Gray Bamboo	WX1150 PV	3	Ochre Tempura	TM2001 T	3
Burgundy	S1015 T	3	Glistening Trail	WH1000 WE	3	Outer Limits	WU0010 WE	3
Café Allusion	AL2004 T	3	Golden Allusion	AL2002 T	3	Painted Woodlands	PDG002 T	3
Café Sienna	S03300 T	3	Golden Anigre	WA0001 SD	3	Palazzo	WK0024 T	3
Calcutta Marble	MW5800 SD	3	Golden Ash	WM8110 T	3	Papier Au Lait	PR2002 T	3
Calm Distinction	VA6001 T	3	Golden Years	AY1300 SD	3	Paris White Potteryware	PO7001 T	3
Caluna Cherry	WC2001 T	3	Grand Isle Maple	W8371 T	3	Passionfruit-ARP	SR5240 T	3
Calypso	WZ0057 T	3	Graphite Blue	S3023 T	3	Passionfruit-Fineline	SR5240 FL	3
Canyon Fissure	FS2001 T	3	Gray Matrix	MR6001 T	3	Patriot Blue	S3048 T	3
Carajillo	WZ0055 T	3	Gray Tranquility	TQ6001 T	3	Penny Lane-Textured		
Caribbean Blue	S3070 T	3	Green Matrix II	MR5007 T	3	Suede	AT7500 SD	3
Carmel Sagawood	WM8350 T	3	Greige Matrix	MR2002 T	3	Penny Lane-Timberline	AT7500 TL	3
Carmen Red	S1049 T	3	Gunmetal	S6020 T	3	Phantom Gray Matrix	MR6007 T	3
Casa Piedra	CK2002 T	3	Herbal Allusion	AL5001 T	3	Porcelain	S2050 T	3
Chai	WK0025 T	3	Honey Maple-ARP	WM8322 T	3	Precision White	S7036 T	3
Chalk White-ARP	S7024 T	3	Honey Plantain	S4025 T	3	Pure Spun Yarn	YSN002 T	3
Chalk White-Barnboard	S7024 BB	3	House Rock	RK4001 T	3	Rare Earth Slate	SL6003 T	3
Chalk White-Groovy	S7024 GV	3	Hybrid Slate	SL6002 T	3	Raven	S6033 T	3
Champagne Sagawood	WM8349 T	3	Iconic Maple-Aged Bark	WM0047 AB	3	Recon Oak	WZ0005 MG	3
Charcoal Essence	ES6002 T	3	Iconic Maple-ARP	WM0047 T	3	Red Dragon Bamboo	WZ1001 T	3
Charcoal Fusion	FN6001 T	3	Illustrious Maple	WM0046 T	3	Red Hot Allusion	ALR003 T	3
Charcoal Matrix	MR6002 T	3	Ivory Essence	ES2001 T	3	Regency Mahogany	W8352 VE	3
Cinder Gray Matrix	MR6006 T	3	Jett Black-ARP	S6053 T	3	Regimental Blue	S3016 T	3
Classic Rock	RK2001 T	3	Jett Black-Groovy	S6053 GV	3	Roaring Wind	WX8500 VE	3
Clear Maple	WM8340 T	3	Jett Black-Super Matte	S6053 SM	3	Rollin' Rock	RK2002 T	3
Cocoa Bean-ARP	S2115 T	3	Jute	S2086 T	3	Royal Mahogany	WS9450 MG	3
Cocoa Bean-Groovy	S2115 GV	3	Kendo	WZ2004 T	3	Rugged Trail	WH0050 PV	3
Cognac Birdseye	W8348 VE	3	Kindred Spirit	WU0030 WE	3	Rush	FS6001 T	3
Cool Chic	VA7002 T	3	Kona Blend	WZ0028 PV	3	Rustic Quartered Oak	WM8164 T	3
Copper Fusion 2	FN1002 T	3	Kool Kiwi	S5057 T	3	Sandcastle	S2093 T	3
Cordial Gray	S6024 T	3	Kopi Susu	LN6002 T	3	Sandpiper	S6047 T	3

Nevamar Laminate Tier (Continued)

JSI offers an extensive program for laminates beyond our Standard Program. Always reference our website for the most current listing when using a [Graded-In Laminate](#), on page [NS4](#) select the color of the PVC edge color.

Laminate	Pattern #	Tier	Laminate	Pattern #	Tier
Santa Rosa Plum	WZ2001 T	3	Vous Metal	VS6001 T	3
Scandia Maple	WM5577 SD	3	Vous Serene	VS5002 T	3
Serene Stardom	VA5001 T	3	Vous Tempest	VS6002 T	3
Shibui Woodprint	WZ0001 T	3	Wall Street Allusion	ALT005 T	3
Sienna Essence	ES2003 T	3	Washington Apple	WF0002 SD	3
Silver Alu Metalx	MXT003 T	3	Weathered Storm	WP3000 AB	3
Silver Dollar-Linez	AG8000 LZ	3	Whispering Wind	WX4600 VE	3
Silver Dollar-Textured Suede	AG8000 SD	3	White Essence	ES7001 T	3
Silver Wings	AG6300 SD	3	White Phantasy	PH7001 T	3
Silverline Hautelink	HLT004 T	3	Wild Oats Matrix	MR7002 T	3
Simplicity	W07100 WE	3	Winter Gray Matrix	MR6005 T	3
Siren Maple	WM0005 T	3	Woodstock Granite	GR2004 T	3
Smoky White	S7027 T	3	Wrought Iron	S6054 T	3
Solid White	S7004 T	3	Xanadu Blue Bamboo	WZ3001 T	3
Sovereign Cherry	W8325 T	3	Yunnan	WZ0063 T	3
Spa White	S7040 T	3	Zebrano White	WZ0080 TL	3
Spicy Flavors	S8002 T	3	Zulu	WZ0053 T	3
Stainless Metalx	MXT002 T	3			
Stepping Stone	AE0500 SD	3			
Storm Gray Matrix	MR6004 T	3			
Stout Walnut	WW3100 T	3			
Straightaway Oak	W00040 T	3			
Straw Matrix	MR2006 T	3			
String	S6052 T	3			
Studio Gray	S6037 T	3			
Studio White Matrix	MR7001 T	3			
Summer Night Glow	S8003 T	3			
Sunbeam	WW9000 WE	3			
Sunken Treasure	S3068 T	3			
Sunray	S4022 T	3			
Tangier Anigre	WA0002 SD	3			
Tawny Satinwood	WZ003 T	3			
Tea Stain Spun Yarn	YSN001 T	3			
Tendu	WZ2007 PV	3			
Topaz Khayawood	W8369 T	3			
Tranquility	WA3000 VE	3			
Tropical Allusion	ALB001 T	3			
Tyrian Purple	SP4170 T	3			
Umber Tempera	TM2002 T	3			
Untold Journey	WW4400 VE	3			
Urban Garden	AV2100 T	3			
Urban Life	AG1900 T	3			
Valencia Teak	WT0003 PV	3			
Validate We Do	WZ0045 T	3			
Vanilla Bean	VS2002 T	3			
Vantage Point Walnut	WW0013 MG	3			
Varnish	VS2003 T	3			
Venerable Old Oak-ARP	WK0017 T	3			
Venerable Old Oak-Barnboard	WK0017 BB	3			
Verdict's In	RK6003 T	3			
Vermont Maple	WM5528 SD	3			
Veta Shadows	VE6001 T	3			
Veto Proof	RK7002 T	3			
Violine	S3055 T	3			
Visible Vava	VA2001 T	3			
Vision Vava	VA2002 T	3			
Vous Fawn	VS2001 T	3			

HSON

Pionite Laminate Tier

JSI offers an extensive program for laminates beyond our Standard Program. Always reference our website for the most current listing when using a [Graded-In Laminate](#), on page NS4 select the color of the PVC edge color.

Laminate	Pattern #	Tier	Laminate	Pattern #	Tier	Laminate	Pattern #	Tier
A Good Book	WW120-WE	3	Dolphin Gray	SG246-SD	3	Mellow Marron	AT965-SD	3
Abraham	MG130-SX	3	Earle Gray Sorbe	WZ160-WE	3	Mercury	SG204-SD	3
Absolute Acajou -Textured Suede	WY160-SD	3	Eggshell White-Suede	CW803-SD	3	Meteoritic Metallo	AG180-SD	3
Absolute Acajou - Timberline	WY160-TL	3	Eggshell White -Textured Suede	SW803-SD	3	Millwork Cherry	WC431-PV	3
Afternoon Nap	WA120-SD	3	Estella	AG011-SD	3	Mineral Talc	AG381-SD	3
Afternoon Showers	HP360-SD	3	Faded Memories	ME100-SD	3	Mocha Almond Fudge	WX600-SD	3
Agatha	AT181-SD	3	Fine Oak	WO951-SD	3	Molten Lava	WP130-SD	3
Aimtoo Savatre	WC115-SD	3	First Kiss -Fineline	SR537-FL	3	Moon Dust	MG115-SX	3
Almond -Textured Suede	ST655-SD	3	First Kiss -Textured Suede	SR537-SD	3	Moonlighting Papel	AV971-SD	3
Amber Curly Maple	WM221-SD	3	First N Main	AG031-SD	3	Moss Gray	SG240-SD	3
America's Pastime	WE360-SD	3	Folkstone Gray	SG241-SD	3	Mud Pie	AT970-LR	3
Angel White -Textured Suede	CW826-SD	3	Formal Mahogany	WY031-SD	3	Navajo Red	SR505-SD	3
Anigre	WX041-SD	3	Forsythia	SY913-SD	3	Navy Blue	SB007-SD	3
Appears Likatre	WP115-SD	3	Frederick	MT310-GR	3	Negotiating in Geneva	PFA60-SD	3
Arctic Flash	ME051-SD	3	Fresh Cut Grass -Textured Suede	SV750-SD	3	Nubian Brown	ST604-SD	3
Ash Gray	SG254-SD	3	Galactic Dust	MG180-SD	3	Oiled Cherry	WC421-SD	3
Azzurra	AB081-SD	3	Ginger Snap	AY120-SD	3	Old Friend	AG415-SD	3
Backwoods Sycamore	HP689-SD	3	Gold Pannin	AT710-SD	3	Olive Organix	AV674-SD	3
Bankers Gray -Textured Suede	SG214-SD	3	Grandiose Grid	AT106-SD	3	Opti Gray	SG213-SD	3
Beachcomber	AT988-SD	3	Graphite Spektrum	AE021-SD	3	Opto Printatre	WX230-SD	3
Beige Linen	AT301-SD	3	Graphite Talc	AG361-SD	3	Ornate Oak	WO095-SD	3
Bernard	MG071-GR	3	Graveyard of the Atlantic	AG611-SD	3	Passin Through	AV250-SD	3
Bittersweet	SO312-SD	3	Greige -Textured Suede	SG210-SD	3	Peach Cobbler	WT850-SD	3
Black Forest Cake	WX440-SD	3	Gridlock in L.A.	PFA51-SD	3	Peanut Brittle	WZ150-SD	3
Black -Textured Suede	SE101-SD	3	Gunstock Savoy Walnut	WW971-SD	3	Pearl of the Orient	AG601-SD	3
Blueberry Hill	SB040-SD	3	Happy Hour	AB400-SD	3	Pearwood	WX031-SD	3
Butter Toffee	WC230-PV	3	Hardrock Maple	WM791-SD	3	Pepperdust	HP451-SD	3
Cake Batter	AG500-LR	3	Harold	MG120-SX	3	Picnic In The Park -Super Matte	WA030-SM	3
Cardamom Fiber	AG371-SD	3	Hazel	MT390-SX	3	Picnic In The Park - Textured Suede	WA030-SD	3
Carnation White -Ashwood	SW806-AW	3	Head Over Heels -Fineline	AB300-FL	3	Polar Cap	MW570-SL	3
Carnation White -Textured Suede	SW806-SD	3	Head Over Heels -Textured Suede	AB300-SD	3	Pralines & Cream -Fineline	WW160-FL	3
Catching Fireflies	WA110-SD	3	Hearth Oak	WO862-SD	3	Pralines & Cream - Textured Suede	WW160-SD	3
Cavalcade South	AT650-SD	3	Hedgerow	MG170-SL	3	Primary Red	SR520-SD	3
Celery Fiber	AV751-SD	3	Honey Maple -Textured Suede	WM951-SD	3	Primary Yellow	SY914-SD	3
Chamomile Fiber	AT291-SD	3	Ice Fishin	WF181-SD	3	Pumice	SG203-SD	3
Charcoal Chromatix	AE011-CR	3	Ice White	SW813-SD	3	Pyrenees Marble	ME011-GL	3
Chocolate Malt	WC210-PV	3	IL Palio Papel	AV981-SD	3	Rock Around the Clock	MT340-SD	3
Cinder Gray Concrete	AG471-SD	3	Indigo Blue	SB006-SD	3	Rock Around the Clock II	MT500-SD	3
Cinnamon Noce	WW601-SD	3	Ingot Gray	SG211-SD	3	Rock of Ages	AW141-SD	3
City of Lights	MT330-SD	3	Jewel Mahogany-Textured Suede	WY351-SD	3	Rocky Mountain High	AT161-SD	3
Clear Ash	WA001-SD	3	Jumping In Puddles	AG801-SD	3	Royal Blue	SB009-SD	3
Coastal Cottage	WC652-WE	3	Kingsley-Aged Bark	WW011-AB	3	Royal Burgundy	SP401-SD	3
Connected Cubes	AT440-SD	3	Kingsley -Textured Suede	WW011-SD	3	Sable	AG021-SD	3
Cookies & Cream	AG130-SM	3	Leave Likatre	WP120-SD	3	Sage Coral	AV781-SD	3
Cool Autumn Night	WT880-SD	3	Licorice Stick	WP140-SD	3	Seems Likatre	WP125-SD	3
Coriander Fiber	AT981-SD	3	Limestone	SG208-SD	3	Shaker Cherry	WC521-SD	3
Cornwall	MT440-SD	3	Little Black Dress	AE100-PV	3	Sherwood Oak	WO891-SD	3
Crackle Crunch	WO680-LZ	3	Looks Likatre	WP110-SD	3	Shooting Star	AG041-SX	3
Cradle of Liberty	AB221-SD	3	Louise	MR120-SX	3	Silvio	WY131-SD	3
Cressida	AT371-SD	3	Love Letters	AW300-SD	3	Sipping Seattle Java	PFA48-SD	3
Crisscross	AT660-SD	3	Lunar Legno	WX800-SD	3	Slate	SG228-SD	3
Cubicle Papel	AG561-SD	3	Macadamia Nut	AG071-SD	3	Sleeping In -Textured Suede	WT870-SD	3
Daydreaming	AG750-SD	3	Man On The Moon	MT250-SD	3	Sleeping In -Timberline	WT870-TL	3
Dining By Candle Light	WA090-SD	3	Manila Linen	AT231-SD	3	Smooth Paddlin	WX110-SD	3

Pionite Laminate Tier (Continued)

JSI offers an extensive program for laminates beyond our Standard Program. Always reference our website for the most current listing when using a [Graded-In Laminate](#), on page NS4 select the color of the PVC edge color.

Laminate	Pattern #	Tier
S'mores	WP500-LZ	3
Spice Walnut	WW561-SD	3
Springtime	SV709-SD	3
Stargazing	AE060-SD	3
Stonedust	SG224-SD	3
Storm Gray	HP565-SD	3
Sugar Maple II	WM115-SD	3
Sugar Pie	AG081-SM	3
Summer Vacation - Textured Suede	SB027-SD	3
Sunset	HP336-SD	3
Sweet 16 -Fineline	SR525-FL	3
Sweet 16 -Textured Suede	SR525-SD	3
Tailgating	WT860-SD	3
Taj Teak	WT741-SD	3
Taupe	ST606-SD	3
Tea Party in Boston	PFA42-SD	3
Theodore	MR125-SX	3
Thunderstorm	HP359-PV	3
Tiramisu	WX170-SD	3
Toasted Coconut	WZ460-WE	3
Travelin Light	AT680-SD	3
Upland Stone	MG160-SL	3
Vana	WF131-SD	3
Vanilla Fiber	AW871-SD	3
Victorian Cherry	WC331-PV	3
Viola	AT191-SD	3
Walnut Grove -Textured Suede	WW050-SD	3
Walnut Grove -Timberline	WW050-TL	3
Wedding Cake -Barnboard	WT790-BB	3
Wedding Cake -Textured Suede	WT790-SD	3
Wheat Fiber	AT991-SD	3
White Elm -Super Matte	WE261-SM	3
White Elm -Textured Suede	WE261-SD	3
White Fiesta	MW550-SD	3
White	SW811-SD	3
White Spektrum	AW785-SD	3
Winter White -Textured Suede	SW836-SD	3
Wisconsin Oak	W0581-SD	3
Witchcraft -Polished Velvet	WX421-PV	3
Yorkshire Cherry	WC411-SD	3

HSON

Wilsonart Laminate Tier

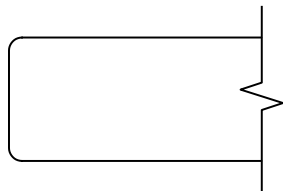
JSI offers an extensive program for laminates beyond our Standard Program. Always reference our website for the most current listing when using a [Graded-In Laminate](#), on page NS4 select the color of the PVC edge color.

Laminate	Pattern #	Tier	Laminate	Pattern #	Tier	Laminate	Pattern #	Tier
Almond Leather	2932-60	2	Hampton Walnut	7959K-78	3	Polished Concrete	5022K-22	3
Amaretto Pine	8224K-16	3	Harvest Maple	7953-38	2	Port	D14-60	2
Amber Cherry	7919K-78	3	High Rise	4996-38	2	Portico Teak	8210K-28	3
Antique Bourbon Pine	8215K-12	3	Hollyberry	D307-60	2	Potter's Clay	5011K-22	3
Antique Marula Pine	8216K-28	3	Huntington Maple	7929-38	2	Pressed Linen	4991-38	2
Antique White-Matte	1572-60	2	Indigo	D379-60	2	Putty	1503-60	2
Asian Night	7949K-18	3	Irish Linen	4993-38	2	Raw Chestnut	7975K-12	3
Asian Sand	7952K-18	3	Island	D498K-18	3	Raw Cotton	4947-38	2
Asian Sun	7951K-18	3	Italian Silver Ash	8217K-16	3	Regimental Red	D12K-18	3
Astro Strandz	4940K-18	3	Khaki Brown	D50-60	2	Rio	7947K-18	3
Atlantis	D25-60	2	Kingswood Walnut	8218-38	2	River Cherry	7937-38	2
Bannister Oak	7806-60	2	Landmark Wood	7981K-12	3	Rugged Linen	4989-38	2
Battleship	5014K-19	3	Lapis Blue	D417-60	2	Rustic Slate	4888-38	2
Beige	1530-60	2	Light Beige	1531-60	2	Sable Soapstone	4883-38	2
Beige Pampus	4170-60	2	Light Oak Ply	8202K-28	3	Saddle Oak	8206K-16	3
Beigewood	7850-60	2	Limber Maple	10734-60	2	Sap Walnut	8221-38	2
Biltmore Cherry	7924K-07	3	Linen	D427-60	2	Satin Stainless	4830K-18	3
Black	1595-60	2	Loden Zephyr	4844-60	2	Shadow Zephyr	4857-60	2
Black Alicante	4926K-07	3	Loft Oak	7968K-12	3	Shaker Cherry	7935K-07	3
Blackbird	5024K-19	3	Low Line	7998K-18	3	Sheer Mesh	4876-38	2
Blackened Chestnut	8223K-12	3	Lowell Ash	7994-38	2	Sierra Cascade	5005-38	2
Blue Agave	4919-60	2	Madagascar	7944K-07	3	Silicon EV	4811-60	2
Boardwalk Oak	7983-38	2	Magnolia	5012K-19	3	Silver Alchemy	4860K-07	3
Branded Oak	8207K-16	3	Mambo	7948K-07	3	Silver Oak Ply	8203K-28	3
Brittany Blue	D321-60	2	Mangalore Mango	7984-38	2	Skyline Walnut	7964K-12	3
Bronze Legacy	4656-60	2	Manitoba Maple	7911-60	2	Soft Gold Mesh	4911-38	2
Buka Bark	7982-38	2	Marmo Bianco	1885K-07	3	Solar Oak	7816-60	2
Burnished Chestnut	4796-60	2	Maroochy Brush	4745-60	2	Sprout	4918-60	2
Calcutta Marble	4925K-07	3	Midnight	D505-60	2	Steel Mesh	4879-38	2
Canyon Zephyr	4842-60	2	Mission Maple	7990-38	2	Sterling Ash	7995-38	2
Carbon EV	4820-60	2	Misted Zephyr	4843-60	2	Tailored Linen	4992-38	2
Carbon Mesh	4880-38	2	Montana Walnut	7110K-78	3	Tan Echo	7941K-18	3
Castle Oak	7928-38	2	Monticello Maple	7925-38	2	Tan Soapstone	4887-38	2
Casual Linen	4944-38	2	Morelia Mango	7985-38	2	Tangerine	4915-60	2
Cement	D503-60	2	Morro Zephyr	4846-60	2	Tawny Legacy	4663-60	2
Classic Linen	4943-38	2	Mushroom	5013K-19	3	Titanium EV	4810-60	2
Cloud Nebula	4630-60	2	Natural Almond	D30-60	2	Tungsten EV	4814-60	2
Cloud Zephyr	4856-60	2	Natural Cotton	4946-38	2	Tuscan Walnut	7921-38	2
Cocobala	7942K-07	3	Natural Nebula	4633-60	2	Twilight Zephyr	4845-60	2
Coffee Bean	D495-60	2	Natural Pear	7061-60	2	Uptown Walnut	7971K-12	3
Colombian Walnut	7943K-07	3	Natural Recon	7996-38	2	Vapor Strandz	4939K-18	3
Cosmic Strandz	4941K-18	3	Natural Rift	7954-38	2	Veranda Teak	8209K-28	3
Crisp Linen	4942-38	2	Natural Tigris	4669-60	2	Versailles Anigre	7923K-07	3
Crystal	D388-60	2	Navy Legacy	4651-60	2	Wallaby	D439-60	2
Desert Zephyr	4841-60	2	NeoWalnut	7991-38	2	Warehouse Oak	7969K-12	3
Ebony Char	8205K-16	3	Nepal Teak	7209K-78	3	Washed Char	8222K-16	3
Ebony Recon	7997-38	2	Neutral Glace	4143-60	2	Washi Crystal	5017-38	2
Eggplant	4913-60	2	New Age Oak	7938-38	2	Washi Gold	5019-38	2
Evening Tigris	4674-60	2	Nickel EV	4813-60	2	Washi Pewter	5018-38	2
Fashion Grey	D381-60	2	Nightfall	5023K-19	3	Weathered Char	8204K-16	3
Fawn Cypress	8208K-16	3	Nordic Linen	5015-38	2	White Barn	7977K-12	3
Field Elm	7999K-12	3	North Sea	D90-60	2	White Carrara	4924-38	2
Figured Mahogany	7040K-78	3	Ocean	D502K-18	3	White Cascade	5003-38	2
Fired Steel	4994-60	2	Oiled Soapstone	4882-38	2	White Cypress	7976K-12	3
Flax Linen	4990-38	2	Old Mill Oak	7973K-12	3	White Driftwood	8200K-16	3
Fonthill Pear	10745-60	2	Orange Grove	D501-60	2	White Nebula	4621-60	2
Forged Steel	4995-60	2	Organic Cotton	4945-38	2	White Sand	D403-60	2
Fossil Shale	D504-60	2	Oxide	1787-60	2	White Tigris	4783-60	2
French Linen	5016-38	2	Palisades Oak	7987-38	2	White-Matte	1570-60	2
French Pear	8220-38	2	Pampus	4166-60	2	Wild Cherry	7054-60	2
Fusion Maple	7909-60	2	Park Elm	7967K-12	3	Windsor Mahogany	7039K-78	3
Gesso Tracery	4962-38	2	Pasadena Oak	7986-38	2	Windswept Bronze	4794-38	2
Glided Mesh	4912-38	2	Pearl Soapstone	4886-38	2	Windswept Pewter	4795-60	2
Graphite Nebula	4623-60	2	Pepperdust	D327-60	2	Woolamai Brush	4746-60	2
Green Soapstone	4885-38	2	Pewter	D73-60	2	Xanadu	7945K-18	3
Green Tigris	4667-60	2	Pewter Brush	4779-60	2	Zanzibar	7957K-78	3
Grey	1500-60	2	Pewter Mesh	4878-38	2	Zebrawood	7980K-18	3
Grey Elm	8201K-12	3	Phantom Charcoal	8214K-28	3			
Grey Glace	4142-60	2	Phantom Cocoa	8213K-28	3			
Grey Mesh	4877-38	2	Phantom Ecru	8212K-28	3			
Grey Nebula	4622-60	2	Phantom Pearl	8211K-28	3			
Grey Pampus	4168-60	2	Pinball	4937-38	2			

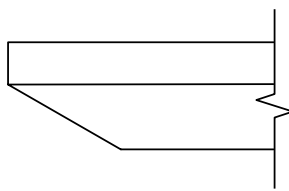
Nosh Product Information

Veneer Tops

Tops are 1 3/16" thick, 5 ply balanced construction with particle board core. Standard Tier 1 veneer is flat cut, book matched for cherry, maple and walnut veneer. Standard Tier 2 veneer is double cut.



Eased Edge (R3)
Internal Lumber Band



Reverse Bevel (K9)
Veneer Band on Stained MDF

Finish - Stain/Colors

Flat Cuts are Tier 1 Veneer pricing, while Double Cut is Tier 2 Veneer pricing. Finishes with an asterisk (*) have coordinating laminate tops.

Finish Sheen

All veneer finishes are standard in 35-sheen, with the exception of Raven. Raven is only offered in 15 sheen. All other finishes can have their sheen modified with a 15% upcharge added to the list price of each item.

CH1 Cherry *Flat Cut Veneer*

BBM Bourbon Medium	CLL Collectors
BRM Brighton Medium	HRV Harvest
CLA Classic	PRL Praline

MA1 Maple *Flat Cut Veneer*

ALM Ale Medium	FLX Flax
BUT Butterscotch	VEN Venetian

WA1 Walnut *Flat Cut Veneer*

ESP Espresso	TRF Truffle
MCH Mocha	UMB Umber
SIE Sienna	

BO1 Black Oak *Flat Cut Veneer*

RAV Raven

DC1 Double Cut Veneer

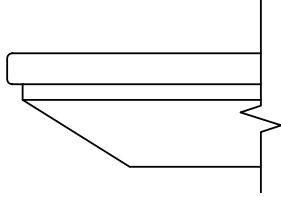
BAR Barrel - Oak Pattern	KHK Khaki
BUF Buff - Oak Pattern	MIN Mineral - Oak Pattern
CND Cinder - Oak Pattern	RYE Rye - Oak Pattern
COF Coffee	SAB Sable - Oak Pattern
EGR Egret - Oak Pattern	SAD Saddle - Oak Pattern
FAW Fawn	STU Studio Teak
GRH Graphite	VAL Valley

HSON

Nosh Product Information

Solid Surface Tops

Tops are 1 3/16" thick constructed of 1/2" thick Solid Surface on top of a 1/4" MDF sub top. Sub top has an under cut bevel profile and is painted in a coordinated color to match the Solid Surface.



Reverse Bevel Edge (S7)

Solid Surface over painted MDF

Standard Solid Surface

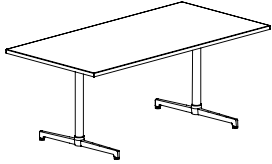
Tier 1 (S1)

- ARM Armadillo
- BLP Black Pearl
- PEB Pebble Pearl
- PUR Pure White

Nosh Product Information

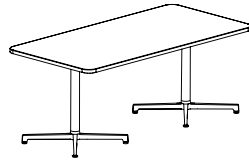
Base Styles

Nosh provides a choice selection of bases in both function and aesthetics to serve a variety of needs. It offers six base styles with: T-base, X-base, X-extended base, X4 base, Round Disc and Square Disc.



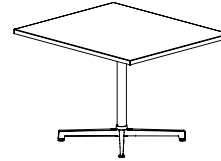
T-Base

- available in 29", 36" and 42"h
- used only with rectangular tops
- base finish bright white, matte black, pewter, arctic silver, or two-tone aesthetics are achieved when selecting arctic silver or polished aluminum foot



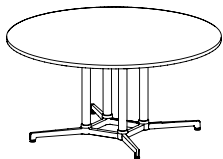
X-Base

- available in 29", 36" and 42"h
- used with all Nosh top shapes
- base finish bright white, matte black, pewter, arctic silver, or two-tone aesthetics are achieved when selecting arctic silver or polished aluminum foot
- power access version available with an upcharge



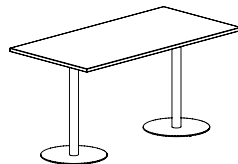
X-Extended Base

- available in 29"h only
- used with rectangular tops
- base finish bright white, matte black, pewter, arctic silver, or two-tone aesthetics are achieved when selecting arctic silver or polished aluminum foot
- cannot be used in conjunction with power cutouts



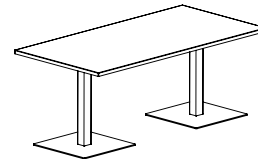
X4 Base

- available in 29", 36" and 42"h
- used only on round, rounded square and squircle tops
- base finish bright white, matte black, pewter, arctic silver, or two-tone aesthetics are achieved when selecting arctic silver or polished aluminum foot



Round Disc

- available in 29", 36" and 42"h
- used with all Nosh top shapes
- base finish bright white, matte black, pewter, arctic silver, or two-tone aesthetics are achieved when selecting arctic silver foot



Square Disc

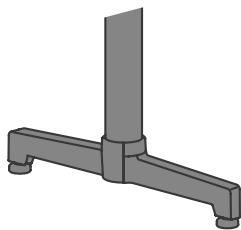
- available in 29", 36" and 42"h
- used with all Nosh top shapes
- base finish bright white, matte black, pewter, arctic silver, or two-tone aesthetics are achieved when selecting arctic silver foot
- round and square tables cannot be used in conjunction with power cutouts

HSON

Two - Two Aesthetics.

Single Metal Finish

- ABZ** Aged Bronze Feet & Post
- ASL** Arctic Silver Feet & Post
- BWH** Bright White Feet & Post
- GLD** Gold Feet & Post
- PEW** Pewter Feet & Post
- MBK** Matte Black Feet & Post
- SBZ** Soft Bronze Feet & Post
- SNK** Soft Nickel Feet & Post

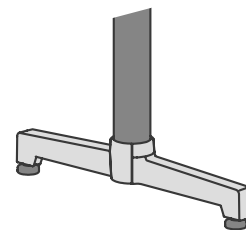


Two - Tone Metal Finish

Two - Tone Aesthetics can be achieved by specifying Polished Aluminum on the foot and a contrasting finish on the post

Polished Aluminum Feet

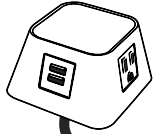
- ABZ** - Aged Bronze Post
- ASL** - Arctic Silver Post
- GLD** - Gold Feet Post
- PEW** - Pewter Feet Post
- MBK** - Matte Black Feet Post
- SBZ** - Soft Bronze Feet Post
- SNK** - Soft Nickel Feet Post



Nosh Product Information

Power/Charging Options

Nosh offers the ability to place power and charging options in the center of most tables. Select your choice of EC23 or EC24, available in black and white.



Moire - EC23

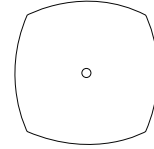
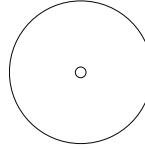
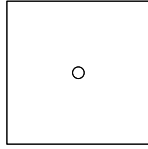
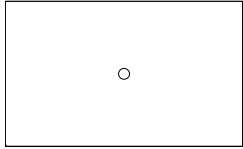
- Three 110 outlets
- Dual USB port with 72" power cord
- Black (B) or White (W)



Node - EC24

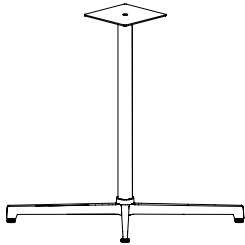
- One 110 outlet
- Dual USB port with 72" power cord
- Black (B) or White (W)

Cut outs are located in the center of each table. See below for representation or location.

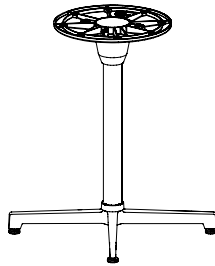


Power Access Base

In round, square, rounded square and squircle tables that use X base, when you select power accessibility; the table is bored for the electrical unit and a power accessible base is used. This provides a drawn mounting bracket and the ability to run the power cord down through the base. See individual product pricing pages for upcharge.



Standard X Base



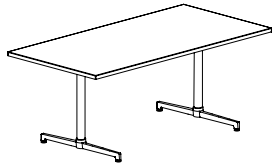
Power Accessible X Base

Nosh - 29"h Tables

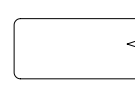


Description

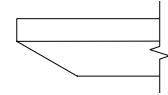
Rectangular Table with T Base



Laminate Tables "NST" Models



Eased Edge (R3)



Reverse Bevel Edge (K9)

LAMINATE

HSO

D	W	H	CTN WT	CU FT	① Model	Eased Edge (R3)			Reverse Bevel Edge (K9)		
						Standard Tier 1	Graded In Tier 2 Tier 3		Standard Tier 1	Graded In Tier 2 Tier 3	
36	72	29	136	47	NST3672-29TTT	\$1,640	\$1,703	\$1,839	\$2,053	\$2,116	\$2,251
36	66	29	127	44	NST3666-29TTT	\$1,582	\$1,640	\$1,766	\$1,995	\$2,053	\$2,179
36	60	29	119	38	NST3660-29TTT	\$1,512	\$1,568	\$1,678	\$1,924	\$1,980	\$2,090
36	54	29	111	33	NST3654-29TTT	\$1,350	\$1,401	\$1,502	\$1,766	\$1,816	\$1,916
36	48	29	96	46	NST3648-29TTT	\$1,260	\$1,303	\$1,392	\$1,672	\$1,719	\$1,806
30	72	29	120	47	NST3072-29TTT	\$1,392	\$1,448	\$1,558	\$1,806	\$1,860	\$1,972
30	66	29	103	41	NST3066-29TTT	\$1,335	\$1,386	\$1,487	\$1,747	\$1,798	\$1,899
30	60	29	106	36	NST3060-29TTT	\$1,264	\$1,314	\$1,402	\$1,678	\$1,726	\$1,817
30	54	29	99	33	NST3054-29TTT	\$1,216	\$1,257	\$1,340	\$1,629	\$1,671	\$1,753
30	48	29	85	33	NST3048-29TTT	\$1,144	\$1,184	\$1,254	\$1,556	\$1,597	\$1,668

Features:

- price reflects complete table - top and base
- ships KD in multiple cartons
- top has option for cutout to receive electrical component, ordered separately
- optional vertical wire manager for base, order separately
- base has leveling glides
- width of base foot is 27"

To Order Specify

① Laminate Model #	② Edge Detail	③ Laminate Selection	③a PVC Edge Color	④ Electrical Cut Out	⑤ Metal Finish
Laminate (NST)	See Edge Detail Options	See Laminate Detail Selection	See PVC Edge Color Options	N None CO_EC23 Cut out for EC23 CO_EC24 Cut out for EC24	See Metal Finish Options

Model Number Breakdown

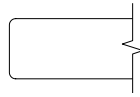
NST3048-29TTT					
NS	T	3048	29	TT	T
Nosh	Laminate	30" x 48"	Height	Rectangular Top Shape	T Base

NS14 Nosh

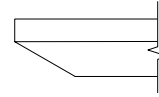
Description

Rectangular Table with T Base
(continued)

Veneer Tops
"NSV" Models



Eased Edge (R3)



Reverse Bevel Edge (K9)

D	W	H	CTN WT	CU FT	① Model	Eased Edge (R3)		Reverse Bevel Edge (K9)	
						Flat Cut	Double Cut	Flat Cut	Double Cut
36	72	29	136	47	NSV3672-29TTT	\$1,917	\$2,097	\$2,075	\$2,253
36	66	29	127	44	NSV3666-29TTT	\$1,876	\$2,045	\$2,029	\$2,195
36	60	29	119	38	NSV3660-29TTT	\$1,821	\$1,979	\$1,968	\$2,121
36	54	29	111	33	NSV3654-29TTT	\$1,666	\$1,810	\$1,803	\$1,942
36	48	29	96	46	NSV3648-29TTT	\$1,628	\$1,759	\$1,757	\$1,886
30	72	29	120	47	NSV3072-29TTT	\$1,800	\$1,960	\$1,948	\$2,103
30	66	29	103	41	NSV3066-29TTT	\$1,748	\$1,897	\$1,891	\$2,033
30	60	29	106	36	NSV3060-29TTT	\$1,703	\$1,865	\$1,836	\$1,971
30	54	29	99	33	NSV3054-29TTT	\$1,555	\$1,680	\$1,679	\$1,798
30	48	29	85	33	NSV3048-29TTT	\$1,522	\$1,636	\$1,642	\$1,750

VENEER

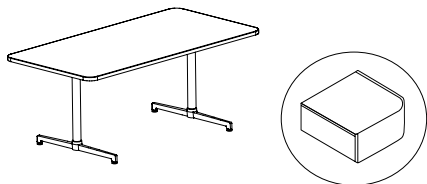
NOSH

To Order Specify

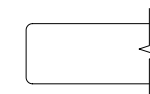
① Veneer Model #	② Edge Detail	③ Wood Species	④ Wood Finish	⑤ Electrical Cut Out	⑥ Metal Finish
Veneer (NSV)	See Edge Detail Options	Flat Cut B01 Cherry CH1 Cherry MA1 Maple WA1 Walnut	See Flat Cut Wood Finish Options	N None CO_EC23 Cut out for EC23 CO_EC24 Cut out for EC24	See Metal Finish Options
	Double Cut DC2 Double Cut	④ Wood Finish	See Double Cut Wood Finish Options		

Description

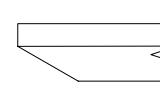
Rounded Rectangular Table with T Base



Laminate Tables "NST" Models



Eased Edge (R3)



Reverse Bevel (K9)

D	W	H	CTN WT	CU FT	① Model	Eased Edge (R3)			Reverse Bevel (K9)		
						Standard	Graded In		Standard	Graded In	
						Tier 1	Tier 2	Tier 3	Tier 1	Tier 2	Tier 3
36	72	29	129	47	NST3672-29TTRT	\$1,731	\$1,794	\$1,929	\$2,143	\$2,206	\$2,342
36	66	29	121	44	NST3666-29TTRT	\$1,678	\$1,736	\$1,858	\$2,090	\$2,150	\$2,271
36	60	29	112	38	NST3660-29TTRT	\$1,614	\$1,670	\$1,779	\$2,027	\$2,083	\$2,192
36	54	29	104	33	NST3654-29TTRT	\$1,399	\$1,448	\$1,547	\$1,811	\$1,860	\$1,960
36	48	29	89	46	NST3648-29TTRT	\$1,350	\$1,399	\$1,486	\$1,766	\$1,811	\$1,898
30	72	29	113	47	NST3072-29TTRT	\$1,572	\$1,628	\$1,736	\$1,985	\$2,041	\$2,150
30	66	29	106	41	NST3066-29TTRT	\$1,510	\$1,563	\$1,663	\$1,923	\$1,977	\$2,076
30	60	29	99	36	NST3060-29TTRT	\$1,457	\$1,507	\$1,595	\$1,871	\$1,920	\$2,008
30	54	29	92	33	NST3054-29TTRT	\$1,274	\$1,318	\$1,398	\$1,686	\$1,730	\$1,810
30	48	29	79	33	NST3048-29TTRT	\$1,234	\$1,275	\$1,344	\$1,647	\$1,687	\$1,756

Features:

- price reflects complete table - top and base
- ships KD in multiple cartons
- top has option for cutout to receive electrical component, ordered separately
- optional vertical wire manager for base, order separately
- base has leveling glides
- width of base foot is 27"

To Order Specify

① Laminate Model #	② Edge Detail	③ Laminate Selection	③a PVC Edge Color	④ Electrical Cut Out	⑤ Metal Finish
Laminate (NST)	See Edge Detail Options	See Laminate Detail Selection	See PVC Edge Color Options	N None CO_EC23 Cut out for EC23 CO_EC24 Cut out for EC24	See Metal Finish Options

Model Number Breakdown

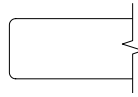
NST3048-29TTRT						
NS	T	3048	29	TT	R	T
Nosh	Laminate	30" x 48"	Height	Rectangular Top Shape	Rounded Corner	T Base

Description

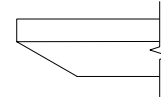
Rounded Rectangular Table with T Base
(continued)

Veneer Tables
"NSV" Models

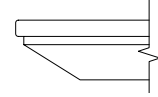
Solid Surface Tables
"NSS" Models



Eased Edge (R3)



Reverse Bevel Edge (K9)



Reverse Bevel Edge (S7)

	D	W	H	CTN WT	CU FT	① Model	Veneer Tables "NSV" Models		Solid Surface Tables "NSS" Models		
							Flat Cut	Double Cut	Flat Cut	Double Cut	Standard
VENEER	36	72	29	129	47	NSV3672-29TTRT	\$2,060	\$2,250	\$2,139	\$2,319	--
	36	66	29	121	44	NSV3666-29TTRT	\$2,018	\$2,195	\$2,093	\$2,259	--
	36	60	29	112	38	NSV3660-29TTRT	\$1,956	\$2,121	\$2,028	\$2,183	--
	36	54	29	104	33	NSV3654-29TTRT	\$1,786	\$1,937	\$1,853	\$1,993	--
	36	48	29	89	46	NSV3648-29TTRT	\$1,745	\$1,881	\$1,807	\$1,936	--
	30	72	29	113	47	NSV3072-29TTRT	\$1,930	\$2,097	\$2,001	\$2,156	--
	30	66	29	106	41	NSV3066-29TTRT	\$1,873	\$2,029	\$1,932	\$2,076	--
	30	60	29	99	36	NSV3060-29TTRT	\$1,824	\$1,967	\$1,884	\$2,021	--
	30	54	29	92	33	NSV3054-29TTRT	\$1,666	\$1,796	\$1,719	\$1,840	--
	30	48	29	79	33	NSV3048-29TTRT	\$1,631	\$1,749	\$1,686	\$1,797	--
SOLID SURFACE	36	72	29	170	47	NSS3672-29TTRT	--	--	--	--	\$5,005
	36	66	29	158	44	NSS3666-29TTRT	--	--	--	--	\$4,750
	36	60	29	140	28	NSS3660-29TTRT	--	--	--	--	\$4,482
	36	54	29	129	33	NSS3654-29TTRT	--	--	--	--	\$4,102
	36	48	29	118	46	NSS3648-29TTRT	--	--	--	--	\$3,850
	30	72	29	144	47	NSS3072-29TTRT	--	--	--	--	\$4,456
	30	66	29	137	41	NSS3066-29TTRT	--	--	--	--	\$4,225
	30	60	29	128	36	NSS3060-29TTRT	--	--	--	--	\$4,000
	30	54	29	117	33	NSS3054-29TTRT	--	--	--	--	\$3,668
	30	48	29	151	33	NSS3048-29TTRT	--	--	--	--	\$3,460

NOSH

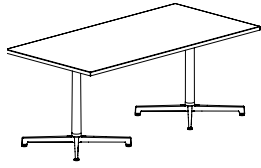
To Order Specify

① Veneer Model #	② Edge Detail	③ Wood Species	④ Wood Finish	⑤ Electrical Cut Out	⑥ Metal Finish
Veneer (NSV)	See Edge Detail Options	Flat Cut B01 Cherry CH1 Cherry MA1 Maple WA1 Walnut Double Cut DC2 Double Cut	See Flat Cut Wood Finish Options ④ Wood Finish See Double Cut Wood Finish Options	N None CO_EC23 Cut out for EC23 CO_EC24 Cut out for EC24	See Metal Finish Options

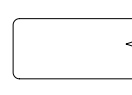
① Solid Surface Model #	② Edge Detail	③ Solid Surface	④ Electrical Cut Out	⑤ Metal Finish
Solid Surface (NSS)	See Edge Detail Options	See Solid Surface Options	N None CO_EC23 Cut out for EC23 CO_EC24 Cut out for EC24	See Metal Finish Options

Description

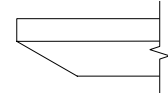
Rectangular Table with X Base



Laminate Tables "NST" Models



Eased Edge (R3)



Reverse Bevel Edge (K9)

LAMINATE	D	W	H	CTN WT	CU FT	1 Model	Eased Edge (R3)			Reverse Bevel Edge (K9)		
							Standard	Graded In		Standard	Graded In	
							Tier 1	Tier 2	Tier 3	Tier 1	Tier 2	Tier 3
	36	72	29	140	41	NST3672-29TTX	\$2,147	\$2,209	\$2,346	\$2,560	\$2,623	\$2,759
	30	72	29	124	31	NST3072-29TTX	\$1,932	\$1,988	\$2,097	\$2,344	\$2,400	\$2,511

Features:

- price reflects complete table - top and base
- ships KD in multiple cartons
- top has option for cutout to receive electrical component, ordered separately
- optional vertical wire manager for base, order separately
- base has leveling glides
- width of base foot is 26"

HSON

To Order Specify

1 Laminate Model #	2 Edge Detail	3 Laminate Selection	3a PVC Edge Color	4 Electrical Cut Out	5 Metal Finish
Laminate (NST)	See Edge Detail Options	See Laminate Detail Selection	See PVC Edge Color Options	N None CO_EC23 Cut out for EC23 CO_EC24 Cut out for EC24	See Metal Finish Options

Model Number Breakdown

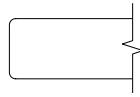
NST3072-29TTX					
NS	T	3072	29	TT	X
Nosh	Laminate	30" x 72"	Height	Rectangular Top Shape	X Base

NS18 Nosh

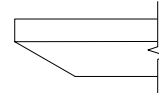
Description

Rectangular Table with X Base
(continued)

Veneer Tables
"NSV" Models



Eased Edge (R3)



Reverse Bevel Edge (K9)

VENEER	D	W	H	CTN WT	CU FT	1 Model	Flat Cut	Double Cut	Flat Cut	Double Cut
	36	72	29	140	41	NSV3672-29TTX	\$2,425	\$2,604	\$2,581	\$2,760
30	72	29	124	31	NSV3072-29TTX	\$2,341	\$2,499	\$2,487	\$2,642	

NOSH

To Order Specify

1 Veneer Model #	2 Edge Detail	3 Wood Species	4 Wood Finish	5 Electrical Cut Out	6 Metal Finish
Veneer (NSV)	See Edge Detail Options	Flat Cut B01 Cherry CH1 Cherry MA1 Maple WA1 Walnut	See Flat Cut Wood Finish Options	N None CO_EC23 Cut out for EC23 CO_EC24 Cut out for EC24	See Metal Finish Options
		Double Cut DC2 Double Cut	4 Wood Finish See Double Cut Wood Finish Options		

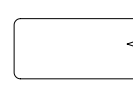
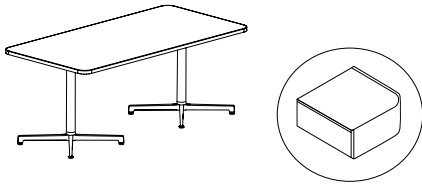
Nosh - 29"h Tables



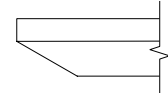
Description

Rounded Rectangular Table with X Base

Laminate Tables "NST" Models



Eased Edge (R3)



Reverse Bevel (K9)

LAMINATE	D	W	H	CTN WT	CU FT	① Model	Eased Edge (R3)			Reverse Bevel (K9)		
							Standard	Graded In		Standard	Graded In	
							Tier 1	Tier 2	Tier 3	Tier 1	Tier 2	Tier 3
	36	72	29	140	47	NST3672-29TTRX	\$2,238	\$2,302	\$2,436	\$2,650	\$2,714	\$2,848
	30	72	29	123	31	NST3072-29TTRX	\$2,110	\$2,167	\$2,277	\$2,524	\$2,579	\$2,689

Features:

- price reflects complete table - top and base
- ships KD in multiple cartons
- top has option for cutout to receive electrical component, ordered separately
- optional vertical wire manager for base, order separately
- base has leveling glides
- width of base foot is 26"

HSON

To Order Specify

① Laminate Model #	② Edge Detail	③ Laminate Selection	③a PVC Edge Color	④ Electrical Cut Out	⑤ Metal Finish
Laminate (NST)	See Edge Detail Options	See Laminate Detail Selection	See PVC Edge Color Options	N None CO_EC23 Cut out for EC23 CO_EC24 Cut out for EC24	See Metal Finish Options

Model Number Breakdown

NST3072-29TTRX						
NS	T	3072	29	TT	R	X
Nosh	Laminate	30" x 72"	Height	Rectangular Top Shape	Rounded Corner	X Base

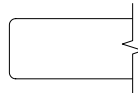
NS20 Nosh

Description

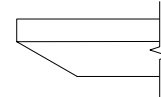
Rounded Rectangular Table with X Base
(continued)

Veneer Tables
"NSV" Models

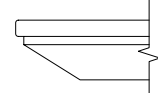
Solid Surface Tables
"NSS" Models



Eased Edge (R3)



Reverse Bevel Edge (K9)



Reverse Bevel Edge (S7)

	D	W	H	CTN WT	CU FT	① Model	Veneer Tables "NSV" Models		Solid Surface Tables "NSS" Models		
							Flat Cut	Double Cut	Flat Cut	Double Cut	Standard
VENEER	36	72	29	140	47	NSV3672-29TTRX	\$2,599	\$2,790	\$2,677	\$2,858	--
	36	66	29	134	36	NSV3666-29TTRX	\$2,555	\$2,735	\$2,631	\$2,798	--
	36	60	29	140	28	NSV3660-29TTRX	\$2,495	\$2,661	\$2,566	\$2,722	--
	30	72	29	123	31	NSV3072-29TTRX	\$2,437	\$2,604	\$2,507	\$2,663	--
	30	66	29	118	29	NSV3066-29TTRX	\$2,380	\$2,536	\$2,438	\$2,582	--
	30	60	29	111	28	NSV3060-29TTRX	\$2,330	\$2,475	\$2,392	\$2,527	--
SOLID SURFACE	36	72	29	173	47	NSS3672-29TTRX	--	--	--	--	\$5,543
	36	66	29	162	36	NSS3666-29TTRX	--	--	--	--	\$5,288
	36	60	29	150	28	NSS3660-29TTRX	--	--	--	--	\$5,020
	30	72	29	149	31	NSS3072-29TTRX	--	--	--	--	\$4,964
	30	66	29	140	29	NSS3066-29TTRX	--	--	--	--	\$4,732
	30	60	29	130	28	NSS3060-29TTRX	--	--	--	--	\$4,506

NOSH

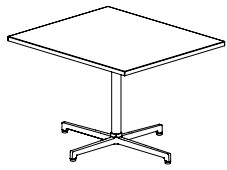
To Order Specify

① Veneer Model #	② Edge Detail	③ Wood Species	④ Wood Finish	⑤ Electrical Cut Out	⑥ Metal Finish
Veneer (NSV)	See Edge Detail Options	Flat Cut B01 Cherry CH1 Cherry MA1 Maple WA1 Walnut	See Flat Cut Wood Finish Options	N None CO_EC23 Cut out for EC23 CO_EC24 Cut out for EC24	See Metal Finish Options
		Double Cut DC2 Double Cut	④ Wood Finish See Double Cut Wood Finish Options		

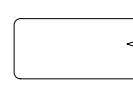
① Solid Surface Model #	② Edge Detail	③ Solid Surface	④ Electrical Cut Out	⑤ Metal Finish
Solid Surface (NSS)	See Edge Detail Options	See Solid Surface Options	N None CO_EC23 Cut out for EC23 CO_EC24 Cut out for EC24	See Metal Finish Options

Description

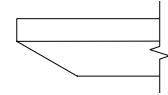
Rectangular Table with X Extended Base



Laminate Tables "NST" Models



Eased Edge (R3)



Reverse Bevel Edge (K9)

LAMINATE	D	W	H	CTN WT	CU FT	1 Model	Eased Edge (R3)			Reverse Bevel Edge (K9)		
							Standard	Graded In		Standard	Graded In	
							Tier 1	Tier 2	Tier 3	Tier 1	Tier 2	Tier 3
	36	42	29	75	17	NST3642-29TTX	\$1,296	\$1,341	\$1,452	\$1,708	\$1,754	\$1,867
	30	42	29	66	15	NST3042-29TTX	\$1,256	\$1,299	\$1,408	\$1,670	\$1,712	\$1,821
	30	36	29	60	17	NST3036-29TTX	\$1,142	\$1,178	\$1,204	\$1,555	\$1,592	\$1,618

Features:

- price reflects complete table - top and base
- ships KD in multiple cartons
- cut out for power is not available on these tables
- base has leveling glides
- width of base short foot varies from 25" or 31"
- width of base long foot varies from 31" or 37"

HSON

To Order Specify

1 Laminate Model #	2 Edge Detail	3 Laminate Selection	3a PVC Edge Color	4 Metal Finish
Laminate (NST)	See Edge Detail Options	See Laminate Detail Selection	See PVC Edge Color Options	See Metal Finish Options

Model Number Breakdown

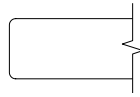
NST3036-29TTX					
NS	T	3036	29	TT	X
Nosh	Laminate	30" x 36"	Height	Rectangular Top Shape	X Extended Base

NS22 Nosh

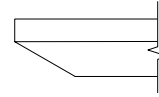
Description

Rectangular Table with X Extended Base
(continued)

Veneer Tables
"NSV" Models



Eased Edge (R3)



Reverse Bevel Edge (K9)

VENEER	D	W	H	CTN WT	CU FT	1 Model	Flat Cut	Double Cut	Flat Cut	Double Cut
		36	42	29	75	17	NSV3642-29TTX	\$1,865	\$1,995	\$1,940
	30	42	29	66	15	NSV3042-29TTX	\$1,808	\$1,936	\$1,880	\$2,012
	30	36	29	60	17	NSV3036-29TTX	\$1,643	\$1,757	\$1,708	\$1,830

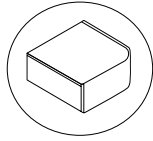
NOSH

To Order Specify

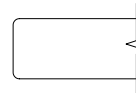
1 Veneer Model #	2 Edge Detail	3 Wood Species	4 Wood Finish	5 Electrical Cut Out	6 Metal Finish
Veneer (NSV)	See Edge Detail Options	Flat Cut B01 Cherry CH1 Cherry MA1 Maple WA1 Walnut	See Flat Cut Wood Finish Options	N None CO_EC23 Cut out for EC23 CO_EC24 Cut out for EC24	See Metal Finish Options
		Double Cut DC2 Double Cut	4 Wood Finish See Double Cut Wood Finish Options		

Description

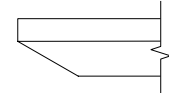
Rounded Rectangular Table with X Extended Base



Laminate Tables "NST" Models



Eased Edge (R3)



Reverse Bevel (K9)

LAMINATE	D	W	H	CTN WT	CU FT	1 Model	Eased Edge (R3)			Reverse Bevel (K9)		
							Standard	Graded In		Standard	Graded In	
							Tier 1	Tier 2	Tier 3	Tier 1	Tier 2	Tier 3
	36	42	29	76	17	NST3642-29TTRX	\$1,382	\$1,430	\$1,547	\$1,794	\$1,842	\$1,960
	30	42	29	65	15	NST3042-29TTRX	\$1,339	\$1,385	\$1,498	\$1,752	\$1,797	\$1,912
	30	36	29	59	17	NST3036-29TTRX	\$1,218	\$1,256	\$1,284	\$1,631	\$1,670	\$1,697

Features:

- price reflects complete table - top and base
- ships KD in multiple cartons
- cut out for power is not available on these tables
- base has leveling glides
- width of base short foot varies from 25" to 31"
- width of base long foot varies from 31" to 37"

HSON

To Order Specify

1 Laminate Model #	2 Edge Detail	3 Laminate Selection	3a PVC Edge Color	4 Metal Finish
Laminate (NST)	See Edge Detail Options	See Laminate Detail Selection	See PVC Edge Color Options	See Metal Finish Options

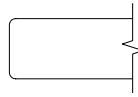
Model Number Breakdown

NST3036-29TTRX						
NS	T	3036	29	TT	R	X
Nosh	Laminate	30" x 36"	Height	Rectangular Top Shape	Rounded Corner	X Extended Base

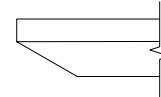
Description

Rounded Rectangular Table with X Extended Base (continued)

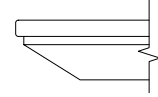
Veneer Tables "NSV" Models Solid Surface Tables "NSS" Models



Eased Edge (R3)



Reverse Bevel Edge (K9)



Reverse Bevel Edge (S7)

	D	W	H	CTN WT	CU FT	① Model	Eased Edge (R3)		Reverse Bevel Edge (K9)		Standard
							Flat Cut	Double Cut	Flat Cut	Double Cut	
VENEER	36	42	29	76	17	NSV3642-29TTRX	\$1,930	\$2,066	\$2,007	\$2,148	--
	30	42	29	65	15	NSV3042-29TTRX	\$1,872	\$2,003	\$1,946	\$2,084	--
	30	36	29	59	17	NSV3036-29TTRX	\$1,701	\$1,821	\$1,771	\$1,895	--
SOL SURF	36	42	29	110	17	NSS3642-29TTRX	--	--	--	--	\$3,827
	30	42	29	92	15	NSS3042-29TTRX	--	--	--	--	\$3,523
	30	36	29	77	17	NSS3036-29TTRX	--	--	--	--	\$3,178

NOSH

To Order Specify

① Veneer Model #	② Edge Detail	③ Wood Species	④ Wood Finish	⑤ Electrical Cut Out	⑥ Metal Finish
Veneer (NSV)	See Edge Detail Options	Flat Cut B01 Cherry CH1 Cherry MA1 Maple WA1 Walnut	See Flat Cut Wood Finish Options	N None CO_EC23 Cut out for EC23 CO_EC24 Cut out for EC24	See Metal Finish Options
		Double Cut DC2 Double Cut	④ Wood Finish See Double Cut Wood Finish Options		

① Solid Surface Model #	② Edge Detail	③ Solid Surface	④ Electrical Cut Out	⑤ Metal Finish
Solid Surface (NSS)	See Edge Detail Options	See Solid Surface Options	N None CO_EC23 Cut out for EC23 CO_EC24 Cut out for EC24	See Metal Finish Options

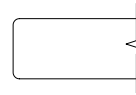
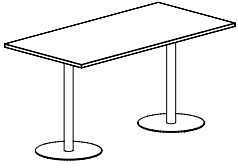
Nosh - 29" h Tables



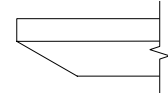
Description

Rectangular Table with Round Disc Base

Laminate Tables "NST" Models



Eased Edge (R3)



Reverse Bevel Edge (K9)

LAMINATE	D	W	H	CTN WT	CU FT	1 Model	Eased Edge (R3)			Reverse Bevel Edge (K9)		
							Standard	Graded In		Standard	Graded In	
							Tier 1	Tier 2	Tier 3	Tier 1	Tier 2	Tier 3
	36	72	29	193	47	NST3672-29TTR	\$2,382	\$2,443	\$2,565	\$2,794	\$2,857	\$2,978
	36	66	29	185	44	NST3666-29TTR	\$2,237	\$2,307	\$2,419	\$2,649	\$2,721	\$2,834
	36	60	29	177	38	NST3660-29TTR	\$2,146	\$2,214	\$2,312	\$2,559	\$2,628	\$2,726
	30	72	29	154	41	NST3072-29TTR	\$2,148	\$2,217	\$2,313	\$2,561	\$2,629	\$2,727
	30	66	29	147	41	NST3066-29TTR	\$1,939	\$2,002	\$2,090	\$2,351	\$2,414	\$2,503
	30	60	29	140	36	NST3060-29TTR	\$1,869	\$1,929	\$2,005	\$2,281	\$2,342	\$2,419

Features:

- price reflects complete table - top and base
- ships KD in multiple cartons
- top has option for cutout to receive electrical component, ordered separately
- optional vertical wire manager for base, order separately
- base has anti-rock glides
- width of base foot varies from 17" or 22"

HSON

To Order Specify

1 Laminate Model #	2 Edge Detail	3 Laminate Selection	3a PVC Edge Color	4 Electrical Cut Out	5 Metal Finish
Laminate (NST)	See Edge Detail Options	See Laminate Detail Selection	See PVC Edge Color Options	N None CO_EC23 Cut out for EC23 CO_EC24 Cut out for EC24	See Metal Finish Options

Model Number Breakdown

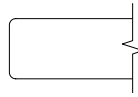
NST3060-29TTR					
NS	T	3060	29	TT	R
Nosh	Laminate	30" x 60"	Height	Rectangular Top Shape	Round Disc Base

NS26 Nosh

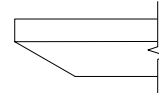
Description

Rectangular Table with Round Disc Base
(continued)

Veneer Tables
"NSV" Models



Eased Edge (R3)



Reverse Bevel Edge (K9)

VENEER	D	W	H	CTN WT	CU FT	1 Model	Flat Cut	Double Cut	Flat Cut	Double Cut
	36	72	29	193	47	NSV3672-29TTR	\$2,725	\$2,847	\$2,786	\$2,899
36	66	29	185	44	NSV3666-29TTR	\$2,631	\$2,743	\$2,702	\$2,802	
36	60	29	177	38	NSV3660-29TTR	\$2,545	\$2,646	\$2,612	\$2,699	
30	72	29	154	41	NSV3072-29TTR	\$2,516	\$2,694	\$2,579	\$2,747	
30	66	29	147	41	NSV3066-29TTR	\$2,307	\$2,425	\$2,365	\$2,473	
30	60	29	140	36	NSV3060-29TTR	\$2,240	\$2,346	\$2,295	\$2,391	

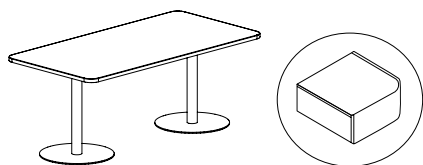
NOSH

To Order Specify

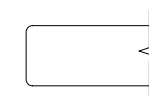
1 Veneer Model #	2 Edge Detail	3 Wood Species	4 Wood Finish	5 Electrical Cut Out	6 Metal Finish
Veneer (NSV)	See Edge Detail Options	Flat Cut B01 Cherry CH1 Cherry MA1 Maple WA1 Walnut	See Flat Cut Wood Finish Options	N None CO_EC23 Cut out for EC23 CO_EC24 Cut out for EC24	See Metal Finish Options
		Double Cut DC2 Double Cut	4 Wood Finish See Double Cut Wood Finish Options		

Description

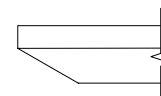
Rounded Rectangular Table with Round Disc Base



Laminate Tables "NST" Models



Eased Edge (R3)



Reverse Bevel (K9)

LAMINATE	D	W	H	CTN WT	CU FT	❶ Model	Eased Edge (R3)			Reverse Bevel (K9)		
							Standard	Graded In		Standard	Graded In	
							Tier 1	Tier 2	Tier 3	Tier 1	Tier 2	Tier 3
	36	72	29	193	47	NST3672-29TTRR	\$2,607	\$2,690	\$2,808	\$3,022	\$3,102	\$3,222
	36	66	29	185	44	NST3666-29TTRR	\$2,264	\$2,335	\$2,448	\$2,677	\$2,749	\$2,860
	36	60	29	176	38	NST3660-29TTRR	\$2,202	\$2,269	\$2,391	\$2,614	\$2,682	\$2,804
	30	72	29	154	41	NST3072-29TTRR	\$2,240	\$2,308	\$2,405	\$2,652	\$2,722	\$2,817
	30	66	29	147	41	NST3066-29TTRR	\$2,180	\$2,244	\$2,331	\$2,592	\$2,656	\$2,743
	30	60	29	140	36	NST3060-29TTRR	\$2,126	\$2,189	\$2,264	\$2,539	\$2,601	\$2,677

Features:

- price reflects complete table - top and base
- ships KD in multiple cartons
- top has option for cutout to receive electrical component, ordered separately
- optional vertical wire manager for base, order separately
- base has anti-rock glides
- width of base foot varies from 17" or 22"

HSON

To Order Specify

❶ Laminate Model #	❷ Edge Detail	❸ Laminate Selection	❹a PVC Edge Color	❹ Electrical Cut Out	❺ Metal Finish
Laminate (NST)	See Edge Detail Options	See Laminate Detail Selection	See PVC Edge Color Options	N None CO_EC23 Cut out for EC23 CO_EC24 Cut out for EC24	See Metal Finish Options

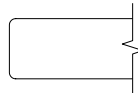
Model Number Breakdown

NST3060-29TTRR						
NS	T	3060	29	TT	R	R
Nosh	Laminate	30" x 60"	Height	Rectangular Top Shape	Rounded Corner	Round Disc Base

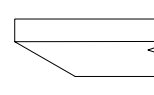
Description

Rounded Rectangular Table with Round Disc Base (continued)

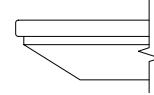
Veneer Tables "NSV" Models Solid Surface Tables "NSS" Models



Eased Edge (R3)



Reverse Bevel Edge (K9)



Reverse Bevel Edge (S7)

	D	W	H	CTN WT	CU FT	① Model	Veneer Tables "NSV" Models		Solid Surface Tables "NSS" Models		
							Flat Cut	Double Cut	Flat Cut	Double Cut	Standard
VENEER	36	72	29	193	47	NSV3672-29TTRR	\$2,951	\$3,075	\$3,024	\$3,135	--
	36	66	29	185	44	NSV3666-29TTRR	\$2,651	\$2,763	\$2,717	\$2,820	--
	36	60	29	176	38	NSV3660-29TTRR	\$2,594	\$2,694	\$2,655	\$2,747	--
	30	72	29	154	41	NSV3072-29TTRR	\$2,599	\$2,725	\$2,671	\$2,782	--
	30	66	29	147	41	NSV3066-29TTRR	\$2,541	\$2,655	\$2,600	\$2,703	--
	30	60	29	140	36	NSV3060-29TTRR	\$2,492	\$2,597	\$2,554	\$2,648	--
	SOLID SURFACE	36	72	29	226	47	NSS3672-29TTRR	--	--	--	--
36		66	29	215	44	NSS3666-29TTRR	--	--	--	--	\$5,386
36		60	29	203	38	NSS3660-29TTRR	--	--	--	--	\$5,118
30		72	29	180	41	NSS3072-29TTRR	--	--	--	--	\$5,125
30		66	29	171	41	NSS3066-29TTRR	--	--	--	--	\$4,894
30		60	29	161	36	NSS3060-29TTRR	--	--	--	--	\$4,667

NOSH

To Order Specify

① Veneer Model #	② Edge Detail	③ Wood Species	④ Wood Finish	⑤ Electrical Cut Out	⑥ Metal Finish
Veneer (NSV)	See Edge Detail Options	Flat Cut B01 Cherry CH1 Cherry MA1 Maple WA1 Walnut	See Flat Cut Wood Finish Options	N None CO_EC23 Cut out for EC23 CO_EC24 Cut out for EC24	See Metal Finish Options
		Double Cut DC2 Double Cut	④ Wood Finish See Double Cut Wood Finish Options		

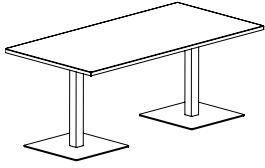
① Solid Surface Model #	② Edge Detail	③ Solid Surface	④ Electrical Cut Out	⑤ Metal Finish
Solid Surface (NSS)	See Edge Detail Options	See Solid Surface Options	N None CO_EC23 Cut out for EC23 CO_EC24 Cut out for EC24	See Metal Finish Options

Nosh - 29" h Tables

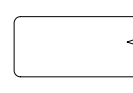


Description

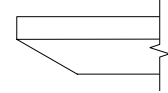
Rectangular Table with Square Disc Base



Laminate Tables "NST" Models



Eased Edge (R3)



Reverse Bevel Edge (K9)

LAMINATE	D	W	H	CTN WT	CU FT	① Model	Eased Edge (R3)			Reverse Bevel Edge (K9)		
							Standard	Graded In		Standard	Graded In	
							Tier 1	Tier 2	Tier 3	Tier 1	Tier 2	Tier 3
	36	72	29	215	47	NST3672-29TTS	\$2,661	\$2,723	\$2,845	\$3,074	\$3,136	\$3,257
	36	66	29	207	44	NST3666-29TTS	\$2,516	\$2,588	\$2,698	\$2,929	\$3,000	\$3,111
	36	60	29	198	38	NST3660-29TTS	\$2,427	\$2,494	\$2,592	\$2,839	\$2,907	\$3,006
	30	72	29	165	41	NST3072-29TTS	\$2,429	\$2,495	\$2,593	\$2,841	\$2,908	\$3,007
	30	66	29	158	41	NST3066-29TTS	\$2,218	\$2,282	\$2,370	\$2,630	\$2,694	\$2,783
	30	60	29	151	36	NST3060-29TTS	\$2,147	\$2,207	\$2,286	\$2,560	\$2,622	\$2,698

Features:

- price reflects complete table - top and base
- ships KD in multiple cartons
- top has option for cutout to receive electrical component, ordered separately
- optional vertical wire manager for base, order separately
- base has anti-rock glides
- width of base foot varies from 17" or 22"

HSON

To Order Specify

① Laminate Model #	② Edge Detail	③ Laminate Selection	③a PVC Edge Color	④ Electrical Cut Out	⑤ Metal Finish
Laminate (NST)	See Edge Detail Options	See Laminate Detail Selection	See PVC Edge Color Options	N None CO_EC23 Cut out for EC23 CO_EC24 Cut out for EC24	See Metal Finish Options

Model Number Breakdown

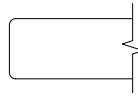
NST3060-29TTS					
NS	T	3060	29	TT	S
Nosh	Laminate	30" x 60"	Height	Rectangular Top Shape	Square Disc Base

NS30 Nosh

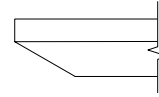
Description

Rectangular Table with Square Disc Base
(continued)

Veneer Tables
"NSV" Models



Eased Edge (R3)



Reverse Bevel Edge (K9)

VENEER	D	W	H	CTN WT	CU FT	1 Model	Flat Cut	Double Cut	Flat Cut	Double Cut
	36	72	29	215	47	NSV3672-29TTS	\$3,004	\$3,127	\$3,064	\$3,180
36	66	29	207	44	NSV3666-29TTS	\$2,910	\$3,025	\$2,983	\$3,083	
36	60	29	198	38	NSV3660-29TTS	\$2,824	\$2,926	\$2,891	\$2,979	
30	72	29	165	41	NSV3072-29TTS	\$2,796	\$2,975	\$2,859	\$3,027	
30	66	29	158	41	NSV3066-29TTS	\$2,588	\$2,702	\$2,646	\$2,751	
30	60	29	151	36	NSV3060-29TTS	\$2,520	\$2,626	\$2,576	\$2,672	

NOSH

To Order Specify

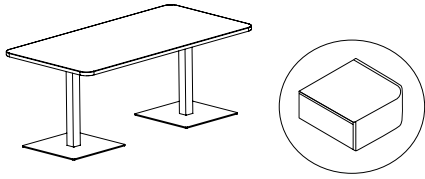
1 Veneer Model #	2 Edge Detail	3 Wood Species	4 Wood Finish	5 Electrical Cut Out	6 Metal Finish
Veneer (NSV)	See Edge Detail Options	Flat Cut B01 Cherry CH1 Cherry MA1 Maple WA1 Walnut	See Flat Cut Wood Finish Options	N None CO_EC23 Cut out for EC23 CO_EC24 Cut out for EC24	See Metal Finish Options
		Double Cut DC2 Double Cut	4 Wood Finish See Double Cut Wood Finish Options		

Nosh - 29" h Tables

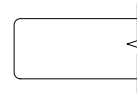


Description

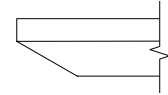
Rounded Rectangular Table with Square Disc Base



Laminate Tables "NST" Models



Eased Edge (R3)



Reverse Bevel (K9)

LAMINATE	D	W	H	CTN WT	CU FT	① Model	Eased Edge (R3)			Reverse Bevel (K9)		
							Standard	Graded In		Standard	Graded In	
							Tier 1	Tier 2	Tier 3	Tier 1	Tier 2	Tier 3
	36	72	29	215	47	NST3672-29TTRS	\$2,888	\$2,969	\$3,087	\$3,300	\$3,382	\$3,500
	36	66	29	207	44	NST3666-29TTRS	\$2,544	\$2,614	\$2,727	\$2,957	\$3,028	\$3,139
	36	60	29	198	38	NST3660-29TTRS	\$2,481	\$2,549	\$2,672	\$2,894	\$2,962	\$3,084
	30	72	29	165	41	NST3072-29TTRS	\$2,520	\$2,589	\$2,686	\$2,933	\$3,001	\$3,098
	30	66	29	158	41	NST3066-29TTRS	\$2,457	\$2,525	\$2,611	\$2,872	\$2,938	\$3,025
	30	60	29	151	36	NST3060-29TTRS	\$2,405	\$2,469	\$2,544	\$2,817	\$2,882	\$2,957

Features:

- price reflects complete table - top and base
- ships KD in multiple cartons
- top has option for cutout to receive electrical component, ordered separately
- optional vertical wire manager for base, order separately
- base has anti-rock glides
- width of base foot varies from 17" or 22"

HSON

To Order Specify

① Laminate Model #	② Edge Detail	③ Laminate Selection	③a PVC Edge Color	④ Electrical Cut Out	⑤ Metal Finish
Laminate (NST)	See Edge Detail Options	See Laminate Detail Selection	See PVC Edge Color Options	N None CO_EC23 Cut out for EC23 CO_EC24 Cut out for EC24	See Metal Finish Options

Model Number Breakdown

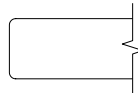
NST3060-29TTRS						
NS	T	3060	29	TT	R	S
Nosh	Laminate	30" x 60"	Height	Rectangular Top Shape	Rounded Corner	Square Disc Base

NS32 Nosh

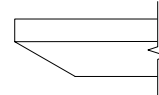
Description

Rounded Rectangular Table with Square Disc Base (continued)

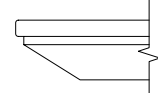
Veneer Tables "NSV" Models	Solid Surface Tables "NSS" Models
----------------------------	-----------------------------------



Eased Edge (R3)



Reverse Bevel Edge (K9)



Reverse Bevel Edge (S7)

	D	W	H	CTN WT	CU FT	① Model	Veneer Tables "NSV" Models		Solid Surface Tables "NSS" Models		
							Flat Cut	Double Cut	Flat Cut	Double Cut	Standard
VENEER	36	72	29	215	47	NSV3672-29TTRS	\$3,231	\$3,354	\$3,301	\$3,414	--
	36	66	29	207	44	NSV3666-29TTRS	\$2,932	\$3,042	\$2,998	\$3,099	--
	36	60	29	198	38	NSV3660-29TTRS	\$2,875	\$2,975	\$2,936	\$3,027	--
	30	72	29	165	41	NSV3072-29TTRS	\$2,879	\$3,004	\$2,949	\$3,060	--
	30	66	29	158	41	NSV3066-29TTRS	\$2,821	\$2,936	\$2,880	\$2,984	--
	30	60	29	151	36	NSV3060-29TTRS	\$2,772	\$2,876	\$2,835	\$2,928	--
SOLID SURFACE	36	72	29	248	47	NSS3672-29TTRS	--	--	--	--	\$6,175
	36	66	29	237	44	NSS3666-29TTRS	--	--	--	--	\$5,666
	36	60	29	226	38	NSS3660-29TTRS	--	--	--	--	\$5,398
	30	72	29	191	41	NSS3072-29TTRS	--	--	--	--	\$5,405
	30	66	29	181	41	NSS3066-29TTRS	--	--	--	--	\$5,173
	30	60	29	172	36	NSS3060-29TTRS	--	--	--	--	\$4,947

NOSH

To Order Specify

① Veneer Model #	② Edge Detail	③ Wood Species	④ Wood Finish	⑤ Electrical Cut Out	⑥ Metal Finish
Veneer (NSV)	See Edge Detail Options	Flat Cut B01 Cherry CH1 Cherry MA1 Maple WA1 Walnut	See Flat Cut Wood Finish Options	N None CO_EC23 Cut out for EC23 CO_EC24 Cut out for EC24	See Metal Finish Options
		Double Cut DC2 Double Cut	④ Wood Finish See Double Cut Wood Finish Options		

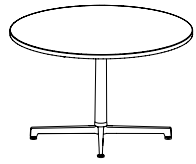
① Solid Surface Model #	② Edge Detail	③ Solid Surface	④ Electrical Cut Out	⑤ Metal Finish
Solid Surface (NSS)	See Edge Detail Options	See Solid Surface Options	N None CO_EC23 Cut out for EC23 CO_EC24 Cut out for EC24	See Metal Finish Options

Nosh - 29"h Tables

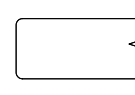


Description

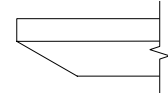
Round Table with X Base



Laminate Tables "NST" Models



Eased Edge (R3)



Reverse Bevel Edge (K9)

LAMINATE	D	W	H	CTN WT	CU FT	① Model	Eased Edge (R3)			Reverse Bevel Edge (K9)		
							Standard	Graded In		Standard	Graded In	
							Tier 1	Tier 2	Tier 3	Tier 1	Tier 2	Tier 3
	48	N/A	29	86	22	NST48-29RDX	\$1,424	\$1,533	\$1,651	\$1,836	\$1,945	\$2,066
	42	N/A	29	72	17	NST42-29RDX	\$1,300	\$1,408	\$1,495	\$1,713	\$1,821	\$1,907
	36	N/A	29	59	17	NST36-29RDX	\$1,260	\$1,298	\$1,362	\$1,672	\$1,710	\$1,774
	30	N/A	29	47	14	NST30-29RDX	\$1,213	\$1,244	\$1,281	\$1,625	\$1,657	\$1,694

Features:

- price reflects complete table - top and base
- ships KD in multiple cartons
- top has option for cutout to receive electrical component, ordered separately
- when electrical cut out selected, power accessible base is sent - add \$111
- base has leveling glides
- width of base foot varies from 26" or 32"

HSON

To Order Specify

① Laminate Model #	② Edge Detail	③ Laminate Selection	③a PVC Edge Color	④ Electrical Cut Out	⑤ Metal Finish
Laminate (NST)	See Edge Detail Options	See Laminate Detail Selection	See PVC Edge Color Options	N None COB_EC23 Cut out for EC23 COB_EC24 Cut out for EC24	See Metal Finish Options

Model Number Breakdown

NST30-29RDX					
NS	T	30	29	RD	X
Nosh	Laminate	30" Diameter	Height	Round Top Shape	X Base

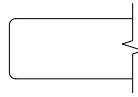
NS34 Nosh

Description

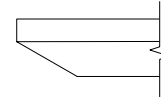
Round Table with X Base
(continued)

Veneer Tables
"NSV" Models

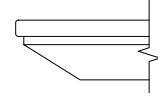
Solid Surface Tables
"NSS" Models



Eased Edge (R3)



Reverse Bevel Edge (K9)



Reverse Bevel Edge (S7)

	D	W	H	CTN WT	CU FT	① Model	Eased Edge (R3)		Reverse Bevel Edge (K9)		Standard
							Flat Cut	Double Cut	Flat Cut	Double Cut	
VENEER	48	N/A	29	86	22	NSV48-29RDX	\$1,907	\$2,042	\$1,985	\$2,125	--
	42	N/A	29	72	17	NSV42-29RDX	\$1,744	\$1,867	\$1,812	\$1,941	--
	36	N/A	29	59	17	NSV36-29RDX	\$1,687	\$1,806	\$1,755	\$1,879	--
	30	N/A	29	47	14	NSV30-29RDX	\$1,624	\$1,738	\$1,689	\$1,808	--
SOLID SURFACE	48	N/A	29	117	22	NSS48-29RDX	--	--	--	--	\$4,576
	42	N/A	29	95	17	NSS42-29RDX	--	--	--	--	\$3,887
	36	N/A	29	75	17	NSS36-29RDX	--	--	--	--	\$3,377
	30	N/A	29	58	14	NSS30-29RDX	--	--	--	--	\$2,928

NOSH

To Order Specify

① Veneer Model #	② Edge Detail	③ Wood Species	④ Wood Finish	⑤ Electrical Cut Out	⑥ Metal Finish
Veneer (NSV)	See Edge Detail Options	Flat Cut B01 Cherry CH1 Cherry MA1 Maple WA1 Walnut	See Flat Cut Wood Finish Options	N None CO_EC23 Cut out for EC23 CO_EC24 Cut out for EC24	See Metal Finish Options
		Double Cut DC2 Double Cut	④ Wood Finish See Double Cut Wood Finish Options		

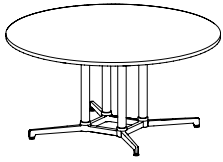
① Solid Surface Model #	② Edge Detail	③ Solid Surface	④ Electrical Cut Out	⑤ Metal Finish
Solid Surface (NSS)	See Edge Detail Options	See Solid Surface Options	N None CO_EC23 Cut out for EC23 CO_EC24 Cut out for EC24	See Metal Finish Options

Nosh - 29"h Tables

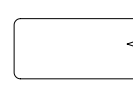


Description

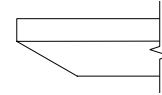
Round Table with X4 Base



Laminate Tables "NST" Models



Eased Edge (R3)



Reverse Bevel Edge (K9)

LAMINATE	D	W	H	CTN WT	CU FT	① Model	Eased Edge (R3)			Reverse Bevel Edge (K9)		
							Standard	Graded In		Standard	Graded In	
							Tier 1	Tier 2	Tier 3	Tier 1	Tier 2	Tier 3
	60	N/A	29	148	46	NST60-29RDZ	\$2,323	\$2,406	\$2,597	\$2,735	\$2,820	\$3,009
	54	N/A	29	103	26	NST54-29RDZ	\$2,276	\$2,341	\$2,405	\$2,688	\$2,753	\$2,817

Features:

- price reflects complete table - top and base
- ships KD in multiple cartons
- top has option for cutout to receive electrical component, ordered separately
- optional vertical wire manager for base, order separately
- base has leveling glides
- width of base foot is 38"

HSON

To Order Specify

① Laminate Model #	② Edge Detail	③ Laminate Selection	③a PVC Edge Color	④ Electrical Cut Out	⑤ Metal Finish
Laminate (NST)	See Edge Detail Options	See Laminate Detail Selection	See PVC Edge Color Options	N None CO_EC23 Cut out for EC23 CO_EC24 Cut out for EC24	See Metal Finish Options

Model Number Breakdown

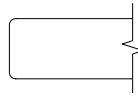
NST54-29RDZ					
NS	T	54	29	RD	Z
Nosh	Laminate	54" Diameter	Height	Round Top Shape	X4 base

NS36 Nosh

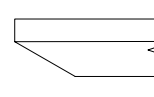
Description

Round Table with X4 Base
(continued)

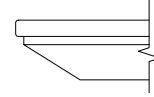
Veneer Tables "NSV" Models				Solid Surface Tables "NSS" Models	
-------------------------------	--	--	--	--------------------------------------	--



Eased Edge (R3)



Reverse Bevel Edge (K9)



Reverse Bevel Edge (S7)

	D	W	H	CTN WT	CU FT	① Model	Eased Edge (R3)		Reverse Bevel Edge (K9)		Reverse Bevel Edge (S7) Standard
							Flat Cut	Double Cut	Flat Cut	Double Cut	
VENEER	60	N/A	29	148	46	NSV60-29RDZ	\$3,110	\$3,330	\$3,234	\$3,462	--
	54	N/A	29	103	26	NSV54-29RDZ	\$3,048	\$3,260	\$3,169	\$3,392	--
SOL SURF	60	N/A	29	196	46	NSS60-29RDZ	--	--	--	--	\$7,034
	54	N/A	29	141	26	NSS54-29RDZ	--	--	--	--	\$6,309

NOSH

To Order Specify

① Veneer Model #	② Edge Detail	③ Wood Species	④ Wood Finish	⑤ Electrical Cut Out	⑥ Metal Finish
Veneer (NSV)	See Edge Detail Options	Flat Cut B01 Cherry CH1 Cherry MA1 Maple WA1 Walnut	See Flat Cut Wood Finish Options	N None CO_EC23 Cut out for EC23 CO_EC24 Cut out for EC24	See Metal Finish Options
		Double Cut DC2 Double Cut	④ Wood Finish See Double Cut Wood Finish Options		

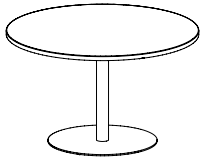
① Solid Surface Model #	② Edge Detail	③ Solid Surface	④ Electrical Cut Out	⑤ Metal Finish
Solid Surface (NSS)	See Edge Detail Options	See Solid Surface Options	N None CO_EC23 Cut out for EC23 CO_EC24 Cut out for EC24	See Metal Finish Options

Nosh - 29"h Tables

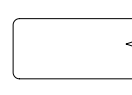


Description

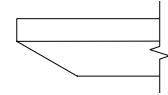
Round Table with Round Disc Base



Laminate Tables "NST" Models



Eased Edge (R3)



Reverse Bevel (K9)

LAMINATE	D	W	H	CTN WT	CU FT	❶ Model	Eased Edge (R3)			Reverse Bevel (K9)		
							Standard	Graded In		Standard	Graded In	
							Tier 1	Tier 2	Tier 3	Tier 1	Tier 2	Tier 3
	48	N/A	29	130	22	NST48-29RDR	\$1,650	\$1,707	\$1,828	\$2,064	\$2,120	\$2,240
	42	N/A	29	97	17	NST42-29RDR	\$1,498	\$1,549	\$1,635	\$1,912	\$1,961	\$2,047
	36	N/A	29	85	14	NST36-29RDR	\$1,270	\$1,311	\$1,370	\$1,683	\$1,724	\$1,783
	30	N/A	29	62	12	NST30-29RDR	\$1,077	\$1,111	\$1,146	\$1,489	\$1,524	\$1,558

Features:

- price reflects complete table - top and base
- ships KD in multiple cartons
- cut out for power is not available on these tables
- base has anti-rock glides
- width of base foot varies from 17" to 27"

HSON

To Order Specify

❶ Laminate Model #	❷ Edge Detail	❸ Laminate Selection	❸a PVC Edge Color	❹ Metal Finish
Laminate (NST)	See Edge Detail Options	See Laminate Detail Selection	See PVC Edge Color Options	See Metal Finish Options

Model Number Breakdown

NST30-29RDR					
NS	T	30	29	RD	R
Nosh	Laminate	30" Diameter	Height	Round Top Shape	Round Disc Base

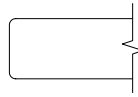
NS38 Nosh

Description

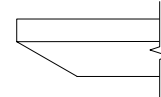
Round Table with Round Disc Base
(continued)

Veneer Tables
"NSV" Models

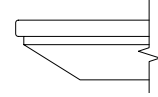
Solid Surface Tables
"NSS" Models



Eased Edge (R3)



Reverse Bevel Edge (K9)



Reverse Bevel Edge (S7)

	D	W	H	CTN WT	CU FT	① Model	Eased Edge (R3)		Reverse Bevel Edge (K9)		Reverse Bevel Edge (S7) Standard
							Flat Cut	Double Cut	Flat Cut	Double Cut	
VENEER	48	N/A	29	130	22	NSV48-29RDR	\$2,211	\$2,365	\$2,301	\$2,460	--
	42	N/A	29	97	17	NSV42-29RDR	\$2,008	\$2,150	\$2,090	\$2,238	--
	36	N/A	29	85	14	NSV36-29RDR	\$1,700	\$1,820	\$1,770	\$1,894	--
	30	N/A	29	62	12	NSV30-29RDR	\$1,443	\$1,543	\$1,500	\$1,606	--
SOLID SURFACE	48	N/A	29	160	22	NSS48-29RDR	--	--	--	--	\$4,877
	42	N/A	29	138	17	NSS42-29RDR	--	--	--	--	\$4,152
	36	N/A	29	71	14	NSS36-29RDR	--	--	--	--	\$3,391
	30	N/A	29	73	12	NSS30-29RDR	--	--	--	--	\$2,746

NOSH

To Order Specify

① Veneer Model #	② Edge Detail	③ Wood Species	④ Wood Finish	⑤ Electrical Cut Out	⑥ Metal Finish
Veneer (NSV)	See Edge Detail Options	Flat Cut B01 Cherry CH1 Cherry MA1 Maple WA1 Walnut	See Flat Cut Wood Finish Options	N None CO_EC23 Cut out for EC23 CO_EC24 Cut out for EC24	See Metal Finish Options
		Double Cut DC2 Double Cut	④ Wood Finish See Double Cut Wood Finish Options		

① Solid Surface Model #	② Edge Detail	③ Solid Surface	④ Electrical Cut Out	⑤ Metal Finish
Solid Surface (NSS)	See Edge Detail Options	See Solid Surface Options	N None CO_EC23 Cut out for EC23 CO_EC24 Cut out for EC24	See Metal Finish Options

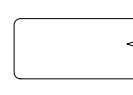
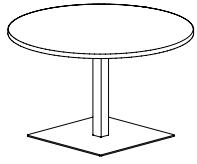
Nosh - 29"h Tables



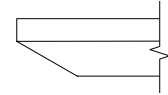
Description

Round Table with Square Disc Base

Laminate Tables "NST" Models



Eased Edge (R3)



Reverse Bevel Edge (K9)

LAMINATE	D	W	H	CTN WT	CU FT	① Model	Eased Edge (R3)			Reverse Bevel Edge (K9)		
							Standard	Graded In		Standard	Graded In	
							Tier 1	Tier 2	Tier 3	Tier 1	Tier 2	Tier 3
	48	N/A	29	145	22	NST48-29RDS	\$1,853	\$1,908	\$2,029	\$2,265	\$2,324	\$2,442
	42	N/A	29	108	17	NST42-29RDS	\$1,701	\$1,908	\$2,029	\$2,114	\$2,324	\$2,442
	36	N/A	29	96	14	NST36-29RDS	\$1,409	\$1,449	\$1,509	\$1,822	\$1,864	\$1,922
	30	N/A	29	68	12	NST30-29RDS	\$1,216	\$1,250	\$1,286	\$1,629	\$1,663	\$1,699

Features:

- price reflects complete table - top and base
- ships KD in multiple cartons
- cut out for power is not available on these tables
- base has anti-rock glides
- width of base foot varies from 17" to 27"

HSON

To Order Specify

① Laminate Model #	② Edge Detail	③ Laminate Selection	③a PVC Edge Color	④ Metal Finish
Laminate (NST)	See Edge Detail Options	See Laminate Detail Selection	See PVC Edge Color Options	See Metal Finish Options

Model Number Breakdown

NST30-29RDS					
NS	T	30	29	RD	S
Nosh	Laminate	30" Diameter	Height	Round Top Shape	Square Disc Base

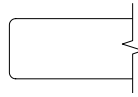
NS40 Nosh

Description

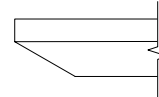
Round Table with Square Disc Base
(continued)

Veneer Tables
"NSV" Models

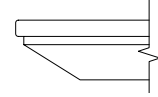
Solid Surface Tables
"NSS" Models



Eased Edge (R3)



Reverse Bevel Edge (K9)



Reverse Bevel Edge (S7)

	D	W	H	CTN WT	CU FT	① Model	Eased Edge (R3)		Reverse Bevel Edge (K9)		Reverse Bevel Edge (S7)
							Flat Cut	Double Cut	Flat Cut	Double Cut	Standard
VENEER	48	N/A	29	145	22	NSV48-29RDS	\$2,482	\$2,655	\$2,582	\$2,764	--
	42	N/A	29	108	17	NSV42-29RDS	\$2,280	\$2,439	\$2,371	\$2,537	--
	36	N/A	29	96	14	NSV36-29RDS	\$1,890	\$2,021	\$1,965	\$2,103	--
	30	N/A	29	68	12	NSV30-29RDS	\$1,629	\$1,744	\$1,696	\$1,816	--
SOLID SURFACE	48	N/A	29	175	22	NSS48-29RDS	--	--	--	--	\$5,151
	42	N/A	29	153	17	NSS42-29RDS	--	--	--	--	\$4,423
	36	N/A	29	145	14	NSS36-29RDS	--	--	--	--	\$3,579
	30	N/A	29	139	12	NSS30-29RDS	--	--	--	--	\$2,933

NOSH

To Order Specify

① Veneer Model #	② Edge Detail	③ Wood Species	④ Wood Finish	⑤ Electrical Cut Out	⑥ Metal Finish
Veneer (NSV)	See Edge Detail Options	Flat Cut B01 Cherry CH1 Cherry MA1 Maple WA1 Walnut	See Flat Cut Wood Finish Options	N None CO_EC23 Cut out for EC23 CO_EC24 Cut out for EC24	See Metal Finish Options
		Double Cut DC2 Double Cut	④ Wood Finish See Double Cut Wood Finish Options		

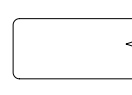
① Solid Surface Model #	② Edge Detail	③ Solid Surface	④ Electrical Cut Out	⑤ Metal Finish
Solid Surface (NSS)	See Edge Detail Options	See Solid Surface Options	N None CO_EC23 Cut out for EC23 CO_EC24 Cut out for EC24	See Metal Finish Options

Description

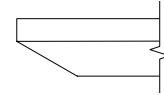
Square Table with X Base



Laminate Tables "NST" Models



Eased Edge (R3)



Reverse Bevel Edge (K9)

LAMINATE	D	W	H	CTN WT	CU FT	❶ Model	Eased Edge (R3)			Reverse Bevel Edge (K9)		
							Standard	Graded In		Standard	Graded In	
							Tier 1	Tier 2	Tier 3	Tier 1	Tier 2	Tier 3
	48	48	29	103	22	NST4848-29SQX	\$1,456	\$1,507	\$1,632	\$1,870	\$1,920	\$2,044
	42	42	29	85	17	NST4242-29SQX	\$1,336	\$1,383	\$1,496	\$1,748	\$1,795	\$1,908
	36	36	29	68	17	NST3636-29SQX	\$1,176	\$1,215	\$1,241	\$1,589	\$1,628	\$1,655
	30	30	29	53	12	NST3030-29SQX	\$1,048	\$1,080	\$1,094	\$1,462	\$1,493	\$1,507

Features:

- price reflects complete table - top and base
- ships KD in multiple cartons
- top has option for cutout to receive electrical component, ordered separately
- when electrical cut out selected, power accessible base is sent - add \$111
- base has leveling glides
- width of base foot varies from 26" to 38"

HSON

To Order Specify

❶ Laminate Model #	❷ Edge Detail	❸ Laminate Selection	❹ PVC Edge Color	❺ Electrical Cut Out	❻ Metal Finish
Laminate (NST)	See Edge Detail Options	See Laminate Detail Selection	See PVC Edge Color Options	N None COB_EC23 Cut out for EC23 COB_EC24 Cut out for EC24	See Metal Finish Options

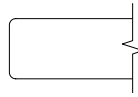
Model Number Breakdown

NST3030-29SQX					
NS	T	3030	29	SQ	X
Nosh	Laminate	30" x 30"	Height	Square Top Shape	X Base

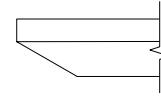
Description

Square Table with X Base
(continued)

Veneer Tables
"NSV" Models



Eased Edge (R3)



Reverse Bevel Edge (K9)

VENEER	D	W	H	CTN WT	CU FT	1 Model	Flat Cut	Double Cut	Flat Cut	Double Cut
		48	48	29	103	22	NSV4848-29SQX	\$1,922	\$2,057	\$2,000
	42	42	29	85	17	NSV4242-29SQX	\$1,761	\$1,884	\$1,833	\$1,961
	36	36	29	68	17	NSV3636-29SQX	\$1,553	\$1,661	\$1,616	\$1,729
	30	30	29	53	12	NSV3030-29SQX	\$1,384	\$1,483	\$1,440	\$1,541

NOSH

To Order Specify

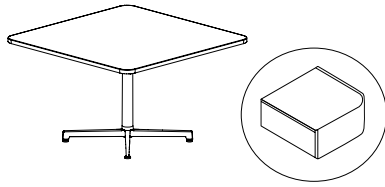
1 Veneer Model #	2 Edge Detail	3 Wood Species	4 Wood Finish	5 Electrical Cut Out	6 Metal Finish
Veneer (NSV)	See Edge Detail Options	Flat Cut B01 Cherry CH1 Cherry MA1 Maple WA1 Walnut	See Flat Cut Wood Finish Options	N None CO_EC23 Cut out for EC23 CO_EC24 Cut out for EC24	See Metal Finish Options
		Double Cut DC2 Double Cut	4 Wood Finish See Double Cut Wood Finish Options		

Nosh - 29" h Tables

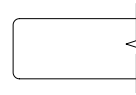


Description

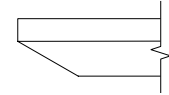
Rounded Square Table with X Base



Laminate Tables "NST" Models



Eased Edge (R3)



Reverse Bevel (K9)

LAMINATE	D	W	H	CTN WT	CU FT	① Model	Eased Edge (R3)			Reverse Bevel (K9)		
							Standard	Graded In		Standard	Graded In	
							Tier 1	Tier 2	Tier 3	Tier 1	Tier 2	Tier 3
	48	48	29	103	22	NST4848-29SQRX	\$1,792	\$1,842	\$1,991	\$2,204	\$2,255	\$2,404
	42	42	29	85	17	NST4242-29SQRX	\$1,658	\$1,706	\$1,868	\$2,071	\$2,119	\$2,280
	36	36	29	69	17	NST3636-29SQRX	\$1,369	\$1,408	\$1,468	\$1,782	\$1,821	\$1,880
	30	30	29	53	12	NST3030-29SQRX	\$1,216	\$1,249	\$1,286	\$1,629	\$1,661	\$1,699

Features:

- price reflects complete table - top and base
- ships KD in multiple cartons
- top has option for cutout to receive electrical component, ordered separately
- when electrical cut out selected, power accessible base is sent - add \$111
- base has leveling glides
- width of base foot varies from 26" to 38"

HSON

To Order Specify

① Laminate Model #	② Edge Detail	③ Laminate Selection	③a PVC Edge Color	④ Electrical Cut Out	⑤ Metal Finish
Laminate (NST)	See Edge Detail Options	See Laminate Detail Selection	See PVC Edge Color Options	N None COB_EC23 Cut out for EC23 COB_EC24 Cut out for EC24	See Metal Finish Options

Model Number Breakdown

NST3030-29SQRX						
NS	T	3030	29	SQ	R	X
Nosh	Laminate	30" x 30"	Height	Square Top Shape	Rounded Corner	X base

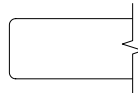
NS44 Nosh

Description

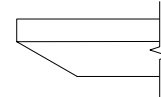
Rounded Square Table with X Base
(continued)

Veneer Tables
"NSV" Models

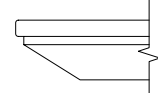
Solid Surface Tables
"NSS" Models



Eased Edge (R3)



Reverse Bevel Edge (K9)



Reverse Bevel Edge (S7)

	D	W	H	CTN WT	CU FT	① Model	Eased Edge (R3)		Reverse Bevel Edge (K9)		Reverse Bevel Edge (S7) Standard
							Flat Cut	Double Cut	Flat Cut	Double Cut	
VENEER	48	48	29	103	22	NSV4848-29SQRX	\$2,364	\$2,531	\$2,458	\$2,632	--
	42	42	29	85	17	NSV4242-29SQRX	\$2,196	\$2,351	\$2,286	\$2,447	--
	36	36	29	69	17	NSV3636-29SQRX	\$1,806	\$1,933	\$1,878	\$2,009	--
	30	30	29	53	12	NSV3030-29SQRX	\$1,605	\$1,719	\$1,670	\$1,786	--
SOLID SURFACE	48	48	29	145	22	NSS4848-29SQRX	--	--	--	--	\$5,033
	42	42	29	117	17	NSS4242-29SQRX	--	--	--	--	\$4,340
	36	36	29	93	17	NSS3636-29SQRX	--	--	--	--	\$3,496
	30	30	29	70	12	NSS3030-29SQRX	--	--	--	--	\$2,908

NOSH

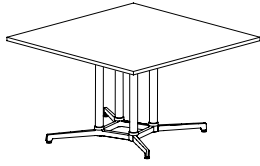
To Order Specify

① Veneer Model #	② Edge Detail	③ Wood Species	④ Wood Finish	⑤ Electrical Cut Out	⑥ Metal Finish
Veneer (NSV)	See Edge Detail Options	Flat Cut B01 Cherry CH1 Cherry MA1 Maple WA1 Walnut	See Flat Cut Wood Finish Options	N None CO_EC23 Cut out for EC23 CO_EC24 Cut out for EC24	See Metal Finish Options
		Double Cut DC2 Double Cut	④ Wood Finish See Double Cut Wood Finish Options		

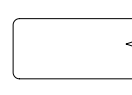
① Solid Surface Model #	② Edge Detail	③ Solid Surface	④ Electrical Cut Out	⑤ Metal Finish
Solid Surface (NSS)	See Edge Detail Options	See Solid Surface Options	N None CO_EC23 Cut out for EC23 CO_EC24 Cut out for EC24	See Metal Finish Options

Description

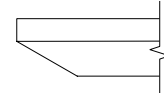
Square Table with X4 Base



Laminate Tables "NST" Models



Eased Edge (R3)



Reverse Bevel Edge (K9)

LAMINATE	D	W	H	CTN WT	CU FT	① Model	Eased Edge (R3)			Reverse Bevel Edge (K9)		
							Standard	Graded In		Standard	Graded In	
							Tier 1	Tier 2	Tier 3	Tier 1	Tier 2	Tier 3
	60	60	29	175	46	NST6060-29SQZ	\$2,665	\$2,750	\$2,940	\$3,079	\$3,162	\$3,352
	54	54	29	151	50	NST5454-29SQZ	\$2,528	\$2,602	\$2,751	\$2,941	\$3,014	\$3,163

Features:

- price reflects complete table - top and base
- ships KD in multiple cartons
- top has option for cutout to receive electrical component, ordered separately
- optional vertical wire manager for base, order separately
- base has leveling glides
- width of base foot is 38"

HSON

To Order Specify

① Laminate Model #	② Edge Detail	③ Laminate Selection	③a PVC Edge Color	④ Electrical Cut Out	⑤ Metal Finish
Laminate (NST)	See Edge Detail Options	See Laminate Detail Selection	See PVC Edge Color Options	N None CO_EC23 Cut out for EC23 CO_EC24 Cut out for EC24	See Metal Finish Options

Model Number Breakdown

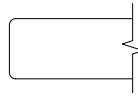
NSV6060-29SQZ					
NS	V	6060	29	SQ	Z
Nosh	Veneer	60" x 60"	Height	Square Top Shape	X4 Base

NS46 Nosh

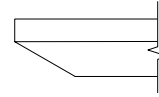
Description

Square Table with X4 Base
(continued)

Veneer Tables
"NSV" Models



Eased Edge (R3)



Reverse Bevel Edge (K9)

VENEER	D	W	H	CTN WT	CU FT	1 Model	Flat Cut	Double Cut	Flat Cut	Double Cut
	60	60	29	175	46	NSV6060-29SQZ	\$3,518	\$3,764	\$3,659	\$3,916
54	54	29	151	50	NSV5454-29SQZ	\$3,338	\$3,571	\$3,470	\$3,715	

NOSH

To Order Specify

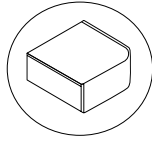
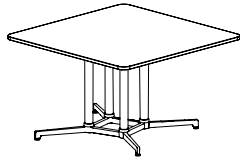
1 Veneer Model #	2 Edge Detail	3 Wood Species	4 Wood Finish	5 Electrical Cut Out	6 Metal Finish
Veneer (NSV)	See Edge Detail Options	Flat Cut B01 Cherry CH1 Cherry MA1 Maple WA1 Walnut	See Flat Cut Wood Finish Options	N None CO_EC23 Cut out for EC23 CO_EC24 Cut out for EC24	See Metal Finish Options
		Double Cut DC2 Double Cut	4 Wood Finish See Double Cut Wood Finish Options		

Nosh - 29"h Tables

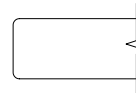


Description

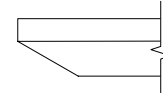
Rounded Square Counter Height
Table with X4 Base



Laminate Tables "NST" Models



Eased Edge (R3)



Reverse Bevel (K9)

LAMINATE	D	W	H	CTN WT	CU FT	① Model	Eased Edge (R3)			Reverse Bevel (K9)		
							Standard	Graded In		Standard	Graded In	
							Tier 1	Tier 2	Tier 3	Tier 1	Tier 2	Tier 3
	60	60	29	68	46	NST6060-29SQRZ	\$2,879	\$2,952	\$3,152	\$3,292	\$3,365	\$3,565
	54	54	29	174	50	NST5454-29SQRZ	\$2,350	\$2,426	\$2,572	\$2,762	\$2,838	\$2,985

Features:

- price reflects complete table - top and base
- ships KD in multiple cartons
- top has option for cutout to receive electrical component, ordered separately
- optional vertical wire manager for base, order separately
- base has leveling glides
- width of base foot is 38"

HSON

To Order Specify

① Laminate Model #	② Edge Detail	③ Laminate Selection	③a PVC Edge Color	④ Electrical Cut Out	⑤ Metal Finish
Laminate (NST)	See Edge Detail Options	See Laminate Detail Selection	See PVC Edge Color Options	N None CO_EC23 Cut out for EC23 CO_EC24 Cut out for EC24	See Metal Finish Options

Model Number Breakdown

NST5454-29SQRZ						
NS	T	5454	29	SQ	R	Z
Nosh	Laminate	54" x 54"	Height	Square Top Shape	Rounded Corner	X4 Base

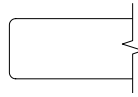
NS48 Nosh

Description

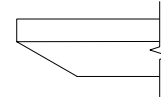
Rounded Square Table with X4 Base
(continued)

Veneer Tables
"NSV" Models

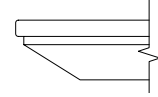
Solid Surface Tables
"NSS" Models



Eased Edge (R3)



Reverse Bevel Edge (K9)



Reverse Bevel Edge (S7)

	D	W	H	CTN WT	CU FT	1 Model	Eased Edge (R3)		Reverse Bevel Edge (K9)		Standard
							Flat Cut	Double Cut	Flat Cut	Double Cut	
VENEER	60	60	29	174	46	NSV6060-29SQRZ	\$3,799	\$4,066	\$3,952	\$4,230	--
	54	54	29	151	50	NSV5454-29SQRZ	\$3,101	\$3,318	\$3,226	\$3,451	--
SOL SURF	60	60	29	235	46	NSS6060-29SQRZ	--	--	--	--	\$7,722
	54	54	29	200	50	NSS5454-29SQRZ	--	--	--	--	\$6,363

NOSH

To Order Specify

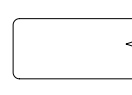
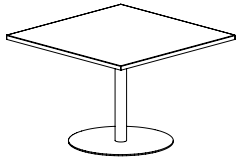
1 Veneer Model #	2 Edge Detail	3 Wood Species	4 Wood Finish	5 Electrical Cut Out	6 Metal Finish
Veneer (NSV)	See Edge Detail Options	Flat Cut B01 Cherry CH1 Cherry MA1 Maple WA1 Walnut	See Flat Cut Wood Finish Options	N None CO_EC23 Cut out for EC23 CO_EC24 Cut out for EC24	See Metal Finish Options
		Double Cut DC2 Double Cut	4 Wood Finish See Double Cut Wood Finish Options		

1 Solid Surface Model #	2 Edge Detail	3 Solid Surface	4 Electrical Cut Out	5 Metal Finish
Solid Surface (NSS)	See Edge Detail Options	See Solid Surface Options	N None CO_EC23 Cut out for EC23 CO_EC24 Cut out for EC24	See Metal Finish Options

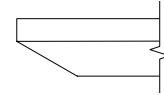
Description

Square Table with Round Disc Base

Laminate Tables "NST" Models



Eased Edge (R3)



Reverse Bevel Edge (K9)

LAMINATE	D	W	H	CTN WT	CU FT	① Model	Eased Edge (R3)			Reverse Bevel Edge (K9)		
							Standard	Graded In		Standard	Graded In	
							Tier 1	Tier 2	Tier 3	Tier 1	Tier 2	Tier 3
	42	42	29	128	17	NST4242-29SQR	\$1,182	\$1,228	\$1,270	\$1,594	\$1,642	\$1,683
	36	36	29	94	15	NST3636-29SQR	\$1,073	\$1,112	\$1,136	\$1,486	\$1,526	\$1,550
	30	30	29	81	13	NST3030-29SQR	\$1,014	\$1,047	\$1,060	\$1,426	\$1,460	\$1,472

Features:

- price reflects complete table - top and base
- ships KD in multiple cartons
- cut out for power is not available on these tables
- base has anti-rock glides
- width of base foot varies from 22" or 27"

HSON

To Order Specify

① Laminate Model #	② Edge Detail	③ Laminate Selection	③a PVC Edge Color	④ Metal Finish
Laminate (NST)	See Edge Detail Options	See Laminate Detail Selection	See PVC Edge Color Options	See Metal Finish Options

Model Number Breakdown

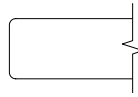
NST3030-29SQR					
NS	T	3030	29	SQ	R
Nosh	Laminate	30" x 30"	Height	Square Top Shape	Round Disc Base

NS50 Nosh

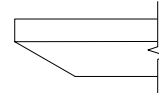
Description

Square Table with Round Disc Base
(continued)

Veneer Tables
"NSV" Models



Eased Edge (R3)



Reverse Bevel Edge (K9)

VENEER	D	W	H	CTN WT	CU FT	1 Model	Flat Cut	Double Cut	Flat Cut	Double Cut
	42	42	29	128	17	NSV4242-29SQR	\$1,558	\$1,668	\$1,622	\$1,735
36	36	29	94	15	NSV3636-29SQR	\$1,415	\$1,514	\$1,472	\$1,576	
30	30	29	81	13	NSV3030-29SQR	\$1,338	\$1,432	\$1,392	\$1,490	

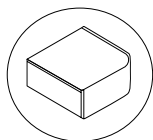
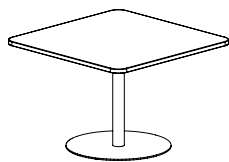
NOSH

To Order Specify

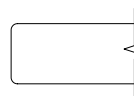
1 Veneer Model #	2 Edge Detail	3 Wood Species	4 Wood Finish	5 Electrical Cut Out	6 Metal Finish
Veneer (NSV)	See Edge Detail Options	Flat Cut B01 Cherry CH1 Cherry MA1 Maple WA1 Walnut	See Flat Cut Wood Finish Options	N None CO_EC23 Cut out for EC23 CO_EC24 Cut out for EC24	See Metal Finish Options
		Double Cut DC2 Double Cut	4 Wood Finish See Double Cut Wood Finish Options		

Description

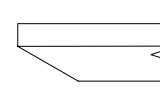
Rounded Square Table with Round Disc Base



Laminate Tables "NST" Models



Eased Edge (R3)



Reverse Bevel (K9)

LAMINATE	D	W	H	CTN WT	CU FT	① Model	Eased Edge (R3)			Reverse Bevel (K9)		
							Standard	Graded In		Standard	Graded In	
							Tier 1	Tier 2	Tier 3	Tier 1	Tier 2	Tier 3
	42	42	29	128	17	NST4242-29SQRR	\$1,505	\$1,553	\$1,638	\$1,918	\$1,966	\$2,052
	36	36	29	94	15	NST3636-29SQRR	\$1,264	\$1,303	\$1,364	\$1,678	\$1,719	\$1,777
	30	30	29	82	13	NST3030-29SQRR	\$1,182	\$1,216	\$1,251	\$1,594	\$1,629	\$1,665

Features:

- price reflects complete table - top and base
- ships KD in multiple cartons
- cut out for power is not available on these tables
- base has anti-rock glides
- width of base foot varies from 22" or 27"

HSON

To Order Specify

① Laminate Model #	② Edge Detail	③ Laminate Selection	③a PVC Edge Color	④ Metal Finish
Laminate (NST)	See Edge Detail Options	See Laminate Detail Selection	See PVC Edge Color Options	See Metal Finish Options

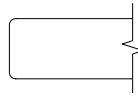
Model Number Breakdown

NST3030-29SQRR						
NS	T	3030	29	SQ	R	R
Nosh	Laminate	30" x 30"	Height	Square Top Shape	Rounded Corner	Round Disc Base

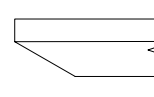
Description

Rounded Square Table with Round Disc Base (continued)

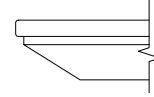
Veneer Tables "NSV" Models Solid Surface Tables "NSS" Models



Eased Edge (R3)



Reverse Bevel Edge (K9)



Reverse Bevel Edge (S7)

	D	W	H	CTN WT	CU FT	① Model	Eased Edge (R3)		Reverse Bevel Edge (K9)		Standard
							Flat Cut	Double Cut	Flat Cut	Double Cut	
VENEER	42	42	29	128	17	NSV4242-29SQRR	\$1,986	\$2,126	\$2,067	\$2,211	--
	36	36	29	94	15	NSV3636-29SQRR	\$1,668	\$1,785	\$1,735	\$1,857	--
	30	30	29	82	13	NSV3030-29SQRR	\$1,558	\$1,668	\$1,622	\$1,735	--
SOL SURF	42	42	29	157	17	NSS4242-29SQRR	--	--	--	--	\$4,129
	36	36	29	115	15	NSS3636-29SQRR	--	--	--	--	\$3,357
	30	30	29	83	13	NSS3030-29SQRR	--	--	--	--	\$2,862

NOSH

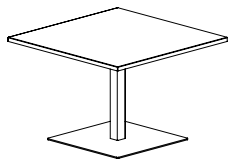
To Order Specify

① Veneer Model #	② Edge Detail	③ Wood Species	④ Wood Finish	⑤ Electrical Cut Out	⑥ Metal Finish
Veneer (NSV)	See Edge Detail Options	Flat Cut B01 Cherry CH1 Cherry MA1 Maple WA1 Walnut	See Flat Cut Wood Finish Options	N None CO_EC23 Cut out for EC23 CO_EC24 Cut out for EC24	See Metal Finish Options
		Double Cut DC2 Double Cut	④ Wood Finish See Double Cut Wood Finish Options		

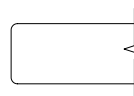
① Solid Surface Model #	② Edge Detail	③ Solid Surface	④ Electrical Cut Out	⑤ Metal Finish
Solid Surface (NSS)	See Edge Detail Options	See Solid Surface Options	N None CO_EC23 Cut out for EC23 CO_EC24 Cut out for EC24	See Metal Finish Options

Description

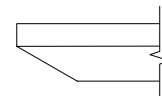
Square Table with Square Disc Base



Laminate Tables "NST" Models



Eased Edge (R3)



Reverse Bevel Edge (K9)

LAMINATE	D	W	H	CTN WT	CU FT	1 Model	Eased Edge (R3)			Reverse Bevel Edge (K9)		
							Standard	Graded In		Standard	Graded In	
							Tier 1	Tier 2	Tier 3	Tier 1	Tier 2	Tier 3
	42	42	29	135	17	NST4242-29SQS	\$1,384	\$1,431	\$1,471	\$1,796	\$1,843	\$1,883
	36	36	29	126	15	NST3636-29SQS	\$1,213	\$1,251	\$1,277	\$1,625	\$1,665	\$1,689
	30	30	29	98	13	NST3030-29SQS	\$1,153	\$1,187	\$1,199	\$1,568	\$1,599	\$1,613

Features:

- price reflects complete table - top and base
- ships KD in multiple cartons
- cut out for power is not available on these tables
- base has anti-rock glides
- width of base foot varies from 17" to 27"

HSON

To Order Specify

1 Laminate Model #	2 Edge Detail	3 Laminate Selection	3a PVC Edge Color	4 Metal Finish
Laminate (NST)	See Edge Detail Options	See Laminate Detail Selection	See PVC Edge Color Options	See Metal Finish Options

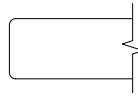
Model Number Breakdown

NST3030-29SQS					
NS	T	3030	29	SQ	S
Nosh	Laminate	30" x 30"	Height	Square Top Shape	Square Disc Base

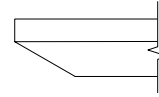
Description

Square Table with Square Disc Base
(continued)

Veneer Tables
"NSV" Models



Eased Edge (R3)



Reverse Bevel Edge (K9)

VENEER	D	W	H	CTN WT	CU FT	1 Model	Flat Cut	Double Cut	Flat Cut	Double Cut
	42	42	29	135	17	NSV4242-29SQS	\$1,827	\$2,032	\$1,899	\$2,033
36	36	29	126	15	NSV3636-29SQS	\$1,599	\$1,777	\$1,665	\$1,782	
30	30	29	98	13	NSV3030-29SQS	\$1,522	\$1,685	\$1,583	\$1,696	

NOSH

To Order Specify

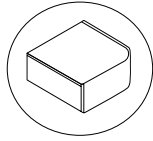
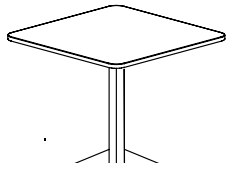
1 Veneer Model #	2 Edge Detail	3 Wood Species	4 Wood Finish	5 Electrical Cut Out	6 Metal Finish
Veneer (NSV)	See Edge Detail Options	Flat Cut B01 Cherry CH1 Cherry MA1 Maple WA1 Walnut	See Flat Cut Wood Finish Options	N None CO_EC23 Cut out for EC23 CO_EC24 Cut out for EC24	See Metal Finish Options
		Double Cut DC2 Double Cut	4 Wood Finish See Double Cut Wood Finish Options		

Nosh - 29" h Tables

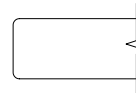


Description

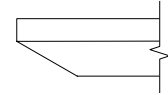
Rounded Square Table with Square Disc Base



Laminate Tables "NST" Models



Eased Edge (R3)



Reverse Bevel (K9)

LAMINATE	D	W	H	CTN WT	CU FT	① Model	Eased Edge (R3)			Reverse Bevel (K9)		
							Standard	Graded In		Standard	Graded In	
							Tier 1	Tier 2	Tier 3	Tier 1	Tier 2	Tier 3
	42	42	29	143	17	NST4242-29SQRS	\$1,706	\$1,754	\$1,841	\$2,119	\$2,168	\$2,254
	36	36	29	105	15	NST3636-29SQRS	\$1,543	\$1,584	\$1,643	\$1,956	\$1,997	\$2,056
	30	30	29	91	13	NST3030-29SQRS	\$1,462	\$1,495	\$1,532	\$1,874	\$1,907	\$1,944

Features:

- price reflects complete table - top and base
- ships KD in multiple cartons
- cut out for power is not available on these tables
- base has anti-rock glides
- width of base foot varies from 17" to 27"

HSON

To Order Specify

① Laminate Model #	② Edge Detail	③ Laminate Selection	③a PVC Edge Color	④ Metal Finish
Laminate (NST)	See Edge Detail Options	See Laminate Detail Selection	See PVC Edge Color Options	See Metal Finish Options

Model Number Breakdown

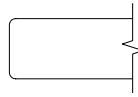
NSV3636-29SQRS						
NS	V	3636	29	SQ	R	S
Nosh	Veneer	36" x 36"	Height	Square Top Shape	Rounded Corner	Square Disc Base

NS56 Nosh

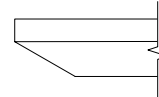
Description

Rounded Square Table with Square Disc Base (continued)

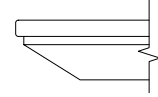
Veneer Tables "NSV" Models Solid Surface Tables "NSS" Models



Eased Edge (R3)



Reverse Bevel Edge (K9)



Reverse Bevel Edge (S7)

	D	W	H	CTN WT	CU FT	① Model	Eased Edge (R3)		Reverse Bevel Edge (K9)		Standard
							Flat Cut	Double Cut	Flat Cut	Double Cut	
VENEER	42	42	29	143	17	NSV4242-29SQRS	\$2,253	\$2,410	\$2,343	\$2,506	--
	36	36	29	105	15	NSV3636-29SQRS	\$2,039	\$2,182	\$2,120	\$2,269	--
	30	30	29	91	13	NSV3030-29SQRS	\$1,929	\$2,066	\$2,005	\$2,147	--
SOL SURF	42	42	29	172	17	NSS4242-29SQRS	--	--	--	--	\$4,397
	36	36	29	126	15	NSS3636-29SQRS	--	--	--	--	\$3,728
	30	30	29	88	13	NSS3030-29SQRS	--	--	--	--	\$3,232

NOSH

To Order Specify

① Veneer Model #	② Edge Detail	③ Wood Species	④ Wood Finish	⑤ Electrical Cut Out	⑥ Metal Finish
Veneer (NSV)	See Edge Detail Options	Flat Cut B01 Cherry CH1 Cherry MA1 Maple WA1 Walnut	See Flat Cut Wood Finish Options	N None CO_EC23 Cut out for EC23 CO_EC24 Cut out for EC24	See Metal Finish Options
		Double Cut DC2 Double Cut	④ Wood Finish See Double Cut Wood Finish Options		

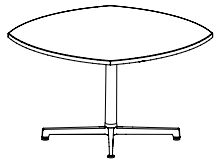
① Solid Surface Model #	② Edge Detail	③ Solid Surface	④ Electrical Cut Out	⑤ Metal Finish
Solid Surface (NSS)	See Edge Detail Options	See Solid Surface Options	N None CO_EC23 Cut out for EC23 CO_EC24 Cut out for EC24	See Metal Finish Options

Nosh - 29" h Tables

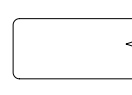


Description

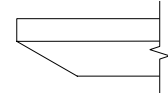
Squirrel Table with X Base



Laminate Tables "NST" Models



Eased Edge (R3)



Reverse Bevel Edge (K9)

LAMINATE	D	W	H	CTN WT	CU FT	① Model	Eased Edge (R3)			Reverse Bevel Edge (K9)		
							Standard	Graded In		Standard	Graded In	
							Tier 1	Tier 2	Tier 3	Tier 1	Tier 2	Tier 3
	48	48	29	86	22	NST48-29SCX	\$1,444	\$1,551	\$1,671	\$1,857	\$1,966	\$2,085
	42	42	29	72	17	NST42-29SCX	\$1,321	\$1,426	\$1,514	\$1,734	\$1,841	\$1,929
	36	36	29	59	17	NST36-29SCX	\$1,277	\$1,318	\$1,378	\$1,691	\$1,731	\$1,793
	30	30	29	47	14	NST30-29SCX	\$1,229	\$1,262	\$1,298	\$1,644	\$1,676	\$1,712

Features:

- price reflects complete table - top and base
- ships KD in multiple cartons
- top has option for cutout to receive electrical component, ordered separately
- when electrical cut out selected, power accessible base is sent - add \$111
- base has leveling glides
- width of base foot varies from 26" to 38"

HSON

To Order Specify

① Laminate Model #	② Edge Detail	③ Laminate Selection	③a PVC Edge Color	④ Electrical Cut Out	⑤ Metal Finish
Laminate (NST)	See Edge Detail Options	See Laminate Detail Selection	See PVC Edge Color Options	N None COB_EC23 Cut out for EC23 COB_EC24 Cut out for EC24	See Metal Finish Options

Model Number Breakdown

NST30-29SCX					
NS	T	30	29	SC	X
Nosh	Laminate	30"	Height	Squirrel Top Shape	X Base

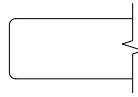
NS58 Nosh

Description

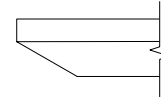
Squircle Table with X Base
(continued)

Veneer Tables
"NSV" Models

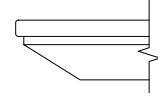
Solid Surface Tables
"NSS" Models



Eased Edge (R3)



Reverse Bevel Edge (K9)



Reverse Bevel Edge (S7)

	D	W	H	CTN WT	CU FT	① Model	Eased Edge (R3)		Reverse Bevel Edge (K9)		Standard
							Flat Cut	Double Cut	Flat Cut	Double Cut	
VENEER	48	48	29	86	22	NSV48-29SCX	\$1,927	\$2,061	\$2,004	\$2,144	--
	42	42	29	72	17	NSV42-29SCX	\$1,761	\$1,883	\$1,833	\$1,960	--
	36	36	29	59	17	NSV36-29SCX	\$1,705	\$1,824	\$1,775	\$1,898	--
	30	30	29	47	14	NSV30-29SCX	\$1,642	\$1,755	\$1,708	\$1,828	--
SOLID SURFACE	48	48	29	117	22	NSS48-29SCX	--	--	--	--	\$4,612
	42	42	29	95	17	NSS42-29SCX	--	--	--	--	\$3,921
	36	36	29	75	17	NSS36-29SCX	--	--	--	--	\$3,413
	30	30	29	58	14	NSS30-29SCX	--	--	--	--	\$2,963

NOSH

To Order Specify

① Veneer Model #	② Edge Detail	③ Wood Species	④ Wood Finish	⑤ Electrical Cut Out	⑥ Metal Finish
Veneer (NSV)	See Edge Detail Options	Flat Cut B01 Cherry CH1 Cherry MA1 Maple WA1 Walnut	See Flat Cut Wood Finish Options	N None CO_EC23 Cut out for EC23 CO_EC24 Cut out for EC24	See Metal Finish Options
		Double Cut DC2 Double Cut	④ Wood Finish See Double Cut Wood Finish Options		

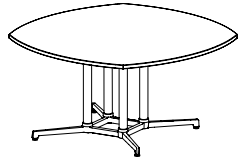
① Solid Surface Model #	② Edge Detail	③ Solid Surface	④ Electrical Cut Out	⑤ Metal Finish
Solid Surface (NSS)	See Edge Detail Options	See Solid Surface Options	N None CO_EC23 Cut out for EC23 CO_EC24 Cut out for EC24	See Metal Finish Options

Nosh - 29"h Tables

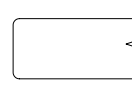


Description

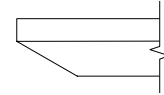
Squirrel Table with X4 Base



Laminate Tables "NST" Models



Eased Edge (R3)



Reverse Bevel Edge (K9)

LAMINATE	D	W	H	CTN WT	CU FT	① Model	Eased Edge (R3)			Reverse Bevel Edge (K9)		
							Standard	Graded In		Standard	Graded In	
							Tier 1	Tier 2	Tier 3	Tier 1	Tier 2	Tier 3
	60	60	29	148	46	NST60-29SCZ	\$2,341	\$2,427	\$2,614	\$2,754	\$2,840	\$3,029
	54	54	29	103	26	NST54-29SCZ	\$2,292	\$2,358	\$2,426	\$2,709	\$2,774	\$2,839

Features:

- price reflects complete table - top and base
- ships KD in multiple cartons
- top has option for cutout to receive electrical component, ordered separately
- optional vertical wire manager for base, order separately
- base has leveling glides
- width of base foot is 38"

HSON

To Order Specify

① Laminate Model #	② Edge Detail	③ Laminate Selection	③a PVC Edge Color	④ Electrical Cut Out	⑤ Metal Finish
Laminate (NST)	See Edge Detail Options	See Laminate Detail Selection	See PVC Edge Color Options	N None CO_EC23 Cut out for EC23 CO_EC24 Cut out for EC24	See Metal Finish Options

Model Number Breakdown

NST54-29SCZ					
NS	T	54	29	SC	Z
Nosh	Laminate	54"	Height	Squirrel Top Shape	X4 Base

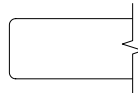
NS60 Nosh

Description

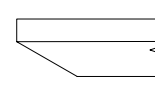
Squirrel Table with X4 Base
(continued)

Veneer Tables
"NSV" Models

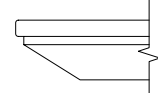
Solid Surface Tables
"NSS" Models



Eased Edge (R3)



Reverse Bevel Edge (K9)



Reverse Bevel Edge (S7)

	D	W	H	CTN WT	CU FT	① Model	Eased Edge (R3)		Reverse Bevel Edge (K9)		Standard
							Flat Cut	Double Cut	Flat Cut	Double Cut	
VEENER	60	60	29	148	46	NSV60-29SCZ	\$3,129	\$3,348	\$3,255	\$3,483	--
VEENER	54	54	29	103	26	NSV54-29SCZ	\$3,064	\$3,279	\$3,188	\$3,412	--
SOL SURF	60	60	29	196	46	NSS60-29SCZ	--	--	--	--	\$7,069
SOL SURF	54	54	29	141	46	NSS54-29SCZ	--	--	--	--	\$6,343

NOSH

To Order Specify

① Veneer Model #	② Edge Detail	③ Wood Species	④ Wood Finish	⑤ Electrical Cut Out	⑥ Metal Finish
Veneer (NSV)	See Edge Detail Options	Flat Cut	See Flat Cut Wood Finish Options	N None CO_EC23 Cut out for EC23 CO_EC24 Cut out for EC24	See Metal Finish Options
		B01 Cherry CH1 Cherry MA1 Maple WA1 Walnut			
		Double Cut	④ Wood Finish See Double Cut Wood Finish Options		
		DC2 Double Cut			

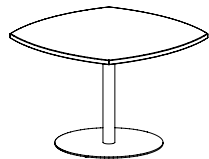
① Solid Surface Model #	② Edge Detail	③ Solid Surface	④ Electrical Cut Out	⑤ Metal Finish
Solid Surface (NSS)	See Edge Detail Options	See Solid Surface Options	N None CO_EC23 Cut out for EC23 CO_EC24 Cut out for EC24	See Metal Finish Options

Nosh - 29" h Tables

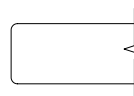


Description

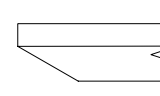
Squirrel Table with Round Disc Base



Laminate Tables "NST" Models



Eased Edge (R3)



Reverse Bevel Edge (K9)

LAMINATE	D	W	H	CTN WT	CU FT	① Model	Eased Edge (R3)			Reverse Bevel Edge (K9)		
							Standard	Graded In		Standard	Graded In	
							Tier 1	Tier 2	Tier 3	Tier 1	Tier 2	Tier 3
	42	42	29	97	17	NST42-29SCR	\$1,519	\$1,569	\$1,655	\$1,933	\$1,982	\$2,069
	36	36	29	85	14	NST36-29SCR	\$1,288	\$1,327	\$1,387	\$1,701	\$1,743	\$1,800
	30	30	29	62	12	NST30-29SCR	\$1,094	\$1,128	\$1,165	\$1,508	\$1,542	\$1,579

Features:

- price reflects complete table - top and base
- ships KD in multiple cartons
- cut out for power is not available on these tables
- base has anti-rock glides
- width of base foot varies from 17" to 27"

HSON

To Order Specify

① Laminate Model #	② Edge Detail	③ Laminate Selection	③a PVC Edge Color	④ Metal Finish
Laminate (NST)	See Edge Detail Options	See Laminate Detail Selection	See PVC Edge Color Options	See Metal Finish Options

Model Number Breakdown

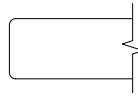
NST30-29SCR					
NS	T	30	29	SC	R
Nosh	Laminate	30"	Height	Squirrel Top Shape	Round Disc Base

NS62 Nosh

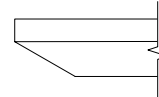
Description

Squiracle Table with Round Disc Base
(continued)

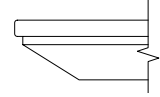
Veneer Tables "NSV" Models	Solid Surface Tables "NSS" Models
-------------------------------	--------------------------------------



Eased Edge (R3)



Reverse Bevel Edge (K9)



Reverse Bevel Edge (S7)

	D	W	H	CTN WT	CU FT	① Model	Eased Edge (R3)		Reverse Bevel Edge (K9)		Reverse Bevel Edge (S7) Standard
							Flat Cut	Double Cut	Flat Cut	Double Cut	
VENEER	42	42	29	97	17	NSV42-29SCR	\$2,028	\$2,169	\$2,110	\$2,258	--
	36	36	29	85	14	NSV36-29SCR	\$1,719	\$1,836	\$1,787	\$1,912	--
	30	30	29	62	12	NSV30-29SCR	\$1,460	\$1,562	\$1,520	\$1,625	--
SOL SURF	42	42	29	138	17	NSS42-29SCR	--	--	--	--	\$4,189
	36	36	29	71	14	NSS36-29SCR	--	--	--	--	\$3,425
	30	30	29	73	12	NSS30-29SCR	--	--	--	--	\$2,782

NOSH

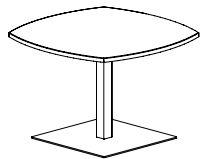
To Order Specify

① Veneer Model #	② Edge Detail	③ Wood Species	④ Wood Finish	⑤ Electrical Cut Out	⑥ Metal Finish
Veneer (NSV)	See Edge Detail Options	Flat Cut B01 Cherry CH1 Cherry MA1 Maple WA1 Walnut	See Flat Cut Wood Finish Options	N None CO_EC23 Cut out for EC23 CO_EC24 Cut out for EC24	See Metal Finish Options
		Double Cut DC2 Double Cut	④ Wood Finish See Double Cut Wood Finish Options		

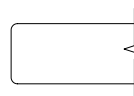
① Solid Surface Model #	② Edge Detail	③ Solid Surface	④ Electrical Cut Out	⑤ Metal Finish
Solid Surface (NSS)	See Edge Detail Options	See Solid Surface Options	N None CO_EC23 Cut out for EC23 CO_EC24 Cut out for EC24	See Metal Finish Options

Description

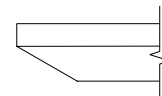
Squirrel Table with Square Disc Base



Laminate Tables "NST" Models



Eased Edge (R3)



Reverse Bevel Edge (K9)

LAMINATE	D	W	H	CTN WT	CU FT	1 Model	Eased Edge (R3)			Reverse Bevel Edge (K9)		
							Standard	Graded In		Standard	Graded In	
							Tier 1	Tier 2	Tier 3	Tier 1	Tier 2	Tier 3
	42	42	29	108	17	NST42-29SCS	\$1,721	\$1,929	\$2,047	\$2,135	\$2,343	\$2,462
	36	36	29	96	14	NST36-29SCS	\$1,426	\$1,468	\$1,529	\$1,841	\$1,881	\$1,942
	30	30	29	68	12	NST30-29SCS	\$1,234	\$1,269	\$1,302	\$1,648	\$1,683	\$1,719

Features:

- price reflects complete table - top and base
- ships KD in multiple cartons
- cut out for power is not available on these tables
- base has anti-rock glides

HSON

To Order Specify

1 Laminate Model #	2 Edge Detail	3 Laminate Selection	3a PVC Edge Color	4 Metal Finish
Laminate (NST)	See Edge Detail Options	See Laminate Detail Selection	See PVC Edge Color Options	See Metal Finish Options

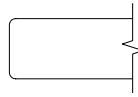
Model Number Breakdown

NST30-29SCS					
NS	T	30	29	SC	S
Nosh	Laminate	30"	Height	Squirrel Top Shape	Square Disc Base

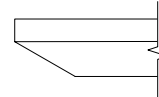
Description

Squirrel Table with Square Disc Base
(continued)

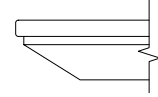
Veneer Tables "NSV" Models	Solid Surface Tables "NSS" Models
-------------------------------	--------------------------------------



Eased Edge (R3)



Reverse Bevel Edge (K9)



Reverse Bevel Edge (S7)

	D	W	H	CTN WT	CU FT	① Model	Eased Edge (R3)		Reverse Bevel Edge (K9)		Standard
							Flat Cut	Double Cut	Flat Cut	Double Cut	
VENEER	42	42	29	108	17	NSV42-29SCS	\$2,300	\$2,457	\$2,391	\$2,557	--
	36	36	29	96	14	NSV36-29SCS	\$1,905	\$2,039	\$1,984	\$2,121	--
	30	30	29	68	12	NSV30-29SCS	\$1,647	\$1,760	\$1,713	\$1,833	--
SOL SURF	42	42	29	153	17	NSS42-29SCS	--	--	--	--	\$4,458
	36	36	29	145	14	NSS36-29SCS	--	--	--	--	\$3,613
	30	30	29	139	12	NSS30-29SCS	--	--	--	--	\$2,967

NOSH

To Order Specify

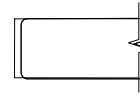
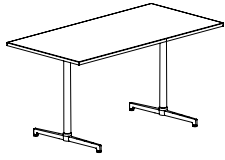
① Veneer Model #	② Edge Detail	③ Wood Species	④ Wood Finish	⑤ Electrical Cut Out	⑥ Metal Finish
Veneer (NSV)	See Edge Detail Options	Flat Cut B01 Cherry CH1 Cherry MA1 Maple WA1 Walnut	See Flat Cut Wood Finish Options	N None CO_EC23 Cut out for EC23 CO_EC24 Cut out for EC24	See Metal Finish Options
		Double Cut DC2 Double Cut	④ Wood Finish See Double Cut Wood Finish Options		

① Solid Surface Model #	② Edge Detail	③ Solid Surface	④ Electrical Cut Out	⑤ Metal Finish
Solid Surface (NSS)	See Edge Detail Options	See Solid Surface Options	N None CO_EC23 Cut out for EC23 CO_EC24 Cut out for EC24	See Metal Finish Options

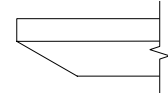
Description

Rectangular Counter Height Table with T Base

Laminate Tables "NST" Models



Eased Edge (R3)



Reverse Bevel Edge (K9)

LAMINATE	D	W	H	CTN WT	CU FT	① Model	Eased Edge (R3)			Reverse Bevel Edge (K9)		
							Standard	Graded In		Standard	Graded In	
							Tier 1	Tier 2	Tier 3	Tier 1	Tier 2	Tier 3
	36	72	36	133	55	NST3672-36TTT	\$1,772	\$1,833	\$1,970	\$2,184	\$2,245	\$2,383
	36	66	36	124	54	NST3666-36TTT	\$1,712	\$1,772	\$1,896	\$2,126	\$2,184	\$2,308
	36	60	36	116	42	NST3660-36TTT	\$1,643	\$1,698	\$1,808	\$2,056	\$2,110	\$2,221
	30	72	36	117	55	NST3072-36TTT	\$1,524	\$1,580	\$1,689	\$1,937	\$1,992	\$2,103
	30	66	36	110	35	NST3066-36TTT	\$1,465	\$1,517	\$1,618	\$1,878	\$1,930	\$2,030
	30	60	36	103	36	NST3060-36TTT	\$1,396	\$1,444	\$1,534	\$1,808	\$1,856	\$1,946

Features:

- price reflects complete table - top and base
- ships KD in multiple cartons
- top has option for cut out to receive electrical component, order separately
- optional vertical wire manager for base, order separately
- base has leveling glides
- optional vertical wire manager for base, order separately
- width of base foot is 27"

HSON

To Order Specify

① Laminate Model #	② Edge Detail	③ Laminate Selection	③a PVC Edge Color	④ Electrical Cut Out	⑤ Metal Finish
Laminate (NST)	See Edge Detail Options	See Laminate Detail Selection	See PVC Edge Color Options	N None CO_EC23 Cut out for EC23 CO_EC24 Cut out for EC24	See Metal Finish Options

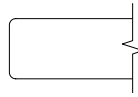
Model Number Breakdown

NST3060-36TTT					
NS	T	3060	36	TT	T
Nosh	Laminate	30" x 60"	Height	Rectangular Top Shape	T Base

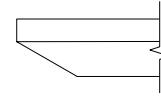
Description

Rectangular Counter Height Table with T Base
(continued)

Veneer Tables
"NSV" Models



Eased Edge (R3)



Reverse Bevel Edge (K9)

VENEER	D	W	H	CTN WT	CU FT	1 Model	Flat Cut	Double Cut	Flat Cut	Double Cut
		36	72	36	133	55	NSV3672-36TTT	\$2,046	\$2,229	\$2,205
	36	66	36	124	54	NSV3666-36TTT	\$2,005	\$2,178	\$2,159	\$2,327
	36	60	36	116	42	NSV3660-36TTT	\$1,951	\$2,109	\$2,098	\$2,253
	30	72	36	117	55	NSV3072-36TTT	\$1,933	\$2,091	\$2,081	\$2,234
	30	66	36	110	35	NSV3066-36TTT	\$1,879	\$2,028	\$2,021	\$2,163
	30	60	36	103	36	NSV3060-36TTT	\$1,833	\$1,995	\$1,968	\$2,101

NOSH

To Order Specify

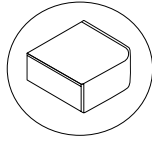
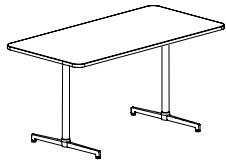
1 Veneer Model #	2 Edge Detail	3 Wood Species	4 Wood Finish	5 Electrical Cut Out	6 Metal Finish
Veneer (NSV)	See Edge Detail Options	Flat Cut B01 Cherry CH1 Cherry MA1 Maple WA1 Walnut	See Flat Cut Wood Finish Options	N None CO_EC23 Cut out for EC23 CO_EC24 Cut out for EC24	See Metal Finish Options
		Double Cut DC2 Double Cut	4 Wood Finish See Double Cut Wood Finish Options		

Nosh - 36" h Tables

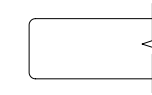


Description

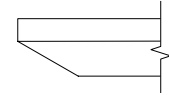
Rounded Rectangular Counter Height Table with T Base



Laminate Tables "NST" Models



Eased Edge (R3)



Reverse Bevel (K9)

LAMINATE	D	W	H	CTN WT	CU FT	① Model	Eased Edge (R3)			Reverse Bevel (K9)		
							Standard	Graded In		Standard	Graded In	
							Tier 1	Tier 2	Tier 3	Tier 1	Tier 2	Tier 3
	36	72	36	132	55	NST3672-36TTRT	\$1,860	\$1,924	\$2,060	\$2,276	\$2,339	\$2,474
	36	66	36	124	54	NST3666-36TTRT	\$1,808	\$1,869	\$1,990	\$2,221	\$2,281	\$2,403
	36	60	36	116	42	NST3660-36TTRT	\$1,745	\$1,799	\$1,908	\$2,157	\$2,213	\$2,324
	30	72	36	117	55	NST3072-36TTRT	\$1,703	\$1,757	\$1,869	\$2,116	\$2,171	\$2,281
	30	66	36	109	35	NST3066-36TTRT	\$1,642	\$1,694	\$1,794	\$2,054	\$2,107	\$2,206
	30	60	36	104	36	NST3060-36TTRT	\$1,588	\$1,637	\$1,728	\$2,001	\$2,050	\$2,140

Features:

- price reflects complete table - top and base
- ships KD in multiple cartons
- top has option for cut out to receive electrical component, order separately
- optional vertical wire manager for base, order separately
- base has leveling glides
- optional vertical wire manager for base, order separately
- width of base foot is 27"

HSON

To Order Specify

① Laminate Model #	② Edge Detail	③ Laminate Selection	③a PVC Edge Color	④ Electrical Cut Out	⑤ Metal Finish
Laminate (NST)	See Edge Detail Options	See Laminate Detail Selection	See PVC Edge Color Options	N None CO_EC23 Cut out for EC23 CO_EC24 Cut out for EC24	See Metal Finish Options

Model Number Breakdown

NST3060-36TTRT						
NS	T	3060	36	TT	R	T
Nosh	Laminate	30" x 60"	Height	Rectangular Top Shape	Rounded Corner	T Base

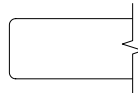
NS68 Nosh

Description

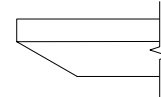
Rounded Rectangular Counter Height Table with T Base (continued)

Veneer Tables "NSV" Models

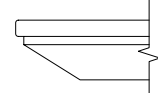
Solid Surface Tables "NSS" Models



Eased Edge (R3)



Reverse Bevel Edge (K9)



Reverse Bevel Edge (S7)

	D	W	H	CTN WT	CU FT	① Model	Eased Edge (R3)		Reverse Bevel Edge (K9)		Standard
							Flat Cut	Double Cut	Flat Cut	Double Cut	
VENEER	36	72	36	132	55	NSV3672-36TTRT	\$2,191	\$2,382	\$2,269	\$2,450	--
	36	66	36	124	54	NSV3666-36TTRT	\$2,147	\$2,327	\$2,224	\$2,390	--
	36	60	36	116	42	NSV3660-36TTRT	\$2,088	\$2,253	\$2,158	\$2,313	--
	30	72	36	117	55	NSV3072-36TTRT	\$2,061	\$2,229	\$2,132	\$2,287	--
	30	66	36	109	35	NSV3066-36TTRT	\$2,003	\$2,159	\$2,063	\$2,206	--
	30	60	36	104	36	NSV3060-36TTRT	\$1,954	\$2,097	\$2,018	\$2,151	--
SOLID SURFACE	36	72	36	132	55	NSS3672-36TTRT	--	--	--	--	\$5,135
	36	66	36	293	54	NSS3666-36TTRT	--	--	--	--	\$4,883
	36	60	36	275	42	NSS3660-36TTRT	--	--	--	--	\$4,612
	30	72	36	282	55	NSS3072-36TTRT	--	--	--	--	\$4,588
	30	66	36	272	35	NSS3066-36TTRT	--	--	--	--	\$4,356
	30	60	36	255	36	NSS3060-36TTRT	--	--	--	--	\$4,130

NOSH

To Order Specify

① Veneer Model #	② Edge Detail	③ Wood Species	④ Wood Finish	⑤ Electrical Cut Out	⑥ Metal Finish
Veneer (NSV)	See Edge Detail Options	Flat Cut B01 Cherry CH1 Cherry MA1 Maple WA1 Walnut	See Flat Cut Wood Finish Options	N None CO_EC23 Cut out for EC23 CO_EC24 Cut out for EC24	See Metal Finish Options
		Double Cut DC2 Double Cut	④ Wood Finish See Double Cut Wood Finish Options		

① Solid Surface Model #	② Edge Detail	③ Solid Surface	④ Electrical Cut Out	⑤ Metal Finish
Solid Surface (NSS)	See Edge Detail Options	See Solid Surface Options	N None CO_EC23 Cut out for EC23 CO_EC24 Cut out for EC24	See Metal Finish Options

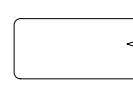
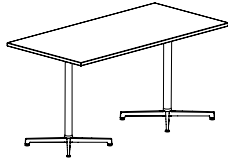
Nosh - 36" h Tables



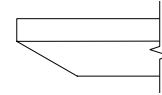
Description

Rectangular Counter Height Table with X Base

Laminate Tables "NST" Models



Eased Edge (R3)



Reverse Bevel Edge (K9)

LAMINATE	D	W	H	CTN WT	CU FT	① Model	Eased Edge (R3)			Reverse Bevel Edge (K9)		
							Standard	Graded In		Standard	Graded In	
							Tier 1	Tier 2	Tier 3	Tier 1	Tier 2	Tier 3
	36	72	36	144	45	NST3672-36TTX	\$2,279	\$2,341	\$2,477	\$2,691	\$2,753	\$2,889
	30	72	36	127	33	NST3072-36TTX	\$2,063	\$2,118	\$2,229	\$2,476	\$2,531	\$2,642

Features:

- price reflects complete table - top and base
- ships KD in multiple cartons
- base has leveling glides
- top has option for cut out to receive electrical component, enter separately
- optional vertical wire manager for base, order separately
- width of base foot varies from 26" or 32"

HSON

To Order Specify

① Laminate Model #	② Edge Detail	③ Laminate Selection	③a PVC Edge Color	④ Electrical Cut Out	⑤ Metal Finish
Laminate (NST)	See Edge Detail Options	See Laminate Detail Selection	See PVC Edge Color Options	N None CO_EC23 Cut out for EC23 CO_EC24 Cut out for EC24	See Metal Finish Options

Model Number Breakdown

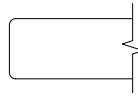
NST3672-36TTX					
NS	T	3672	36	TT	X
Nosh	Laminate	36" x 72"	Height	Rectangular Top Shape	X Base

NS70 Nosh

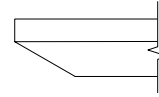
Description

Rectangular Counter Height Table with X Base
(continued)

Veneer Tables
"NSV" Models



Eased Edge (R3)



Reverse Bevel Edge (K9)

VENEER	D	W	H	CTN WT	CU FT	1 Model	Flat Cut	Double Cut	Flat Cut	Double Cut
	36	72	36	144	45	NSV3672-36TTX	\$2,554	\$2,736	\$2,713	\$2,890
30	72	36	127	33	NSV3072-36TTX	\$2,473	\$2,630	\$2,619	\$2,773	

NOSH

To Order Specify

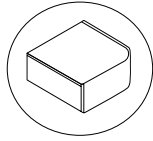
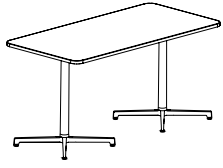
1 Veneer Model #	2 Edge Detail	3 Wood Species	4 Wood Finish	5 Electrical Cut Out	6 Metal Finish
Veneer (NSV)	See Edge Detail Options	Flat Cut B01 Cherry CH1 Cherry MA1 Maple WA1 Walnut	See Flat Cut Wood Finish Options	N None CO_EC23 Cut out for EC23 CO_EC24 Cut out for EC24	See Metal Finish Options
		Double Cut DC2 Double Cut	4 Wood Finish See Double Cut Wood Finish Options		

Nosh - 36" h Tables

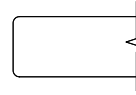


Description

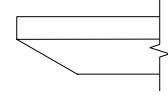
Rounded Rectangular Counter Height Table with X Base



Laminate Tables "NST" Models



Eased Edge (R3)



Reverse Bevel (K9)

LAMINATE	D	W	H	CTN WT	CU FT	① Model	Eased Edge (R3)			Reverse Bevel (K9)		
							Standard	Graded In		Standard	Graded In	
							Tier 1	Tier 2	Tier 3	Tier 1	Tier 2	Tier 3
	36	72	36	143	45	NST3672-36TTRX	\$2,368	\$2,432	\$2,566	\$2,782	\$2,845	\$2,979
	30	72	36	129	33	NST3072-36TTRX	\$2,241	\$2,299	\$2,406	\$2,653	\$2,711	\$2,820

Features:

- price reflects complete table - top and base
- ships KD in multiple cartons
- base has leveling glides
- top has option for cut out to receive electrical component, enter separately
- optional vertical wire manager for base, order separately
- width of base foot varies from 26" or 32"

HSON

To Order Specify

① Laminate Model #	② Edge Detail	③ Laminate Selection	③a PVC Edge Color	④ Electrical Cut Out	⑤ Metal Finish
Laminate (NST)	See Edge Detail Options	See Laminate Detail Selection	See PVC Edge Color Options	N None CO_EC23 Cut out for EC23 CO_EC24 Cut out for EC24	See Metal Finish Options

Model Number Breakdown

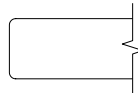
NST3072-36TTRX						
NS	T	3072	36	TT	R	X
Nosh	Laminate	30" x 72"	Height	Rectangular Top Shape	Rounded Corner	X Base

NS72 Nosh

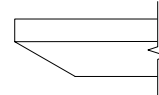
Description

Rounded Rectangular Counter Height Table
with X Base
(continued)

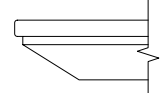
Veneer Tables "NSV" Models				Solid Surface Tables "NSS" Models	
-------------------------------	--	--	--	--------------------------------------	--



Eased Edge (R3)



Reverse Bevel Edge (K9)



Reverse Bevel Edge (S7)

	D	W	H	CTN WT	CU FT	① Model	Eased Edge (R3)		Reverse Bevel Edge (K9)		Standard
							Flat Cut	Double Cut	Flat Cut	Double Cut	
VENEER	36	72	36	143	45	NSV3672-36TTRX	\$2,729	\$2,921	\$2,808	\$2,988	--
	30	72	36	129	33	NSV3072-36TTRX	\$2,568	\$2,736	\$2,640	\$2,794	--
SOL SURF	36	72	36	177	45	NSS3672-36TTRX	--	--	--	--	\$5,672
	30	72	36	152	33	NSS3072-36TTRX	--	--	--	--	\$5,095

NOSH

To Order Specify

① Veneer Model #	② Edge Detail	③ Wood Species	④ Wood Finish	⑤ Electrical Cut Out	⑥ Metal Finish
Veneer (NSV)	See Edge Detail Options	Flat Cut B01 Cherry CH1 Cherry MA1 Maple WA1 Walnut	See Flat Cut Wood Finish Options	N None CO_EC23 Cut out for EC23 CO_EC24 Cut out for EC24	See Metal Finish Options
		Double Cut DC2 Double Cut	④ Wood Finish See Double Cut Wood Finish Options		

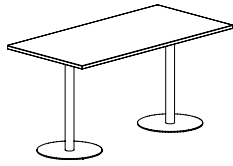
① Solid Surface Model #	② Edge Detail	③ Solid Surface	④ Electrical Cut Out	⑤ Metal Finish
Solid Surface (NSS)	See Edge Detail Options	See Solid Surface Options	N None CO_EC23 Cut out for EC23 CO_EC24 Cut out for EC24	See Metal Finish Options

Nosh - 36" h Tables

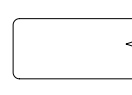


Description

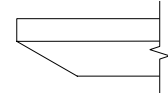
Rectangular Counter Height Table with Round Disc Base



Laminate Tables "NST" Models



Eased Edge (R3)



Reverse Bevel Edge (K9)

LAMINATE	D	W	H	CTN WT	CU FT	① Model	Eased Edge (R3)			Reverse Bevel Edge (K9)		
							Standard	Graded In		Standard	Graded In	
							Tier 1	Tier 2	Tier 3	Tier 1	Tier 2	Tier 3
	36	72	36	219	55	NST3672-36TTR	\$2,585	\$2,647	\$2,770	\$2,998	\$3,059	\$3,182
	36	66	36	210	54	NST3666-36TTR	\$2,439	\$2,511	\$2,623	\$2,853	\$2,924	\$3,036
	36	60	36	202	42	NST3660-36TTR	\$2,350	\$2,418	\$2,516	\$2,762	\$2,833	\$2,929
	30	72	36	169	55	NST3072-36TTR	\$2,352	\$2,419	\$2,518	\$2,764	\$2,834	\$2,930
	30	66	36	162	41	NST3066-36TTR	\$2,141	\$2,205	\$2,292	\$2,554	\$2,619	\$2,705
	30	60	36	155	36	NST3060-36TTR	\$2,071	\$2,132	\$2,209	\$2,483	\$2,545	\$2,623

Features:

- price reflects complete table - top and base
- ships KD in multiple cartons
- top has option for cutout to receive electrical component, ordered separately
- optional vertical wire manager for base, order separately
- base has anti-rock glides
- width of base foot varies from 17" or 22"

HSON

To Order Specify

① Laminate Model #	② Edge Detail	③ Laminate Selection	③a PVC Edge Color	④ Electrical Cut Out	⑤ Metal Finish
Laminate (NST)	See Edge Detail Options	See Laminate Detail Selection	See PVC Edge Color Options	N None CO_EC23 Cut out for EC23 CO_EC24 Cut out for EC24	See Metal Finish Options

Model Number Breakdown

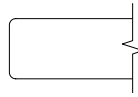
NST3672-36TTR					
NS	T	3672	36	TT	R
Nosh	Laminate	36" x 72"	Height	Rectangular Top Shape	Round Disc Base

NS74 Nosh

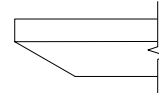
Description

Rectangular Counter Height Table
with Round Disc Base
(continued)

Veneer Tables
"NSV" Models



Eased Edge (R3)



Reverse Bevel Edge (K9)

VENEER	D	W	H	CTN WT	CU FT	1 Model	Flat Cut	Double Cut	Flat Cut	Double Cut
		36	72	36	219	55	NSV3672-36TTR	\$2,928	\$3,051	\$2,989
	36	66	36	210	54	NSV3666-36TTR	\$2,836	\$2,947	\$2,905	\$3,007
	36	60	36	202	42	NSV3660-36TTR	\$2,749	\$2,848	\$2,815	\$2,903
	30	72	36	169	55	NSV3072-36TTR	\$2,719	\$2,898	\$2,783	\$2,950
	30	66	36	162	41	NSV3066-36TTR	\$2,511	\$2,627	\$2,569	\$2,675
	30	60	36	155	36	NSV3060-36TTR	\$2,443	\$2,549	\$2,499	\$2,594

NOSH

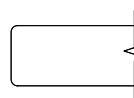
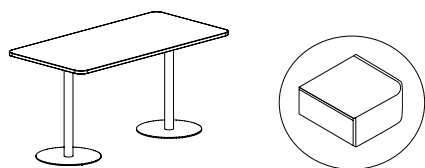
To Order Specify

1 Veneer Model #	2 Edge Detail	3 Wood Species	4 Wood Finish	5 Electrical Cut Out	6 Metal Finish
Veneer (NSV)	See Edge Detail Options	Flat Cut B01 Cherry CH1 Cherry MA1 Maple WA1 Walnut	See Flat Cut Wood Finish Options	N None CO_EC23 Cut out for EC23 CO_EC24 Cut out for EC24	See Metal Finish Options
		Double Cut DC2 Double Cut	4 Wood Finish See Double Cut Wood Finish Options		

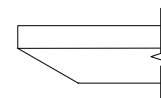
Description

Rounded Rectangular Counter Height Table with Round Disc Base

Laminate Tables "NST" Models



Eased Edge (R3)



Reverse Bevel (K9)

LAMINATE	D	W	H	CTN WT	CU FT	① Model	Eased Edge (R3)			Reverse Bevel (K9)		
							Standard	Graded In		Standard	Graded In	
							Tier 1	Tier 2	Tier 3	Tier 1	Tier 2	Tier 3
	36	72	36	196	55	NST3672-36TTRR	\$2,812	\$2,892	\$3,011	\$3,225	\$3,306	\$3,424
	36	66	36	188	54	NST3666-36TTRR	\$2,469	\$2,539	\$2,650	\$2,882	\$2,951	\$3,062
	36	60	36	180	42	NST3660-36TTRR	\$2,405	\$2,474	\$2,594	\$2,817	\$2,886	\$3,008
	30	72	36	157	55	NST3072-36TTRR	\$2,443	\$2,512	\$2,607	\$2,857	\$2,926	\$3,022
	30	66	36	150	41	NST3066-36TTRR	\$2,383	\$2,449	\$2,535	\$2,796	\$2,861	\$2,947
	30	60	36	143	36	NST3060-36TTRR	\$2,329	\$2,391	\$2,469	\$2,741	\$2,804	\$2,882

Features:

- price reflects complete table - top and base
- ships KD in multiple cartons
- top has option for cutout to receive electrical component, ordered separately
- optional vertical wire manager for base, order separately
- base has anti-rock glides
- width of base foot varies from 17" or 22"

HSOON

To Order Specify

① Laminate Model #	② Edge Detail	③ Laminate Selection	③a PVC Edge Color	④ Electrical Cut Out	⑤ Metal Finish
Laminate (NST)	See Edge Detail Options	See Laminate Detail Selection	See PVC Edge Color Options	N None CO_EC23 Cut out for EC23 CO_EC24 Cut out for EC24	See Metal Finish Options

Model Number Breakdown

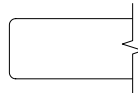
NST3060-36TTRR						
NS	T	3060	36	TT	R	R
Nosh	Laminate	30" x 60"	Height	Rectangular Top Shape	Rounded Corner	Round Disc Base

Description

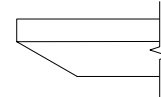
Rounded Rectangular Counter Height Table
with Round Disc Base
(continued)

Veneer Tables
"NSV" Models

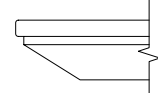
Solid Surface Tables
"NSS" Models



Eased Edge (R3)



Reverse Bevel Edge (K9)



Reverse Bevel Edge (S7)

	D	W	H	CTN WT	CU FT	① Model	Veneer Tables "NSV" Models		Solid Surface Tables "NSS" Models		
							Flat Cut	Double Cut	Flat Cut	Double Cut	Standard
VENEER	36	72	36	196	55	NSV3672-36TTRR	\$3,155	\$3,277	\$3,226	\$3,338	--
	36	66	36	188	54	NSV3666-36TTRR	\$2,855	\$2,966	\$2,922	\$3,024	--
	36	60	36	180	42	NSV3660-36TTRR	\$2,798	\$2,898	\$2,860	\$2,950	--
	30	72	36	157	55	NSV3072-36TTRR	\$2,801	\$2,928	\$2,873	\$2,985	--
	30	66	36	150	41	NSV3066-36TTRR	\$2,743	\$2,860	\$2,802	\$2,907	--
	30	60	36	143	36	NSV3060-36TTRR	\$2,694	\$2,799	\$2,758	\$2,850	--
SOLID SURFACE	36	72	36	229	55	NSS3672-36TTRR	--	--	--	--	\$6,099
	36	66	36	218	54	NSS3666-36TTRR	--	--	--	--	\$5,590
	36	60	36	207	42	NSS3660-36TTRR	--	--	--	--	\$5,322
	30	72	36	183	55	NSS3072-36TTRR	--	--	--	--	\$5,328
	30	66	36	174	41	NSS3066-36TTRR	--	--	--	--	\$5,096
	30	60	36	165	36	NSS3060-36TTRR	--	--	--	--	\$4,871

NOSH

To Order Specify

① Veneer Model #	② Edge Detail	③ Wood Species	④ Wood Finish	⑤ Electrical Cut Out	⑥ Metal Finish
Veneer (NSV)	See Edge Detail Options	Flat Cut B01 Cherry CH1 Cherry MA1 Maple WA1 Walnut Double Cut DC2 Double Cut	See Flat Cut Wood Finish Options ④ Wood Finish See Double Cut Wood Finish Options	N None CO_EC23 Cut out for EC23 CO_EC24 Cut out for EC24	See Metal Finish Options

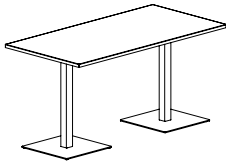
① Solid Surface Model #	② Edge Detail	③ Solid Surface	④ Electrical Cut Out	⑤ Metal Finish
Solid Surface (NSS)	See Edge Detail Options	See Solid Surface Options	N None CO_EC23 Cut out for EC23 CO_EC24 Cut out for EC24	See Metal Finish Options

Nosh - 36" h Tables

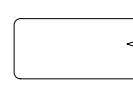


Description

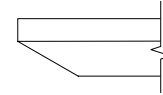
Rectangular Counter Height Table with Square Disc Base



Laminate Tables "NST" Models



Eased Edge (R3)



Reverse Bevel Edge (K9)

LAMINATE	D	W	H	CTN WT	CU FT	① Model	Eased Edge (R3)			Reverse Bevel Edge (K9)		
							Standard	Graded In		Standard	Graded In	
							Tier 1	Tier 2	Tier 3	Tier 1	Tier 2	Tier 3
	36	72	36	215	55	NST3672-36TTS	\$2,863	\$2,927	\$3,049	\$3,276	\$3,339	\$3,461
	36	66	36	207	54	NST3666-36TTS	\$2,719	\$2,791	\$2,902	\$3,133	\$3,203	\$3,314
	36	60	36	198	42	NST3660-36TTS	\$2,629	\$2,697	\$2,796	\$3,041	\$3,110	\$3,208
	30	72	36	169	55	NST3072-36TTS	\$2,631	\$2,698	\$2,797	\$3,044	\$3,111	\$3,209
	30	66	36	162	41	NST3066-36TTS	\$2,421	\$2,485	\$2,574	\$2,835	\$2,898	\$2,986
	30	60	36	155	36	NST3060-36TTS	\$2,351	\$2,411	\$2,489	\$2,763	\$2,824	\$2,902

Features:

- price reflects complete table - top and base
- ships KD in multiple cartons
- base has anti-rock glides
- top has option for cut out to receive electrical component, enter separately
- optional vertical wire manager for base, order separately
- width of base foot varies from 17" or 22"

HSOON

To Order Specify

① Laminate Model #	② Edge Detail	③ Laminate Selection	③a PVC Edge Color	④ Electrical Cut Out	⑤ Metal Finish
Laminate (NST)	See Edge Detail Options	See Laminate Detail Selection	See PVC Edge Color Options	N None CO_EC23 Cut out for EC23 CO_EC24 Cut out for EC24	See Metal Finish Options

Model Number Breakdown

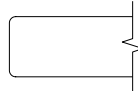
NSV3672-36TTS					
NS	V	3672	36	TT	S
Nosh	Veneer	36" x 72"	Height	Rectangular Top Shape	Square Disc Base

NS78 Nosh

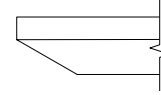
Description

Rectangular Counter Height Table
with Square Disc Base
(continued)

Veneer Tables
"NSV" Models



Eased Edge (R3)



Reverse Bevel Edge (K9)

VENEER	D	W	H	CTN WT	CU FT	1 Model	Flat Cut	Double Cut	Flat Cut	Double Cut
		36	72	36	215	55	NSV3672-36TTS	\$3,207	\$3,331	\$3,269
	36	66	36	207	54	NSV3666-36TTS	\$3,113	\$3,227	\$3,185	\$3,286
	36	60	36	198	42	NSV3660-36TTS	\$3,028	\$3,128	\$3,096	\$3,183
	30	72	36	169	55	NSV3072-36TTS	\$2,999	\$3,178	\$3,061	\$3,230
	30	66	36	162	41	NSV3066-36TTS	\$2,791	\$2,905	\$2,848	\$2,954
	30	60	36	155	36	NSV3060-36TTS	\$2,723	\$2,828	\$2,778	\$2,875

NOSH

To Order Specify

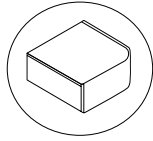
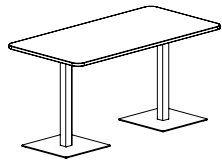
1 Veneer Model #	2 Edge Detail	3 Wood Species	4 Wood Finish	5 Electrical Cut Out	6 Metal Finish
Veneer (NSV)	See Edge Detail Options	Flat Cut B01 Cherry CH1 Cherry MA1 Maple WA1 Walnut	See Flat Cut Wood Finish Options	N None CO_EC23 Cut out for EC23 CO_EC24 Cut out for EC24	See Metal Finish Options
		Double Cut DC2 Double Cut	4 Wood Finish See Double Cut Wood Finish Options		

Nosh - 36" h Tables

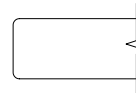


Description

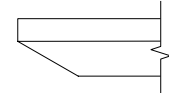
Rounded Rectangular Counter Height
Table with Square Disc Base



Laminate Tables "NST" Models



Eased Edge (R3)



Reverse Bevel (K9)

LAMINATE	D	W	H	CTN WT	CU FT	① Model	Eased Edge (R3)			Reverse Bevel (K9)		
							Standard	Graded In		Standard	Graded In	
							Tier 1	Tier 2	Tier 3	Tier 1	Tier 2	Tier 3
	36	72	36	215	55	NST3672-36TTRS	\$3,091	\$3,174	\$3,292	\$3,505	\$3,586	\$3,704
	36	66	36	207	54	NST3666-36TTRS	\$2,747	\$2,817	\$2,930	\$3,160	\$3,231	\$3,343
	36	60	36	198	42	NST3660-36TTRS	\$2,686	\$2,752	\$2,875	\$3,098	\$3,164	\$3,288
	30	72	36	169	55	NST3072-36TTRS	\$2,723	\$2,792	\$2,888	\$3,136	\$3,205	\$3,300
	30	66	36	162	41	NST3066-36TTRS	\$2,662	\$2,728	\$2,814	\$3,075	\$3,140	\$3,227
	30	60	36	155	36	NST3060-36TTRS	\$2,607	\$2,672	\$2,747	\$3,022	\$3,084	\$3,160

Features:

- price reflects complete table - top and base
- ships KD in multiple cartons
- base has anti-rock glides
- top has option for cut out to receive electrical component, enter separately
- optional vertical wire manager for base, order separately
- width of base foot varies from 17" or 22"

HSON

To Order Specify

① Laminate Model #	② Edge Detail	③ Laminate Selection	③a PVC Edge Color	④ Electrical Cut Out	⑤ Metal Finish
Laminate (NST)	See Edge Detail Options	See Laminate Detail Selection	See PVC Edge Color Options	N None CO_EC23 Cut out for EC23 CO_EC24 Cut out for EC24	See Metal Finish Options

Model Number Breakdown

NST3060-36TTRS						
NS	T	3060	36	TT	R	S
Nosh	Laminate	30" x 60"	Height	Rectangular Top Shape	Rounded Corner	Square Disc Base

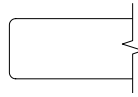
NS80 Nosh

Description

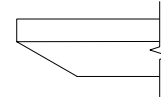
Rounded Rectangular Counter Height Table
with Square Disc Base
(continued)

Veneer Tables
"NSV" Models

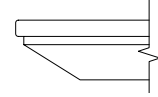
Solid Surface Tables
"NSS" Models



Eased Edge (R3)



Reverse Bevel Edge (K9)



Reverse Bevel Edge (S7)

	D	W	H	CTN WT	CU FT	① Model	Veneer Tables "NSV" Models		Solid Surface Tables "NSS" Models		
							Flat Cut	Double Cut	Flat Cut	Double Cut	Standard
VENEER	36	72	36	215	55	NSV3672-36TTRS	\$3,435	\$3,557	\$3,506	\$3,617	--
	36	66	36	207	54	NSV3666-36TTRS	\$3,135	\$3,247	\$3,201	\$3,301	--
	36	60	36	198	42	NSV3660-36TTRS	\$3,078	\$3,178	\$3,139	\$3,230	--
	30	72	36	169	55	NSV3072-36TTRS	\$3,082	\$3,207	\$3,152	\$3,264	--
	30	66	36	162	41	NSV3066-36TTRS	\$3,025	\$3,139	\$3,083	\$3,186	--
	30	60	36	155	36	NSV3060-36TTRS	\$2,975	\$3,079	\$3,037	\$3,132	--
SOLID SURFACE	36	72	36	252	55	NSS3672-36TTRS	--	--	--	--	\$6,378
	36	66	36	240	54	NSS3666-36TTRS	--	--	--	--	\$5,868
	36	60	36	229	42	NSS3660-36TTRS	--	--	--	--	\$5,602
	30	72	36	194	55	NSS3072-36TTRS	--	--	--	--	\$5,608
	30	66	36	185	41	NSS3066-36TTRS	--	--	--	--	\$5,375
	30	60	36	176	36	NSS3060-36TTRS	--	--	--	--	\$5,151

NOSH

To Order Specify

① Veneer Model #	② Edge Detail	③ Wood Species	④ Wood Finish	⑤ Electrical Cut Out	⑥ Metal Finish
Veneer (NSV)	See Edge Detail Options	Flat Cut B01 Cherry CH1 Cherry MA1 Maple WA1 Walnut	See Flat Cut Wood Finish Options	N None CO_EC23 Cut out for EC23 CO_EC24 Cut out for EC24	See Metal Finish Options
		Double Cut DC2 Double Cut	④ Wood Finish See Double Cut Wood Finish Options		

① Solid Surface Model #	② Edge Detail	③ Solid Surface	④ Electrical Cut Out	⑤ Metal Finish
Solid Surface (NSS)	See Edge Detail Options	See Solid Surface Options	N None CO_EC23 Cut out for EC23 CO_EC24 Cut out for EC24	See Metal Finish Options

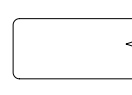
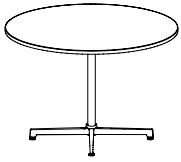
Nosh - 36" h Tables



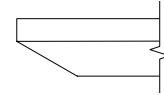
Description

Round Counter Height Table with X Base

Laminate Tables "NST" Models



Eased Edge (R3)



Reverse Bevel Edge (K9)

LAMINATE	D	W	H	CTN WT	CU FT	1 Model	Eased Edge (R3)			Reverse Bevel Edge (K9)		
							Standard	Graded In		Standard	Graded In	
							Tier 1	Tier 2	Tier 3	Tier 1	Tier 2	Tier 3
	48	N/A	36	88	25	NST48-36RDX	\$1,527	\$1,634	\$1,753	\$1,940	\$2,046	\$2,167
	42	N/A	36	74	21	NST42-36RDX	\$1,402	\$1,509	\$1,597	\$1,817	\$1,922	\$2,009
	36	N/A	36	60	18	NST36-36RDX	\$1,362	\$1,400	\$1,463	\$1,774	\$1,812	\$1,876
	30	N/A	36	48	16	NST30-36RDX	\$1,315	\$1,345	\$1,383	\$1,728	\$1,757	\$1,795

Features:

- price reflects complete table - top and base
- ships KD in multiple cartons
- top has option for cutout to receive electrical component, ordered separately
- when electrical cut out selected, power accessible base is sent - add \$111
- optional vertical wire manager for base, order separately
- base has leveling glides
- width of base foot varies from 26" or 32"

HSON

To Order Specify

1 Laminate Model #	2 Edge Detail	3 Laminate Selection	3a PVC Edge Color	4 Electrical Cut Out	5 Metal Finish
Laminate (NST)	See Edge Detail Options	See Laminate Detail Selection	See PVC Edge Color Options	N None COB_EC23 Cut out for EC23 COB_EC24 Cut out for EC24	See Metal Finish Options

Model Number Breakdown

NST30-36RDX					
NS	T	30	36	RD	X
Nosh	Laminate	30" Diameter	Height	Round Top Shape	X base

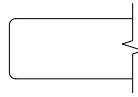
NS82 Nosh

Description

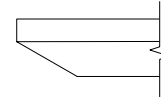
Round Counter Height Table with X Base
(continued)

Veneer Tables
"NSV" Models

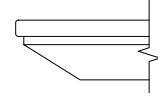
Solid Surface Tables
"NSS" Models



Eased Edge (R3)



Reverse Bevel Edge (K9)



Reverse Bevel Edge (S7)

	D	W	H	CTN WT	CU FT	① Model	Eased Edge (R3)		Reverse Bevel Edge (K9)		Reverse Bevel Edge (S7)
							Flat Cut	Double Cut	Flat Cut	Double Cut	
VENEER	48	N/A	36	88	25	NSV48-36RDX	\$2,009	\$2,143	\$2,087	\$2,227	--
	42	N/A	36	74	21	NSV42-36RDX	\$1,845	\$1,967	\$1,916	\$2,042	--
	36	N/A	36	60	18	NSV36-36RDX	\$1,788	\$1,906	\$1,857	\$1,981	--
	30	N/A	36	48	16	NSV30-36RDX	\$1,726	\$1,840	\$1,792	\$1,908	--
SOLID SURFACE	48	N/A	36	118	25	NSS48-36RDX	--	--	--	--	\$4,678
	42	N/A	36	96	21	NSS42-36RDX	--	--	--	--	\$3,990
	36	N/A	36	76	18	NSS36-36RDX	--	--	--	--	\$3,479
	30	N/A	36	59	16	NSS30-36RDX	--	--	--	--	\$3,029

NSH

To Order Specify

① Veneer Model #	② Edge Detail	③ Wood Species	④ Wood Finish	⑤ Electrical Cut Out	⑥ Metal Finish
Veneer (NSV)	See Edge Detail Options	Flat Cut B01 Cherry CH1 Cherry MA1 Maple WA1 Walnut	See Flat Cut Wood Finish Options	N None CO_EC23 Cut out for EC23 CO_EC24 Cut out for EC24	See Metal Finish Options
		Double Cut DC2 Double Cut	④ Wood Finish See Double Cut Wood Finish Options		

① Solid Surface Model #	② Edge Detail	③ Solid Surface	④ Electrical Cut Out	⑤ Metal Finish
Solid Surface (NSS)	See Edge Detail Options	See Solid Surface Options	N None CO_EC23 Cut out for EC23 CO_EC24 Cut out for EC24	See Metal Finish Options

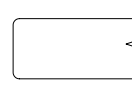
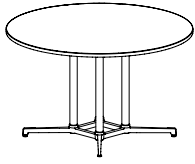
Nosh - 36" h Tables



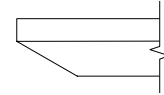
Description

Round Counter Height Table with X4 Base

Laminate Tables "NST" Models



Eased Edge (R3)



Reverse Bevel Edge (K9)

LAMINATE	D	W	H	CTN WT	CU FT	1 Model	Eased Edge (R3)			Reverse Bevel Edge (K9)		
							Standard	Graded In		Standard	Graded In	
							Tier 1	Tier 2	Tier 3	Tier 1	Tier 2	Tier 3
	60	N/A	36	154	48	NST60-36RDZ	\$2,544	\$2,629	\$2,817	\$2,957	\$3,041	\$3,231
	54	N/A	36	105	26	NST54-36RDZ	\$2,376	\$2,442	\$2,506	\$2,790	\$2,855	\$2,921

Features:

- price reflects complete table - top and base
- ships KD in multiple cartons
- base has leveling glides
- top has option for cut out to receive electrical component, enter separately
- optional vertical wire manager for base, order separately
- width of base foot is 38"

HSON

To Order Specify

1 Laminate Model #	2 Edge Detail	3 Laminate Selection	3a PVC Edge Color	4 Electrical Cut Out	5 Metal Finish
Laminate (NST)	See Edge Detail Options	See Laminate Detail Selection	See PVC Edge Color Options	N None CO_EC23 Cut out for EC23 CO_EC24 Cut out for EC24	See Metal Finish Options

Model Number Breakdown

NST54-36RDZ					
NS	T	54	36	RD	Z
Nosh	Laminate	54" Diameter	Height	Round Top Shape	X4 Base

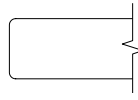
NS84 Nosh

Description

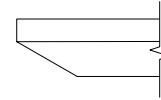
Round Counter Height Table with X4 Base
(continued)

Veneer Tables
"NSV" Models

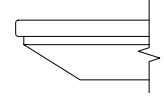
Solid Surface Tables
"NSS" Models



Eased Edge (R3)



Reverse Bevel Edge (K9)



Reverse Bevel Edge (S7)

	D	W	H	CTN WT	CU FT	① Model	Eased Edge (R3)		Reverse Bevel Edge (K9)		Standard
							Flat Cut	Double Cut	Flat Cut	Double Cut	
VENEER	60	N/A	36	154	48	NSV60-36RDZ	\$3,333	\$3,550	\$3,458	\$3,684	--
	54	N/A	36	105	26	NSV54-36RDZ	\$3,148	\$3,361	\$3,270	\$3,493	--
SOL SURF	60	N/A	36	202	48	NSS60-36RDZ	--	--	--	--	\$7,256
	54	N/A	36	146	23	NSS54-36RDZ	--	--	--	--	\$6,411

NOSH

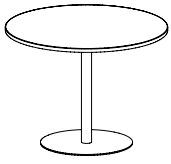
To Order Specify

① Veneer Model #	② Edge Detail	③ Wood Species	④ Wood Finish	⑤ Electrical Cut Out	⑥ Metal Finish
Veneer (NSV)	See Edge Detail Options	Flat Cut B01 Cherry CH1 Cherry MA1 Maple WA1 Walnut	See Flat Cut Wood Finish Options	N None CO_EC23 Cut out for EC23 CO_EC24 Cut out for EC24	See Metal Finish Options
		Double Cut DC2 Double Cut	④ Wood Finish See Double Cut Wood Finish Options		

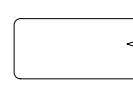
① Solid Surface Model #	② Edge Detail	③ Solid Surface	④ Electrical Cut Out	⑤ Metal Finish
Solid Surface (NSS)	See Edge Detail Options	See Solid Surface Options	N None CO_EC23 Cut out for EC23 CO_EC24 Cut out for EC24	See Metal Finish Options

Description

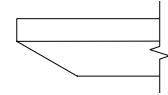
Round Counter Height Table
with Round Disc Base



Laminate Tables "NST" Models



Eased Edge (R3)



Reverse Bevel Edge (K9)

LAMINATE	D	W	H	CTN WT	CU FT	① Model	Eased Edge (R3)			Reverse Bevel Edge (K9)		
							Standard	Graded In		Standard	Graded In	
							Tier 1	Tier 2	Tier 3	Tier 1	Tier 2	Tier 3
	48	N/A	36	132	25	NST48-36RDR	\$1,752	\$1,809	\$1,929	\$2,165	\$2,222	\$2,342
	42	N/A	36	117	20	NST42-36RDR	\$1,601	\$1,650	\$1,736	\$2,015	\$2,064	\$2,150
	36	N/A	36	86	17	NST36-36RDR	\$1,371	\$1,412	\$1,471	\$1,784	\$1,825	\$1,883
	30	N/A	36	64	15	NST30-36RDR	\$1,177	\$1,213	\$1,248	\$1,591	\$1,625	\$1,660

Features:

- price reflects complete table - top and base
- ships KD in multiple cartons
- base has anti-rock glides
- cut out for power is not available on these tables
- width of base foot varies from 22" or 27"

HSON

To Order Specify

① Laminate Model #	② Edge Detail	③ Laminate Selection	③a PVC Edge Color	④ Metal Finish
Laminate (NST)	See Edge Detail Options	See Laminate Detail Selection	See PVC Edge Color Options	See Metal Finish Options

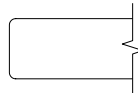
Model Number Breakdown

NST30-36RDR					
NS	T	30	36	RD	R
Nosh	Laminate	30" Diameter	Height	Round Top Shape	R Disc Base

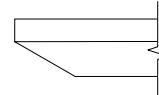
Description

Round Counter Height Table
with Round Disc Base
(continued)

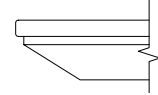
Veneer Tables "NSV" Models				Solid Surface Tables "NSS" Models	
-------------------------------	--	--	--	--------------------------------------	--



Eased Edge (R3)



Reverse Bevel Edge (K9)



Reverse Bevel Edge (S7)

	D	W	H	CTN WT	CU FT	① Model	Eased Edge (R3)		Reverse Bevel Edge (K9)		Reverse Bevel Edge (S7) Standard
							Flat Cut	Double Cut	Flat Cut	Double Cut	
VENEER	48	N/A	36	132	25	NSV48-36RDR	\$2,312	\$2,469	\$2,401	\$2,563	--
	42	N/A	36	117	20	NSV42-36RDR	\$2,110	\$2,251	\$2,192	\$2,340	--
	36	N/A	36	86	17	NSV36-36RDR	\$1,800	\$1,921	\$1,871	\$1,995	--
	30	N/A	36	64	15	NSV30-36RDR	\$1,543	\$1,646	\$1,602	\$1,707	--
SOLID SURFACE	48	N/A	36	162	25	NSS48-36RDR	--	--	--	--	\$4,981
	42	N/A	36	140	20	NSS42-36RDR	--	--	--	--	\$4,254
	36	N/A	36	103	17	NSS36-36RDR	--	--	--	--	\$3,492
	30	N/A	36	75	15	NSS30-36RDR	--	--	--	--	\$2,847

NOSH

To Order Specify

① Veneer Model #	② Edge Detail	③ Wood Species	④ Wood Finish	⑤ Electrical Cut Out	⑥ Metal Finish
Veneer (NSV)	See Edge Detail Options	Flat Cut B01 Cherry CH1 Cherry MA1 Maple WA1 Walnut	See Flat Cut Wood Finish Options	N None CO_EC23 Cut out for EC23 CO_EC24 Cut out for EC24	See Metal Finish Options
		Double Cut DC2 Double Cut	④ Wood Finish See Double Cut Wood Finish Options		

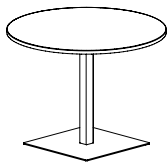
① Solid Surface Model #	② Edge Detail	③ Solid Surface	④ Electrical Cut Out	⑤ Metal Finish
Solid Surface (NSS)	See Edge Detail Options	See Solid Surface Options	N None CO_EC23 Cut out for EC23 CO_EC24 Cut out for EC24	See Metal Finish Options

Nosh - 36" h Tables

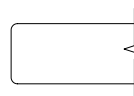


Description

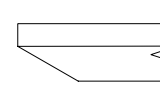
Round Counter Height Table with Square Disc Base



Laminate Tables "NST" Models



Eased Edge (R3)



Reverse Bevel Edge (K9)

LAMINATE	D	W	H	CTN WT	CU FT	① Model	Eased Edge (R3)			Reverse Bevel Edge (K9)		
							Standard	Graded In		Standard	Graded In	
							Tier 1	Tier 2	Tier 3	Tier 1	Tier 2	Tier 3
	48	N/A	36	147	25	NST48-36RDS	\$1,954	\$2,011	\$2,131	\$2,367	\$2,426	\$2,544
	42	N/A	36	132	20	NST42-36RDS	\$1,803	\$1,853	\$1,940	\$2,217	\$2,265	\$2,352
	36	N/A	36	98	17	NST36-36RDS	\$1,510	\$1,551	\$1,611	\$1,923	\$1,965	\$2,024
	30	N/A	36	69	15	NST30-36RDS	\$1,319	\$1,350	\$1,387	\$1,731	\$1,766	\$1,799

Features:

- price reflects complete table - top and base
- ships KD in multiple cartons
- top has option for cut out to receive electrical component, order separately
- optional vertical wire manage for base, order separately
- width of base foot varies from 17" to 27"
- base has anti-rock glides

HSON

To Order Specify

① Laminate Model #	② Edge Detail	③ Laminate Selection	③a PVC Edge Color	④ Metal Finish
Laminate (NST)	See Edge Detail Options	See Laminate Detail Selection	See PVC Edge Color Options	See Metal Finish Options

Model Number Breakdown

NST30-36RDS					
NS	T	30	36	RD	S
Nosh	Laminate	30" Diameter	Height	Round Top Shape	Square Disc Base

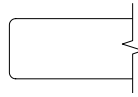
NS88 Nosh

Description

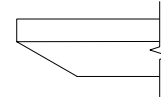
Round Counter Height Table
with Square Disc Base
(continued)

Veneer Tables
"NSV" Models

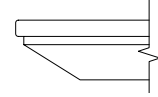
Solid Surface Tables
"NSS" Models



Eased Edge (R3)



Reverse Bevel Edge (K9)



Reverse Bevel Edge (S7)

	D	W	H	CTN WT	CU FT	① Model	Eased Edge (R3)		Reverse Bevel Edge (K9)		Reverse Bevel Edge (S7) Standard
							Flat Cut	Double Cut	Flat Cut	Double Cut	
VENEER	48	N/A	36	147	25	NSV48-36RDS	\$2,585	\$2,759	\$2,686	\$2,865	--
	42	N/A	36	132	20	NSV42-36RDS	\$2,382	\$2,541	\$2,474	\$2,640	--
	36	N/A	36	98	17	NSV36-36RDS	\$1,990	\$2,121	\$2,067	\$2,204	--
	30	N/A	36	69	15	NSV30-36RDS	\$1,731	\$1,845	\$1,796	\$1,917	--
SOLID SURFACE	48	N/A	36	177	25	NSS48-36RDS	--	--	--	--	\$5,254
	42	N/A	36	155	20	NSS42-36RDS	--	--	--	--	\$4,525
	36	N/A	36	103	17	NSS36-36RDS	--	--	--	--	\$3,680
	30	N/A	36	80	15	NSS30-36RDS	--	--	--	--	\$3,034

NOSH

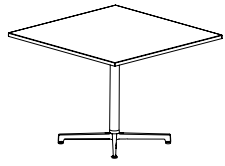
To Order Specify

① Veneer Model #	② Edge Detail	③ Wood Species	④ Wood Finish	⑤ Electrical Cut Out	⑥ Metal Finish
Veneer (NSV)	See Edge Detail Options	Flat Cut B01 Cherry CH1 Cherry MA1 Maple WA1 Walnut	See Flat Cut Wood Finish Options	N None CO_EC23 Cut out for EC23 CO_EC24 Cut out for EC24	See Metal Finish Options
		Double Cut DC2 Double Cut	④ Wood Finish See Double Cut Wood Finish Options		

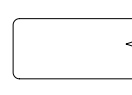
① Solid Surface Model #	② Edge Detail	③ Solid Surface	④ Electrical Cut Out	⑤ Metal Finish
Solid Surface (NSS)	See Edge Detail Options	See Solid Surface Options	N None CO_EC23 Cut out for EC23 CO_EC24 Cut out for EC24	See Metal Finish Options

Description

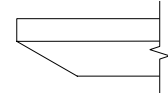
Square Counter Height Table with X Base



Laminate Tables "NST" Models



Eased Edge (R3)



Reverse Bevel Edge (K9)

LAMINATE	D	W	H	CTN WT	CU FT	① Model	Eased Edge (R3)			Reverse Bevel Edge (K9)		
							Standard	Graded In		Standard	Graded In	
							Tier 1	Tier 2	Tier 3	Tier 1	Tier 2	Tier 3
	42	42	36	87	21	NST4242-36SQX	\$1,437	\$1,485	\$1,598	\$1,850	\$1,897	\$2,011
	36	36	36	55	18	NST3636-36SQX	\$1,278	\$1,318	\$1,343	\$1,691	\$1,730	\$1,755
	30	30	36	55	16	NST3030-36SQX	\$1,150	\$1,182	\$1,196	\$1,563	\$1,594	\$1,608

Features:

- price reflects complete table - top and base
- ships KD in multiple cartons
- top has option for cutout to receive electrical component, ordered separately
- when electrical cut out selected, power accessible base is sent - add \$111
- optional vertical wire manager for base, order separately
- base has leveling glides
- width of base foot varies from 26" to 38"

HSON

To Order Specify

① Laminate Model #	② Edge Detail	③ Laminate Selection	③a PVC Edge Color	④ Electrical Cut Out	⑤ Metal Finish
Laminate (NST)	See Edge Detail Options	See Laminate Detail Selection	See PVC Edge Color Options	N None CO_EC23 Cut out for EC23 CO_EC24 Cut out for EC24	See Metal Finish Options

Model Number Breakdown

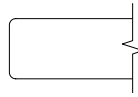
NSV4848-36SQX					
NS	V	4848	36	SQ	X
Nosh	Veneer	48" x 48"	Height	Square Top Shape	X Base

NS90 Nosh

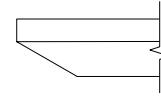
Description

Square Counter Height Table with X Base
(continued)

Veneer Tables
"NSV" Models



Eased Edge (R3)



Reverse Bevel Edge (K9)

VENEER	D	W	H	CTN WT	CU FT	1 Model	Flat Cut	Double Cut	Flat Cut	Double Cut
	42	42	36	87	21	NSV4242-36SQX	\$1,865	\$1,988	\$1,936	\$2,064
36	36	36	55	18	NSV3636-36SQX	\$1,655	\$1,765	\$1,717	\$1,830	
30	30	36	55	16	NSV3030-36SQX	\$1,486	\$1,583	\$1,541	\$1,643	

NOSH

To Order Specify

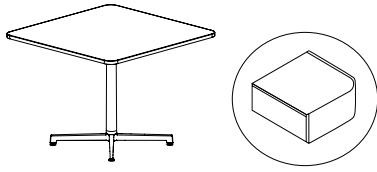
1 Veneer Model #	2 Edge Detail	3 Wood Species	4 Wood Finish	5 Electrical Cut Out	6 Metal Finish
Veneer (NSV)	See Edge Detail Options	Flat Cut B01 Cherry CH1 Cherry MA1 Maple WA1 Walnut	See Flat Cut Wood Finish Options	N None CO_EC23 Cut out for EC23 CO_EC24 Cut out for EC24	See Metal Finish Options
		Double Cut DC2 Double Cut	4 Wood Finish See Double Cut Wood Finish Options		

Nosh - 36" h Tables

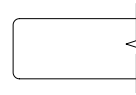


Description

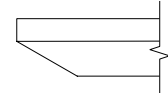
Rounded Square Counter Height Table with X Base



Laminate Tables "NST" Models



Eased Edge (R3)



Reverse Bevel (K9)

LAMINATE	D	W	H	CTN WT	CU FT	① Model	Eased Edge (R3)			Reverse Bevel (K9)		
							Standard	Graded In		Standard	Graded In	
							Tier 1	Tier 2	Tier 3	Tier 1	Tier 2	Tier 3
	42	42	36	86	21	NST4242-36SQRX	\$1,759	\$1,808	\$1,968	\$2,172	\$2,221	\$2,382
	36	36	36	69	18	NST3636-36SQRX	\$1,369	\$1,408	\$1,468	\$1,782	\$1,821	\$1,880
	30	30	36	55	16	NST3030-36SQRX	\$1,216	\$1,249	\$1,286	\$1,629	\$1,661	\$1,699

Features:

- price reflects complete table - top and base
- ships KD in multiple cartons
- top has option for cutout to receive electrical component, ordered separately
- when electrical cut out selected, power accessible base is sent - add \$111
- optional vertical wire manager for base, order separately
- base has leveling glides
- width of base foot varies from 26" to 38"

HSON

To Order Specify

① Laminate Model #	② Edge Detail	③ Laminate Selection	③a PVC Edge Color	④ Electrical Cut Out	⑤ Metal Finish
Laminate (NST)	See Edge Detail Options	See Laminate Detail Selection	See PVC Edge Color Options	N None CO_EC23 Cut out for EC23 CO_EC24 Cut out for EC24	See Metal Finish Options

Model Number Breakdown

NSV3030-36SQZ					
NS	V	3030	36	SQ	Z
Nosh	Veneer	30" x 30"	Height	Square Top Shape	X4 Base

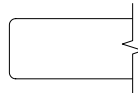
NS92 Nosh

Description

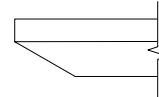
Rounded Square Counter Height Table
with X Base
(continued)

Veneer Tables
"NSV" Models

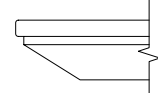
Solid Surface Tables
"NSS" Models



Eased Edge (R3)



Reverse Bevel Edge (K9)



Reverse Bevel Edge (S7)

	D	W	H	CTN WT	CU FT	① Model	Eased Edge (R3)		Reverse Bevel Edge (K9)		Reverse Bevel Edge (S7) Standard
							Flat Cut	Double Cut	Flat Cut	Double Cut	
VENEER	42	42	36	86	21	NSV4242-36SQRX	\$2,300	\$2,452	\$2,388	\$2,548	--
	36	36	36	69	18	NSV3636-36SQRX	\$1,906	\$2,034	\$1,980	\$2,112	--
	30	30	36	55	16	NSV3030-36SQRX	\$1,706	\$1,820	\$1,772	\$1,890	--
SOL SURF	42	42	36	115	21	NSS4242-36SQRX	--	--	--	--	\$4,543
	36	36	36	90	18	NSS3636-36SQRX	--	--	--	--	\$3,596
	30	30	36	69	13	NSS3030-36SQRX	--	--	--	--	\$3,010

NOSH

To Order Specify

① Veneer Model #	② Edge Detail	③ Wood Species	④ Wood Finish	⑤ Electrical Cut Out	⑥ Metal Finish
Veneer (NSV)	See Edge Detail Options	Flat Cut B01 Cherry CH1 Cherry MA1 Maple WA1 Walnut	See Flat Cut Wood Finish Options	N None CO_EC23 Cut out for EC23 CO_EC24 Cut out for EC24	See Metal Finish Options
		Double Cut DC2 Double Cut	④ Wood Finish See Double Cut Wood Finish Options		

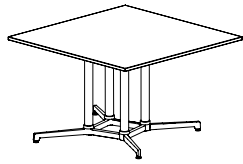
① Solid Surface Model #	② Edge Detail	③ Solid Surface	④ Electrical Cut Out	⑤ Metal Finish
Solid Surface (NSS)	See Edge Detail Options	See Solid Surface Options	N None CO_EC23 Cut out for EC23 CO_EC24 Cut out for EC24	See Metal Finish Options

Nosh - 36" h Tables

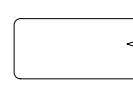


Description

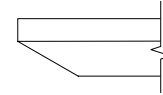
Square Counter Height Table with X4 Base



Laminate Tables "NST" Models



Eased Edge (R3)



Reverse Bevel Edge (K9)

LAMINATE	D	W	H	CTN WT	CU FT	① Model	Eased Edge (R3)			Reverse Bevel Edge (K9)		
							Standard	Graded In		Standard	Graded In	
							Tier 1	Tier 2	Tier 3	Tier 1	Tier 2	Tier 3
	60	60	36	175	48	NST6060-36SQZ	\$2,888	\$2,972	\$3,162	\$3,300	\$3,385	\$3,575
	54	54	36	151	42	NST5454-36SQZ	\$2,751	\$2,824	\$2,974	\$3,163	\$3,236	\$3,386
	48	48	36	136	60	NST4848-36SQZ	\$2,288	\$2,340	\$2,463	\$2,700	\$2,752	\$2,878

Features:

- price reflects complete table - top and base
- ships KD in multiple cartons
- base has leveling glides
- top has option for cut out to receive electrical component, order separately
- optional vertical wire manager for base, order separately
- width of base foot is 38"

HSON

To Order Specify

① Laminate Model #	② Edge Detail	③ Laminate Selection	③a PVC Edge Color	④ Electrical Cut Out	⑤ Metal Finish
Laminate (NST)	See Edge Detail Options	See Laminate Detail Selection	See PVC Edge Color Options	N None CO_EC23 Cut out for EC23 CO_EC24 Cut out for EC24	See Metal Finish Options

Model Number Breakdown

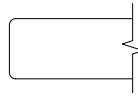
NSV5454-36SQZ					
NS	V	5454	36	SQ	Z
Nosh	Veneer	54" x 54"	Height	Square Top Shape	X4 Base

NS94 Nosh

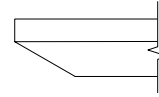
Description

Square Counter Height Table with X4 Base
(continued)

Veneer Tables
"NSV" Models



Eased Edge (R3)



Reverse Bevel Edge (K9)

VENEER	D	W	H	CTN WT	CU FT	1 Model	Flat Cut	Double Cut	Flat Cut	Double Cut
	60	60	36	175	48	NSV6060-36SQZ	\$3,741	\$3,989	\$3,882	\$4,139
54	54	36	151	42	NSV5454-36SQZ	\$3,560	\$3,794	\$3,694	\$3,938	
48	48	36	136	60	NSV4848-36SQZ	\$2,754	\$2,889	\$2,834	\$2,974	

NOSH

To Order Specify

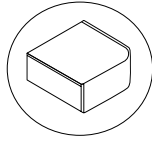
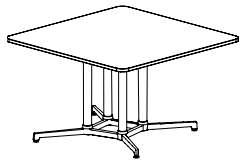
1 Veneer Model #	2 Edge Detail	3 Wood Species	4 Wood Finish	5 Electrical Cut Out	6 Metal Finish
Veneer (NSV)	See Edge Detail Options	Flat Cut B01 Cherry CH1 Cherry MA1 Maple WA1 Walnut	See Flat Cut Wood Finish Options	N None CO_EC23 Cut out for EC23 CO_EC24 Cut out for EC24	See Metal Finish Options
		Double Cut DC2 Double Cut	4 Wood Finish See Double Cut Wood Finish Options		

Nosh - 36" h Tables

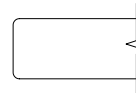


Description

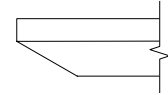
Rounded Square Counter Height Table with X4 Base



Laminate Tables "NST" Models



Eased Edge (R3)



Reverse Bevel (K9)

LAMINATE	D	W	H	CTN WT	CU FT	① Model	Eased Edge (R3)			Reverse Bevel (K9)		
							Standard	Graded In		Standard	Graded In	
							Tier 1	Tier 2	Tier 3	Tier 1	Tier 2	Tier 3
	60	60	36	180	48	NST6060-36SQRZ	\$3,100	\$3,176	\$3,375	\$3,512	\$3,588	\$3,788
	54	54	36	157	42	NST5454-36SQRZ	\$2,572	\$2,647	\$2,794	\$2,985	\$3,059	\$3,207
	48	48	36	136	60	NST4848-36SQRZ	\$2,624	\$2,675	\$2,823	\$3,037	\$3,087	\$3,235

Features:

- price reflects complete table - top and base
- ships KD in multiple cartons
- base has leveling glides
- top has option for cut out to receive electrical component, order separately
- optional vertical wire manager for base, order separately
- width of base foot is 38"

HSON

To Order Specify

① Laminate Model #	② Edge Detail	③ Laminate Selection	③a PVC Edge Color	④ Electrical Cut Out	⑤ Metal Finish
Laminate (NST)	See Edge Detail Options	See Laminate Detail Selection	See PVC Edge Color Options	N None CO_EC23 Cut out for EC23 CO_EC24 Cut out for EC24	See Metal Finish Options

Model Number Breakdown

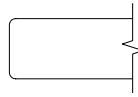
NST6060-36SQRZ						
NS	T	6060	36	SQ	R	Z
Nosh	Laminate	60" x 60"	Height	Square Top Shape	Rounded Corner	X4 Base

NS96 Nosh

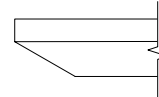
Description

Rounded Square Counter Height Table with X4 Base (continued)

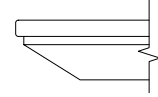
Veneer Tables "NSV" Models Solid Surface Tables "NSS" Models



Eased Edge (R3)



Reverse Bevel Edge (K9)



Reverse Bevel Edge (S7)

	D	W	H	CTN WT	CU FT	① Model	Eased Edge (R3)		Reverse Bevel Edge (K9)		Standard
							Flat Cut	Double Cut	Flat Cut	Double Cut	
VENEER	60	60	36	180	48	NSV6060-36SQRZ	\$4,021	\$4,289	\$4,173	\$4,451	--
	54	54	36	157	42	NSV5454-36SQRZ	\$3,325	\$3,542	\$3,448	\$3,676	--
	48	48	36	136	60	NSV4848-36SQRZ	\$3,197	\$3,362	\$3,293	\$3,464	--
SOL SURF	60	60	36	242	48	NSS6060-36SQRZ	--	--	--	--	\$7,943
	54	54	36	206	42	NSS5454-36SQRZ	--	--	--	--	\$6,585
	48	48	36	136	60	NSS4848-36SQRZ	--	--	--	--	\$5,236

NOSH

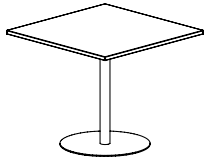
To Order Specify

① Veneer Model #	② Edge Detail	③ Wood Species	④ Wood Finish	⑤ Electrical Cut Out	⑥ Metal Finish
Veneer (NSV)	See Edge Detail Options	Flat Cut B01 Cherry CH1 Cherry MA1 Maple WA1 Walnut	See Flat Cut Wood Finish Options	N None CO_EC23 Cut out for EC23 CO_EC24 Cut out for EC24	See Metal Finish Options
		Double Cut DC2 Double Cut	④ Wood Finish See Double Cut Wood Finish Options		

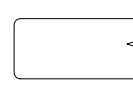
① Solid Surface Model #	② Edge Detail	③ Solid Surface	④ Electrical Cut Out	⑤ Metal Finish
Solid Surface (NSS)	See Edge Detail Options	See Solid Surface Options	N None CO_EC23 Cut out for EC23 CO_EC24 Cut out for EC24	See Metal Finish Options

Description

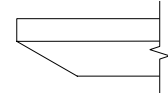
Square Counter Height Table
with Round Disc Base



Laminate Tables "NST" Models



Eased Edge (R3)



Reverse Bevel Edge (K9)

LAMINATE	D	W	H	CTN WT	CU FT	1 Model	Eased Edge (R3)			Reverse Bevel Edge (K9)		
							Standard	Graded In		Standard	Graded In	
							Tier 1	Tier 2	Tier 3	Tier 1	Tier 2	Tier 3
	42	42	36	123	20	NST4242-36SQR	\$1,314	\$1,360	\$1,400	\$1,726	\$1,773	\$1,812
	36	36	36	90	17	NST3636-36SQR	\$1,203	\$1,242	\$1,269	\$1,617	\$1,656	\$1,681
	30	30	36	76	13	NST3030-36SQR	\$1,145	\$1,177	\$1,191	\$1,557	\$1,591	\$1,604

Features:

- price reflects complete table - top and base
- ships KD in multiple cartons
- cut out for power is not available on these tables
- base has anti-rock glides
- width of base foot varies from 22" or 27"

HSON

To Order Specify

1 Laminate Model #	2 Edge Detail	3 Laminate Selection	3a PVC Edge Color	4 Metal Finish
Laminate (NST)	See Edge Detail Options	See Laminate Detail Selection	See PVC Edge Color Options	See Metal Finish Options

Model Number Breakdown

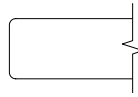
NSV4242-36SQR					
NS	V	4242	36	SQ	R
Nosh	Veneer	42" x 42"	Height	Square Top Shape	Round Disc Base

NS98 Nosh

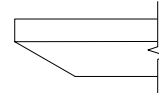
Description

Square Counter Height Table
with Round Disc Base
(continued)

Veneer Tables
"NSV" Models



Eased Edge (R3)



Reverse Bevel Edge (K9)

VENEER	D	W	H	CTN WT	CU FT	1 Model	Flat Cut	Double Cut	Flat Cut	Double Cut
	42	42	36	123	20	NSV4242-36SQR	\$1,660	\$1,771	\$1,724	\$1,836
36	36	36	90	17	NSV3636-36SQR	\$1,517	\$1,617	\$1,575	\$1,678	
30	30	36	76	13	NSV3030-36SQR	\$1,440	\$1,534	\$1,494	\$1,592	

NOSH

To Order Specify

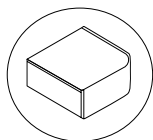
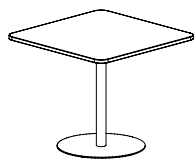
1 Veneer Model #	2 Edge Detail	3 Wood Species	4 Wood Finish	5 Electrical Cut Out	6 Metal Finish
Veneer (NSV)	See Edge Detail Options	Flat Cut B01 Cherry CH1 Cherry MA1 Maple WA1 Walnut	See Flat Cut Wood Finish Options	N None CO_EC23 Cut out for EC23 CO_EC24 Cut out for EC24	See Metal Finish Options
		Double Cut DC2 Double Cut	4 Wood Finish See Double Cut Wood Finish Options		

Nosh - 36" h Tables

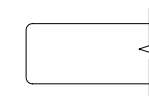


Description

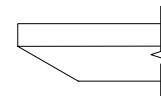
Rounded Square Counter Height Table with Round Disc Base



Laminate Tables "NST" Models



Eased Edge (R3)



Reverse Bevel (K9)

LAMINATE	D	W	H	CTN WT	CU FT	Model	Eased Edge (R3)			Reverse Bevel (K9)		
							Standard	Graded In		Standard	Graded In	
							Tier 1	Tier 2	Tier 3	Tier 1	Tier 2	Tier 3
	42	42	36	130	20	NST4242-36SQRR	\$1,635	\$1,684	\$1,771	\$2,047	\$2,096	\$2,183
	36	36	36	97	17	NST3636-36SQRR	\$1,396	\$1,435	\$1,494	\$1,808	\$1,849	\$1,906
	30	30	36	82	13	NST3030-36SQRR	\$1,314	\$1,346	\$1,383	\$1,726	\$1,759	\$1,795

Features:

- price reflects complete table - top and base
- ships KD in multiple cartons
- cut out for power is not available on these tables
- base has anti-rock glides
- width of base foot varies from 22" or 27"

HSON

To Order Specify

1 Laminate Model #	2 Edge Detail	3 Laminate Selection	3a PVC Edge Color	4 Metal Finish
Laminate (NST)	See Edge Detail Options	See Laminate Detail Selection	See PVC Edge Color Options	See Metal Finish Options

Model Number Breakdown

NST3030-36SQRR						
NS	T	3636	36	SQ	R	R
Nosh	Laminate	36" x 36"	Height	Square Top Shape	Rounded Corner	Round Disc Base

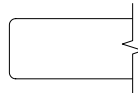
NS100 Nosh

Description

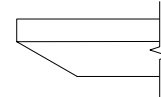
Rounded Square Counter Height Table
with Round Disc Base
(continued)

Veneer Tables
"NSV" Models

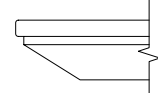
Solid Surface Tables
"NSS" Models



Eased Edge (R3)



Reverse Bevel Edge (K9)



Reverse Bevel Edge (S7)

	D	W	H	CTN WT	CU FT	① Model	Eased Edge (R3)		Reverse Bevel Edge (K9)		Reverse Bevel Edge (S7) Standard
							Flat Cut	Double Cut	Flat Cut	Double Cut	
VENEER	42	42	36	130	20	NSV4242-36SQRR	\$2,088	\$2,228	\$2,168	\$2,312	--
	36	36	36	97	17	NSV3636-36SQRR	\$1,771	\$1,886	\$1,836	\$1,959	--
	30	30	36	64	13	NSV3030-36SQRR	\$1,660	\$1,771	\$1,724	\$1,836	
SOL SURF	42	42	36	159	20	NSS4242-36SQRR	--	--	--	--	\$4,232
	36	36	36	117	17	NSS3636-36SQRR	--	--	--	--	\$3,460
	30	30	36	84	13	NSS3030-36SQRR	--	--	--	--	\$2,964

NOSH

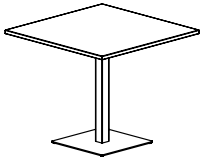
To Order Specify

① Veneer Model #	② Edge Detail	③ Wood Species	④ Wood Finish	⑤ Electrical Cut Out	⑥ Metal Finish
Veneer (NSV)	See Edge Detail Options	Flat Cut B01 Cherry CH1 Cherry MA1 Maple WA1 Walnut	See Flat Cut Wood Finish Options	N None CO_EC23 Cut out for EC23 CO_EC24 Cut out for EC24	See Metal Finish Options
		Double Cut DC2 Double Cut	④ Wood Finish See Double Cut Wood Finish Options		

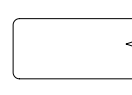
① Solid Surface Model #	② Edge Detail	③ Solid Surface	④ Electrical Cut Out	⑤ Metal Finish
Solid Surface (NSS)	See Edge Detail Options	See Solid Surface Options	N None CO_EC23 Cut out for EC23 CO_EC24 Cut out for EC24	See Metal Finish Options

Description

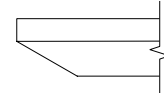
Square Counter Height Table with Square Disc Base



Laminate Tables "NST" Models



Eased Edge (R3)



Reverse Bevel Edge (K9)

LAMINATE	D	W	H	CTN WT	CU FT	① Model	Eased Edge (R3)			Reverse Bevel Edge (K9)		
							Standard	Graded In		Standard	Graded In	
							Tier 1	Tier 2	Tier 3	Tier 1	Tier 2	Tier 3
	42	42	36	145	20	NST4242-36SQS	\$1,514	\$1,562	\$1,602	\$1,927	\$1,976	\$2,016
	36	36	36	107	17	NST3636-36SQS	\$1,343	\$1,383	\$1,408	\$1,755	\$1,795	\$1,821
	30	30	36	93	13	NST3030-36SQS	\$1,285	\$1,319	\$1,330	\$1,698	\$1,731	\$1,744

Features:

- price reflects complete table - top and base
- ships KD in multiple cartons
- cut out for power is not available on these tables
- width of base foot varies from 22" or 27"
- base has anti-rock glides

HSON

To Order Specify

① Laminate Model #	② Edge Detail	③ Laminate Selection	③a PVC Edge Color	④ Metal Finish
Laminate (NST)	See Edge Detail Options	See Laminate Detail Selection	See PVC Edge Color Options	See Metal Finish Options

Model Number Breakdown

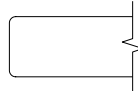
NST3636-36SQS					
NS	T	3636	36	SQ	S
Nosh	Laminate	36" x 36"	Height	Square Top Shape	Square Disc Base

NS102 Nosh

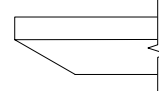
Description

Square Counter Height Table
with Square Disc Base
(continued)

Veneer Tables
"NSV" Models



Eased Edge (R3)



Reverse Bevel Edge (K9)

VENEER	D	W	H	CTN WT	CU FT	1 Model	Flat Cut	Double Cut	Flat Cut	Double Cut
	42	42	36	145	20	NSV4242-36SQS	\$1,927	\$2,134	\$2,001	\$2,135
36	36	36	107	17	NSV3636-36SQS	\$1,701	\$1,878	\$1,768	\$1,882	
30	30	36	93	13	NSV3030-36SQS	\$1,624	\$1,786	\$1,685	\$1,796	

NOSH

To Order Specify

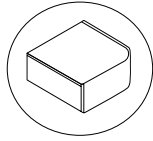
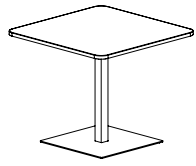
1 Veneer Model #	2 Edge Detail	3 Wood Species	4 Wood Finish	5 Electrical Cut Out	6 Metal Finish
Veneer (NSV)	See Edge Detail Options	Flat Cut B01 Cherry CH1 Cherry MA1 Maple WA1 Walnut	See Flat Cut Wood Finish Options	N None CO_EC23 Cut out for EC23 CO_EC24 Cut out for EC24	See Metal Finish Options
		Double Cut DC2 Double Cut	4 Wood Finish See Double Cut Wood Finish Options		

Nosh - 36"h Tables

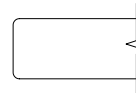


Description

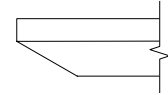
Rounded Square Counter Height Table with Square Disc Base



Laminate Tables "NST" Models



Eased Edge (R3)



Reverse Bevel (K9)

LAMINATE	D	W	H	CTN WT	CU FT	① Model	Eased Edge (R3)			Reverse Bevel (K9)		
							Standard	Graded In		Standard	Graded In	
							Tier 1	Tier 2	Tier 3	Tier 1	Tier 2	Tier 3
	42	42	36	145	20	NST4242-36SQRS	\$1,836	\$1,884	\$1,972	\$2,250	\$2,300	\$2,386
	36	36	36	107	17	NST3636-36SQRS	\$1,535	\$1,576	\$1,634	\$1,947	\$1,989	\$2,046
	30	30	36	93	13	NST3030-36SQRS	\$1,452	\$1,487	\$1,522	\$1,867	\$1,899	\$1,936

Features:

- bases are cast aluminum feet with 2 5/8" - 14 guage round
- ships KD in multiple cartons
- cut out for power is not available on these tables
- base has anti-rock glides
- width of base foot varies from 22" or 27"

HSON

To Order Specify

① Laminate Model #	② Edge Detail	③ Laminate Selection	③a PVC Edge Color	④ Metal Finish
Laminate (NST)	See Edge Detail Options	See Laminate Detail Selection	See PVC Edge Color Options	See Metal Finish Options

Model Number Breakdown

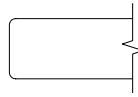
NSS4242-36SQRS						
NS	S	4242	36	SQ	R	S
Nosh	Solid Surfaced	42" x 42"	Height	Square Top Shape	Rounded Corner	Square Disc Base

NS104 Nosh

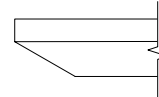
Description

Rounded Square Counter Height Table with Square Disc Base (continued)

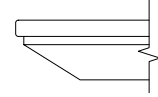
Veneer Tables "NSV" Models Solid Surface Tables "NSS" Models



Eased Edge (R3)



Reverse Bevel Edge (K9)



Reverse Bevel Edge (S7)

	D	W	H	CTN WT	CU FT	① Model	Eased Edge (R3)		Reverse Bevel Edge (K9)		Standard
							Flat Cut	Double Cut	Flat Cut	Double Cut	
VENEER	42	42	36	145	20	NSV4242-36SQRS	\$2,354	\$2,512	\$2,445	\$2,607	--
	36	36	36	107	17	NSV3636-36SQRS	\$2,140	\$2,283	\$2,222	\$2,371	--
	30	30	36	93	13	NSV3030-36SQRS	\$2,030	\$2,167	\$2,108	\$2,249	--
SOL SURF	42	42	36	174	20	NSS4242-36SQRS	--	--	--	--	\$4,498
	36	36	36	118	17	NSS3636-36SQRS	--	--	--	--	\$3,830
	30	30	36	90	13	NSS3030-36SQRS	--	--	--	--	\$3,334

NOSH

To Order Specify

① Veneer Model #	② Edge Detail	③ Wood Species	④ Wood Finish	⑤ Electrical Cut Out	⑥ Metal Finish
Veneer (NSV)	See Edge Detail Options	Flat Cut B01 Cherry CH1 Cherry MA1 Maple WA1 Walnut	See Flat Cut Wood Finish Options	N None CO_EC23 Cut out for EC23 CO_EC24 Cut out for EC24	See Metal Finish Options
		Double Cut DC2 Double Cut	④ Wood Finish See Double Cut Wood Finish Options		

① Solid Surface Model #	② Edge Detail	③ Solid Surface	④ Electrical Cut Out	⑤ Metal Finish
Solid Surface (NSS)	See Edge Detail Options	See Solid Surface Options	N None CO_EC23 Cut out for EC23 CO_EC24 Cut out for EC24	See Metal Finish Options

Nosh - 36" h Tables



Description

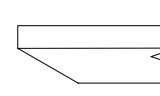
Squirrel Counter Height Table with X Base



Laminate Tables "NST" Models



Eased Edge (R3)



Reverse Bevel Edge (K9)

LAMINATE	D	W	H	CTN WT	CU FT	① Model	Eased Edge (R3)			Reverse Bevel Edge (K9)		
							Standard	Graded In		Standard	Graded In	
							Tier 1	Tier 2	Tier 3	Tier 1	Tier 2	Tier 3
	42	42	36	74	21	NST42-36SCX	\$1,422	\$1,530	\$1,617	\$1,835	\$1,943	\$2,030
	36	36	36	60	18	NST36-36SCX	\$1,378	\$1,419	\$1,482	\$1,793	\$1,832	\$1,895
	30	30	36	48	16	NST30-36SCX	\$1,333	\$1,364	\$1,400	\$1,746	\$1,778	\$1,816

Features:

- price reflects complete table - top and base
- ships KD in multiple cartons
- top has option for cutout to receive electrical component, ordered separately
- when electrical cut out selected, power accessible base is sent - add \$111
- base has leveling glides
- width of base foot varies from 26" or 32"

HSON

To Order Specify

① Laminate Model #	② Edge Detail	③ Laminate Selection	③a PVC Edge Color	④ Electrical Cut Out	⑤ Metal Finish
Laminate (NST)	See Edge Detail Options	See Laminate Detail Selection	See PVC Edge Color Options	N None COB_EC23 Cut out for EC23 COB_EC24 Cut out for EC24	See Metal Finish Options

Model Number Breakdown

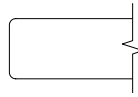
NSS42-36SCX					
NS	S	42	36	SC	X
Nosh	Solid Surface	42"	Height	Squirrel Top Shape	X Base

NS106 Nosh

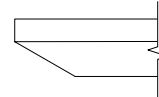
Description

Squircle Counter Height Table with X Base
(continued)

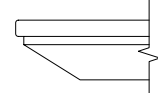
Veneer Tables "NSV" Models	Solid Surface Tables "NSS" Models
----------------------------	-----------------------------------



Eased Edge (R3)



Reverse Bevel Edge (K9)



Reverse Bevel Edge (S7)

	D	W	H	CTN WT	CU FT	① Model	Eased Edge (R3)		Reverse Bevel Edge (K9)		Reverse Bevel Edge (S7) Standard
							Flat Cut	Double Cut	Flat Cut	Double Cut	
VENEER	42	42	36	74	21	NSV42-36SCX	\$1,865	\$1,986	\$1,936	\$2,063	--
	36	36	36	60	18	NSV36-36SCX	\$1,807	\$1,924	\$1,877	\$2,000	--
	30	30	36	48	16	NSV30-36SCX	\$1,744	\$1,857	\$1,810	\$1,929	--
SOL SURF	42	42	36	96	21	NSS42-36SCX	--	--	--	--	\$4,023
	36	36	36	76	18	NSS36-36SCX	--	--	--	--	\$3,513
	30	30	36	59	16	NSS30-36SCX	--	--	--	--	\$3,389

NOSH

To Order Specify

① Veneer Model #	② Edge Detail	③ Wood Species	④ Wood Finish	⑤ Electrical Cut Out	⑥ Metal Finish
Veneer (NSV)	See Edge Detail Options	Flat Cut B01 Cherry CH1 Cherry MA1 Maple WA1 Walnut	See Flat Cut Wood Finish Options	N None CO_EC23 Cut out for EC23 CO_EC24 Cut out for EC24	See Metal Finish Options
		Double Cut DC2 Double Cut	④ Wood Finish See Double Cut Wood Finish Options		

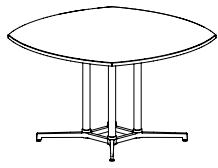
① Solid Surface Model #	② Edge Detail	③ Solid Surface	④ Electrical Cut Out	⑤ Metal Finish
Solid Surface (NSS)	See Edge Detail Options	See Solid Surface Options	N None CO_EC23 Cut out for EC23 CO_EC24 Cut out for EC24	See Metal Finish Options

Nosh - 36" h Tables

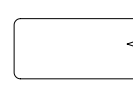


Description

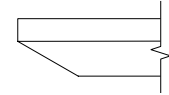
Squirrel Counter Height Table with X4 Base



Laminate Tables "NST" Models



Eased Edge (R3)



Reverse Bevel Edge (K9)

LAMINATE	D	W	H	CTN WT	CU FT	① Model	Eased Edge (R3)			Reverse Bevel Edge (K9)		
							Standard	Graded In		Standard	Graded In	
							Tier 1	Tier 2	Tier 3	Tier 1	Tier 2	Tier 3
	60	60	36	154	48	NST60-36SCZ	\$2,563	\$2,648	\$2,838	\$2,977	\$3,061	\$3,251
	54	54	36	105	26	NST54-36SCZ	\$2,395	\$2,460	\$2,526	\$2,810	\$2,876	\$2,940
	48	48	36	88	25	NST48-36SCZ	\$2,277	\$2,384	\$2,503	\$2,690	\$2,798	\$2,917

Features:

- price reflects complete table - top and base
- ships KD in multiple cartons
- base has leveling glides
- top has option for cut out to receive electrical component, order separately
- optional vertical wire manager for base, order separately
- width of base foot is 38"

HSON

To Order Specify

① Laminate Model #	② Edge Detail	③ Laminate Selection	③a PVC Edge Color	④ Electrical Cut Out	⑤ Metal Finish
Laminate (NST)	See Edge Detail Options	See Laminate Detail Selection	See PVC Edge Color Options	N None CO_EC23 Cut out for EC23 CO_EC24 Cut out for EC24	See Metal Finish Options

Model Number Breakdown

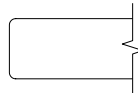
NST54-36SCZ					
NS	T	54	36	SC	Z
Nosh	Laminate	54"	Height	Squirrel Top Shape	X4 Base

NS108 Nosh

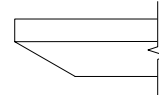
Description

Squircle Counter Height Table with X4 Base (continued)

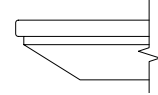
Veneer Tables "NSV" Models	Solid Surface Tables "NSS" Models
----------------------------	-----------------------------------



Eased Edge (R3)



Reverse Bevel Edge (K9)



Reverse Bevel Edge (S7)

	D	W	H	CTN WT	CU FT	① Model	Eased Edge (R3)		Reverse Bevel Edge (K9)		Reverse Bevel Edge (S7) Standard
							Flat Cut	Double Cut	Flat Cut	Double Cut	
VENEER	60	60	36	154	48	NSV60-36SCZ	\$3,351	\$3,570	\$3,478	\$3,705	--
	54	54	36	105	26	NSV54-36SCZ	\$3,168	\$3,381	\$3,292	\$3,512	--
	48	48	36	88	25	NSV48-36SCZ	\$2,760	\$2,892	\$2,838	\$2,977	--
SOL SURF	60	60	36	202	48	NSS60-36SCZ	--	--	--	--	\$7,291
	54	54	36	143	26	NSS54-36SCZ	--	--	--	--	\$6,446
	48	48	36	118	25	NSS48-36SCZ	--	--	--	--	\$5,444

NOSH

To Order Specify

① Veneer Model #	② Edge Detail	③ Wood Species	④ Wood Finish	⑤ Electrical Cut Out	⑥ Metal Finish
Veneer (NSV)	See Edge Detail Options	Flat Cut B01 Cherry CH1 Cherry MA1 Maple WA1 Walnut	See Flat Cut Wood Finish Options	N None CO_EC23 Cut out for EC23 CO_EC24 Cut out for EC24	See Metal Finish Options
		Double Cut DC2 Double Cut	④ Wood Finish See Double Cut Wood Finish Options		

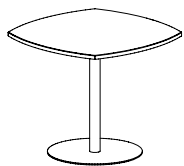
① Solid Surface Model #	② Edge Detail	③ Solid Surface	④ Electrical Cut Out	⑤ Metal Finish
Solid Surface (NSS)	See Edge Detail Options	See Solid Surface Options	N None CO_EC23 Cut out for EC23 CO_EC24 Cut out for EC24	See Metal Finish Options

Nosh - 36" h Tables

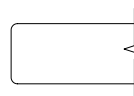


Description

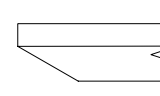
Squirrel Counter Height Table with Round Disc Base



Laminate Tables "NST" Models



Eased Edge (R3)



Reverse Bevel Edge (K9)

LAMINATE	D	W	H	CTN WT	CU FT	① Model	Eased Edge (R3)			Reverse Bevel Edge (K9)		
							Standard	Graded In		Standard	Graded In	
							Tier 1	Tier 2	Tier 3	Tier 1	Tier 2	Tier 3
	42	42	36	117	20	NST42-36SCR	\$1,620	\$1,670	\$1,755	\$2,034	\$2,084	\$2,170
	36	36	36	86	17	NST36-36SCR	\$1,388	\$1,430	\$1,489	\$1,800	\$1,842	\$1,902
	30	30	36	64	15	NST30-36SCR	\$1,196	\$1,229	\$1,266	\$1,610	\$1,644	\$1,680

Features:

- price reflects complete table - top and base
- ships KD in multiple cartons
- cut out for power is not available on these tables
- base has anti-rock glides
- width of base foot varies from 22" or 27"

HSON

To Order Specify

① Laminate Model #	② Edge Detail	③ Laminate Selection	③a PVC Edge Color	④ Metal Finish
Laminate (NST)	See Edge Detail Options	See Laminate Detail Selection	See PVC Edge Color Options	See Metal Finish Options

Model Number Breakdown

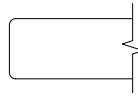
NSV42-36SCR					
NS	V	42	36	SC	R
Nosh	Veneer	42"	Height	Squirrel Top Shape	Round Disc Base

NS110 Nosh

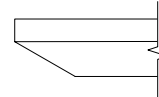
Description

Squirle Counter Height Table with Round Disc Base (continued)

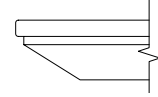
Veneer Tables "NSV" Models	Solid Surface Tables "NSS" Models
----------------------------	-----------------------------------



Eased Edge (R3)



Reverse Bevel Edge (K9)



Reverse Bevel Edge (S7)

	D	W	H	CTN WT	CU FT	1 Model	Eased Edge (R3)		Reverse Bevel Edge (K9)		Standard
							Flat Cut	Double Cut	Flat Cut	Double Cut	
VENEER	42	42	36	117	20	NSV42-36SCR	\$2,130	\$2,270	\$2,212	\$2,358	--
	36	36	36	86	17	NSV36-36SCR	\$1,820	\$1,940	\$1,891	\$2,015	--
	30	30	36	64	15	NSV30-36SCR	\$1,562	\$1,663	\$1,622	\$1,728	--
SOL SURF	42	42	36	140	20	NSS42-36SCR	--	--	--	--	\$4,290
	36	36	36	103	17	NSS36-36SCR	--	--	--	--	\$3,528
	30	30	36	75	15	NSS30-36SCR	--	--	--	--	\$3,022

NOSH

To Order Specify

1 Veneer Model #	2 Edge Detail	3 Wood Species	4 Wood Finish	5 Electrical Cut Out	6 Metal Finish
Veneer (NSV)	See Edge Detail Options	Flat Cut B01 Cherry CH1 Cherry MA1 Maple WA1 Walnut	See Flat Cut Wood Finish Options	N None CO_EC23 Cut out for EC23 CO_EC24 Cut out for EC24	See Metal Finish Options
		Double Cut DC2 Double Cut	4 Wood Finish See Double Cut Wood Finish Options		

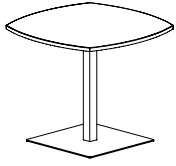
1 Solid Surface Model #	2 Edge Detail	3 Solid Surface	4 Electrical Cut Out	5 Metal Finish
Solid Surface (NSS)	See Edge Detail Options	See Solid Surface Options	N None CO_EC23 Cut out for EC23 CO_EC24 Cut out for EC24	See Metal Finish Options

Nosh - 36" h Tables

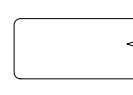


Description

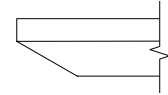
Squirrel Counter Height Table with Square Disc Base



Laminate Tables "NST" Models



Eased Edge (R3)



Reverse Bevel Edge (K9)

LAMINATE	D	W	H	CTN WT	CU FT	① Model	Eased Edge (R3)			Reverse Bevel Edge (K9)		
							Standard	Graded In		Standard	Graded In	
							Tier 1	Tier 2	Tier 3	Tier 1	Tier 2	Tier 3
	42	42	36	132	20	NST42-36SCS	\$1,822	\$1,872	\$1,957	\$2,237	\$2,286	\$2,373
	36	36	36	98	17	NST36-36SCS	\$1,530	\$1,570	\$1,629	\$1,942	\$1,982	\$2,042
	30	30	36	69	15	NST30-36SCS	\$1,336	\$1,370	\$1,406	\$1,749	\$1,784	\$1,820

Features:

- price reflects complete table - top and base
- ships KD in multiple cartons
- cut out for power is not available on these tables
- base has anti-rock glides
- width of base foot varies from 17" to 27"

HSON

To Order Specify

① Laminate Model #	② Edge Detail	③ Laminate Selection	③a PVC Edge Color	④ Metal Finish
Laminate (NST)	See Edge Detail Options	See Laminate Detail Selection	See PVC Edge Color Options	See Metal Finish Options

Model Number Breakdown

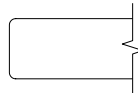
NST36-36SCS					
NS	T	36	36	SC	S
Nosh	Laminate	36"	Height	Squirrel Top Shape	Square Disc Base

NS112 Nosh

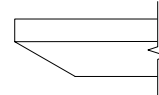
Description

Squircle Counter Height Table with Square Disc Base (continued)

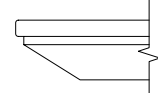
Veneer Tables "NSV" Models Solid Surface Tables "NSS" Models



Eased Edge (R3)



Reverse Bevel Edge (K9)



Reverse Bevel Edge (S7)

	D	W	H	CTN WT	CU FT	① Model	Eased Edge (R3)		Reverse Bevel Edge (K9)		Standard
							Flat Cut	Double Cut	Flat Cut	Double Cut	
VENEER	42	42	36	132	20	NSV42-36SCS	\$2,400	\$2,560	\$2,493	\$2,660	--
	36	36	36	98	17	NSV36-36SCS	\$2,007	\$2,140	\$2,085	\$2,224	--
	30	30	36	69	15	NSV30-36SCS	\$1,748	\$1,864	\$1,817	\$1,936	--
SOL SURF	42	42	36	155	20	NSS42-36SCS	--	--	--	--	\$4,560
	36	36	36	103	17	NSS36-36SCS	--	--	--	--	\$3,715
	30	30	36	80	15	NSS30-36SCS	--	--	--	--	\$3,398

NOSH

To Order Specify

① Veneer Model #	② Edge Detail	③ Wood Species	④ Wood Finish	⑤ Electrical Cut Out	⑥ Metal Finish
Veneer (NSV)	See Edge Detail Options	Flat Cut	See Flat Cut Wood Finish Options	N None CO_EC23 Cut out for EC23 CO_EC24 Cut out for EC24	See Metal Finish Options
		B01 Cherry CH1 Cherry MA1 Maple WA1 Walnut			
		Double Cut	④ Wood Finish See Double Cut Wood Finish Options		
		DC2 Double Cut			

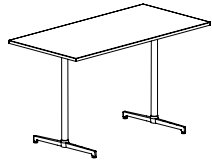
① Solid Surface Model #	② Edge Detail	③ Solid Surface	④ Electrical Cut Out	⑤ Metal Finish
Solid Surface (NSS)	See Edge Detail Options	See Solid Surface Options	N None CO_EC23 Cut out for EC23 CO_EC24 Cut out for EC24	See Metal Finish Options

Nosh - 42" h Tables

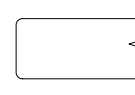


Description

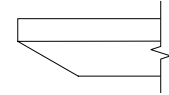
Rectangular Bar Height Table with T Base



Laminate Tables "NST" Models



Eased Edge (R3)



Reverse Bevel Edge (K9)

LAMINATE	D	W	H	CTN WT	CU FT	① Model	Eased Edge (R3)			Reverse Bevel Edge (K9)		
							Standard	Graded In		Standard	Graded In	
							Tier 1	Tier 2	Tier 3	Tier 1	Tier 2	Tier 3
	36	72	42	135	63	NST3672-42TTT	\$1,785	\$1,848	\$1,984	\$2,197	\$2,260	\$2,396
	36	66	42	127	58	NST3666-42TTT	\$1,728	\$1,785	\$1,908	\$2,140	\$2,197	\$2,324
	36	60	42	119	46	NST3660-42TTT	\$1,657	\$1,710	\$1,822	\$2,070	\$2,125	\$2,235
	30	72	42	120	61	NST3072-42TTT	\$1,537	\$1,593	\$1,704	\$1,949	\$2,005	\$2,117
	30	66	42	113	35	NST3066-42TTT	\$1,480	\$1,532	\$1,632	\$1,893	\$1,944	\$2,044
	30	60	42	105	36	NST3060-42TTT	\$1,409	\$1,457	\$1,547	\$1,822	\$1,871	\$1,960

Features:

- price reflects complete table - top and base
- ships KD in multiple cartons
- top has option for cut out to receive electrical component, order separately
- optional vertical wire manager for base, order separately
- base has leveling glides
- width of base foot varies from 26 ½" or 32 ½"

HSON

To Order Specify

① Laminate Model #	② Edge Detail	③ Laminate Selection	③a PVC Edge Color	④ Electrical Cut Out	⑤ Metal Finish
Laminate (NST)	See Edge Detail Options	See Laminate Detail Selection	See PVC Edge Color Options	N None CO_EC23 Cut out for EC23 CO_EC24 Cut out for EC24	See Metal Finish Options

Model Number Breakdown

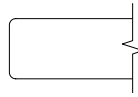
NSV3672-42TTT					
NS	V	3672	42	TT	T
Nosh	Veneer	36" x 72"	Height	Rectangular Top Shape	T Base

NS114 Nosh

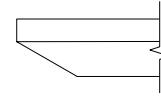
Description

Rectangular Bar Height Table with T Base
(continued)

Veneer Tables
"NSV" Models



Eased Edge (R3)



Reverse Bevel Edge (K9)

VENEER	D	W	H	CTN WT	CU FT	① Model	Flat Cut	Double Cut	Flat Cut	Double Cut
		36	72	42	135	63	NSV3672-42TTT	\$2,061	\$2,242	\$2,220
	36	66	42	127	58	NSV3666-42TTT	\$2,021	\$2,191	\$2,175	\$2,341
	36	60	42	119	46	NSV3660-42TTT	\$1,966	\$2,122	\$2,113	\$2,267
	30	72	42	120	61	NSV3072-42TTT	\$1,946	\$2,106	\$2,094	\$2,246
	30	66	42	113	35	NSV3066-42TTT	\$1,894	\$2,042	\$2,034	\$2,179
	30	60	42	105	36	NSV3060-42TTT	\$1,848	\$2,008	\$1,982	\$2,116

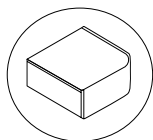
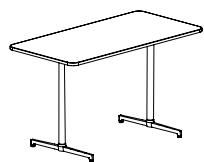
NOSH

To Order Specify

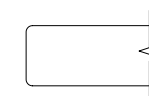
① Veneer Model #	② Edge Detail	③ Wood Species	④ Wood Finish	⑤ Electrical Cut Out	⑥ Metal Finish
Veneer (NSV)	See Edge Detail Options	Flat Cut B01 Cherry CH1 Cherry MA1 Maple WA1 Walnut	See Flat Cut Wood Finish Options	N None CO_EC23 Cut out for EC23 CO_EC24 Cut out for EC24	See Metal Finish Options
		Double Cut DC2 Double Cut	④ Wood Finish See Double Cut Wood Finish Options		

Description

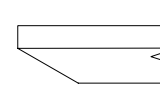
Rounded Rectangular Bar Height Table with T Base



Laminate Tables "NST" Models



Eased Edge (R3)



Reverse Bevel (K9)

LAMINATE	D	W	H	CTN WT	CU FT	① Model	Eased Edge (R3)			Reverse Bevel (K9)		
							Standard	Graded In		Standard	Graded In	
							Tier 1	Tier 2	Tier 3	Tier 1	Tier 2	Tier 3
	36	72	42	135	63	NST3672-42TTRT	\$1,757	\$1,816	\$1,923	\$2,171	\$2,228	\$2,336
	36	66	42	127	58	NST3666-42TTRT	\$1,543	\$1,593	\$1,692	\$1,956	\$2,005	\$2,106
	36	60	42	119	46	NST3660-42TTRT	\$1,496	\$1,543	\$1,631	\$1,908	\$1,956	\$2,043
	30	72	42	119	61	NST3072-42TTRT	\$1,717	\$1,773	\$1,881	\$2,130	\$2,185	\$2,293
	30	66	42	112	35	NST3066-42TTRT	\$1,656	\$1,707	\$1,808	\$2,069	\$2,120	\$2,221
	30	60	42	105	36	NST3060-42TTRT	\$1,602	\$1,651	\$1,741	\$2,016	\$2,066	\$2,154

Features:

- price reflects complete table - top and base
- ships KD in multiple cartons
- top has option for cut out to receive electrical component, order separately
- optional vertical wire manager for base, order separately
- base has leveling glides
- width of base foot varies from 22" or 33"

HSON

To Order Specify

① Laminate Model #	② Edge Detail	③ Laminate Selection	③a PVC Edge Color	④ Electrical Cut Out	⑤ Metal Finish
Laminate (NST)	See Edge Detail Options	See Laminate Detail Selection	See PVC Edge Color Options	N None CO_EC23 Cut out for EC23 CO_EC24 Cut out for EC24	See Metal Finish Options

Model Number Breakdown

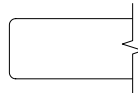
NST3072-42TTRT						
NS	T	3072	42	TT	R	T
Nosh	Laminate	30" x 72"	Height	Rectangular Top Shape	Rounded Corner	T Base

Description

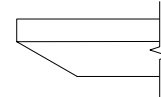
Rounded Rectangular Bar Height Table
with T Base
(continued)

Veneer Tables
"NSV" Models

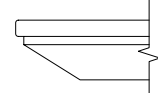
Solid Surface Tables
"NSS" Models



Eased Edge (R3)



Reverse Bevel Edge (K9)



Reverse Bevel Edge (S7)

	D	W	H	CTN WT	CU FT	① Model	Veneer Tables "NSV" Models		Solid Surface Tables "NSS" Models		
							Flat Cut	Double Cut	Flat Cut	Double Cut	Standard
VENEER	36	72	42	135	63	NSV3672-42TTRT	\$2,204	\$2,395	\$2,283	\$2,463	--
	36	66	42	127	58	NSV3666-42TTRT	\$2,160	\$2,341	\$2,238	\$2,404	--
	36	60	42	119	46	NSV3660-42TTRT	\$2,101	\$2,267	\$2,172	\$2,328	--
	30	72	42	119	61	NSV3072-42TTRT	\$2,075	\$2,242	\$2,146	\$2,302	--
	30	66	42	112	35	NSV3066-42TTRT	\$2,019	\$2,175	\$2,076	\$2,221	--
	30	60	42	105	36	NSV3060-42TTRT	\$1,968	\$2,112	\$2,030	\$2,165	--
SOLID SURFACE	36	72	42	176	63	NSS3672-42TTRT	--	--	--	--	\$5,232
	36	66	42	164	58	NSS3666-42TTRT	--	--	--	--	\$4,980
	36	60	42	145	46	NSS3660-42TTRT	--	--	--	--	\$4,709
	30	72	42	152	61	NSS3072-42TTRT	--	--	--	--	\$4,686
	30	66	42	142	35	NSS3066-42TTRT	--	--	--	--	\$4,453
	30	60	42	125	36	NSS3060-42TTRT	--	--	--	--	\$4,230

NOSH

To Order Specify

① Veneer Model #	② Edge Detail	③ Wood Species	④ Wood Finish	⑤ Electrical Cut Out	⑥ Metal Finish
Veneer (NSV)	See Edge Detail Options	Flat Cut B01 Cherry CH1 Cherry MA1 Maple WA1 Walnut	See Flat Cut Wood Finish Options	N None CO_EC23 Cut out for EC23 CO_EC24 Cut out for EC24	See Metal Finish Options
		Double Cut DC2 Double Cut	④ Wood Finish See Double Cut Wood Finish Options		

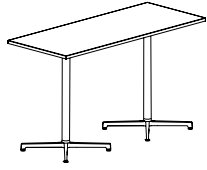
① Solid Surface Model #	② Edge Detail	③ Solid Surface	④ Electrical Cut Out	⑤ Metal Finish
Solid Surface (NSS)	See Edge Detail Options	See Solid Surface Options	N None CO_EC23 Cut out for EC23 CO_EC24 Cut out for EC24	See Metal Finish Options

Nosh - 42" h Tables

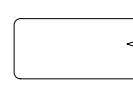


Description

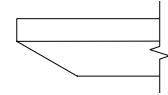
Rectangular Bar Height Table with X Base



Laminate Tables "NST" Models



Eased Edge (R3)



Reverse Bevel Edge (K9)

LAMINATE	D	W	H	CTN WT	CU FT	① Model	Eased Edge (R3)			Reverse Bevel Edge (K9)		
							Standard	Graded In		Standard	Graded In	
							Tier 1	Tier 2	Tier 3	Tier 1	Tier 2	Tier 3
	36	72	42	146	57	NST3672-42TTX	\$2,291	\$2,354	\$2,491	\$2,704	\$2,767	\$2,903
	30	72	42	130	33	NST3072-42TTX	\$2,076	\$2,132	\$2,242	\$2,489	\$2,545	\$2,654

Features:

- price reflects complete table - top and base
- ships KD in multiple cartons
- top has option for cut out to receive electrical component, order separately
- optional vertical wire manager for base, order separately
- base has leveling glides
- width of base foot varies from 26" or 32"

HSON

To Order Specify

① Laminate Model #	② Edge Detail	③ Laminate Selection	③a PVC Edge Color	④ Electrical Cut Out	⑤ Metal Finish
Laminate (NST)	See Edge Detail Options	See Laminate Detail Selection	See PVC Edge Color Options	N None CO_EC23 Cut out for EC23 CO_EC24 Cut out for EC24	See Metal Finish Options

Model Number Breakdown

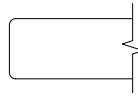
NST3060-42TTX					
NS	T	3060	42	TT	X
Nosh	Laminate	30" x 60"	Height	Rectangular Top Shape	X Base

NS118 Nosh

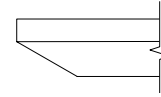
Description

Rectangular Bar Height Table with X Base
(continued)

Veneer Tables
"NSV" Models



Eased Edge (R3)



Reverse Bevel Edge (K9)

VENEER	D	W	H	CTN WT	CU FT	1 Model	Flat Cut	Double Cut	Flat Cut	Double Cut
	36	72	42	146	57	NSV3672-42TTX	\$2,568	\$2,750	\$2,727	\$2,904
30	72	42	130	33	NSV3072-42TTX	\$2,485	\$2,644	\$2,632	\$2,786	

NOSH

To Order Specify

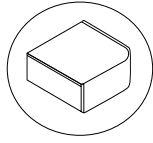
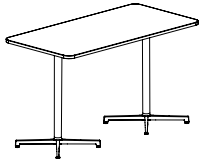
1 Veneer Model #	2 Edge Detail	3 Wood Species	4 Wood Finish	5 Electrical Cut Out	6 Metal Finish
Veneer (NSV)	See Edge Detail Options	Flat Cut B01 Cherry CH1 Cherry MA1 Maple WA1 Walnut	See Flat Cut Wood Finish Options	N None CO_EC23 Cut out for EC23 CO_EC24 Cut out for EC24	See Metal Finish Options
		Double Cut DC2 Double Cut	4 Wood Finish See Double Cut Wood Finish Options		

Nosh - 42" h Tables

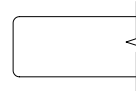


Description

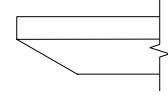
Rounded Rectangular Bar Height Table with X Base



Laminate Tables "NST" Models



Eased Edge (R3)



Reverse Bevel (K9)

LAMINATE	D	W	H	CTN WT	CU FT	① Model	Eased Edge (R3)			Reverse Bevel (K9)		
							Standard Tier 1	Graded In Tier 2 Tier 3		Standard Tier 1	Graded In Tier 2 Tier 3	
	36	72	42	146	57	NST3672-42TTRX	\$2,383	\$2,447	\$2,580	\$2,796	\$2,859	\$2,993
	30	72	42	129	33	NST3072-42TTRX	\$2,255	\$2,311	\$2,421	\$2,669	\$2,725	\$2,835

Features:

- price reflects complete table - top and base
- ships KD in multiple cartons
- top has option for cut out to receive electrical component, order separately
- optional vertical wire manager for base, order separately
- base has leveling glides
- width of base foot varies from 26" or 32"

HSON

To Order Specify

① Laminate Model #	② Edge Detail	③ Laminate Selection	③a PVC Edge Color	④ Electrical Cut Out	⑤ Metal Finish
Laminate (NST)	See Edge Detail Options	See Laminate Detail Selection	See PVC Edge Color Options	N None CO_EC23 Cut out for EC23 CO_EC24 Cut out for EC24	See Metal Finish Options

Model Number Breakdown

NST3066-42TTRX						
NS	T	3066	42	TT	R	X
Nosh	Laminate	30" x 66"	Height	Rectangular Top Shape	Rounded Corner	X Base

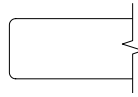
NS120 Nosh

Description

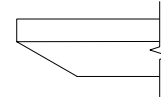
Rounded Rectangular Bar Height Table
with X Base
(continued)

Veneer Tables
"NSV" Models

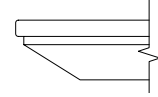
Solid Surface Tables
"NSS" Models



Eased Edge (R3)



Reverse Bevel Edge (K9)



Reverse Bevel Edge (S7)

	D	W	H	CTN WT	CU FT	① Model	Eased Edge (R3)		Reverse Bevel Edge (K9)		Standard
							Flat Cut	Double Cut	Flat Cut	Double Cut	
VENEER	36	72	42	146	57	NSV3672-42TTRX	\$2,742	\$2,934	\$2,822	\$3,003	--
	30	72	42	129	33	NSV3072-42TTRX	\$2,581	\$2,750	\$2,652	\$2,808	--
SOL SURF	36	72	42	179	57	NSS3672-42TTRX	--	--	--	--	\$5,770
	30	72	42	155	33	NSS3072-42TTRX	--	--	--	--	\$5,193

NOSH

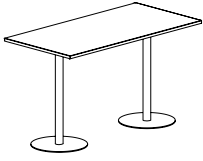
To Order Specify

① Veneer Model #	② Edge Detail	③ Wood Species	④ Wood Finish	⑤ Electrical Cut Out	⑥ Metal Finish
Veneer (NSV)	See Edge Detail Options	Flat Cut B01 Cherry CH1 Cherry MA1 Maple WA1 Walnut	See Flat Cut Wood Finish Options	N None CO_EC23 Cut out for EC23 CO_EC24 Cut out for EC24	See Metal Finish Options
		Double Cut DC2 Double Cut	④ Wood Finish See Double Cut Wood Finish Options		

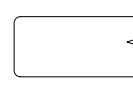
① Solid Surface Model #	② Edge Detail	③ Solid Surface	④ Electrical Cut Out	⑤ Metal Finish
Solid Surface (NSS)	See Edge Detail Options	See Solid Surface Options	N None CO_EC23 Cut out for EC23 CO_EC24 Cut out for EC24	See Metal Finish Options

Description

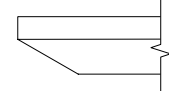
Rectangular Bar Height Table
with Round Disc Base



Laminate Tables "NST" Models



Eased Edge (R3)



Reverse Bevel Edge (K9)

LAMINATE	D	W	H	CTN WT	CU FT	① Model	Eased Edge (R3)			Reverse Bevel Edge (K9)		
							Standard	Graded In		Standard	Graded In	
							Tier 1	Tier 2	Tier 3	Tier 1	Tier 2	Tier 3
	36	72	42	199	63	NST3672-42TTR	\$2,609	\$2,673	\$2,794	\$3,024	\$3,085	\$3,207
	36	66	42	1191	58	NST3666-42TTR	\$2,464	\$2,536	\$2,648	\$2,879	\$2,949	\$3,060
	36	60	42	182	46	NST3660-42TTR	\$2,375	\$2,443	\$2,541	\$2,788	\$2,857	\$2,954
	30	72	42	160	33	NST3072-42TTR	\$2,377	\$2,445	\$2,542	\$2,791	\$2,858	\$2,955
	30	66	42	153	41	NST3066-42TTR	\$2,167	\$2,232	\$2,319	\$2,579	\$2,644	\$2,733
	30	60	42	146	36	NST3060-42TTR	\$2,096	\$2,157	\$2,235	\$2,508	\$2,570	\$2,648

Features:

- price reflects complete table - top and base
- ships KD in multiple cartons
- top has option for cutout to receive electrical component, ordered separately
- optional vertical wire manager for base, order separately
- base has anti-rock glides
- width of base foot varies from 17" or 22"

To Order Specify

① Laminate Model #	② Edge Detail	③ Laminate Selection	③a PVC Edge Color	④ Electrical Cut Out	⑤ Metal Finish
Laminate (NST)	See Edge Detail Options	See Laminate Detail Selection	See PVC Edge Color Options	N None CO_EC23 Cut out for EC23 CO_EC24 Cut out for EC24	See Metal Finish Options

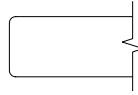
Model Number Breakdown

NST3660-42TTR					
NS	T	3660	42	TT	R
Nosh	Laminate	36" x 60"	Height	Rectangular Top Shape	Round Disc Base

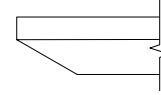
Description

Rectangular Bar Height Table
with Round Disc Base
(continued)

Veneer Tables
"NSV" Models



Eased Edge (R3)



Reverse Bevel Edge (K9)

VENEER	D	W	H	CTN WT	CU FT	1 Model	Flat Cut	Double Cut	Flat Cut	Double Cut
		36	72	42	199	63	NSV3672-42TTR	\$2,952	\$3,077	\$3,014
	36	66	42	1191	58	NSV3666-42TTR	\$2,860	\$2,974	\$2,932	\$3,032
	36	60	42	182	46	NSV3660-42TTR	\$2,774	\$2,875	\$2,841	\$2,929
	30	72	42	160	33	NSV3072-42TTR	\$2,743	\$2,924	\$2,808	\$2,976
	30	66	42	153	41	NSV3066-42TTR	\$2,536	\$2,651	\$2,594	\$2,699
	30	60	42	146	36	NSV3060-42TTR	\$2,470	\$2,575	\$2,525	\$2,621

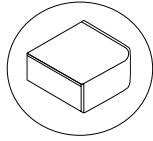
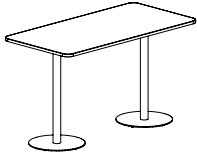
NOSH

To Order Specify

1 Veneer Model #	2 Edge Detail	3 Wood Species	4 Wood Finish	5 Electrical Cut Out	6 Metal Finish
Veneer (NSV)	See Edge Detail Options	Flat Cut B01 Cherry CH1 Cherry MA1 Maple WA1 Walnut	See Flat Cut Wood Finish Options	N None CO_EC23 Cut out for EC23 CO_EC24 Cut out for EC24	See Metal Finish Options
		Double Cut DC2 Double Cut	4 Wood Finish See Double Cut Wood Finish Options		

Description

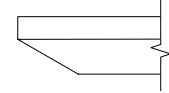
Rounded Rectangular Bar Height Table with Round Disc Base



Laminate Tables "NST" Models



Eased Edge (R3)



Reverse Bevel (K9)

LAMINATE	D	W	H	CTN WT	CU FT	① Model	Eased Edge (R3)			Reverse Bevel (K9)		
							Standard	Graded In		Standard	Graded In	
							Tier 1	Tier 2	Tier 3	Tier 1	Tier 2	Tier 3
	36	72	42	199	63	NST3672-42TTRR	\$2,838	\$2,918	\$3,037	\$3,250	\$3,332	\$3,449
	36	66	42	193	58	NST3666-42TTRR	\$2,493	\$2,564	\$2,676	\$2,905	\$2,977	\$3,089
	36	60	42	182	46	NST3660-42TTRR	\$2,431	\$2,498	\$2,621	\$2,843	\$2,910	\$3,033
	30	72	42	160	61	NST3072-42TTRR	\$2,470	\$2,537	\$2,634	\$2,883	\$2,950	\$3,048
	30	66	42	153	41	NST3066-42TTRR	\$2,407	\$2,475	\$2,560	\$2,821	\$2,887	\$2,974
	30	60	42	146	36	NST3060-42TTRR	\$2,354	\$2,415	\$2,493	\$2,767	\$2,829	\$2,905

Features:

- price reflects complete table - top and base
- ships KD in multiple cartons
- top has option for cutout to receive electrical component, ordered separately
- optional vertical wire manager for base, order separately
- base has anti-rock glides
- width of base foot varies from 17" or 22"

HSON

To Order Specify

① Laminate Model #	② Edge Detail	③ Laminate Selection	③a PVC Edge Color	④ Electrical Cut Out	⑤ Metal Finish
Laminate (NST)	See Edge Detail Options	See Laminate Detail Selection	See PVC Edge Color Options	N None CO_EC23 Cut out for EC23 CO_EC24 Cut out for EC24	See Metal Finish Options

Model Number Breakdown

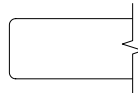
NST3666-42TTRR						
NS	T	3666	42	TT	R	R
Nosh	Laminate	36" x 66"	Height	Rectangular Top Shape	Rounded Corner	Round Disc Base

Description

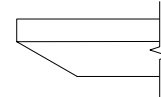
Rounded Rectangular Bar Height Table
with Round Disc Base
(continued)

Veneer Tables
"NSV" Models

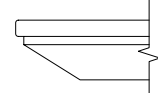
Solid Surface Tables
"NSS" Models



Eased Edge (R3)



Reverse Bevel Edge (K9)



Reverse Bevel Edge (S7)

	D	W	H	CTN WT	CU FT	① Model	Eased Edge (R3)		Reverse Bevel Edge (K9)		Standard
							Flat Cut	Double Cut	Flat Cut	Double Cut	
VENEER	36	72	42	199	63	NSV3672-42TTRR	\$3,181	\$3,304	\$3,251	\$3,362	--
	36	66	42	193	58	NSV3666-42TTRR	\$2,882	\$2,991	\$2,946	\$3,049	--
	36	60	42	182	46	NSV3660-42TTRR	\$2,823	\$2,924	\$2,886	\$2,976	--
	30	72	42	160	61	NSV3072-42TTRR	\$2,826	\$2,952	\$2,898	\$3,010	--
	30	66	42	153	41	NSV3066-42TTRR	\$2,771	\$2,886	\$2,828	\$2,933	--
	30	60	42	146	36	NSV3060-42TTRR	\$2,721	\$2,824	\$2,783	\$2,878	--
SOLID SURFACE	36	72	42	232	63	NSS3672-42TTRR	--	--	--	--	\$6,124
	36	66	42	221	58	NSS3666-42TTRR	--	--	--	--	\$5,614
	36	60	42	210	46	NSS3660-42TTRR	--	--	--	--	\$5,348
	30	72	42	186	61	NSS3072-42TTRR	--	--	--	--	\$5,354
	30	66	42	175	41	NSS3066-42TTRR	--	--	--	--	\$5,121
	30	60	42	167	36	NSS3060-42TTRR	--	--	--	--	\$4,897

NOSH

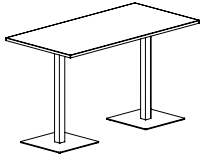
To Order Specify

① Veneer Model #	② Edge Detail	③ Wood Species	④ Wood Finish	⑤ Electrical Cut Out	⑥ Metal Finish
Veneer (NSV)	See Edge Detail Options	Flat Cut B01 Cherry CH1 Cherry MA1 Maple WA1 Walnut	See Flat Cut Wood Finish Options	N None CO_EC23 Cut out for EC23 CO_EC24 Cut out for EC24	See Metal Finish Options
		Double Cut DC2 Double Cut	④ Wood Finish See Double Cut Wood Finish Options		

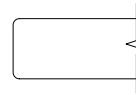
① Solid Surface Model #	② Edge Detail	③ Solid Surface	④ Electrical Cut Out	⑤ Metal Finish
Solid Surface (NSS)	See Edge Detail Options	See Solid Surface Options	N None CO_EC23 Cut out for EC23 CO_EC24 Cut out for EC24	See Metal Finish Options

Description

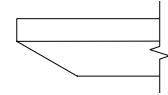
Rectangular Bar Height Table with Square Disc Base



Laminate Tables "NST" Models



Eased Edge (R3)



Reverse Bevel Edge (K9)

LAMINATE	D	W	H	CTN WT	CU FT	① Model	Eased Edge (R3)			Reverse Bevel Edge (K9)		
							Standard	Graded In		Standard	Graded In	
							Tier 1	Tier 2	Tier 3	Tier 1	Tier 2	Tier 3
	36	72	42	199	63	NST3672-42TTS	\$2,889	\$2,951	\$3,074	\$3,301	\$3,364	\$3,487
	36	66	42	191	58	NST3666-42TTS	\$2,743	\$2,815	\$2,928	\$3,157	\$3,229	\$3,341
	36	60	42	182	46	NST3660-42TTS	\$2,653	\$2,723	\$2,821	\$3,065	\$3,136	\$3,233
	30	72	42	159	61	NST3072-42TTS	\$2,655	\$2,725	\$2,822	\$3,071	\$3,137	\$3,234
	30	66	42	153	41	NST3066-42TTS	\$2,447	\$2,511	\$2,599	\$2,859	\$2,924	\$3,011
	30	60	42	146	36	NST3060-42TTS	\$2,376	\$2,437	\$2,515	\$2,790	\$2,849	\$2,928

Features:

- price reflects complete table - top and base
- ships KD in multiple cartons
- top has option for cut out to receive electrical component, order separately
- optional vertical wire manager for base, order separately
- base has anti-rock glides
- width of base foot varies from 17" or 22"

HSON

To Order Specify

① Laminate Model #	② Edge Detail	③ Laminate Selection	③a PVC Edge Color	④ Electrical Cut Out	⑤ Metal Finish
Laminate (NST)	See Edge Detail Options	See Laminate Detail Selection	See PVC Edge Color Options	N None CO_EC23 Cut out for EC23 CO_EC24 Cut out for EC24	See Metal Finish Options

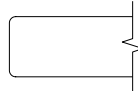
Model Number Breakdown

NST3066-42TTS					
NS	T	3066	42	TT	S
Nosh	Laminate	30" x 66"	Height	Rectangular Top Shape	Square Disc Base

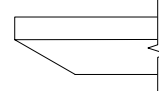
Description

Rectangular Bar Height Table
with Square Disc Base
(continued)

Veneer Tables
"NSV" Models



Eased Edge (R3)



Reverse Bevel Edge (K9)

VENEER	D	W	H	CTN WT	CU FT	1 Model	Flat Cut	Double Cut	Flat Cut	Double Cut
		36	72	42	199	63	NSV3672-42TTS	\$3,232	\$3,355	\$3,295
	36	66	42	191	58	NSV3666-42TTS	\$3,139	\$3,252	\$3,210	\$3,311
	36	60	42	182	46	NSV3660-42TTS	\$3,053	\$3,153	\$3,122	\$3,208
	30	72	42	159	61	NSV3072-42TTS	\$3,025	\$3,203	\$3,087	\$3,255
	30	66	42	153	41	NSV3066-42TTS	\$2,815	\$2,932	\$2,875	\$2,979
	30	60	42	146	36	NSV3060-42TTS	\$2,749	\$2,854	\$2,804	\$2,899

NOSH

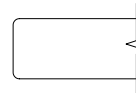
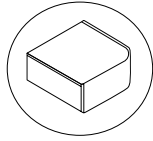
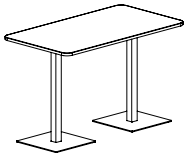
To Order Specify

1 Veneer Model #	2 Edge Detail	3 Wood Species	4 Wood Finish	5 Electrical Cut Out	6 Metal Finish
Veneer (NSV)	See Edge Detail Options	Flat Cut B01 Cherry CH1 Cherry MA1 Maple WA1 Walnut	See Flat Cut Wood Finish Options	N None CO_EC23 Cut out for EC23 CO_EC24 Cut out for EC24	See Metal Finish Options
		Double Cut DC2 Double Cut	4 Wood Finish See Double Cut Wood Finish Options		

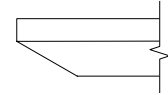
Description

Rounded Rectangular Bar Height Table with Square Disc Base

Laminate Tables "NST" Models



Eased Edge (R3)



Reverse Bevel (K9)

LAMINATE	D	W	H	CTN WT	CU FT	① Model	Eased Edge (R3)			Reverse Bevel (K9)		
							Standard	Graded In		Standard	Graded In	
							Tier 1	Tier 2	Tier 3	Tier 1	Tier 2	Tier 3
	36	72	42	221	63	NST3672-42TTRS	\$3,115	\$3,198	\$3,316	\$3,531	\$3,611	\$3,729
	36	66	42	213	58	NST3666-42TTRS	\$2,773	\$2,843	\$2,955	\$3,185	\$3,256	\$3,369
	36	60	42	205	46	NST3660-42TTRS	\$2,711	\$2,777	\$2,899	\$3,124	\$3,190	\$3,312
	30	72	42	172	61	NST3072-42TTRS	\$2,749	\$2,816	\$2,913	\$3,161	\$3,230	\$3,327
	30	66	42	165	41	NST3066-42TTRS	\$2,688	\$2,753	\$2,840	\$3,100	\$3,166	\$3,252
	30	60	42	158	36	NST3060-42TTRS	\$2,634	\$2,696	\$2,773	\$3,048	\$3,108	\$3,185

Features:

- price reflects complete table - top and base
- ships KD in multiple cartons
- top has option for cut out to receive electrical component, order separately
- optional vertical wire manager for base, order separately
- base has anti-rock glides
- width of base foot varies from 17" or 22"

HSOON

To Order Specify

① Laminate Model #	② Edge Detail	③ Laminate Selection	③a PVC Edge Color	④ Electrical Cut Out	⑤ Metal Finish
Laminate (NST)	See Edge Detail Options	See Laminate Detail Selection	See PVC Edge Color Options	N None CO_EC23 Cut out for EC23 CO_EC24 Cut out for EC24	See Metal Finish Options

Model Number Breakdown

NST3060-42TTRS						
NS	T	3060	42	TT	R	S
Nosh	Laminate	30" x 60"	Height	Rectangular Top Shape	Rounded Corner	Sqaure Disc Base

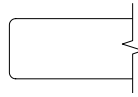
NS128 Nosh

Description

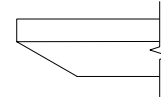
Rounded Rectangular Bar Height Table
with Square Disc Base
(continued)

Veneer Tables
"NSV" Models

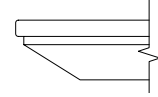
Solid Surface Tables
"NSS" Models



Eased Edge (R3)



Reverse Bevel Edge (K9)



Reverse Bevel Edge (S7)

	D	W	H	CTN WT	CU FT	① Model	Veneer Tables "NSV" Models		Solid Surface Tables "NSS" Models		
							Flat Cut	Double Cut	Flat Cut	Double Cut	Standard
VENEER	36	72	42	221	63	NSV3672-42TTRS	\$3,460	\$3,584	\$3,532	\$3,642	--
	36	66	42	213	58	NSV3666-42TTRS	\$3,160	\$3,272	\$3,226	\$3,329	--
	36	60	42	205	46	NSV3660-42TTRS	\$3,102	\$3,203	\$3,164	\$3,255	--
	30	72	42	172	61	NSV3072-42TTRS	\$3,106	\$3,232	\$3,178	\$3,290	--
	30	66	42	165	41	NSV3066-42TTRS	\$3,050	\$3,164	\$3,107	\$3,211	--
	30	60	42	158	36	NSV3060-42TTRS	\$3,000	\$3,103	\$3,061	\$3,156	--
SOLID SURFACE	36	72	42	255	63	NSS3672-42TTRS	--	--	--	--	\$6,404
	36	66	42	243	58	NSS3666-42TTRS	--	--	--	--	\$5,894
	36	60	42	132	46	NSS3660-42TTRS	--	--	--	--	\$5,627
	30	72	42	197	61	NSS3072-42TTRS	--	--	--	--	\$5,633
	30	66	42	188	41	NSS3066-42TTRS	--	--	--	--	\$5,400
	30	60	42	179	36	NSS3060-42TTRS	--	--	--	--	\$5,176

NOSH

To Order Specify

① Veneer Model #	② Edge Detail	③ Wood Species	④ Wood Finish	⑤ Electrical Cut Out	⑥ Metal Finish
Veneer (NSV)	See Edge Detail Options	Flat Cut B01 Cherry CH1 Cherry MA1 Maple WA1 Walnut	See Flat Cut Wood Finish Options	N None CO_EC23 Cut out for EC23 CO_EC24 Cut out for EC24	See Metal Finish Options
		Double Cut DC2 Double Cut	④ Wood Finish See Double Cut Wood Finish Options		

① Solid Surface Model #	② Edge Detail	③ Solid Surface	④ Electrical Cut Out	⑤ Metal Finish
Solid Surface (NSS)	See Edge Detail Options	See Solid Surface Options	N None CO_EC23 Cut out for EC23 CO_EC24 Cut out for EC24	See Metal Finish Options

Nosh - 42" h Tables

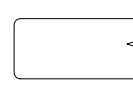


Description

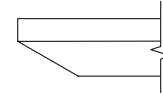
Round Bar Height Table with X Base



Laminate Tables "NST" Models



Eased Edge (R3)



Reverse Bevel Edge (K9)

LAMINATE	D	W	H	CTN WT	CU FT	① Model	Eased Edge (R3)			Reverse Bevel Edge (K9)		
							Standard	Graded In		Standard	Graded In	
							Tier 1	Tier 2	Tier 3	Tier 1	Tier 2	Tier 3
	48	N/A	42	90	28	NST48-42RDX	\$1,538	\$1,647	\$1,768	\$1,951	\$2,060	\$2,180
	42	N/A	42	75	23	NST42-42RDX	\$1,415	\$1,522	\$1,610	\$1,829	\$1,936	\$2,023
	36	N/A	42	61	19	NST36-42RDX	\$1,374	\$1,413	\$1,474	\$1,786	\$1,827	\$1,890
	30	N/A	42	50	21	NST30-42RDX	\$1,326	\$1,359	\$1,396	\$1,740	\$1,772	\$1,808

Features:

- price reflects complete table - top and base
- ships KD in multiple cartons
- top has option for cutout to receive electrical component, ordered separately
- when electrical cut out selected, power accessible base is sent - add \$111
- optional vertical wire manager for base, order separately
- base has leveling glides
- width of base foot varies from 32" to 38"

HSON

To Order Specify

① Laminate Model #	② Edge Detail	③ Laminate Selection	③a PVC Edge Color	④ Electrical Cut Out	⑤ Metal Finish
Laminate (NST)	See Edge Detail Options	See Laminate Detail Selection	See PVC Edge Color Options	N None CO_EC23 Cut out for EC23 CO_EC24 Cut out for EC24	See Metal Finish Options

Model Number Breakdown

NST48-42RDX					
NS	T	48	42	RD	X
Nosh	Laminate	48" Diameter	Height	Round Top Shape	X base

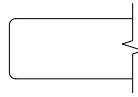
NS130 Nosh

Description

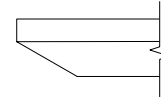
Round Bar Height Table with X Base
(continued)

Veneer Tables
"NSV" Models

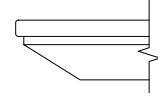
Solid Surface Tables
"NSS" Models



Eased Edge (R3)



Reverse Bevel Edge (K9)



Reverse Bevel Edge (S7)

	D	W	H	CTN WT	CU FT	① Model	Eased Edge (R3)		Reverse Bevel Edge (K9)		Standard
							Flat Cut	Double Cut	Flat Cut	Double Cut	
VENEER	48	N/A	42	90	28	NSV48-42RDX	\$2,023	\$2,156	\$2,098	\$2,239	--
	42	N/A	42	75	23	NSV42-42RDX	\$1,857	\$1,980	\$1,927	\$2,054	--
	36	N/A	42	61	19	NSV36-42RDX	\$1,800	\$1,920	\$1,871	\$1,993	--
	30	N/A	42	50	21	NSV30-42RDX	\$1,738	\$1,853	\$1,804	\$1,922	--
SOLID SURFACE	48	N/A	42	120	28	NSS48-42RDX	--	--	--	--	\$4,691
	42	N/A	42	98	23	NSS42-42RDX	--	--	--	--	\$4,001
	36	N/A	42	78	19	NSS36-42RDX	--	--	--	--	\$3,492
	30	N/A	42	61	21	NSS30-42RDX	--	--	--	--	\$3,041

NOSH

To Order Specify

① Veneer Model #	② Edge Detail	③ Wood Species	④ Wood Finish	⑤ Electrical Cut Out	⑥ Metal Finish
Veneer (NSV)	See Edge Detail Options	Flat Cut B01 Cherry CH1 Cherry MA1 Maple WA1 Walnut	See Flat Cut Wood Finish Options	N None CO_EC23 Cut out for EC23 CO_EC24 Cut out for EC24	See Metal Finish Options
		Double Cut DC2 Double Cut	④ Wood Finish See Double Cut Wood Finish Options		

① Solid Surface Model #	② Edge Detail	③ Solid Surface	④ Electrical Cut Out	⑤ Metal Finish
Solid Surface (NSS)	See Edge Detail Options	See Solid Surface Options	N None CO_EC23 Cut out for EC23 CO_EC24 Cut out for EC24	See Metal Finish Options

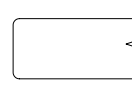
Nosh - 42" h Tables



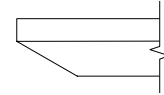
Description

Round Bar Height Table with X4 Base

Laminate Tables "NST" Models



Eased Edge (R3)



Reverse Bevel Edge (K9)

LAMINATE	D	W	H	CTN WT	CU FT	1 Model	Eased Edge (R3)			Reverse Bevel Edge (K9)		
							Standard	Graded In		Standard	Graded In	
							Tier 1	Tier 2	Tier 3	Tier 1	Tier 2	Tier 3
	60	N/A	42	154	50	NST60-42RDZ	\$2,551	\$2,637	\$2,825	\$2,964	\$3,050	\$3,239
	54	N/A	42	71	15	NST54-42RDZ	\$2,389	\$2,454	\$2,520	\$2,801	\$2,866	\$2,933

Features:

- price reflects complete table - top and base
- ships KD in multiple cartons
- top has option for cut out to receive electrical component, order separately
- optional vertical wire manager for base, order separately
- base has leveling glides
- width of base foot is 38"

HSON

To Order Specify

1 Laminate Model #	2 Edge Detail	3 Laminate Selection	3a PVC Edge Color	4 Electrical Cut Out	5 Metal Finish
Laminate (NST)	See Edge Detail Options	See Laminate Detail Selection	See PVC Edge Color Options	N None CO_EC23 Cut out for EC23 CO_EC24 Cut out for EC24	See Metal Finish Options

Model Number Breakdown

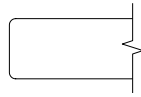
NSV54-42RDZ					
NS	V	54	42	RD	Z
Nosh	Veneer	54" Diameter	Height	Round Top Shape	X4 Base

NS132 Nosh

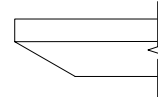
Description

Round Bar Height Table with X4 Base
(continued)

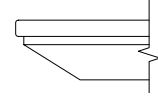
Veneer Tables "NSV" Models				Solid Surface Tables "NSS" Models	
-------------------------------	--	--	--	--------------------------------------	--



Eased Edge (R3)



Reverse Bevel Edge (K9)



Reverse Bevel Edge (S7)

	D	W	H	CTN WT	CU FT	1 Model	Eased Edge (R3)		Reverse Bevel Edge (K9)		Standard
							Flat Cut	Double Cut	Flat Cut	Double Cut	
VENEER	60	N/A	42	154	50	NSV60-42RDZ	\$3,341	\$3,558	\$3,464	\$3,693	--
	54	N/A	42	106	28	NSV54-42RDZ	\$3,161	\$3,375	\$3,284	\$3,506	--
SOL SURF	60	N/A	42	208	50	NSS60-42RDZ	--	--	--	--	\$7,263
	54	N/A	42	145	28	NSS54-42RDZ	--	--	--	--	\$6,422

NOSH

To Order Specify

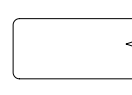
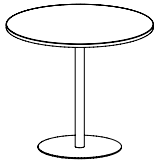
1 Veneer Model #	2 Edge Detail	3 Wood Species	4 Wood Finish	5 Electrical Cut Out	6 Metal Finish
Veneer (NSV)	See Edge Detail Options	Flat Cut B01 Cherry CH1 Cherry MA1 Maple WA1 Walnut	See Flat Cut Wood Finish Options	N None CO_EC23 Cut out for EC23 CO_EC24 Cut out for EC24	See Metal Finish Options
		Double Cut DC2 Double Cut	4 Wood Finish See Double Cut Wood Finish Options		

1 Solid Surface Model #	2 Edge Detail	3 Solid Surface	4 Electrical Cut Out	5 Metal Finish
Solid Surface (NSS)	See Edge Detail Options	See Solid Surface Options	N None CO_EC23 Cut out for EC23 CO_EC24 Cut out for EC24	See Metal Finish Options

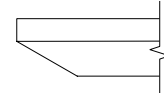
Description

Round Bar Height Table with Round Disc Base

Laminate Tables "NST" Models



Eased Edge (R3)



Reverse Bevel Edge (K9)

LAMINATE	D	W	H	CTN WT	CU FT	① Model	Eased Edge (R3)			Reverse Bevel Edge (K9)		
							Standard	Graded In		Standard	Graded In	
							Tier 1	Tier 2	Tier 3	Tier 1	Tier 2	Tier 3
	48	N/A	42	133	28	NST48-42RDR	\$1,773	\$1,830	\$1,948	\$2,185	\$2,242	\$2,362
	42	N/A	42	118	21	NST42-42RDR	\$1,622	\$1,671	\$1,756	\$2,034	\$2,084	\$2,170
	36	N/A	42	88	20	NST36-42RDR	\$1,390	\$1,432	\$1,492	\$1,804	\$1,845	\$1,904
	30	N/A	42	65	15	NST30-42RDR	\$1,198	\$1,233	\$1,269	\$1,611	\$1,646	\$1,681

Features:

- price reflects complete table - top and base
- ships KD in multiple cartons
- cut out for power is not available on these tables
- base has anti-rock glides
- width of base foot varies from 22" or 27"

HSON

To Order Specify

① Laminate Model #	② Edge Detail	③ Laminate Selection	③a PVC Edge Color	④ Metal Finish
Laminate (NST)	See Edge Detail Options	See Laminate Detail Selection	See PVC Edge Color Options	See Metal Finish Options

Model Number Breakdown

NST30-42RDR					
NS	V	30	42	RD	R
Nosh	Veneer	30" Diameter	Height	Round Top Shape	Round Disc Base

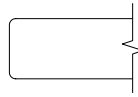
NS134 Nosh

Description

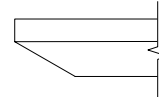
Round Bar Height Table with Round Disc Base
(continued)

Veneer Tables
"NSV" Models

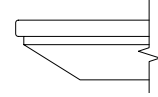
Solid Surface Tables
"NSS" Models



Eased Edge (R3)



Reverse Bevel Edge (K9)



Reverse Bevel Edge (S7)

	D	W	H	CTN WT	CU FT	① Model	Eased Edge (R3)		Reverse Bevel Edge (K9)		Reverse Bevel Edge (S7) Standard
							Flat Cut	Double Cut	Flat Cut	Double Cut	
VENEER	48	N/A	42	133	28	NSV48-42RDR	\$2,211	\$2,365	\$2,301	\$2,460	--
	42	N/A	42	118	21	NSV42-42RDR	\$2,008	\$2,150	\$2,090	\$2,238	--
	36	N/A	42	88	20	NSV36-42RDR	\$1,700	\$1,820	\$1,770	\$1,894	--
	30	N/A	42	65	15	NSV30-42RDR	\$1,443	\$1,543	\$1,500	\$1,606	--
SOLID SURFACE	48	N/A	42	163	28	NSS48-42RDR	--	--	--	--	\$4,993
	42	N/A	42	141	21	NSS42-42RDR	--	--	--	--	\$4,266
	36	N/A	42	104	20	NSS36-42RDR	--	--	--	--	\$3,505
	30	N/A	42	76	15	NSS30-42RDR	--	--	--	--	\$2,860

NSH

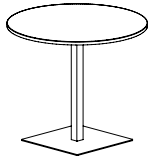
To Order Specify

① Veneer Model #	② Edge Detail	③ Wood Species	④ Wood Finish	⑤ Electrical Cut Out	⑥ Metal Finish
Veneer (NSV)	See Edge Detail Options	Flat Cut B01 Cherry CH1 Cherry MA1 Maple WA1 Walnut	See Flat Cut Wood Finish Options	N None CO_EC23 Cut out for EC23 CO_EC24 Cut out for EC24	See Metal Finish Options
		Double Cut DC2 Double Cut	④ Wood Finish See Double Cut Wood Finish Options		

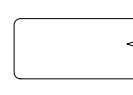
① Solid Surface Model #	② Edge Detail	③ Solid Surface	④ Electrical Cut Out	⑤ Metal Finish
Solid Surface (NSS)	See Edge Detail Options	See Solid Surface Options	N None CO_EC23 Cut out for EC23 CO_EC24 Cut out for EC24	See Metal Finish Options

Description

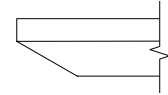
Round Bar Height Table
with Square Disc Base



Laminate Tables "NST" Models



Eased Edge (R3)



Reverse Bevel (K9)

LAMINATE	D	W	H	CTN WT	CU FT	① Model	Eased Edge (R3)			Reverse Bevel (K9)		
							Standard	Graded In		Standard	Graded In	
							Tier 1	Tier 2	Tier 3	Tier 1	Tier 2	Tier 3
	48	N/A	42	149	28	NST48-42RDS	\$1,976	\$2,032	\$2,151	\$2,388	\$2,445	\$2,564
	42	N/A	42	134	21	NST42-42RDS	\$1,824	\$1,873	\$1,959	\$2,237	\$2,286	\$2,373
	36	N/A	42	99	20	NST36-42RDS	\$1,532	\$1,572	\$1,632	\$1,944	\$1,985	\$2,044
	30	N/A	42	71	15	NST30-42RDS	\$1,338	\$1,372	\$1,408	\$1,750	\$1,785	\$1,821

Features:

- price reflects complete table - top and base
- ships KD in multiple cartons
- cut out for power is not available on these tables
- width of base foot varies from 17" to 27"

HSON

To Order Specify

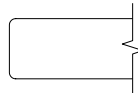
① Laminate Model #	② Edge Detail	③ Laminate Selection	③a PVC Edge Color	④ Metal Finish
Laminate (NST)	See Edge Detail Options	See Laminate Detail Selection	See PVC Edge Color Options	See Metal Finish Options

NST48-42RDS					
NS	T	48	42	RD	S
Nosh	Laminate	48" Diameter	Height	Round Top Shape	Square Disc Base

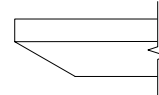
Description

Round Bar Height Table
with Square Disc Base
(continued)

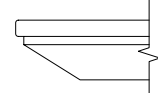
Veneer Tables "NSV" Models Solid Surface Tables "NSS" Models



Eased Edge (R3)



Reverse Bevel Edge (K9)



Reverse Bevel Edge (S7)

	D	W	H	CTN WT	CU FT	① Model	Eased Edge (R3)		Reverse Bevel Edge (K9)		Standard
							Flat Cut	Double Cut	Flat Cut	Double Cut	
VENEER	48	N/A	42	149	28	NSV48-42RDS	\$2,598	\$2,772	\$2,697	\$2,880	--
	42	N/A	42	134	21	NSV42-42RDS	\$2,394	\$2,554	\$2,485	\$2,651	--
	36	N/A	42	99	20	NSV36-42RDS	\$2,002	\$2,135	\$2,078	\$2,218	--
	30	N/A	42	71	15	NSV30-42RDS	\$1,744	\$1,857	\$1,809	\$1,929	--
SOLID SURFACE	48	N/A	42	178	28	NSS48-42RDS	--	--	--	--	\$5,264
	42	N/A	42	156	21	NSS42-42RDS	--	--	--	--	\$4,537
	36	N/A	42	115	20	NSS36-42RDS	--	--	--	--	\$3,693
	30	N/A	42	82	15	NSS30-42RDS	--	--	--	--	\$3,048

NOSH

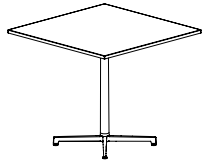
To Order Specify

① Veneer Model #	② Edge Detail	③ Wood Species	④ Wood Finish	⑤ Electrical Cut Out	⑥ Metal Finish
Veneer (NSV)	See Edge Detail Options	Flat Cut B01 Cherry CH1 Cherry MA1 Maple WA1 Walnut	See Flat Cut Wood Finish Options	N None CO_EC23 Cut out for EC23 CO_EC24 Cut out for EC24	See Metal Finish Options
		Double Cut DC2 Double Cut	④ Wood Finish See Double Cut Wood Finish Options		

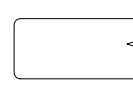
① Solid Surface Model #	② Edge Detail	③ Solid Surface	④ Electrical Cut Out	⑤ Metal Finish
Solid Surface (NSS)	See Edge Detail Options	See Solid Surface Options	N None CO_EC23 Cut out for EC23 CO_EC24 Cut out for EC24	See Metal Finish Options

Description

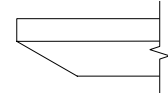
Square Bar Height Table with X Base



Laminate Tables "NST" Models



Eased Edge (R3)



Reverse Bevel Edge (K9)

LAMINATE	D	W	H	CTN WT	CU FT	① Model	Eased Edge (R3)			Reverse Bevel Edge (K9)		
							Standard	Graded In		Standard	Graded In	
							Tier 1	Tier 2	Tier 3	Tier 1	Tier 2	Tier 3
	42	42	42	88	23	NST4242-42SQX	\$1,449	\$1,496	\$1,611	\$1,864	\$1,908	\$2,024
	36	36	42	72	18	NST3636-42SQX	\$1,291	\$1,328	\$1,357	\$1,704	\$1,743	\$1,770
	30	30	42	58	18	NST3030-42SQX	\$1,164	\$1,195	\$1,208	\$1,576	\$1,607	\$1,622

Features:

- price reflects complete table - top and base
- ships KD in multiple cartons
- top has option for cutout to receive electrical component, ordered separately
- when electrical cut out selected, power accessible base is sent - add \$111
- base has leveling glides
- width of base foot varies from 26" to 38"

HSON

To Order Specify

① Laminate Model #	② Edge Detail	③ Laminate Selection	③a PVC Edge Color	④ Electrical Cut Out	⑤ Metal Finish
Laminate (NST)	See Edge Detail Options	See Laminate Detail Selection	See PVC Edge Color Options	N None CO_EC23 Cut out for EC23 CO_EC24 Cut out for EC24	See Metal Finish Options

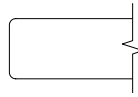
Model Number Breakdown

NST4242-42SQX					
NS	T	4242	42	SQ	X
Nosh	Laminate	42" x 42"	Height	Square Top Shape	X Base

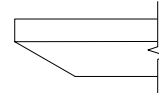
Description

Square Bar Height Table with X Base
(continued)

Veneer Tables
"NSV" Models



Eased Edge (R3)



Reverse Bevel Edge (K9)

VENEER	D	W	H	CTN WT	CU FT	1 Model	Flat Cut	Double Cut	Flat Cut	Double Cut
	42	42	42	88	23	NSV4242-42SQX	\$1,877	\$2,000	\$1,947	\$2,076
36	36	42	72	18	NSV3636-42SQX	\$1,667	\$1,777	\$1,730	\$1,842	
30	30	42	58	18	NSV3030-42SQX	\$1,497	\$1,595	\$1,554	\$1,656	

NOSH

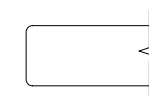
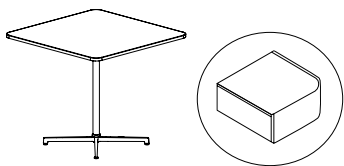
To Order Specify

1 Veneer Model #	2 Edge Detail	3 Wood Species	4 Wood Finish	5 Electrical Cut Out	6 Metal Finish
Veneer (NSV)	See Edge Detail Options	Flat Cut B01 Cherry CH1 Cherry MA1 Maple WA1 Walnut	See Flat Cut Wood Finish Options	N None CO_EC23 Cut out for EC23 CO_EC24 Cut out for EC24	See Metal Finish Options
		Double Cut DC2 Double Cut	4 Wood Finish See Double Cut Wood Finish Options		

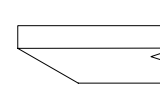
Description

Rounded Square Bar Height Table with X Base

Laminate Tables "NST" Models



Eased Edge (R3)



Reverse Bevel (K9)

LAMINATE	D	W	H	CTN WT	CU FT	① Model	Eased Edge (R3)			Reverse Bevel (K9)		
							Standard	Graded In		Standard	Graded In	
							Tier 1	Tier 2	Tier 3	Tier 1	Tier 2	Tier 3
	42	42	42	88	23	NST4242-42SQRX	\$1,773	\$1,821	\$1,981	\$2,185	\$2,234	\$2,394
	36	36	42	71	18	NST3636-42SQRX	\$1,484	\$1,522	\$1,582	\$1,896	\$1,936	\$1,995
	30	30	42	56	18	NST3030-42SQRX	\$1,330	\$1,364	\$1,400	\$1,744	\$1,777	\$1,812

Features:

- price reflects complete table - top and base
- ships KD in multiple cartons
- top has option for cutout to receive electrical component, ordered separately
- when electrical cut out selected, power accessible base is sent - add \$111
- base has leveling glides
- width of base foot varies from 26" to 38"

HSON

To Order Specify

① Laminate Model #	② Edge Detail	③ Laminate Selection	③a PVC Edge Color	④ Electrical Cut Out	⑤ Metal Finish
Laminate (NST)	See Edge Detail Options	See Laminate Detail Selection	See PVC Edge Color Options	N None CO_EC23 Cut out for EC23 CO_EC24 Cut out for EC24	See Metal Finish Options

Model Number Breakdown

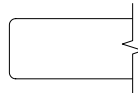
NST4242-42SQRX						
NS	T	4242	42	SQ	R	X
Nosh	Laminate	42" x 42"	Height	Square Top Shape	Rounded Corner	X base

Description

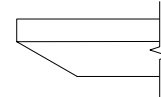
Rounded Square Bar Height Table
with X Base
(continued)

Veneer Tables
"NSV" Models

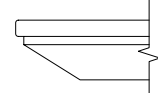
Solid Surface Tables
"NSS" Models



Eased Edge (R3)



Reverse Bevel Edge (K9)



Reverse Bevel Edge (S7)

	D	W	H	CTN WT	CU FT	① Model	Eased Edge (R3)		Reverse Bevel Edge (K9)		Standard
							Flat Cut	Double Cut	Flat Cut	Double Cut	
VENEER	42	42	42	88	23	NSV4242-42SQRX	\$2,311	\$2,464	\$2,400	\$2,560	--
	36	36	42	71	18	NSV3636-42SQRX	\$1,920	\$2,046	\$1,992	\$2,125	--
	30	30	42	56	18	NSV3030-42SQRX	\$1,720	\$1,832	\$1,784	\$1,900	--
SOL SURF	42	42	42	117	23	NSS4242-42SQRX	--	--	--	--	\$4,454
	36	36	42	93	18	NSS3636-42SQRX	--	--	--	--	\$3,610
	30	30	42	70	18	NSS3030-42SQRX	--	--	--	--	\$3,024

NOSH

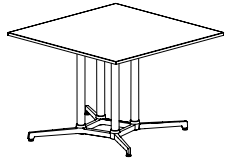
To Order Specify

① Veneer Model #	② Edge Detail	③ Wood Species	④ Wood Finish	⑤ Electrical Cut Out	⑥ Metal Finish
Veneer (NSV)	See Edge Detail Options	Flat Cut B01 Cherry CH1 Cherry MA1 Maple WA1 Walnut	See Flat Cut Wood Finish Options	N None CO_EC23 Cut out for EC23 CO_EC24 Cut out for EC24	See Metal Finish Options
		Double Cut DC2 Double Cut	④ Wood Finish See Double Cut Wood Finish Options		

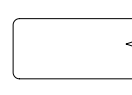
① Solid Surface Model #	② Edge Detail	③ Solid Surface	④ Electrical Cut Out	⑤ Metal Finish
Solid Surface (NSS)	See Edge Detail Options	See Solid Surface Options	N None CO_EC23 Cut out for EC23 CO_EC24 Cut out for EC24	See Metal Finish Options

Description

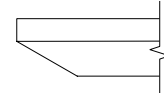
Square Bar Height Table with X4 Base



Laminate Tables "NST" Models



Eased Edge (R3)



Reverse Bevel Edge (K9)

LAMINATE	D	W	H	CTN WT	CU FT	① Model	Eased Edge (R3)			Reverse Bevel Edge (K9)		
							Standard	Graded In		Standard	Graded In	
							Tier 1	Tier 2	Tier 3	Tier 1	Tier 2	Tier 3
	60	60	42	163	50	NST6060-42SQZ	\$2,896	\$2,979	\$3,170	\$3,308	\$3,393	\$3,584
	54	54	42	186	43	NST5454-42SQZ	\$2,759	\$2,834	\$2,982	\$3,172	\$3,246	\$3,394
	48	48	42	142	68	NST4848-42SQZ	\$2,302	\$2,352	\$2,477	\$2,714	\$2,764	\$2,889

Features:

- price reflects complete table - top and base
- ships KD in multiple cartons
- top has option for cut out to receive electrical component, order separately
- optional vertical wire manager for base, order separately
- base has leveling glides
- width of base foot is 38"

HSON

To Order Specify

① Laminate Model #	② Edge Detail	③ Laminate Selection	③a PVC Edge Color	④ Electrical Cut Out	⑤ Metal Finish
Laminate (NST)	See Edge Detail Options	See Laminate Detail Selection	See PVC Edge Color Options	N None CO_EC23 Cut out for EC23 CO_EC24 Cut out for EC24	See Metal Finish Options

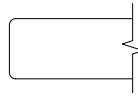
Model Number Breakdown

NST6060-42SQZ					
NS	T	6060	42	SQ	Z
Nosh	Laminate	60" x 60"	Height	Square Top Shape	X4 base

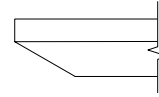
Description

Square Bar Height Table with X4 Base
(continued)

Veneer Tables
"NSV" Models



Eased Edge (R3)



Reverse Bevel Edge (K9)

VENEER	D	W	H	CTN WT	CU FT	1 Model	Flat Cut	Double Cut	Flat Cut	Double Cut
	60	60	42	163	50	NSV6060-42SQZ	\$3,748	\$3,995	\$3,889	\$4,146
54	54	42	186	43	NSV5454-42SQZ	\$3,567	\$3,802	\$3,702	\$3,946	
48	48	42	142	68	NSV4848-42SQZ	\$2,767	\$2,902	\$2,845	\$2,986	

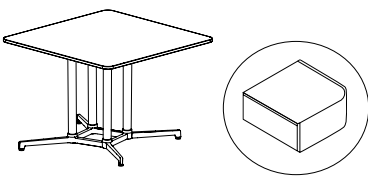
NOSH

To Order Specify

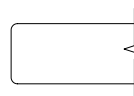
1 Veneer Model #	2 Edge Detail	3 Wood Species	4 Wood Finish	5 Electrical Cut Out	6 Metal Finish
Veneer (NSV)	See Edge Detail Options	Flat Cut B01 Cherry CH1 Cherry MA1 Maple WA1 Walnut	See Flat Cut Wood Finish Options	N None CO_EC23 Cut out for EC23 CO_EC24 Cut out for EC24	See Metal Finish Options
		Double Cut DC2 Double Cut	4 Wood Finish See Double Cut Wood Finish Options		

Description

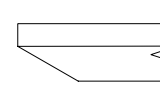
Rounded Square Bar Height Table with X4 Base



Laminate Tables "NST" Models



Eased Edge (R3)



Reverse Bevel (K9)

LAMINATE	D	W	H	CTN WT	CU FT	① Model	Eased Edge (R3)			Reverse Bevel (K9)		
							Standard	Graded In		Standard	Graded In	
							Tier 1	Tier 2	Tier 3	Tier 1	Tier 2	Tier 3
	60	60	42	180	50	NST6060-42SQRZ	\$3,107	\$3,183	\$3,382	\$3,520	\$3,595	\$3,796
	54	54	42	157	43	NST5454-42SQRZ	\$2,579	\$2,653	\$2,801	\$2,991	\$3,065	\$3,214
	48	48	42	142	68	NST4848-42SQRZ	\$2,637	\$2,688	\$2,837	\$3,050	\$3,100	\$3,249

Features:

- price reflects complete table - top and base
- ships KD in multiple cartons
- top has option for cut out to receive electrical component, order separately
- optional vertical wire manager for base, order separately
- base has leveling glides
- width of base foot is 38"

HSON

To Order Specify

① Laminate Model #	② Edge Detail	③ Laminate Selection	③a PVC Edge Color	④ Electrical Cut Out	⑤ Metal Finish
Laminate (NST)	See Edge Detail Options	See Laminate Detail Selection	See PVC Edge Color Options	N None CO_EC23 Cut out for EC23 CO_EC24 Cut out for EC24	See Metal Finish Options

Model Number Breakdown

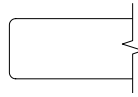
NST6060-42SQRZ						
NS	T	6060	42	SQ	R	Z
Nosh	Laminate	60" x 60"	Height	Square Top Shape	Rounded Corner	X4 base

Description

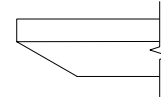
Rounded Square Bar Height Table
with X4 Base
(continued)

Veneer Tables
"NSV" Models

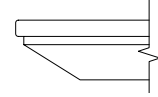
Solid Surface Tables
"NSS" Models



Eased Edge (R3)



Reverse Bevel Edge (K9)



Reverse Bevel Edge (S7)

	D	W	H	CTN WT	CU FT	1 Model	Eased Edge (R3)		Reverse Bevel Edge (K9)		Standard
							Flat Cut	Double Cut	Flat Cut	Double Cut	
VENEER	60	60	42	180	50	NSV6060-42SQRZ	\$4,029	\$4,295	\$4,182	\$4,458	--
	54	54	42	157	43	NSV5454-42SQRZ	\$3,332	\$3,548	\$3,457	\$3,682	--
	48	48	42	142	68	NSV4848-42SQRZ	\$3,209	\$3,376	\$3,305	\$3,478	--
SOL SURF	60	60	42	247	50	NSS6060-42SQRZ	--	--	--	--	\$7,953
	54	54	42	212	43	NSS5454-42SQRZ	--	--	--	--	\$6,592
	48	48	42	142	68	NSS4848-42SQRZ	--	--	--	--	\$5,148

NOSH

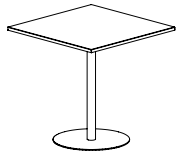
To Order Specify

1 Veneer Model #	2 Edge Detail	3 Wood Species	4 Wood Finish	5 Electrical Cut Out	6 Metal Finish
Veneer (NSV)	See Edge Detail Options	Flat Cut B01 Cherry CH1 Cherry MA1 Maple WA1 Walnut	See Flat Cut Wood Finish Options	N None CO_EC23 Cut out for EC23 CO_EC24 Cut out for EC24	See Metal Finish Options
		Double Cut DC2 Double Cut	4 Wood Finish See Double Cut Wood Finish Options		

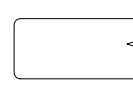
1 Solid Surface Model #	2 Edge Detail	3 Solid Surface	4 Electrical Cut Out	5 Metal Finish
Solid Surface (NSS)	See Edge Detail Options	See Solid Surface Options	N None CO_EC23 Cut out for EC23 CO_EC24 Cut out for EC24	See Metal Finish Options

Description

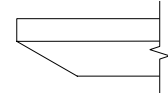
Square Bar Height Table with Round Disc Base



Laminate Tables "NST" Models



Eased Edge (R3)



Reverse Bevel Edge (K9)

LAMINATE	D	W	H	CTN WT	CU FT	① Model	Eased Edge (R3)			Reverse Bevel Edge (K9)		
							Standard	Graded In		Standard	Graded In	
							Tier 1	Tier 2	Tier 3	Tier 1	Tier 2	Tier 3
	42	42	42	131	21	NST4242-42SQR	\$1,326	\$1,374	\$1,414	\$1,740	\$1,786	\$1,828
	36	36	42	97	20	NST3636-42SQR	\$1,218	\$1,256	\$1,282	\$1,631	\$1,670	\$1,696
	30	30	42	84	16	NST3030-42SQR	\$1,158	\$1,192	\$1,204	\$1,572	\$1,605	\$1,618

Features:

- price reflects complete table - top and base
- ships KD in multiple cartons
- cut out for power is not available on these tables
- base has anti-rock glides
- width of base foot varies from 22" or 27"

HSON

To Order Specify

① Laminate Model #	② Edge Detail	③ Laminate Selection	③a PVC Edge Color	④ Metal Finish
Laminate (NST)	See Edge Detail Options	See Laminate Detail Selection	See PVC Edge Color Options	See Metal Finish Options

Model Number Breakdown

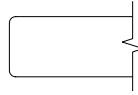
NST4242-42SQR					
NS	T	4242	42	SQ	R
Nosh	Laminate	42" x 42"	Height	Square Top Shape	Round Disc Base

NS146 Nosh

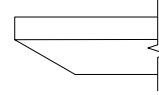
Description

Square Bar Height Table with Round Disc Base (continued)

Veneer Tables "NSV" Models



Eased Edge (R3)



Reverse Bevel Edge (K9)

VENEER	D	W	H	CTN WT	CU FT	1 Model	Flat Cut	Double Cut	Flat Cut	Double Cut
	42	42	42	131	21	NSV4242-42SQR	\$1,674	\$1,783	\$1,735	\$1,850
36	36	42	97	20	NSV3636-42SQR	\$1,531	\$1,629	\$1,586	\$1,689	
30	30	42	84	16	NSV3030-42SQR	\$1,452	\$1,546	\$1,507	\$1,605	

NOSH

To Order Specify

1 Veneer Model #	2 Edge Detail	3 Wood Species	4 Wood Finish	5 Electrical Cut Out	6 Metal Finish
Veneer (NSV)	See Edge Detail Options	Flat Cut B01 Cherry CH1 Cherry MA1 Maple WA1 Walnut	See Flat Cut Wood Finish Options	N None CO_EC23 Cut out for EC23 CO_EC24 Cut out for EC24	See Metal Finish Options
		Double Cut DC2 Double Cut	4 Wood Finish See Double Cut Wood Finish Options		

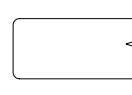
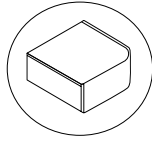
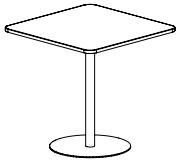
Nosh - 42" h Tables



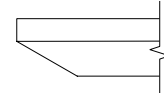
Description

Rounded Square Bar Height Table with Round Disc Base

Laminate Tables "NST" Models



Eased Edge (R3)



Reverse Bevel (K9)

LAMINATE	D	W	H	CTN WT	CU FT	① Model	Eased Edge (R3)			Reverse Bevel (K9)		
							Standard	Graded In		Standard	Graded In	
							Tier 1	Tier 2	Tier 3	Tier 1	Tier 2	Tier 3
	42	42	42	131	21	NST4242-42SQRR	\$1,649	\$1,698	\$1,784	\$2,063	\$2,110	\$2,196
	36	36	42	97	20	NST3636-42SQRR	\$1,409	\$1,449	\$1,508	\$1,822	\$1,864	\$1,921
	30	30	42	83	16	NST3030-42SQRR	\$1,326	\$1,362	\$1,397	\$1,740	\$1,774	\$1,809

Features:

- price reflects complete table - top and base
- ships KD in multiple cartons
- cut out for power is not available on these tables
- base has anti-rock glides
- width of base foot varies from 22" or 27"

HSON

To Order Specify

① Laminate Model #	② Edge Detail	③ Laminate Selection	③a PVC Edge Color	④ Metal Finish
Laminate (NST)	See Edge Detail Options	See Laminate Detail Selection	See PVC Edge Color Options	See Metal Finish Options

Model Number Breakdown

NST4242-42SQRR						
NS	T	4242	42	SQ	R	R
Nosh	Laminate	42" x 42"	Height	Square Top Shape	Rounded Corner	Round Disc Base

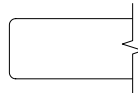
NS148 Nosh

Description

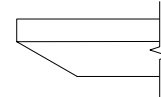
Rounded Square Bar Height Table with Round Disc Base
(continued)

Veneer Tables
"NSV" Models

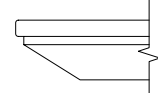
Solid Surface Tables
"NSS" Models



Eased Edge (R3)



Reverse Bevel Edge (K9)



Reverse Bevel Edge (S7)

	D	W	H	CTN WT	CU FT	① Model	Eased Edge (R3)		Reverse Bevel Edge (K9)		Standard
							Flat Cut	Double Cut	Flat Cut	Double Cut	
VENEER	42	42	42	131	21	NSV4242-42SQRR	\$2,100	\$2,240	\$2,181	\$2,326	--
	36	36	42	97	20	NSV3636-42SQRR	\$1,783	\$1,899	\$1,850	\$1,972	--
	30	30	42	83	16	NSV3030-42SQRR	\$1,674	\$1,783	\$1,735	\$1,850	--
SOL SURF	42	42	42	160	21	NSS4242-42SQRR	--	--	--	--	\$4,243
	36	36	42	118	20	NSS3636-42SQRR	--	--	--	--	\$3,471
	30	30	42	86	16	NSS3030-42SQRR	--	--	--	--	\$2,977

NOSH

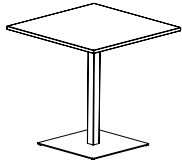
To Order Specify

① Veneer Model #	② Edge Detail	③ Wood Species	④ Wood Finish	⑤ Electrical Cut Out	⑥ Metal Finish
Veneer (NSV)	See Edge Detail Options	Flat Cut B01 Cherry CH1 Cherry MA1 Maple WA1 Walnut	See Flat Cut Wood Finish Options	N None CO_EC23 Cut out for EC23 CO_EC24 Cut out for EC24	See Metal Finish Options
		Double Cut DC2 Double Cut	④ Wood Finish See Double Cut Wood Finish Options		

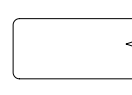
① Solid Surface Model #	② Edge Detail	③ Solid Surface	④ Electrical Cut Out	⑤ Metal Finish
Solid Surface (NSS)	See Edge Detail Options	See Solid Surface Options	N None CO_EC23 Cut out for EC23 CO_EC24 Cut out for EC24	See Metal Finish Options

Description

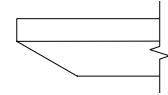
Square Bar Height Table with Square Disc Base



Laminate Tables "NST" Models



Eased Edge (R3)



Reverse Bevel Edge (K9)

LAMINATE	D	W	H	CTN WT	CU FT	① Model	Eased Edge (R3)			Reverse Bevel Edge (K9)		
							Standard	Graded In		Standard	Graded In	
							Tier 1	Tier 2	Tier 3	Tier 1	Tier 2	Tier 3
	42	42	42	131	21	NST4242-42SQS	\$1,530	\$1,576	\$1,617	\$1,942	\$1,989	\$2,029
	36	36	42	97	20	NST3636-42SQS	\$1,358	\$1,397	\$1,422	\$1,771	\$1,809	\$1,834
	30	30	42	84	16	NST3030-42SQS	\$1,298	\$1,333	\$1,344	\$1,710	\$1,745	\$1,756

Features:

- price reflects complete table - top and base
- ships KD in multiple cartons
- cut out for power is not available on these tables
- width of base foot varies from 22" or 27"

HSON

To Order Specify

① Laminate Model #	② Edge Detail	③ Laminate Selection	③a PVC Edge Color	④ Metal Finish
Laminate (NST)	See Edge Detail Options	See Laminate Detail Selection	See PVC Edge Color Options	See Metal Finish Options

Model Number Breakdown

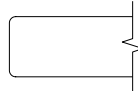
NST4242-42SQS					
NS	T	4242	42	SQ	S
Nosh	Laminate	42" x 42"	Height	Square Top Shape	Square Disc Base

NS150 Nosh

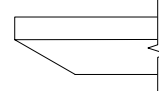
Description

Square Bar Height Table with Square Disc Base
Base
(continued)

Veneer Tables
"NSV" Models



Eased Edge (R3)



Reverse Bevel Edge (K9)

VENEER	D	W	H	CTN WT	CU FT	1 Model	Flat Cut	Double Cut	Flat Cut	Double Cut
	42	42	42	131	21	NSV4242-42SQS	\$1,941	\$2,146	\$2,015	\$2,147
36	36	42	97	20	NSV3636-42SQS	\$1,713	\$1,892	\$1,779	\$1,896	
30	30	42	84	16	NSV3030-42SQS	\$1,636	\$1,798	\$1,698	\$1,809	

NOSH

To Order Specify

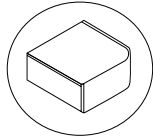
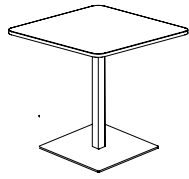
1 Veneer Model #	2 Edge Detail	3 Wood Species	4 Wood Finish	5 Electrical Cut Out	6 Metal Finish
Veneer (NSV)	See Edge Detail Options	Flat Cut B01 Cherry CH1 Cherry MA1 Maple WA1 Walnut	See Flat Cut Wood Finish Options	N None CO_EC23 Cut out for EC23 CO_EC24 Cut out for EC24	See Metal Finish Options
		Double Cut DC2 Double Cut	4 Wood Finish See Double Cut Wood Finish Options		

Nosh - 42" h Tables

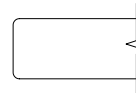


Description

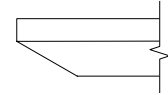
Rounded Square Bar Height Table with Square Disc Base



Laminate Tables "NST" Models



Eased Edge (R3)



Reverse Bevel (K9)

LAMINATE	D	W	H	CTN WT	CU FT	① Model	Eased Edge (R3)			Reverse Bevel (K9)		
							Standard	Graded In		Standard	Graded In	
							Tier 1	Tier 2	Tier 3	Tier 1	Tier 2	Tier 3
	42	42	42	146	21	NST4242-42SQRS	\$1,852	\$1,899	\$1,986	\$2,264	\$2,312	\$2,399
	36	36	42	108	20	NST3636-42SQRS	\$1,549	\$1,589	\$1,648	\$1,961	\$2,002	\$2,061
	30	30	42	95	16	NST3030-42SQRS	\$1,467	\$1,500	\$1,536	\$1,879	\$1,915	\$1,948

Features:

- price reflects complete table - top and base
- ships KD in multiple cartons
- cut out for power is not available on these tables
- width of base foot varies from 22" or 27"

HSON

To Order Specify

① Laminate Model #	② Edge Detail	③ Laminate Selection	③a PVC Edge Color	④ Metal Finish
Laminate (NST)	See Edge Detail Options	See Laminate Detail Selection	See PVC Edge Color Options	See Metal Finish Options

Model Number Breakdown

NST4242-42SQRS						
NS	T	4242	42	SQ	R	S
Nosh	Laminate	42" x 42"	Height	Square Top Shape	Rounded Corner	Square Disc Base

NS152 Nosh

Description

Rounded Square Bar Height Table with Square Disc Base (continued)

		Veneer Tables "NSV" Models				Solid Surface Tables "NSS" Models					
		Eased Edge (R3)		Reverse Bevel Edge (K9)		Reverse Bevel Edge (S7)					
		Flat Cut	Double Cut	Flat Cut	Double Cut	Standard					
	D	W	H	CTN WT	CU FT	1 Model					
VENEER	42	42	42	146	21	NSV4242-42SQRS	\$2,367	\$2,525	\$2,456	\$2,622	--
	36	36	42	108	20	NSV3636-42SQRS	\$2,153	\$2,295	\$2,235	\$2,384	--
	30	30	42	95	16	NSV3030-42SQRS	\$2,043	\$2,180	\$2,120	\$2,262	--
SOL SURF	42	42	42	175	21	NSS4242-42SQRS	--	--	--	--	\$4,510
	36	36	42	129	20	NSS3636-42SQRS	--	--	--	--	\$3,843
	30	30	42	93	16	NSS3030-42SQRS	--	--	--	--	\$3,347

NOSH

To Order Specify

1 Veneer Model #	2 Edge Detail	3 Wood Species	4 Wood Finish	5 Electrical Cut Out	6 Metal Finish
Veneer (NSV)	See Edge Detail Options	Flat Cut B01 Cherry CH1 Cherry MA1 Maple WA1 Walnut	See Flat Cut Wood Finish Options	N None CO_EC23 Cut out for EC23 CO_EC24 Cut out for EC24	See Metal Finish Options
		Double Cut DC2 Double Cut	4 Wood Finish See Double Cut Wood Finish Options		

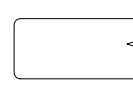
1 Solid Surface Model #	2 Edge Detail	3 Solid Surface	4 Electrical Cut Out	5 Metal Finish
Solid Surface (NSS)	See Edge Detail Options	See Solid Surface Options	N None CO_EC23 Cut out for EC23 CO_EC24 Cut out for EC24	See Metal Finish Options

Description

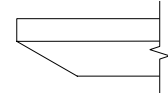
Squirrelle Bar Height Table with X Base



Laminate Tables "NST" Models



Eased Edge (R3)



Reverse Bevel Edge (K9)

LAMINATE	D	W	H	CTN WT	CU FT	① Model	Eased Edge (R3)			Reverse Bevel Edge (K9)		
							Standard	Graded In		Standard	Graded In	
							Tier 1	Tier 2	Tier 3	Tier 1	Tier 2	Tier 3
	42	42	42	75	23	NST42-42SCX	\$1,434	\$1,541	\$1,629	\$1,849	\$1,955	\$2,043
	36	36	42	61	19	NST36-42SCX	\$1,390	\$1,431	\$1,493	\$1,804	\$1,843	\$1,905
	30	30	42	50	21	NST30-42SCX	\$1,344	\$1,376	\$1,413	\$1,757	\$1,791	\$1,828

Features:

- price reflects complete table - top and base
- ships KD in multiple cartons
- top has option for cutout to receive electrical component, ordered separately
- when electrical cut out selected, power accessible base is sent - add \$111
- base has leveling glides
- width of base foot varies from 26" to 38"

HSON

To Order Specify

① Laminate Model #	② Edge Detail	③ Laminate Selection	③a PVC Edge Color	④ Electrical Cut Out	⑤ Metal Finish
Laminate (NST)	See Edge Detail Options	See Laminate Detail Selection	See PVC Edge Color Options	N None COB_EC23 Cut out for EC23 COB_EC24 Cut out for EC24	See Metal Finish Options

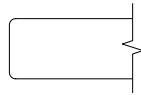
Model Number Breakdown

NST36-42SCX					
NS	T	36	42	SC	X
Nosh	Laminate	36"	Height	Squirrelle Top Shape	X Base

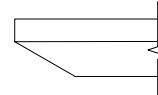
Description

Squircle Bar Height Table with X Base
(continued)

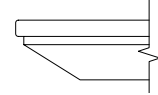
Veneer Tables "NSV" Models Solid Surface Tables "NSS" Models



Eased Edge (R3)



Reverse Bevel Edge (K9)



Reverse Bevel Edge (S7)

	D	W	H	CTN WT	CU FT	① Model	Eased Edge (R3)		Reverse Bevel Edge (K9)		Standard
							Flat Cut	Double Cut	Flat Cut	Double Cut	
VENEER	42	42	42	75	23	NSV42-42SCX	\$1,877	\$1,998	\$1,947	\$2,075	--
	36	36	42	61	19	NSV36-42SCX	\$1,820	\$1,939	\$1,891	\$2,012	--
	30	30	42	50	21	NSV30-42SCX	\$1,755	\$1,871	\$1,824	\$1,942	--
SOL SURF	42	42	42	98	23	NSS42-42SCX	--	--	--	--	\$4,038
	36	36	42	78	19	NSS36-42SCX	--	--	--	--	\$3,528
	30	30	42	61	21	NSS30-42SCX	--	--	--	--	\$3,400

NOSH

To Order Specify

① Veneer Model #	② Edge Detail	③ Wood Species	④ Wood Finish	⑤ Electrical Cut Out	⑥ Metal Finish
Veneer (NSV)	See Edge Detail Options	Flat Cut B01 Cherry CH1 Cherry MA1 Maple WA1 Walnut	See Flat Cut Wood Finish Options	N None CO_EC23 Cut out for EC23 CO_EC24 Cut out for EC24	See Metal Finish Options
		Double Cut DC2 Double Cut	④ Wood Finish See Double Cut Wood Finish Options		

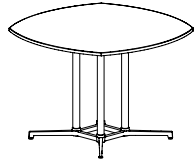
① Solid Surface Model #	② Edge Detail	③ Solid Surface	④ Electrical Cut Out	⑤ Metal Finish
Solid Surface (NSS)	See Edge Detail Options	See Solid Surface Options	N None CO_EC23 Cut out for EC23 CO_EC24 Cut out for EC24	See Metal Finish Options

Nosh - 42" h Tables

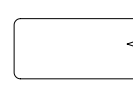


Description

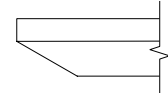
Squirrel Bar Height Table with X4 Base



Laminate Tables "NST" Models



Eased Edge (R3)



Reverse Bevel Edge (K9)

LAMINATE	D	W	H	CTN WT	CU FT	① Model	Eased Edge (R3)			Reverse Bevel Edge (K9)		
							Standard	Graded In		Standard	Graded In	
							Tier 1	Tier 2	Tier 3	Tier 1	Tier 2	Tier 3
	60	60	42	154	50	NST60-42SCZ	\$2,570	\$2,654	\$2,845	\$2,985	\$3,071	\$3,258
	54	54	42	106	28	NST54-42SCZ	\$2,407	\$2,475	\$2,539	\$2,822	\$2,888	\$2,952
	48	48	42	90	28	NST48-42SCZ	\$2,288	\$2,396	\$2,516	\$2,702	\$2,811	\$2,930

Features:

- price reflects complete table - top and base
- ships KD in multiple cartons
- top has option for cut out to receive electrical component, order separately
- optional vertical wire manager for base, order separately
- base has leveling glides
- width of base foot is 38"

HSON

To Order Specify

① Laminate Model #	② Edge Detail	③ Laminate Selection	③a PVC Edge Color	④ Electrical Cut Out	⑤ Metal Finish
Laminate (NST)	See Edge Detail Options	See Laminate Detail Selection	See PVC Edge Color Options	N None CO_EC23 Cut out for EC23 CO_EC24 Cut out for EC24	See Metal Finish Options

Model Number Breakdown

NST54-42SCZ					
NS	T	54	42	SC	Z
Nosh	Laminate	54"	Height	Squirrel Top Shape	X4 Base

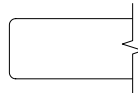
NS156 Nosh

Description

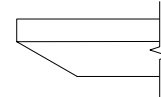
Squircle Bar Height Table with X4 Base
(continued)

Veneer Tables
"NSV" Models

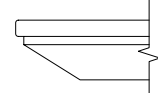
Solid Surface Tables
"NSS" Models



Eased Edge (R3)



Reverse Bevel Edge (K9)



Reverse Bevel Edge (S7)

	D	W	H	CTN WT	CU FT	① Model	Eased Edge (R3)		Reverse Bevel Edge (K9)		Reverse Bevel Edge (S7) Standard
							Flat Cut	Double Cut	Flat Cut	Double Cut	
VENEER	60	60	42	154	50	NSV60-42SCZ	\$3,359	\$3,579	\$3,485	\$3,712	--
	54	54	42	106	28	NSV54-42SCZ	\$3,181	\$3,394	\$3,304	\$3,525	--
	48	48	42	90	28	NSV48-42SCZ	\$2,773	\$2,905	\$2,849	\$2,989	--
SOL SURF	60	60	42	208	50	NSS60-42SCZ	--	--	--	--	\$7,300
	54	54	42	145	28	NSS54-42SCZ	--	--	--	--	\$6,459
	48	48	42	120	28	NSS48-42SCZ	--	--	--	--	\$5,457

NOSH

To Order Specify

① Veneer Model #	② Edge Detail	③ Wood Species	④ Wood Finish	⑤ Electrical Cut Out	⑥ Metal Finish
Veneer (NSV)	See Edge Detail Options	Flat Cut B01 Cherry CH1 Cherry MA1 Maple WA1 Walnut	See Flat Cut Wood Finish Options	N None CO_EC23 Cut out for EC23 CO_EC24 Cut out for EC24	See Metal Finish Options
		Double Cut DC2 Double Cut	④ Wood Finish See Double Cut Wood Finish Options		

① Solid Surface Model #	② Edge Detail	③ Solid Surface	④ Electrical Cut Out	⑤ Metal Finish
Solid Surface (NSS)	See Edge Detail Options	See Solid Surface Options	N None CO_EC23 Cut out for EC23 CO_EC24 Cut out for EC24	See Metal Finish Options

Nosh - 42" h Tables

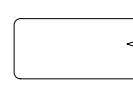


Description

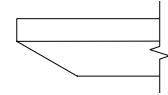
Squirrel Bar Height Table with Round Disc Base



Laminate Tables "NST" Models



Eased Edge (R3)



Reverse Bevel Edge (K9)

LAMINATE	D	W	H	CTN WT	CU FT	① Model	Eased Edge (R3)			Reverse Bevel Edge (K9)		
							Standard	Graded In		Standard	Graded In	
							Tier 1	Tier 2	Tier 3	Tier 1	Tier 2	Tier 3
	42	42	42	118	21	NST42-42SCR	\$1,640	\$1,689	\$1,777	\$2,054	\$2,105	\$2,191
	36	36	42	88	20	NST36-42SCR	\$1,409	\$1,449	\$1,509	\$1,822	\$1,864	\$1,922
	30	30	42	65	15	NST30-42SCR	\$1,216	\$1,250	\$1,286	\$1,631	\$1,665	\$1,700

Features:

- price reflects complete table - top and base
- ships KD in multiple cartons
- cut out for power is not available on these tables
- base has anti-rock glides
- width of base foot varies from 22" or 27"

HSON

To Order Specify

① Laminate Model #	② Edge Detail	③ Laminate Selection	③a PVC Edge Color	④ Metal Finish
Laminate (NST)	See Edge Detail Options	See Laminate Detail Selection	See PVC Edge Color Options	See Metal Finish Options

Model Number Breakdown

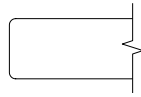
NST30-42SCR					
NS	T	30	42	SC	R
Nosh	Laminate	30"	Height	Squirrel Top Shape	Round Disc Base

NS158 Nosh

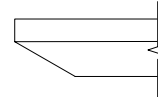
Description

Squirrel Bar Height Table with Round Disc Base (continued)

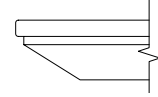
Veneer Tables "NSV" Models Solid Surface Tables "NSS" Models



Eased Edge (R3)



Reverse Bevel Edge (K9)



Reverse Bevel Edge (S7)

	D	W	H	CTN WT	CU FT	① Model	Eased Edge (R3)		Reverse Bevel Edge (K9)		Reverse Bevel Edge (S7) Standard
							Flat Cut	Double Cut	Flat Cut	Double Cut	
VENEER	42	42	42	118	21	NSV42-42SCR	\$2,028	\$2,169	\$2,110	\$2,258	--
	36	36	42	88	20	NSV36-42SCR	\$1,719	\$1,836	\$1,787	\$1,912	--
	30	30	42	65	15	NSV30-42SCR	\$1,460	\$1,562	\$1,520	\$1,625	--
SOL SURF	42	42	42	141	21	NSS42-42SCR	--	--	--	--	\$4,302
	36	36	42	104	20	NSS36-42SCR	--	--	--	--	\$3,541
	30	30	42	76	15	NSS30-42SCR	--	--	--	--	\$3,034

NOSH

To Order Specify

① Veneer Model #	② Edge Detail	③ Wood Species	④ Wood Finish	⑤ Electrical Cut Out	⑥ Metal Finish
Veneer (NSV)	See Edge Detail Options	Flat Cut B01 Cherry CH1 Cherry MA1 Maple WA1 Walnut	See Flat Cut Wood Finish Options	N None CO_EC23 Cut out for EC23 CO_EC24 Cut out for EC24	See Metal Finish Options
		Double Cut DC2 Double Cut	④ Wood Finish See Double Cut Wood Finish Options		

① Solid Surface Model #	② Edge Detail	③ Solid Surface	④ Electrical Cut Out	⑤ Metal Finish
Solid Surface (NSS)	See Edge Detail Options	See Solid Surface Options	N None CO_EC23 Cut out for EC23 CO_EC24 Cut out for EC24	See Metal Finish Options

Nosh - 42" h Tables

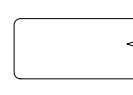


Description

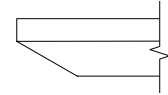
Squirrel Bar Height Table with Square Disc Base



Laminate Tables "NST" Models



Eased Edge (R3)



Reverse Bevel Edge (K9)

LAMINATE	D	W	H	CTN WT	CU FT	① Model	Eased Edge (R3)			Reverse Bevel Edge (K9)		
							Standard	Graded In		Standard	Graded In	
							Tier 1	Tier 2	Tier 3	Tier 1	Tier 2	Tier 3
	42	42	42	134	21	NST42-42SCS	\$1,842	\$1,893	\$1,979	\$2,257	\$2,306	\$2,392
	36	36	42	99	20	NST36-42SCS	\$1,549	\$1,589	\$1,649	\$1,961	\$2,002	\$2,063
	30	30	42	71	15	NST30-42SCS	\$1,357	\$1,389	\$1,425	\$1,771	\$1,804	\$1,840

Features:

- price reflects complete table - top and base
- ships KD in multiple cartons
- cut out for power is not available on these tables
- base has anti-rock glides
- width of base foot varies from 22" or 27"

HSON

To Order Specify

① Laminate Model #	② Edge Detail	③ Laminate Selection	③a PVC Edge Color	④ Metal Finish
Laminate (NST)	See Edge Detail Options	See Laminate Detail Selection	See PVC Edge Color Options	See Metal Finish Options

Model Number Breakdown

NST30-42SCS					
NS	T	30	42	SC	S
Nosh	Laminate	30"	Height	Squirrel Top Shape	Square Disc Base

NS160 Nosh

Description

Squircle Bar Height Table with Square Disc Base (continued)

		Veneer Tables "NSV" Models				Solid Surface Tables "NSS" Models					
		Eased Edge (R3)		Reverse Bevel Edge (K9)		Reverse Bevel Edge (S7)					
		Flat Cut	Double Cut	Flat Cut	Double Cut	Standard					
	D	W	H	CTN WT	CU FT	1 Model	Flat Cut	Double Cut	Flat Cut	Double Cut	Standard
VENEER	42	42	42	134	21	NSV42-42SCS	\$2,412	\$2,574	\$2,505	\$2,673	--
	36	36	42	99	20	NSV36-42SCS	\$2,021	\$2,153	\$2,097	\$2,237	--
	30	30	42	71	15	NSV30-42SCS	\$1,760	\$1,876	\$1,829	\$1,947	--
SOL SURF	42	42	29	156	21	NSS42-42SCS	--	--	--	--	\$4,573
	36	36	29	115	20	NSS36-42SCS	--	--	--	--	\$3,728
	30	30	29	82	15	NSS30-42SCS	--	--	--	--	\$3,412

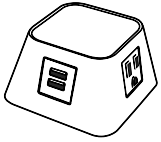
NOSH

To Order Specify

1 Veneer Model #	2 Edge Detail	3 Wood Species	4 Wood Finish	5 Electrical Cut Out	6 Metal Finish
Veneer (NSV)	See Edge Detail Options	Flat Cut B01 Cherry CH1 Cherry MA1 Maple WA1 Walnut	See Flat Cut Wood Finish Options	N None CO_EC23 Cut out for EC23 CO_EC24 Cut out for EC24	See Metal Finish Options
		Double Cut DC2 Double Cut	4 Wood Finish See Double Cut Wood Finish Options		

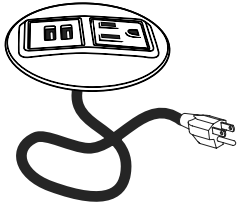
1 Solid Surface Model #	2 Edge Detail	3 Solid Surface	4 Electrical Cut Out	5 Metal Finish
Solid Surface (NSS)	See Edge Detail Options	See Solid Surface Options	N None CO_EC23 Cut out for EC23 CO_EC24 Cut out for EC24	See Metal Finish Options

Description	D	W	H	CTN WT	CU FT	① Model	List Price
Corner Electrical Jumper Cable	3 3/8	3 3/8	2	5	1	EC23	\$481



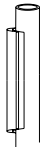
- 3 power & 1 Dual USB, 72" cord
- color: black or white

Node Power Unit	3 3/8	3 3/8	3/8	5	1	EC24	\$384
-----------------	-------	-------	-----	---	---	------	-------



- 1 power & 1 Dual USB, 72" cord
- color: black or white

Vertical Wire Management	1/2	1/2	0	1	1	AVL20	\$85
--------------------------	-----	-----	---	---	---	-------	------



- field installed
- color: black or silver

To Order Specify

① Model #	
-----------	--

Privacy Solutions



PRIVACY

Privacy Solutions

Under-Surface Mount [PS2-PS14](#)
 Above-Surface Mount [PS15-PS20](#)
 Edge Mount [PS21](#)
 Side Mount [PS22-PS23](#)
 Freestanding Soft-Sided [PS24-PS33](#)
 Freestanding Hard-Sided. [PS34-PS35](#)

Privacy Solutions - Cleaning Guidelines

We offer numerous textile and hard surface options that will stand up to the rigors of frequent bleach cleaning, ranging from untreated surfaces to those with anti-microbial topcoats. Please contact our Customer Support Team today for more information.

MATERIALS:

ACRYLIC: water based foam or cleaner and bleach cleanable (5:1)*

ACOUSTIC PET: bleach solution cleanable (2% bleach)*

HPL LAMINATE: recommended by suppliers: Clorox Healthcare Bleach Germicidal wipes, Virex II 256, PDI Super Sani-Cloth wipes, PDI Sani-Prime Germicidal spray

TFL LAMINATE: cleaning guidelines will vary between manufacturer; cleaning details available upon request

VENEER: first clean with warm soapy water - do not soak. Pledge Antibacterial cleaner or bleach free disinfectant wipes are recommended

COATED FABRIC: water based foam or cleaner and bleach cleanable (4:1)*

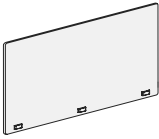
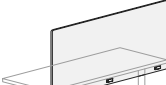
FABRIC: cleaning guidelines will vary between fabric type, pattern and manufacturer; see material recommendations for bleach-solution cleanable fabrics

*Bleach solution cleanable:

Complies with BIFMA HCF 8.1 guidelines

Important to rinse repeatedly with cool, clean water after cleaning to remove all residue. More cleaning details from raw material suppliers available upon request

All surfaces with the exception of some fabrics can be cleaned with Clorox Healthcare Bleach Germicidal Wipes as well as bleach free wipes. This includes all coated fabric, laminate, acrylic and metal surfaces.

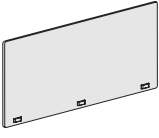

Description	D	W	H	CTN WT	CU FT	① Model	List Price
  in application	¼	71½	27½	23	3	GP7228LU-ACR	\$1,008
	¼	65½	27½	21	3	GP6628LU-ACR	\$954
	¼	59½	27½	19	3	GP6028LU-ACR	\$853
	¼	53½	27½	18	3	GP5428LU-ACR	\$835
	¼	47½	27½	16	2	GP4828LU-ACR	\$750
	¼	41½	27½	14	2	GP4228LU-ACR	\$702
	¼	35½	27½	13	2	GP3628LU-ACR	\$626
	¼	29½	27½	11	2	GP3028LU-ACR	\$578
	¼	23½	27½	10	1	GP2428LU-ACR	\$514

Features:

- bracket attaches to bottom of worksurface with wood screws
- minimum worksurface overhang clearance for bracket: 1"
- height above worksurface: 24"
- wire pass-through
- bracket visible on approach side only
- corners: ¾" radius
- see cleaning guidelines for cleaning information

To Order, Specify:

- ① Model Number
- ② Material:
 - a. acrylic - frosted or clear
 - b. metal - matte black or arctic silver

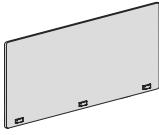

  in application	½	71½	27½	10	4	GP7228LU-PET	\$975
	½	65½	27½	10	3	GP6628LU-PET	\$960
	½	59½	27½	9	3	GP6028LU-PET	\$928
	½	53½	27½	9	3	GP5428LU-PET	\$903
	½	47½	27½	8	3	GP4828LU-PET	\$609
	½	41½	27½	7	2	GP4228LU-PET	\$600
	½	35½	27½	7	2	GP3628LU-PET	\$576
	½	29½	27½	6	2	GP3028LU-PET	\$472
	½	23½	27½	5	2	GP2428LU-PET	\$352

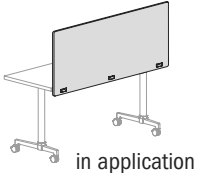
Features:

- bracket attaches to bottom of worksurface with wood screws
- minimum worksurface overhang clearance for bracket: 1"
- height above worksurface: 24"
- wire pass-through
- bracket visible on approach side only
- corners: ¾" radius
- see cleaning guidelines for cleaning information

To Order, Specify:

- ① Model Number
- ② Material:
 - a. PET - ash grey or silver grey
 - b. metal - matte black or arctic silver

Description	D	W	H	CTN WT	CU FT	① Model	List Price
Acoustic PET/Magnetic Markerboard Privacy Screen	½	71 ⅝	27 ⅝	14	4	GP7228LU-PETMB1	\$2,141
	½	65 ⅝	27 ⅝	13	3	GP6628LU-PETMB1	\$2,136
 one side: acoustic PET	½	59 ⅝	27 ⅝	12	3	GP6028LU-PETMB1	\$2,132
	½	53 ⅝	27 ⅝	11	3	GP5428LU-PETMB1	\$1,227
	½	47 ⅝	27 ⅝	10	3	GP4828LU-PETMB1	\$882
	½	41 ⅝	27 ⅝	9	2	GP4228LU-PETMB1	\$879
	½	35 ⅝	27 ⅝	8	2	GP3628LU-PETMB1	\$876
 opposite side: magnetic markerboard	½	29 ⅝	27 ⅝	8	2	GP3028LU-PETMB1	\$874
	½	23 ⅝	27 ⅝	7	2	GP2428LU-PETMB1	\$571



Features:

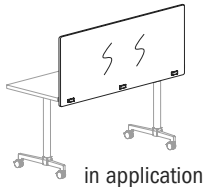
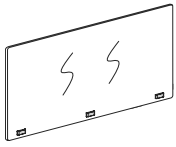
- bracket attaches to bottom of worksurface with wood screws
- minimum worksurface overhang clearance for bracket: 1"
- one side acoustic PET, opposite side magnetic markerboard
- PET is silver grey
- height above worksurface: 24"
- wire pass-through
- bracket visible on approach side only
- corners: ¾" radius
- see cleaning guidelines for cleaning information

To Order, Specify:

- ① Model Number
- ② Metal Finish: matte black or arctic silver

PRIVACY

Description	D	W	H	CTN WT	CU FT	① Model	List Price
Dual Magnetic Markerboard	1/2	71%	27%	17	4	GP7228LU-PETMB2	\$3,323
Privacy Screen	1/2	65%	27%	16	3	GP6628LU-PETMB2	\$3,319
	1/2	59%	27%	15	3	GP6028LU-PETMB2	\$3,315
	1/2	53%	27%	14	3	GP5428LU-PETMB2	\$1,821
	1/2	47%	27%	12	3	GP4828LU-PETMB2	\$1,276
	1/2	41%	27%	11	2	GP4228LU-PETMB2	\$1,271
	1/2	35%	27%	10	2	GP3628LU-PETMB2	\$1,269
	1/2	29%	27%	9	2	GP3028LU-PETMB2	\$1,267
	1/2	23%	27%	8	2	GP2428LU-PETMB2	\$767

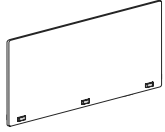
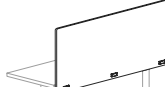


Features:

- bracket attaches to bottom of worksurface with wood screws
- minimum worksurface overhang clearance for bracket: 1"
- exposed edges in PET silver grey
- height above worksurface: 24"
- wire pass-through
- bracket visible on approach side only
- corners: 3/4" radius
- see cleaning guidelines for cleaning information

To Order, Specify:

- ① Model Number
- ② Metal Finish: matte black or arctic silver

Description	D	W	H	CTN WT	CU FT	① Model	List Price
  in application	¾	71 ½	27 ½	46	4	GP7228LU-TFL	\$522
	¾	65 ½	27 ½	43	4	GP6628LU-TFL	\$507
	¾	59 ½	27 ½	39	3	GP6028LU-TFL	\$494
	¾	53 ½	27 ½	36	3	GP5428LU-TFL	\$478
	¾	47 ½	27 ½	32	3	GP4828LU-TFL	\$421
	¾	41 ½	27 ½	28	3	GP4228LU-TFL	\$404
	¾	35 ½	27 ½	24	2	GP3628LU-TFL	\$389
	¾	29 ½	27 ½	21	2	GP3028LU-TFL	\$376
	¾	23 ½	27 ½	17	2	GP2428LU-TFL	\$360

Features:

- bracket attaches to bottom of worksurface with wood screws
- minimum worksurface overhang clearance for bracket: 1"
- edges are matching PVC
- height above worksurface: 24"
- wire pass-through
- bracket visible on approach side only
- corners: ¼" radius
- see cleaning guidelines for cleaning information

To Order, Specify:

① Model Number

② Laminate Color

- ③ Metal Finish: matte black
or arctic silver

② Laminate Color

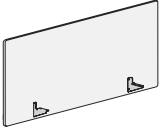
Solid Patterns:

- ALB** Alabaster
BBL Bridal Blanco
DWH Designer White
SHD Shadow
SLG Slate Grey

Wood Grain Patterns:

- ALL** Ale Light
BOL Bourbon Light
BZW Brazilwood
BGL Brighton Light
CLL Collectors
FAW Fawn
FLO Florence Walnut
GRH Graphite
MIN Mineral
OAT Oatmeal Cookie
PIN Pinnacle Walnut
STU Studio Teak

- UMB** Umber
VAL Valley
VIN Vintage
WEA Weathered Ash

Description	D	W	H	CTN WT	CU FT	① Model	List Price
Acrylic Privacy Screen 	¼	71½	27½	22	3	GP7224FU-ACR	\$1,151
	¼	65½	27½	21	3	GP6624FU-ACR	\$1,085
	¼	59½	27½	19	3	GP6024FU-ACR	\$961
	¼	53½	27½	18	3	GP5424FU-ACR	\$939
	¼	47½	27½	16	2	GP4824FU-ACR	\$858
	¼	41½	27½	14	2	GP4224FU-ACR	\$803
	¼	35½	27½	13	2	GP3624FU-ACR	\$713
	¼	29½	27½	11	2	GP3024FU-ACR	\$638
	¼	23½	27½	10	1	GP2424FU-ACR	\$564

Features:

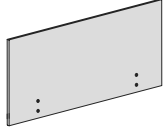
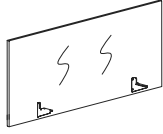
- bracket attaches to bottom of worksurface with wood screws
- minimum worksurface overhang clearance for bracket: 3 ½"
- height above worksurface: 24"
- wire pass-through
- corners: ¾" radius
- see cleaning guidelines for cleaning information
- exposed bolts on approach side

To Order, Specify:

- ① Model Number
- ② Acrylic Options: frosted or clear

Description

Acoustic PET/Magnetic Marker-board Privacy Screen



D	W	H	CTN WT	CU FT	① Model	List Price
½	71 ¾	27 ¾	14	5	GP7224FU-PETMB1	\$2,060
½	65 ¾	27 ¾	13	5	GP6624FU-PETMB1	\$2,056
½	59 ¾	27 ¾	12	4	GP6024FU-PETMB1	\$2,054
½	53 ¾	27 ¾	11	4	GP5424FU-PETMB1	\$1,147
½	47 ¾	27 ¾	10	3	GP4824FU-PETMB1	\$848
½	41 ¾	27 ¾	9	3	GP4224FU-PETMB1	\$846
½	35 ¾	27 ¾	9	3	GP3624FU-PETMB1	\$842
½	29 ¾	27 ¾	8	2	GP3024FU-PETMB1	\$840
½	23 ¾	27 ¾	7	2	GP2424FU-PETMB1	\$539

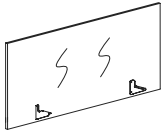
Features:

- bracket attaches to bottom of worksurface with wood screws
- minimum worksurface overhang clearance for bracket: 3 ¾"
- one side acoustic PET, opposite side magnetic markerboard
- PET is silver grey
- height above worksurface: 24"
- wire pass-through
- corners: square
- see cleaning guidelines for cleaning information
- exposed bolts on approach side

To Order, Specify:

- ① Model Number

Description	D	W	H	CTN WT	CU FT	① Model	List Price
Dual Magnetic Markerboard	½	71⅝	27⅝	17	5	GP7224FU-PETMB2	\$3,242
Privacy Screen	½	65⅝	27⅝	16	5	GP6624FU-PETMB2	\$3,239
	½	59⅝	27⅝	15	4	GP6024FU-PETMB2	\$3,235
	½	53⅝	27⅝	14	4	GP5424FU-PETMB2	\$1,740
	½	47⅝	27⅝	13	3	GP4824FU-PETMB2	\$1,242
	½	41⅝	27⅝	11	3	GP4224FU-PETMB2	\$1,239
	½	35⅝	27⅝	10	3	GP3624FU-PETMB2	\$1,237
	½	29⅝	27⅝	9	2	GP3024FU-PETMB2	\$1,233
	½	23⅝	27⅝	8	2	GP2424FU-PETMB2	\$733

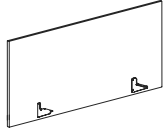


Features:

- bracket attaches to bottom of worksurface with wood screws
- minimum worksurface overhang clearance for bracket: 3⅝"
- exposed edges in PET silver grey
- height above worksurface: 24"
- wire pass-through
- corners: square
- see cleaning guidelines for cleaning information
- exposed bolts on approach side

To Order, Specify:

- ① Model Number

Description	D	W	H	CTN WT	CU FT	① Model	List Price
TFL Privacy Screen 	¾	71 ½	27 ½	46	5	GP7224FU-TFL	\$440
	¾	65 ½	27 ½	43	5	GP6624FU-TFL	\$428
	¾	59 ½	27 ½	39	4	GP6024FU-TFL	\$414
	¾	53 ½	27 ½	35	4	GP5424FU-TFL	\$399
	¾	47 ½	27 ½	32	4	GP4824FU-TFL	\$387
	¾	41 ½	27 ½	28	3	GP4224FU-TFL	\$369
	¾	35 ½	27 ½	25	3	GP3624FU-TFL	\$356
	¾	29 ½	27 ½	21	3	GP3024FU-TFL	\$342
	¾	23 ½	27 ½	18	2	GP2424FU-TFL	\$325

Features:

- bracket attaches to bottom of worksurface with wood screws
- minimum worksurface overhang clearance for bracket: 3 ½"
- edges are matching PVC
- height above worksurface: 24"
- wire pass-through
- corners: square
- see cleaning guidelines for cleaning information
- exposed bolts on approach side

To Order, Specify:

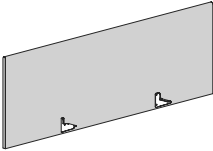
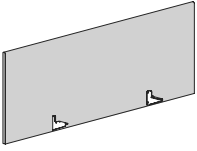
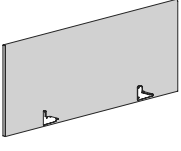
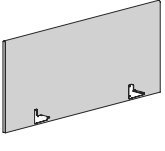
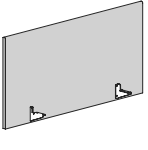
- ① Model Number
- ② Laminate Color

② Laminate Color

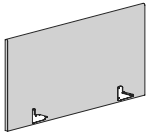
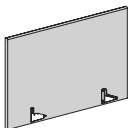
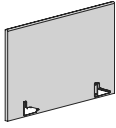
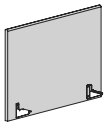
Solid Patterns:		Wood Grain Patterns:			
ALB	Alabaster	ALL	Ale Light	FLO	Florence Walnut
BBL	Bridal Blanco	BOL	Bourbon Light	GRH	Graphite
DWH	Designer White	BZW	Brazilwood	MIN	Mineral
SHD	Shadow	BGL	Brighton Light	OAT	Oatmeal Cookie
SLG	Slate Grey	CLL	Collectors	PIN	Pinnacle Walnut
		FAW	Fawn	STU	Studio Teak
				UMB	Umber
				VAL	Valley
				VIN	Vintage
				WEA	Weathered Ash

Under-Surface Mount | FX Style



Description	D	W	H	CTN WT	CU FT	① Model	List Price Per Grade				
 <p>Features:</p> <ul style="list-style-type: none"> · bracket attaches to bottom of worksurface with wood screws · minimum worksurface overhang clearance for bracket: 3 1/8" · height above worksurface: 24" · wire pass-through · corners: square · see cleaning guidelines for cleaning information · com ydg: 4 1/2 	1 1/8	72	27 5/8	52	8	GP7228FU-EMTK	COM \$1,546 A \$1,626 B \$1,784 C \$2,061 D \$2,415 E \$2,771 F \$3,324 G \$3,916 H \$4,547 I \$5,534 J \$6,716				
	 <p>Features:</p> <ul style="list-style-type: none"> · bracket attaches to bottom of worksurface with wood screws · minimum worksurface overhang clearance for bracket: 3 1/8" · height above worksurface: 24" · wire pass-through · corners: square · see cleaning guidelines for cleaning information · com ydg: 4 1/4 	1 1/8	66	27 5/8	48	8	GP6628FU-EMTK	COM \$1,513 A \$1,586 B \$1,730 C \$1,983 D \$2,309 E \$2,635 F \$3,142 G \$3,683 H \$4,262 I \$5,169 J \$6,252			
		 <p>Features:</p> <ul style="list-style-type: none"> · bracket attaches to bottom of worksurface with wood screws · minimum worksurface overhang clearance for bracket: 3 1/8" · height above worksurface: 24" · wire pass-through · corners: square · see cleaning guidelines for cleaning information · com ydg: 4 	1 1/8	60	27 5/8	44	7	GP6028FU-EMTK	COM \$1,479 A \$1,544 B \$1,676 C \$1,906 D \$2,202 E \$2,497 F \$2,960 G \$3,452 H \$3,977 I \$4,800 J \$5,787		
			 <p>Features:</p> <ul style="list-style-type: none"> · bracket attaches to bottom of worksurface with wood screws · minimum worksurface overhang clearance for bracket: 3 1/8" · height above worksurface: 24" · wire pass-through · corners: square · see cleaning guidelines for cleaning information · com ydg: 3 1/2 	1 1/8	54	27 5/8	40	6	GP5428FU-EMTK	COM \$1,444 A \$1,504 B \$1,622 C \$1,829 D \$2,096 E \$2,362 F \$2,777 G \$3,221 H \$3,695 I \$4,435 J \$5,322	
				 <p>Features:</p> <ul style="list-style-type: none"> · bracket attaches to bottom of worksurface with wood screws · minimum worksurface overhang clearance for bracket: 3 1/8" · height above worksurface: 24" · wire pass-through · corners: square · see cleaning guidelines for cleaning information · com ydg: 3 1/4 	1 1/8	48	27 5/8	36	6	GP4828FU-EMTK	COM \$1,223 A \$1,277 B \$1,382 C \$1,567 D \$1,802 E \$2,040 F \$2,408 G \$2,803 H \$3,224 I \$3,882 J \$4,671

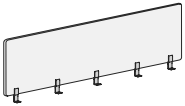
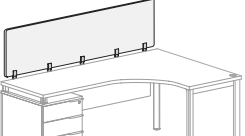
PRIVACY

Description	D	W	H	CTN WT	CU FT	① Model	List Price Per Grade
Fabric Privacy Screen 	1 1/8	42	27 5/8	32	5	GP4228FU-EMTK	COM \$1,189 A \$1,237 B \$1,329 C \$1,490 D \$1,697 E \$1,904 F \$2,227 G \$2,571 H \$2,940 I \$3,515 J \$4,206
Features: <ul style="list-style-type: none"> • bracket attaches to bottom of worksurface with wood screws • minimum worksurface overhang clearance for bracket: 3 1/8" • height above worksurface: 24" • wire pass-through • corners: square • see cleaning guidelines for cleaning information • com ydg: 3 							
Fabric Privacy Screen 	1 1/8	36	27 5/8	28	4	GP3628FU-EMTK	COM \$1,157 A \$1,198 B \$1,276 C \$1,415 D \$1,592 E \$1,769 F \$2,045 G \$2,342 H \$2,657 I \$3,150 J \$3,743
Features: <ul style="list-style-type: none"> • bracket attaches to bottom of worksurface with wood screws • minimum worksurface overhang clearance for bracket: 3 1/8" • height above worksurface: 24" • wire pass-through • corners: square • see cleaning guidelines for cleaning information • com ydg: 2 1/2 							
Fabric Privacy Screen 	1 1/8	30	27 5/8	24	4	GP3028FU-EMTK	COM \$1,065 A \$1,086 B \$1,126 C \$1,195 D \$1,284 E \$1,373 F \$1,509 G \$1,658 H \$1,816 I \$2,062 J \$2,359
Features: <ul style="list-style-type: none"> • bracket attaches to bottom of worksurface with wood screws • minimum worksurface overhang clearance for bracket: 3 1/8" • height above worksurface: 24" • wire pass-through • corners: square • see cleaning guidelines for cleaning information • com ydg: 2 1/4 							
Fabric Privacy Screen 	1 1/8	24	27 5/8	20	3	GP2428FU-EMTK	COM \$969 A \$982 B \$1,009 C \$1,055 D \$1,115 E \$1,173 F \$1,266 G \$1,364 H \$1,469 I \$1,634 J \$1,832
Features: <ul style="list-style-type: none"> • bracket attaches to bottom of worksurface with wood screws • minimum worksurface overhang clearance for bracket: 3 1/8" • height above worksurface: 24" • wire pass-through • corners: square • see cleaning guidelines for cleaning information • com ydg: 2 							

PRIVACY

To Order, Specify:

① Model Number	② Fabric Selection
(FLB)	Visit www.jsifurniture.com/finishes-and-materials/textiles for our textiles program. See selection of standard and graded in manufacturers and patterns.

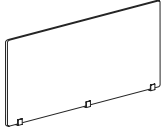
Description	D	W	H	CTN WT	CU FT	① Model	List Price
  in application	¼	71 ¼	23 ⅝	20	4	GP7224SS-ACR	\$1,162
	¼	65 ¼	23 ⅝	19	4	GP6624SS-ACR	\$1,136
	¼	59 ¼	23 ⅝	17	3	GP6024SS-ACR	\$1,020
	¼	53 ¼	23 ⅝	16	3	GP5424SS-ACR	\$969
	¼	47 ¼	23 ⅝	14	3	GP4824SS-ACR	\$846
	¼	41 ¼	23 ⅝	13	3	GP4224SS-ACR	\$806
	¼	35 ¼	23 ⅝	11	2	GP3624SS-ACR	\$692
	¼	29 ¼	23 ⅝	10	2	GP3024SS-ACR	\$589
	¼	23 ¼	23 ⅝	9	2	GP2424SS-ACR	\$541

Features:

- bracket attaches to top side of worksurface with wood screws
- height above worksurface: 24"
- corners: ¾" radius
- see cleaning guidelines for cleaning information

To Order, Specify:

- ① Model Number
- ② Acrylic Options: frosted or clear

Description	D	W	H	CTN WT	CU FT	① Model	List Price
Acrylic Privacy Screen 	¼	71 ¼	23 ⅝	20	4	GP7224VS-ACR	\$1,170
	¼	65 ¼	23 ⅝	19	4	GP6624VS-ACR	\$1,144
	¼	59 ¼	23 ⅝	17	3	GP6024VS-ACR	\$1,031
	¼	53 ¼	23 ⅝	16	3	GP5424VS-ACR	\$981
	¼	47 ¼	23 ⅝	14	3	GP4824VS-ACR	\$861
	¼	41 ¼	23 ⅝	13	3	GP4224VS-ACR	\$808
	¼	35 ¼	23 ⅝	11	2	GP3624VS-ACR	\$696
	¼	29 ½	23 ⅝	10	2	GP3024VS-ACR	\$599
	¼	23 ½	23 ⅝	9	2	GP2424VS-ACR	\$550

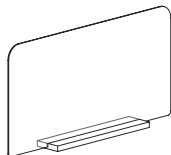
Features:

- bracket attaches to top side of worksurface with wood screws
- height above worksurface: 24"
- corners: ¾" radius
- see cleaning guidelines for cleaning information

To Order, Specify:

- ① Model Number
- ② Acrylic Options: frosted or clear

Description	D	W	H	CTN WT	CU FT	① Model	TFL Block	Flat Cut Block	Double Cut Block
Freestanding Above Surface	¼	47¾	23¾	14	4	GPT4824DTS-ACR	\$727		
Acrylic Privacy Screen with Support Block	¼	47¾	23¾	14	4	GPV4824DTS-ACR		\$861	\$874



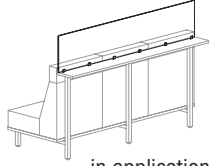
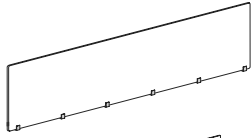
Features:

- sits on top of worksurface
- height above worksurface: 24"
- corners: ¾" radius
- see cleaning guidelines for cleaning information
- stability block dimensions: 1 ½"h x 27"w x 6"d
- ships flat

Options:

- GPT4824DTS-ACR - specify JSI standard laminate
- GPV4824DTS-ACR - specify Flat Cut (cherry, maple or walnut) or Double Cut and Finish

Description	D	W	H	CTN WT	CU FT	1 Model	List Price
Straight Acrylic Add On Screen Kit	¼	89 ¼	15 ½	19	5	GPS1690-ACR	\$1,135



Features:

- bracket attaches to top side of worksurface with hardware and screws
- height above worksurface: 16"
- corners ¾" radius
- see cleaning guidelines for cleaning information
- brackets are satin nickel
- 6 brackets included
- used with: CTL3306, CTL3304

To Order, Specify:

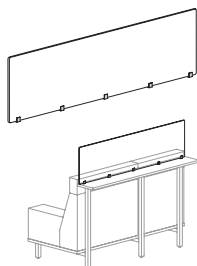
- 1 Model Number
- 2 Acrylic Options: frosted or clear

PRIVACY

To Order, Specify:

1 Laminate Model #		2 Laminate Selection				
Laminate (GPT)	Flat Cut	Solid Patterns: ALB Alabaster BBL Bridal Blanco DWH Designer White SHD Shadow SLG Slate Grey	Wood Grain Patterns: ALL Ale Light BOL Bourbon Light BZW Brazilwood BGL Brighton Light CLL Collectors FAW Fawn	FLO Florence Walnut GRH Graphite MIN Mineral OAT Oatmeal Cookie PIN Pinnacle Walnut STU Studio Teak	UMB Umber VAL Valley VIN Vintage WEA Weathered Ash	
	Double Cut	Cherry: BBM Bourbon Medium BRM Brighton Medium CLA Classic CLL Collectors HRV Harvest PRL Praline	Maple: ALM Ale Medium BUT Butterscotch FLX Flax VEN Venetian	Walnut: ESP Espresso MCH Mocha SIE Sienna TRF Truffle UMB Umber	Black Oak: RAV Raven	
1 Veneer Model #		2 Wood Species		3 Wood Finish		
Veneer (GPV)	Flat Cut	CH1 Cherry MA1 Maple WA1 Walnut BO1 Black Oak				
	Double Cut	DC1 Double Cut				

Description	D	W	H	CTN WT	CU FT	① Model	List Price
Straight Acrylic Add On Screen Kit	¼	69 ¼	15 ½	15	4	GPS1670-ACR	\$911



in application

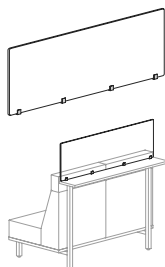
Features:

- bracket attaches to top side of worksurface with hardware and screws
- height above worksurface: 16"
- corners ¾" radius
- see cleaning guidelines for cleaning information
- brackets are satin nickel
- 5 brackets included
- used with: CTL2306WR, CTL2306WL, CTL2306UR, CTL2306UL, CTL2304WR, CTL2304WL, CTL2304UR, CTL2304UL

To Order, Specify:

- ① Model Number
- ② Acrylic Options: frosted or clear

Straight Acrylic Add On Screen Kit	¼	59 ¼	15 ½	14	3	GPS1660-ACR	\$782
---	---	------	------	----	---	--------------------	--------------



in application

Features:

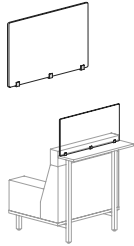
- bracket attaches to top side of worksurface with hardware and screws
- height above worksurface: 16"
- corners ¾" radius
- see cleaning guidelines for cleaning information
- brackets are satin nickel
- 4 brackets included
- used with: CTL2306, CTL2304

To Order, Specify:

- ① Model Number
- ② Acrylic Options: frosted or clear

PRIVACY

Description	D	W	H	CTN WT	CU FT	① Model	List Price
Straight Acrylic Add On Screen Kit	¼	39 ¼	15 ½	10	3	GPS1640-ACR	\$561



in application

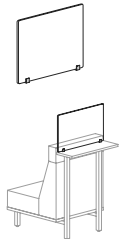
Features:

- bracket attaches to top side of worksurface with hardware and screws
- height above worksurface: 16"
- corners ¾" radius
- see cleaning guidelines for cleaning information
- brackets are satin nickel
- 3 brackets included
- used with: CTL1306WR, CTL1306WL, CTL1306UR, CTL1306UL, CTL1304WR, CTL1304WL, CTL1304UR, CTL1304UL

To Order, Specify:

- ① Model Number
- ② Acrylic Options: frosted or clear

Straight Acrylic Add On Screen Kit	¼	29 ¼	15 ½	8	2	GPS1630-ACR	\$431
---	---	------	------	---	---	--------------------	--------------



in application

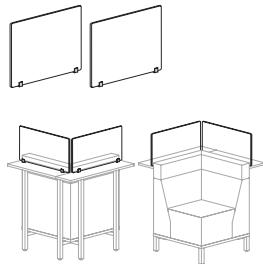
Features:

- bracket attaches to top side of worksurface with hardware and screws
- height above worksurface: 16"
- corners ¾" radius
- see cleaning guidelines for cleaning information
- brackets are satin nickel
- 2 brackets included
- used with: CTL1306, CTL1304

To Order, Specify:

- ① Model Number
- ② Acrylic Options: frosted or clear

Corner Acrylic Add On Screen Kit	¼	31 ¾	15 ½	14	3	GPC1632-ACR	\$864
---	---	------	------	----	---	--------------------	--------------



in application

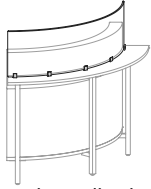
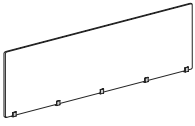
Features:

- bracket attaches to top side of worksurface with hardware and screws
- height above worksurface: 16"
- corners ¾" radius
- see cleaning guidelines for cleaning information
- brackets are satin nickel
- 4 brackets included- 2 per panel
- used with: CTC20T6W, CTC20T6UR, CTC20T6UL, CTC20T6UC, CTC20T4W, CTC20T4UR, CTC20T4UL, CTC20T4UC, CTC20S6UR, CTC20S6UL, CTC20S6UC, CTC20S4UR, CTC20S4UL, CTC20S4UC

To Order, Specify:

- ① Model Number
- ② Acrylic Options: frosted or clear

Description	D	W	H	CTN WT	CU FT	① Model	List Price
Radius Acrylic Add On Screen Kit	¼	69	15½	16	4	GPR1669-ACR	\$911



in application

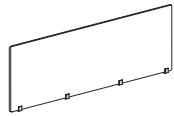
Features:

- bracket attaches to top side of worksurface with hardware and screws
- height above worksurface: 16"
- corners ¾" radius
- see cleaning guidelines for cleaning information
- brackets are satin nickel
- 5 brackets included
- ships flat
- used with: CTI32126, CTI32124

To Order, Specify:

- ① Model Number
- ② Acrylic Options: frosted or clear

Radius Acrylic Add On Screen Kit	¼	60¼	15½	14	4	GPR1661-ACR	\$797
----------------------------------	---	-----	-----	----	---	-------------	-------



in application

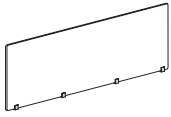
Features:

- bracket attaches to top side of worksurface with hardware and screws
- height above worksurface: 16"
- corners ¾" radius
- see cleaning guidelines for cleaning information
- brackets are satin nickel
- 4 brackets included
- ships flat
- used with: CTI32456, CTI32454

To Order, Specify:

- ① Model Number
- ② Acrylic Options: frosted or clear

Description	D	W	H	CTN WT	CU FT	① Model	List Price
Radius Acrylic Add On Screen Kit	¼	48 ¼	15 ½	11	3	GPR1649-ACR	\$683



in application

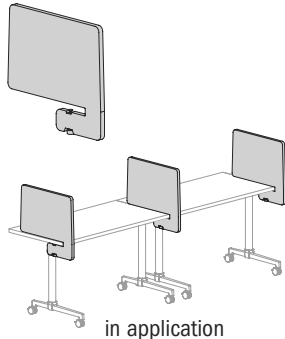
Features:

- bracket attaches to top side of worksurface with hardware and screws
- height above worksurface: 16"
- corners ¾" radius
- see cleaning guidelines for cleaning information
- brackets are satin nickel
- 4 brackets included
- ships flat
- used with: CTI32306, CTI32304

To Order, Specify:

- ① Model Number
- ② Acrylic Options: frosted or clear

Description	D	W	H	CTN WT	CU FT	① Model	List Price
Acoustic PET Portable Slide on Privacy Screen	1	28	29½	14	3	GP2830SL-PET	\$1,078
	1	24	21½	10	2	GP2422SL-PET	\$818



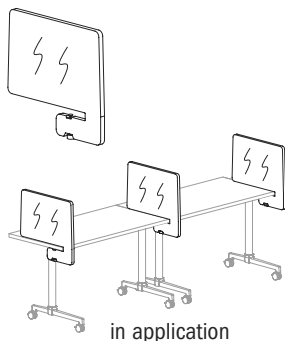
Features:

- slide on to edge of 1" - 1½" worksurface
- hard knob clamps to surface
- minimum worksurface overhang clearance for bracket: 7½"
- height above worksurface: 16" for GP2422SL-PET and 24" for GP2830SL-PET
- see cleaning guidelines for cleaning information

To Order, Specify:

- ① Model Number
- ② PET Color: ash grey or silver grey

Markerboard Portable Slide on Privacy Screen	1 ¼	28	29½	26	3	GP2830SL-PMB	\$940
---	-----	----	-----	----	---	---------------------	--------------



Features:

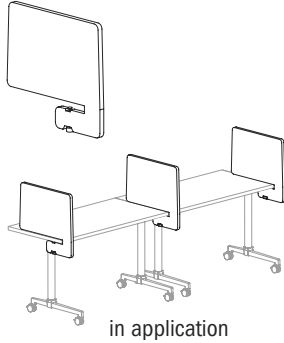
- slide on to edge of 1" - 1½" worksurface
- hard knob clamps to surface
- minimum worksurface overhang clearance for bracket: 7½"
- height above worksurface: 24"
- plywood core
- edges are white PVC

To Order, Specify:

- ① Model Number

PRIVACY

Description	D	W	H	CTN WT	CU FT	1 Model	List Price
HPL Laminate Portable Slide on Privacy Screen	1 1/16	28	29 1/2	26	3	GP2830SL-PHPL	\$991


Features:

- slide on to edge of 1" - 1 1/2" worksurface
- hard knob clamps to surface
- minimum worksurface overhang clearance for bracket: 7 1/2"
- height above worksurface: 24"
- plywood core
- edges are matching PVC

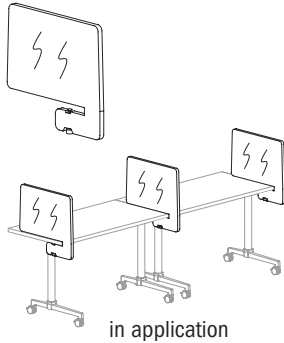
To Order, Specify:

- 1 Model Number
- 2 Laminate Color

2 Laminate Color

Solid Patterns:		Wood Grain Patterns:					
ALB Alabaster	ALL Ale Light	CLL Collectors	MIN Mineral	UMB Umber			
BBL Bridal Bianco	BOL Bourbon Light	FAW Fawn	OAT Oatmeal Cookie	VAL Valley			
DWH Designer White	BZW Brazilwood	FLO Florence Walnut	PIN Pinnacle Walnut	VIN Vintage			
SHD Shadow	BGL Brighton Light	GRH Graphite	STU Studio Teak	WEA Weathered Ash			
SLG Slate Grey							

Dual Magnetic Markerboard	1	28	29 1/2	14	3	GP2830SL-PETMB	\$1,590
Portable Slide on Privacy Screen	1	24	21 1/2	10	2	GP2422SL-PETMB	\$1,078

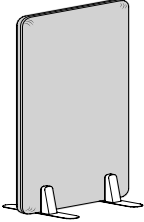
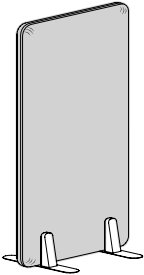
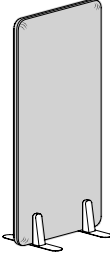

Features:

- slide on to edge of 1" - 1 1/2" worksurface
- hard knob clamps to surface
- minimum worksurface overhang clearance for bracket: 7 1/2"
- height above worksurface: 24"
- exposed edges in PET silver grey
- see cleaning guidelines for cleaning information

To Order, Specify:

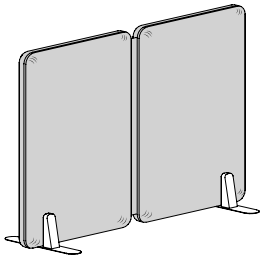
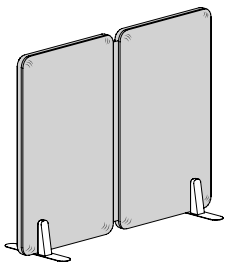
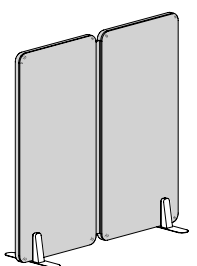
- 1 Model Number

Poufy - Freestanding Upholstered Screens

Description	D	W	H	CTN WT	CU FT	① Model	List Price Per Grade
60"h Single - Poufy Freestanding Upholstered Screen 	2 1/8	48	60	73	9	INF4860-1SUP	COM \$1,819 A \$1,891 B \$2,029 C \$2,275 D \$2,588 E \$2,902 F \$3,391 G \$3,914 H \$4,473 I \$5,345 J \$6,392
Features: <ul style="list-style-type: none"> two metal bases with solid maple supports maple solid wood supports standard walnut or white oak solid wood supports available, specify and add \$189 list heavy cushioned surface not recommended for tacking upholstery can only be cut up the roll for 60"h freestanding screens com ydg: 6 3/4 see cleaning guidelines for cleaning information Options: <ul style="list-style-type: none"> specify upholstery specify wood species and finish specify metal finish 							
60"h Single - Poufy Freestanding Upholstered Screen 	2 1/8	36	60	60	7	INF3660-1SUP	COM \$1,686 A \$1,744 B \$1,858 C \$2,056 D \$2,313 E \$2,568 F \$2,966 G \$3,393 H \$3,847 I \$4,560 J \$5,411
Features: <ul style="list-style-type: none"> two metal bases with solid maple supports maple solid wood supports standard walnut or white oak solid wood supports available, specify and add \$189 list heavy cushioned surface not recommended for tacking upholstery can only be cut up the roll for 60"h freestanding screens com ydg: 5 1/2 see cleaning guidelines for cleaning information Options: <ul style="list-style-type: none"> specify upholstery specify wood species and finish specify metal finish 							
60"h Single - Poufy Freestanding Upholstered Screen 	2 1/8	30	60	50	6	INF3060-1SUP	COM \$1,487 A \$1,539 B \$1,643 C \$1,824 D \$2,056 E \$2,289 F \$2,651 G \$3,039 H \$3,454 I \$4,099 J \$4,874
Features: <ul style="list-style-type: none"> two metal bases with solid maple supports maple solid wood supports standard walnut or white oak solid wood supports available, specify and add \$189 list heavy cushioned surface not recommended for tacking upholstery can only be cut up the roll for 60"h freestanding screens com ydg: 5 see cleaning guidelines for cleaning information Options: <ul style="list-style-type: none"> specify upholstery specify wood species and finish specify metal finish 							

PRIVACY

Poufy - Freestanding Upholstered Screens

Description	D	W	H	CTN WT	CU FT	① Model	List Price Per Grade	
60" h Double - Poufy Freestanding Upholstered Screen 	2 1/8	98	60	134	12	INF4860-2SUP	COM \$2,842	
	Features: <ul style="list-style-type: none"> two metal bases with solid maple supports maple solid wood supports standard walnut or white oak solid wood supports available, specify and add \$189 list heavy cushioned surface not recommended for tacking upholstery can only be cut up the roll for 60" h freestanding screens com ydg: 10 1/4 see cleaning guidelines for cleaning information 							A \$2,949
								B \$3,162
								C \$3,532
								D \$4,008
								E \$4,487
								F \$5,228
								G \$6,023
								H \$6,871
	Options: <ul style="list-style-type: none"> specify upholstery specify wood species and finish specify metal finish 							I \$8,196
							J \$9,786	
60" h Double - Poufy Freestanding Upholstered Screen 	2 1/8	74	60	107	10	INF3660-2SUP	COM \$2,649	
	Features: <ul style="list-style-type: none"> two metal bases with solid maple supports maple solid wood supports standard walnut or white oak solid wood supports available, specify and add \$189 list heavy cushioned surface not recommended for tacking upholstery can only be cut up the roll for 60" h freestanding screens com ydg: 8 1/2 see cleaning guidelines for cleaning information 							A \$2,737
								B \$2,914
								C \$3,222
								D \$3,617
								E \$4,013
								F \$4,627
								G \$5,286
								H \$5,991
	Options: <ul style="list-style-type: none"> specify upholstery specify wood species and finish specify metal finish 							I \$7,088
							J \$8,408	
60" h Double - Poufy Freestanding Upholstered Screen 	2 1/8	62	60	89	9	INF3060-2SUP	COM \$2,240	
	Features: <ul style="list-style-type: none"> two metal bases with solid maple supports maple solid wood supports standard walnut or white oak solid wood supports available, specify and add \$189 list heavy cushioned surface not recommended for tacking upholstery can only be cut up the roll for 60" h freestanding screens com ydg: 7 1/4 see cleaning guidelines for cleaning information 							A \$2,315
								B \$2,467
								C \$2,728
								D \$3,064
								E \$3,403
								F \$3,928
								G \$4,490
								H \$5,090
	Options: <ul style="list-style-type: none"> specify upholstery specify wood species and finish specify metal finish 							I \$6,027
							J \$7,151	

To Order, Specify:

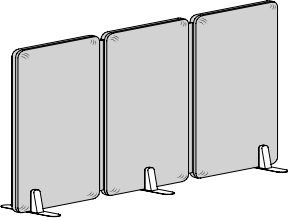
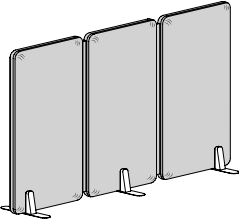
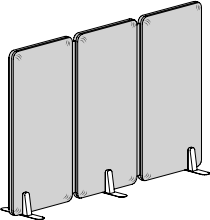
- ① Model Number
- ② Wood Species:
 - a.) STANDARD Maple (M)
 - b.) PREMIUM Walnut (W) - upcharge applies
 - c.) PREMIUM White Oak (WK1) - upcharge applies
- ③ Finish
 - a.) Maple Finish
 - b.) Walnut Finish
 - c.) White Oak Finish
- ④ Fabric Selection - vendor, pattern and color
- ⑤ Metal Color - Arctic Silver (ASL), Matte Black (MBK), Pewter (PEW) or Soft Nickel (SNK)

Specifications

- two 12mm sandwiched birch plywood panel frames
- 1/2" polyurethane foam surface cushions on both faces
- living hinge is high density polyethylene with sewn upholstery
- solid hardwood supports
- 12 gauge metal base feet

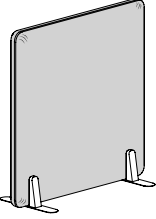
Note: Walnut and White Oak Solid hardwoods are PREMIUM materials and upcharges apply. Associated upcharges are located in bullet points under units where applicable.

Poufy - Freestanding Upholstered Screens

Description	D	W	H	CTN WT	CU FT	① Model	List Price Per Grade
60" h Triple - Poufy Freestanding Upholstered Screen 	2 1/8	148	60	199	16	INF4860-3SUP	COM \$4,098
	Features: <ul style="list-style-type: none"> two metal bases with solid maple supports maple solid wood supports standard walnut or white oak solid wood supports available, specify and add \$189 list heavy cushioned surface not recommended for tacking upholstery can only be cut up the roll for 60" h freestanding screens com ydg: 14 see cleaning guidelines for cleaning information Options: <ul style="list-style-type: none"> specify upholstery specify wood species and finish specify metal finish 						A \$4,243 B \$4,534 C \$5,039 D \$5,691 E \$6,342 F \$7,357 G \$8,441 H \$9,601 I \$11,411 J \$13,581
60" h Triple - Poufy Freestanding Upholstered Screen 	2 1/8	112	60	158	13	INF3660-3SUP	COM \$3,360
	Features: <ul style="list-style-type: none"> two metal bases with solid maple supports maple solid wood supports standard walnut or white oak solid wood supports available, specify and add \$189 list heavy cushioned surface not recommended for tacking upholstery can only be cut up the roll for 60" h freestanding screens com ydg: 11 3/4 see cleaning guidelines for cleaning information Options: <ul style="list-style-type: none"> specify upholstery specify wood species and finish specify metal finish 						A \$3,483 B \$3,726 C \$4,152 D \$4,699 E \$5,245 F \$6,095 G \$7,007 H \$7,979 I \$9,499 J \$11,321
60" h Triple - Poufy Freestanding Upholstered Screen 	2 1/8	94	60	132	11	INF3060-3SUP	COM \$3,292
	Features: <ul style="list-style-type: none"> two metal bases with solid maple supports maple solid wood supports standard walnut or white oak solid wood supports available, specify and add \$189 list heavy cushioned surface not recommended for tacking upholstery can only be cut up the roll for 60" h freestanding screens com ydg: 10 3/4 see cleaning guidelines for cleaning information Options: <ul style="list-style-type: none"> specify upholstery specify wood species and finish specify metal finish 						A \$3,403 B \$3,627 C \$4,015 D \$4,515 E \$5,015 F \$5,794 G \$6,627 H \$7,517 I \$8,907 J \$10,573

PRIVACY

Poufy - Freestanding Upholstered Screens

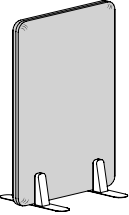
Description	D	W	H	CTN WT	CU FT	① Model	List Price Per Grade
48" Single - Poufy Freestanding Upholstered Screen 	2 7/8	48	48	62	7	INF4848-1SUP	COM \$1,713
							A \$1,774
							B \$1,894
							C \$2,103
							D \$2,369
							E \$2,637
							F \$3,053
							G \$3,499
							H \$3,975
							I \$4,718
J \$5,609							

Features:

- two metal bases with solid maple supports
- maple solid wood supports standard
- walnut or white oak solid wood supports available, specify and add \$189 list
- heavy cushioned surface not recommended for tacking
- com ydg: 5 3/4
- see cleaning guidelines for cleaning information
- specify upholstery

Options:

- specify wood species and finish
- specify metal finish

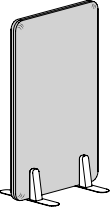
48" Single - Poufy Freestanding Upholstered Screen 	2 7/8	36	48	51	6	INF3648-1SUP	COM \$1,605
							A \$1,655
							B \$1,753
							C \$1,924
							D \$2,146
							E \$2,367
							F \$2,711
							G \$3,079
							H \$3,471
							I \$4,086
J \$4,822							

Features:

- two metal bases with solid maple supports
- maple solid wood supports standard
- walnut or white oak solid wood supports available, specify and add \$189 list
- heavy cushioned surface not recommended for tacking
- com ydg: 4 3/4
- see cleaning guidelines for cleaning information
- specify upholstery

Options:

- specify wood species and finish
- specify metal finish

48" Single - Poufy Freestanding Upholstered Screen 	2 7/8	30	48	44	5	INF3048-1SUP	COM \$1,474
							A \$1,522
							B \$1,616
							C \$1,778
							D \$1,988
							E \$2,197
							F \$2,523
							G \$2,872
							H \$3,245
							I \$3,826
J \$4,525							

Features:

- two metal bases with solid maple supports
- maple solid wood supports standard
- walnut or white oak solid wood supports available, specify and add \$189 list
- heavy cushioned surface not recommended for tacking
- com ydg: 4 1/2
- see cleaning guidelines for cleaning information
- specify upholstery

Options:

- specify wood species and finish
- specify metal finish

To Order, Specify:

- ① Model Number
- ② Wood Species:
 - a.) STANDARD Maple (M)
 - b.) PREMIUM Walnut (W) - upcharge applies
 - c.) PREMIUM White Oak (WK1) - upcharge applies
- ③ Finish
 - a.) Maple Finish
 - b.) Walnut Finish
 - c.) White Oak Finish
- ④ Fabric Selection - vendor, pattern and color
- ⑤ Metal Color - Arctic Silver (ASL), Matte Black (MBK), Pewter (PEW) or Soft Nickel (SNK)

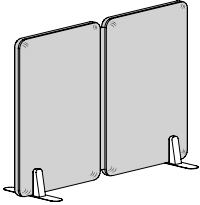
Specifications

- two 12mm sandwiched birch plywood panel frames
- 1/2" polyurethane foam surface cushions on both faces
- living hinge is high density polyethylene with sewn upholstery
- solid hardwood supports
- 12 gauge metal base feet

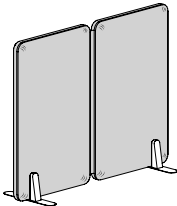
Note: Walnut and White Oak Solid hardwoods are PREMIUM materials and upcharges apply. Associated upcharges are located in bullet points under units where applicable.

Poufy - Freestanding Upholstered Screens

Description	D	W	H	CTN WT	CU FT	① Model	List Price Per Grade
48" h Double - Poufy Freestanding Upholstered Screen	2 1/8	98	48	112	10	INF4848-2SUP	COM \$2,643
Features: <ul style="list-style-type: none"> · two metal bases with solid maple supports · maple solid wood supports standard · walnut or white oak solid wood supports available, specify and add \$189 list · heavy cushioned surface not recommended for tacking · com ydg: 8 1/2 · see cleaning guidelines for cleaning information · specify upholstery 							A \$2,731
Options: <ul style="list-style-type: none"> · specify wood species and finish · specify metal finish 							B \$2,908
							C \$3,215
							D \$3,611
							E \$4,006
							F \$4,622
							G \$5,281
							H \$5,985
							I \$7,083
							J \$8,400

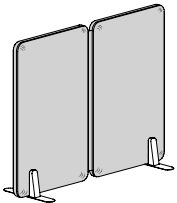


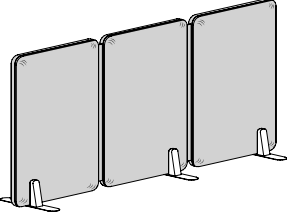
48" h Double - Poufy Freestanding Upholstered Screen	2 1/8	74	48	89	8	INF3648-2SUP	COM \$2,499
Features: <ul style="list-style-type: none"> · two metal bases with solid maple supports · maple solid wood supports standard · walnut or white oak solid wood supports available, specify and add \$189 list · heavy cushioned surface not recommended for tacking · com ydg: 7 1/4 · see cleaning guidelines for cleaning information · specify upholstery 							A \$2,575
Options: <ul style="list-style-type: none"> · specify wood species and finish · specify metal finish 							B \$2,726
							C \$2,987
							D \$3,325
							E \$3,662
							F \$4,188
							G \$4,749
							H \$5,349
							I \$6,287
							J \$7,410



PRIVACY

48" h Double - Poufy Freestanding Upholstered Screen	2 1/8	62	48	76	7	INF3048-2SUP	COM \$2,195
Features: <ul style="list-style-type: none"> · two metal bases with solid maple supports · maple solid wood supports standard · walnut or white oak solid wood supports available, specify and add \$189 list · heavy cushioned surface not recommended for tacking · com ydg: 6 3/4 · see cleaning guidelines for cleaning information · specify upholstery 							A \$2,258
Options: <ul style="list-style-type: none"> · specify wood species and finish · specify metal finish 							B \$2,383
							C \$2,600
							D \$2,879
							E \$3,159
							F \$3,592
							G \$4,057
							H \$4,554
							I \$5,329
							J \$6,261



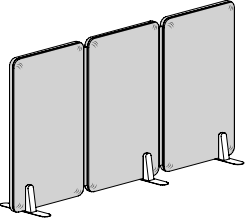
Description	D	W	H	CTN WT	CU FT	① Model	List Price Per Grade
48" Triple - Poufy Freestanding Upholstered Screen 	2 7/8	148	48	166	13	INF4848-3SUP	COM \$3,805
							A \$3,926
							B \$4,164
							C \$4,579
							D \$5,114
							E \$5,650
							F \$6,483
							G \$7,374
							H \$8,326
							I \$9,812
J \$11,597							

Features:

- two metal bases with solid maple supports
- maple solid wood supports standard
- walnut or white oak solid wood supports available, specify and add \$189 list
- heavy cushioned surface not recommended for tacking
- com ydg: 11 1/2
- see cleaning guidelines for cleaning information
- specify upholstery

Options:

- specify wood species and finish
- specify metal finish

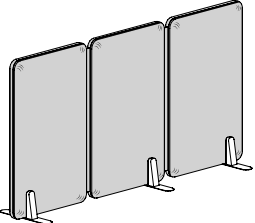
48" Triple - Poufy Freestanding Upholstered Screen 	2 7/8	112	48	131	11	INF3648-3SUP	COM \$3,607
							A \$3,708
							B \$3,911
							C \$4,263
							D \$4,718
							E \$5,172
							F \$5,878
							G \$6,633
							H \$7,440
							I \$8,700
J \$10,213							

Features:

- two metal bases with solid maple supports
- maple solid wood supports standard
- walnut or white oak solid wood supports available, specify and add \$189 list
- heavy cushioned surface not recommended for tacking
- com ydg: 9 3/4
- see cleaning guidelines for cleaning information
- specify upholstery

Options:

- specify wood species and finish
- specify metal finish

48" Triple - Poufy Freestanding Upholstered Screen 	2 7/8	94	48	112	9	INF3048-3SUP	COM \$3,211
							A \$3,304
							B \$3,483
							C \$3,801
							D \$4,207
							E \$4,615
							F \$5,247
							G \$5,927
							H \$6,651
							I \$7,782
J \$9,139							

Features:

- two metal bases with solid maple supports
- maple solid wood supports standard
- walnut or white oak solid wood supports available, specify and add \$189 list
- heavy cushioned surface not recommended for tacking
- com ydg: 8 3/4
- see cleaning guidelines for cleaning information
- specify upholstery

Options:

- specify wood species and finish
- specify metal finish

To Order, Specify:

- ① Model Number
- ② Wood Species:
 - a.) STANDARD Maple (M)
 - b.) PREMIUM Walnut (W) - upcharge applies
 - c.) PREMIUM White Oak (WK1) - upcharge applies
- ③ Finish
 - a.) Maple Finish
 - b.) Walnut Finish
 - c.) White Oak Finish
- ④ Fabric Selection - vendor, pattern and color
- ⑤ Metal Color - Arctic Silver (ASL), Matte Black (MBK), Pewter (PEW) or Soft Nickel (SNK)

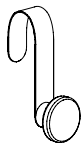
Specifications

- two 12mm sandwiched birch plywood panel frames
- 1/2" polyurethane foam surface cushions on both faces
- living hinge is high density polyethylene with sewn upholstery
- solid hardwood supports
- 12 gauge metal base feet

Note: Walnut and White Oak Solid hardwoods are PREMIUM materials and upcharges apply. Associated upcharges are located in bullet points under units where applicable.

Freestanding Screen Accessories

Description	D	W	H	CTN WT	CU FT	① Model	List Price
Knob - Freestanding Screen Accessory	3 7/8	2 1/2	7	2	1	INA0307F-KNOB	\$240



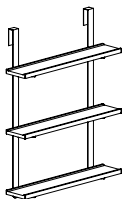
Features:

- supported by a metal hook
- solid maple knob standardmaximum weight rating 10 lbs. (evenly distributed load)

Options:

- solid walnut or white knob available, specify and add \$21 list
- specify wood species and finish
- specify metal finish

Shelves - Freestanding Screen Accessory	6 5/8	24	32	9	4	INA2432F-3SHELF	\$818
	6 5/8	24	20	7	3	INA2420F-2SHELF	\$641
	6 5/8	24	8	5	2	INA2408F-1SHELF	\$456



-3SHELF shown

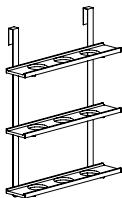
Features:

- supported by two metal hooks
- shelf depth 4 3/4"
- solid maple shelves standardmaximum weight rating 10 lbs. per shelf (evenly distributed load)

Options:

- walnut or white oak shelves available, -3SHELF specify and add \$115 list, -2SHELF specify and add \$78 list or -1SHELF specify and add \$41 list
- specify wood species and finish
- specify metal finish

Planter Shelves - Freestanding Screen Accessory	6 5/8	24	32	9	4	INA2432F-3PLANTER	\$860
	6 5/8	24	20	7	3	INA2420F-2PLANTER	\$670
	6 5/8	24	8	5	2	INA2408F-1PLANTER	\$469



-3PLANTER shown

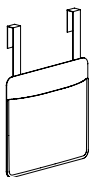
Features:

- supported by two metal hooks
- planter shelf with 3 1/2" holes for plant containers
- solid maple planter shelves standardmaximum weight rating 10 lbs. per shelf (evenly distributed load)

Options:

- walnut or white oak shelves available, -3PLANTER specify and add \$115 list, -2PLANTER specify and add \$78 list or -1PLANTER specify and add \$41 list
- specify wood species and finish
- specify metal finish

Pouch - Freestanding Screen Accessory	3 3/8	14	20	2	1	INA1111F-POUCH	\$539
--	-------	----	----	---	---	----------------	-------



Features:

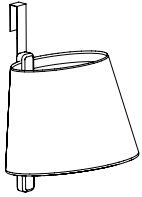
- supported by two metal hooks
- aniline dye leather
- maximum weight rating 10 lbs. per shelf (evenly distributed load)

Options:

- specify metal finish

PRIVACY

Description	D	W	H	CTN WT	CU FT	① Model	List Price
Sconce Lamp - Freestanding Screen Accessory	17 7/8	15	22	9	4	INA1522F-SCONCE	\$777



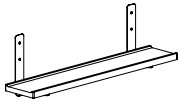
Features:

- supported by a metal hook
- 15' cord
- cord mounted rocker on/off switch - three prong plug fabric power cord
- on/off switch on 32" from light - field assembly required
- maximum 60 watt light bulb, NOT included/LED bulb recommended

Options:

- specify wood species and finish
- specify mode upholstery color for shade
- specify cord color
- specify metal finish

Tray - Poufy and Square Upholstered Wall Mound Tile Accessory	4 3/4	24	1	5	2	INA0524T	\$392
---	-------	----	---	---	---	----------	-------



Features:

- for use with square laminate marker, cork and tackable screen accessories
- supported by two metal brackets
- tray can be field installed on any 24" or wider tile except glass marker tiles
- tray can not be installed on intermediate positioned tiles (space is required below tile for clearance)
- maximum weight rating 10 lbs. per shelf (evenly distributed load)

Options:

- walnut or white oak sconce support available, specify and add \$41 list
- specify wood species and finish

To Order, Specify:

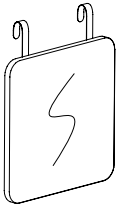
- ① Model Number

Specifications

- extruded PVC 1/2" thick panel
- natural cork 1/4" thick tackable face
- extruded aluminum mounting Z clips

Freestanding Screen Accessories

Description	D	W	H	CTN WT	CU FT	① Model	List Price
Square - Laminate Marker Tile Freestanding Screen Accessory	27 ⁸ / ₈	24	24	17	2	INA2424F-SQM	\$546



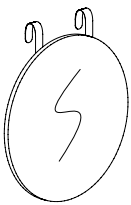
Features:

- supported by two metal hooks
- white markerboard high pressure laminate
- white edge band

Options:

- specify metal finish

Round - Laminate Marker Tile Freestanding Screen Accessory	27 ⁸ / ₈	24	24	17	2	INA24F-RDM	\$539
---	--------------------------------	----	----	----	---	------------	-------



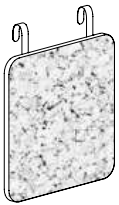
Features:

- supported by two metal hooks
- white markerboard high pressure laminate
- white edge band

Options:

- specify metal finish

Square - Cork Tile Freestanding Screen Accessory	27 ⁸ / ₈	24	24	8	2	INA2424F-SQC	\$512
---	--------------------------------	----	----	---	---	--------------	-------



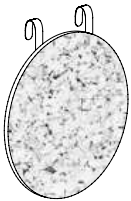
Features:

- supported by two metal hooks
- extruded PVC 1/2" thick panel
- natural cork 1/4" thick tackable face

Options:

- specify metal finish

Round - Cork Tile Freestanding Screen Accessory	27 ⁸ / ₈	24	24	7	2	INA24F-RDC	\$512
--	--------------------------------	----	----	---	---	------------	-------



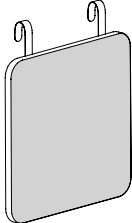
Features:

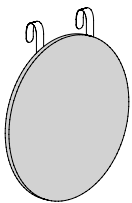
- supported by two metal hooks
- extruded PVC 1/2" thick panel
- natural cork 1/4" thick tackable face

Options:

- specify metal finish

PRIVACY

Description	D	W	H	CTN WT	CU FT	1 Model	List Price Per Grade	
Square - Tackboard Tile Free-standing Screen Accessory 	27½	24	24	11	2	INA2424F-SQUT	COM \$505	
	Features:							A \$515
	· supported by two metal hooks							B \$537
	· ½" soft tack core face							C \$573
	· ¼" hardwood backer panel							D \$619
	· covered with surface glued and staple upholstery							E \$667
	· com ydg: 1 ½"							F \$738
	Options:							G \$816
	· specify upholstery							H \$898
	· specify metal finish							I \$1,028
								J \$1,183

Round - Tackboard Tile Free-standing Screen Accessory 	27½	24	24	11	2	INA24F-RDUT	COM \$506	
	Features:							A \$523
	· supported by two metal hooks							B \$553
	· ½" soft tack core face							C \$607
	· ¼" hardwood backer panel							D \$677
	· covered with surface glued and staple upholstery							E \$748
	· com ydg: 1 ½"							F \$855
	Options:							G \$972
	· specify upholstery							H \$1,097
	· specify metal finish							I \$1,290
								J \$1,524

To Order, Specify:

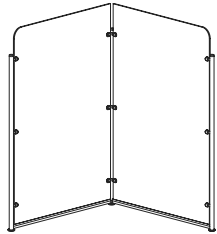
- 1 Model Number
- 2 Wood Species:
 - a.) STANDARD Maple (M)
 - b.) PREMIUM Walnut (W) - upcharge applies
 - c.) PREMIUM White Oak (WK1) - upcharge applies
- 3 Finish
 - a.) Maple Finish
 - b.) Walnut Finish
 - c.) White Oak Finish
- 4 Fabric Selection - vendor, pattern and color
- 5 Metal Color - Arctic Silver (ASL), Matte Black (MBK), Pewter (PEW) or Soft Nickel (SNK)

Specifications

- two 12mm sandwiched birch plywood panel frames
- ½" polyurethane foam surface cushions on both faces
- living hinge is high density polyethylene with sewn upholstery
- solid hardwood supports
- 12 gauge metal base feet

Note: Walnut and White Oak Solid hardwoods are PREMIUM materials and upcharges apply. Associated upcharges are located in bullet points under units where applicable.

Description	D	W	H	CTN WT	CU FT	① Model	List Price
Frosted Acrylic Freestanding Fixed Screen	42	42	64	100	44	CL4242-64PP-ACR	\$3,691



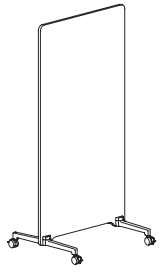
Features:

- slider glides for easy mobility
- ships kd
- frame is arctic silver

To Order, Specify:

- ① Model Number

TFL Freestanding Mobile Screen	¾	48	72	95	16	GP4872MS-TFL	\$1,547
	¾	42	72	86	15	GP4272MS-TFL	\$1,519
	¾	36	72	75	13	GP3672MS-TFL	\$1,490



Features:

- overall height: 72"
- base allows for offset nesting
- locking casters
- see cleaning guidelines for cleaning information

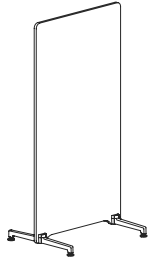
To Order, Specify:

- ① Model Number
- ② Laminate Color
- ③ Metal Finish

② Laminate Color

Solid Patterns:		Wood Grain Patterns:				
ALB Alabaster	ALL Ale Light	CLL Collectors	MIN Mineral	UMB Umber		
BBL Bridal Blanco	BOL Bourbon Light	FAW Fawn	OAT Oatmeal Cookie	VAL Valley		
DWH Designer White	BZW Brazilwood	FLO Florence Walnut	PIN Pinnacle Walnut	VIN Vintage		
SHD Shadow	BGL Brighton Light	GRH Graphite	STU Studio Teak	WEA Weathered Ash		
SLG Slate Grey						

TFL Freestanding Fixed Screen	¾	48	72	95	16	GP4872FS-TFL	\$1,504
	¾	42	72	86	15	GP4272FS-TFL	\$1,473
	¾	36	72	75	13	GP3672FS-TFL	\$1,447



Features:

- overall height: 72"
- base allows for offset nesting
- see cleaning guidelines for cleaning information

To Order, Specify:

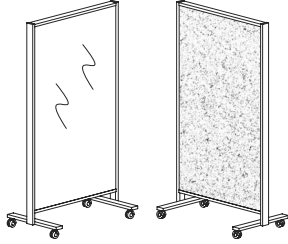
- ① Model Number
- ② Laminate Color
- ③ Metal Finish

② Laminate Color

Solid Patterns:		Wood Grain Patterns:				
ALB Alabaster	ALL Ale Light	CLL Collectors	MIN Mineral	UMB Umber		
BBL Bridal Blanco	BOL Bourbon Light	FAW Fawn	OAT Oatmeal Cookie	VAL Valley		
DWH Designer White	BZW Brazilwood	FLO Florence Walnut	PIN Pinnacle Walnut	VIN Vintage		
SHD Shadow	BGL Brighton Light	GRH Graphite	STU Studio Teak	WEA Weathered Ash		
SLG Slate Grey						

PRIVACY

Description	D	W	H	CTN WT	CU FT	① Model	List Price
Freestanding Mobile Screen	24	42	75	162	58	NAB2442-75MMB	\$4,334



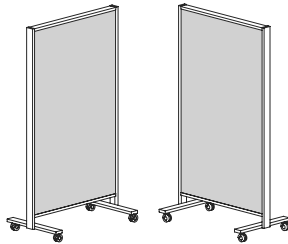
Features:

- four non-locking casters
- base allows for offset nesting

To Order, Specify:

- ① Model Number
- ② Markerboard or Cork Board
- ③ Metal Finish: matte black or arctic silver

Description	D	W	H	CTN WT	CU FT	① Model	List Price Per Grade
Freestanding Mobile Screen - Tackboard One Side	24	42	75	162	58	NAB2442-75MTKD	COM \$4,418



Features:

- four non-locking casters
- base allows for offset nesting

To Order, Specify:

- ① Model Number
- ② Fabric Selection
- ③ Metal Finish: matte black or arctic silver

- A \$4,473
- B \$4,578
- C \$4,765
- D \$5,005
- E \$5,243
- F \$5,614
- G \$6,013
- H \$6,439
- I \$7,104
- J \$7,900

Privacy Solutions - Cleaning Guidelines

We offer numerous textile and hard surface options that will stand up to the rigors of frequent bleach cleaning, ranging from untreated surfaces to those with anti-microbial topcoats. Please contact our Customer Support Team today for more information.

MATERIALS:

ACRYLIC: water based foam or cleaner and bleach cleanable (5:1)*

ACOUSTIC PET: bleach solution cleanable (2% bleach)*

HPL LAMINATE: recommended by suppliers: Clorox Healthcare Bleach Germicidal wipes, Virex II 256, PDI Super Sani-Cloth wipes, PDI Sani-Prime Germicidal spray

TFL LAMINATE: cleaning guidelines will vary between manufacturer; cleaning details available upon request

ENEER: first clean with warm soapy water - do not soak. Pledge Antibacterial cleaner or bleach free disinfectant wipes are recommended

COATED FABRIC: water based foam or cleaner and bleach cleanable (4:1)*

FABRIC: cleaning guidelines will vary between fabric type, pattern and manufacturer; see material recommendations for bleach-solution cleanable fabrics

*Bleach solution cleanable:

Complies with BIFMA HCF 8.1 guidelines

Important to rinse repeatedly with cool, clean water after cleaning to remove all residue. More cleaning details from raw material suppliers available upon request

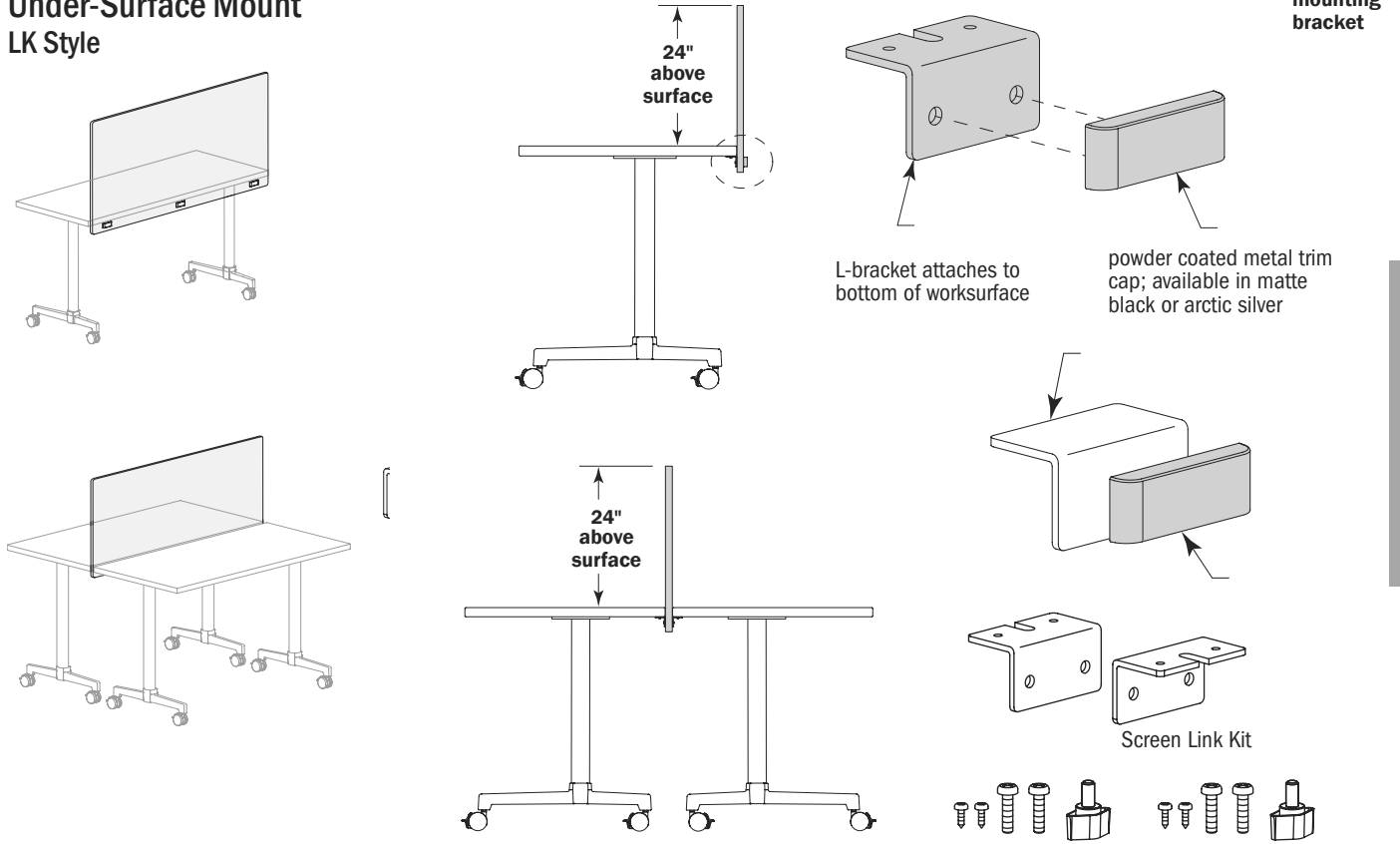
All surfaces with the exception of some fabrics can be cleaned with Clorox Healthcare Bleach Germicidal Wipes as well as bleach free wipes. This includes all coated fabric, laminate, acrylic and metal surfaces.

Privacy Solutions Product Information

Screen Mounting

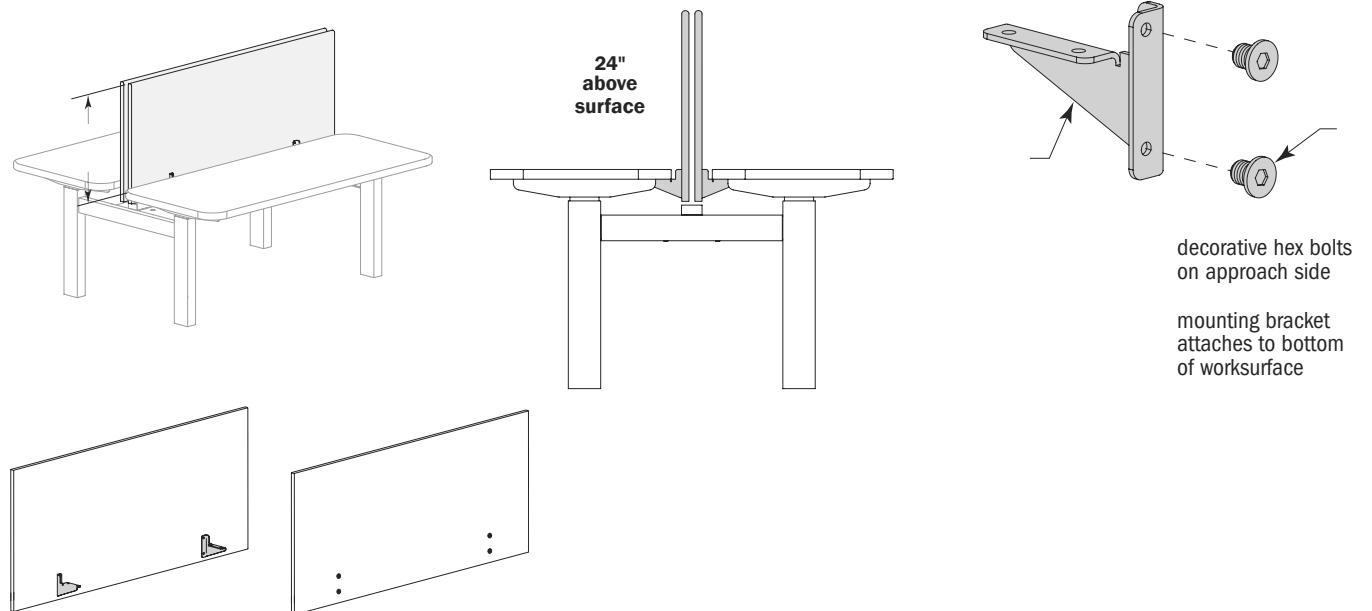
- screens supported by brackets with powder coated cover plates to underside of top
- mounting brackets slide out for routing cables to underside of top or to install monitor arm
- screens available for approach and end of table applications
- screen link kits available (see below) for shared privacy screen application between two tables approach or end applications
- screens must be removed before tilting

Under-Surface Mount LK Style



PRIVACY

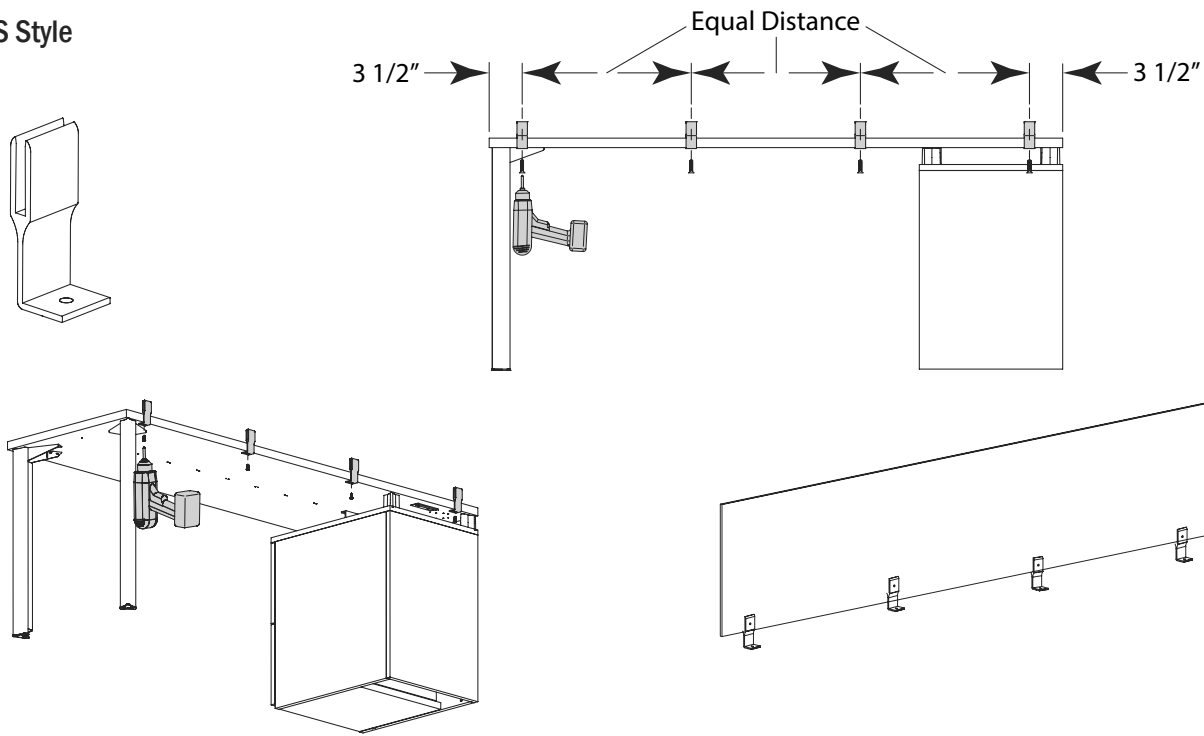
FX Style



Privacy Solutions Product Information

Under-Surface Mount

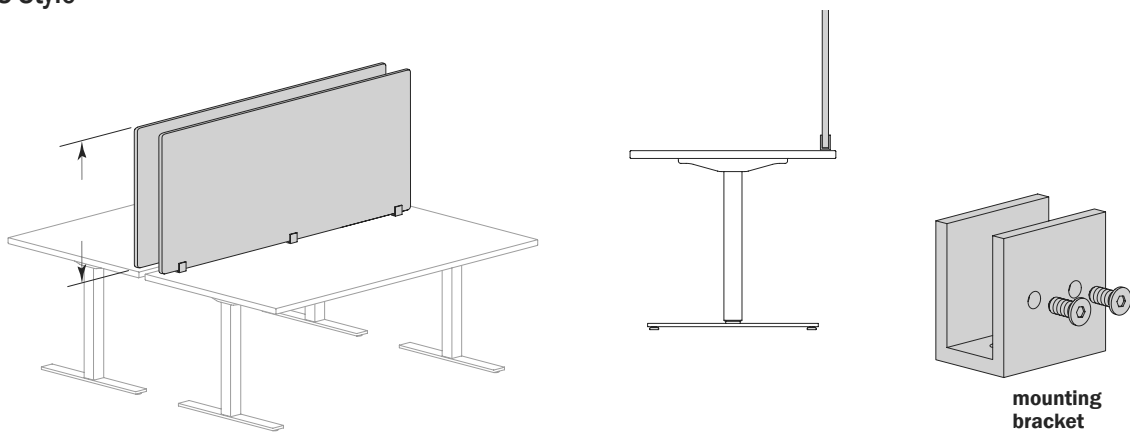
SS Style



PRIVACY

Above-Surface Mount

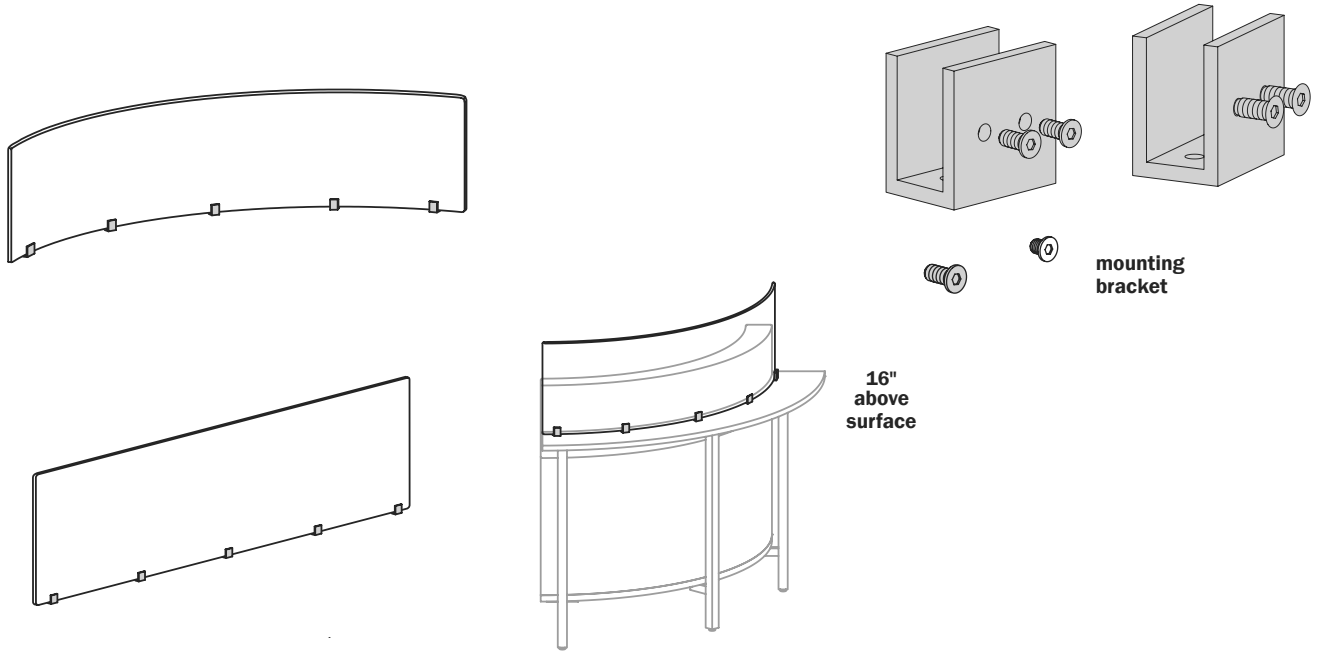
VS Style



Privacy Solutions Product Information

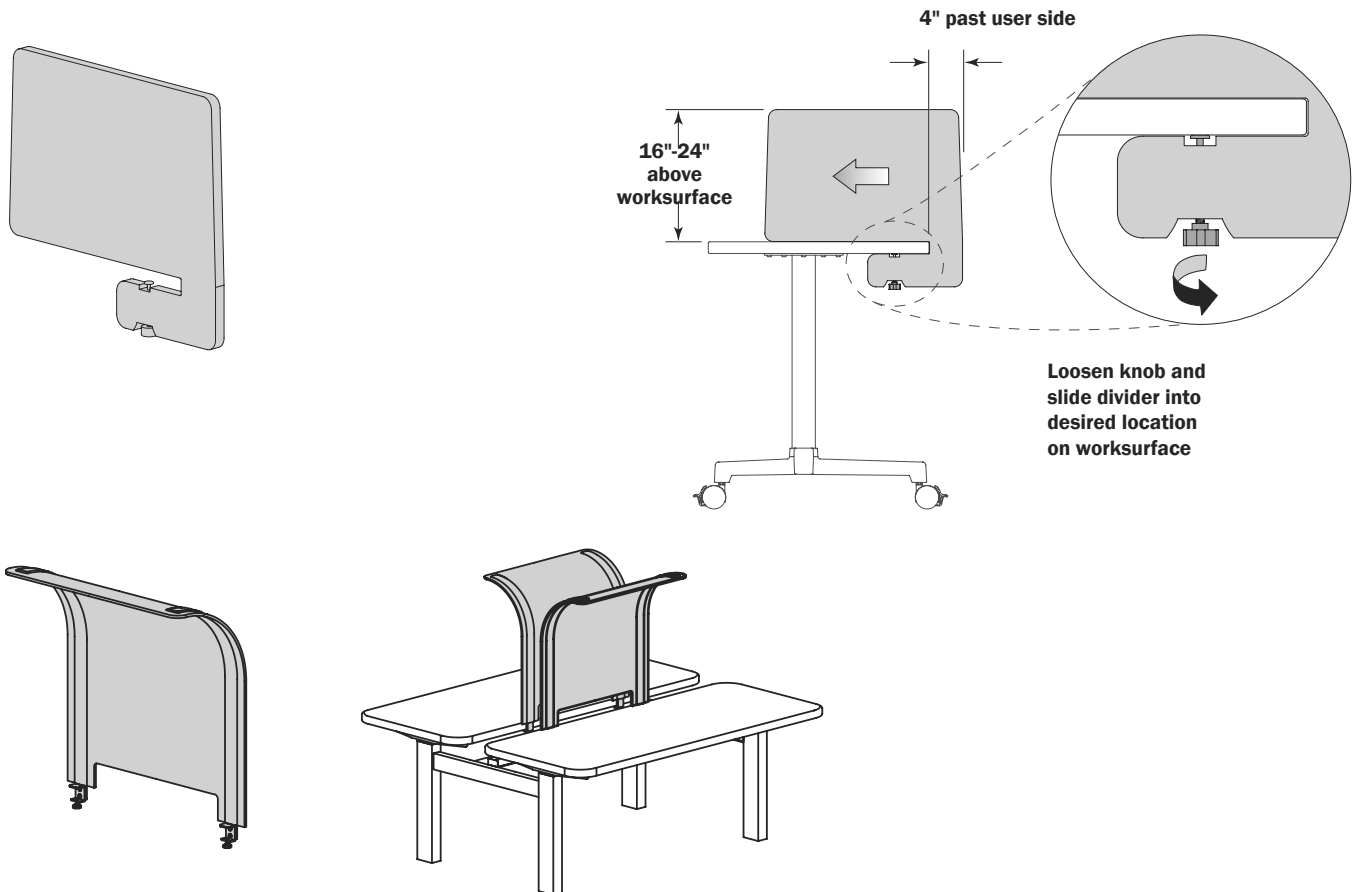
Above-Surface Mount

Connect Style



PRIVACY

Side-Mount



Prost Occasional Tables Order Check List:



Specify:

- 1. Model Number
- 2. Material Selection
 - a.) Laminate
 - 1.) Laminate Color - See list below
 - b.) Veneer
 - 1.) Wood Species - Cherry (CH1), Maple (MA1), Walnut (WA1) Black Oak (BO1) or Double Cut (DC1)
 - 2.) Wood Finish - See list below
- 3. Metal Leg Color - Arctic Silver (ASL), Bright White (BWH), Matte Black (MBK), Pewter (PEW), or Soft Nickel (SNK)
- 4. Optional Top Overlay
 - a.) White Back Painted Glass - add \$1,485 list for 18" dia., \$1,813 list for 24" dia., \$2,090 list for 36" dia.
 - b.) Solid Surface - add \$930 list for 18" dia., \$1,163 list for 24" dia., \$1,996 list for 36" dia.
 - 1.) Solid Surface Color - Armadillo (ARM), Black Pearl (BLP), Pebble Pearl (PEB) or Pure White (PUR)
- 5. Optional Power Center (leg models only) - Node (EC24) - Black (B) or White (W); order separately \$384 list each

Example:

PSV24-18RDC
(model #)

WA1
(veneer species)

MCH
(wood finish)

BWH
(metal frame)

PUR
(top overlay)

1. Model Number

2. Material Selection:

Laminate

Solid Laminates

ALB	Alabaster	DWH	Designer White
BLK	Black	SHD	Shadow
BBL	Bridal Blanco	SLG	Slate Grey

Veneer Grain Pattern Laminates

ALE	Ale Light	MIN	Mineral
BOL	Bourbon Light	OAT	Oatmeal Cookie
BZW	Brazilwood	PIN	Pinnacle Walnut
BGL	Brighton Light	STU	Studio Teak
BZW	Brazilwood	UMB	Umber
CLL	Collectors	VAL	Valley
FAW	Fawn	VIN	Vintage
FLO	Florence Walnut	WEA	Weathered Ash
GRH	Graphite		

Veneer

Flat Cut

Cherry (CH1)	Maple (MA1)	Walnut (WA1)
BBM Bourbon Medium	ALM Ale Medium	ESP Espresso
BRM Brighton Medium	BUT Butterscotch	MCH Mocha
CLA Classic	FLX Flax	SIE Sienna
CLL Collectors	VEN Venetian	TRF Truffle
HRV Harvest		UMB Umber
PRL Praline		

Double Cut (DC1)

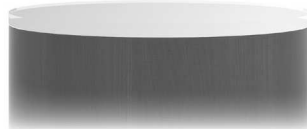
BAR Barrel - Oak Pattern	KHK Khaki
BUF Buff - Oak Pattern	MIN Mineral - Oak Pattern
CND Cinder - Oak Pattern	RYE Rye - Oak Pattern
COF Cofee	SAB Sable - Oak Pattern
EGR Egret - Oak Pattern	SAD Saddle - Oak Pattern
FAW Fawn	STU Studio Teak
GRH Graphite	VAL Valley

3. Metal Leg Color:

ABZ	Aged Bronze	GLD	Gold	SBZ	Soft Bronze
ASL	Arctic Silver	PEW	Pewter	SNK	Soft Nickel
BWH	Bright White	MBK	Matte Black		

4. Optional Top Overlay

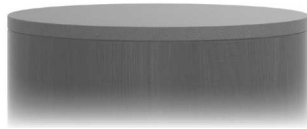
White Back Painted Glass - add \$1,485 list for 18" dia. tables, \$1,813 list for 24" dia. tables, \$2,090 list for 36" dia. tables



Solid Surface - add \$930 list for 18" dia. tables, \$1,163 list for 24" dia. tables, \$1,996 list for 36" dia. tables

Color Selection:

ARM	Armadillo	PEB	Pebble Pearl
BLP	Black Pearl	PUR	Pure White

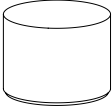
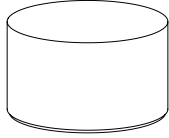


5. Optional Power Center (EC24) - order separately \$384 list
Specify color: Black (B) or White (W)



Note: Power only available on leg models. Cannot be used in conjunction with glass and solid surface tops. (Only with laminate and veneer tops.)

Description	D	W	H	CTN WT	CU FT	① Model	Laminate	Flat Cut Veneer	Double Cut Veneer
15" h Cylinder Column Table with ¾" Plinth	36	36	15	80	15	PST36-15RDA	\$1,804		
	36	36	15	80	15	PSV36-15RDA		\$2,070	\$2,607
	24	24	15	50	7	PST24-15RDA	\$1,333		
	24	24	15	50	7	PSV24-15RDA		\$1,483	\$1,791
	18	18	15	40	4	PST18-15RDA	\$1,163		
	18	18	15	40	4	PSV18-15RDA		\$1,261	\$1,496



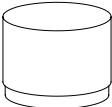
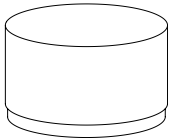
Features:

- ¾" black laminate plinth
- nylon tack glides

Options:

- white back painted glass top overlay available; add \$1,485 list for 18" dia. tables, \$1,813 list for 24" dia. tables, \$2,090 list for 36" dia. tables
- solid surface top overlay available; add \$930 list for 18" dia. tables, \$1,163 list for 24" dia. tables, \$1,996 list for 36" dia. tables

15" h Cylinder Column Table with 3" Plinth	36	36	15	80	15	PST36-15RDB	\$2,005		
	36	36	15	80	15	PSV36-15RDB		\$2,211	\$2,747
	24	24	15	50	7	PST24-15RDB	\$1,516		
	24	24	15	50	7	PSV24-15RDB		\$1,657	\$1,963
	18	18	15	40	4	PST18-15RDB	\$1,235		
	18	18	15	40	4	PSV18-15RDB		\$1,334	\$1,569



Features:

- 3" black laminate plinth
- nylon tack glides

Options:

- white back painted glass top overlay available; add \$1,485 list for 18" dia. tables, \$1,813 list for 24" dia. tables, \$2,090 list for 36" dia. tables
- solid surface top overlay available; add \$930 list for 18" dia. tables, \$1,163 list for 24" dia. tables, \$1,996 list for 36" dia. tables

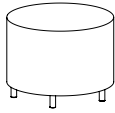
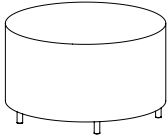
To Order, Specify:

- ① Model Number
- ② Material Selection:
 - a.) Laminate [See Laminate Top Options](#)
 - 1.) Laminate Color
 - b.) Veneer [See Veneer Top Options](#)
 - 1.) Wood Species - Cherry (CH1), Maple (MA1), Walnut (WA1), Black Oak (BO1) or Double Cut (DC1)
 - a.) Finish Color
- ③ Metal Leg Color [See Metal Frame Color Options](#)
- ④ Optional Top Overlay: see page PS2 for upcharge
 - a.) White Back Painted Glass
 - b.) Solid Surface [See Solid Surface Selection Options](#)
- ⑤ Optional Power Center (EC24) - add \$384 list
 - a.) Color: Black (B) or White (W)

Specifications

- Tops:**
- Optional glass or solid surface tops are ½" thick and sit on cylinder via attached non skid glides
 - Glass is back painted white and a tempered satin surface
- Plinths:**
- Plinth base models have tack in button glides.
 - Plinth is always black.
- Legs:**
- Leg models have non adjustable knock in glides.
 - Leg models come with 5 legs for all sizes.
- Power:**
- Power only available on leg models. Cannot be used in conjunction with glass and solid surface tops. (Only with laminate and veneer tops)

Description	D	W	H	CTN WT	CU FT	① Model	Laminate	Flat Cut Veneer	Double Cut Veneer
15" h Cylinder Column Table with Legs	36	36	15	80	15	PST36-15RDC	\$1,918		
	36	36	15	80	15	PSV36-15RDC		\$2,162	\$2,642
	24	24	15	50	7	PST24-15RDC	\$1,530		
	24	24	15	50	7	PSV24-15RDC		\$1,612	\$1,880
	18	18	15	40	4	PST18-15RDC	\$1,326		
	18	18	15	40	4	PSV18-15RDC		\$1,425	\$1,661



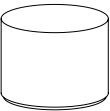
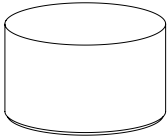
Features:

- 3" metal leg
- black nylon glides

Options:

- white back painted glass top overlay available; add \$1,485 list for 18" dia. tables, \$1,813 list for 24" dia. tables, \$2,090 list for 36" dia. tables
- solid surface top overlay available; add \$930 list for 18" dia. tables, \$1,163 list for 24" dia. tables, \$1,996 list for 36" dia. tables
- power center (EC24) - order as separate item, not available on glass or solid surface

18" h Cylinder Column Table with 3/4" Plinth	36	36	18	80	18	PST36-18RDA	\$2,019		
	36	36	18	80	18	PSV36-18RDA		\$2,500	\$2,864
	24	24	18	50	9	PST24-18RDA	\$1,414		
	24	24	18	50	9	PSV24-18RDA		\$1,561	\$1,907
	18	18	18	40	5	PST18-18RDA	\$1,198		
	18	18	18	40	5	PSV18-18RDA		\$1,371	\$1,602



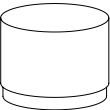
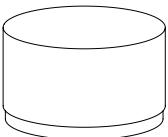
Features:

- 3/4" black laminate plinth
- nylon tack glides

Options:

- white back painted glass top overlay available; add \$1,485 list for 18" dia. tables, \$1,813 list for 24" dia. tables, \$2,090 list for 36" dia. tables
- solid surface top overlay available; add \$930 list for 18" dia. tables, \$1,163 list for 24" dia. tables, \$1,996 list for 36" dia. tables

18" h Cylinder Column Table with 3" Plinth	36	36	18	80	18	PST36-18RDB	\$2,125		
	36	36	18	80	18	PSV36-18RDB		\$2,407	\$2,999
	24	24	18	50	9	PST24-18RDB	\$1,599		
	24	24	18	50	9	PSV24-18RDB		\$1,693	\$2,079
	18	18	18	40	5	PST18-18RDB	\$1,270		
	18	18	18	40	5	PSV18-18RDB		\$1,439	\$1,674



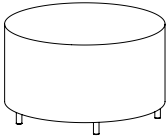
Features:

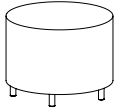
- 3" black laminate plinth
- nylon tack glides

Options:

- white back painted glass top overlay available; add \$1,485 list for 18" dia. tables, \$1,813 list for 24" dia. tables, \$2,090 list for 36" dia. tables
- solid surface top overlay available; add \$930 list for 18" dia. tables, \$1,163 list for 24" dia. tables, \$1,996 list for 36" dia. tables

PROST

Description	D	W	H	CTN WT	CU FT	① Model	Laminate	Flat Cut Veneer	Double Cut Veneer
18" h Cylinder Column Table with Legs 	36	36	18	80	18	PST36-18RDC	\$2,146		
	36	36	18	80	18	PSV36-18RDC		\$2,304	\$2,840
	24	24	18	50	9	PST24-18RDC	\$1,611		
	24	24	18	50	9	PSV24-18RDC		\$1,692	\$1,998
	18	18	18	40	5	PST18-18RDC	\$1,432		
	18	18	18	40	5	PSV18-18RDC		\$1,493	\$1,762

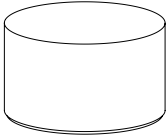


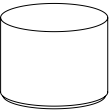
Features:

- 3" metal leg
- black nylon glides

Options:

- white back painted glass top overlay available; add \$1,485 list for 18" dia. tables, \$1,813 list for 24" dia. tables, \$2,090 list for 36" dia. tables
- solid surface top overlay available; add \$930 list for 18" dia. tables, \$1,163 list for 24" dia. tables, \$1,996 list for 36" dia. tables
- power center (EC24) - order as separate item. Not Available on Glass or Solid Surface

21" h Cylinder Column Table with 3/4" Plinth 	36	36	21	80	20	PST36-21RDA	\$2,131		
	36	36	21	80	20	PSV36-21RDA		\$2,377	\$3,026
	24	24	21	50	9	PST24-21RDA	\$1,488		
	24	24	21	50	9	PSV24-21RDA		\$1,662	\$2,047
	18	18	21	40	6	PST18-21RDA	\$1,235		
	18	18	21	40	6	PSV18-21RDA		\$1,449	\$1,749



Features:

- 3/4" black laminate plinth
- nylon tack glides

Options:

- white back painted glass top overlay available; add \$1,485 list for 18" dia. tables, \$1,813 list for 24" dia. tables, \$2,090 list for 36" dia. tables
- solid surface top overlay available; add \$930 list for 18" dia. tables, \$1,163 list for 24" dia. tables, \$1,996 list for 36" dia. tables

To Order, Specify:

- ① Model Number
- ② Material Selection:
 - a.) Laminate [See Laminate Top Options](#)
 - 1.) Laminate Color
 - b.) Veneer [See Veneer Top Options](#)
 - 1.) Wood Species - Cherry (CH1), Maple (MA1), Walnut (WA1), Black Oak (BO1) or Double Cut (DC1)
 - a.) Finish Color
- ③ Metal Leg Color [See Metal Frame Color Options](#)
- ④ Optional Top Overlay: see page [PS2](#) for upcharge
 - a.) White Back Painted Glass
 - b.) Solid Surface [See Solid Surface Selection Options](#)
- ⑤ Optional Power Center (EC24) - add \$384 list
 - a.) Color: Black (B) or White (W)

Specifications

Tops:

- Optional glass or solid surface tops are 1/2" thick and sit on cylinder via attached non skid glides
- Glass is back painted white and a tempered satin surface

Plinths:

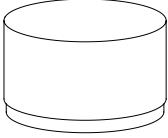
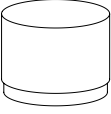
- Plinth base models have tack in button glides.
- Plinth is always black.

Legs:

- Leg models have non adjustable knock in glides.
- Leg models come with 5 legs for all sizes.

Power:

- Power only available on leg models. Cannot be used in conjunction with glass and solid surface tops. (Only with laminate and veneer tops)

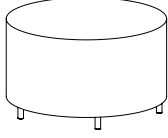
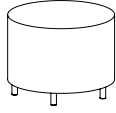
Description	D	W	H	CTN WT	CU FT	① Model	Laminate	Flat Cut Veneer	Double Cut Veneer
21" h Cylinder Column Table with 3" Plinth	36	36	21	80	20	PST36-21RDB	\$2,333		
	36	36	21	80	20	PSV36-21RDB		\$2,483	\$3,182
	24	24	21	50	9	PST24-21RDB	\$1,670		
	24	24	21	50	9	PSV24-21RDB		\$1,862	\$2,247
	18	18	21	40	6	PST18-21RDB	\$1,305		
	18	18	21	40	6	PSV18-21RDB		\$1,761	\$2,063

Features:

- 3" black laminate plinth
- nylon tack glides

Options:

- white back painted glass top overlay available; add \$1,485 list for 18" dia. tables, \$1,813 list for 24" dia. tables, \$2,090 list for 36" dia. tables
- solid surface top overlay available; add \$930 list for 18" dia. tables, \$1,163 list for 24" dia. tables, \$1,996 list for 36" dia. tables

21" h Cylinder Column Table with Legs	36	36	21	80	20	PST36-21RDC	\$2,258		
	36	36	21	80	20	PSV36-21RDC		\$2,374	\$2,965
	24	24	21	50	9	PST24-21RDC	\$1,688		
	24	24	21	50	9	PSV24-21RDC		\$1,766	\$2,110
	18	18	21	40	6	PST18-21RDC	\$1,482		
	18	18	21	40	6	PSV18-21RDC		\$1,800	\$2,069

Features:

- 3" metal leg
- black nylon glides

Options:

- white back painted glass top overlay available; add \$1,485 list for 18" dia. tables, \$1,813 list for 24" dia. tables, \$2,090 list for 36" dia. tables
- solid surface top overlay available; add \$930 list for 18" dia. tables, \$1,163 list for 24" dia. tables, \$1,996 list for 36" dia. tables
- power center (EC24) - order as separate item. Not Available on Glass or Solid Surface

Node Power Unit	3 3/8	3 3/8	3/8	5	1	EC24	\$384		
-----------------	-------	-------	-----	---	---	------	-------	--	--



- black or white
- one power and one dual USB, 72" cord

To Order, Specify:

- ① Model Number
- ② Material Selection:
 - a.) Laminate See [Laminate Top Options](#)
 - 1.) Laminate Color
 - b.) Veneer See [Veneer Top Options](#)
 - 1.) Wood Species - Cherry (CH1), Maple (MA1), Walnut (WA1), Black Oak (BO1) or Double Cut (DC1)
 - a.) Finish Color
- ③ Metal Leg Color See [Metal Frame Color Options](#)
- ④ Optional Top Overlay: see page [PS2](#) for upcharge
 - a.) White Back Painted Glass
 - b.) Solid Surface See [Solid Surface Selection Options](#)
- ⑤ Optional Power Center (EC24) - add \$384 list
 - a.) Color: Black (B) or White (W)

Specifications

Tops:

- Optional glass or solid surface tops are 1/2" thick and sit on cylinder via attached non skid glides
- Glass is back painted white and a tempered satin surface

Plinths:

- Plinth base models have tack in button glides.
- Plinth is always black.

Legs:

- Leg models have non adjustable knock in glides.
- Leg models come with 5 legs for all sizes.

Power:

- Power only available on leg models. Cannot be used in conjunction with glass and solid surface tops. (Only with laminate and veneer tops)

Reef Product Information



REEF

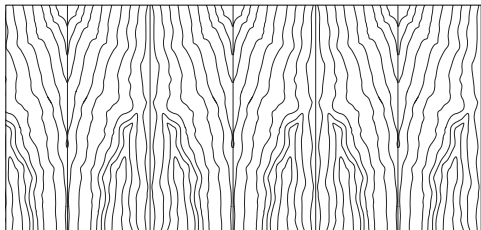
Material Offering	RE2	Panel Tables	RE10
Overview	RE4	Wall Dependant Panel Tables.	RE13
General Options	RE5	Layered Tables	RE14
Vertical Wire Manager Chart	RE6	Wall Dependant Layered Tables.	RE17
Worksurface Power.	RE8	Layered Tables w/Bookshelf	RE18
Applied Materials	RE9	Wall Dependant Layered Tables w/B'shelf.	RE21
		Layered Tables w/ Full Bookshelf	RE24
		Vertical Wire Manager	RE25
		Worksurface Power.	RE26

Reef Product Information

Reef Veneer

Exterior Wood Materials

Exterior surfaces are made from the finest selected veneers to achieve clarity and consistency in the Reef Veneer product line. To attain a pleasing, symmetrical pattern, all cherry, maple, walnut, & black oak veneers are book-matched.



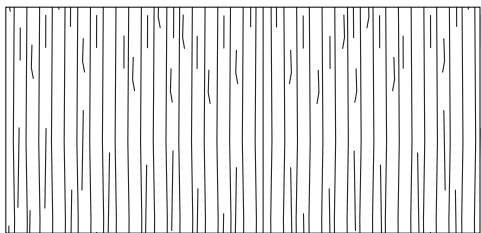
Book-Matched Example

Alternating pieces of veneer are flipped over so they face each other like the pages within a book.

Reef Veneer is available in flat cut cherry, maple and walnut. A wide range of wood stains have been formulated to enhance the beauty of the veneer.

Double Cut veneer is another choice on Veneer product. This veneer is a processed product that has at least two cuttings to create the final veneers. These cuts of veneer strands are dyed and layered into a block to create variation of patterns from a very tight grain pattern to an exotic figure grain pattern.

The diagram below shows the tight pattern used on Double Cut Veneer.



Worksurface Construction

Worksurfaces are 1 3/16" thick and are manufactured with 3-ply balanced construction. Surfaces are available in wood veneer or high pressure laminate. No additional charge for HPL worksurface when using the standard coordinating HPL match to a standard wood finish. Veneer tops feature 3mm thick matching veneer edgebands. HPL tops are constructed with internal solid hardwood lumber edgebands.

Case Construction

Veneer end panels are produced using a 1 3/16" thick substrate with veneer surfaces and matching veneer bands on exposed edges. Stretcher panels are 1 3/16" thick for layered tables and 3/4" thick on panel tables. Stretcher panels feature heavy duty metal brackets that bolt to metal insert nuts in end panels. 36", 42" and 48" deep tables feature dual stretcher panels that are sized to provide proper support for worksurfaces. 20" deep wall dependent tables incorporate rear stretcher and metal support rails for worksurface support. Worksurfaces are joined to end assemblies and stretcher panels by metal brackets and wood screws. Upper shelves on layered tables are 1 3/16" thick and attach with Modeez connectors and metal brackets with wood screws. Bookcase sections are constructed from 3/4" thick veneer panels with matching veneer edgebanding. Narrow bookcase and full bookcase joinery includes wood cleats, wood screws and metal fasteners. All tables have adjustable leveling glides. Tables require field assembly.

RE2 Reef

Foot Rails

Optional metal foot rails are constructed with 14-gauge 1 3/4" square tubing with powder coated finish. Rails attach to end panels using 1/4"-20 machine screws into metal inserts in end panels. Foot rails not available on quickship.

Finish - Stain/Colors

We offer a variety of wood stains and paint colors on Reef. Please see the chart below. Samples are available upon request.

CH1 Cherry *Flat Cut Veneer*

BBM Bourbon Medium	CLL Collectors
BRM Brighton Medium	HRV Harvest
CLA Classic	PRL Praline

MA1 Maple *Flat Cut Veneer*

ALM Ale Medium	FLX Flax
BUT Butterscotch	VEN Venetian

WA1 Walnut *Flat Cut Veneer*

ESP Espresso	TRF Truffle
MCH Mocha	UMB Umber
SIE Sienna	

B01 Black Oak *Flat Cut Veneer*

RAV Raven	
-----------	--

DC1 Double Cut Veneer *Eased Edge Only*

BAR Barrel - Oak Pattern	KHK Khaki
BUF Buff - Oak Pattern	MIN Mineral - Oak Pattern
CND Cinder - Oak Pattern	RYE Rye - Oak Pattern
COF Coffee	SAB Sable - Oak Pattern
EGR Egret - Oak Pattern	SAD Saddle - Oak Pattern
FAW Fawn	STU Studio Teak
GRH Graphite	VAL Valley

PNT Paint *Maple Flat Cut Veneer*

BKD Backdrop	GRV Greek Villa
BFX Black Fox	NET Network Gray
BWH Bright White	NWH Nonchalant White
CGP Cargo Pants	STM Storm
CHT Chatroom	TRC Tricorn Black
FRR French Roast	

Protective Top Coat

DuraTex™ offers exceptional hardness along with abrasion and impact resistance, it has been formulated to eliminate hazardous and harmful gases that are normally associated with wood finish.

DuraTex™ Features

Safety - Significantly reduces hazardous formaldehyde emissions which help improve the quality of the indoor air we breathe. Quality - Developed to be tough and durable with special attention to appearance. The DuraTex™ finish preserves the natural beauty of wood. Durability - Designed to meet a wide range of demanding performance and environmental standards to withstand even the highest wear and tear.

Custom/Special Finishes

JSI, upon request, will accommodate special finishes. A written request is required to proceed with custom finish orders. A sample reference is required for first time matches and must be included with the written request.

There is a one time charge of \$372 list per order for any non-standard wood finish.

Reef Product Information

Orders will be entered noting the special finish. A sample match will be provided to the customer. Written approval is needed before the finish process can be started. Delays in approval may have an impact on lead times.

Every effort will be made to create the requested match; however, an acceptable match may not be possible because of natural variations of wood. These natural variations can also cause minor differences in the final finish product.

Finish Sheen

All veneer finishes are standard in 35-sheen, with the exception of Raven. Raven is only offered in 15 sheen. All other finishes can have their sheen modified with a 15% upcharge added to the list price of each item.

Species Change

For species changes contact customer service for a quote.

Laminate Tops

Work surface only, no additional upcharge if Reef's coordinating wood grain laminate is specified. Contact Customer Service for any other laminate request. Listed below are finishes that have coordinating wood grain HPL laminates.

CH1 Cherry *Flat Cut Veneer*

CLL Collectors
HRV Harvest
PRL Praline

WA1 Walnut *Flat Cut Veneer*

MCH Mocha TRF Truffle
SIE Sienna UMB Umber

DC1 Double Cut Veneer

FAW Fawn VAL Valley
MIN Mineral - Oak Pattern

Reef Laminate

Reef Laminate features TFL (thermally fused laminate) chassis components. Worksurfaces are available in HPL (high pressure laminate).

Edges of the worksurface are banded with impact resistant (PVC) on HPL tops. The laminate is offered in 16 wood grain patterns and 6 solid colors. Wood grain laminates feature an embossed grain that adds texture and helps to hide finger prints and light scratches. The solid color laminates are smooth to the touch with a semi-matte finish. All Reef Laminate products are indoor-air certified by GreenGuard.

The chart below lists the laminates available on the Reef product.

TFL / HPL Wood Grain Pattern Laminates

ALL Ale Light	MIN Mineral
BOL Bourbon Light	OAT Oatmeal Cookie
BZW Brazilwood	PIN Pinnacle Walnut
BGL Brighton Light	STU Studio Teak
CLL Collectors	UMB Umber
FAW Fawn	VAL Valley
FLO Florence Walnut	VIN Vintage
GRH Graphite	WEA Weathered Ash

TFL /HPL Solid Laminates

ALB Alabaster	DWH Designer White
BLK Black	SHD Shadow
BBL Bridal Blanco	SLG Slate Grey

Worksurfaces

Worksurfaces are manufactured with 3-ply balanced construction. Tops are 1 3/16" thick with coordinating PVC edges. Worksurfaces feature 3mm PVC edges on user sides. Edge detail is flat with eased edge on top and bottom. Worksurface ends are banded with 1mm PVC.

Case Construction

Reef Laminate end panels are produced using 1 3/16" thick substrate with TFL surfaces and matching PVC bands on exposed edges. Stretcher panels are 1 3/16" thick for layered tables and 3/4" thick on panel tables. Stretcher Panels feature heavy duty metal brackets that bolt to metal insert nuts in end panels. Reef 36", 42" and 48" deep tables feature dual stretcher panels that are sized to provide proper support for worksurfaces. Reef 20" deep wall dependent tables incorporate rear stretcher and metal support rails for work surface support. Worksurfaces are joined to end assemblies and stretcher panels by metal brackets and wood screws. Upper shelves on layered tables are 1 1/8" thick and attach with Modeez connectors and metal brackets. Bookcase sections are constructed from 3/4" thick TFL panels with 1mm edgebanding. Narrow bookcase and full bookcase assembly joinery include wood cleats, wood screws and metal fasteners. All tables have adjustable leveling glides. Reef tables require field assembly.

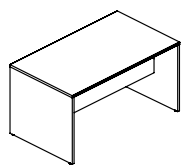
Foot Rails

Optional metal foot rails are constructed with 14-gauge 1 3/4" square tubing with powder coated finish. Rails attach to end panels using 1/4-20 machine screws into metal inserts in end panels.

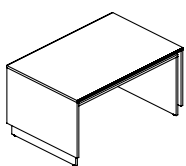
Metal Finishes for Foot Rails

Aged Bronze (ABZ)
Arctic Silver (ASL)
Black Sandtex (BSX)
Gold (GLD)
Pewter (PEW)
Soft Nickel (SNK)
Soft Bronze (SBZ)

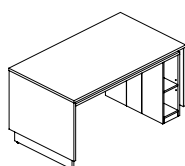
Reef - Overview



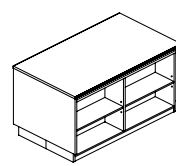
Panel Table



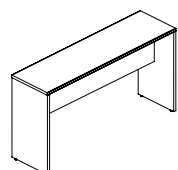
Layered Table



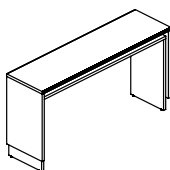
Layered Table with Asymmetric Bookshelf



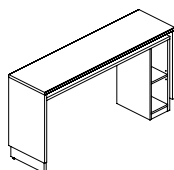
Layered Table with Full Width Bookcases



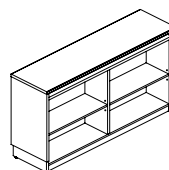
Wall Dependent Panel Table



Wall Dependent Layered Table



Wall Dependent Layered Table with Asymmetric Bookshelf



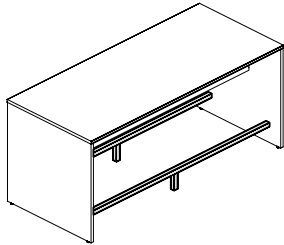
Wall Dependent Layered Table with Full Width Bookcases

REEF

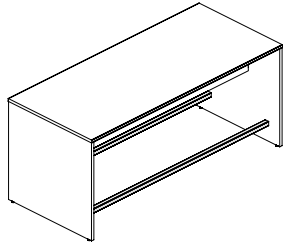
Reef Product Information

Optional Foot Rail

Optional foot rail in the Arctic Silver, Black Sandtex Pewter, or Soft Nickel powder coat finish is available on the 42" h tables.



96" wide



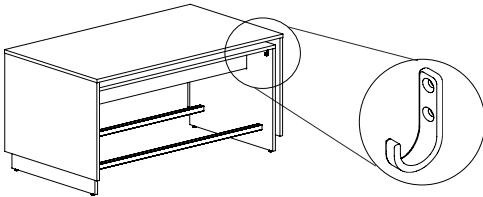
54", 60", 72", & 84" wide

Double Sided Table - Two Rails - add \$1,065 list

Single Sided Table - One Rail - add \$596 list

Optional Coat Hook

Optional satin stainless steel coat hook is available on the 42" h and 37" h tables.



Double Sided Table - Four Hooks - add \$203 list

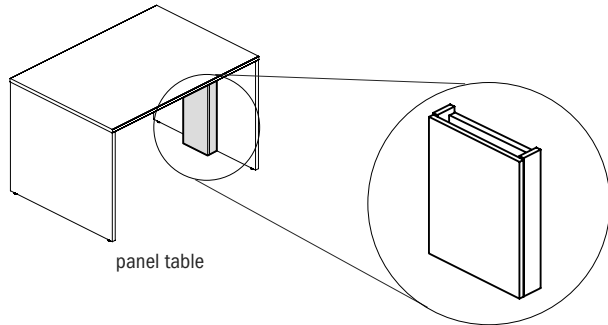
Single Sided Table - Two Hooks - add \$125 list

Vertical Wire Manager

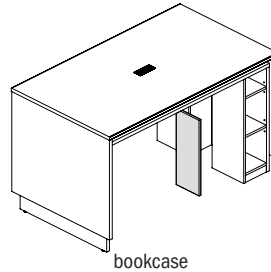
Vertical Wire Manager is optional on the 48", 42" and 36" d units, select veneer or laminate.

Bookcases feature integrated vertical wire management with a removable access panel. Vertical wire managers are not available on bookcase sides.

Note: Not available on 20" d units.



panel table



bookcase

Reef Product Information

Chart below should be used when determining appropriate Vertical Wire Manager for Panel Tables.

REEF

Depth	Table		Vertical Wire Manager	
	Width	Height	Veneer	Laminate
48	96	42	REV1617WMA	RET1617WMA
48	84	42	REV1617WMA	RET1617WMA
48	72	42	REV1617WMA	RET1617WMA
48	60	42	REV1617WMA	RET1617WMA
48	54	42	REV1617WMA	RET1617WMA
42	96	42	REV1017WMA	RET1017WMA
42	84	42	REV1017WMA	RET1017WMA
42	72	42	REV1017WMA	RET1017WMA
42	60	42	REV1017WMA	RET1017WMA
42	54	42	REV1017WMA	RET1017WMA
36	96	42	REV1017WMA	RET1017WMA
36	84	42	REV1017WMA	RET1017WMA
36	72	42	REV1017WMA	RET1017WMA
36	60	42	REV1017WMA	RET1017WMA
36	54	42	REV1017WMA	RET1017WMA
48	96	37	REV1617WMA	RET1617WMA
48	84	37	REV1617WMA	RET1617WMA
48	72	37	REV1617WMA	RET1617WMA
48	60	37	REV1617WMA	RET1617WMA
48	54	37	REV1617WMA	RET1617WMA
42	96	37	REV1017WMA	RET1017WMA
42	84	37	REV1017WMA	RET1017WMA
42	72	37	REV1017WMA	RET1017WMA
42	60	37	REV1017WMA	RET1017WMA
42	54	37	REV1017WMA	RET1017WMA
36	96	37	REV1017WMA	RET1017WMA
36	84	37	REV1017WMA	RET1017WMA
36	72	37	REV1017WMA	RET1017WMA
36	60	37	REV1017WMA	RET1017WMA
36	54	37	REV1017WMA	RET1017WMA

Depth	Table		Vertical Wire Manager	
	Width	Height	Veneer	Laminate
48	96	30	REV1617WMA	RET1617WMA
48	84	30	REV1617WMA	RET1617WMA
48	72	30	REV1617WMA	RET1617WMA
48	60	30	REV1617WMA	RET1617WMA
48	54	30	REV1617WMA	RET1617WMA
42	96	30	REV1017WMA	RET1017WMA
42	84	30	REV1017WMA	RET1017WMA
42	72	30	REV1017WMA	RET1017WMA
42	60	30	REV1017WMA	RET1017WMA
42	54	30	REV1017WMA	RET1017WMA
36	96	30	REV1017WMA	RET1017WMA
36	84	30	REV1017WMA	RET1017WMA
36	72	30	REV1017WMA	RET1017WMA
36	60	30	REV1017WMA	RET1017WMA
36	54	30	REV1017WMA	RET1017WMA

Reef Product Information

Chart below should be used when determining appropriate Vertical Wire Manager for Layered Tables and Layered Tables with Asymmetric Bookshelf.

Depth	Table		Vertical Wire Manager	
	Width	Height	Veneer	Laminate
48	96	42	REV1626WMA	RET1626WMA
48	84	42	REV1626WMA	RET1626WMA
48	72	42	REV1626WMA	RET1626WMA
48	60	42	REV1626WMA	RET1626WMA
48	54	42	REV1626WMA	RET1626WMA
42	96	42	REV1026WMA	RET1026WMA
42	84	42	REV1026WMA	RET1026WMA
42	72	42	REV1026WMA	RET1026WMA
42	60	42	REV1026WMA	RET1026WMA
42	54	42	REV1026WMA	RET1026WMA
36	96	42	REV1026WMA	RET1026WMA
36	84	42	REV1026WMA	RET1026WMA
36	72	42	REV1026WMA	RET1026WMA
36	60	42	REV1026WMA	RET1026WMA
36	54	42	REV1026WMA	RET1026WMA
48	96	37	REV1626WMA	RET1626WMA
48	84	37	REV1626WMA	RET1626WMA
48	72	37	REV1626WMA	RET1626WMA
48	60	37	REV1626WMA	RET1626WMA
48	54	37	REV1626WMA	RET1626WMA
42	96	37	REV1026WMA	RET1026WMA
42	84	37	REV1026WMA	RET1026WMA
42	72	37	REV1026WMA	RET1026WMA
42	60	37	REV1026WMA	RET1026WMA
42	54	37	REV1026WMA	RET1026WMA
36	96	37	REV1026WMA	RET1026WMA
36	84	37	REV1026WMA	RET1026WMA
36	72	37	REV1026WMA	RET1026WMA
36	60	37	REV1026WMA	RET1026WMA
36	54	37	REV1026WMA	RET1026WMA

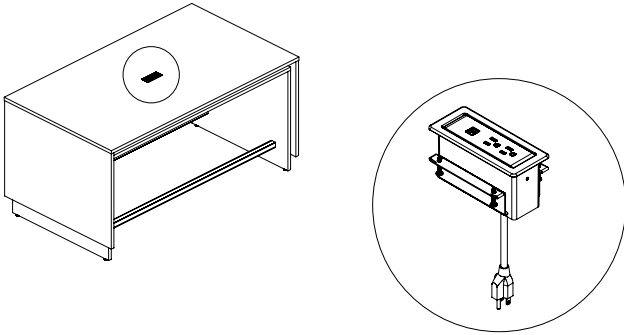
Depth	Table		Vertical Wire Manager	
	Width	Height	Veneer	Laminate
48	96	30	REV1620WMA	RET1620WMA
48	84	30	REV1620WMA	RET1620WMA
48	72	30	REV1620WMA	RET1620WMA
48	60	30	REV1620WMA	RET1620WMA
48	54	30	REV1620WMA	RET1620WMA
42	96	30	REV1020WMA	RET1020WMA
42	84	30	REV1020WMA	RET1020WMA
42	72	30	REV1020WMA	RET1020WMA
42	60	30	REV1020WMA	RET1020WMA
42	54	30	REV1020WMA	RET1020WMA
36	96	30	REV1020WMA	RET1020WMA
36	84	30	REV1020WMA	RET1020WMA
36	72	30	REV1020WMA	RET1020WMA
36	60	30	REV1020WMA	RET1020WMA
36	54	30	REV1020WMA	RET1020WMA

Reef Product Information

Optional Worksurface Power

Optional Worksurface Power (EC26) is available on 48", 42" and 36" deep units. Indicate "to accommodate Worksurface Power" on your purchase order. When this option is specified the worksurface will have one cut out in the center. One EC26 Worksurface Power unit must be ordered separately, see page RE26. Length of cord is 10 feet.

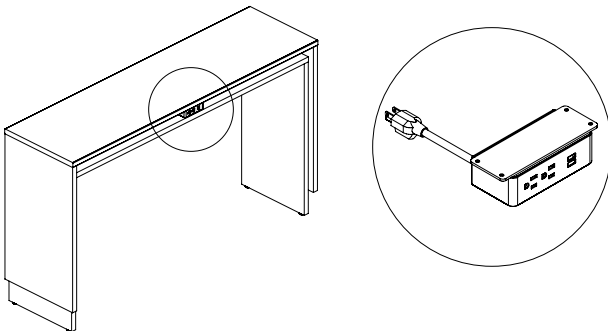
Note: Not available on wall dependent tables or tables with full width bookcases.



Under Surface Power

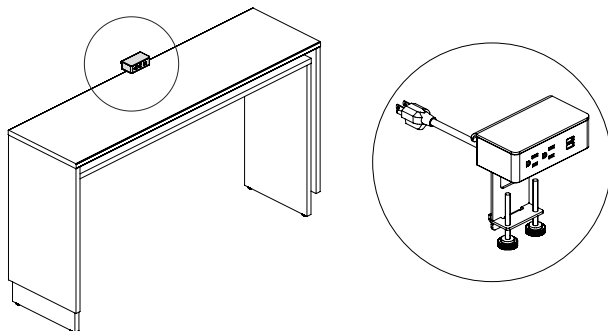
Under Surface Power (EC27) may be ordered for 48", 42", 36" and 20" deep units. The 48", 42" and 36" deep units can accommodate power unit on each side of the table. The 20" deep units can accommodate power units on the non-wall side. The EC27 Under Surface Power Unit(s) must be ordered separately, see page RE26. This unit is field installed. Length of cord is 10 feet.

Note: Not available on tables with full width bookcases.



Edge Mount Power

Edge Mount Power (EC28) may be ordered for 20" deep units. This unit is field installed. Ordering information can be found on page RE26. Length of power cord is 10 feet.

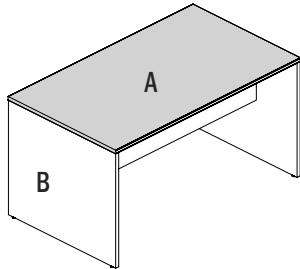


Reef Product Information

Material Options

Note: Only one veneer can be specified.

Panel Table



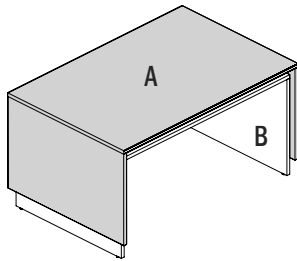
- REV - Veneer**
A Worksurface
 Veneer
B Panels
 Veneer
 Paint

Note: Stretcher matches "B"

- RET - Laminate**
A Worksurface
 Laminate
B Panels
 Laminate

Note: Stretcher matches "B"

Layered Table



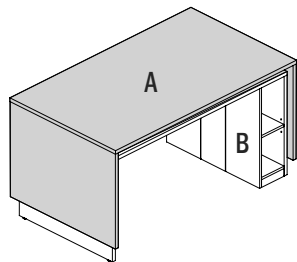
- REV - Veneer**
A Worksurface/Outer Panels
 Veneer
B Inner Panels
 Veneer
 Paint

Note: Stretcher matches "B"

- RET - Laminate**
A Worksurface/Outer Panels
 Laminate
B Inner Panels
 Laminate

Note: Stretcher matches "B"

Layered Table with Asymmetric Bookshelf



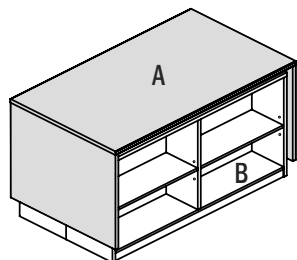
- REV - Veneer**
A Worksurface/Outer Panels
 Veneer
B Bookcase/Inner Panels
 Veneer
 Paint

Note: Stretcher matches "B"

- RET - Laminate**
A Worksurface/Outer Panels
 Laminate
B Bookcase/Inner Panels
 Laminate

Note: Stretcher matches "B"

Layered Table with Full Width Bookcase



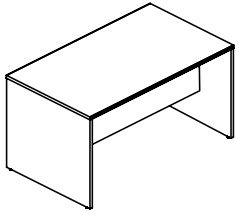
- REV - Veneer**
A Worksurface/Outer Panels
 Veneer
B Bookcase/Inner Panels
 Veneer
 Paint

Note: Stretcher matches "B"

- RET - Laminate**
A Worksurface/Outer Panels
 Laminate
B Bookcase/Inner Panels
 Laminate

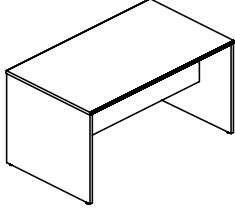
Note: Stretcher matches "B"

Description	D	W	H	CTN WT	CU FT	① Model	TFL Laminate List Price	HPL Laminate List Price	Veneer Flat Cut and Double Cut List Price
42" h Panel Table	48	96	42	317	34	RET4896-42PT	\$2,113	\$2,872	
	48	96	42	317	34	REV4896-42PT			\$4,853
	48	84	42	292	31	RET4884-42PT	\$1,993	\$2,710	
	48	84	42	292	31	REV4884-42PT			\$4,577
	48	72	42	267	28	RET4872-42PT	\$1,873	\$2,522	
	48	72	42	267	28	REV4872-42PT			\$4,312
	48	60	42	241	25	RET4860-42PT	\$1,765	\$2,357	
	48	60	42	241	25	REV4860-42PT			\$4,074
	48	54	42	229	24	RET4854-42PT	\$1,718	\$2,282	
	48	54	42	229	24	REV4854-42PT			\$3,966
	42	96	42	288	31	RET4296-42PT	\$1,991	\$2,686	
	42	96	42	288	31	REV4296-42PT			\$4,574
	42	84	42	264	28	RET4284-42PT	\$1,877	\$2,535	
	42	84	42	264	28	REV4284-42PT			\$4,317
	42	72	42	241	26	RET4272-42PT	\$1,765	\$2,361	
	42	72	42	241	26	REV4272-42PT			\$4,066
	42	60	42	218	23	RET4260-42PT	\$1,664	\$2,204	
	42	60	42	218	23	REV4260-42PT			\$3,841
	42	54	42	206	22	RET4254-42PT	\$1,622	\$2,136	
	42	54	42	206	22	REV4254-42PT			\$3,741
	36	96	42	258	28	RET3696-42PT	\$1,834	\$2,474	
	36	96	42	258	28	REV3696-42PT			\$4,211
	36	84	42	237	25	RET3684-42PT	\$1,729	\$2,333	
	36	84	42	237	25	REV3684-42PT			\$3,971
	36	72	42	216	23	RET3672-42PT	\$1,625	\$2,171	
	36	72	42	216	23	REV3672-42PT			\$3,741
	36	60	42	194	20	RET3660-42PT	\$1,533	\$2,028	
	36	60	42	194	20	REV3660-42PT			\$3,537
	36	54	42	184	19	RET3654-42PT	\$1,491	\$1,964	
	36	54	42	184	19	REV3654-42PT			\$3,442



REEF

- ships KD
- vertical kneespace clearance 40 3/4"
- EC26 worksurface power available, specify "to accommodate worksurface power" on your purchase order; one EC26 unit must be ordered separately, see page [RE26](#)
- EC27 undersurface power available, see page [RE26](#)
- wire manager available, see page [RE25](#)
- optional foot rail (two rails), specify and add \$1,065 list
- optional coat hooks (four hooks), specify and add \$203 list

Description	D	W	H	CTN WT	CU FT	① Model	TFL Laminate List Price	HPL Laminate List Price	Veneer Flat Cut and Double Cut List Price
37" h Panel Table 	48	96	37	286	32	RET4896-37PT	\$1,967	\$2,698	
	48	96	37	286	32	REV4896-37PT			\$4,568
	48	84	37	263	29	RET4884-37PT	\$1,858	\$2,545	
	48	84	37	263	29	REV4884-37PT			\$4,310
	48	72	37	240	26	RET4872-37PT	\$1,735	\$2,360	
	48	72	37	240	26	REV4872-37PT			\$4,062
	48	60	37	218	23	RET4860-37PT	\$1,629	\$2,192	
	48	60	37	218	23	REV4860-37PT			\$3,839
	48	54	37	206	22	RET4854-37PT	\$1,579	\$2,119	
	48	54	37	206	22	REV4854-37PT			\$3,741
	42	96	37	258	29	RET4296-37PT	\$1,841	\$2,507	
	42	96	37	258	29	REV4296-37PT			\$4,300
	42	84	37	237	26	RET4284-37PT	\$1,735	\$2,364	
	42	84	37	237	26	REV4284-37PT			\$4,057
	42	72	37	216	24	RET4272-37PT	\$1,624	\$2,193	
	42	72	37	216	24	REV4272-37PT			\$3,826
	42	60	37	196	21	RET4260-37PT	\$1,525	\$2,041	
	42	60	37	196	21	REV4260-37PT			\$3,618
	42	54	37	185	20	RET4254-37PT	\$1,482	\$1,976	
	42	54	37	185	20	REV4254-37PT			\$3,528
	36	96	37	229	25	RET3696-37PT	\$1,694	\$2,307	
	36	96	37	229	25	REV3696-37PT			\$3,959
	36	84	37	211	23	RET3684-37PT	\$1,598	\$2,179	
	36	84	37	211	23	REV3684-37PT			\$3,731
	36	72	37	192	21	RET3672-37PT	\$1,496	\$2,020	
	36	72	37	192	21	REV3672-37PT			\$3,520
	36	60	37	173	19	RET3660-37PT	\$1,405	\$1,880	
	36	60	37	173	19	REV3660-37PT			\$3,332
	36	54	37	164	18	RET3654-37PT	\$1,365	\$1,821	
	36	54	37	164	18	REV3654-37PT			\$3,246

- ships KD
- vertical kneespace clearance 35 3/4"
- EC26 worksurface power available, specify "to accommodate worksurface power" on your purchase order; one EC26 unit must be ordered separately, see page [RE26](#)
- EC27 undersurface power available, see page [RE26](#)
- wire manager available, see page [RE25](#)
- optional coat hooks (four hooks), specify and add \$203 list

To Order, Specify:

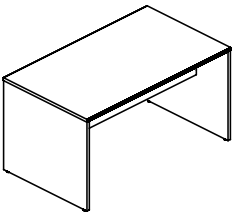
Veneer

- ① Model Number
- ② Worksurface Wood Species - Cherry (CH1), Maple (MA1), Walnut (WA1), Black Oak (BO1) or Double Cut (DC1) (see page [RE2](#))
- ③ Finish Color (see page [RE2](#))

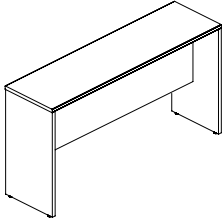
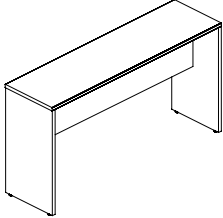
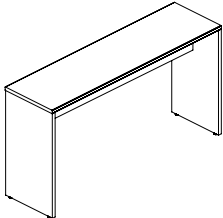
- ④ Panels Species & Finish
 - a.) Same as Worksurface
 - b.) Paint (see page [RE2](#))
- ⑤ Other Product Options

Laminate

- ① Model Number
- ② Worksurface Material (see page [RE3](#))
 - a.) TFL
 - b.) HPL
- ③ Worksurface Laminate Color (see page [RE3](#))
- ④ Panels Laminate Color
 - a.) Same as Worksurface
 - b.) Other Laminate (see page [RE3](#))
- ⑤ Other Product Options

Description	D	W	H	CTN WT	CU FT	① Model	TFL Laminate List Price	HPL Laminate List Price	Veneer Flat Cut and Double Cut List Price
30" h Panel Table	48	96	30	254	29	RET4896-30PT	\$1,835	\$2,541	
	48	96	30	254	29	REV4896-30PT			\$4,288
	48	84	30	233	26	RET4884-30PT	\$1,731	\$2,396	
	48	84	30	233	26	REV4884-30PT			\$4,044
	48	72	30	211	24	RET4872-30PT	\$1,609	\$2,205	
	48	72	30	211	24	REV4872-30PT			\$3,808
	48	60	30	190	21	RET4860-30PT	\$1,499	\$2,034	
	48	60	30	190	21	REV4860-30PT			\$3,598
	48	54	30	179	20	RET4854-30PT	\$1,452	\$1,960	
	48	54	30	179	20	REV4854-30PT			\$3,502
	42	96	30	229	26	RET4296-30PT	\$1,736	\$2,382	
	42	96	30	229	26	REV4296-30PT			\$4,042
	42	84	30	209	24	RET4284-30PT	\$1,640	\$2,247	
	42	84	30	209	24	REV4284-30PT			\$3,813
	42	72	30	190	21	RET4272-30PT	\$1,524	\$2,071	
	42	72	30	190	21	REV4272-30PT			\$3,589
	42	60	30	171	19	RET4260-30PT	\$1,419	\$1,912	
	42	60	30	171	19	REV4260-30PT			\$3,391
	42	54	30	161	18	RET4254-30PT	\$1,374	\$1,839	
	42	54	30	161	18	REV4254-30PT			\$3,305
	36	96	30	203	23	RET3696-30PT	\$1,599	\$2,193	
	36	96	30	203	23	REV3696-30PT			\$3,721
	36	84	30	186	21	RET3684-30PT	\$1,508	\$2,070	
	36	84	30	186	21	REV3684-30PT			\$3,509
	36	72	30	168	19	RET3672-30PT	\$1,403	\$1,908	
	36	72	30	168	19	REV3672-30PT			\$3,305
	36	60	30	151	17	RET3660-30PT	\$1,308	\$1,760	
	36	60	30	151	17	REV3660-30PT			\$3,122
	36	54	30	142	16	RET3654-30PT	\$1,267	\$1,693	
	36	54	30	142	16	REV3654-30PT			\$3,044

- ships KD
- vertical kneespace clearance 28 3/4"
- EC26 worksurface power available, specify "to accommodate worksurface power" on your purchase order; one EC26 unit must be ordered separately, see page [RE26](#)
- EC27 undersurface power available, see page [RE26](#)
- wire manager available, see page [RE25](#)

Description	D	W	H	CTN WT	CU FT	① Model	TFL Laminate List Price	HPL Laminate List Price	Veneer Flat Cut and Double Cut List Price
	20	84	42	105	14	RET2084-42PT	\$1,144	\$1,513	
	20	84	42	105	14	REV2084-42PT			\$2,724
	20	72	42	94	13	RET2072-42PT	\$1,083	\$1,420	
	20	72	42	94	13	REV2072-42PT			\$2,585
	20	60	42	83	12	RET2060-42PT	\$1,030	\$1,340	
	20	60	42	83	12	REV2060-42PT			\$2,442
	20	54	42	77	11	RET2054-42PT	\$1,008	\$1,302	
20	54	42	77	11	REV2054-42PT			\$2,380	
	20	84	37	94	13	RET2084-37PT	\$1,056	\$1,417	
	20	84	37	94	13	REV2084-37PT			\$2,581
	20	72	37	84	12	RET2072-37PT	\$988	\$1,316	
	20	72	37	84	12	REV2072-37PT			\$2,433
	20	60	37	74	11	RET2060-37PT	\$930	\$1,224	
	20	60	37	74	11	REV2060-37PT			\$2,300
	20	54	37	69	10	RET2054-37PT	\$901	\$1,184	
20	54	37	69	10	REV2054-37PT			\$2,243	
	20	84	30	85	12	RET2084-30PT	\$998	\$1,348	
	20	84	30	85	12	REV2084-30PT			\$2,426
	20	72	30	76	11	RET2072-30PT	\$926	\$1,242	
	20	72	30	76	11	REV2072-30PT			\$2,283
	20	60	30	66	10	RET2060-30PT	\$865	\$1,150	
	20	60	30	66	10	REV2060-30PT			\$2,157
	20	54	30	62	9	RET2054-30PT	\$840	\$1,102	
20	54	30	62	9	REV2054-30PT			\$2,103	

- ships KD
- intended for use against a wall, does not attach to the wall
- exposed hardware on back side
- EC27 undersurface power available, see page [RE26](#)
- EC28 edge mount power available, see page [RE26](#)
- optional foot rail available on 42" h table, specify and add \$596 list
- optional coat hooks (two hooks) available on 42" h and 37" h tables, specify and add \$125 list
- vertical kneespace clearance for 42" h panel table - 40 3/4"
- vertical kneespace clearance for 37" h panel table - 35 3/4"
- vertical kneespace clearance for 30" h panel table - 28 3/4"

To Order, Specify:

Veneer

- ① Model Number
- ② Worksurface Wood Species - Cherry (CH1), Maple (MA1), Walnut (WA1), Black Oak (BO1) or Double Cut (DC1) (see page [RE2](#))
- ③ Finish Color (see page [RE2](#))

- ④ Panels Species & Finish
 - a.) Same as Worksurface
 - b.) Paint (see page [RE2](#))
- ⑤ Other Product Options

Laminate

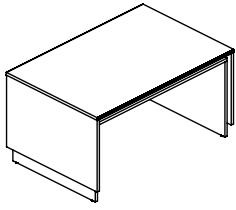
- ① Model Number
- ② Worksurface Material (see page [RE3](#))
 - a.) TFL
 - b.) HPL
- ③ Worksurface Laminate Color (see page [RE3](#))
- ④ Panels Laminate Color
 - a.) Same as Worksurface
 - b.) Other Laminate (see page [RE3](#))
- ⑤ Other Product Options

Reef



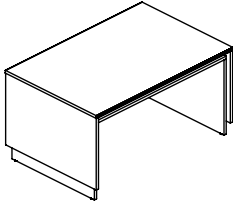
Description

42" h Layered Table



D	W	H	CTN WT	CU FT	① Model	TFL Laminate List Price	HPL Laminate List Price	Veneer Flat Cut and Double Cut List Price
48	96	42	443	44	RET4896-42LT	\$2,982	\$3,929	
48	96	42	443	44	REV4896-42LT			\$6,647
48	84	42	409	40	RET4884-42LT	\$2,816	\$3,707	
48	84	42	409	40	REV4884-42LT			\$6,270
48	72	42	375	37	RET4872-42LT	\$2,643	\$3,453	
48	72	42	375	37	REV4872-42LT			\$5,906
48	60	42	340	33	RET4860-42LT	\$2,494	\$3,225	
48	60	42	340	33	REV4860-42LT			\$5,579
48	54	42	323	31	RET4854-42LT	\$2,427	\$3,122	
48	54	42	323	31	REV4854-42LT			\$5,432
42	96	42	407	41	RET4296-42LT	\$2,837	\$3,690	
42	96	42	407	41	REV4296-42LT			\$6,345
42	84	42	375	37	RET4284-42LT	\$2,678	\$3,481	
42	84	42	375	37	REV4284-42LT			\$5,986
42	72	42	342	33	RET4272-42LT	\$2,518	\$3,244	
42	72	42	342	33	REV4272-42LT			\$5,639
42	60	42	310	30	RET4260-42LT	\$2,371	\$3,029	
42	60	42	310	30	REV4260-42LT			\$5,327
42	54	42	294	28	RET4254-42LT	\$2,309	\$2,934	
42	54	42	294	28	REV4254-42LT			\$5,191
36	96	42	355	36	RET3696-42LT	\$2,614	\$3,399	
36	96	42	355	36	REV3696-42LT			\$5,841
36	84	42	327	33	RET3684-42LT	\$2,465	\$3,206	
36	84	42	327	33	REV3684-42LT			\$5,508
36	72	42	299	29	RET3672-42LT	\$2,317	\$2,983	
36	72	42	299	29	REV3672-42LT			\$5,191
36	60	42	270	26	RET3660-42LT	\$2,184	\$2,787	
36	60	42	270	26	REV3660-42LT			\$4,904
36	54	42	256	25	RET3654-42LT	\$2,125	\$2,700	
36	54	42	256	25	REV3654-42LT			\$4,775

- ships KD
- vertical kneespace clearance 36⁵/₈"
- vertical shelf clearance 2¹⁵/₁₆"
- EC26 worksurface power available, specify "to accommodate worksurface power" on your purchase order; one EC26 unit must be ordered separately, see page [RE26](#)
- EC27 undersurface power available, see page [RE26](#)
- wire manager available, see page [RE25](#)
- optional foot rail (two rails), specify and add \$1,065 list
- optional coat hooks (four hooks), specify and add \$203 list

Description	D	W	H	CTN WT	CU FT	① Model	TFL Laminate List Price	HPL Laminate List Price	Veneer Flat Cut and Double Cut List Price
37" h Layered Table	48	96	37	407	41	RET4896-37LT	\$2,786	\$3,694	
	48	96	37	407	41	REV4896-37LT			\$6,285
	48	84	37	375	38	RET4884-37LT	\$2,629	\$3,487	
	48	84	37	375	38	REV4884-37LT			\$5,929
	48	72	37	343	34	RET4872-37LT	\$2,462	\$3,232	
	48	72	37	343	34	REV4872-37LT			\$5,590
	48	60	37	312	30	RET4860-37LT	\$2,306	\$3,007	
	48	60	37	312	30	REV4860-37LT			\$5,284
	48	54	37	296	29	RET4854-37LT	\$2,238	\$2,905	
	48	54	37	296	29	REV4854-37LT			\$5,149
	42	96	37	372	38	RET4296-37LT	\$2,623	\$3,446	
	42	96	37	372	38	REV4296-37LT			\$5,965
	42	84	37	343	34	RET4284-37LT	\$2,475	\$3,250	
	42	84	37	343	34	REV4284-37LT			\$5,627
	42	72	37	313	31	RET4272-37LT	\$2,315	\$3,015	
	42	72	37	313	31	REV4272-37LT			\$5,307
	42	60	37	283	28	RET4260-37LT	\$2,171	\$2,806	
	42	60	37	283	28	REV4260-37LT			\$5,017
	42	54	37	268	26	RET4254-37LT	\$2,111	\$2,716	
	42	54	37	268	26	REV4254-37LT			\$4,891
	36	96	37	322	33	RET3696-37LT	\$2,412	\$3,171	
	36	96	37	322	33	REV3696-37LT			\$5,490
	36	84	37	297	30	RET3684-37LT	\$2,276	\$2,989	
	36	84	37	297	30	REV3684-37LT			\$5,178
	36	72	37	271	27	RET3672-37LT	\$2,131	\$2,774	
	36	72	37	271	27	REV3672-37LT			\$4,879
	36	60	37	245	24	RET3660-37LT	\$2,001	\$2,583	
	36	60	37	245	24	REV3660-37LT			\$4,620
	36	54	37	233	23	RET3654-37LT	\$1,944	\$2,499	
	36	54	37	233	23	REV3654-37LT			\$4,498

- ships KD
- vertical kneespace clearance 31 5/8"
- vertical shelf clearance 2 15/16"
- EC26 worksurface power available, specify "to accommodate worksurface power" on your purchase order; one EC26 unit must be ordered separately, see page RE26
- EC27 undersurface power available, see page RE26
- wire manager available, see page RE25
- optional coat hooks (four hooks), specify and add \$203 list

To Order, Specify:

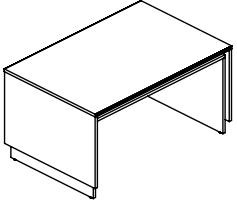
Veneer

- ① Model Number
- ② Worksurface Wood Species - Cherry (CH1), Maple (MA1), Walnut (WA1), Black Oak (BO1) or Double Cut (DC1) (see page RE2)
- ③ Finish Color (see page RE2)

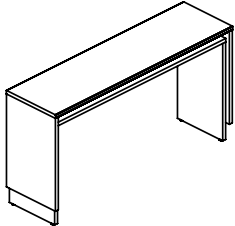
- ④ Panels Species & Finish
 - a.) Same as Worksurface
 - b.) Paint (see page RE2)
- ⑤ Other Product Options

Laminate

- ① Model Number
- ② Worksurface Material (see page RE3)
 - a.) TFL
 - b.) HPL
- ③ Worksurface/Outer Panels Laminate Color (see page RE3)
- ④ Inner Panels Laminate Color
 - a.) Same as Worksurface/Outer Panels
 - b.) Other Laminate (see page RE3)
- ⑤ Other Product Options

Description	D	W	H	CTN WT	CU FT	① Model	TFL Laminate List Price	HPL Laminate List Price	Veneer Flat Cut and Double Cut List Price
30" h Layered Table	48	96	30	364	38	RET4896-30LT	\$2,615	\$3,489	
	48	96	30	364	38	REV4896-30LT			\$5,947
	48	84	30	334	34	RET4884-30LT	\$2,467	\$3,291	
	48	84	30	334	34	REV4884-30LT			\$5,610
	48	72	30	303	31	RET4872-30LT	\$2,293	\$3,030	
	48	72	30	303	31	REV4872-30LT			\$5,281
	48	60	30	273	27	RET4860-30LT	\$2,136	\$2,796	
	48	60	30	273	27	REV4860-30LT			\$4,988
	48	54	30	258	26	RET4854-30LT	\$2,070	\$2,693	
	48	54	30	258	26	REV4854-30LT			\$4,859
	42	96	30	334	35	RET4296-30LT	\$2,478	\$3,273	
	42	96	30	334	35	REV4296-30LT			\$5,603
	42	84	30	306	31	RET4284-30LT	\$2,337	\$3,089	
	42	84	30	306	31	REV4284-30LT			\$5,285
	42	72	30	277	28	RET4272-30LT	\$2,169	\$2,843	
	42	72	30	277	28	REV4272-30LT			\$4,979
	42	60	30	249	25	RET4260-30LT	\$2,025	\$2,628	
	42	60	30	249	25	REV4260-30LT			\$4,706
	42	54	30	235	23	RET4254-30LT	\$1,961	\$2,529	
	42	54	30	235	23	REV4254-30LT			\$4,583
	36	96	30	288	30	RET3696-30LT	\$2,278	\$3,014	
	36	96	30	288	30	REV3696-30LT			\$5,159
	36	84	30	264	27	RET3684-30LT	\$2,151	\$2,842	
	36	84	30	264	27	REV3684-30LT			\$4,867
	36	72	30	239	25	RET3672-30LT	\$1,999	\$2,621	
	36	72	30	239	25	REV3672-30LT			\$4,583
	36	60	30	215	22	RET3660-30LT	\$1,866	\$2,416	
	36	60	30	215	22	REV3660-30LT			\$4,329
	36	54	30	203	20	RET3654-30LT	\$1,803	\$2,324	
	36	54	30	203	20	REV3654-30LT			\$4,218

- ships KD
- vertical kneespace clearance 24 5/8"
- vertical shelf clearance 2 15/16"
- EC26 worksurface power available, specify "to accommodate worksurface power" on your purchase order; one EC26 unit must be ordered separately, see page [RE26](#)
- EC27 undersurface power available, see page [RE26](#)
- wire manager available, see page [RE25](#)

Description	D	W	H	CTN WT	CU FT	① Model	TFL Laminate List Price	HPL Laminate List Price	Veneer Flat Cut and Double Cut List Price
20"d Wall Dependent Layered Table	20	84	42	148	19	RET2084-42LT	\$1,629	\$2,079	
	20	84	42	148	19	REV2084-42LT			\$3,779
	20	72	42	132	17	RET2072-42LT	\$1,544	\$1,954	
	20	72	42	132	17	REV2072-42LT			\$3,582
	20	60	42	116	15	RET2060-42LT	\$1,467	\$1,839	
	20	60	42	116	15	REV2060-42LT			\$3,387
	20	54	42	109	14	RET2054-42LT	\$1,434	\$1,791	
	20	54	42	109	14	REV2054-42LT			\$3,298
	20	84	37	136	17	RET2084-37LT	\$1,505	\$1,949	
	20	84	37	136	17	REV2084-37LT			\$3,579
	20	72	37	121	16	RET2072-37LT	\$1,410	\$1,807	
	20	72	37	121	16	REV2072-37LT			\$3,375
	20	60	37	107	14	RET2060-37LT	\$1,324	\$1,684	
	20	60	37	107	14	REV2060-37LT			\$3,190
	20	54	37	100	13	RET2054-37LT	\$1,286	\$1,629	
	20	54	37	100	13	REV2054-37LT			\$3,109
	20	84	30	125	16	RET2084-30LT	\$1,420	\$1,850	
	20	84	30	125	16	REV2084-30LT			\$3,360
	20	72	30	111	14	RET2072-30LT	\$1,321	\$1,707	
	20	72	30	111	14	REV2072-30LT			\$3,165
	20	60	30	97	13	RET2060-30LT	\$1,233	\$1,576	
	20	60	30	97	13	REV2060-30LT			\$2,989
	20	54	30	86	12	RET2054-30LT	\$1,195	\$1,512	
	20	54	30	86	12	REV2054-30LT			\$2,913

- ships KD
- intended for use against a wall, does not attach to the wall
- exposed hardware on back side
- vertical shelf clearance 2 1/8"
- EC27 undersurface power available, see page RE26
- EC28 edge mount power available, see page RE26
- optional foot rail available on 42" table, specify and add \$596 list
- optional coat hooks (two hooks) available on 42" and 37" tables, specify and add \$125 list
- vertical kneespace clearance for 42" layered table - 36 5/8"
- vertical kneespace clearance for 37" layered table - 31 5/8"
- vertical kneespace clearance for 30" layered table - 24 5/8"

To Order, Specify:

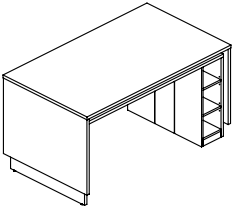
Veneer

- ① Model Number
- ② Worksurface Wood Species - Cherry (CH1), Maple (MA1), Walnut (WA1), Black Oak (BO1) or Double Cut (DC1) (see page RE2)
- ③ Finish Color (see page RE2)

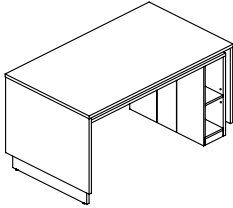
- ④ Inner Panels Species & Finish
 - a.) Same as Worksurface/Outer Panels
 - b.) Paint (see page RE2)
- ⑤ Other Product Options

Laminate

- ① Model Number
- ② Worksurface Material (see page RE3)
 - a.) TFL
 - b.) HPL
- ③ Worksurface/Outer Panels Laminate Color (see page RE3)
- ④ Inner Panels Laminate Color
 - a.) Same as Worksurface/Outer Panels
 - b.) Other Laminate (see page RE3)
- ⑤ Other Product Options

Description	D	W	H	CTN WT	CU FT	① Model	TFL Laminate List Price	HPL Laminate List Price	Veneer Flat Cut and Double Cut List Price
42" h Layered Table with Asymmetric Bookshelf	48	96	42	579	55	RET4896-42LTNB	\$3,468	\$4,476	
	48	96	42	579	55	REV4896-42LTNB			\$7,625
	48	84	42	545	51	RET4884-42LTNB	\$3,269	\$4,220	
	48	84	42	545	51	REV4884-42LTNB			\$7,194
	48	72	42	511	47	RET4872-42LTNB	\$3,101	\$3,967	
	48	72	42	511	47	REV4872-42LTNB			\$6,825
	48	60	42	476	43	RET4860-42LTNB	\$2,949	\$3,740	
	48	60	42	476	43	REV4860-42LTNB			\$6,501
	48	54	42	459	42	RET4854-42LTNB	\$2,881	\$3,637	
	48	54	42	459	42	REV4854-42LTNB			\$6,351
	42	96	42	530	50	RET4296-42LTNB	\$3,279	\$4,214	
	42	96	42	530	50	REV4296-42LTNB			\$7,219
	42	84	42	498	46	RET4284-42LTNB	\$3,092	\$3,974	
	42	84	42	498	46	REV4284-42LTNB			\$6,810
	42	72	42	466	43	RET4272-42LTNB	\$2,930	\$3,736	
	42	72	42	466	43	REV4272-42LTNB			\$6,462
	42	60	42	433	39	RET4260-42LTNB	\$2,786	\$3,522	
	42	60	42	433	39	REV4260-42LTNB			\$6,150
	42	54	42	417	38	RET4254-42LTNB	\$2,723	\$3,426	
	42	54	42	417	38	REV4254-42LTNB			\$6,012
	36	96	42	466	44	RET3696-42LTNB	\$3,032	\$3,881	
	36	96	42	466	44	REV3696-42LTNB			\$6,707
	36	84	42	437	41	RET3684-42LTNB	\$2,860	\$3,660	
	36	84	42	437	41	REV3684-42LTNB			\$6,328
	36	72	42	409	38	RET3672-42LTNB	\$2,712	\$3,440	
	36	72	42	409	38	REV3672-42LTNB			\$6,009
	36	60	42	381	34	RET3660-42LTNB	\$2,581	\$3,244	
	36	60	42	381	34	REV3660-42LTNB			\$5,725
	36	54	42	367	33	RET3654-42LTNB	\$2,521	\$3,155	
	36	54	42	367	33	REV3654-42LTNB			\$5,593

- ships KD
- vertical kneespace clearance 36 5/8"
- vertical shelf clearance 2 15/16"
- adjustable shelves
- removable wire access panel on bookcase side
- EC26 worksurface power available, specify "to accommodate worksurface power" on your purchase order; one EC26 unit must be ordered separately, see page [RE26](#)
- EC27 undersurface power available, see page [RE26](#)
- wire manager available on non-bookcase side, see page [RE25](#)
- optional foot rail (two rails), specify and add \$1,065 list
- optional coat hooks (four hooks), specify and add \$203 list

Description	D	W	H	CTN WT	CU FT	① Model	TFL Laminate List Price	HPL Laminate List Price	Veneer Flat Cut and Double Cut List Price
37" h Layered Table with Asymmetric Bookshelf	48	96	37	531	51	RET4896-37LTNB	\$3,260	\$4,164	
	48	96	37	531	51	REV4896-37LTNB			\$7,167
	48	84	37	499	47	RET4884-37LTNB	\$3,074	\$3,927	
	48	84	37	499	47	REV4884-37LTNB			\$6,760
	48	72	37	467	44	RET4872-37LTNB	\$2,915	\$3,729	
	48	72	37	467	44	REV4872-37LTNB			\$6,419
	48	60	37	436	40	RET4860-37LTNB	\$2,773	\$3,517	
	48	60	37	436	40	REV4860-37LTNB			\$6,112
	48	54	37	420	38	RET4854-37LTNB	\$2,710	\$3,422	
	48	54	37	420	38	REV4854-37LTNB			\$5,972
	42	96	37	485	46	RET4296-37LTNB	\$3,083	\$3,920	
	42	96	37	485	46	REV4296-37LTNB			\$6,787
	42	84	37	455	43	RET4284-37LTNB	\$2,906	\$3,697	
	42	84	37	455	43	REV4284-37LTNB			\$6,403
	42	72	37	425	40	RET4272-37LTNB	\$2,755	\$3,512	
	42	72	37	425	40	REV4272-37LTNB			\$6,075
	42	60	37	396	36	RET4260-37LTNB	\$2,620	\$3,311	
	42	60	37	396	36	REV4260-37LTNB			\$5,784
	42	54	37	381	35	RET4254-37LTNB	\$2,560	\$3,222	
	42	54	37	381	35	REV4254-37LTNB			\$5,653
	36	96	37	423	40	RET3696-37LTNB	\$2,790	\$3,572	
	36	96	37	423	40	REV3696-37LTNB			\$6,173
	36	84	37	398	37	RET3684-37LTNB	\$2,632	\$3,369	
	36	84	37	398	37	REV3684-37LTNB			\$5,821
	36	72	37	372	35	RET3672-37LTNB	\$2,497	\$3,166	
	36	72	37	372	35	REV3672-37LTNB			\$5,530
	36	60	37	346	32	RET3660-37LTNB	\$2,375	\$2,983	
	36	60	37	346	32	REV3660-37LTNB			\$5,269
	36	54	37	334	30	RET3654-37LTNB	\$2,320	\$2,904	
	36	54	37	334	30	REV3654-37LTNB			\$5,149

- ships KD
- vertical kneespace clearance 31 5/8"
- vertical shelf clearance 2 15/16"
- adjustable shelf
- removable wire access panel on bookcase side
- EC26 worksurface power available, specify "to accommodate worksurface power" on your purchase order; one EC26 unit must be ordered separately, see page [RE26](#)
- EC27 undersurface power available, see page [RE26](#)
- wire manager available on non-bookcase side, see page [RE25](#)
- optional coat hooks (four hooks), specify and add \$203 list

To Order, Specify:

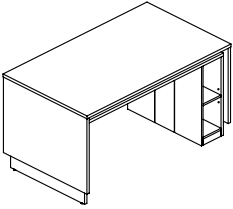
Veneer

- ① Model Number
- ② Worksurface Wood Species - Cherry (CH1), Maple (MA1), Walnut (WA1), Black Oak (BO1) or Double Cut (DC1) (see page [RE2](#))
- ③ Finish Color (see page [RE2](#))

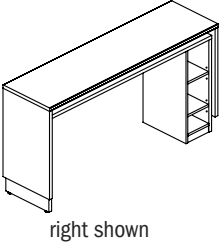
- ④ Bookcase /Inner Panels Species & Finish
 - a.) Same as Worksurface/Outer Panels
 - b.) Paint (see page [RE2](#))
- ⑤ Other Product Options

Laminate

- ① Model Number
- ② Worksurface Material (see page [RE3](#))
 - a.) TFL
 - b.) HPL
- ③ Worksurface/Outer Panels Laminate Color (see page [RE3](#))
- ④ Bookcase/Inner Panels Laminate Color
 - a.) Same as Worksurface/Outer Panels
 - b.) Other Laminate (see page [RE3](#))
- ⑤ Other Product Options

Description	D	W	H	CTN WT	CU FT	① Model	TFL Laminate List Price	HPL Laminate List Price	Veneer Flat Cut and Double Cut List Price
30" h Layered Table with Asymmetric Bookshelf	48	96	30	462	46	RET4896-30LTNB	\$3,064	\$3,916	
	48	96	30	462	46	REV4896-30LTNB			\$6,738
	48	84	30	432	42	RET4884-30LTNB	\$2,891	\$3,693	
	48	84	30	432	42	REV4884-30LTNB			\$6,353
	48	72	30	401	39	RET4872-30LTNB	\$2,741	\$3,505	
	48	72	30	401	39	REV4872-30LTNB			\$6,035
	48	60	30	371	35	RET4860-30LTNB	\$2,608	\$3,306	
	48	60	30	371	35	REV4860-30LTNB			\$5,748
	48	54	30	356	33	RET4854-30LTNB	\$2,547	\$3,216	
	48	54	30	356	33	REV4854-30LTNB			\$5,617
	42	96	30	423	42	RET4296-30LTNB	\$2,899	\$3,684	
	42	96	30	423	42	REV4296-30LTNB			\$6,381
	42	84	30	394	38	RET4284-30LTNB	\$2,733	\$3,476	
	42	84	30	394	38	REV4284-30LTNB			\$6,021
	42	72	30	366	35	RET4272-30LTNB	\$2,590	\$3,301	
	42	72	30	366	35	REV4272-30LTNB			\$5,712
	42	60	30	338	32	RET4260-30LTNB	\$2,464	\$3,114	
	42	60	30	338	32	REV4260-30LTNB			\$5,438
	42	54	30	324	30	RET4254-30LTNB	\$2,407	\$3,029	
	42	54	30	324	30	REV4254-30LTNB			\$5,317
	36	96	30	368	36	RET3696-30LTNB	\$2,567	\$3,289	
	36	96	30	368	36	REV3696-30LTNB			\$5,679
	36	84	30	344	33	RET3684-30LTNB	\$2,419	\$3,102	
	36	84	30	344	33	REV3684-30LTNB			\$5,356
	36	72	30	319	31	RET3672-30LTNB	\$2,299	\$2,915	
	36	72	30	319	31	REV3672-30LTNB			\$5,088
	36	60	30	295	28	RET3660-30LTNB	\$2,187	\$2,747	
	36	60	30	295	28	REV3660-30LTNB			\$4,848
	36	54	30	283	26	RET3654-30LTNB	\$2,135	\$2,674	
	36	54	30	283	26	REV3654-30LTNB			\$4,739

- ships KD
- vertical kneespace clearance 24 5/8"
- vertical shelf clearance 2 15/16"
- adjustable shelf
- removable wire access panel on bookcase side
- EC26 worksurface power available, specify "to accommodate worksurface power" on your purchase order; one EC26 unit must be ordered separately, see page [RE26](#)
- EC27 undersurface power available, see page [RE26](#)
- wire manager available on non-bookcase side, see page [RE25](#)

Description	D	W	H	CTN WT	CU FT	① Model	TFL Laminate List Price	HPL Laminate List Price	Veneer Flat Cut and Double Cut List Price
42" h Wall Dependent Layered Table with Asymmetric Bookshelf	20	84	42	209	23	RET2084-42LTNBR	\$2,022	\$2,554	
	20	84	42	209	23	REV2084-42LTNBR			\$4,406
 right shown	20	84	42	209	23	RET2084-42LTNBL	\$2,022	\$2,554	
	20	84	42	209	23	REV2084-42LTNBL			\$4,406
	20	72	42	193	22	RET2072-42LTNBR	\$1,936	\$2,431	
	20	72	42	193	22	REV2072-42LTNBR			\$4,211
	20	72	42	193	22	RET2072-42LTNBL	\$1,936	\$2,431	
	20	72	42	193	22	REV2072-42LTNBL			\$4,211
	20	60	42	177	20	RET2060-42LTNBR	\$1,862	\$2,314	
	20	60	42	177	20	REV2060-42LTNBR			\$4,017
	20	60	42	177	20	RET2060-42LTNBL	\$1,862	\$2,314	
	20	60	42	177	20	REV2060-42LTNBL			\$4,017
	20	54	42	169	19	RET2054-42LTNBR	\$1,827	\$2,266	
	20	54	42	169	19	REV2054-42LTNBR			\$3,927
	20	54	42	169	19	RET2054-42LTNBL	\$1,827	\$2,266	
	20	54	42	169	19	REV2054-42LTNBL			\$3,927

- ships KD
- intended for use against a wall, does not attach to the wall
- exposed hardware on back side
- vertical kneespace clearance 36 5/8"
- vertical shelf clearance 2 15/16"
- adjustable shelves
- EC27 undersurface power available, see page [RE26](#)
- EC28 edge mount power available, see page [RE26](#)
- optional foot rail, specify and add \$596 list
- optional coat hooks (two hooks), specify and add \$125 list

To Order, Specify:

Veneer

- ① Model Number
- ② Worksurface Wood Species - Cherry (CH1), Maple (MA1), Walnut (WA1), Black Oak (BO1) or Double Cut (DC1) (see page [RE2](#))
- ③ Finish Color (see page [RE2](#))

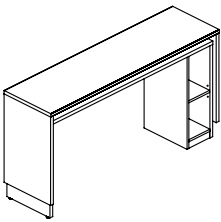
- ④ Bookcase /Inner Panels Species & Finish
 - a.) Same as Worksurface/Outer Panels
 - b.) Paint (see page [RE2](#))
- ⑤ Other Product Options

Laminate

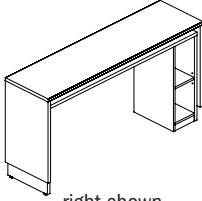
- ① Model Number
- ② Worksurface Material (see page [RE3](#))
 - a.) TFL
 - b.) HPL
- ③ Worksurface/Outer Panels Laminate Color (see page [RE3](#))
- ④ Bookcase/Inner Panels Laminate Color
 - a.) Same as Worksurface/Outer Panels
 - b.) Other Laminate (see page [RE3](#))
- ⑤ Other Product Options

Reef



Description	D	W	H	CTN WT	CU FT	① Model	TFL Laminate List Price	HPL Laminate List Price	Veneer Flat Cut and Double Cut List Price
37" h Wall Dependent Layered Table with Asymmetric Bookshelf	20	84	37	191	22	RET2084-37LTNBR	\$1,904	\$2,402	
	20	84	37	191	22	REV2084-37LTNBR			\$4,146
	20	84	37	191	22	RET2084-37LTNBL	\$1,904	\$2,402	
	20	84	37	191	22	REV2084-37LTNBL			\$4,146
	20	72	37	177	20	RET2072-37LTNBR	\$1,803	\$2,262	
	20	72	37	177	20	REV2072-37LTNBR			\$3,942
	20	72	37	177	20	RET2072-37LTNBL	\$1,803	\$2,262	
	20	72	37	177	20	REV2072-37LTNBL			\$3,942
	20	60	37	162	18	RET2060-37LTNBR	\$1,721	\$2,136	
	20	60	37	162	18	REV2060-37LTNBR			\$3,759
	20	60	37	162	18	RET2060-37LTNBL	\$1,721	\$2,136	
	20	60	37	162	18	REV2060-37LTNBL			\$3,759
	20	54	37	155	18	RET2054-37LTNBR	\$1,684	\$2,080	
	20	54	37	155	18	REV2054-37LTNBR			\$3,677
	20	54	37	155	18	RET2054-37LTNBL	\$1,684	\$2,080	
	20	54	37	155	18	REV2054-37LTNBL			\$3,677

- ships KD
- intended for use against a wall, does not attach to the wall
- exposed hardware on back side
- vertical kneespace clearance 31 5/8"
- vertical shelf clearance 2 15/16"
- adjustable shelf
- EC27 undersurface power available, see page [RE26](#)
- EC28 edge mount power available, see page [RE26](#)
- optional coat hooks (two hooks), specify and add \$125 list

Description	D	W	H	CTN WT	CU FT	① Model	TFL Laminate List Price	HPL Laminate List Price	Veneer Flat Cut and Double Cut List Price
30" h Wall Dependent Layered Table with Asymmetric Bookshelf	20	84	30	169	19	RET2084-30LTNBR	\$1,789	\$2,259	
	20	84	30	169	19	REV2084-30LTNBR			\$3,900
 right shown	20	84	30	169	19	RET2084-30LTNBL	\$1,789	\$2,259	
	20	84	30	169	19	REV2084-30LTNBL			\$3,900
	20	72	30	155	18	RET2072-30LTNBR	\$1,687	\$2,113	
	20	72	30	155	18	REV2072-30LTNBR			\$3,704
	20	72	30	155	18	RET2072-30LTNBL	\$1,687	\$2,113	
	20	72	30	155	18	REV2072-30LTNBL			\$3,704
	20	60	30	141	16	RET2060-30LTNBR	\$1,598	\$1,984	
	20	60	30	141	16	REV2060-30LTNBR			\$3,531
	20	60	30	141	16	RET2060-30LTNBL	\$1,598	\$1,984	
	20	60	30	141	16	REV2060-30LTNBL			\$3,531
	20	54	30	134	15	RET2054-30LTNBR	\$1,560	\$1,920	
	20	54	30	134	15	REV2054-30LTNBR			\$3,452
	20	54	30	134	15	RET2054-30LTNBL	\$1,560	\$1,920	
	20	54	30	134	15	REV2054-30LTNBL			\$3,452

- ships KD
- intended for use against a wall, does not attach to the wall
- exposed hardware on back side
- vertical kneespace clearance 24 5/8"
- vertical shelf clearance 2 15/16"
- adjustable shelf
- EC27 undersurface power available, see page [RE26](#)
- EC28 edge mount power available, see page [RE26](#)

To Order, Specify:

Veneer

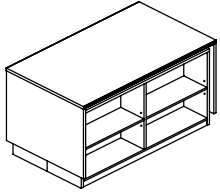
- ① Model Number
- ② Worksurface Wood Species - Cherry (CH1), Maple (MA1), Walnut (WA1), Black Oak (BO1) or Double Cut (DC1) (see page [RE2](#))
- ③ Finish Color (see page [RE2](#))

- ④ Bookcase /Inner Panels Species & Finish
 - a.) Same as Worksurface/Outer Panels
 - b.) Paint (see page [RE2](#))
- ⑤ Other Product Options

Laminate

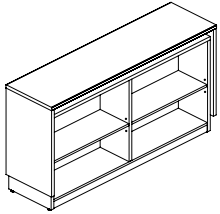
- ① Model Number
- ② Worksurface Material (see page [RE3](#))
 - a.) TFL
 - b.) HPL
- ③ Worksurface/Outer Panels Laminate Color (see page [RE3](#))
- ④ Bookcase/Inner Panels Laminate Color
 - a.) Same as Worksurface/Outer Panels
 - b.) Other Laminate (see page [RE3](#))
- ⑤ Other Product Options

Description	D	W	H	CTN WT	CU FT	① Model	TFL Laminate List Price	HPL Laminate List Price	Veneer Flat Cut and Double Cut List Price
37" h Layered Table with Full Width Bookcases	48	72	37	485	86	RET4872-37LTFB	\$3,122	\$4,037	
	48	72	37	485	86	REV4872-37LTFB			\$7,304
	42	72	37	450	76	RET4272-37LTFB	\$2,935	\$3,795	
	42	72	37	450	76	REV4272-37LTFB			\$6,864



- ships KD
- adjustable shelves
- vertical shelf clearance 2 15/16"

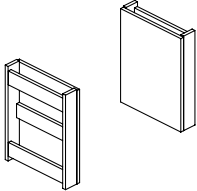
37" h Wall Dependent Layered Table with Full Width Bookcases	20	72	37	232	38	RET2072-37LTFB	\$1,798	\$2,291	
	20	72	37	232	38	REV2072-37LTFB			\$4,189



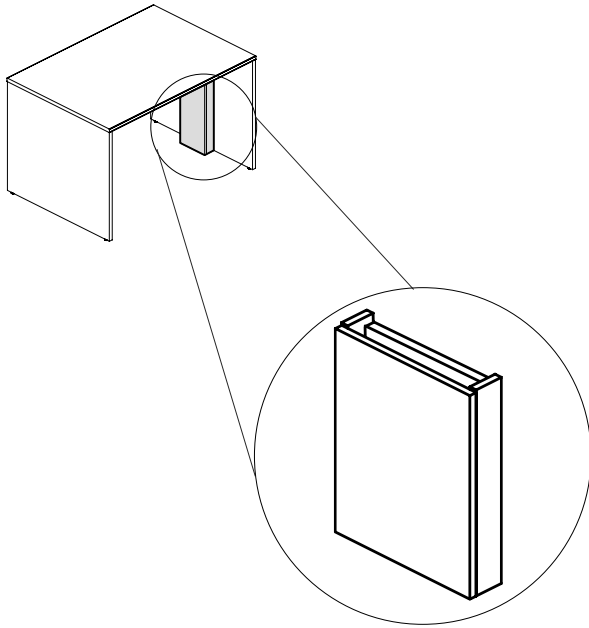
- ships KD
- intended for use against a wall, does not attach to the wall
- exposed hardware on back side
- adjustable shelves
- vertical shelf clearance 2 15/16"

To Order, Specify:

- | | | |
|--|---|--|
| <p>Veneer</p> <ul style="list-style-type: none"> ① Model Number ② Worksurface Wood Species - Cherry (CH1), Maple (MA1), Walnut (WA1), Black Oak (BO1) or Double Cut (DC1) (see page RE2) ③ Finish Color (see page RE2) | <ul style="list-style-type: none"> ④ Bookcase/Inner Panels Species & Finish <ul style="list-style-type: none"> a.) Same as Worksurface/Outer Panels b.) Paint (see page RE2) ⑤ Other Product Options | <p>Laminate</p> <ul style="list-style-type: none"> ① Model Number ② Worksurface Laminate Color (see page RE3) ③ Worksurface/Outer Panels Laminate Color (see page RE3) ④ Bookcase/Inner Panels Laminate Color <ul style="list-style-type: none"> a.) Same as Worksurface/Outer Panels b.) Other Laminate (see page RE3) ⑤ Other Product Options |
|--|---|--|

Description	D	W	H	CTN WT	CU FT	① Model	Laminate List Price	Veneer Flat Cut and Double Cut List Price
Vertical Wire Manager 	3 3/4	16	26 1/2	18	2	RET1626WMA	\$410	
	3 3/4	16	26 1/2	18	2	REV1626WMA		\$934
	3 3/4	10	26 1/2	15	2	RET1026WMA	\$393	
	3 3/4	10	26 1/2	15	2	REV1026WMA		\$902
	3 3/4	16	20 1/2	15	2	RET1620WMA	\$351	
	3 3/4	16	20 1/2	15	2	REV1620WMA		\$801
	3 3/4	10	20 1/2	12	1	RET1020WMA	\$335	
	3 3/4	10	20 1/2	12	1	REV1020WMA		\$775
	3 3/4	16	17 1/2	13	2	RET1617WMA	\$325	
	3 3/4	16	17 1/2	13	2	REV1617WMA		\$760
	3 3/4	10	17 1/2	11	1	RET1017WMA	\$313	
	3 3/4	10	17 1/2	11	1	REV1017WMA		\$743

- attaches to non-bookcase end panels
- sold as individual unit (not in pairs)
- see page [RE3](#) to determine appropriate vertical wire manager



To Order, Specify:

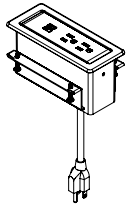
Veneer

- ① Model Number
- ② Worksurface Wood Species - Cherry (CH1), Maple (MA1), Walnut (WA1), Black Oak (BO1) or Double Cut (DC1) (see page [RE2](#))
- ③ Finish Color (see page [RE2](#))

Laminate

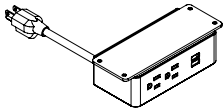
- ① Model Number
- ② Laminate Color (see page [RE3](#))

Description	D	W	H	CTN WT	CU FT	① Model	List Price
Worksurface Power	2 5/8	6 3/8	3	3	1	EC26	\$516



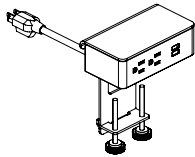
- two power receptacles - 120 volt; 15 amp dual powered USB
- 120" power cord with molded plug
- White (W) or Black (B) finish available, specify when ordering
- UL recognized
- meets UL spill requirements

Under Surface Power	3	6 1/2	1 13/16	2	1	EC27	\$406
---------------------	---	-------	---------	---	---	------	-------



- two power receptacles - 120 volt; 15 amp dual powered USB
- 120" power cord with molded plug
- White (W) or Black (B) finish available, specify when ordering
- UL recognized

Edge Mount Power	3 1/2	5 1/2	7 1/2	3	1	EC28	\$414
------------------	-------	-------	-------	---	---	------	-------



- two power receptacles - 120 volt; 15 amp dual powered USB
- 120" power cord with molded plug
- White (W) or Black (B) finish available, specify when ordering
- UL recognized

To Order, Specify:

- ① Model Number

Romy Tables Order Check List: For Tops



Specify:

Top

- 1. Model Number
- 2. Top Material

A. Veneer (W)

- 1. Wood Species - Cherry (CH1), Maple (MA1), Oak (OK1) or Walnut (WA1)
- 2. Wood Finish

B. Laminate (L)

- 1. Laminate Color

Example:

Top

RM54SQCL | L | DWH
 (model #) | (top material) | (laminate color)

Top Wood Species/Finish:

CH1 Cherry <i>Flat Cut Veneer</i>	
BBM Bourbon Medium	CLL Collectors
BRM Brighton Medium	HRV Harvest
CLA Classic	PRL Praline
MA1 Maple <i>Flat Cut Veneer</i>	
ALM Ale Medium	FLX Flax
BUT Butterscotch	VEN Venetian
WA1 Walnut <i>Flat Cut Veneer</i>	
ESP Espresso	TRF Truffle
MCH Mocha	UMB Umber
SIE Sienna	
OK1 Red Oak <i>Flat Cut Veneer</i>	
BRW Brownie	HEN Henna
CAN Canyon	HNY Honey
CIT Citron	NUT Nut Brown
DES Desert	

**Top Material Selection (continued):
Laminate**

TFL - HPL Wood Grain Pattern Laminates

ALL Ale Light	MIN Mineral
BOL Bourbon Light	OAT Oatmeal Cookie
BZW Brazilwood	PIN Pinnacle Walnut
BGL Brighton Light	STU Studio Teak
CLL Collectors	UMB Umber
FAW Fawn	VAL Valley
FLO Florence Walnut	VIN Vintage
GRH Graphite	WEA Weathered Ash

TFL - HPL Solid Laminates

ALB Alabaster	DWH Designer White
BLK Black	SHD Shadow
BBL Bridal Blanco	SLG Slate Grey

Laminate Tops on Veneer Units

Work surface only, no additional upcharge if Vision's coordinating wood grain laminate with finished wood edges is specified. Contact Customer Service for any other laminate request. Listed below are finishes that have coordinating wood grain HPL laminates.

CH1 Cherry *Flat Cut Veneer*

CLL Collectors
HRV Harvest
PRL Praline

WA1 Walnut *Flat Cut Veneer*

MCH Mocha	TRF Truffle
SIE Sienna	UMB Umber

Romy Tables Order Check List: For Base



Specify:

Base

- 1. Model Number
- 2. Wood Finish/Paint Color
- 3. Optional Rubber Cushion Nylon Glides - no upcharge

Example:

Base

RM3535-TBB | **FLX**
 (model #) | (wood finish)

Base Wood Finish:

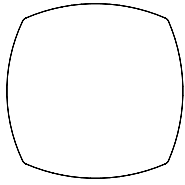
ALM	Ale Medium	CGR	Graphite Coordinate
CAL	Ale Light Coordinate	HRV	Harvest
BBM	Bourbon Medium	HEN	Henna
CBZ	Brazilwood Coordinate	HNY	Honey
BARC	Barrel Coordinate	CKC	Khaki Coordinate
CBO	Bourbon Light Coordinate	MINC	Mineral Coordinate
CBG	Brighton Light Coordinate	MCH	Mocha
BRM	Brighton Medium	NUT	Nut Brown
BRW	Brownie	CPI	Pinnacle Walnut Coordinate
BUT	Butterscotch		
CAN	Canyon	PRL	Praline
CIT	Citron	RAVC	Raven Coordinate
CNDC	Cinder Coordinate	SABC	Sable Coordinate
CLA	Classic	SIE	Sienna
CLL	Collectors	CST	Studio Teak Coordinate
DES	Desert	TRF	Truffle
EGRC	Egret Coordinate	UMB	Umber
ESP	Espresso	VALC	Valley Coordinate
FAWC	Fawn Coordinate	VEN	Venetian
FLX	Flax	CWE	Weathered Ash Coordinate

Base Paint Color - Add \$45 list per item:

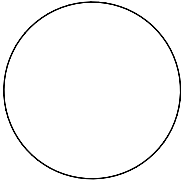
PAB	Alabaster	GRV	Greek Villa
BKD	Blackdrop	GLF	Gulf Stream
BFX	Black Fox	HTB	Heartthrob
PBB	Bridal Blanco	NET	Network Gray
BWH	Bright White	NWH	Nonchalan White
CGP	Cargo Pants	PAR	Paradise
CHT	Chatroom	QXP	Quixotic Plum
DSY	Daisy	RBZ	Relic Bronze
DRG	Daring	SNB	Sandbank
PDW	Designer White	PSD	Shadow
DYN	Dynamo	PSG	Slate Grey
ENG	Enigma	STM	Storm
FRR	French Roast	TRC	Tricorn Black
GBY	Georgian Bay		

ROMY

Description	D	W	H	CTN WT	CU FT	① Model	List Price
Squire Top	54	54	1 ¼	109	8	RM54SQCL	\$1,260
	48	48	1 ¼	86	7	RM48SQCL	\$1,166



Round Top	54	54	1 ¼	92	8	RM54ROUN	\$1,260
	48	48	1 ¼	73	7	RM48ROUN	\$1,166



Base	35	35	28 ½	25	5	RM3535-TBB	\$1,391
------	----	----	------	----	---	------------	---------



· beech wood species

Base	35	35	28 ½	25	5	RM3535-TBM	\$1,391
------	----	----	------	----	---	------------	---------



· maple wood species

Tops

To Order, Specify:

- ① Model Number
- ② Top Material - Veneer (W) or Laminate (L)
- ③ Wood Species - Cherry (CH1), Maple (MA1), Oak (OK1) or Walnut (WA1)
- ④ Wood Finish/Laminate Color

Specifications

- Wood species - Cherry, Maple Oak or Walnut.
- Core material is 1 ½" MDF.
- Face is wood veneer or horizontal grade HPL.
- Backer is bonded to bottom side to ensure balanced construction.
- Bevel MDF edge.

Bases

To Order, Specify:

- ① Model Number
- ② Wood Finish/Paint Color
- ③ Optional Rubber Cushion Nylon Glides - no upcharge

Specifications

- Wood species - Beech or Maple.
- Standard with rubber cushion metal glides.

Strata



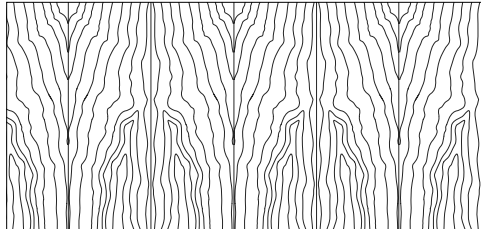
Strata

Strata Product Information

Strata Veneer

Exterior Wood Materials

Exterior surfaces are made from the finest selected veneers to achieve clarity and consistency in the Strata Veneer product line. To attain a pleasing, symmetrical pattern, all cherry, maple, walnut and black oak veneers are book-matched. All exterior solid lumber is matched to coordinate with the veneer.

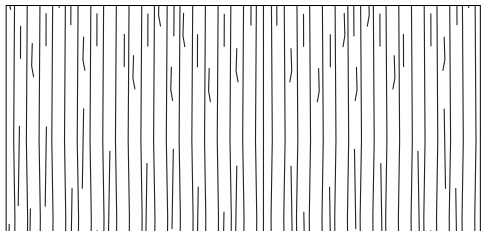


Book-Matched Example

Alternating pieces of veneer are flipped over so they face each other like the pages within a book.

Strata Veneer is available in flat cut cherry, maple, walnut and black oak veneer. A wide range of wood stains have been formulated to enhance the beauty of the veneer.

Double Cut veneer is another choice on Strata Veneer product. This veneer is a processed product that has at least two cuttings to create the final veneers. These cuts of veneer strands are dyed and layered into a block to create variation of patterns from a very tight grain pattern to an exotic figure grain pattern. The diagram below shows the tight pattern used on Strata Veneer.



Solid painted finishes on MDF are also offered to provide an accent to the Strata product.

Worksurface Construction

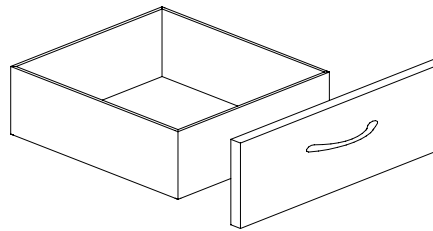
Tops are 5-ply balanced construction, 1 3/16" thick with solid matching hardwood edges. Surfaces are available in wood veneer or high pressure laminate. No additional charge for using our coordinating high pressure laminate with a veneer grain pattern with finish wood edges.

Case Construction

Outside panels are 3/4" and joined together with dowels reinforced with screws, cleats and metal fasteners for increased stability. Leveling glides are set into solid hardwood blocks, which helps to prevent the leveling glide from tear out. Tops are secured to the chassis with top fastening cleats screwed to the inside of the panels.

Drawers

The unidirectional V-Fold drawer box is a durable miter-fold drawer structure which is glued and doweled. The 1/2" thick drawer sides are wrapped in a high grade maple vinyl, with an attached front. The drawer front is attached to the four sided box.



Drawer Suspension

High quality black drawer suspension carries a lifetime warranty. File and box drawers have 100% full extension with over travel. Slides feature steel ball bearings for longer wear and positive, cushioned in/out stops.

Locking

Desk and return pedestals feature pedestal front locking to provide maximum security and flexibility in configuration.

Units are shipped randomly keyed as standard. Key alike units are available upon request for no additional charges. Removable cores for in-field re-keying are standard. product.

Installation

Installation assistance is available, contact Customer Service for a quote.

Strata Product Information

Finish - Stain/Colors

We offer a variety of wood stains and paint colors on Strata. Please see the chart below. Samples are available upon request. Finishes with an asterisk (*) have coordinating laminate tops.

CH1 Cherry	<i>Flat Cut Veneer</i>	
BBM Bourbon Medium	CLL Collectors	
BRM Brighton Medium	HRV Harvest	
CLA Classic	PRL Praline	

MA1 Maple	<i>Flat Cut Veneer</i>	
ALM Ale Medium	FLX Flax	
BUT Butterscotch	VEN Venetian	

WA1 Walnut	<i>Flat Cut Veneer</i>	
ESP Espresso	TRF Truffle	
MCH Mocha	UMB Umber	
SIE Sienna		

B01 Black Oak	<i>Flat Cut Veneer</i>	
RAV Raven		

DC1 Double Cut Veneer		
BAR Barrel - Oak Pattern	KHK Khaki	
BUF Buff - Oak Pattern	MIN Mineral - Oak Pattern	
CND Cinder - Oak Pattern	RYE Rye - Oak Pattern	
COF Coffee	SAB Sable - Oak Pattern	
EGR Egret - Oak Pattern	SAD Saddle - Oak Pattern	
FAW Fawn	STU Studio Teak	
GRH Graphite	VAL Valley	

PNT Paint	<i>Maple Flat Cut Veneer</i>	
BKD Backdrop	GRV Greek Villa	
BFX Black Fox	NET Network Gray	
BWH Bright White	NWH Nonchalant White	
CGP Cargo Pants	STM Storm	
CHT Chatroom	TRC Tricorn Black	
FRR French Roast		

Protective Top Coat

DuraTex™ offers exceptional hardness along with abrasion and impact resistance, it has been formulated to eliminate hazardous and harmful gases that are normally associated with wood finish.

DuraTex™ Features

Safety - Significantly reduces hazardous formaldehyde emissions which help improve the quality of the indoor air we breathe. **Quality** - Developed to be tough and durable with special attention to appearance. The DuraTex™ finish preserves the natural beauty of wood. **Durability** - Designed to meet a wide range of demanding performance and environmental standards to withstand even the highest wear and tear.

Custom/Special Finishes

JSI, upon request, will accommodate special finishes. A written request is required to proceed with custom finish orders. A sample reference is required for first time matches and must be included with the written request.

There is a one time charge of **\$372 list per order** for any non-standard wood finish.

Orders will be entered noting the special finish. A sample match will be provided to the customer. Written approval is needed before the finish process can be started. Delays in approval may have an impact on lead times.

Every effort will be made to create the requested match; however, an acceptable match may not be possible because of natural variations of wood. These natural variations can also cause minor differences in the final finish product.

Product Modification

Laminate Tops

Worksurface only, no additional upcharge if coordinating wood grain laminate is specified. Contact Customer Service for any other laminate request. Listed below are finishes that have coordinating wood grain HPL laminates.

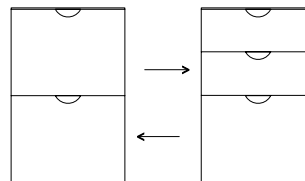
CH1 Cherry	<i>Flat Cut Veneer</i>	
CLL Collectors		
HRV Harvest		
PRL Praline		
WA1 Walnut	<i>Flat Cut Veneer</i>	
MCH Mocha	TRF Truffle	
SIE Sienna	UMB Umber	

DC1 Double Cut Veneer		
FAW Fawn	VAL Valley	
MIN Mineral - Oak Pattern		

Pedestal Configuration Change

File/File configuration is standard on the reception station.

Strata pedestal drawer configuration can be reconfigured to a Box/Box/File configuration, but must be specified at the time of order; no additional upcharge.



Wood Drawers

Four corner dovetailed wood drawers must be specified at the time of order placement. Specify and add \$276

Strata Product Information

Strata Laminate

Strata Laminate features HPL (high pressure laminate) worksurfaces and TFL (thermally fused laminate) chassis.

Edges of the worksurface are banded with impact resistant (PVC). The laminate is offered in 29 wood grain patterns and 5 solid colors. Wood grain laminates feature an embossed grain that adds texture and helps to hide finger prints and light scratches. The solid color laminates are smooth to the touch with a semi-matte finish. All Strata Laminate products are indoor-air certified by GreenGuard.

The chart below lists the laminates available on the Strata product.

TFL - HPL Wood Grain Pattern Laminates

ALL Ale Light	MIN Mineral
BOL Bourbon Light	OAT Oatmeal Cookie
BZW Brazilwood	PIN Pinnacle Walnut
BGL Brighton Light	STU Studio Teak
CLL Collectors	UMB Umber
FAW Fawn	VAL Valley
FLO Florence Walnut	VIN Vintage
GRH Graphite	WEA Weathered Ash

TFL - HPL Solid Laminates

ALB Alabaster	DWH Designer White
BLK Black	SHD Shadow
BBL Bridal Blanco	SLG Slate Grey

Worksurfaces

Worksurfaces are manufactured with 3-ply balanced construction. Tops are 1 3/16" thick with coordinating PVC edges. Worksurfaces feature 3mm PVC edges on user sides. Edge detail is flat with eased edge on top and bottom. Worksurface ends are banded with 1mm PVC.

HPL Features on Worksurfaces

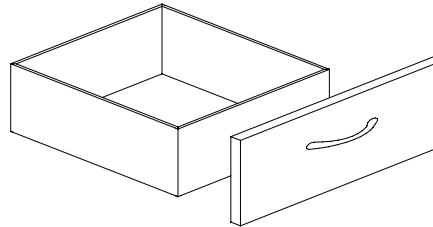
Fusion of multiple layers creates a higher impact resistant surface. Tops are 3-ply balanced construction. Available in all wood grain and solid patterns.

Case Construction

Panels for chassis consist of a 3/4" thick substrate with TFL surfaces and PVC bands on exposed edges. Pedestals and cabinets are constructed with dowels reinforced with screws, cleats and metal fasteners for increased stability. Leveling glides are set into solid hardwood blocks, which helps to prevent the leveling glide from tear out.

Drawers

The unidirectional V-Fold drawer box is a durable miter-fold drawer structure which is glued and doweled. The 1/2" thick drawer sides are wrapped in a high grade maple vinyl, with an attached front. The drawer front is attached to the four sided box.



Drawer Suspension

High quality black drawer suspension carries a lifetime warranty. File and box drawers have 100% full extension with over travel. Slides feature steel ball bearings for longer wear and positive, cushioned in/out stops.

Locking

Desk and return pedestals feature pedestal front locking to provide maximum security and flexibility in configuration.

Units are shipped randomly keyed as standard. Key alike units are available upon request for no additional charges. Removable cores for in-field re-keying are standard.

Installation

Installation assistance is available, contact Customer Service for a quote.

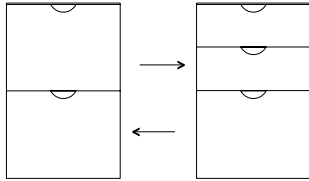
Strata Product Information

Product Modification

Pedestal Configuration Change

File/File configuration is standard on the reception station.

Strata pedestal drawer configuration can be reconfigured to a Box/Box/File configuration, but must be specified at the time of order; no additional upcharge.



Wood Drawers

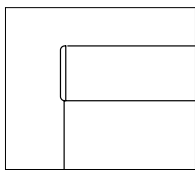
Four corner dovetailed wood drawers must be specified at the time of order placement. Specify and add \$276 list per unit.

Finish Sheen

All veneer finishes are standard in 35-sheen, with the exception of Raven. Raven is only offered in 15 sheen. All other finishes can have their sheen modified with a 15% upcharge added to the list price of each item.

Strata Product Information

Edge Detail

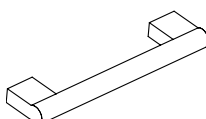


Eased (R3)

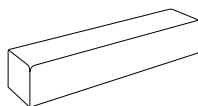
Pull Style and Color Options



Arch
Matte Black (MBK)
Matte Silver (MSL)



Bar
Matte Black (MBK)
Polished Nickel (PNK)



Block
Matte Nickel (MNK)



Bow
Matte Nickel (MNK)



Curve
Matte Nickel (MNK)



Sweep
Matte Black (MBK)
Matte Nickel (MNK)

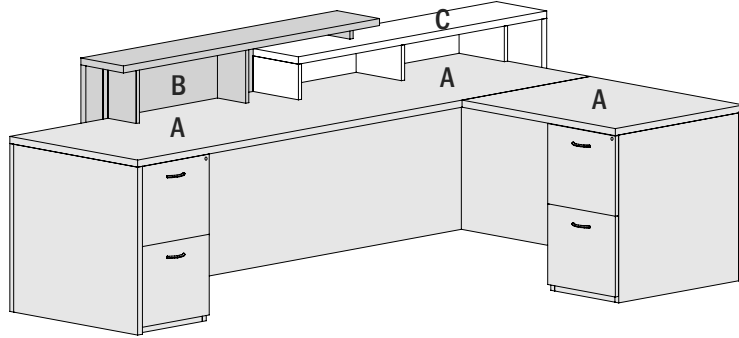


Twist
Matte Nickel (MNK)

Strata Product Information

Product Features and Material Options

Flat Cut

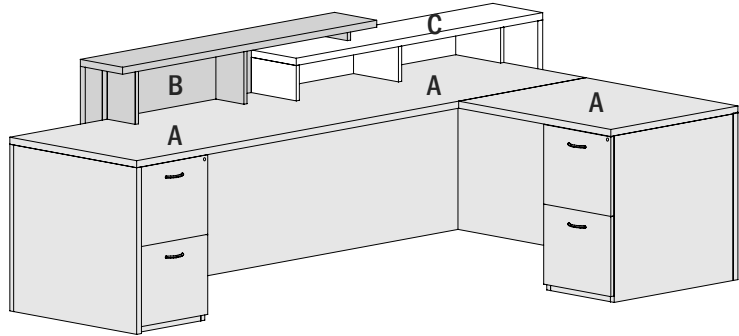


- A Desk/Return**
Flat Cut Veneer
- B Upper Transaction**
Flat Cut Veneer or Paint
- C Lower Transaction**
Flat Cut Veneer or Paint

upper and lower transaction units can be different than the desk/return

upper transaction unit can be different than the lower transaction unit

Double Cut

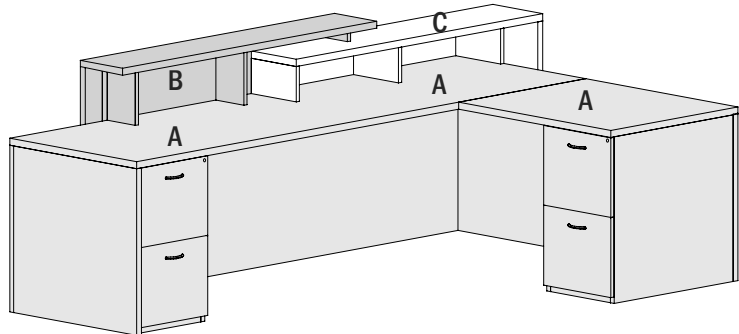


- A Desk/Return**
Double Cut Veneer
- B Upper Transaction**
Double Cut Veneer or Paint
- C Lower Transaction**
Double Cut Veneer or Paint

upper and lower transaction units can be different than the desk/return

upper transaction unit can be different than the lower transaction unit

Laminate



- A Desk/Return**
Laminate
- B Upper Transaction**
Laminate
- C Lower Transaction**
Laminate

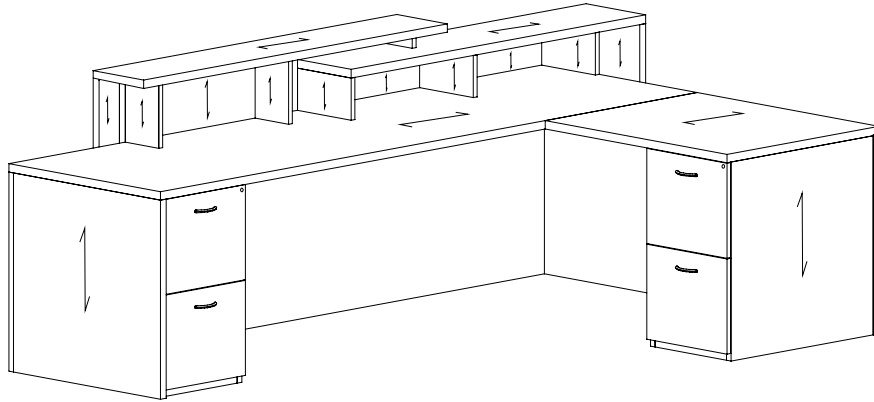
upper and lower transaction units can be different than the desk/return

upper transaction unit can be different than the lower transaction unit

Strata Product Information

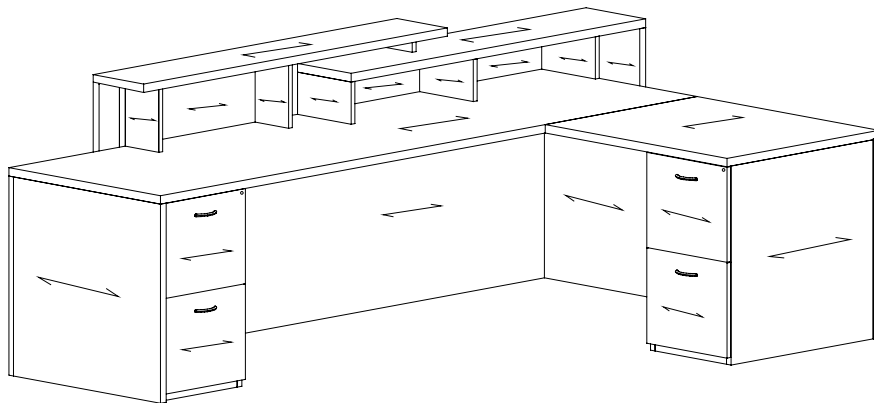
Flat Cut Veneer Grain Direction

Grain Direction on the worksurface will be long grain. Grain direction on the return worksurface will be short grain.
 Grain will run vertical on the chassis of the flat grain veneer units. Grain direction for upper and lower transaction units will run same direction as the desk.



Double Cut Veneer Grain Direction

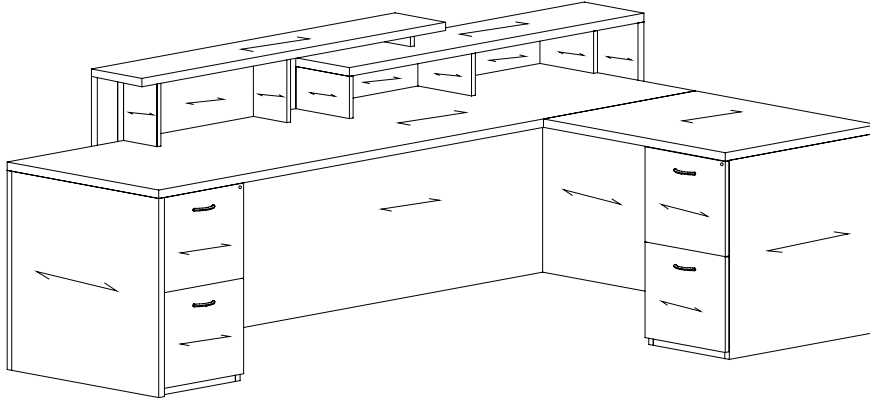
Grain Direction on the worksurface will be long grain. Grain direction on the return worksurface will be short grain.
 Grain will run horizontal on the chassis of the double cut veneer units. Grain direction for upper and lower transaction units will run same direction as the desk.



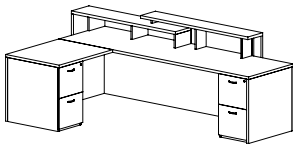
Strata Product Information

Laminate Direction

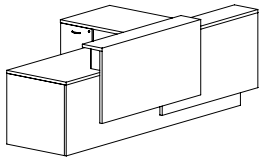
Grain Direction on the worksurface will be long grain. Grain direction on the return worksurface will be short grain on any unit 60" wide or less. Grain will run horizontal on the chassis of the laminate units. Grain direction for upper and lower transaction units will run same direction as the desk.



Description	D	W	H	CTN WT	CU FT	① Model	Veneer List Price	Laminate List Price
Right Single Pedestal Desk with Left Return	67	115	30	618	116	SRV30106RSR	\$47,009	
	67	115	30	618	116	SRT30106RSR		\$37,583



- desk top edge profile user and approach sides
- return top edge profile on user side
- letter width pedestals
- pedestal front locking
- white back painted glass top (40 3/16" x 11 13/16") available for lower transaction shelf; specify and add \$517 list



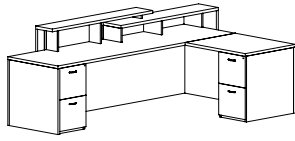
- dimensions:
- desk - 29 7/8" deep
- return - 30" deep x 36" wide
- 5 7/8" vertical clearance of lower transaction unit
- 9" vertical clearance of upper transaction unit
- ships in 4 cartons

To Order, Specify:

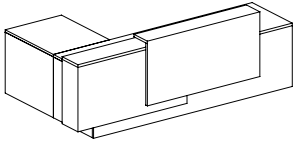
- ① Model Number
- ② Desk & Return Wood Species - Cherry (CH1), Maple (MA1), Walnut (WA1), Black Oak (BO1) or Double Cut (DC1) (see page [SR3](#))
- ③ Finish (see page [SR3](#))
- ④ Lower Transaction Wood Species
 - a. Same as Desk & Return
 - b. Cherry (CH1), Maple (MA1), Walnut (WA1), Black Oak (BO1), Double Cut (DC1) or Paint (PNT)
 1. Finish or Paint Color (see page [SR3](#))
- ⑤ Upper Transaction Wood Species
 - a. Same as Desk & Return
 - b. Same as Lower Transaction
 - c. Cherry (CH1), Maple (MA1), Walnut (WA1), Black Oak (BO1), Double Cut (DC1) or Paint (PNT)
 1. Finish or Paint Color (see page [SR3](#))
- ⑥ Pull Option & Color (see page [SR6](#))
- ⑦ Product Modifications (see page [SR3](#))

Note: Reception station must be specified in all flat cut veneer or all double cut veneer. Cannot mix the two veneer types.

Description	D	W	H	CTN WT	CU FT	① Model	Veneer List Price	Laminate List Price
Left Single Pedestal Desk with Right Return	67	115	30	618	116	SRV30106RSL	\$47,009	
	67	115	30	618	116	SRT30106RSL		\$37,583



- desk top edge profile user and approach sides
- return top edge profile on user side
- letter width pedestals
- pedestal front locking
- white back painted glass top (40 3/16" x 11 13/16") available for lower transaction shelf; specify and add \$517 list
- dimensions:
- desk - 29 7/8" deep
- return - 30" deep x 36" wide
- 5 7/8" vertical clearance of lower transaction unit
- 9" vertical clearance of upper transaction unit
- ships in 4 cartons



To Order, Specify:

- ① Model Number
- ② Desk & Return Wood Species - Cherry (CH1), Maple (MA1), Walnut (WA1), Black Oak (BO1) or Double Cut (DC1) (see page [SR3](#))
- ③ Finish (see page [SR3](#))
- ④ Lower Transaction Wood Species
 - a. Same as Desk & Return
 - b. Cherry (CH1), Maple (MA1), Walnut (WA1), Black Oak (BO1), Double Cut (DC1) or Paint (PNT)
 1. Finish or Paint Color (see page [SR3](#))
- ⑤ Upper Transaction Wood Species
 - a. Same as Desk & Return
 - b. Same as Lower Transaction
 - c. Cherry (CH1), Maple (MA1), Walnut (WA1), Black Oak (BO1), Double Cut (DC1) or Paint (PNT)
 1. Finish or Paint Color (see page [SR3](#))
- ⑥ Pull Option & Color (see page [SR6](#))
- ⑦ Product Modifications (see page [SR3](#))

Note: Reception station must be specified in all flat cut veneer or all double cut veneer. Cannot mix the two veneer types.

Traditional Occasional Tables Order Check List:



Specify:

- 1. Model Number
- 2. Wood Species - Cherry (CH1) or Walnut (WA1)
- 3. Wood Finish
- 4. Product Options

Example:

ST8028 | **CH1** | **CLL**
 (model #) | (wood species) | (finish)

1. Model Number

2. Wood Species - Cherry (CH1) or Walnut (WA1)

3. Wood Finish Options:

- | | | |
|---------------------|------------------------|--|
| CH1 Cherry | <i>Flat Cut Veneer</i> | |
| BBM Bourbon Medium | CLL Collectors | |
| BRM Brighton Medium | HRV Harvest | |
| CLA Classic | PRL Praline | |
| WA1 Walnut | <i>Flat Cut Veneer</i> | |
| ESP Espresso | TRF Truffle | |
| MCH Mocha | UMB Umber | |
| SIE Sienna | | |

4. Product Options:

Work surface only, no additional upcharge if coordinating wood grain laminate with finished wood edges is specified. Contact Customer Service for any other laminate request. Listed below are finishes that have coordinating wood grain HPL laminates.

- | | | |
|-------------------|------------------------|--|
| CH1 Cherry | <i>Flat Cut Veneer</i> | |
| CLL Collectors | | |
| HRV Harvest | | |
| PRL Praline | | |
| WA1 Walnut | <i>Flat Cut Veneer</i> | |
| MCH Mocha | TRF Truffle | |
| SIE Sienna | UMB Umber | |

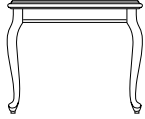
NOTE: Any specials or modifications must be accompanied by quote and approved drawing.

Description	D	W	H	CTN WT	CU FT	① Model	List Price
Rectangular Coffee Table	20	48	16	65	12	COFTQS8048	\$2,053



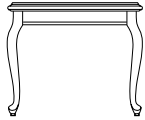
- compliment Walden and Wellington series

Square End Table	28	28	23	35	13	STQS8028	\$1,749
------------------	----	----	----	----	----	----------	---------



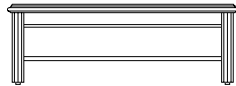
- compliment Walden and Wellington series

Rectangular End Table	18	28	23	25	9	ETQS8028	\$1,593
-----------------------	----	----	----	----	---	----------	---------



- compliment Walden and Wellington series

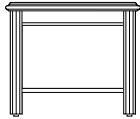
Rectangular Coffee Table	20	48	16	65	12	COFT8048	\$1,876
--------------------------	----	----	----	----	----	----------	---------



shown with
optional shelf

- compliment Walden and Wellington series
- optional shelf available, specify and add \$308 list

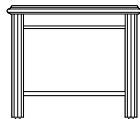
Square End Table	28	28	23	35	13	ST8028	\$1,595
------------------	----	----	----	----	----	--------	---------



shown with
optional shelf

- compliment Walden and Wellington series
- optional shelf available, specify and add \$284 list

Rectangular End Table	18	28	23	25	9	ET8028	\$1,497
-----------------------	----	----	----	----	---	--------	---------



shown with
optional shelf

- compliment Walden and Wellington series
- optional shelf available, specify and add \$230 list

To Order, Specify:

- ① Model Number
- ② Wood Species - Cherry (CH1) or Walnut (WA1)
- ③ Wood Finish See [Wood Finish Options](#)
- ④ Product Options

Specifications

- Wood species - Cherry or Walnut.
- Top is 1 1/4" thick.
- Veneer is reverse slip-matched.
- Shipped KD.

Trail Occasional Tables Order Check List:



Specify:

- 1. Model Number**
- 2. Top Material**
 - a.) **Laminate**
 - 1.) **Laminate Color - See list below**
 - a.) **Veneer**
 - 1.) **Wood Species - Cherry (CH1), Maple (MA1), Walnut (WA1) or Double Cut (DC1)**
 - 2.) **Wood Finish - See list below**
 - c.) **Solid Surface**
 - 1.) **Solid Surface Color - Armadillo (ARM), Black Pearl (BLP), Pebble Pearl (PEB) or Pure White (PUR)**
- 3. Metal Frame Color - Arctic Silver (ASL), Bright White (BWH), Matte Black (MBK), Pewter (PEW), or Soft Nickel (SNK)**

Example:

TNV18-18RD (model #)	WA1 (veneer species)	MCH (wood finish)	BWH (metal frame)
--------------------------------	--------------------------------	-----------------------------	-----------------------------

1. Model Number

2. Top Material Selection:

Veneer

CH1 Cherry <i>Flat Cut Veneer</i>	
BBM Bourbon Medium	CLL Collectors
BRM Brighton Medium	HRV Harvest
CLA Classic	PRL Praline
MA1 Maple <i>Flat Cut Veneer</i>	
ALM Ale Medium	FLX Flax
BUT Butterscotch	VEN Venetian
WA1 Walnut <i>Flat Cut Veneer</i>	
ESP Espresso	TRF Truffle
MCH Mocha	UMB Umber
SIE Sienna	

B01 Black Oak <i>Flat Cut Veneer</i>	
RAV Raven	

DC1 Double Cut Veneer

BAR Barrel - Oak Pattern	KHK Khaki
BUF Buff - Oak Pattern	MIN Mineral - Oak Pattern
CND Cinder - Oak Pattern	RYE Rye - Oak Pattern
COF Coffee	SAB Sable - Oak Pattern
EGR Egret - Oak Pattern	SAD Saddle - Oak Pattern
FAW Fawn	STU Studio Teak
GRH Graphite	VAL Valley

2. Top Material Selection: (continued):

Laminate

TFL - HPL Wood Grain Pattern Laminates

ALL Ale Light	MIN Mineral
BOL Bourbon Light	OAT Oatmeal Cookie
BZW Brazilwood	PIN Pinnacle Walnut
BGL Brighton Light	STU Studio Teak
CLL Collectors	UMB Umber
FAW Fawn	VAL Valley
FLO Florence Walnut	VIN Vintage
GRH Graphite	WEA Weathered Ash

TFL - HPL Solid Laminates

ALB Alabaster	DWH Designer White
BLK Black	SHD Shadow
BBL Bridal Blanco	SLG Slate Grey

Solid Surfaces

ARM Armadillo	PEB Pebble Pearl
BLP Black Pearl	PUR Pure White

3. Metal Frame Color:

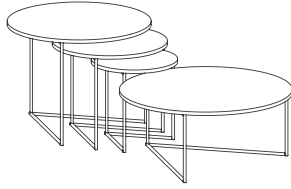
Metal

ABZ Aged Bronze	MBK Matte Black
ASL Arctic Silver	PEW Pewter
BWH Bright White	SBZ Soft Bronze
GLD Gold	SNK Soft Nickel

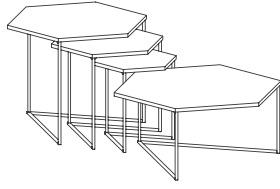
TRAIL

Trail Product Information

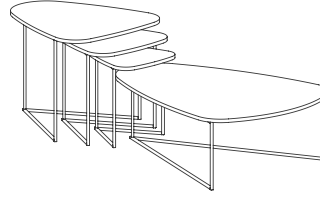
Product Overview



Round Nesting Occasional Tables

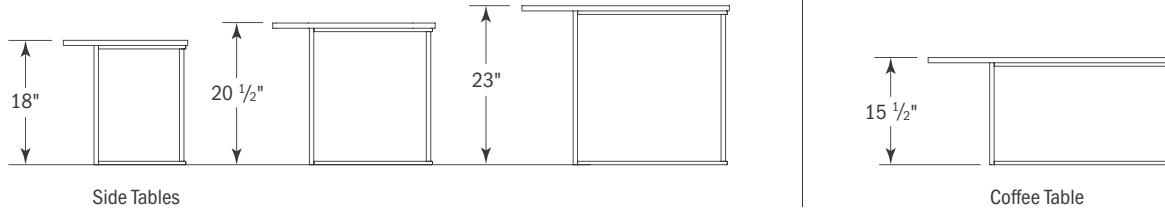


Hexagon Nesting Occasional Tables



Guitar Pick Nesting Occasional Tables

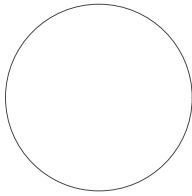
Table Heights



Side Tables

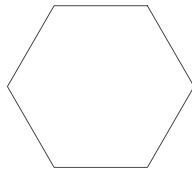
Coffee Table

Table Shapes



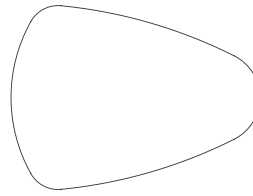
round

sizes available:
 18" dia. - side table
 24" dia. - side table
 30" dia. - side table
 36" dia. - coffee table



hexagon

sizes available:
 15 3/8" x 18" - side table
 20 3/4" x 24" - side table
 26" x 30" - side table
 31 1/4" x 36" - coffee table



guitar pick

sizes available:
 16 1/4" x 18" - side table
 21 1/8" x 23 3/8" - side table
 27 1/2" x 30 1/2" - side table
 35 1/2" x 48" - coffee table

Metal Frame Construction



Top Options

Veneer: 3/4" thick with .5mm veneer edge
 Laminate: 3/4" thick with 1mm PVC edge
 Solid Surface: 1/2" thick with 1/16" radius

Frame

Frame constructed of 1/2" square, 16 gage fabricated steel tube. It is powdercoated with your choice of the following colors (see previous page). Additional JSI powdercoat program colors available, upon request, Contact Customer Service for specific quote.


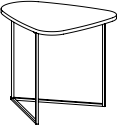

Trail



Description	D	W	H	CTN WT	CU FT	① Model	Laminate	Flat Cut Veneer	Double Cut Veneer	Solid Surface	
	30	30	23	24	15	TNT30-23RD	\$1,517				
	30	30	23	24	15	TNV30-23RD		\$1,517	\$1,594		
	30	30	23	24	15	TNS30-23RD				\$2,205	
	24	24	20½	17	9	TNT24-21RD	\$1,455				
	24	24	20½	17	9	TNV24-21RD		\$1,455	\$1,529		
	24	24	20½	17	9	TNS24-21RD				\$1,886	
	18	18	18	12	5	TNT18-18RD	\$1,402				
	18	18	18	12	5	TNV18-18RD		\$1,402	\$1,472		
	18	18	18	12	5	TNS18-18RD				\$1,632	
	· ships assembled										

Description	D	W	H	CTN WT	CU FT	① Model	Laminate	Flat Cut Veneer	Double Cut Veneer	Solid Surface	
	26	30	23	24	15	TNT2630-23HX	\$1,489				
	26	30	23	24	15	TNV2630-23HX		\$1,489	\$1,563		
	26	30	23	24	15	TNS2630-23HX				\$2,041	
	20¾	24	20½	17	9	TNT2124-21HX	\$1,433				
	20¾	24	20½	17	9	TNV2124-21HX		\$1,433	\$1,506		
	20¾	24	20½	17	9	TNS2124-21HX				\$1,772	
	15⅝	18	18	12	5	TNT1618-18HX	\$1,388				
	15⅝	18	18	12	5	TNV1618-18HX		\$1,388	\$1,458		
	15⅝	18	18	12	5	TNS1618-18HX				\$1,560	
	· ships assembled										

TRAIL

Description	D	W	H	CTN WT	CU FT	① Model	Laminate	Flat Cut Veneer	Double Cut Veneer	Solid Surface	
  	27 1/2	30 1/2	23	24	15	TNT2831-23PK	\$1,511				
	27 1/2	30 1/2	23	24	15	TNV2831-23PK		\$1,511	\$1,586		
	27 1/2	30 1/2	23	24	15	TNS2831-23PK				\$2,147	
	21 1/8	23 3/8	20 1/2	17	9	TNT2124-21PK	\$1,442				
	21 1/8	23 3/8	20 1/2	17	9	TNV2124-21PK		\$1,442	\$1,512		
	21 1/8	23 3/8	20 1/2	17	9	TNS2124-21PK				\$1,822	
	16 1/4	18	18	12	5	TNT1618-18PK	\$1,397				
	16 1/4	18	18	12	5	TNV1618-18PK		\$1,397	\$1,467		
	16 1/4	18	18	12	5	TNS1618-18PK				\$1,601	
	· ships assembled										

To Order, Specify:

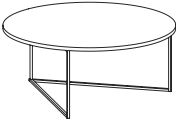
- ① Model Number
- ② Top Material:
 - a.) Laminate [See Laminate Top Options](#)
 - 1.) Laminate Color
 - b.) Veneer
 - 1.) Wood Species - Cherry (CH1), Maple (MA1), Walnut (WA1), Black Oak (BO1) or Double Cut (DC1)
 - a.) Finish Color [See Veneer Top Options](#)
 - c.) Solid Surface - [See Solid Surface Top Options](#)
- ③ Metal Frame Color [See Metal Frame Color Options](#)

Specifications
Tops:

- 3/4" thick veneer top with .5mm veneer edge
- 3/4" thick laminate top with 1mm pvc edge
- 1/2" solid surface top with 1/16" radius

Frame:

- Frame constructed of 1/2" square, 16 gauge fabricated steel tube

Description	D	W	H	CTN WT	CU FT	① Model	Laminate	Flat Cut Veneer	Double Cut Veneer	Solid Surface
	36	36	15½	31	16	TNT36-16RD	\$1,619			
	36	36	15½	31	16	TNV36-16RD		\$1,619	\$1,700	
	36	36	15½	31	16	TNS36-16RD				\$3,095

· ships assembled

	31¾	36	15½	31	16	TNT3236-16HX	\$1,583			
	31¾	36	15½	31	16	TNV3236-16HX		\$1,583	\$1,663	
	31¾	36	15½	31	16	TNS3236-16HX				\$2,887

· ships assembled

	35½	48	15½	38	21	TNT3648-16PK	\$1,698			
	35½	48	15½	38	21	TNV3648-16PK		\$1,698	\$1,782	
	35½	48	15½	38	21	TNS3648-16PK				\$3,646

· ships assembled

TRAIL

To Order, Specify:

- ① Model Number
- ② Top Material:
 - a.) Laminate [See Laminate Top Options](#)
 - 1.) Laminate Color
 - b.) Veneer
 - 1.) Wood Species - Cherry (CH1), Maple (MA1), Walnut (WA1), Black Oak (BO1) or Double Cut (DC1)
 - a.) Finish Color [See Veneer Top Options](#)
 - c.) Solid Surface - [See Solid Surface Top Options](#)
- ③ Metal Frame Color [See Metal Frame Color Options](#)

Specifications

- Tops:**
- ¾" thick veneer top with .5mm veneer edge
 - ¾" thick laminate top with 1mm pvc edge
 - ½" solid surface top with 1/16" radius
- Frame:**
- Frame constructed of ½" square, 16 gauge fabricated steel tube



WALDEN

Desks	WN16
Reception Galleries	WN19
Returns	WN22
Bridges	WN24
Credenzas	WN26
Overhead Storage Cabinets	WN30
Wall Mount Overhead Cabinets	WN36
Modular Components	WN39
Storage Towers	WN41
Bookcases	WN44
Storage Cabinets	WN46
Lateral Files	WN49
Modular Components	WN52
Center Drawers	WN61

Walden - Overview

Desks



Double Pedestal Desk
Page [WN16](#)



Double Pedestal Desk
Page [WN17](#)



Single Pedestal Desk
Page [WN18](#)



Single Pedestal Desk
Page [WN18](#)



Run-Off Desk with Pedestal Support
Page [WN20](#)



Run-Off Desk with Leg Support
Page [WN20](#)

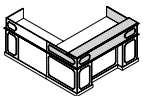


Table Desk
Page [WN21](#)

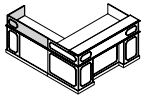


Table Desk
Page [WN21](#)

Reception Galleries



Desk Reception Gallery
Page [WN19](#)



Return Reception Gallery
Page [WN19](#)

Returns



22" d Return
Page [WN22](#)



25" d Return
Page [WN22](#)



22" d Return with Corner Unit
Page [WN23](#)

22" d Bridges



22" d Bridge Top with Modesty Panel
Page [WN24](#)



22" d Bridge Top
Page [WN24](#)



22" d Bridge Top with Modesty Panel used with Corner Unit
Page [WN24](#)



22" d Bridge Top used with Corner Unit
Page [WN24](#)

25" d Bridges



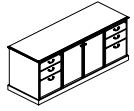
25" d Bridge Top with Modesty Panel
Page [WN25](#)



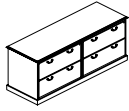
25" d Bridge Top
Page [WN25](#)

Walden - Overview

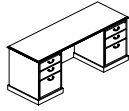
Credenzas



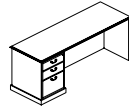
Storage Credenza
Page [WN26](#)



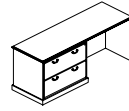
Lateral File Credenza
Page [WN26](#)



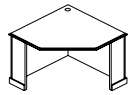
Kneespace Credenza
Page [WN26](#)



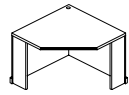
Box/Box/File Open
Corner Credenza
Page [WN27](#)



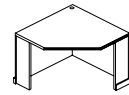
Lateral File Open
Corner Credenza
Page [WN27](#)



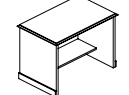
Freestanding
Corner Unit
Page [WN28](#)



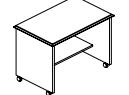
Corner Unit
Page [WN28](#)



Corner Unit
Page [WN28](#)

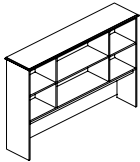


Computer/Printer
Stand
Page [WN29](#)

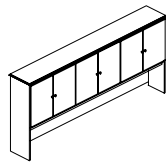


Mobile Computer/Printer
Stand
Page [WN29](#)

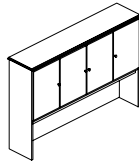
Double Height Overhead Storage Cabinets



Double Height Open
Storage Cabinet
Page [WN30](#)

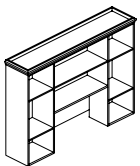


Double Height Storage
Overhead with 6 Doors
Page [WN32](#)

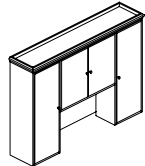


Double Height Storage
Overhead with 4 Doors
Page [WN34](#)

Overhead Storage Cabinets with Tower

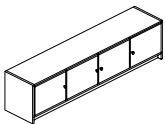


Open Overhead
Storage with Tower
Page [WN35](#)

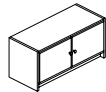


Overhead Storage with
Tower
Page [WN35](#)

Wall Mount Overheads



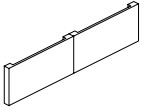
Wall Mount Overhead
with 4 Doors
Page [WN36](#)



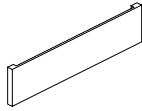
Wall Mount Overhead
with 2 Doors
Page [WN36](#)

Walden - Overview

Wall Mount Tackboards



Wall Mount Tackboard
Page [WN37](#)



Wall Mount Tackboard
Page [WN38](#)

Modular Components



Modular Storage Top
Page [WN39](#)



Modular Storage Base
Page [WN39](#)

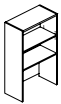


Modular Overhead Cornice Top
Page [WN40](#)

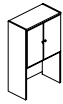


Cornice Top Filler Panel
Page [WN40](#)

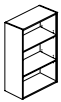
Storage Towers



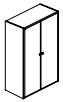
Open Bookcase
Storage Tower
Page [WN41](#)



Storage Tower
with Doors
Page [WN41](#)



Open Storage Tower
Page [WN42](#)

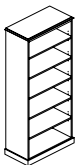


Storage Tower
with Doors
Page [WN42](#)



Storage Tower
with Door
Page [WN43](#)

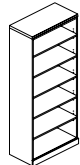
Bookcases



79" h Bookcase
Page [WN44](#)



29" h Bookcase
Page [WN44](#)

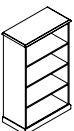


Bookcase
Page [WN45](#)

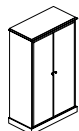


Heavy Duty Shelf
Page [WN45](#)

Storage Cabinets



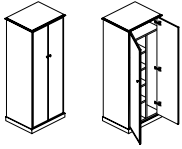
Open Storage
Cabinet
Page [WN46](#)



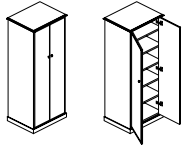
Storage Cabinet with
Doors
Page [WN46](#)

Walden - Overview

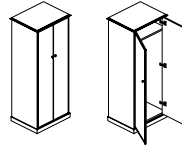
Storage/Wardrobe Cabinets



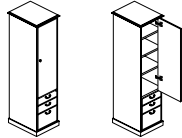
Storage Wardrobe Cabinet
Page [WN47](#)



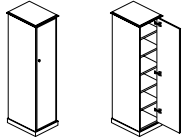
Storage Cabinet
Page [WN47](#)



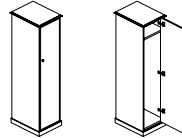
Wardrobe Cabinet
Page [WN47](#)



Storage Cabinet -
Box/Box/File
Page [WN48](#)

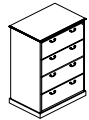


Storage Cabinet
Page [WN48](#)



Wardrobe Cabinet
Page [WN48](#)

Lateral Files



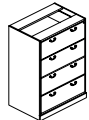
Four Drawer Lateral File
Page [WN49](#)



Three Drawer Lateral File
Page [WN49](#)



Two Drawer Lateral File
Page [WN49](#)



Four Drawer Lateral File
without Top
Page [WN51](#)



Three Drawer Lateral File
without Top
Page [WN51](#)



Two Drawer Lateral File
without Top
Page [WN51](#)

Mobile Pedestal



Mobile Box/File Pedestal
Page [WN50](#)

Walden - Overview

Modular Components



Open Pedestal
Page [WN52](#)



Hinged Door Pedestal
Page [WN52](#)



Box/Box/File Pedestal
Page [WN52](#)



File/File Pedestal
Page [WN52](#)



Box/Box/File Pedestal
Page [WN53](#)



File/File Pedestal
Page [WN53](#)



Open Pedestal without Top
Page [WN54](#)



Hinged Door Pedestal without Top
Page [WN54](#)



Box/Box/File Pedestal without Top
Page [WN54](#)



File/File Pedestal without Top
Page [WN54](#)



Box/Box/File Pedestal without Top
Page [WN55](#)



File/File Pedestal without Top
Page [WN55](#)



Open Pedestal without Top and Base
Page [WN56](#)



Hinged Door Pedestal without Top and Base
Page [WN56](#)



Box/Box/File Pedestal without Top and Base
Page [WN56](#)



File/File Pedestal without Top and Base
Page [WN56](#)



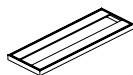
Box/Box/File Pedestal without Top and Base
Page [WN57](#)



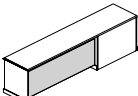
File/File Pedestal without Top and Base
Page [WN57](#)



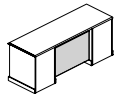
Modular Top
Page [WN58](#)



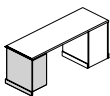
Modular Base
Page [WN58](#)



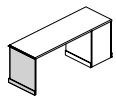
Modesty Panel
Page [WN59](#)



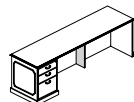
Modesty Panel
Page [WN59](#)



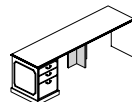
End L-Support Panel
Page [WN60](#)



End Panel
Page [WN60](#)



Center Support Panel
Page [WN60](#)



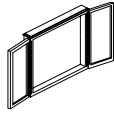
Center T-Support Panel
Page [WN60](#)

Walden - Overview

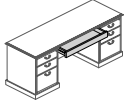
Accessories



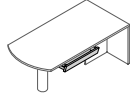
Costumer
Page [WN61](#)



Visual Board
Page [WN61](#)



Straight Front
Center Drawer
Page [WN61](#)

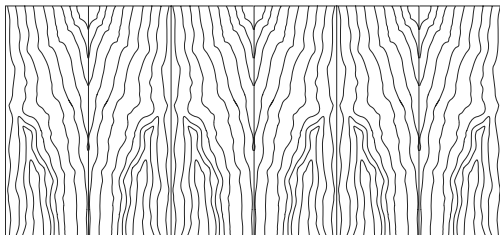


Angled Front
Center Drawer
Page [WN61](#)

Walden Product Information

Exterior Wood Materials

Exterior surfaces are made from the finest selected veneers to achieve clarity and consistency in the Walden product line. To attain a pleasing, symmetrical pattern, all veneers in Walden are book-matched. All exterior solid lumber is matched to coordinate with the veneer.



Alternating pieces of veneer are flipped over so they face each other like the pages within a book.

Walden is available in flat cut cherry and walnut veneer. A wide range of wood stains have been formulated to enhance the beauty of the veneer.

Work Surface Construction

Tops are 3-ply balanced construction, 1 3/8" thick with solid matching hardwood edges.

Coordinating high pressure laminate in a veneer grain pattern can be applied to the top surface and is available at no additional charge.

Case Construction

All construction is a combination of mortise and tenon with bore and dowel.

All panels are 3/4" thick with 3-ply construction and rimmed with veneer bands.

Arm slides are 3-ply construction, banded on all four sides with veneer. Pedestals are enclosed at the bottom with a 1/8" thick panel securely fastened to the bottom of the pedestal.

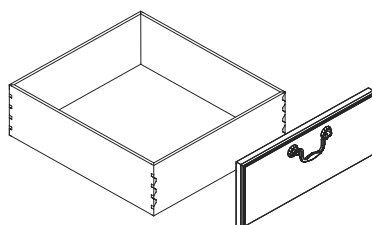
Each corner of the pedestal has a metal reinforcement bracket with a 2 1/2" adjustable glides. All glides can be adjusted from inside the pedestal by removing the bottom drawer.

Drawer Construction

The standard Baltic Birch drawer is constructed with 1/2" thick high quality Baltic Birch plywood with a durable finish. This five sided drawer box features fully glued dovetail construction ensuring a solid, warp resistant drawer box.

Veneered bottoms are framed into grooves on four sides. Bottoms are then glued, stapled, and reinforced with a continuous band of glue.

The optional V-fold drawer interior is a 1/2" durable, miter-fold drawer system. The V-fold vinyl wrapped drawer sides form a mitered box. The box is glued and doweled, the drawer fronts attached to the box.



WN8 Walden

Drawer Suspension

The high quality black drawer suspensions carry a lifetime warranty. Slides feature steel ball bearings for longer life with cushioned in/out stops. All drawers, including file and box drawers, fully extend past the pedestal chassis allowing full access to the drawer box.

Filing Hardware

All file drawers are constructed with a custom designed filing system in place to allow for hanging folders. Filing diagram on pages [WN12-WN13](#).

Locking

All desk, credenzas and freestanding pedestals with drawers are face locked. Locks are located in the upper right corner of top drawer. Door locks are available as an option.

Units are shipped randomly keyed as standard. Key alike units are available upon request for no additional charges. Removable cores for in-field re-keying are standard.

Finish - Stain/Colors

We offer a variety of wood stains on Walden. Please see the chart below. Samples are available upon request.

CH1	Cherry	<i>Flat Cut Veneer</i>		
BBM	Bourbon Medium		CLL	Collectors
BRM	Brighton Medium		HRV	Harvest
CLA	Classic		PRL	Praline
WA1	Walnut	<i>Flat Cut Veneer</i>		
ESP	Espresso		TRF	Truffle
MCH	Mocha		UMB	Umber
SIE	Sienna			

Protective Top Coat

DuraTex™ offers exceptional hardness along with abrasion and impact resistance, it has been formulated to eliminate hazardous and harmful gases that are normally associated with wood finish.

DuraTex™ Features

Safety - Significantly reduces hazardous formaldehyde emissions, which help improve the quality of the indoor air we breathe.

Quality - Developed to be tough and durable with special attention to appearance. The DuraTex™ finish preserves the natural beauty of wood.

Durability - Designed to meet a wide range of demanding performance and environmental standards to withstand even the highest wear and tear.

Walden Product Information

Product Modification

Laminate Tops

Work surface only, no additional upcharge if Walden's coordinating wood grain laminate is specified. Contact Customer Service for any other laminate request. Listed below are finishes that have coordinating wood grain HPL laminates.

- CH1 Cherry** *Flat Cut Veneer*
 CLL Collectors
 HRV Harvest
 PRL Praline

- WA1 Walnut** *Flat Cut Veneer*
 MCH Mocha TRF Truffle
 SIE Sienna UMB Umber

Special Finishes

Special finishes can be requested by following the instruction in the general introduction section. There is a one time charge of \$372 list per order.

Finish Sheen

All veneer finishes, for Walden, are standard in 35-sheen. All other finishes can have their sheen modified with a 15% upcharge added to the list price of each item.

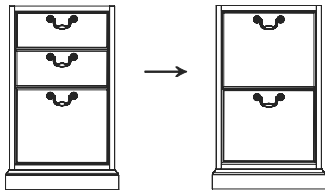
Special Veneer

Upon request standard veneer can be changed to a special veneer contact Customer Service for availability and pricing.

Pedestal Configuration Change

Pencil-box-file configuration is standard on all desks pedestals. Standard configurations for all other units are listed in the pricing section for that model.

Drawer configurations can be switched from a pencil-box-file or box-box-file to a file-file configuration on units 28 3/4" high, but must be specified at the time of order with an additional \$216 list per pedestal.



Changing from pencil-box-file to file-file pedestal will eliminate the writing shelf (arm slide).

Special Sizes from Standard Offering

The following chart contains pricing for general modifications to Walden. **All modifications still must be approved by JSI manufacturing**, please contact Customer Service to verify any of the modifications listed in the chart below. More complex modification to standard product may be possible.

This chart does not apply to glass doors, or to metal components; such as grill on doors and cornices. Any changes to file drawers will affect filing capabilities.

Increasing Dimensions - Add On to the list Per 6" Occurrence

Overhead	
Increasing width	\$1,018
Increasing depth	\$1,736
Increasing width with doors	\$1,205
Increasing depth with doors	\$1,858

Any Pedestal	
Increasing width	\$1,443
Increasing depth	\$1,288

Any Panel	
Increasing width	\$329

Any Top	
Increasing width	\$429
Increasing depth	\$604

Decreasing Dimensions Add On to the list Per 6" Occurrence

Overhead	
Decreasing width	\$257
Decreasing depth	\$257
Decreasing width with doors	\$351
Decreasing depth with doors	\$351

Any Pedestal	
Decreasing width	\$1,111
Decreasing depth	\$992

Any Panel	
Decreasing width	\$131

Any Top	
Decreasing width	\$193
Decreasing depth	\$193

Example 1

Increasing open corner credenza width by 11", from 86" to 97".
 Add Top Width (\$429 × 2) [\$429 for each 6" increment]
 Add Panel Width (\$329 × 2) [\$329 for each 6" increment]
 Total Modification = \$1,442

Example 2

Increasing a desk pedestal depth from 36" to 40" & increase the width of the same pedestal by 8"
 Add Pedestal Depth \$1,226
 Add Pedestal Width (\$1,443 × 2) [\$1,443 for each 6" increment]
 Total Modification = \$3,976

Example 3

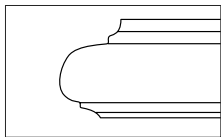
Decreasing an overhead from 62" to 58" width & increasing the depth by 3"
 Add Overhead Width \$257
 Add Overhead Depth \$1,736
 Total Modification = \$1,910

Walden Product Information

Edge and Hardware

Walden offers the traditional federal edge profile and the Walden drawer pull in antique brass or pewter finish

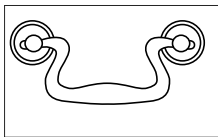
Edge Profile



Federal Edge Profile (C3)

Accepts Laminate Top

Drawer Hardware



Walden Hardware

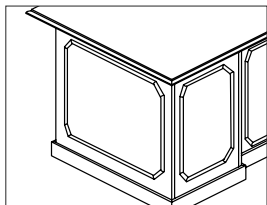
Antique Brass (ANB)

Pewter (PTR)

Picture Frame Molding

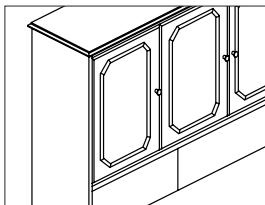
Many Walden units, including desks, credenzas, and overhead storage, can be specified with picture frame molding. Desks feature this molding on the modesty panel, the back and side of the pedestal, and the outside of the end panel. Molding on the returns are located on the side and back of the pedestal. Credenzas have molding on the side of the pedestal and end panel only. Overhead storage features molding on wood doors only.

Walden Molding (WDM)



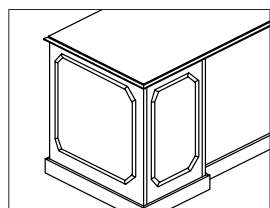
Desk (approach shown)

Pedestal Side and Back, Modesty, End Panel (Single Pedestal Desk only)



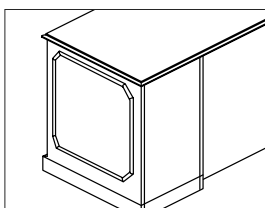
Overhead (front shown)

Wood Doors only



Return (approach shown)

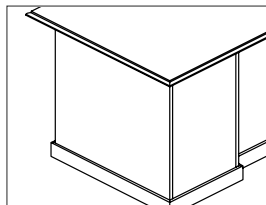
Pedestal Side and Back



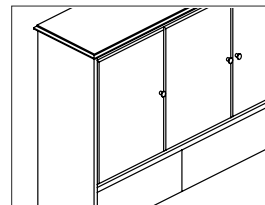
Credenza (back shown)

Pedestal End Panel

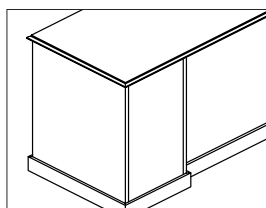
Base Molding Only (WOM)



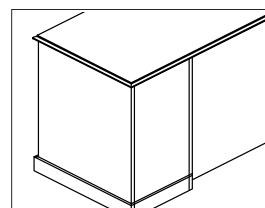
Desk (approach shown)



Overhead (front shown)



Return (approach shown)

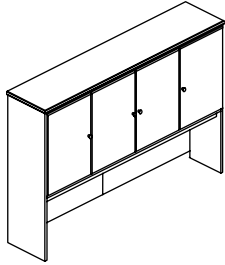


Credenza (back shown)

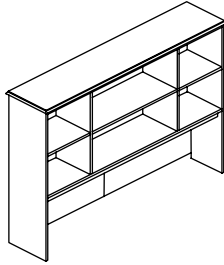
Walden Product Information

Storage Overhead Cabinet

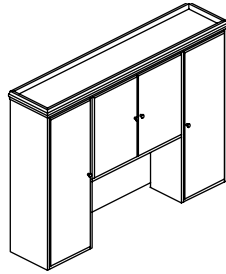
Overhead storage sizes range from 30" wide to 90" wide. Multiple variations, including wall mount overheads and open storage, are available.



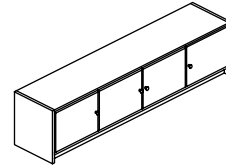
Storage Overhead Cabinet with Doors



Open Storage Overhead Cabinet



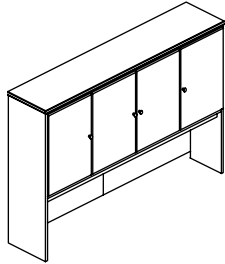
Open Storage Overhead Cabinet with Tower



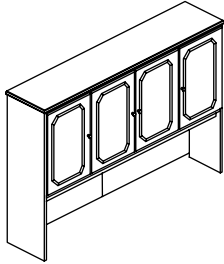
Wall Mount Overhead

Storage Overhead Cabinet Doors

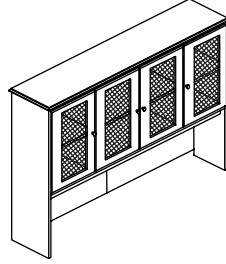
Door options for storage overhead cabinets and storage towers include wood doors (DWW) with or without picture frame molding, grill doors (DWM), and clear glass doors (not low iron) (DWC). Knobs may be either antique brass or pewter. Grill matches hardware finish selected.



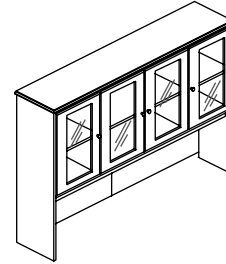
Wood Doors (DWW)
Standard



Wood Doors (DWW)
with Optional Molding



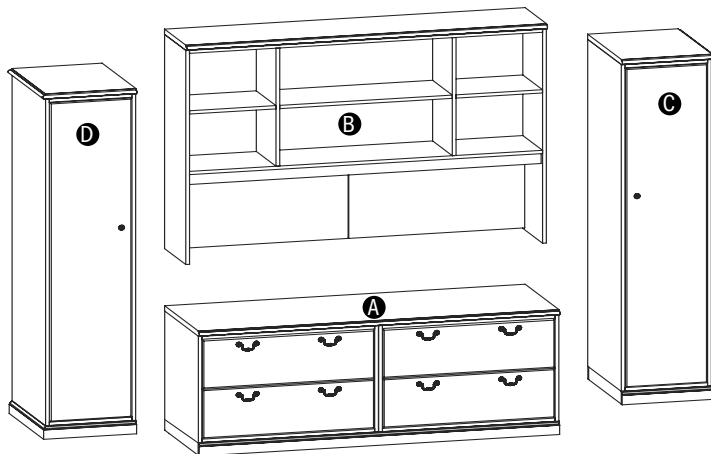
Grill Doors (DWM)



Clear Glass Doors (DWC)
(not low iron)

Flat Cut Options

Units can fit tightly together with flat cut rims that replace the top edge profile and base molding. Specify the flat cut options. (see example)



Example

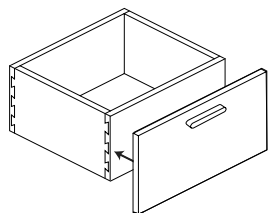
- A** WN2DST1-2574
credenza flat cut on both sides (option code FB)
- B** WN4B001-1674
overhead flat cut on both sides (option code FB)
- C** WN6ADS1R-2520
wardrobe flat cut on the left side (option code FL)
- D** WN6ADS1L-2520
wardrobe flat cut on the right side (option code FR)

Must be specified at the time of order placement.

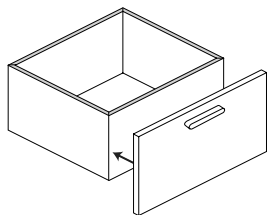
Walden Product Information

Drawer Options

Walden drawers are standard in Baltic birch and available in an optional V-fold style. Refer to the pricing pages for the V-fold deduct.



Wood Drawer (DRW)
Standard

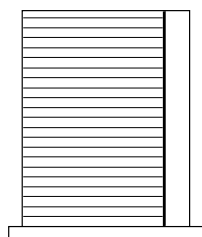


V-Fold Drawer (DRV)
Optional

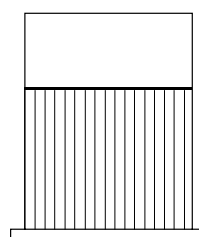
Standard Filing Option

Desk with 18" Wide Pedestals

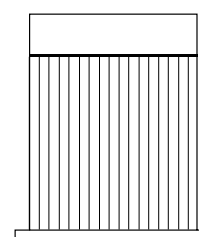
Used with Desks over 66" w
File Drawer Size: 15" w x 20" d



Letter
Front to Back



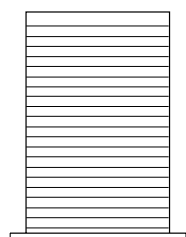
Letter
Side to Side



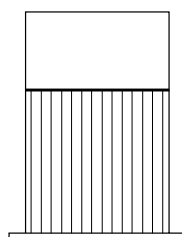
Legal
Side to Side Only

Desk with 15" Wide Pedestals

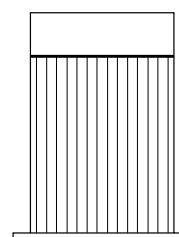
Used with Desks up to 66" w
Drawer Size: 13" w x 20" d



Letter
Front to Back



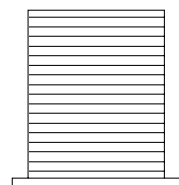
Letter
Side to Side



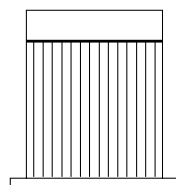
Legal
Side to Side Only

Return and Credenza with 15" Wide Pedestals

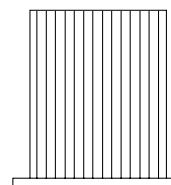
Used with Credenzas over 66" w
Drawer Size: 15" w x 16" d



Letter
Front to Back



Letter
Side to Side

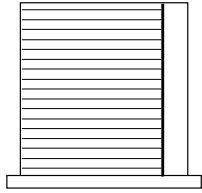


Legal
Side to Side Only

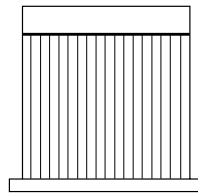
Walden Product Information

Credenza with 18" Wide Pedestals

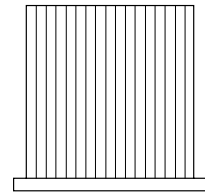
Used with Credenzas over 66" w
 Drawer Size: 15" w x 16" d



Letter
 Front to Back



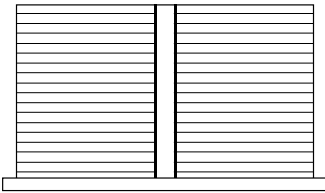
Letter
 Side to Side



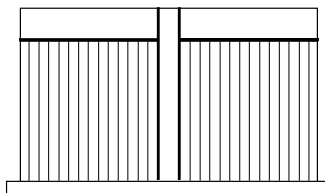
Legal
 Side to Side Only

Lateral Credenza and Lateral Pedestals

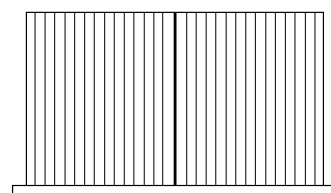
30" w Lateral File
 Drawer Size 27" w x 16" d



Letter
 Double Front to Back



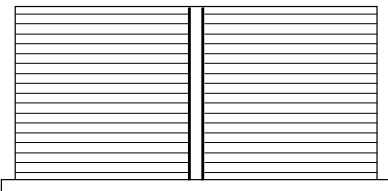
Letter
 Double Side to Side



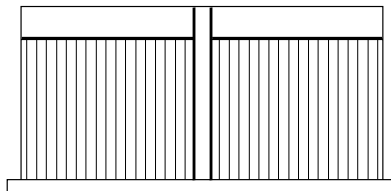
Legal
 Side to Side

Lateral Credenza and Lateral Pedestals

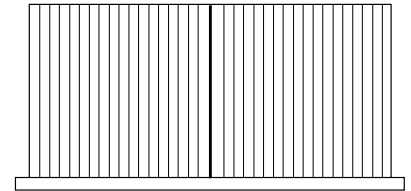
36" w Lateral File
 Drawer Size 33" w x 16" d



Letter/Legal
 Double Front to Back



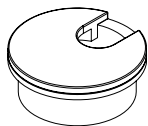
Letter
 Double Side to Side



Legal
 Side to Side

Walden Product Information

Worksurface Grommets



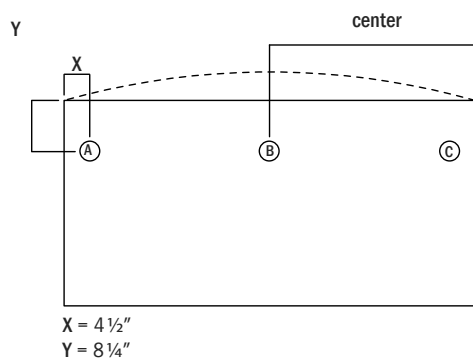
- G3A - 2"**
Antique Brass
- G3B - 2"**
Matte Black

Work Surface Grommet Locations

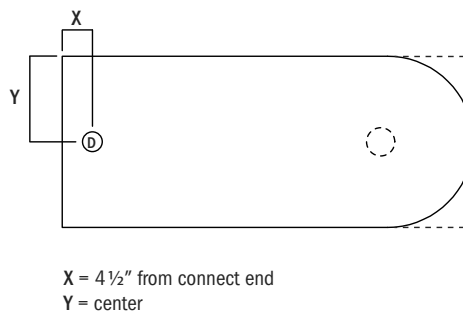
The optional grommet locations on the desk, run-off desk, bridges, credenzas and returns are predetermined on the Walden product. Grommet locations are indicated below with an (A) for left, (B) for center, (C) for right, and (D) for center end.

Add \$114 to the list for each additional grommet.

Pedestal Desk

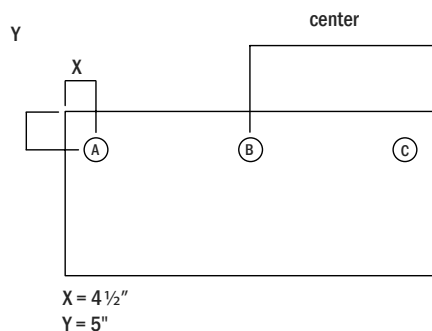


Support End and Run-Off Desk



Bridges, Returns and Credenzas

Center grommet is not available on open corner lateral credenzas and lateral returns due to the location of the pedestal.



Note: Grommet not recommended over pedestal, contact Customer Service for other locations.

Walden Product Information

Finish and Product Reference Codes

Select Veneer

Select	Code
Cherry	CH1
Walnut	WA1

Finish

Cherry Finishes

Bourbon Medium	BBM
Brighton Medium	BRM
Classic	CLA
Collectors	CLL
Harvest	HRV
Praline	PRL

Walnut Finishes

Espresso	ESP
Mocha	MCH
Mocha	MCH
Sienna	SIE
Truffle	TRF
Umber	UMB

Laminate Coordinates

Cherry Finishes

Collectors	CLL
Harvest	HRV
Praline	PRL

Walnut Finishes

Mocha	MCH
Sienna	SIE
Truffle	TRF
Umber	UMB

Select Top Edge Profile

Federal

Hardware Finish

Antique Brass	ANB
Pewter	PTR

Drawer Box

Wood	DRW
V-Fold	DRV

DOOR STYLE

Wood Door	DWW
Wire Mesh/Wood Door	DWM
Clear Glass/Wood Door	DWC

Top Grommet Finish

2" dia. Antique Brass	G3A
2" dia. Black	G3B

Top Grommet Locations

Left	A
Center	B
Right	C
Center End	D

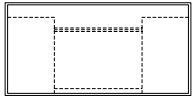
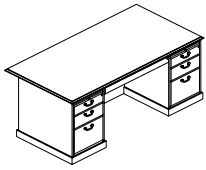
Door Locks

Locks	LCY
Without Locks	LCN

Flat Cut

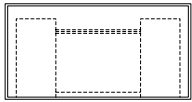
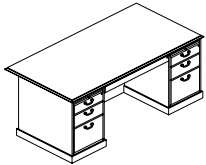
Left Flat	FEL
Right Flat	FER
Left and Right Flat	FEB
No Flat Cut	NFE

Description	D	W	H	CTN WT	CU FT	① Model	List Price
Double Pedestal Desk	43 7/8	85 5/8	28 3/4	432	72	WN1DPF1-4486	\$8,602



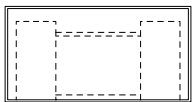
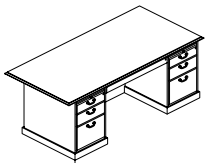
- top shaped all sides
- 18" w pencil/box/file pedestal left with arm slide
- 18" w pencil/box/file pedestal right with arm slide
- wood drawers standard, v-fold drawers available, specify and deduct \$147
- locking drawers and center drawer
- enclosed pedestal bottom
- walden molding available, specify and add \$582 list
- grommet available, specify and add \$114 list each; see page [WN14](#)
- chassis size: 84" x 36"
- kneespace width: 48"
- kneespace height: 24 1/2"
- 7 1/8" overhang on approach side

Double Pedestal Desk	43 3/8	79 5/8	28 3/4	387	66	WN1DPF1-4480	\$8,360
----------------------	--------	--------	--------	-----	----	--------------	---------



- top shaped all sides
- 18" w pencil/box/file pedestal left with arm slide
- 18" w pencil/box/file pedestal right with arm slide
- wood drawers standard, v-fold drawers available, specify and deduct \$147
- locking drawers and center drawer
- enclosed pedestal bottom
- walden molding available, specify and add \$582 list
- grommet available, specify and add \$114 list each; see page [WN14](#)
- chassis size: 72" x 36"
- kneespace width: 36"
- kneespace height: 24 1/2"
- 7 1/8" overhang on approach side
- 3 3/4" overhang on side

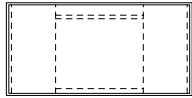
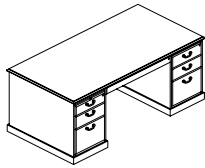
Double Pedestal Desk	37 1/2	73 5/8	28 3/4	320	53	WN1DPF1-3874	\$7,076
----------------------	--------	--------	--------	-----	----	--------------	---------



- top shaped all sides
- 15 5/8" w pencil/box/file pedestal left with arm slide
- 15 5/8" w pencil/box/file pedestal right with arm slide
- wood drawers standard, v-fold drawers available, specify and deduct \$147
- locking drawers and center drawer
- enclosed pedestal bottom
- walden molding available, specify and add \$582 list
- grommet available, specify and add \$114 list each; see page [WN14](#)
- chassis size: 66" x 29 5/8"
- kneespace width: 34 7/8"
- kneespace height: 24 1/2"
- 7 1/8" overhang on approach side
- 3 3/4" overhang on side

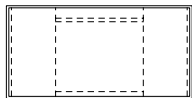
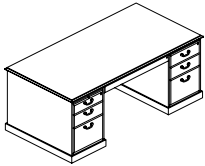
WALDEN

Description	D	W	H	CTN WT	CU FT	① Model	List Price
Double Pedestal Desk	37½	73⅝	28¾	356	53	WN1DPR1-3874	\$7,913



- top shaped all sides
- 18" w pencil/box/file pedestal left with arm slide
- 18" w pencil/box/file pedestal right with arm slide
- wood drawers standard, v-fold drawers available, specify and deduct \$147
- locking drawers and center drawer
- enclosed pedestal bottom
- walden molding available, specify and add \$582 list
- grommet available, specify and add \$114 list each; see page [WN14](#)
- chassis size: 72" x 36"
- kneespace width: 36"
- kneespace height: 24 ½"

Double Pedestal Desk	31½	67½	28¾	297	41	WN1DPR1-3168	\$6,704
----------------------	-----	-----	-----	-----	----	--------------	---------

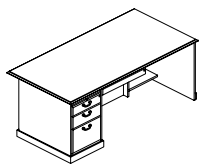


- top shaped all sides
- 15 ⅝" w pencil/box/file pedestal left with arm slide
- 15 ⅝" w pencil/box/file pedestal right with arm slide
- wood drawers standard, v-fold drawers available, specify and deduct \$147
- locking drawers and center drawer
- enclosed pedestal bottom
- walden molding available, specify and add \$582 list
- grommet available, specify and add \$114 list each; see page [WN14](#)
- chassis size: 66" x 29 ⅝"
- kneespace width: 34 ⅞"
- kneespace height: 24 ½"

To Order, Specify:

- ① Model Number
- ② Wood Species - Cherry (CH1) or Walnut (WA1)
(see page [WN15](#))
- ③ Finish Color - (see page [WN15](#))
- ④ Pull Color - (see page [WN15](#))
- ⑤ Product Modification - (see page [WN9](#))

Description	D	W	H	CTN WT	CU FT	① Model	List Price
Single Pedestal Desk	37 1/2	85 5/8	28 3/4	290	62	WN1SPF1R-3886	\$8,073
	37 1/2	85 5/8	28 3/4	290	62	WN1SPF1L-3886	\$8,073
	37 1/2	73 5/8	28 3/4	288	53	WN1SPF1R-3874	\$6,671
	37 1/2	73 5/8	28 3/4	288	53	WN1SPF1L-3874	\$6,671

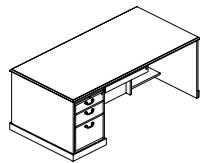


left shown



- top shaped all sides
- 18" w pencil/box/file pedestal with arm slide
- wood drawers standard, v-fold drawers available, specify and deduct \$87
- locking drawers and center drawer
- enclosed pedestal bottom
- walden molding available, specify and add \$582 list
- grommet available, specify and add \$114 list each; see page [WN14](#)
- -3886 chassis size: 84" x 29 5/8"
- -3874 chassis size: 72" x 29 5/8"
- -3886 kneespace width: 65 1/4"
- -3874 kneespace width: 53 1/4"
- kneespace height: 24 1/2"
- 7" overhang on approach side

Single Pedestal Desk	37 1/2	73 5/8	28 3/4	302	53	WN1SPR1R-3874	\$7,695
	37 1/2	73 5/8	28 3/4	302	53	WN1SPR1L-3874	\$7,695

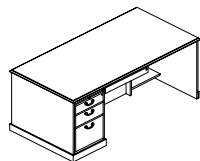


left shown

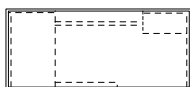


- top shaped all sides
- 18" w pencil/box/file pedestal with arm slide
- wood drawers standard, v-fold drawers available, specify and deduct \$87
- locking drawers and center drawer
- enclosed pedestal bottom
- walden molding available, specify and add \$582 list
- grommet available, specify and add \$114 list each; see page [WN14](#)
- chassis size: 72" x 36"
- kneespace width: 53 1/4"
- kneespace height: 24 1/2"

Single Pedestal Desk	31 1/2	67 1/2	28 3/4	251	41	WN1SPR1R-3168	\$5,794
	31 1/2	67 1/2	28 3/4	251	41	WN1SPR1L-3168	\$5,794



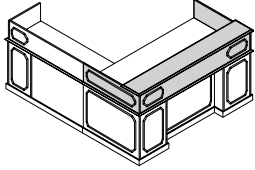
left shown



- top shaped all sides
- 15 5/8" w pencil/box/file pedestal with arm slide
- wood drawers standard, v-fold drawers available, specify and deduct \$87
- locking drawers and center drawer
- enclosed pedestal bottom
- walden molding available, specify and add \$582 list
- grommet available, specify and add \$114 list each; see page [WN14](#)
- chassis size: 66" x 29 5/8"
- kneespace width: 49 3/8"
- kneespace height: 24 1/2"

WALDEN

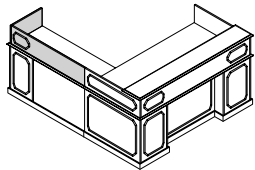
Description	D	W	H	CTN WT	CU FT	① Model	List Price
Desk Reception Gallery	36 3/4	73 5/8	11 1/4	86	22	WN7TCG1-3774	\$3,515
	30 3/8	67 1/2	11 1/4	76	17	WN7TCG1-3068	\$3,250



shown with optional molding

- use atop double and single pedestal desk
- transaction top shaped all sides
- walden molding available, specify and add \$582 list
- transaction top depth: 10"

Return Reception Gallery	23 7/8	48 3/4	10 1/8	34	9	WN7TCR1R-2449	\$1,930
	23 7/8	48 3/4	10 1/8	34	9	WN7TCR1L-2449	\$1,930
	20	48 3/4	10 1/8	33	8	WN7TCR1R-2049	\$1,894
	20	48 3/4	10 1/8	33	8	WN7TCR1L-2049	\$1,894



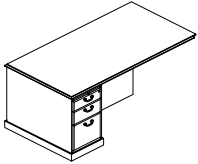
right shown with optional molding

- use atop returns
- walden molding available, specify and add \$582 list
- -2449 use with 25"d returns
- -2049 use with 22"d returns

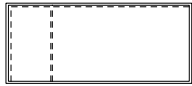
To Order, Specify:

- ① Model Number
- ② Wood Species - Cherry (CH1) or Walnut (WA1)
(see page [WN15](#))
- ③ Finish Color - (see page [WN15](#))
- ④ Pull Color - (see page [WN15](#))
- ⑤ Product Modification - (see page [WN9](#))

Description	D	W	H	CTN WT	CU FT	① Model	List Price
Run-Off Desk with Pedestal Support	37 1/2	66 3/4	28 3/4	233	48	WN1PRR1R-3867	\$5,021
	37 1/2	66 3/4	28 3/4	233	48	WN1PRR1L-3867	\$5,021
	37 1/2	60 3/4	28 3/4	221	44	WN1PRR1R-3861	\$4,826
	37 1/2	60 3/4	28 3/4	221	44	WN1PRR1L-3861	\$4,826

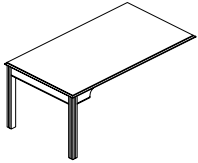


left shown



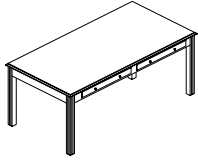
- top shaped three sides with reverse shape on connecting end
- 15 5/8" w pencil/box/file pedestal with arm slide
- wood drawers standard, v-fold drawers available, specify and deduct \$60
- pedestal front locking
- enclosed pedestal bottom
- walden molding available, specify and add \$238 list
- grommet available, specify and add \$114 list each; see page [WN14](#)

Run-Off Desk with Leg Support	36	66	28 3/4	104	46	WN1LRR1-3666	\$3,261
	30	60	28 3/4	95	35	WN1LRR1-3060	\$2,858
	30	54	28 3/4	87	32	WN1LRR1-3054	\$2,636



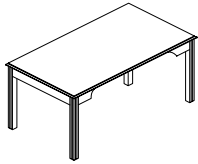
- top shaped three sides with reverse shape on connecting end
- grommet available, specify and add \$114 list each; see page [WN14](#)

Description	D	W	H	CTN WT	CU FT	① Model	List Price
Table Desk	36	72	28 ¾	146	12	WN1TDR1-3672	\$4,964
	30	60	28 ¾	109	8	WN1TDR1-3060	\$4,342



- top shaped all sides
- two wood drawers standard, v-fold drawers available, specify and deduct \$72
- grommet available, specify and add \$114 list each; see page [WN14](#)
- kneespace height: 23 ¾"
- -3672 kneespace width: 66"
- -3060 kneespace width: 54"

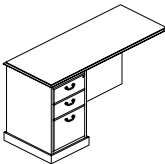
Table Desk	36	66	28 ¾	100	11	WN1TDRA-3666	\$3,435
------------	----	----	------	-----	----	--------------	---------



- top shaped all sides
- grommet available, specify and add \$114 list each; see page [WN14](#)
- kneespace height: 23 ¾"
- kneespace width: 60"

To Order, Specify:

- ① Model Number
- ② Wood Species - Cherry (CH1) or Walnut (WA1)
(see page [WN15](#))
- ③ Finish Color - (see page [WN15](#))
- ④ Pull Color - (see page [WN15](#))
- ⑤ Product Modification - (see page [WN9](#))

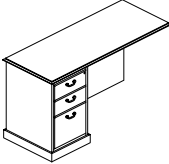
Description	D	W	H	CTN WT	CU FT	① Model	List Price
 left shown	21 5/8	54 3/4	28 3/4	158	24	WN3RTP1R-2255	\$4,571
	21 5/8	54 3/4	28 3/4	158	24	WN3RTP1L-2255	\$4,571
	21 5/8	48 3/4	28 3/4	149	21	WN3RTP1R-2249	\$4,424
	21 5/8	48 3/4	28 3/4	149	21	WN3RTP1L-2249	\$4,424
	21 5/8	42 3/4	28 3/4	139	19	WN3RTP1R-2243	\$4,294
	21 5/8	42 3/4	28 3/4	139	19	WN3RTP1L-2243	\$4,294

- top shaped three sides with reverse shape on connecting end
- 15 5/8" w box/box/file pedestal
- wood drawers standard, v-fold drawers available, specify and deduct \$60
- pedestal front locking
- enclosed pedestal bottom
- walden molding available, specify and add \$238 list
- grommet available, specify and add \$114 list each; see page [WN14](#)
- kneespace wire management: 3 1/2" x 1 5/8" with black trim insert
- kneespace height: 27 1/2"
- -2255 kneespace width: 39 3/8"
- -2249 kneespace width: 35 3/8"
- -2243 kneespace width: 27 3/8"

 left shown	25 3/8	54 3/4	28 3/4	171	28	WN3RTP1R-2555	\$5,118
	25 3/8	54 3/4	28 3/4	171	28	WN3RTP1L-2555	\$5,118
	25 3/8	48 3/4	28 3/4	161	25	WN3RTP1R-2549	\$4,965
	25 3/8	48 3/4	28 3/4	161	25	WN3RTP1L-2549	\$4,965
	25 3/8	42 3/4	28 3/4	152	22	WN3RTP1R-2543	\$4,821
	25 3/8	42 3/4	28 3/4	152	22	WN3RTP1L-2543	\$4,821

- top shaped three sides with reverse shape on connecting end
- 15 5/8" w box/box/file pedestal
- wood drawers standard, v-fold drawers available, specify and deduct \$60
- pedestal front locking
- enclosed pedestal bottom
- walden molding available, specify and add \$238 list
- grommet available, specify and add \$114 list each; see page [WN14](#)
- kneespace wire management: 3 1/2" x 1 5/8" with black trim insert
- kneespace height: 27 1/2"
- -2255 kneespace width: 39 3/8"
- -2249 kneespace width: 35 3/8"
- -2243 kneespace width: 27 3/8"

WALDEN

Description	D	W	H	CTN WT	CU FT	① Model	List Price
22" d Return used with Corner Unit  left shown	21 5/8	54 3/4	28 3/4	158	28	WN3RTP5R-2255	\$4,668
	21 5/8	54 3/4	28 3/4	158	28	WN3RTP5L-2255	\$4,668
	21 5/8	48 3/4	28 3/4	148	21	WN3RTP5R-2249	\$4,522
	21 5/8	48 3/4	28 3/4	148	21	WN3RTP5L-2249	\$4,522
	21 5/8	42 3/4	28 3/4	138	19	WN3RTP5R-2243	\$4,389
	21 5/8	42 3/4	28 3/4	138	19	WN3RTP5L-2243	\$4,389

- use with corner units WN7SCU1-4242, WN7SCU1R-4242 or WN7SCU1L-4242
- top shaped three sides, flat on connecting end
- right hand return connects to the right hand corner unit
- left hand return connects to the left hand corner unit
- 15 5/8" w box/box/file pedestal
- wood drawers standard, v-fold drawers available, specify and deduct \$60
- pedestal front locking
- enclosed pedestal bottom
- walden molding available, specify and add \$238 list
- grommet available, specify and add \$114 list each; see page [WN14](#)
- kneespace wire management: 3 1/2" x 1 5/8" with black trim insert
- kneespace height: 27 1/2"
- -2255 kneespace width: 38 3/8"
- -2249 kneespace width: 33 3/8"
- -2243 kneespace width: 27 3/8"

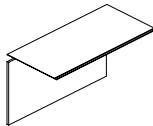
To Order, Specify:

- ① Model Number
- ② Wood Species - Cherry (CH1) or Walnut (WA1)
(see page [WN15](#))
- ③ Finish Color - (see page [WN15](#))
- ④ Pull Color - (see page [WN15](#))
- ⑤ Product Modification - (see page [WN9](#))

Product Modifications:

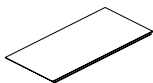
Pedestal Change - see page [WN9](#)

Description	D	W	H	CTN WT	CU FT	① Model	List Price
22"d Bridge Top with Modesty Panel	21 5/8	54	28 3/4	95	2	WN3BMR1-2254	\$3,217
	21 5/8	48	28 3/4	88	2	WN3BMR1-2248	\$3,063
	21 5/8	42	28 3/4	76	2	WN3BMR1-2242	\$2,932



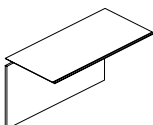
- top shaped two sides with reverse shape on connecting ends
- removable modesty panel
- 1 1/2" h wire management space between worksurface and modesty
- grommet available, specify and add \$114 list each; see page [WN14](#)

22"d Bridge Top	21 5/8	54	1 1/8	45	2	WN3BTU1-2254	\$1,663
	21 5/8	48	1 1/8	41	2	WN3BTU1-2248	\$1,592
	21 5/8	42	1 1/8	37	2	WN3BTU1-2242	\$1,562



- top shaped two sides with reverse shape on connecting ends
- grommet available, specify and add \$114 list each; see page [WN14](#)

22"d Bridge Top with Modesty Panel used with Corner Unit	21 5/8	54	28 3/4	86	2	WN3BMR5R-2254	\$3,309
	21 5/8	54	28 3/4	86	2	WN3BMR5L-2254	\$3,309
	21 5/8	48	28 3/4	78	2	WN3BMR5R-2248	\$3,158
	21 5/8	48	28 3/4	78	2	WN3BMR5L-2248	\$3,158
	21 5/8	42	28 3/4	68	2	WN3BMR5R-2242	\$3,024
	21 5/8	42	28 3/4	68	2	WN3BMR5L-2242	\$3,024



right shown

- use with corner units WN7SCU1-4242, WN7SCU1R-4242 or WN7SCU1L-4242
- top shaped two sides with reverse shape on one end, flat connecting end on the other
- right hand bridge attaches to left hand corner unit
- left hand bridge attaches to the right hand corner unit
- removable modesty panel
- 1 1/2" h wire management space between worksurface and modesty
- grommet available, specify and add \$114 list each; see page [WN14](#)

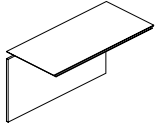
22"d Bridge Top used with Corner Unit	21 5/8	54	1 1/8	42	2	WN3BTU5R-2254	\$1,755
	21 5/8	54	1 1/8	42	2	WN3BTU5L-2254	\$1,755
	21 5/8	48	1 1/8	38	2	WN3BTU5R-2248	\$1,690
	21 5/8	48	1 1/8	38	2	WN3BTU5L-2248	\$1,690
	21 5/8	42	1 1/8	34	2	WN3BTU5R-2242	\$1,657
	21 5/8	42	1 1/8	34	2	WN3BTU5L-2242	\$1,657



right shown

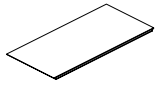
- use with corner units WN7SCU1-4242, WN7SCU1R-4242 or WN7SCU1L-4242
- top shaped two sides with reverse shape on one end, flat connecting end on the other
- right hand bridge attaches to left hand corner unit
- left hand bridge attaches to the right hand corner unit
- grommet available, specify and add \$114 list each; see page [WN14](#)

Description	D	W	H	CTN WT	CU FT	① Model	List Price
25"d Bridge Top with Modesty Panel	25 3/8	54	28 3/4	102	3	WN3BMR1-2554	\$3,772
	25 3/8	48	28 3/4	92	3	WN3BMR1-2548	\$3,622
	25 3/8	42	28 3/4	79	2	WN3BMR1-2542	\$3,490



- top shaped two sides with reverse shape on connecting ends
- removable modesty panel
- 1 1/2" h wire management space between worksurface and modesty
- grommet available, specify and add \$114 list each; see page [WN14](#)

25"d Bridge Top	25 3/8	54	1 1/8	53	3	WN3BTU1-2554	\$1,751
	25 3/8	48	1 1/8	48	2	WN3BTU1-2548	\$1,672
	25 3/8	42	1 1/8	42	2	WN3BTU1-2542	\$1,625



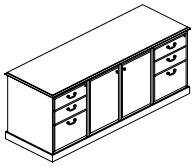
- top shaped two sides with reverse shape on connecting ends
- grommet available, specify and add \$114 list each; see page [WN14](#)

WALDEN

To Order, Specify:

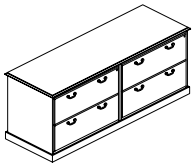
- ① Model Number
- ② Wood Species - Cherry (CH1) or Walnut (WA1)
(see page [WN15](#))
- ③ Finish Color - (see page [WN15](#))
- ④ Product Modification - (see page [WN9](#))

Description	D	W	H	CTN WT	CU FT	① Model	List Price
Storage Credenza	24 5/8	73 5/8	28 3/4	353	37	WN2HDP1-2574	\$6,821
	24 5/8	67 5/8	28 3/4	332	34	WN2HDP1-2568	\$6,708
	24 5/8	61 5/8	28 3/4	307	31	WN2HDP1-2562	\$6,470



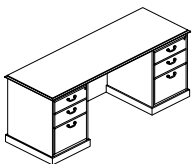
- top and base shaped three sides
- wood drawers standard, v-fold drawers available, specify and deduct \$120
- adjustable shelf in hinged door compartment
- pedestal front locking
- locking doors available, specify and add \$142 list
- walden molding available, specify and add \$238 list
- grommet available, specify and add \$114 list each; see page [WN14](#)
- flat cut for connection left or right end, specify and add \$753 list and indicate right or left end
- flat cut for connection on both ends available, specify and add \$1,151 list
- -2574 box/box/file pedestals, 18"w
- -2568 box/box/file pedestals, 15 5/8"w
- -2562 box/box/file pedestals, 15 5/8"w
- -2574 hinged door compartment, 34 1/2"w
- -2568 hinged door compartment, 33 3/8"w
- -2562 hinged door compartment, 27 3/8"w

Lateral File Credenza	24 5/8	73 5/8	28 3/4	321	37	WN2DST1-2574	\$8,321
	24 5/8	61 5/8	28 3/4	282	31	WN2DST1-2562	\$7,756



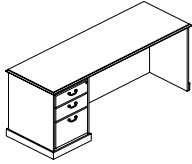
- top and base shaped three sides
- wood drawers standard, v-fold drawers available, specify and deduct \$120
- pedestal front locking
- walden molding available, specify and add \$238 list
- flat cut for connection left or right end, specify and add \$753 list and indicate right or left end
- flat cut for connection on both ends available, specify and add \$1,151 list
- -2574 four lateral files, 36"w
- -2562 four lateral files, 30"w

Kneespace Credenza	24 5/8	73 5/8	28 3/4	266	37	WN2KSP1-2574	\$6,321
	24 5/8	67 5/8	28 3/4	248	34	WN2KSP1-2568	\$5,864
	24 5/8	61 5/8	28 3/4	233	31	WN2KSP1-2562	\$5,409

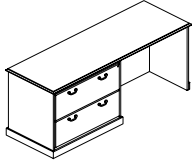


- top and base shaped three sides
- wood drawers standard, v-fold drawers available, specify and deduct \$120
- pedestal front locking
- 1 1/2"h wire management space between worksurface and back panel of kneespace
- walden molding available, specify and add \$238 list
- grommet available, specify and add \$114 list each; see page [WN14](#)
- flat cut for connection left or right end, specify and add \$753 list and indicate right or left end
- flat cut for connection on both ends available, specify and add \$1,151 list
- kneespace height: 27 1/2"h
- -2574 box/box/file pedestals, 18"w
- -2568 box/box/file pedestals, 15 5/8"w
- -2562 box/box/file pedestals, 15 5/8"w
- -2574 kneespace width, 36"w
- -2568 kneespace width, 34 5/8"w
- -2562 kneespace width, 28 7/8"w

WALDEN

Description	D	W	H	CTN WT	CU FT	① Model	List Price
Box/Box/File Open Corner Credenza  left shown	24 5/8	85 5/8	28 3/4	230	43	WN20CP1R-2586	\$6,214
	24 5/8	85 5/8	28 3/4	230	43	WN20CP1L-2586	\$6,214
	24 5/8	73 5/8	28 3/4	211	37	WN20CP1R-2574	\$5,854
	24 5/8	73 5/8	28 3/4	211	37	WN20CP1L-2574	\$5,854
	24 5/8	61 5/8	28 3/4	195	31	WN20CP1R-2562	\$5,638
	24 5/8	61 5/8	28 3/4	195	31	WN20CP1L-2562	\$5,638

- top and base shaped three sides
- 18" box/box/file pedestal
- wood drawers standard, v-fold drawers available, specify and deduct \$60
- pedestal front locking
- locking drawers
- 1 1/2" h wire management space between worksurface and back panel of kneespace
- walden molding available, specify and add \$238 list
- grommet available, specify and add \$114 list each; see page [WN14](#)
- flat cut for connection left or right end, specify and add \$753 list and indicate right or left end
- flat cut for connection on both ends available, specify and add \$1,151 list
- kneespace height: 27 1/2" h
- -2586 kneespace width, 62 1/4" w
- -2574 kneespace width, 50 1/4" w
- -2562 kneespace width, 43 5/8" w

Description	D	W	H	CTN WT	CU FT	Model	List Price
Lateral File Open Corner Credenza  left shown	24 5/8	91 5/8	28 3/4	276	46	WN20CL1R-2592	\$7,177
	24 5/8	91 5/8	28 3/4	276	46	WN20CL1L-2592	\$7,177
	24 5/8	85 5/8	28 3/4	267	43	WN20CL1R-2586	\$6,539
	24 5/8	85 5/8	28 3/4	267	43	WN20CL1L-2586	\$6,539
	24 5/8	73 5/8	28 3/4	253	37	WN20CL1R-2574	\$6,060
	24 5/8	73 5/8	28 3/4	253	37	WN20CL1L-2574	\$6,060

- top and base shaped three sides
- 36" w lateral files
- wood drawers standard, v-fold drawers available, specify and deduct \$60
- locking drawers
- 1 1/2" h wire management space between worksurface and back panel of kneespace
- walden molding available, specify and add \$238 list
- grommet available, specify and add \$114 list each; see page [WN14](#)
- flat cut for connection left or right end, specify and add \$753 list and indicate right or left end
- flat cut for connection on both ends available, specify and add \$1,151 list
- kneespace height: 27 1/2" h
- -2592 kneespace width, 53 1/4" w
- -2586 kneespace width, 47 1/4" w
- -2574 kneespace width, 35 1/4" w

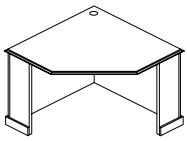
To Order, Specify:

- ① Model Number
- ② Wood Species - Cherry (CH1) or Walnut (WA1)
(see page [WN15](#))
- ③ Finish Color - (see page [WN15](#))
- ④ Pull Color - (see page [WN15](#))
- ⑤ Product Modification - (see page [WN9](#))

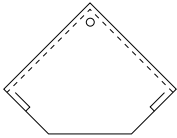
Product Modifications:

Pedestal Change - see page [WN9](#)

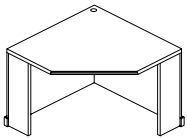
Description	D	W	H	CTN WT	CU FT	① Model	List Price
Freestanding Corner Unit	41 5/8	41 5/8	28 3/4	146	34	WNOSCU1-4242	\$5,404



- top shaped all sides
- 2" grommet in center corner of top
- grommet finish, see page [WN14](#)
- kneespace width: 28 3/8"w
- kneespace height: 27 5/8"h

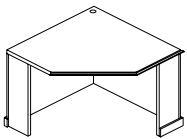


Corner Unit	41 5/8	41 5/8	28 3/4	150	34	WN7SCU1-4242	\$5,095
-------------	--------	--------	--------	-----	----	--------------	---------



- top shaped three sides, flat on connecting ends
- connecting on left and right
- bridges available, see page [WN24](#)
- 2" grommet in center corner of top
- grommet finish, see page [WN14](#)
- kneespace width: 28 3/8"w
- kneespace height: 27 5/8"h
- connecting end: 21 5/8"

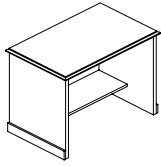
Corner Unit	41 5/8	41 5/8	28 3/4	150	34	WN7SCU1R-4242	\$5,147
	41 5/8	41 5/8	28 3/4	150	34	WN7SCU1L-4242	\$5,147



left shown

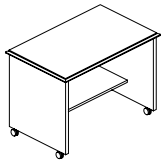
- top shaped four sides, flat on connecting end
- connecting on left or right
- bridges available, see page [WN24](#)
- 2" grommet in center corner of top
- grommet finish, see page [WN14](#)
- kneespace width: 28 3/8"w
- kneespace height: 27 5/8"h
- connecting end: 21 5/8"

Description	D	W	H	CTN WT	CU FT	① Model	List Price
Computer/Printer Stand	25 3/8	40	28 3/4	210	20	WNOCP5-2540	\$2,640



- top shaped three sides
- 12"d fixed inside shelf
- access slot across top of back panel
- grommet available, specify and add \$114 list each; see page [WN14](#)
- kneespace height: 27 3/8"h

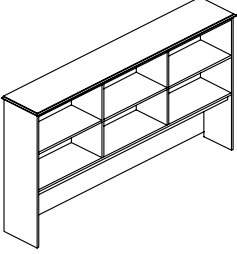

Mobile Computer/Printer Stand	25 3/8	40	28 3/4	224	20	WNOCP5-2540	\$2,945
-------------------------------	--------	----	--------	-----	----	-------------	---------

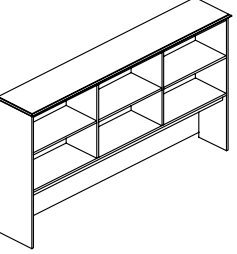



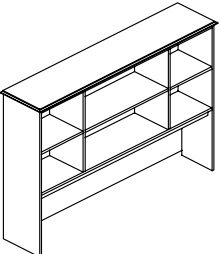

- top shaped three sides
- 12"d fixed inside shelf
- access slot across top of back panel
- grommet available, specify and add \$114 list each; see page [WN14](#)
- casters: front two are locking
- kneespace height: 27 3/8"h

To Order, Specify:

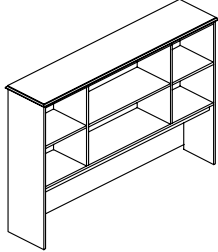
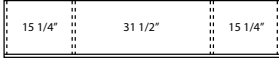
- ① Model Number
- ② Wood Species - Cherry (CH1) or Walnut (WA1)
(see page [WN15](#))
- ③ Finish Color - (see page [WN15](#))
- ④ Grommet Color - (see page [WN14](#))
- ⑤ Product Modification - (see page [WN9](#))

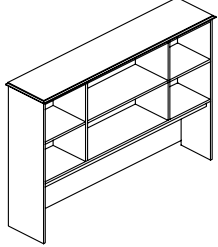

Description	D	W	H	CTN WT	CU FT	① Model	List Price No Tackboard	List Price With Tackboard
Double Height Open Storage Overhead Cabinet  	15 7/8	91 5/8	50 3/8	330	51	WN4B001-1692	\$8,426	COM \$9,728
	<ul style="list-style-type: none"> · top shaped three sides · three adjustable shelves · hardware included for attachment to credenza · 1 1/2" wire access slot across the bottom of back panel · task lights available, see accessories price list · glass shelves available, specify and add \$787 list · unit without top, specify and deduct \$209 · flat cut for connection left or right end, specify and add \$753 list and indicate right or left end · flat cut for connection on both ends available, specify and add \$1,151 list · compartment height: 27" · compartment depth: 14" · worksurface to valance rail: 18" · com ydg: 1 3/4 							
	A \$9,755							
	B \$9,804							
	C \$9,896							
	D \$10,006							
	E \$10,122							
	F \$10,299							
	G \$10,488							
	H \$10,691							
	I \$11,010							
	J \$11,387							

Double Height Open Storage Overhead Cabinet  	15 7/8	85 5/8	50 3/8	313	47	WN4B001-1686	\$7,662	COM \$8,781
	<ul style="list-style-type: none"> · top shaped three sides · three adjustable shelves · hardware included for attachment to credenza · 1 1/2" wire access slot across the bottom of back panel · task lights available, see accessories price list · glass shelves available, specify and add \$787 list · unit without top, specify and deduct \$192 · flat cut for connection left or right end, specify and add \$753 list and indicate right or left end · flat cut for connection on both ends available, specify and add \$1,151 list · compartment height: 27" · compartment depth: 14" · worksurface to valance rail: 18" · com ydg: 1 1/2 							
	A \$8,803							
	B \$8,845							
	C \$8,921							
	D \$9,020							
	E \$9,118							
	F \$9,270							
	G \$9,432							
	H \$9,603							
	I \$9,877							
	J \$10,202							

Double Height Open Storage Overhead Cabinet  	15 7/8	73 5/8	50 3/8	277	41	WN4B001-1674	\$6,901	COM \$7,920
	<ul style="list-style-type: none"> · top shaped three sides · three adjustable shelves · hardware included for attachment to credenza · 1 1/2" wire access slot across the bottom of back panel · task lights available, see accessories price list · glass shelves available, specify and add \$586 list · unit without top, deduct \$165 · flat cut for connection left or right end, specify and add \$753 list and indicate right or left end · flat cut for connection on both ends available, specify and add \$1,151 list · compartment height: 27" · compartment depth: 14" · worksurface to valance rail: 18" · com ydg: 1 1/4 							
	A \$7,941							
	B \$7,977							
	C \$8,040							
	D \$8,122							
	E \$8,203							
	F \$8,328							
	G \$8,467							
	H \$8,609							
	I \$8,837							
	J \$9,107							

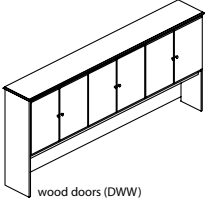
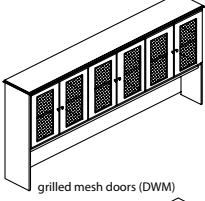
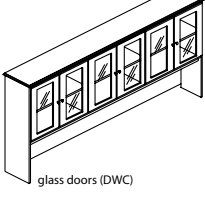

WALDEN

Description	D	W	H	CTN WT	CU FT	① Model	List Price No Tackboard	List Price With Tackboard
Double Height Open Storage Overhead Cabinet  	15 7/8	67 5/8	50 3/8	261	38	WN4B001-1668	\$6,494	COM \$7,336 A \$7,355 B \$7,388 C \$7,453 D \$7,535 E \$7,615 F \$7,743 G \$7,879 H \$8,024 I \$8,249 J \$8,521
<ul style="list-style-type: none"> top shaped three sides three adjustable shelves hardware included for attachment to credenza 1 1/2" wire access slot across the bottom of back panel task lights available, see accessories price list glass shelves available, specify and add \$586 list unit without top, deduct \$161 flat cut for connection left or right end, specify and add \$753 list and indicate right or left end flat cut for connection on both ends available, specify and add \$1,151 list compartment height: 27" compartment depth: 14" worksurface to valance rail: 18" com ydg: 1 1/4 								

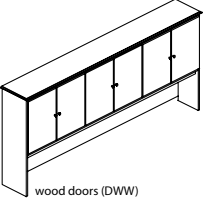
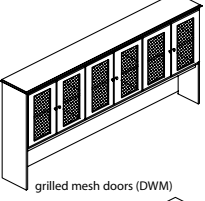
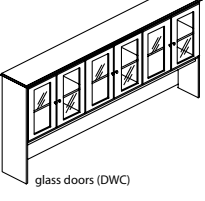
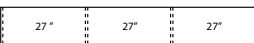
Double Height Open Storage Overhead Cabinet  	15 7/8	61 5/8	50 3/8	256	34	WN4B001-1662	\$5,857	COM \$6,426 A \$6,439 B \$6,470 C \$6,520 D \$6,585 E \$6,648 F \$6,752 G \$6,862 H \$6,976 I \$7,158 J \$7,374
<ul style="list-style-type: none"> top shaped three sides three adjustable shelves hardware included for attachment to credenza 1 1/2" wire access slot across the bottom of back panel task lights available, see accessories price list glass shelves available, specify and add \$586 list unit without top, deduct \$135 flat cut for connection left or right end, specify and add \$753 list and indicate right or left end flat cut for connection on both ends available, specify and add \$1,151 list compartment height: 27" compartment depth: 14" worksurface to valance rail: 18" com ydg: 1 								

To Order, Specify:

- ① Model Number
- ② Wood Species - Cherry (CH1) or Walnut (WA1)
(see page [WN15](#))
- ③ Finish Color - (see page [WN15](#))
- ④ Fabric - vendor, pattern, color

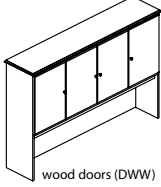
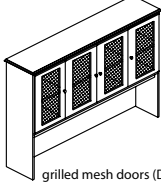
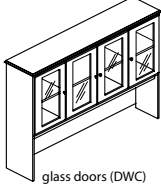

Description	D	W	H	CTN WT	CU FT	Model	List Price No Tackboard	List Price With Tackboard
Double Height Storage Overhead Cabinet with 6 Doors  wood doors (DWW)  grilled mesh doors (DWM)  glass doors (DWC) 	15 7/8	91 5/8	50 3/8	413	51	WN4BOS1-1692	\$9,252	COM \$10,554 A \$10,580 B \$10,630 C \$10,719 D \$10,832 E \$10,947 F \$11,123 G \$11,313 H \$11,518 I \$11,832 J \$12,211

- top shaped three sides
- three adjustable shelves; one adjustable shelf per compartment
- hardware included for attachment to credenza
- 1 1/2" wire access slot across the bottom of back panel
- task lights available, see [accessories price list](#)
- walden molding available on wood doors, specify and add \$729 list
- grilled mesh or glass doors available, specify and add \$639 list
- glass shelves available, specify and add \$787 list
- unit without top, specify and deduct \$209 list
- locking doors available, specify and add \$426 list
- flat cut for connection left or right end, specify and add \$753 list and indicate right or left end
- flat cut for connection on both ends available, specify and add \$1,151 list
- compartment height: 27"
- compartment depth: 13 1/4"
- worksurface to valance rail: 18"
- com ydg: 1 3/4

Double Height Storage Overhead Cabinet with 6 Doors  wood doors (DWW)  grilled mesh doors (DWM)  glass doors (DWC) 	15 7/8	85 5/8	50 3/8	385	47	WN4BOS1-1686	\$8,412	COM \$9,530 A \$9,552 B \$9,594 C \$9,672 D \$9,767 E \$9,865 F \$10,020 G \$10,179 H \$10,352 I \$10,625 J \$10,950
---	--------	--------	--------	-----	----	--------------	---------	--

- top shaped three sides
- three adjustable shelves; one adjustable shelf per compartment
- hardware included for attachment to credenza
- 1 1/2" wire access slot across the bottom of back panel
- task lights available, see [accessories price list](#)
- walden molding available on wood doors, specify and add \$729
- grilled mesh or glass doors available, specify and add \$639 list
- glass shelves available, specify and add \$787 list
- unit without top, specify and deduct \$192 list
- locking doors available, specify and add \$426 list
- flat cut for connection left or right end, specify and add \$753 list and indicate right or left end
- flat cut for connection on both ends available, specify and add \$1,151 list
- compartment height: 27"
- compartment depth: 13 1/4"
- worksurface to valance rail: 18"
- com ydg: 1 1/2

WALDEN

Description	D	W	H	CTN WT	CU FT	① Model	List Price No Tackboard	List Price With Tackboard
Double Height Storage Overhead Cabinet with 4 Doors  <p>wood doors (DWW)</p>  <p>grilled mesh doors (DWM)</p>  <p>glass doors (DWC)</p> 	15 $\frac{7}{8}$	73 $\frac{5}{8}$	50 $\frac{3}{8}$	323	41	WN4BOS1-1674	\$7,768	COM \$8,790 A \$8,809 B \$8,844 C \$8,907 D \$8,990 E \$9,068 F \$9,195 G \$9,334 H \$9,479 I \$9,704 J \$9,973

- top shaped three sides
- three adjustable shelves; one adjustable shelf per compartment
- hardware included for attachment to credenza
- 1 1/2" wire access slot across the bottom of back panel
- task lights available, see [accessories price list](#)
- walden molding available on wood doors, specify and add \$489 list
- grilled mesh or glass doors available, specify and add \$427 list
- glass shelves available, specify and add \$586 list
- unit without top, deduct \$165 list
- locking doors available, specify and add \$426 list
- flat cut for connection left or right end, specify and add \$753 list and indicate right or left end
- flat cut for connection on both ends available, specify and add \$1,151 list
- compartment height: 27"
- compartment depth: 13 1/4"
- worksurface to valance rail: 18"
- com ydg: 1 1/4

WALDEN

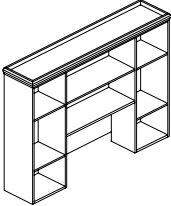

To Order, Specify:

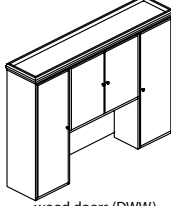
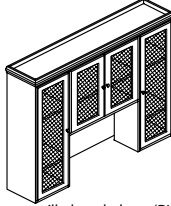
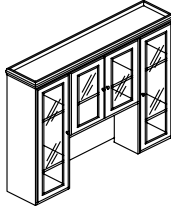

- ① Model Number
- ② Wood Species - Cherry (CH1) or Walnut (WA1)
(see page [WN15](#))
- ③ Finish Color - (see page [WN15](#))
- ④ Fabric - vendor, pattern, color
- ⑤ Pull Color - (see page [WN15](#))

Description	D	W	H	CTN WT	CU FT	① Model	List Price No Tackboard	List Price With Tackboard	
Double Height Storage Overhead Cabinet with 4 Doors	15 7/8	67 5/8	50 3/8	301	38	WN4BOS1-1668	\$7,147	COM \$7,986	
<p>wood doors (DWW)</p> <p>grilled mesh doors (DWM)</p> <p>glass doors (DWC)</p>	<ul style="list-style-type: none"> · top shaped three sides · three adjustable shelves; one adjustable shelf per compartment · hardware included for attachment to credenza · 1 1/2" wire access slot across the bottom of back panel · task lights available, see accessories price list · walden molding available on wood doors, specify and add \$489 list · grilled mesh or glass doors available, specify and add \$427 list · glass shelves available, specify and add \$586 list · unit without top, deduct \$161 list · locking doors available, specify and add \$426 list · flat cut for connection left or right end, specify and add \$753 list and indicate right or left end · flat cut for connection on both ends available, specify and add \$1,151 list · compartment height: 27" · compartment depth: 13 1/4" · worksurface to valance rail: 18" · com ydg: 1 1/4 								
								A \$8,008	
								B \$8,041	
								C \$8,104	
								D \$8,187	
								E \$8,267	
								F \$8,395	
								G \$8,531	
								H \$8,677	
								I \$8,901	
								J \$9,172	

Double Height Storage Overhead Cabinet with 4 Doors	15 7/8	61 5/8	50 3/8	299	34	WN4BOS1-1662	\$6,509	COM \$7,079	
<p>wood doors (DWW)</p> <p>grilled mesh doors (DWM)</p> <p>glass doors (DWC)</p>	<ul style="list-style-type: none"> · top shaped three sides · three adjustable shelves; one adjustable shelf per compartment · hardware included for attachment to credenza · 1 1/2" wire access slot across the bottom of back panel · task lights available, see accessories price list · walden molding available on wood doors, specify and add \$489 list · grilled mesh or glass doors available, specify and add \$427 list · glass shelves available, specify and add \$586 list · unit without top, deduct \$135 list · locking doors available, specify and add \$426 list · flat cut for connection left or right end, specify and add \$753 list and indicate right or left end · flat cut for connection on both ends available, specify and add \$1,151 list · compartment height: 27" · compartment depth: 13 1/4" · worksurface to valance rail: 18" · com ydg: 1 								
								A \$7,094	
								B \$7,123	
								C \$7,171	
								D \$7,237	
								E \$7,301	
								F \$7,405	
								G \$7,511	
								H \$7,629	
								I \$7,810	
								J \$8,025	

WALDEN

Description	D	W	H	CTN WT	CU FT	① Model	List Price No Tackboard	List Price With Tackboard
Open Overhead Storage Cabinet with Tower  	15 7/8	73 5/8	51 5/8	259	42	WN4BST6-1674	\$5,720	COM \$6,198 A \$6,211 B \$6,230 C \$6,270 D \$6,318 E \$6,368 F \$6,444 G \$6,524 H \$6,609 I \$6,748 J \$6,912
<ul style="list-style-type: none"> · top shaped three sides · adjustable shelves · hardware included for attachment to credenza · 1 1/2" wire access slot across bottom of back panel · task lights available, see accessories price list · cornice top · glass shelves available, specify and add \$586 list · unit without top, deduct \$175 list · left & right compartment height: 49 3/8" · center compartment height: 27" · compartment depth: 14" · worksurface to valance rail: 18" · com ydg: 3/4 <p>cornice tops are meant as stand alone units</p>								

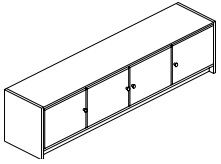
Overhead Storage Cabinet with Tower  wood doors (DWW)  grilled mesh doors (DWM)  glass doors (DWC) 	15 7/8	73 5/8	51 5/8	429	42	WN4BST1-1674	\$7,242	COM \$7,722 A \$7,732 B \$7,753 C \$7,791 D \$7,839 E \$7,889 F \$7,967 G \$8,047 H \$8,134 I \$8,267 J \$8,432
<ul style="list-style-type: none"> · top shaped three sides · adjustable shelves · hardware included for attachment to credenza · 1 1/2" wire access slot across bottom of back panel · task lights available, see accessories price list · walden molding available on wood doors, specify and add \$489 list · cornice top · glass shelves available, specify and add \$586 list · unit without top, deduct \$175 · grilled mesh or glass doors available, specify and add \$427 list · locking doors available, specify and add \$426 list · left & right compartment height: 49 3/8" · center compartment height: 27" · compartment depth: 13 1/4" · worksurface to valance rail: 18" · com ydg: 3/4 <p>cornice tops are meant as stand alone units</p>								

To Order, Specify:

- ① Model Number
- ② Wood Species - Cherry (CH1) or Walnut (WA1)
(see page [WN15](#))
- ③ Finish Color - (see page [WN15](#))
- ④ Pull Color - (see page [WN15](#))
- ⑤ Fabric - vendor, pattern, color

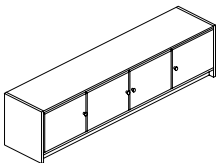
Description	D	W	H	CTN WT	CU FT	① Model	List Price
-------------	---	---	---	-----------	----------	---------	------------

Wall Mount Overhead with 4 Doors	15 1/8	72	18 3/8	208	16	WN4BBW1-1572	\$3,906
----------------------------------	--------	----	--------	-----	----	--------------	---------



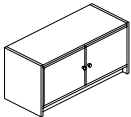
- without top
- mounting brackets included
- valance rail
- wire management grommet in back panel
- locking doors available, specify and add \$426 list

Wall Mount Overhead with 4 Doors	15 1/8	60	18 3/8	172	13	WN4BBW1-1560	\$3,689
----------------------------------	--------	----	--------	-----	----	--------------	---------



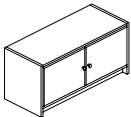
- without top
- mounting brackets included
- valance rail
- wire management grommet in back panel
- locking doors available, specify and add \$426 list

Wall Mount Overhead with 2 Doors	15 1/8	36	18 3/8	114	8	WN4BBW1-1536	\$3,129
----------------------------------	--------	----	--------	-----	---	--------------	---------



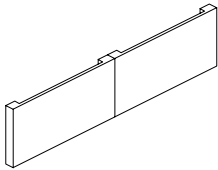
- without top
- mounting brackets included
- valance rail
- wire management grommet in back panel
- locking doors available, specify and add \$142 list

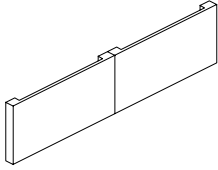
Wall Mount Overhead with 2 Doors	15 1/8	30	18 3/8	87	7	WN4BBW1-1530	\$2,995
----------------------------------	--------	----	--------	----	---	--------------	---------

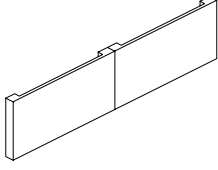


- without top
- mounting brackets included
- valance rail
- wire management grommet in back panel
- locking doors available, specify and add \$142 list

WALDEN

Description	D	W	H	CTN WT	CU FT	① Model	List Price Per Grade
84" w Wall Mount Tackboard 	1 1/2	84	21 1/2	35	4	GP9HTB1-8422	COM \$1,291 A \$1,312 B \$1,355 C \$1,430 D \$1,529 E \$1,626 F \$1,778 G \$1,942 H \$2,114 I \$2,388 J \$2,711
<ul style="list-style-type: none"> · use with wall mounted storage · com ydg: 1 1/2 							

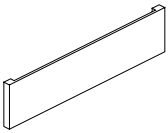
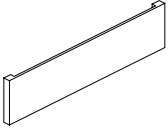
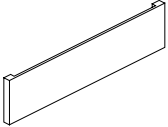
72" w Wall Mount Tackboard 	1 1/2	72	21 1/2	30	4	GP9HTB1-7222	COM \$1,106 A \$1,125 B \$1,163 C \$1,223 D \$1,307 E \$1,388 F \$1,512 G \$1,650 H \$1,794 I \$2,020 J \$2,291
<ul style="list-style-type: none"> · use with wall mounted storage · com ydg: 1 1/4 							

66" w Wall Mount Tackboard 	1 1/2	66	21 1/2	26	3	GP9HTB1-6622	COM \$1,015 A \$1,035 B \$1,070 C \$1,133 D \$1,215 E \$1,296 F \$1,423 G \$1,561 H \$1,704 I \$1,930 J \$2,201
<ul style="list-style-type: none"> · use with wall mounted storage · com ydg: 1 1/4 							

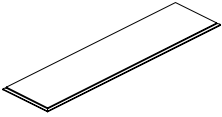
To Order, Specify:

- ① Model Number
- ② Wood Species - Cherry (CH1) or Walnut (WA1)
(see page [WN15](#))
- ③ Finish Color - (see page [WN15](#))
- ④ Fabric - vendor, pattern, color


WALDEN

Description	D	W	H	CTN WT	CU FT	① Model	List Price Per Grade
54"w Wall Mount Tackboard  <ul style="list-style-type: none"> · use with wall mounted storage · com ydg: 1 3/4 	1 1/2	54	21 1/2	22	3	GP9HTB1-5422	COM \$852 A \$879 B \$930 C \$1,017 D \$1,132 E \$1,246 F \$1,423 G \$1,613 H \$1,817 I \$2,131 J \$2,510
36"w Wall Mount Tackboard  <ul style="list-style-type: none"> · use with wall mounted storage · com ydg: 1 1/4 	1 1/2	36	21 1/2	15	2	GP9HTB1-3622	COM \$574 A \$591 B \$628 C \$690 D \$772 E \$855 F \$980 G \$1,118 H \$1,263 I \$1,488 J \$1,758
30"w Wall Mount Tackboard  <ul style="list-style-type: none"> · use with wall mounted storage · com ydg: 1 	1 1/2	30	21 1/2	14	2	GP9HTB1-3022	COM \$477 A \$493 B \$520 C \$572 D \$638 E \$704 F \$803 G \$914 H \$1,026 I \$1,210 J \$1,424

WALDEN

Description	D	W	H	CTN WT	CU FT	① Model	List Price
	15 7/8	121 5/8	1 1/8	73	4	WN70TU1-16122	\$2,608
	15 7/8	109 5/8	1 1/8	67	4	WN70TU1-16110	\$2,214
	15 7/8	91 5/8	1 1/8	55	3	WN70TU1-1692	\$1,479
	15 7/8	73 5/8	1 1/8	46	2	WN70TU1-1674	\$1,371
	15 7/8	61 5/8	1 1/8	39	2	WN70TU1-1662	\$960
	15 7/8	37 5/8	1 1/8	24	1	WN70TU1-1638	\$826
	15 7/8	31 5/8	1 1/8	21	1	WN70TU1-1632	\$585
	15 7/8	19 5/8	1 1/8	15	1	WN70TU1-1620	\$491

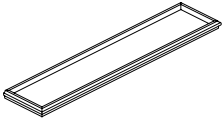
- shaped three sides
- flat cut for connection left or right end, specify and add \$753 list and indicate right or left end
- flat cut for connection on both ends available, specify and add \$1,151 list
- WN70TU1-16122 use with four 30" bookcases
- WN70TU1-16110 use with three 36" bookcases
- WN70TU1-1692 use with three 30" bookcases
- WN70TU1-1674 use with two 36" bookcases
- WN70TU1-1662 use with two 30" bookcases
- WN70TU1-1638 use with one 36" bookcases
- WN70TU1-1632 use with one 30" bookcases
- WN70TU1-1620 use with one 18" bookcases

Description	D	W	H	CTN WT	CU FT	Model	List Price
	15 5/8	121 3/8	3	62	6	WN7MBB1-16122	\$1,847
	15 5/8	109 3/8	3	60	6	WN7MBB1-16110	\$1,503
	15 5/8	91 3/8	3	51	5	WN7MBB1-1692	\$1,254
	15 5/8	73 3/8	3	42	4	WN7MBB1-1674	\$1,105
	15 5/8	61 3/8	3	36	3	WN7MBB1-1662	\$909
	15 5/8	37 3/8	3	24	2	WN7MBB1-1638	\$842
	15 5/8	31 3/8	3	20	2	WN7MBB1-1632	\$600

- shaped three sides
- used to make floor-bases bookcases
- flat cut for connection left or right end, specify and add \$753 list and indicate right or left end
- flat cut for connection on both ends available, specify and add \$1,151 list
- WN7MBB1-16122 use with four 30" bookcases
- WN7MBB1-16110 use with three 36" bookcases
- WN7MBB1-1692 use with three 30" bookcases
- WN7MBB1-1674 use with two 36" bookcases
- WN7MBB1-1662 use with two 30" bookcases
- WN7MBB1-1638 use with one 36" bookcases
- WN7MBB1-1632 use with one 30" bookcases

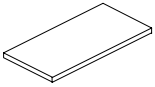
To Order, Specify:

- ① Model Number
- ② Wood Species - Cherry (CH1) or Walnut (WA1)
(see page WN15)
- ③ Finish Color - (see page WN15)
- ④ Fabric - vendor, pattern, color

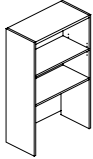
Description	D	W	H	CTN WT	CU FT	① Model	List Price
	15 7/8	121 5/8	2 1/2	64	6	WN70TC1-16122	\$1,847
	15 7/8	109 5/8	2 1/2	58	5	WN70TC1-16110	\$1,476
	15 7/8	91 5/8	2 1/2	49	4	WN70TC1-1692	\$1,358
	15 7/8	73 5/8	2 1/2	37	4	WN70TC1-1674	\$1,162
	15 7/8	61 5/8	2 1/2	34	3	WN70TC1-1662	\$916
	15 7/8	37 5/8	2 1/2	23	2	WN70TC1-1638	\$808
	15 7/8	31 5/8	2 1/2	20	2	WN70TC1-1632	\$614

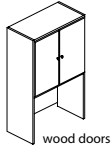

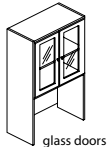
- shaped three sides
- WN70TC1-16122 use with four 30" bookcases
- WN70TC1-16110 use with three 36" bookcases
- WN70TC1-1692 use with three 30" bookcases
- WN70TC1-1674 use with two 36" bookcases
- WN70TC1-1662 use with two 30" bookcases
- WN70TC1-1638 use with one 36" bookcases
- WN70TC1-1632 use with one 30" bookcases

Cornice Top Filler Panel	15	30	3/4	24	1	WN7FLP1-1530	\$519
--------------------------	----	----	-----	----	---	--------------	-------



- use with modular overhead cornice top and two worksurface storage towers

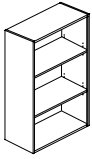
Description	D	W	H	CTN WT	CU FT	① Model	List Price No Tackboard	List Price With Tackboard
Open Bookcase Storage Tower	15 1/8	30	49 1/8	129	16	WN4SUB6-1530	\$3,022	COM \$3,589
 <ul style="list-style-type: none"> adjustable shelf without top hardware for attachment to credenza 1 1/2" wire access slot across bottom of back panel task lights available, see accessories price list glass shelf available, specify and add \$301 list interior dimensions: 14"d x 28 1/2"w x 27"h worksurface to valance rail: 18" com: 1/2 								A \$3,598
								B \$3,611
								C \$3,637
								D \$3,671
								E \$3,706
								F \$3,755
								G \$3,808
								H \$3,867
								I \$3,957
								J \$4,063

Storage Tower with Doors	15 1/8	30	49 1/8	168	16	WN4SUB1-1530	\$4,044	COM \$4,644
 wood doors  grilled meshed doors  glass doors <ul style="list-style-type: none"> adjustable shelf without top hardware for attachment to credenza 1 1/2" wire access slot across bottom of back panel task lights available, see accessories price list walden molding available on wood doors, specify and add \$246 list grilled mesh or glass doors available, specify and add \$216 list glass shelf available, specify and add \$301 list locking doors available, specify and add \$142 list interior dimensions: 13 1/4"d x 28 1/2"w x 27"h worksurface to valance rail: 18" com: 1/2 								A \$4,650
								B \$4,664
								C \$4,691
								D \$4,721
								E \$4,755
								F \$4,805
								G \$4,860
								H \$4,917
								I \$5,010
								J \$5,116

To Order, Specify:

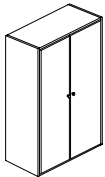
- ① Model Number
- ② Wood Species - Cherry (CH1) or Walnut (WA1)
(see page [WN15](#))
- ③ Finish Color - (see page [WN15](#))
- ④ Pull Color - (see page [WN15](#))
- ⑤ Fabric - vendor, pattern, color

Description	D	W	H	CTN WT	CU FT	① Model	List Price
Open Storage Tower	15 1/8	36	49 1/8	149	19	WN50ST1-1636	\$3,158
	15 1/8	30	49 1/8	138	16	WN50ST1-1630	\$2,821



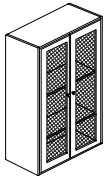
- two adjustable shelves
- without top
- glass shelves available, specify and add \$344 list

Storage Tower with Doors	15 1/8	36	49 1/8	194	19	WN5FDS1-1636	\$4,467
	15 1/8	30	49 1/8	168	16	WN5FDS1-1630	\$4,028

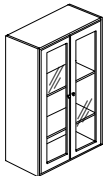


wood doors

- two adjustable shelves
- without top
- walden molding available on wood doors, specify and add \$246 list
- grilled mesh or glass doors available, specify and add \$216 list
- glass shelves available, specify and add \$344 list
- locking doors available, specify and add \$142 list

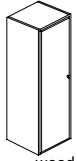


grilled mesh doors

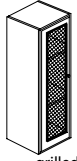


glass doors

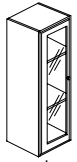
Description	D	W	H	CTN WT	CU FT	① Model	List Price
Storage Tower with Door	15 1/8	18	49 1/8	101	10	WN5FDS1R-1618	\$3,325
	15 1/8	18	49 1/8	101	10	WN5FDS1L-1618	\$3,325



wood doors



grilled mesh doors



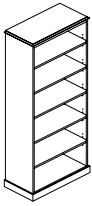
glass doors

- two adjustable shelves
- without top
- walden molding available on wood doors, specify and add \$125 list
- grilled mesh or glass doors available, specify and add \$111 list
- glass shelves available, specify and add \$245 list
- locking door available, specify and add \$142 list
- hinge door determines left or right

To Order, Specify:

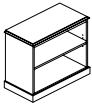
- ① Model Number
- ② Wood Species - Cherry (CH1) or Walnut (WA1)
(see page [WN15](#))
- ③ Finish Color - (see page [WN15](#))
- ④ Pull Color - (see page [WN15](#))

Description	D	W	H	CTN WT	CU FT	① Model	List Price
79"h Bookcase	15 7/8	37 5/8	79 1/8	160	32	WN60BK1-3879	\$4,284

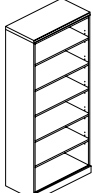


- aligns with overheads
- top and base shaped three sides
- finished, inset back panel
- five adjustable shelves
- properly secure to prevent tipping (hardware not included)
- WNOHDS1-3501 heavy duty shelf available, specify and add \$179 each
- flat cut for connection left or right end, specify and add \$753 list and indicate right or left end
- flat cut for connection on both ends available, specify and add \$1,151 list
- unfinished back panel available, specify and deduct \$139

29"h Bookcase	15 7/8	37 5/8	28 3/4	82	12	WN60BK1-3829	\$2,494
---------------	--------	--------	--------	----	----	--------------	---------

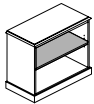


- aligns with worksurface
- top and base shaped three sides
- finished, inset back panel
- one adjustable shelf
- properly secure to prevent tipping (hardware not included)
- WNOHDS1-3501 heavy duty shelf available, specify and add \$179 each
- flat cut for connection left or right end, specify and add \$753 list and indicate right or left end
- flat cut for connection on both ends available, specify and add \$1,151 list
- unfinished back panel available, specify and deduct \$72

Description	D	W	H	CTN WT	CU FT	① Model	List Price
	15 7/8	35 7/8	84	168	34	GP60BK8-3684	\$4,172
	15 7/8	35 7/8	72	159	29	GP60BK8-3672	\$3,815
	15 7/8	35 7/8	60	130	24	GP60BK8-3660	\$3,369
	15 7/8	35 7/8	48	111	20	GP60BK8-3648	\$2,841
	15 7/8	35 7/8	36	101	15	GP60BK8-3636	\$2,541
	15 7/8	35 7/8	30	87	13	GP60BK8-3630	\$2,265

- top and base shaped front only
- finished, inset back panel
- properly secure to prevent tipping (hardware not included)
- GPOHDS1-3501 heavy duty shelf available, specify and add \$179 list each
- unfinished back panel available -3684, -3672, 3660, specify and deduct \$139 list, -3648, -3636, -3630 specify and deduct \$72 list
- -3684 six adjustable shelves
- -3672 five adjustable shelves
- -3660 four adjustable shelves
- -3648 three adjustable shelves
- -3636 two adjustable shelves
- -3630 one adjustable shelf

Heavy Duty Shelf	13 1/4	34 1/2	1	15	1	GPOHDS1-3501	\$286
------------------	--------	--------	---	----	---	--------------	-------

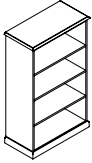


WALDEN

To Order, Specify:

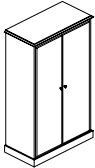
- ① Model Number
- ② Wood Species - Cherry (CH1) or Walnut (WA1)
(see page [WN15](#))
- ③ Finish Color - (see page [WN15](#))

Description	D	W	H	CTN WT	CU FT	① Model	List Price
Open Storage Cabinet	15 7/8	31 5/8	53	155	19	WN6TOB1-3253	\$3,627

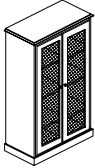


- top and base shaped three sides
- three adjustable shelves

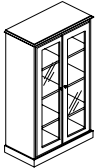
Storage Cabinet with Doors	15 7/8	31 5/8	53	186	19	WN6TDB1-3253	\$4,841
----------------------------	--------	--------	----	-----	----	--------------	---------



wood doors



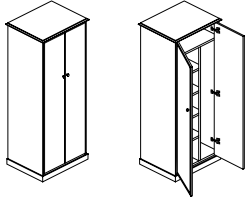
grilled mesh doors



glass doors

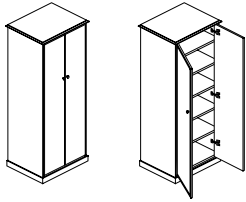
- top and base shaped three sides
- three adjustable shelves
- walden molding available on wood doors, specify and add \$246 list
- grilled mesh or glass doors available, specify and add \$216 list
- glass shelves available, specify and add \$344 list
- locking doors available, specify and add \$142 list

Description	D	W	H	CTN WT	CU FT	① Model	List Price
Storage Wardrobe Cabinet	24 5/8	37 5/8	79 1/8	431	51	WN6ADS3-2538	\$10,813
	24 5/8	31 5/8	79 1/8	379	43	WN6ADS3-2532	\$9,837



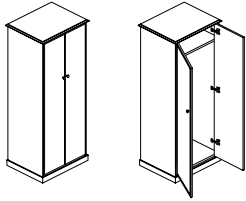
- top and base shaped three sides
- fixed shelf in wardrobe
- coat hook in wardrobe
- four adjustable shelves
- locking doors available, specify and add \$142 list
- flat cut for connection left or right end, specify and add \$753 list and indicate right or left end
- flat cut for connection on both ends available, specify and add \$1,151 list
- -2538 shelf compartment: 22 5/8"w
- -2532 shelf compartment: 17 5/8"w
- -2538 wardrobe compartment: 11 1/8"w
- -2532 wardrobe compartment: 10 1/8"w

Storage Cabinet	24 5/8	37 5/8	79 1/8	422	51	WN6ADS2-2538	\$10,282
	24 5/8	31 5/8	79 1/8	367	43	WN6ADS2-2532	\$9,628



- top and base shaped three sides
- one fixed shelf
- four adjustable shelves
- locking doors available, specify and add \$142 list
- flat cut for connection left or right end, specify and add \$753 list and indicate right or left end
- flat cut for connection on both ends available, specify and add \$1,151 list

Wardrobe Cabinet	24 5/8	37 5/8	79 1/8	357	51	WN6ADS1-2538	\$9,534
	24 5/8	31 5/8	79 1/8	314	43	WN6ADS1-2532	\$8,899

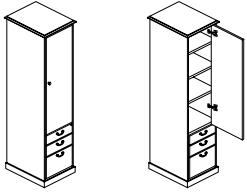


- top and base shaped three sides
- one adjustable shelf
- hanging bar
- locking doors available, specify and add \$142 list
- flat cut for connection left or right end, specify and add \$753 list and indicate right or left end
- flat cut for connection on both ends available, specify and add \$1,151 list

To Order, Specify:

- ① Model Number
- ② Wood Species - Cherry (CH1) or Walnut (WA1)
(see page [WN15](#))
- ③ Finish Color - (see page [WN15](#))
- ④ Pull Color - (see page [WN15](#))

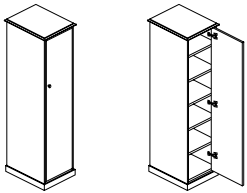
Description	D	W	H	CTN WT	CU FT	① Model	List Price
Storage Cabinet - Box/Box/File	24 5/8	19 5/8	79 1/8	258	28	WN6DDS2R-2520	\$6,241
	24 5/8	19 5/8	79 1/8	258	28	WN6DDS2L-2520	\$6,241



right shown

- top and base shaped three sides
- one fixed shelf
- two adjustable shelves
- pedestal front locking
- wood drawers standard, v-fold drawers available, specify and deduct \$60
- locking door available, specify and add \$142 list
- flat cut for connection left or right end, specify and add \$753 list and indicate right or left end
- flat cut for connection on both ends available, specify and add \$1,151 list

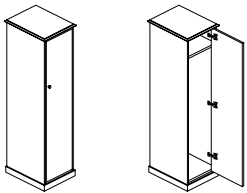
Storage Cabinet	24 5/8	19 5/8	79 1/8	242	28	WN6ADS2R-2520	\$5,343
	24 5/8	19 5/8	79 1/8	242	28	WN6ADS2L-2520	\$5,343



right shown

- top and base shaped three sides
- one fixed shelf
- four adjustable shelves
- locking door available, specify and add \$142 list
- flat cut for connection left or right end, specify and add \$753 list and indicate right or left end
- flat cut for connection on both ends available, specify and add \$1,151 list

Wardrobe Cabinet	24 5/8	19 5/8	79 1/8	211	28	WN6ADS1R-2520	\$4,990
	24 5/8	19 5/8	79 1/8	211	28	WN6ADS1L-2520	\$4,990



right shown

- top and base shaped three sides
- one fixed shelf
- hanging bar
- locking door available, specify and add \$142 list
- flat cut for connection left or right end, specify and add \$753 list and indicate right or left end
- flat cut for connection on both ends available, specify and add \$1,151 list

Description	D	W	H	CTN WT	CU FT	① Model	List Price
Four Drawer Lateral File	24 5/8	37 5/8	54	294	35	WN6FLT1-2538	\$7,392
	24 5/8	31 5/8	54	258	30	WN6FLT1-2532	\$7,156



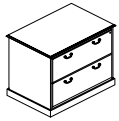
- top and base shaped three sides
- pedestal front locking
- wood drawers standard, v-fold drawers available, specify and deduct \$60
- reinforced drawer bottoms

Three Drawer Lateral File	24 5/8	37 5/8	41 3/8	231	27	WN6FLM1-2538	\$6,124
	24 5/8	31 5/8	41 3/8	203	23	WN6FLM1-2532	\$5,938



- top and base shaped three sides
- pedestal front locking
- wood drawers standard, v-fold drawers available, specify and deduct \$60
- reinforced drawer bottoms

Two Drawer Lateral File	24 5/8	37 5/8	28 3/4	169	19	WN6FLS1-2538	\$5,187
-------------------------	--------	--------	--------	-----	----	--------------	---------



- top and base shaped three sides
- pedestal front locking
- wood drawers standard, v-fold drawers available, specify and deduct \$60
- reinforced drawer bottoms
- flat cut for connection left or right end, specify and add \$753 list and indicate right or left end
- flat cut for connection on both ends available, specify and add \$1,151 list

WALDEN

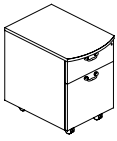
To Order, Specify:

- ① Model Number
- ② Wood Species - Cherry (CH1) or Walnut (WA1)
(see page [WN15](#))
- ③ Finish Color - (see page [WN15](#))
- ④ Pull Color - (see page [WN15](#))
- ⑤ Product Modification - (see page [WN9](#))

Product Modifications:

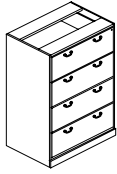
Pedestal Change - see page [WN9](#)

Description	D	W	H	CTN WT	CU FT	① Model	List Price
Mobile Box/File Pedestal	23	15 5/8	23	94	6	WN6MBP6-2316	\$2,278



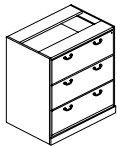
- pedestal front locking
- wood drawers standard, v-fold drawers available, specify and deduct \$60
- recessed finger pull under top overhang
- casters: front two are locking

Description	D	W	H	CTN WT	CU FT	① Model	List Price
Four Drawer Lateral without Top	24 3/8	36	52 7/8	260	32	WN7FLT1-2436	\$6,701
	24 3/8	30	52 7/8	233	27	WN7FLT1-2430	\$6,482



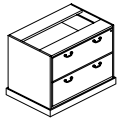
- base shaped front only
- pedestal front locking
- wood drawers standard, v-fold drawers available, specify and deduct \$60
- reinforced drawer bottoms

Three Drawer Lateral File without Top	24 3/8	36	40 1/8	202	24	WN7FLM1-2436	\$5,241
	24 3/8	30	40 1/8	177	21	WN7FLM1-2430	\$5,055



- base shaped front only
- pedestal front locking
- wood drawers standard, v-fold drawers available, specify and deduct \$60
- reinforced drawer bottoms

Two Drawer Lateral File without Top	24 3/8	37 1/8	27 3/8	136	15	WN7FLS1-2537	\$4,595
-------------------------------------	--------	--------	--------	-----	----	--------------	---------



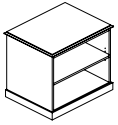
- base shaped three sides
- pedestal front locking
- wood drawers standard, v-fold drawers available, specify and deduct \$60
- reinforced drawer bottoms
- flat cut for connection left or right end, specify and add \$753 list and indicate right or left end
- flat cut for connection on both ends available, specify and add \$1,151 list

WALDEN

To Order, Specify:

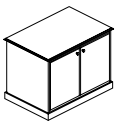
- ① Model Number
- ② Wood Species - Cherry (CH1) or Walnut (WA1)
(see page [WN15](#))
- ③ Finish Color - (see page [WN15](#))
- ④ Pull Color - (see page [WN15](#))

Description	D	W	H	CTN WT	CU FT	① Model	List Price
Open Pedestal	24 5/8	31 5/8	28 3/4	123	16	WN60TT1-2532	\$2,871



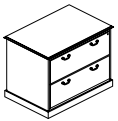
- top and base shaped three sides
- one adjustable shelf
- flat cut for connection left or right end, specify and add \$753 list and indicate right or left end
- flat cut for connection on both ends available, specify and add \$1,151 list

Hinge Door Pedestal	24 5/8	31 5/8	28 3/4	137	16	WN6HDT1-2532	\$3,625
---------------------	--------	--------	--------	-----	----	--------------	---------



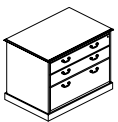
- top and base shaped three sides
- one adjustable shelf
- locking doors available, specify and add \$142 list
- flat cut for connection left or right end, specify and add \$753 list and indicate right or left end
- flat cut for connection on both ends available, specify and add \$1,151 list

File/File Pedestal	24 5/8	31 5/8	28 3/4	148	16	WN6PTM-2532	\$4,253
--------------------	--------	--------	--------	-----	----	-------------	---------



- top and base shaped three sides
- pedestal front locking
- wood drawers standard, v-fold drawers available, specify and deduct \$60
- reinforced drawer bottoms
- flat cut for connection left or right end, specify and add \$753 list and indicate right or left end
- flat cut for connection on both ends available, specify and add \$1,151 list

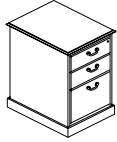
Box/Box/File Pedestal	24 5/8	31 5/8	28 3/4	149	16	WN6PTT1-2532	\$4,253
-----------------------	--------	--------	--------	-----	----	--------------	---------



- top and base shaped three sides
- pedestal front locking
- wood drawers standard, v-fold drawers available, specify and deduct \$60
- reinforced drawer bottoms
- flat cut for connection left or right end, specify and add \$753 list and indicate right or left end
- flat cut for connection on both ends available, specify and add \$1,151 list

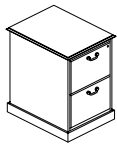
WALDEN

Description	D	W	H	CTN WT	CU FT	❶ Model	List Price
Box/Box/File Pedestal	24 5/8	19 5/8	28 3/4	109	11	WN6PTT1-2520	\$3,386



- top and base shaped three sides
- pedestal front locking
- wood drawers standard, v-fold drawers available, specify and deduct \$60
- flat cut for connection left or right end, specify and add \$753 list and indicate right or left end
- flat cut for connection on both ends available, specify and add \$1,151 list

File/File Pedestal	24 5/8	19 5/8	28 3/4	107	11	WN6PTTM-2520	\$3,386
--------------------	--------	--------	--------	-----	----	--------------	---------

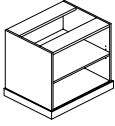


- top and base shaped three sides
- pedestal front locking
- wood drawers standard, v-fold drawers available, specify and deduct \$60
- flat cut for connection left or right end, specify and add \$753 list and indicate right or left end
- flat cut for connection on both ends available, specify and add \$1,151 list

To Order, Specify:

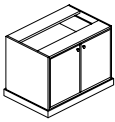
- ❶ Model Number
- ❷ Wood Species - Cherry (CH1) or Walnut (WA1)
(see page [WN15](#))
- ❸ Finish Color - (see page [WN15](#))
- ❹ Pull Color - (see page [WN15](#))
- ❺ Product Modification - (see page [WN9](#))

Description	D	W	H	CTN WT	CU FT	① Model	List Price
Open Pedestal without Top	24 5/8	31 1/8	27 5/8	91	15	WN70TN1-2531	\$2,350



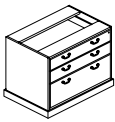
- base shaped three sides
- one adjustable shelf
- flat cut for connection left or right end, specify and add \$753 list and indicate right or left end
- flat cut for connection on both ends available, specify and add \$1,151 list

Hinge Door Pedestal without Top	24 5/8	31 1/8	27 5/8	111	15	WN7HDN1-2531	\$3,107
---------------------------------	--------	--------	--------	-----	----	--------------	---------



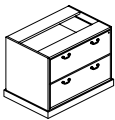
- base shaped three sides
- one adjustable shelf
- locking doors available, specify and add \$142 list
- flat cut for connection left or right end, specify and add \$753 list and indicate right or left end
- flat cut for connection on both ends available, specify and add \$1,151 list

Box/Box/File Pedestal without Top	24 3/8	31 1/8	27 5/8	122	15	WN7PTN1-2531	\$3,730
-----------------------------------	--------	--------	--------	-----	----	--------------	---------



- base shaped three sides
- pedestal front locking
- wood drawers standard, v-fold drawers available, specify and deduct \$60
- reinforced drawer bottoms
- flat cut for connection left or right end, specify and add \$753 list and indicate right or left end
- flat cut for connection on both ends available, specify and add \$1,151 list

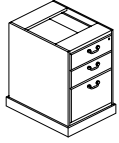
File/File Pedestal without Top	24 3/8	31 1/8	27 5/8	121	15	WN7PTNM-2531	\$3,730
--------------------------------	--------	--------	--------	-----	----	--------------	---------



- base shaped three sides
- pedestal front locking
- wood drawers standard, v-fold drawers available, specify and deduct \$60
- reinforced drawer bottoms
- flat cut for connection left or right end, specify and add \$753 list and indicate right or left end
- flat cut for connection on both ends available, specify and add \$1,151 list

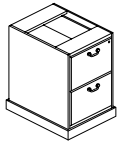
WALDEN

Description	D	W	H	CTN WT	CU FT	① Model	List Price
Box/Box/File Pedestal without Top	24 3/8	19 1/8	27 5/8	92	10	WN7PTN1-2519	\$2,775



- base shaped three sides
- pedestal front locking
- wood drawers standard, v-fold drawers available, specify and deduct \$60
- flat cut for connection left or right end, specify and add \$753 list and indicate right or left end
- flat cut for connection on both ends available, specify and add \$1,151 list

File/File Pedestal without Top	24 3/8	19 1/8	27 5/8	91	10	WN7PTNM-2519	\$2,775
--------------------------------	--------	--------	--------	----	----	--------------	---------



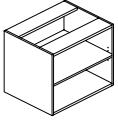
- base shaped three sides
- pedestal front locking
- wood drawers standard, v-fold drawers available, specify and deduct \$60
- flat cut for connection left or right end, specify and add \$753 list and indicate right or left end
- flat cut for connection on both ends available, specify and add \$1,151 list

To Order, Specify:

- ① Model Number
- ② Wood Species - Cherry (CH1) or Walnut (WA1)
(see page [WN15](#))
- ③ Finish Color - (see page [WN15](#))
- ④ Pull Color - (see page [WN15](#))

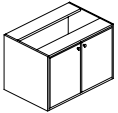
Description	D	W	H	CTN WT	CU FT	① Model	List Price
Open Pedestal without Top and Base	24 1/8	30	24 3/8	76	13	WN70TZ1-2430	\$1,821

- one adjustable shelf



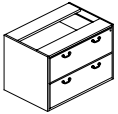
Hinge Door Pedestal without Top and Base	24 1/8	30	24 3/8	91	13	WN7HTZ1-2430	\$2,580
--	--------	----	--------	----	----	--------------	---------

- one adjustable shelf
- locking doors available, specify and add \$142 list



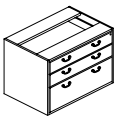
Two Drawer Lateral File without Top and Base	24 1/8	36	24 3/8	114	15	WN7FLSC-2436	\$3,997
--	--------	----	--------	-----	----	--------------	---------

- pedestal front locking
- wood drawers standard, v-fold drawers available, specify and deduct \$60
- reinforced drawer bottoms



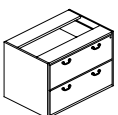
Box/Box/File Pedestal without Top and Base	24 1/8	30	24 3/8	104	13	WN7PTZ1-2430	\$3,202
--	--------	----	--------	-----	----	--------------	---------

- pedestal front locking
- wood drawers standard, v-fold drawers available, specify and deduct \$60
- reinforced drawer bottoms



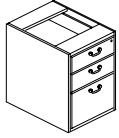
File/File Pedestal without Top and Base	24 1/8	30	24 3/8	101	13	WN7PTZM-2430	\$3,202
---	--------	----	--------	-----	----	--------------	---------

- pedestal front locking
- wood drawers standard, v-fold drawers available, specify and deduct \$60
- reinforced drawer bottoms



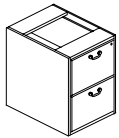
WALDEN

Description	D	W	H	CTN WT	CU FT	① Model	List Price
Box/Box/File Pedestal without Top and Base	24 1/8	18	24 3/8	79	8	WN7PTZ1-2418	\$2,393



- pedestal front locking
- wood drawers standard, v-fold drawers available, specify and deduct \$60

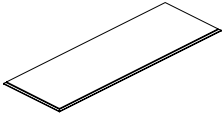
File/File Pedestal without Top and Base	24 1/8	18	24 3/8	78	8	WN7PTZM-2418	\$2,393
---	--------	----	--------	----	---	--------------	---------



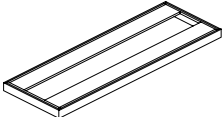
- pedestal front locking
- wood drawers standard, v-fold drawers available, specify and deduct \$60

To Order, Specify:

- ① Model Number
- ② Wood Species - Cherry (CH1) or Walnut (WA1)
(see page [WN15](#))
- ③ Finish Color - (see page [WN15](#))
- ④ Pull Color - (see page [WN15](#))

Description	D	W	H	CTN WT	CU FT	① Model	List Price
Modular Top 	24 5/8	121 5/8	1 1/8	112	6	WN7WTU1-25122	\$2,765
	24 5/8	109 5/8	1 1/8	101	6	WN7WTU1-25110	\$2,402
	24 5/8	91 5/8	1 1/8	84	5	WN7WTU1-2592	\$1,568
	24 5/8	85 5/8	1 1/8	80	6	WN7WTU1-2586	\$1,278
	24 5/8	73 5/8	1 1/8	69	4	WN7WTU1-2574	\$1,213
	24 5/8	67 5/8	1 1/8	63	3	WN7WTU1-2568	\$1,012
	24 5/8	61 5/8	1 1/8	58	3	WN7WTU1-2562	\$980
	24 5/8	55 5/8	1 1/8	52	3	WN7WTU1-2556	\$962
	24 5/8	37 5/8	1 1/8	37	2	WN7WTU1-2538	\$667
	24 5/8	31 5/8	1 1/8	31	2	WN7WTU1-2532	\$606
	24 5/8	19 5/8	1 1/8	20	1	WN7WTU1-2520	\$577

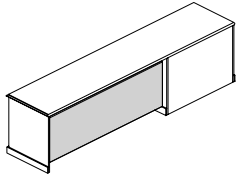
- shaped three sides
- flat cut for connection left or right end, specify and add \$753 list and indicate right or left end
- flat cut for connection on both ends available, specify and add \$1,151 list
- WN7WTU1-25122 use with four 30" modular units
- WN7WTU1-25110 use with three 36" modular units
- WN7WTU1-2592 use with three 30" modular units
- WN7WTU1-2586 use with miscellaneous units
- WN7WTU1-2574 use with two 36" or one 36" and two 18" modular units
- WN7WTU1-2568 use with miscellaneous units
- WN7WTU1-2562 use with two 30" modular units
- WN7WTU1-2556 use with three 18" modular units
- WN7WTU1-2538 use with one 36" or two 18" modular units
- WN7WTU1-2532 use with one 30" modular unit
- WN7WTU1-2520 use with one 20" modular unit

Description	D	W	H	CTN WT	CU FT	① Model	List Price
Modular Base 	24 3/8	121 3/8	3	71	10	WN7MBS1-25121	\$2,004
	24 3/8	109 3/8	3	66	8	WN7MBS1-25109	\$1,674
	24 3/8	91 3/8	3	56	7	WN7MBS1-2591	\$1,311
	24 3/8	73 3/8	3	46	6	WN7MBS1-2573	\$1,052
	24 3/8	67 3/8	3	43	5	WN7MBS1-2567	\$1,052
	24 3/8	61 3/8	3	39	5	WN7MBS1-2561	\$940
	24 3/8	55 3/8	3	37	3	WN7MBS1-2555	\$940
	24 3/8	37 3/8	3	27	3	WN7MBS1-2537	\$710
	24 3/8	31 3/8	3	24	3	WN7MBS1-2531	\$609
	24 3/8	19 3/8	3	17	2	WN7MBS1-2519	\$446

- shaped three sides
- flat cut for connection left or right end, specify and add \$753 list and indicate right or left end
- flat cut for connection on both ends available, specify and add \$1,151 list
- WN7MBS1-25121 use with four 30" modular units
- WN7MBS1-25109 use with three 36" modular units
- WN7MBS1-2591 use with three 30" modular units
- WN7MBS1-2573 use with two 36" modular units
- WN7MBS1-2567 use with one 30" and two 18" modular units
- WN7MBS1-2561 use with two 30" modular units
- WN7MBS1-2555 use with three 18" modular units
- WN7MBS1-2537 use with one 36" or two 18" modular units
- WN7MBS1-2531 use with one 30" modular unit
- WN7MBS1-2519 use with one 18" modular unit

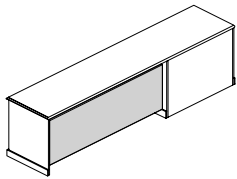
WALDEN

Description	D	W	H	CTN WT	CU FT	① Model	List Price
Modesty Panel	¾	59 ¼	24 ¾	34	3	WN7WMP1-5924	\$1,008



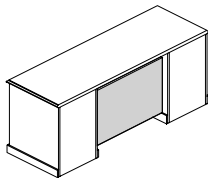
- use between an end panel and a 30" pedestal to make a 60" kneespace

Modesty Panel	¾	53 ¼	24 ¾	31	2	WN7WMP1-5324	\$949
---------------	---	------	------	----	---	--------------	-------



- use between an end panel and a 36" pedestal to make a 54" open corner kneespace

Modesty Panel	¾	30	24 ¾	18	1	WN7WMP1-3024	\$873
---------------	---	----	------	----	---	--------------	-------

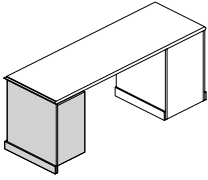


- use between two pedestals to make a 30" center kneespace

To Order, Specify:

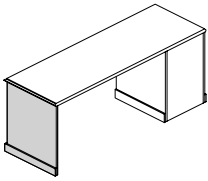
- ① Model Number
- ② Wood Species - Cherry (CH1) or Walnut (WA1)
(see page [WN15](#))
- ③ Finish Color - (see page [WN15](#))

Description	D	W	H	CTN WT	CU FT	① Model	List Price
End L-Support Panel	23 7/8	12 3/8	27 5/8	39	6	WN7WME1R-2412	\$1,119
	23 7/8	12 3/8	27 5/8	38	6	WN7WME1L-2412	\$1,119



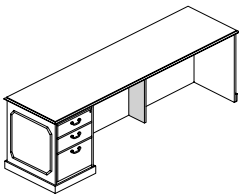
- used in making credenzas
- use without modesty panel

End Panel	23 7/8	3/4	27 5/8	27	1	WN7WME1R-2401	\$764
	23 7/8	3/4	27 5/8	27	1	WN7WME1L-2401	\$764



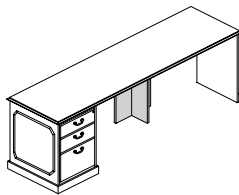
- used in making credenzas
- use with modesty panel

Center Support Panel	11	3/4	27 5/8	13	1	WN7WSC1-1101	\$713
----------------------	----	-----	--------	----	---	--------------	-------



- use to support tops spanning 48"-72"
- use with modesty

Center T-Support Panel	11 3/4	11	27 5/8	16	3	WN7WSC1-1211	\$756
------------------------	--------	----	--------	----	---	--------------	-------



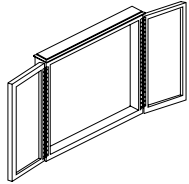
- use to support tops spanning 48"-72"
- use without modesty

WALDEN

Description	D	W	H	CTN WT	CU FT	① Model	List Price
Costumer	20	20	72	30	21	WNO CST1-2020	\$1,036

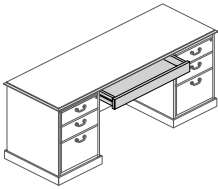


Visual Board	6 1/2	48	49 1/8	116	12	WNOVIS1-0748	\$4,205
--------------	-------	----	--------	-----	----	--------------	---------



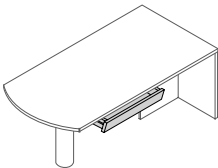
- two tackable cork panels
- porcelain magnetic non-glare writing surface
- mounted flip chart pad
- eraser and four markers
- finger grip doors
- wall mounting brackets

Straight Front Center Drawer	18 1/8	25 3/4	3 1/8	14	1	WN9CDR1-1626	\$507
------------------------------	--------	--------	-------	----	---	--------------	-------



- use with credenzas
- wood drawer
- locking available, specify and add \$142 list

Angled Front Center Drawer	17 5/8	24 1/2	2 1/2	17	1	GP9CDRC-1626	\$430
----------------------------	--------	--------	-------	----	---	--------------	-------



- use with a post style desk
- wood drawer

To Order, Specify:

- ① Model Number
- ② Wood Species - Cherry (CH1) or Walnut (WA1)
(see page [WN15](#))
- ③ Finish Color - (see page [WN15](#))

WALDEN

Walden Conference Product Information

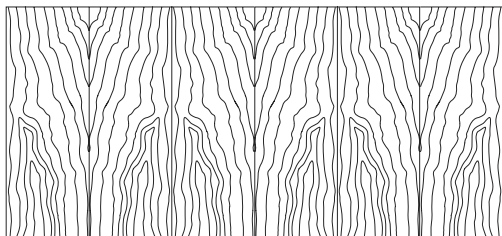


WALDEN

Walden Product Information

Exterior Wood Materials

Exterior surfaces are made from the finest selected veneers to achieve clarity and consistency in the Walden product line. To attain a pleasing, symmetrical pattern, all veneers in Walden are book-matched. All exterior solid lumber is matched to coordinate with the veneer.



Book Matched Example

Alternating pieces of veneer are flipped over so they face each other like the pages within a book.

Walden is available in flat cut cherry veneer and walnut veneer. A wide range of wood stains have been formulated to enhance the beauty of the veneer.

Work Surface Construction

Tops are 3-ply balanced construction, 1³/₁₆" thick with solid matching hardwood edges. Tops are available in federal edge style profile.

Matching or coordinating high pressure laminate in a veneer grain can be applied to the top surface and is available at no additional charge.

Base Construction

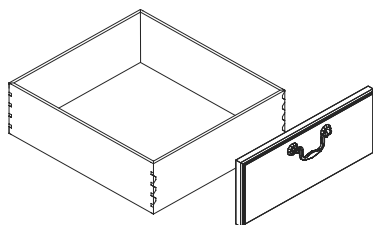
Panels are joined together by mortise and tenon construction. In addition to mortise and tenon joint construction. Leveling glides are set into solid hardwood with t-nut inserts, which helps to prevent the leveling glide from tear out. Tops are secured to the bases with top fastening cleats screwed to the inside of the panels.

Drawers

The standard Baltic Birch drawer is constructed with 1/2" thick high quality Baltic Birch plywood with a durable finish. This five sided drawer box features fully glued dovetail construction ensuring a solid, warp resistant drawer box.

Veneered bottoms are framed into grooves on four sides. Bottoms are then glued, stapled, and reinforced with a continuous band of glue.

The optional V-fold drawer interior is a 1/2" durable, miter-fold drawer system. The V-fold vinyl wrapped drawer sides form a mitered box. The box is glued and doweled, the drawer fronts attached to the box.



Drawer Suspension

The high quality black drawer suspensions carry a lifetime warranty. Slides feature steel ball bearings for longer life with cushioned in/out stops. File and box drawers have 100% full extension.

Finish - Stain/Colors

We offer a variety of wood stains and paint colors on Walden. Please see the chart below. Samples are available upon request.

CH1 Cherry	<i>Flat Cut Veneer</i>		
BBM Bourbon Medium		CLL Collectors	
BRM Brighton Medium		HRV Harvest	
CLA Classic		PRL Praline	
WA1 Walnut	<i>Flat Cut Veneer</i>		
ESP Espresso		TRF Truffle	
MCH Mocha		UMB Umber	
SIE Sienna			

Protective Top Coat

DuraTex™ offers exceptional hardness along with abrasion and impact resistance, it has been formulated to eliminate hazardous and harmful gases that are normally associated with wood finish.

DuraTex™ Features

Safety - Significantly reduces hazardous formaldehyde emissions, which help improve the quality of the of the indoor air we breathe.

Quality - Developed to be tough and durable with special attention to appearance. The DuraTex™ finish preserves the natural beauty of wood.

Durability - Designed to meet a wide range of demanding performance and environmental standards to withstand even the highest wear and tear.

Walden Product Information

Product Modification

Laminate Tops

Worksurface only, no additional upcharge if coordinating wood grain laminate is specified. Contact Customer Service for any other laminate request. Listed below are finishes that have coordinating wood grain HPL laminates.

CH1 Cherry *Flat Cut Veneer*

CLL Collectors
HRV Harvest
PRL Praline

WA1 Walnut *Flat Cut Veneer*

MCH Mocha TRF Truffle
SIE Sienna UMB Umber

Special Finishes

Special finishes can be requested by following the instruction in the general introduction section. There is a one time charge of \$372 list per order.

Finish Sheen

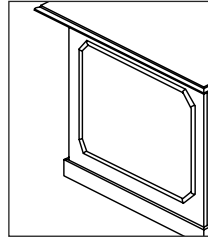
All veneer finishes, for Walden, are standard in 35-sheen. All other finishes can have their sheen modified with a 15% upcharge added to the list price of each item.

Product Modification

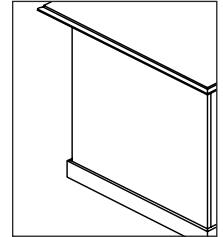
Trim Molding

Walden Trim molding is an option on all Walden products.

Walden trim molding (WDM) or without molding (WOM) can be specified at the time of order placement. Use the appropriate pricing column.



Walden Molding (WDM)



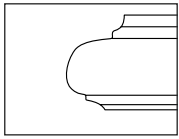
Base Molding Only (WOM)

Walden Product Information

Edge and Hardware

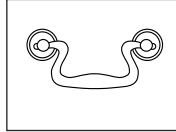
Walden offers a traditional edge profile and the Walden drawer pull in antique brass or pewter finish.

Edge Profile



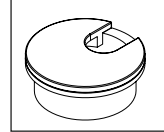
Federal Edge Profile
Accepts Laminate Top

Drawer Hardware



Walden Hardware (PJM6)
Antique Brass (ANB)
Pewter (PTR)

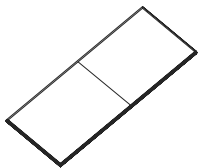
Grommet



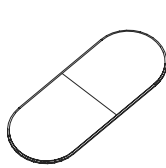
2" Dia. Antique Brass (G3A)
2" Dia. Black (G3B)

add \$114 to list price for each grommet for electrical and data accessories

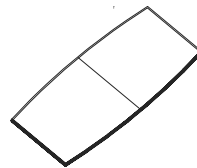
Top Shapes - size - base requirement - seating capacity top sizes 144" through 120" are 2 pieces



rectangular
144" x 60" 3 bases seats 14
144" x 48" 3 bases seats 12
120" x 48" 2-3* bases seats 8
96" x 48" 2 bases seats 8
72" x 36" 2 bases seats 6



racetrack
144" x 60" 3 bases seats 14
144" x 48" 3 bases seats 12
120" x 48" 2-3* bases seats 8
96" x 48" 2 bases seats 8
72" x 36" 2 bases seats 6



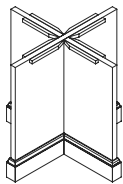
boat
144" x 48" 3 bases seats 12
120" x 48" 2-3* bases seats 8
96" x 48" 2 bases seats 8
72" x 36" 2 bases seats 6



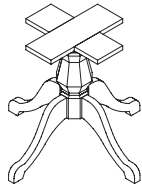
round*
60" dia. Seats 6
54" dia. Seats 6
48" dia. Seats 4
42" dia. Seats 4
36" dia. Seats 4

*requires 1 base

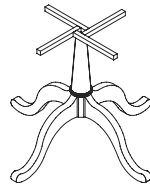
Traditional Bases for Walden



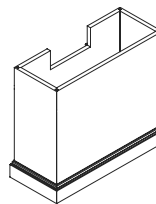
X base
25" width
29" width



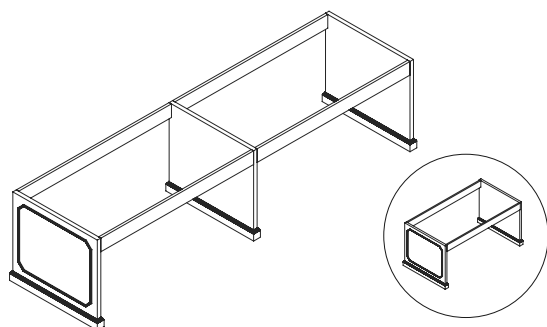
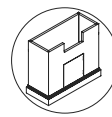
pedestal base
31" dia. span



pedestal base
38" dia. span



rectangular base
24" x 12"
30" x 12"
(access door models availability)
available with Walden molding options



panel base assembly (panels 1 1/4" thick)

base sizes	top sizes
114" x 43" width	144" x 60"
114" x 31" width	144" x 48"
90" x 31" width	120" x 48"
72" x 31" width	96" x 48"
48" x 25" width	72" x 36"

bases 114" and longer requires middle panel available with Walden molding options

WN66 Walden

Walden Product Information

Finish and Product Reference Codes

Select	Code
Veneer	
Cherry	CH1
Walnut	WA1
Finish	
Cherry Finishes	
Bourbon Medium	BBM
Brighton Medium	BRM
Classic	CLA
Collectors	CLL
Harvest	HRV
Praline	PRL

Select	Code
Finish (continued)	
Walnut Finishes	
Espresso	ESP
Mocha	MCH
Sienna	SIE
Truffle	TRF
Umber	UMB

Pull & Finishes Codes

Walden Pull-Antique Brass	ANB
Walden Pull-Pewter	PTR

Grommet Codes

2" dia. Antique Brass	G3A
2" dia. Black	G3B

Select	Code
Laminate Coordinates	
Cherry Wood Grain Patterns	
Collectors	CLL
Harvest	HRV
Praline	PRL
Walnut Wood Grain Patterns	
Mocha	MCH
Sienna	SIE
Truffle	TRF
Umber	UMB

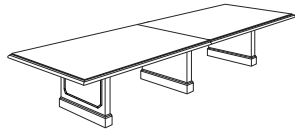
Order Check List:

Specify:

- 1. Model Number
- 2. Finish
- 3. Wood Species - cherry - walnut
- 4. Top Options - standard veneer - laminate surface (see page [WN65](#))
- 5. Pull Selection **if applicable**
- 6. Other Product Options
- 7. Power and Data Accessories (*drawing showing location and orientation must accompany order*)
- 8. Side Mark Information (*i.e. room number, East Conference Room*)
- 9. Shipping Address (*contact name and phone number*)
- 10. Special Delivery Instructions (*i.e. call before delivery, deliver to job site*)

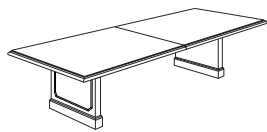
Description	D	W	H	CTN WT	CU FT	① Model	Without Molding (WOM)	Walden Molding (WDM)
-------------	---	---	---	-----------	----------	---------	--------------------------	-------------------------

Rectangular Table	48	144	29	361	51	WN8JRP4-48144	\$12,453	\$12,957
--------------------------	----	-----	----	-----	----	----------------------	-----------------	-----------------



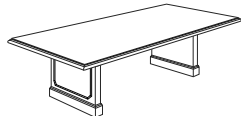
- top shaped all sides
- solid hardwood rims
- top is two sections
- ¾" h apron
- base: GP8NPT1-31114
- flat cut, book-matched vertical veneers
- panels are 1 ¼" thick
- horizontal rail is 4 ¼" h
- adjustable glides
- seats 10

Rectangular Table	48	120	29	283	24	WN8JRP4-48120	\$10,892	\$11,393
--------------------------	----	-----	----	-----	----	----------------------	-----------------	-----------------



- top shaped all sides
- solid hardwood rims
- top is two sections
- ¾" h apron
- base: GP8NPT1-3190
- flat cut, book-matched vertical veneers
- panels are 1 ¼" thick
- horizontal rail is 4 ¼" h
- adjustable glides
- seats 8

Rectangular Table	48	96	29	245	18	WN8JRP4-4896	\$9,105	\$9,611
--------------------------	----	----	----	-----	----	---------------------	----------------	----------------

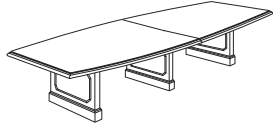


- top shaped all sides
- solid hardwood rims
- ¾" h apron
- base: GP8NPT1-3172
- flat cut, book-matched vertical veneers
- panels are 1 ¼" thick
- horizontal rail is 4 ¼" h
- adjustable glides
- seats 6 to 8

WALDEN

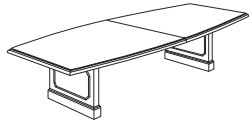
Description	D	W	H	CTN WT	CU FT	① Model	Without Molding (WOM)	Walden Molding (WDM)
-------------	---	---	---	-----------	----------	---------	--------------------------	-------------------------

Boat Shaped Table	48	144	29	369	28	WN8JBP4-48144	\$13,325	\$13,828
--------------------------	----	-----	----	-----	----	----------------------	----------	----------



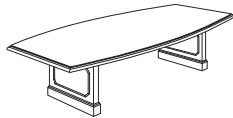
- top shaped all sides
- solid hardwood rims
- top is two sections
- ¾" h apron
- base: GP8NPT1-31114
- flat cut, book-matched vertical veneers
- panels are 1 ¼" thick
- horizontal rail is 4 ¼" h
- adjustable glides
- top size: 38/48" d
- seats 10

Boat Shaped Table	48	120	29	283	24	WN8JBP4-48120	\$11,726	\$12,230
--------------------------	----	-----	----	-----	----	----------------------	----------	----------



- top shaped all sides
- solid hardwood rims
- top is two sections
- ¾" h apron
- base: GP8NPT1-3190
- flat cut, book-matched vertical veneers
- panels are 1 ¼" thick
- horizontal rail is 4 ¼" h
- adjustable glides
- top size: 38/48" d
- seats 8

Boat Shaped Table	48	96	29	245	18	WN8JBP4-4896	\$9,914	\$10,421
--------------------------	----	----	----	-----	----	---------------------	---------	----------

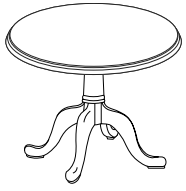


- top shaped all sides
- solid hardwood rims
- ¾" h apron
- base: GP8NPT1-3172
- flat cut, book-matched vertical veneers
- panels are 1 ¼" thick
- horizontal rail is 4 ¼" h
- adjustable glides
- top size: 38/48" d
- seats 6 to 8

To Order, Specify:

- ① Model Number
- ② Wood Species - Cherry (CH1) or Walnut (WA1)
(see page [WN64](#))
- ③ Finish Color (see page [WN64](#))
- ④ Top Option (see page [WN66](#))
- ⑤ Product Modification (see page [WN65](#))
- ⑥ Power and Data Accessories

Description	D	W	H	CTN WT	CU FT	① Model	List Price
Round Table	48	48	29	108	46	WN8JDG4-0048	\$5,655




- top shaped all sides
- solid hardwood rims
- 1 5/8" h apron
- base: GP8NTR4-0038
- 37 1/2" span between legs
- adjustable glides
- seats 4

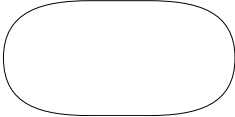
Round Table	42	42	29	82	16	WN8JDG4-0042	\$5,303
-------------	----	----	----	----	----	--------------	---------




- top shaped all sides
- solid hardwood rims
- 1 5/8" h apron
- base: GP8NFG4-0031
- 30 1/2" span between legs
- adjustable glides
- seats 4

Description	D	W	H	CTN WT	CU FT	① Model	List Price
Rectangular Top 	60	144	1 ¼	330	30	WE8CTR1-60144	\$12,105
	48	144	1 ¼	280	28	WE8CTR1-48144	\$8,914
	48	120	1 ¼	250	22	WE8CTR1-48120	\$7,127
	48	96	1 ¼	220	20	WE8CTR1-4896	\$5,835
	36	72	1 ¼	190	10	WE8CTR1-3672	\$2,975

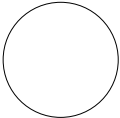
- top shaped all sides
- solid hardwood rims
- 120" and 144" tops are two sections

Racetrack Top 	60	144	1 ¼	320	30	WE8CTO1-60144	\$13,664
	48	144	1 ¼	368	28	WE8CTO1-48144	\$10,655
	48	120	1 ¼	148	22	WE8CTO1-48120	\$10,313
	48	96	1 ¼	220	20	WE8CTO1-4896	\$7,405
	36	72	1 ¼	92	10	WE8CTO1-3672	\$5,938

- top shaped all sides
- solid hardwood rims
- 1 5/8" h apron
- 120" and 144" tops are two sections

Boat Shaped Top 	48	144	1 ¼	178	28	WE8CTB1-48144	\$9,607
	48	120	1 ¼	148	22	WE8CTB1-48120	\$7,819
	48	96	1 ¼	221	20	WE8CTB1-4896	\$6,535
	36	72	1 ¼	87	10	WE8CTB1-3672	\$5,286

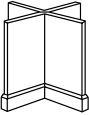

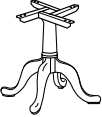
- top shaped all sides
- solid hardwood rims
- 3/4" h apron
- 120" and 144" tops are two sections
- 96" - 144" w top size: 38/48" d
- 72" w top size: 26/36" d

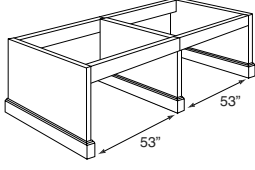
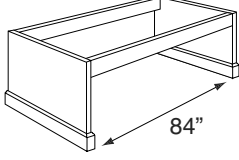
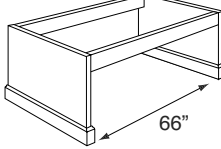
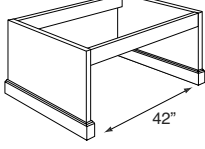
Round Top 	60	60	1 ¼	120	14	WE8CTD1-0060	\$6,152
	54	54	1 ¼	90	11	WE8CTD1-0054	\$5,381
	48	48	1 ¼	70	9	WE8CTD1-0048	\$4,505
	42	42	1 ¼	50	7	WE8CTD1-0042	\$4,151
	36	36	1 ¼	45	6	WE8CTD1-0036	\$3,973

- top shaped all sides
- solid hardwood rims

To Order, Specify:

- ① Model Number
- ② Wood Species - Cherry (CH1) or Walnut (WA1)
(see page [WN64](#))
- ③ Finish Color (see page [WN64](#))
- ④ Top Option (see page [WN66](#))
- ⑤ Product Modification (see page [WN65](#))
- ⑥ Power and Data Accessories

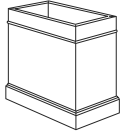
Description	D	W	H	CTN WT	CU FT	① Model	List Price
Traditional X Base  <ul style="list-style-type: none"> · hardwood solids and veneers · panels are 1 1/2" h thick · base molding is 4 3/4" · adjustable glides 	30 1/4	30 1/4	27 7/8	46	12	GP8NCR4-2929	\$3,229
	22 3/4	22 3/4	27 7/8	41	9	GP8NCR4-2525	\$3,229
Traditional Pedestal Base  <ul style="list-style-type: none"> · hardwood solids · 30 1/2" leg span · adjustable glides 	30 1/2	30 1/2	27 7/8	48	12	GP8NFG4-0031	\$1,416
Traditional Pedestal Base  <ul style="list-style-type: none"> · hardwood solids · 37 1/2" leg span · adjustable glides 	37 1/2	37 1/2	27 7/8	50	15	GP8NTR4-0038	\$3,439

Description	D	W	H	CTN WT	CU FT	① Model	Without Molding (WOM)	Walden Molding (WDM)
144" Traditional Panel Base 	43 1/4	113 3/4	27 7/8	105	15	GP8NPT1-43114	\$5,353	\$5,125
	31 1/4	113 3/4	27 7/8	95	13	GP8NPT1-31114	\$5,167	\$4,936
						<ul style="list-style-type: none"> walnut solids and veneers flat cut, book-matched vertical veneers molding only on outside end panels panels are 1 1/4" thick horizontal rail is 4 1/4" h GP8NPT1-43114 panel base with molding 43 1/4" w GP8NPT1-31114 panel with base molding 31 1/4" w adjustable glides 		
120" Traditional Panel Base 	31 1/4	89 5/8	27 7/8	60	10	GP8NPT1-3190	\$4,759	\$4,532
						<ul style="list-style-type: none"> walnut solids and veneers flat cut, book-matched vertical veneers molding only on outside end panels panels are 1 1/4" thick horizontal rail is 4 1/4" h panel with base molding 31 1/4" w adjustable glides 		
96" Traditional Panel Base 	31 1/4	71 5/8	27 7/8	53	10	GP8NPT1-3172	\$4,156	\$3,926
						<ul style="list-style-type: none"> walnut solids and veneers flat cut, book-matched vertical veneers molding only on outside end panels panels are 1 1/4" thick horizontal rail is 4 1/4" h panel with base molding 31 1/4" w adjustable glides 		
72" Traditional Panel Base 	25 1/4	47 5/8	27 7/8	47	9	GP8NPT1-2548	\$3,499	\$3,265
						<ul style="list-style-type: none"> walnut solids and veneers flat cut, book-matched vertical veneers molding only on outside end panels panels are 1 1/4" thick horizontal rail is 4 1/4" h panel with base molding 25 1/4" w adjustable glides 		

To Order, Specify:

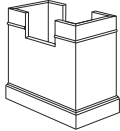
- ① Model Number
- ② Wood Species - Cherry (CH1) or Walnut (WA1)
(see page [WN64](#))
- ③ Finish Color (see page [WN64](#))
- ④ Product Modification (see page [WN65](#))

Description	D	W	H	CTN WT	CU FT	① Model	Without Molding (WOM)	Windsor (WNM)	Wellington (WLM)	Westminster (WSM)
Traditional Rectangular Base- End Unit	12	30	27 ³ / ₈	95	8	GP8NRT1-1230	\$2,370	\$2,469	\$2,633	\$2,633
	12	24	27 ³ / ₈	67	6	GP8NRT1-1224	\$2,220	\$2,292	\$2,444	\$2,444



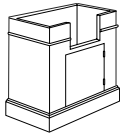
- hardwood solids and veneers
- flat cut, book-matched vertical veneers
- adjustable glides

Traditional Rectangular Base- Mid Unit	12	30	27 ³ / ₈	85	8	GP8NRTL-1230	\$2,471	\$2,574	\$2,729	\$2,729
	12	24	27 ³ / ₈	59	6	GP8NRTL-1224	\$2,314	\$2,386	\$2,535	\$2,535



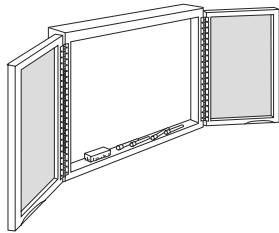
- hardwood solids and veneers
- flat cut, book-matched vertical veneers
- cut-out for wire pass-through
- adjustable glides

Traditional Rectangular Base- End Unit with Access Door	12	30	27 ³ / ₈	86	8	GP8NRTK-1230	\$2,874	\$2,976	\$3,136	\$3,136
	12	24	27 ³ / ₈	60	6	GP8NRTK-1224	\$2,687	\$2,760	\$2,909	\$2,909



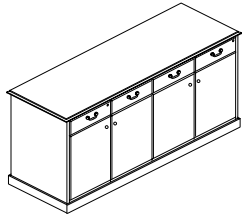
- hardwood solids and veneers
- flat cut, book-matched vertical veneers
- cut-out for wire pass-through
- adjustable glides
- access door opening: 12¹/₈" x 11⁷/₈"

Description	D	W	H	CTN WT	CU FT	① Model	List Price
Visual Board with Doors	5	48	48	135	8	GPOVIS1-0548	\$3,439



- two tackable cork panels
- porcelain magnetic non-glare writing surface
- mounted flip chart pad
- eraser and four markers
- finger grip doors
- wall mounting brackets

Meeting Room Credenza	24	71 3/8	36	330	44	MRC8072-36	\$10,092
-----------------------	----	--------	----	-----	----	------------	----------

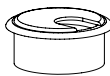
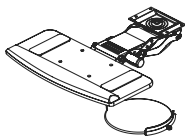


- four drawers
- top shaped all sides
- one adjustable shelf per double door
- locking doors available, specify and add \$286 list

Accessories/ Keyboard/ Tasklights

For a list of electrical units, grommets, keyboards, wire management, monitor arms & telecom jacks, please see our [accessories price list](#)

Contact your customer service representative for specific questions regarding which units can be used with Walden



To Order, Specify:

- ① Model Number
- ② Wood Species - Cherry (CH1) or Walnut (WA1)
(see page [WN64](#))
- ③ Finish Color (see page [WN64](#))
- ④ Top Option (see page [WN65](#))
- ⑤ Pull Style and Color (see page [WN66](#))
- ⑥ Product Modification (see page [WN65](#))

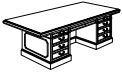
Wellington



Desks [.WE20](#)
 Reception Galleries [.WE23](#)
 Returns [.WE26](#)
 Bridges [.WE27](#)
 Credenzas [.WE28](#)
 Overhead Storage Cabinets [.WE32](#)
 Wall Mount Overhead Cabinets. [.WE34](#)
 Storage Towers. [.WE35](#)
 Bookcases. [.WE37](#)
 Modular Components [.WE40](#)
 Storage Cabinets [.WE41](#)
 Lateral Files [.WE46](#)
 Modular Components [.WE47](#)
 Center Drawer [.WE61](#)

Wellington - Overview

Desks



Double Pedestal Desk
Page [WE20](#)



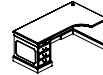
Double Pedestal Desk
Page [WE21](#)



Single Pedestal Desk
Page [WE22](#)



Single Pedestal Desk
Page [WE22](#)



Curved Single Pedestal Desk
Page [WE22](#)



Run-Off Desk with Pedestal Support
Page [WE24](#)



Run-Off Desk with Leg Support
Page [WE25](#)



Table Desk
Page [WE25](#)

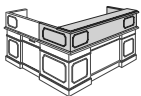


Work Table
Page [WE25](#)

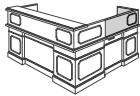


Table Desk
Page [WE25](#)

Reception Galleries



Desk Reception Gallery
Page [WE23](#)



Return Reception Gallery
Page [WE23](#)

Returns



25 3/4" d Return
Page [WE26](#)



19 3/4" d Return
Page [WE26](#)

Bridges



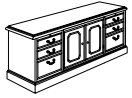
Bridge with Modesty Panel
Page [WE27](#)



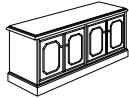
Bridge Top
Page [WE27](#)

Wellington - Overview

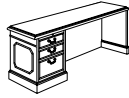
Credenzas



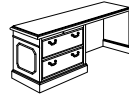
Storage Credenza
Page [WE28](#)



Hinged Door Storage Credenza
Page [WE28](#)



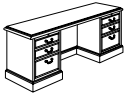
Open Corner Credenza
Page [WE29](#)



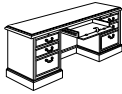
Open Corner Lateral File Credenza
Page [WE29](#)



Lateral File Credenza
Page [WE30](#)



Kneespace Credenza
Page [WE30](#)



Kneespace Credenza with Center Drawer
Page [WE30](#)



Computer/Printer Stand
Page [WE31](#)



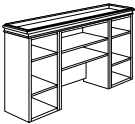
Mobile Computer/Printer Stand
Page [WE31](#)

Overhead Storage Cabinets

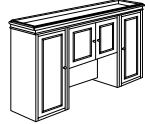


Overhead Storage Cabinet with Doors
Page [WE32](#)

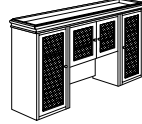
Overhead Storage Cabinets with Tower



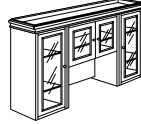
Open Overhead Storage with Tower
Page [WE32](#)



Overhead Storage with Tower and Wood Doors
Page [WE33](#)

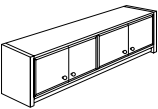


Overhead Storage with Tower and Grilled Doors
Page [WE33](#)



Overhead Storage with Tower and Glass Doors
Page [WE33](#)

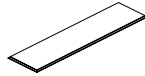
Wall Mount Overheads



Wall Mount Overhead with 4 Doors
Page [WE34](#)



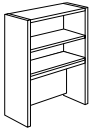
Wall Mount Overhead with 2 Doors
Page [WE34](#)



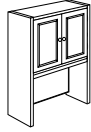
Wall Mount Storage Top
Page [WE34](#)

Wellington - Overview

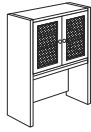
Storage Towers



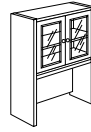
Open Bookcase
Storage Tower
Page [WE36](#)



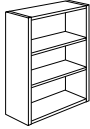
Storage Tower with
Wood Doors
Page [WE36](#)



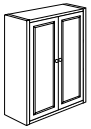
Storage Tower with
Grilled Doors
Page [WE36](#)



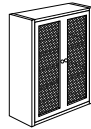
Storage Tower with
Glass Doors
Page [WE36](#)



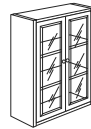
Open Bookcase
Storage Tower
Page [WE35](#)



Storage Tower with
Wood Doors
Page [WE35](#)

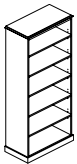


Storage Tower with
Grilled Doors
Page [WE35](#)



Storage Tower with
Glass Doors
Page [WE35](#)

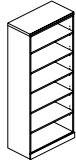
Bookcases



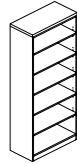
79" h Bookcase
Page [WE37](#)



29" h Bookcase
Page [WE37](#)



Bookcase
Page [WE38](#)



Bookcase
Page [WE39](#)



Heavy Duty Shelf
Page [WE39](#)

Modular Storage Components



Modular Storage Top
Page [WE40](#)



Modular Storage Base
Page [WE40](#)

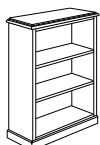


Modular Overhead
Cornice Top
Page [WE40](#)

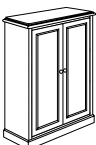


Cornice Top Filler Panel
Page [WE40](#)

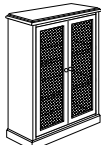
Storage Cabinet



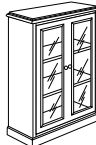
Open Storage Cabinet
Page [WE41](#)



Storage Cabinet with
Wood Doors
Page [WE41](#)



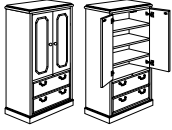
Storage Cabinet with
Grilled Doors
Page [WE41](#)



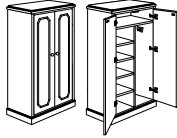
Storage Cabinet with
Glass Doors
Page [WE41](#)

Wellington - Overview

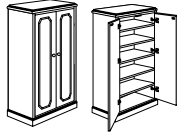
Storage/Wardrobe Cabinets



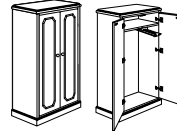
Storage Cabinet -
File/File Lateral
Page [WE42](#)



Storage Wardrobe
Cabinet
Page [WE42](#)



Storage Cabinet
Page [WE42](#)



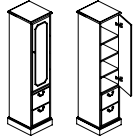
Wardrobe Cabinet
Page [WE42](#)



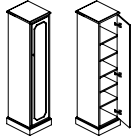
Open Storage Cabinet -
File/File Lateral
Page [WE43](#)



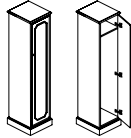
Open Storage Cabinet
Page [WE43](#)



Storage Cabinet -
File/File Lateral
Page [WE44](#)



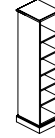
Storage Cabinet
Page [WE44](#)



Wardrobe Cabinet
Page [WE44](#)



Open Storage Cabinet -
File/File Lateral
Page [WE45](#)



Open Storage Cabinet
Page [WE45](#)

Lateral Files



Four Drawer Lateral File
Page [WE46](#)



Three Drawer Lateral File
Page [WE46](#)



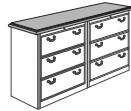
Two Drawer Lateral File
Page [WE46](#)



Four Drawer Lateral File
without Top
Page [WE47](#)



Three Drawer Lateral File
without Top
Page [WE47](#)



Lateral File Top
Page [WE47](#)

Wellington - Overview

Modular Components



Open Pedestal
Page [WE48](#)



Hinged Door Pedestal
Page [WE54](#)



Box/Box/File Pedestal
Page [WE48](#)



File/File Pedestal
Page [WE48](#)



Open Pedestal
without Top
Page [WE50](#)



Hinged Door Pedestal
without Top
Page [WE55](#)



Box/Box/File Pedestal
without Top
Page [WE50](#)



File/File Pedestal
without Top
Page [WE50](#)



Open Pedestal
without Top and Base
Page [WE52](#)



Hinged Door Pedestal
without Top and Base
Page [WE56](#)



Box/Box/File Pedestal
without Top and Base
Page [WE52](#)



File/File Pedestal
without Top and Base
Page [WE52](#)



Open Pedestal
Page [WE49](#)



Hinged Door Pedestal
Page [WE54](#)



Box/Box/File Pedestal
Page [WE49](#)



File/File Pedestal
Page [WE49](#)



Open Pedestal
without Top
Page [WE51](#)



Hinged Door Pedestal
without Top
Page [WE55](#)



Box/Box/File Pedestal
without Top
Page [WE51](#)



File/File Pedestal
without Top
Page [WE51](#)



Open Pedestal
without Top and Base
Page [WE53](#)



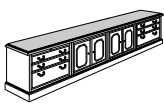
Hinged Door Pedestal
without Top and Base
Page [WE56](#)



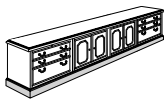
Box/Box/File Pedestal
without Top and Base
Page [WE53](#)



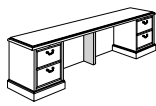
File/File Pedestal
without Top and Base
Page [WE53](#)



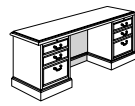
Modular Credenza Top
Page [WE57](#)



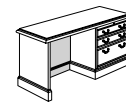
Modular Credenza Base
Page [WE58](#)



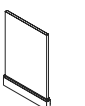
Modular Center
Support Panel
Page [WE59](#)



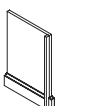
Modular Modesty Panel
Page [WE59](#)



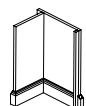
Modular Modesty Panel
Page [WE59](#)



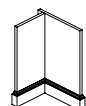
Modular End Panel
Page [WE60](#)



Modular End Panel
Page [WE60](#)



End L-Support Panel
Page [WE60](#)



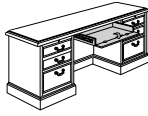
End L-Support Panel
Page [WE60](#)

Wellington - Overview

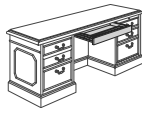
Accessories



Castomer
Page [WE61](#)



Keyboard Drawer with
Flip Down Front
Page [WE61](#)

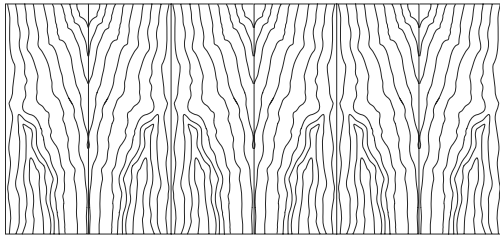


Center Drawer
Page [WE61](#)

Wellington Product Information

Exterior Wood Materials

Exterior surfaces are made from the finest selected veneers to achieve clarity and consistency in the Wellington product line. To attain a pleasing, symmetrical pattern, all veneers in Wellington are book-matched. All exterior solid lumber is matched to coordinate with the veneer.



Alternating pieces of veneer are flipped over so they face each other like the pages within a book.

Wellington is available in flat cut cherry and walnut veneer. A wide range of wood stains have been formulated to enhance the beauty of the veneer.

Work Surface Construction

Tops are 3-ply balanced construction, 1 3/8" thick with solid matching hardwood edges.

Coordinating high pressure laminate in a veneer grain pattern can be applied to the top surface and is available at no additional charge.

Top can be routed to accept 3 piece leather inlay.

Case Construction

All construction is full mortise and tenon.

Some panels are 7/8" and others are 1 3/16" thick. All panels are 3-ply construction. End panels and pedestal back panels are mitered and lock jointed together on approach side of desk.

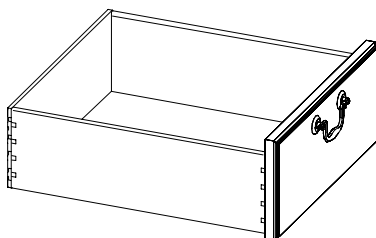
Pedestals are enclosed at bottom by a 1 1/8" framed base platform, securely fastened to panels.

Arm slides are 3-ply construction, banded on all four sides with veneer.

Drawer Construction

All drawer fronts are 5-ply construction with a hardwood core. Veneer grain runs in a vertical direction. Drawer sides and backs are solid wood with top edges of sides completely rounded. Drawers are joined at front using a French dovetail and the back by an English dovetail. Veneered bottoms are framed into grooves on four sides and glued. All drawer interiors are finished with special toner and covered with a clear coat. Drawer bottoms are sanded and hand-rubbed.

All drawer bottoms are glued, stapled and reinforced with hand-fitted glue blocks.



Drawer Suspension

The high quality black drawer suspensions carry a lifetime warranty. Slides feature steel ball bearings for longer life with cushioned in/out stops. All drawers, including file and box drawers, fully extend past the pedestal chassis allowing full access to the drawer box.

Filing Hardware

All file drawers are constructed with a custom designed filing system in place to allow for hanging folders. Filing diagram on pages [WE16-WE17](#).

Locking

Locking is standard in all desks, credenzas and modular units. Door locks are available as an option.

Units are shipped randomly keyed as standard. Key alike units are available upon request for no additional charges. Removable cores for in-field re-keying are standard.

Finish - Stain/Colors

We offer a variety of wood stains and paint colors on Wellington. Please see the chart below. Samples are available upon request.

CH1	Cherry	<i>Flat Cut Veneer</i>		
BBM	Bourbon Medium		CLL	Collectors
BRM	Brighton Medium		HRV	Harvest
CLA	Classic		PRL	Praline
WA1	Walnut	<i>Flat Cut Veneer</i>		
ESP	Espresso		TRF	Truffle
MCH	Mocha		UMB	Umber
SIE	Sienna			

Protective Top Coat

DuraTex™ offers exceptional hardness along with abrasion and impact resistance, it has been formulated to eliminate hazardous and harmful gases that are normally associated with wood finish.

DuraTex™ Features

Safety - Significantly reduces hazardous formaldehyde emissions, which help improve the quality of the indoor air we breathe.

Quality - Developed to be tough and durable with special attention to appearance. The DuraTex™ finish preserves the natural beauty of wood.

Durability - Designed to meet a wide range of demanding performance and environmental standards to withstand even the highest wear and tear.

Wellington Product Information

Product Modification

Laminate Tops

Worksurface only, no additional upcharge if Wellington's coordinating wood grain laminate is specified. Contact Customer Service for any other laminate request. Listed below are finishes that have coordinating wood grain HPL laminates.

CH1 Cherry *Flat Cut Veneer*

- CLL Collectors
- HRV Harvest
- PRL Praline

WA1 Walnut *Flat Cut Veneer*

- MCH Mocha
- SIE Sienna
- TRF Truffle
- UMB Umber

Special Finishes

Special finishes can be requested by following the instruction in the general introduction section. There is a one time charge of \$372 list per order.

Finish Sheen

All veneer finishes, for Wellington, are standard in 35-sheen. All other finishes can have their sheen modified with a 15% upcharge added to the list price of each item.

Special Veneer

Upon request standard veneer can be changed to a special veneer contact Customer Service for availability and pricing.

Adjusting Sizes

All charges are to be added to the list price of the unit. All size adjustment need approval by JSI Engineering, contact Customer Service.

Re-size standard tops or bases (shorter or narrower)	\$567
Flat cut or reverse shaped tops	\$618

Modesty panels special lengths:	
Up to 40"	\$857
40" to 60"	\$1,491

Picture Frame Molding (unlisted option)

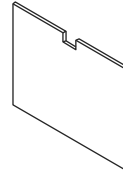
Windsor (WNM)	\$55 per panel
Wellington (WLM)	\$55 per panel
Westminster (WSM)	\$55 per panel

Other Modifications

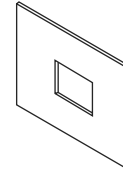
Lateral File Drawer Reinforcement	\$217
-----------------------------------	-------

Access Slots

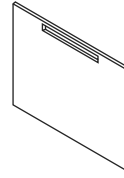
- Wire management access in back panel (2 3/4" x 1 1/4") \$466
- Wall access in back panel (10" x 12", 10" from floor) \$490
- Printer access in top or back panel (17 3/16" x 1 3/16") \$548



Wire Management Access



Wall Access



Printer

FSC- Certified Materials

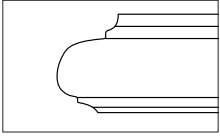
Wellington can be built using FSC-certified material call Customer Service for quotes.

Wellington Product Information

Edge and Hardware

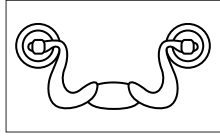
Wellington is available with the Federal Edge Profile and two hardware options. Each hardware is available in antique or burnished brass.

Edge Profile

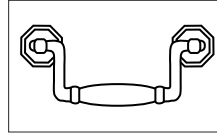


Federal Edge Profile
Accepts Laminate Top

Drawer Hardware



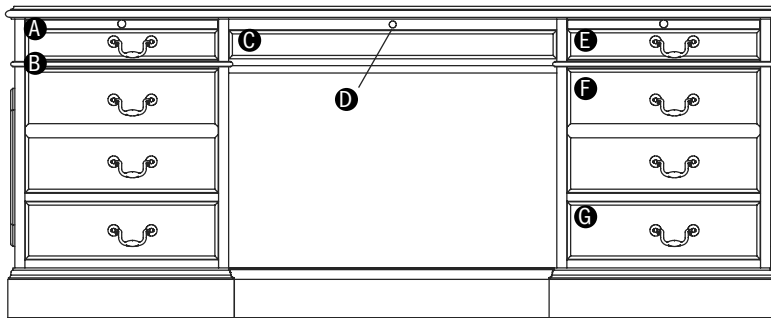
Wellington Hardware
Antique Brass (ANB)
Burnished Brass (BBR)



Windsor Hardware
Burnished Brass (BBR)

Drawer Pedestals

Wellington has unique construction on the pedestals as described below. Space does not allow for file-file configuration.



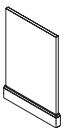
Pedestal Configuration

- A** Pedestal Writing Shelf
- B** Horizontal Trim Molding (*molding can be eliminated*)
- C** Center Drawer (*with pen tray*)
- D** Central Locking (*locks all drawers*)
- E** Top Tray Drawer
- F** Center File Drawer (*front made as two box drawers*)
- G** Lower Box Drawer

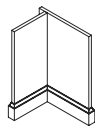
End Support Components

Wellington offers end support components that can be used with other modular items to create modular freestanding applications.

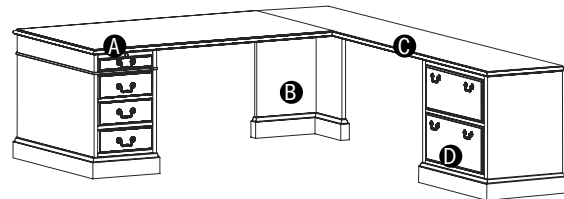
Note: Spans 48" or greater requires a support rail



End Panel Support PE8028
Use as support for modular credenza configuration

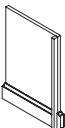


End L-Panel Support PELF8028R (*right shown*)
Use as additional support for either freestanding credenza or when connecting run-off desk to modular credenza configuration.

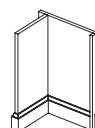


Example 1

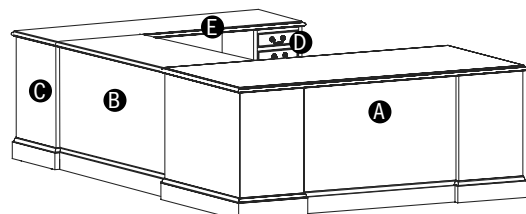
- A** PRR8066L Run-Off Desk
- B** PELF8028L End L-Support
- C** TU8091 Modular Top
- D** FD8031N File/File Pedestal



End Panel Support PE8028R (*right shown*)
Use as support for modular credenza configuration when connecting to a return or a bridge.



End L-Panel Support PELC8028R (*right shown*)
Use as additional support for modular credenza configuration and connecting to return or bridge.



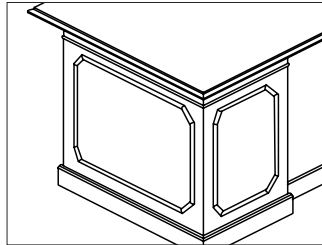
Example 2

- A** SPR8066L Single Ped. Desk
- B** EU8048 Bridge
- C** PELC8028L End L-Support
- D** F8020N Box/Box/File Pedestal
- E** TU8066 Modular Top

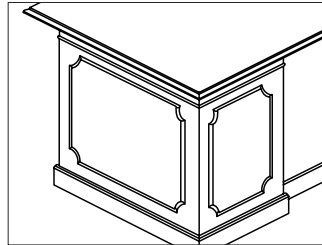
Wellington Product Information

Picture Frame Molding

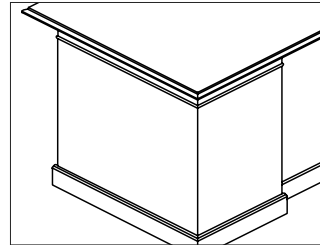
Wellington desks, credenzas and overhead storage may be specified with picture frame molding. Desks feature this molding on the back and side of the pedestal, and the outside of the end panel. Molding on the returns are located on the side and back of the pedestal. Overhead storage features molding on wood doors only..



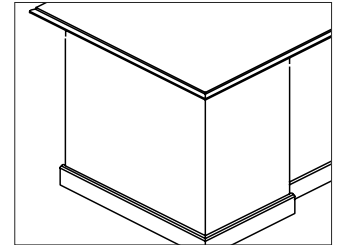
Wellington Molding
Use **WLM** pricing column



Westminster Molding
Use **WSM** pricing column



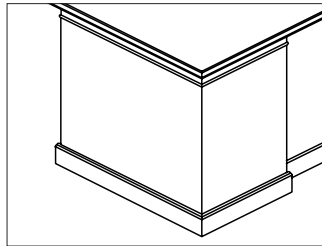
Windsor Molding
Use **WNM** in pricing column



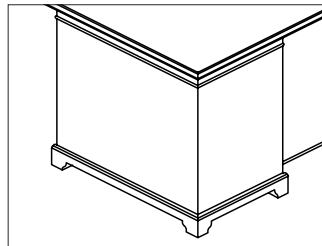
No Molding
WOM in pricing column (when available)

Base & Leg Options

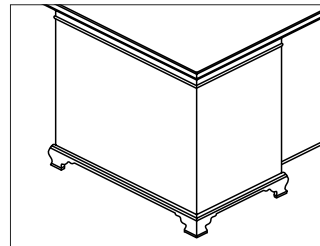
Wellington units feature a standard traditional style base molding. The Bracket Base and Georgian Feet are available on Wellington desks, credenzas, returns, bookcases, lateral files and wardrobes. Connecting units must always have the same base style. Modesty panels on returns and bridges may be specified without base molding to coordinate with the Bracket Base and Georgian Feet styles. Table desks are standard with the fluted leg.



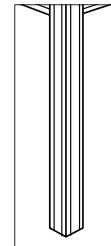
Standard Base



Bracket Base Option
Add \$805 list for double pedestal desk, single pedestal desk and open corner credenzas.
Add \$686 list for kneespace credenzas.
Add \$378 list for run-off desks, returns, storage credenzas, bookcases with bases, wardrobes and pedestal units with base.
Add \$292 list for non-handed pedestal ends.



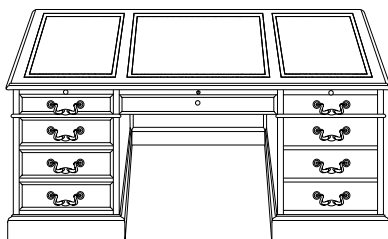
Georgian Feet
Add \$900 list for double pedestal desks, kneespace credenzas and storage credenzas over 72" w.
Add \$865 list for single pedestal desks, run-off desks, returns, storage credenzas 71" w and less, open corner credenzas, bookcases with bases, wardrobes and pedestal units with base.
Add \$336 list for non-handed pedestal ends.



Fluted Leg

3-Piece Leather Inlay

The prestige of Wellington can be enhanced with a 3-Piece Leather Inlay, which may be added to the worksurface of any freestanding desk for a \$2,687 upcharge to list price.



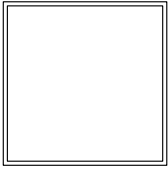
Cortina Leather Options
Caprone
Old English

Leather Inlay is limited to specific style and thickness of leather.
Call Customer Service for more information.
Visit jsifurniture.com for leather colors.

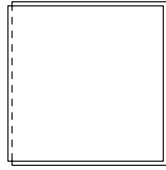
Wellington Product Information

Edge Shaping

Freestanding desks and storage units such as credenzas and overheads are shaped all sides. Run-Off desks, returns, and bridges use a combination of shaped sides and reverse shaped sides.



Shaped All Sides
Freestanding Desks
Storage Units



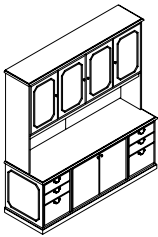
Shaped 3 Sides with Reverse Shape on Connecting End
Run-Off Desks and Returns



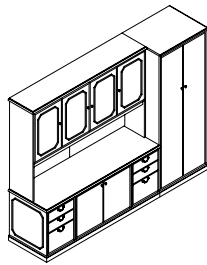
Shaped 2 Sides with Reverse Shape or Flat Cut on Connecting Ends
Bridges

Flat Cut Option

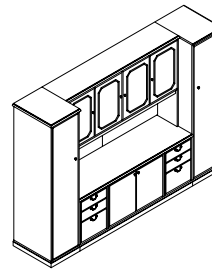
Storage units have the option to have the left, right or both sides flat cut to allow for flush alignment against other units. Handedness is determined when facing the front of the unit. See pricing pages for additional charges.



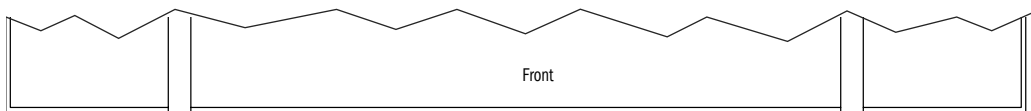
Shape Front and Both Side



Flat Cut



Flat Cut
(see details below)



Flat Cut Right (FER)

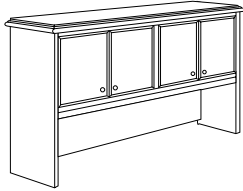
Flat Cut Both Sides (FEB)

Flat Cut Left (FEL)

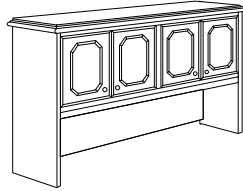
Wellington Product Information

Picture Frame Molding

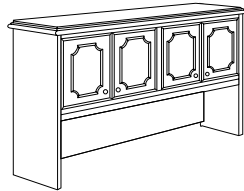
Door options for the BOS8069 overhead storage may be specified without molding (WOM), with Wellington molding (WLM), or with Westminster molding (WSM).



No Molding (WOM)
Standard



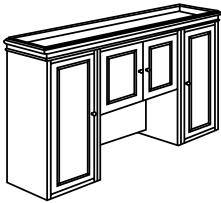
Wellington Molding (WLM)
Add \$494 to the list price



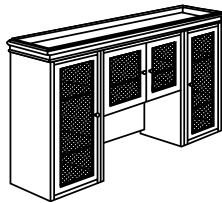
Westminster Molding (WSM)
Add \$494 to the list price

Door Styles

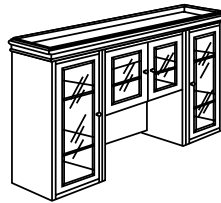
Door styles for overhead storage units are determined by the specific model number and include wood doors with inset detail, grilled doors, and beveled glass doors. Open storage units without doors are also available.



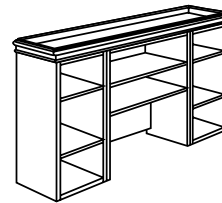
Wood Doors
with Inset Details



Grilled Doors



Clear Glass Doors
(not low iron)



Open Storage

Wellington Product Information

Worksurface Grommets



G3A - 2"
Antique Brass
G3R - 2"
Burnished Brass

Worksurface grommets can be specified on desk, bridges and credenzas. Grommet locations are indicated below with an (A) for left, (B) for center and (C) for left.

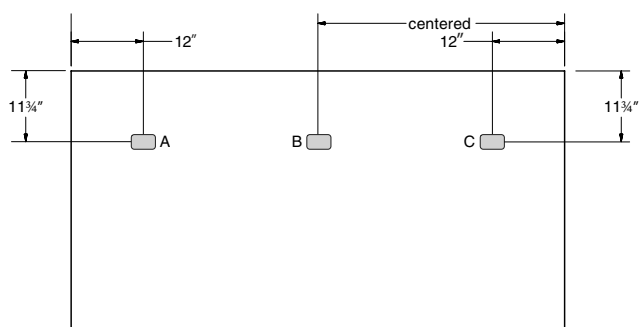
Add \$114 to the list for each additional grommet.

Grommet color must be specified, select Antique Brass or Burnished Brass choose one color for all grommets. If no color is selected, grommet color will coordinate with the pull color. Lock cores will coordinate with grommet color

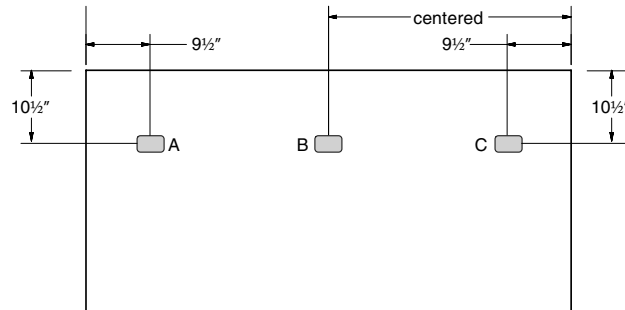
Antique Brass (G3A)

Burnished Brass (G3R)

82"w Double Pedestal Conference Desk



72"w Double Pedestal Conference Desk



Double Pedestal Desk with Dictation Slide

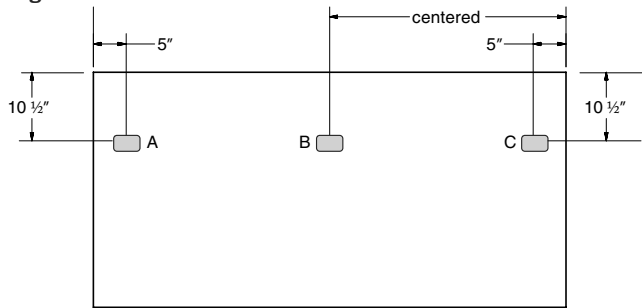


Note: Grommet not recommended over pedestal, contact Customer Service for other locations.

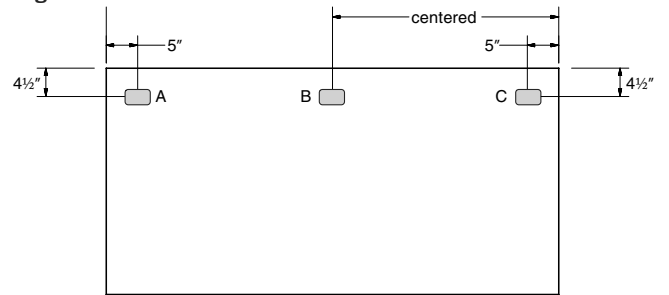
Wellington Product Information

Worksurface Grommets Continued

Single Pedestal Conference Desk

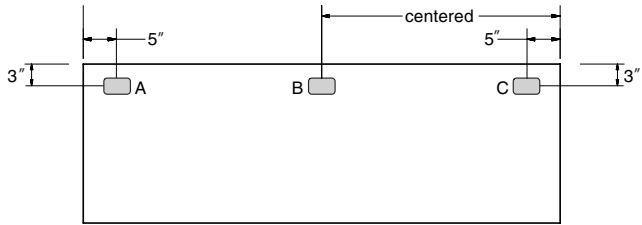


Single Pedestal Desk and Table Desk without Dictation Slides



Bridge Tops and Credenza Modular Storage Tops

Center (B) grommet is not available when unit has a center panel.



Note: Grommet not recommended over pedestal, contact Customer Service for other locations.

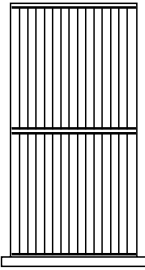
Wellington Product Information

Standard Filing Option

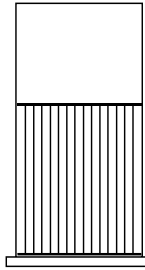
18" w Desk Pedestal

Drawer Size: 14 ¹⁵/₁₆" w x 22 ³/₄" d
Used on 36" x 66" desks

Drawer Size: 16 ¹⁵/₁₆" w x 26 ³/₄" d
Used on 82" w conference desks



Letter
Side to Side

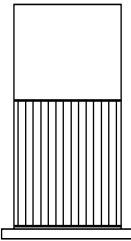


Legal
Side to Side

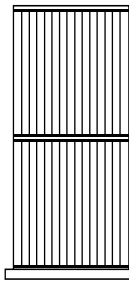
16" w Desk Pedestal

Drawer Size: 12 ¹⁵/₁₆" w x 22 ³/₄" d
Used on 30" deep desk

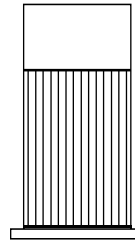
Drawer Size: 12 ¹⁵/₁₆" w x 26 ³/₄" d
Used on 82" w conference desks



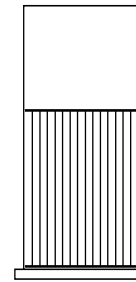
Letter
30" Deep Desk
Side to Side



Letter
36" Deep Desk
Side to Side



Legal
30" Deep Desk
Side to Side

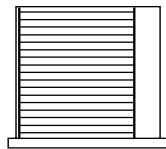


Legal
36" Deep Desk
Side to Side

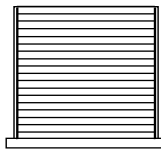
20" w Return and Credenza Pedestal

Drawer Size: 16 ¹⁵/₁₆" w x 15 ⁵/₈" d
Used on credenza and 20" deep returns

Drawer Size: 16 ¹⁵/₁₆" w x 18 ³/₄" d
Used on 20" deep returns



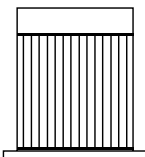
Letter
Front to Back



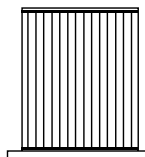
Legal
Front to Back

18" w Credenza Pedestal

Drawer Size: 13 ⁹/₁₆" w x 15 ⁵/₈" d
Used on open corner credenzas
and curved single pedestal desks



Letter
Side to Side

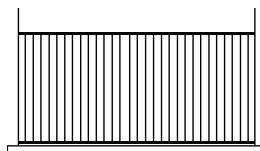


Legal
Side to Side

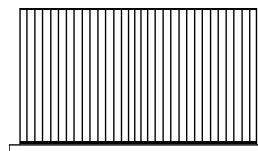
2-Drawer Lateral Files

Drawer Size: 26 ¹¹/₁₆" w x 15 ⁵/₈" d
Used 30" wide lateral files

Drawer Size: 33 ¹/₈" w x 16" d



Letter
Side to Side

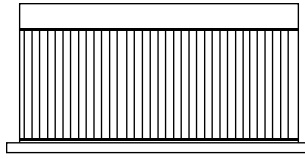


Legal
Side to Side

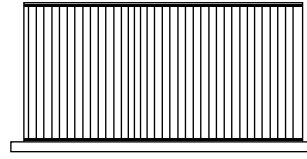
Wellington Product Information

3 and 4 Drawer Lateral Files

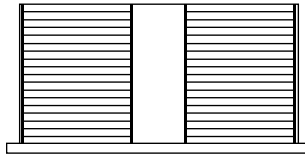
Drawer Size: 34 15/16" w x 16 3/4" d



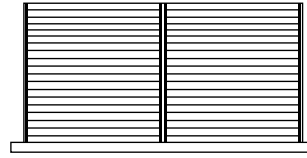
Letter
Double Side to Side



Legal
Side to Side



Letter
Double Front to Back



Letter/Legal
Double Front to Back

Wellington Product Information

Finish and Product Reference Codes

Select Code

Veneer

Cherry	CH1
Walnut	WA1

Finish

Cherry Finishes

Brighton Medium	BRM
Bourbon Medium	BBM
Classic	CLA
Collectors	CLL
Harvest	HRV
Praline	PRL

Walnut Finishes

Espresso	ESP
Mocha	MCH
Sienna	SIE
Truffle	TRF
Umber	UMB

Laminate Coordinates

Cherry Finishes

Collectors	CLL
Harvest	HRV
Praline	PRL

Walnut Finishes

Mocha	MCH
Sienna	SIE
Truffle	TRF
Umber	UMB

Select Code

Top Edge Profile

Federal

Hardware/Finish

Wellington

Antique Brass ANB

Burnished Brass BBR

Windsor

Burnished Brass BBR

Base/Feet

Standard (Baseboard)

Bracket Style Base *see page 147 price add-on*

Georgian Feet *see page 147 price add-on*

Trim

No Trim Molding WOM *(desk & ovhd)*

Wellington Molding WLM *(desk & ovhd)*

Westminster Molding WSM *(desk & ovhd)*

Windsor Molding WNM *(desk only)*

Top Grommet Finish

2" dia. Antique Brass G3R

2" dia. Burnished Brass G3A

Door Locks

Locks LCY

Without Locks LCN

Flat Cut

Left Flat FEL

Right Flat FER

Left and Right Flat FEB

No Flat Cut NFE

Overhead Cabinet

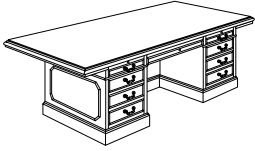
Doors

Wood Panel in Wood Frame

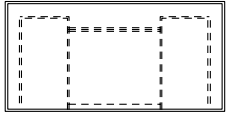
Grilled Mesh in Wood Frame

Clear Bevel Glass in Wood Frame

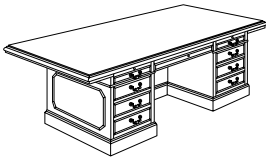
Description	D	W	H	CTN WT	CU FT	① Model	Windsor (WNM)	Wellington (WLM)	Westminster (WSM)
82"w Double Pedestal Desk	43	82	29	450	69	CF8082	\$10,792	\$11,298	\$11,298



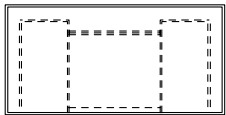
- top shaped all sides
- 18"w personal/file/box pedestal
- file drawer styled as two box drawers
- center drawer
- arm slide writing shelf
- central locking
- 3-piece leather inlay available, specify color and add \$2,687 list
- chassis size: 66" x 36"
- kneespace width: 30 1/4"
- kneespace height: 24 3/8"
- 7" overhang on approach side



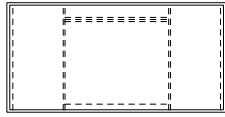
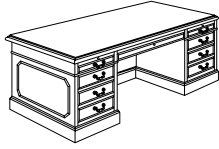
72"w Double Pedestal Desk	36	72	29	365	52	CF8072	\$9,287	\$9,792	\$9,792
---------------------------	----	----	----	-----	----	--------	---------	---------	---------



- top shaped all sides
- 16"w personal/file/box pedestal
- file drawer styled as two box drawers
- center drawer
- arm slide writing shelf
- central locking
- 3-piece leather inlay available, specify color and add \$2,687 list
- chassis size: 60" x 30"
- kneespace width: 26 1/4"
- kneespace height: 24 3/8"
- 6" overhang on approach side

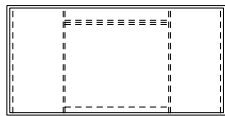
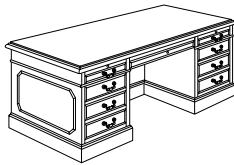


Description	D	W	H	CTN WT	CU FT	① Model	Windsor (WNM)	Wellington (WLM)	Westminster (WSM)
72" w Double Pedestal Desk	36	72	29	444	52	F8072	\$10,046	\$10,550	\$10,550



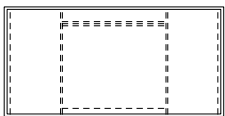
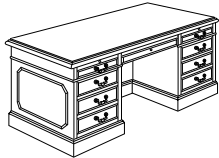
- top shaped all sides
- 20" w personal/file/box pedestal
- file drawer styled as two box drawers
- center drawer
- slide-out writing shelf, approach side
- arm slide writing shelf, user side
- central locking
- 3-piece leather inlay available, specify color and add \$2,687 list
- kneespace width: 30 1/4"
- kneespace height: 24 3/8"

66" w Double Pedestal Desk	36	66	29	420	48	F8066	\$8,748	\$9,253	\$9,253
----------------------------	----	----	----	-----	----	-------	---------	---------	---------



- top shaped all sides
- 18" w personal/file/box pedestal
- file drawer styled as two box drawers
- center drawer
- slide-out writing shelf, approach side
- arm slide writing shelf, user side
- central locking
- 3-piece leather inlay available, specify color and add \$2,687 list
- kneespace width: 28 1/4"
- kneespace height: 24 3/8"

60" w Double Pedestal Desk	30	60	29	335	36	F8060-30	\$7,986	\$8,492	\$8,492
----------------------------	----	----	----	-----	----	----------	---------	---------	---------

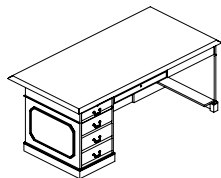


- top shaped all sides
- 16" w personal/file/box pedestal
- file drawer styled as two box drawers
- center drawer
- slide-out writing shelf, approach side
- arm slide writing shelf, user side
- central locking
- 3-piece leather inlay, specify color and add \$2,687 list
- kneespace width: 26 1/4"
- kneespace height: 24 3/8"

To Order, Specify:

- ① Model Number
- ② Wood Species - Cherry (CH1) or Walnut (WA1)
(see page WE18)
- ③ Finish Color - (see page WE18)
- ④ Molding - (see page WE18)
- ⑤ Pull Selection & Color - (see page WE18)
- ⑥ Base - (see page WE11)
- ⑦ Product Modification - (see page WE9)

Description	D	W	H	CTN WT	CU FT	① Model	Windsor (WNM)	Wellington (WLM)	Westminster (WSM)
72"w Single Pedestal Desk	36	72	29	340	52	SP8072R-36	\$9,134	\$9,512	\$9,512
	36	72	29	340	52	SP8072L-36	\$9,134	\$9,512	\$9,512

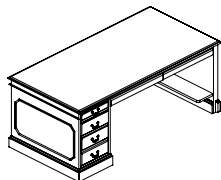


left shown



- top shaped all sides
- 16"w personal/file/box pedestal
- file drawer styled as two box drawers
- center drawer
- arm slide writing shelf
- central locking
- 3-piece leather inlay available, specify color and add \$2,687 list
- grommet available, specify and add \$114 list each; see page [WE14](#)
- kneespace width: 52"
- kneespace height: 24 3/8"
- 6" overhang on approach side

72"w Single Pedestal Desk	36	72	29	340	52	SPF8072Rx36	\$9,357	\$9,860	\$9,860
	36	72	29	340	52	SPF8072Lx36	\$9,357	\$9,860	\$9,860

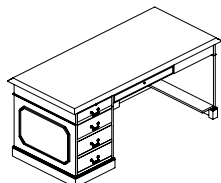


left shown



- top shaped all sides
- 16"w personal/file/box pedestal
- file drawer styled as two box drawers
- central locking
- arm slide writing shelf
- 3-piece leather inlay available, specify color and add \$2,687 list
- grommet available, specify and add \$114 list each; see page [WE14](#)
- kneespace width: 52"
- kneespace height: 24 3/8"

66"w Single Pedestal Desk	30	66	29	307	40	SP8066R	\$7,913	\$8,417	\$8,417
	30	66	29	307	40	SP8066L	\$7,913	\$8,417	\$8,417

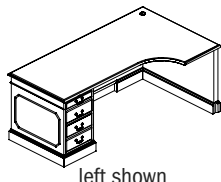


left shown

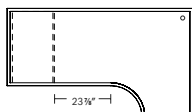


- top shaped all sides
- 16"w personal/file/box pedestal
- file drawer styled as two box drawers
- central locking
- arm slide writing shelf
- 3-piece leather inlay available, specify color and add \$2,687 list
- grommet available, specify and add \$114 list each; see page [WE14](#)
- kneespace width: 46"
- kneespace height: 24 3/8"

Curved Single Pedestal Desk	42	72	29	325	58	SPCUR8072R	\$10,641	\$11,121	\$11,121
	42	72	29	325	58	SPCUR8072L	\$10,641	\$11,121	\$11,121

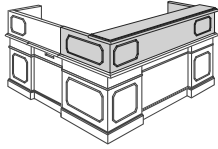


left shown



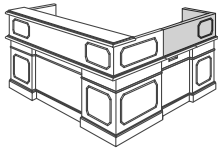
- use with 19 3/4" d bridge or return
- top shaped all sides
- 2" top grommet
- 16"w personal/file/box pedestal
- file drawer styled as two box drawers
- arm slide writing shelf
- pedestal front locking
- 3-piece leather inlay available, specify color and add \$2,687 list
- grommet available, specify and add \$114 list each; see page [WE14](#)
- depth: 42/30"

Description	D	W	H	CTN WT	CU FT	① Model	Without Molding (WOM)	Wellington (WLM)	Westminster (WSM)
Desk Reception Gallery	36	72	11 ¼	75	21	RG8072-36	\$3,500	\$4,003	\$4,003
	30	66	11 ¼	65	16	RG8066	\$3,233	\$3,740	\$3,740



- use atop double and single pedestal desks
- transaction top shaped all sides
- transaction top depth: 10"

Return Reception Gallery	24	51	10	50	10	RG8050-24R	\$1,920	\$2,171	\$2,171
	24	51	10	50	10	RG8050-24L	\$1,920	\$2,171	\$2,171
	18	51	10	45	7	RG8050R	\$1,882	\$2,135	\$2,135
	18	51	10	45	7	RG8050L	\$1,882	\$2,135	\$2,135



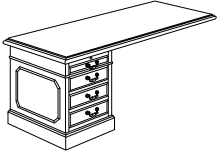
left shown

- use atop return

To Order, Specify:

- ① Model Number
- ② Wood Species - Cherry (CH1) or Walnut (WA1)
(see page WE18)
- ③ Finish Color - (see page WE18)
- ④ Molding - (see page WE18)
- ⑤ Pull Selection & Color - (see page WE18)
- ⑥ Base - (see page WE11)
- ⑦ Product Modification - (see page WE9)

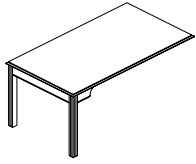
Description	D	W	H	CTN WT	CU FT	① Model	Windsor (WNM)	Wellington (WLM)	Westminster (WSM)
Run-Off Desk with Pedestal Support	36	66	29	262	48	PRR8066R	\$6,424	\$6,928	\$6,928
	36	66	29	262	48	PRR8066L	\$6,424	\$6,928	\$6,928
	36	60	29	251	44	PRR8060R	\$4,888	\$5,391	\$5,391
	36	60	29	251	44	PRR8060L	\$4,888	\$5,391	\$5,391



left shown

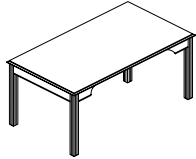
- top shaped three sides with reverse shape on connecting end
- 18" w personal/file/box pedestal
- file drawer styled as two box drawers
- arm slide writing shelf
- pedestal front locking
- 3-piece leather inlay available, specify color and add \$2,687 list
- grommet available, specify and add \$114 list each; see page [WE14](#)
- modesty panel available, specify and add \$1,094 list

Description	D	W	H	CTN WT	CU FT	① Model	List Price
Run-Off Table Desk with Leg Support	36	66	29	95	13	LRR8066	\$3,297
	30	60	29	75	10	LRR8060	\$2,890
	30	54	29	70	9	LRR8054	\$2,660



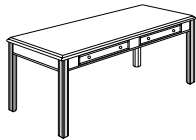
- top shaped three sides with reverse shape on connecting end
- fluted legs

Table Desk	36	72	29	138	13	TD8072-36	\$4,007
------------	----	----	----	-----	----	-----------	---------



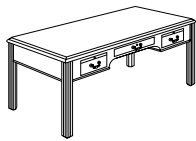
- top shaped all sides
- top long grain veneer direction
- fluted legs
- 3-piece leather inlay available, specify color and add \$2,687 list
- shipped KD
- kneespace height: 28 ¾"h

Work Table	36	72	29	150	18	T8072-36	\$5,039
	30	60	29	109	12	T8060-30	\$3,050



- top shaped all sides
- top long grain veneer direction
- two drawers
- fluted legs
- 3-piece leather inlay available, specify color and add \$2,687 list
- shipped KD
- kneespace height: 23 ⅝"h

Table Desk	36	72	30 ¼	259	25	TD8072	\$6,684
------------	----	----	------	-----	----	--------	---------

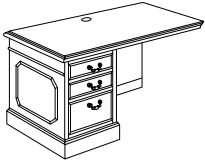


- top shaped all sides
- top long grain veneer direction
- cut-away front
- slide-out writing shelf, approach side
- 3-piece leather inlay available, specify color and add \$2,687 list
- shipped KD
- kneespace height:
 - floor-center drawer: 24 ¼"h
 - floor-outer drawer: 20 ½"h

To Order, Specify:

- ① Model Number
- ② Wood Species - Cherry (CH1) or Walnut (WA1)
(see page WE18)
- ③ Finish Color - (see page WE18)
- ④ Molding - (see page WE18)
- ⑤ Pull Selection & Color - (see page WE18)
- ⑥ Product Modification - (see page WE9)

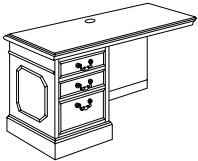
Description	D	W	H	CTN WT	CU FT	① Model	Windsor (WNM)	Wellington (WLM)	Westminster (WSM)
25 3/4" d Return	25 3/4	51 3/4	29	165	22	ER8050R-24	\$5,552	\$5,803	\$5,803
	25 3/4	51 3/4	29	165	22	ER8050L-24	\$5,552	\$5,803	\$5,803



left shown

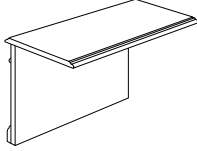
- use with 72" w or 66" w desk
- top shaped three sides
- reverse shape connecting end
- 20" w box/box/file pedestal
- pedestal front locking
- 2" top grommet
- 1 7/8" x 3 7/8" modesty grommet, top center
- kneespace width: 29 1/2"
- kneespace height: 27 7/8"

19 3/4" d Return	19 3/4	51 3/4	29	159	20	ER8050R	\$5,241	\$5,494	\$5,494
	19 3/4	51 3/4	29	159	20	ER8050L	\$5,241	\$5,494	\$5,494




left shown

- use with 72" w or 66" w desk or SPCUR8072L or R
- top shaped three sides
- reverse shape connecting end
- 20" w box/box/file pedestal
- pedestal front locking
- 2" top grommet
- 1 7/8" x 3 7/8" modesty grommet, top center
- kneespace width: 29 1/2"
- kneespace height: 27 7/8"

Description	D	W	H	CTN WT	CU FT	① Model	List Price
Bridge with Modesty Panel 	24	48	29	110	6	EU8048-24	\$3,112
	19 3/4	48	29	92	6	EU8048	\$2,987
	19 3/4	36	29	85	5	EU8036	\$2,600

- shaped two sides
- reverse shaped connecting ends
- top short grain veneer direction
- 1 7/8" x 3 7/8" grommet top center of modesty panel

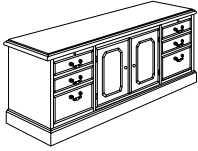
Description	D	W	H	CTN WT	CU FT	① Model	List Price
Bridge Top 	24	48	1 1/4	50	2	EUT8048-24	\$1,650
	19 3/4	48	1 1/4	41	2	EUT8048	\$1,586
	19 3/4	36	1 1/4	38	2	EUT8036	\$1,380

- shaped two sides
- reverse shaped connecting ends

To Order, Specify:

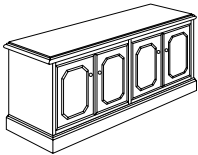
- ① Model Number
- ② Wood Species - Cherry (CH1) or Walnut (WA1)
(see page [WE18](#))
- ③ Finish Color - (see page [WE18](#))
- ④ Molding - (see page [WE18](#))
- ⑤ Pull Selection & Color - (see page [WE18](#))
- ⑥ Product Modification - (see page [WE9](#))

Description	D	W	H	CTN WT	CU FT	① Model	Without Molding (WOM)	Wellington (WLM)	Westminster (WSM)
Storage Credenza	19 ¾	71	29	334	30	CR8071-HD	\$9,125	\$9,362	\$9,362
	19 ¾	66	29	304	27	CR8066-HD	\$8,137	\$8,431	\$8,431



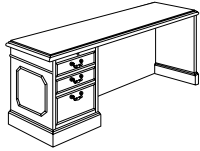
- top shaped all sides
- 20" w box/box/file pedestals
- pedestal front and hinge doors locking
- hinged door compartment with adjustable shelf
- no ventilation for electronic storage
- flat cut for connection left or right end, specify and add \$753 list and indicate right or left end
- flat cut for connection on both ends available, specify and add \$1,151 list

Hinged Door Storage Credenza	19 ¾	60 ½	29	246	25	CR8061-HD	\$7,429	\$7,934	\$7,934
------------------------------	------	------	----	-----	----	-----------	---------	---------	---------



- top shaped all sides
- adjustable shelves
- hinged doors front locking
- no ventilation for electronic storage
- flat cut for connection left or right end, specify and add \$753 list and indicate right or left end
- flat cut for connection on both ends available, specify and add \$1,151 list
- inside dimensions: 16 ½" d x 27 ¾" w x 22 ¾" h

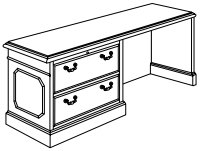
Description	D	W	H	CTN WT	CU FT	① Model	Windsor (WNM)	Wellington (WLM)	Westminster (WSM)
Open Corner Credenza	19 3/4	71	29	299	30	CR8071FR	\$6,446	\$6,682	\$6,682
	19 3/4	71	29	299	30	CR8071FL	\$6,446	\$6,682	\$6,682



left shown

- top shaped all sides
- 20" w box/box/file pedestals
- pedestal front locking
- 1 7/8" x 3 7/8" grommet top center of back panel
- grommet available, specify and add \$114 list each; see page WE14
- flat cut for connection left or right end, specify and add \$753 list and indicate right or left end
- flat cut for connection on both ends available, specify and add \$1,151 list
- kneespace height: 27 5/8"
- kneespace width: 51 1/2"

Open Corner Lateral File Credenza	19 3/4	71	29	302	30	CR802FDR	\$6,787	\$7,024	\$7,024
	19 3/4	71	29	302	30	CR802FDL	\$6,787	\$7,024	\$7,024



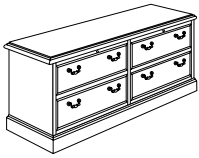
left shown

- top shaped all sides
- 30" w lateral files
- pedestal front locking
- 1 7/8" x 3 7/8" grommet top center of back panel
- flat cut for connection left or right end, specify and add \$753 list and indicate right or left end
- flat cut for connection on both ends available, specify and add \$1,151 list
- kneespace height: 27 5/8"
- kneespace width: 36 7/8"

To Order, Specify:

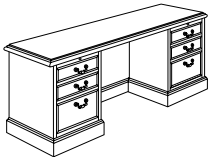
- ① Model Number
- ② Wood Species - Cherry (CH1) or Walnut (WA1)
(see page WE18)
- ③ Finish Color - (see page WE18)
- ④ Molding - (see page WE18)
- ⑤ Pull Selection & Color - (see page WE18)
- ⑥ Base - (see page WE11)
- ⑦ Product Modification - (see page WE9)

Description	D	W	H	CTN WT	CU FT	① Model	List Price
Lateral File Credenza	19 ¾	71	29	421	29	CR8071-4FD	\$9,426
	19 ¾	60 ½	29	284	25	CR8061-4FD	\$8,718



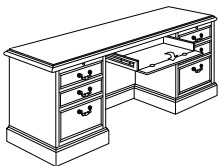
- top shaped all sides
- pedestal front locking
- flat cut for connection left or right end, specify and add \$753 list and indicate right or left end
- flat cut for connection on both ends available, specify and add \$1,151 list
- CR8071-4FD four lateral files, 36" w
- CR8061-4FD four lateral files, 30" w

Kneespace Credenza	19 ¾	71	29	240	30	CR8071-KS	\$8,049
	19 ¾	66	29	212	27	CR8066-KS	\$7,087



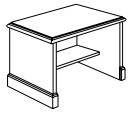
- top shaped all sides
- 20" w box/box/file pedestal
- pedestal front locking
- 1 7/8" x 3 7/8" grommet top center of modesty panel
- flat cut for connection left or right end, specify and add \$753 list and indicate right or left end
- flat cut for connection on both ends available, specify and add \$1,151 list
- CR8071-KS kneespace width: 29 5/8"
- CR8066-KS kneespace width: 24 5/8"

Kneespace Credenza with Center Drawer	19 ¾	71	29	263	30	CR8071-KBT	\$8,723
	19 ¾	66	29	235	27	CR8066-KBT	\$7,753



- top shaped all sides
- flip front drawer
- 20" w box/box/file pedestals
- pedestals front locking
- 1 7/8" x 3 7/8" grommet top center of modesty panel
- flat cut for connection left or right end, specify and add \$753 list and indicate right or left end
- flat cut for connection on both ends available, specify and add \$1,151 list
- CR8071-KBT kneespace width: 29 5/8"
- CR8066-KBT kneespace width: 24 5/8"

Description	D	W	H	CTN WT	CU FT	① Model	List Price
Computer/Printer Stand	23 ¼	38 ¾	29	131	22	CRT8038FS	\$3,488



- top shaped all sides
- fixed inside shelf
- access slot across top of back
- kneespace width: 34 ⅝"
- kneespace height: 25 ¼"

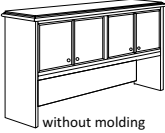
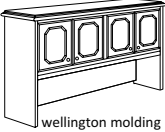
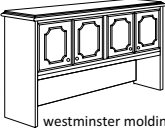
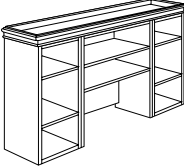
Mobile Computer/Printer Stand	23 ¼	38 ¾	29	131	22	CRT8038FSM	\$3,871
-------------------------------	------	------	----	-----	----	------------	---------

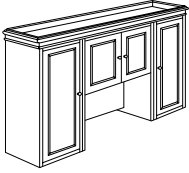


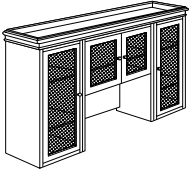
- top shaped all sides
- fixed inside shelf
- access slot across top of back
- casters: front two are locking
- kneespace width: 34 ⅝"
- kneespace height: 25 ¼"

To Order, Specify:

- ① Model Number
- ② Wood Species - Cherry (CH1) or Walnut (WA1)
(see page WE18)
- ③ Finish Color - (see page WE18)
- ④ Pull Selection & Color - (see page WE18)
- ⑤ Base - (see page WE11)
- ⑥ Product Modification - (see page WE9)

Description	D	W	H	CTN WT	CU FT	① Model	List Price No Tackboard	List Price With Tackboard
Storage Overhead Cabinet with 4 Doors  without molding  wellington molding  westminster molding	19 ¾	71	48 ¼	235	38	BOS8069	\$6,943	COM \$7,962 A \$7,989 B \$8,037 C \$8,124 D \$8,238 E \$8,350 F \$8,522 G \$8,709 H \$8,911 I \$9,222 J \$9,595
<ul style="list-style-type: none"> · top shaped all sides · one adjustable shelf per compartment · 1" wire access slot across the bottom of back panel · task lights available, see accessories price list wellington or westminster molding available, specify and add \$494 list · locking doors available, specify and add \$286 list · flat cut for connection left or right end, specify and add \$753 list and indicate right or left end · flat cut for connection on both ends available, specify and add \$1,151 list · compartment height: 24" · compartment depth: 16 ¼" · worksurface to valance rail: 19" · com ydg: 1 ¾ 								
Open Storage Overhead Cabinet with Towers 	13	71	50	195	36	80HU72	\$5,865	COM \$6,864 A \$6,878 B \$6,906 C \$6,958 D \$7,022 E \$7,084 F \$7,185 G \$7,293 H \$7,405 I \$7,584 J \$7,796
<ul style="list-style-type: none"> · top shaped three sides, back side flat · adjustable shelves · 1" wire access slot across bottom of back panel · task lights available, see accessories price list glass shelves, specify and add \$537 · worksurface to valance rail: 19 ¼" · com ydg: 1 								

Description	D	W	H	CTN WT	CU FT	① Model	List Price No Tackboard	List Price With Tackboard
Storage Overhead Cabinet with Tower and Wood Doors	13	71	50	210	36	80HUWD72	\$7,065	COM \$8,066
 <ul style="list-style-type: none"> · top shaped three sides, back side flat · adjustable shelves · 1" wire access slot across bottom of back panel · task lights available, see accessories price list · locking doors available, specify and add \$426 list · worksurface to valance rail: 19 1/4" · com ydg: 1 								A \$8,079
								B \$8,106
								C \$8,158
								D \$8,223
								E \$8,286
								F \$8,387
								G \$8,493
								H \$8,608
								I \$8,785
								J \$8,998

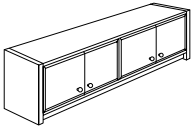
Storage Overhead Cabinet with Tower and Grilled Doors	13	71	50	210	36	80HUGR72	\$7,505	COM \$8,505
 <ul style="list-style-type: none"> · top shaped three sides, back side flat · adjustable shelves · 1" wire access slot across bottom of back panel · task lights available, see accessories price list · glass shelves, specify and add \$537 · locking doors available, specify and add \$426 list · worksurface to valance rail: 19 1/4" · com ydg: 1 								A \$8,519
								B \$8,546
								C \$8,596
								D \$8,661
								E \$8,726
								F \$8,826
								G \$8,931
								H \$9,046
								I \$9,226
								J \$9,438

Storage Overhead Cabinet with Tower and Glass Doors	13	71	50	210	36	80HUGL72	\$7,505	COM \$8,505
 <ul style="list-style-type: none"> · top shaped three sides, back side flat · adjustable shelves · 1" wire access slot across bottom of back panel · task lights available, see accessories price list · glass shelves, specify and add \$537 · locking doors available, specify and add \$426 list · worksurface to valance rail: 19 1/4" · com ydg: 1 								A \$8,519
								B \$8,546
								C \$8,596
								D \$8,661
								E \$8,726
								F \$8,826
								G \$8,931
								H \$9,046
								I \$9,226
								J \$9,438

To Order, Specify:

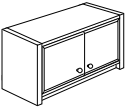
- ① Model Number
- ② Wood Species - Cherry (CH1) or Walnut (WA1) (see page WE18)
- ③ Finish Color - (see page WE18)
- ④ Fabric - vendor, pattern, color
- ⑤ Pull Selection & Color - (see page WE18)
- ⑥ Product Modification - (see page WE9))

Description	D	W	H	CTN WT	CU FT	① Model	List Price
Wall Mount Overhead with 4 Doors	15	88 7/8	17 1/4	143	18	WE4BBW1-1589	\$4,262
	15	69 1/8	17 1/4	110	14	WE4BBW1-1569	\$3,389
	15	64 3/8	17 1/4	104	13	WE4BBW1-1565	\$3,328
	15	59 1/4	17 1/4	100	12	WE4BBW1-1560	\$3,188



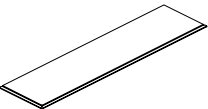
- without top
- mounting brackets included
- valance rail
- wire management grommet in back panel
- locking doors available, specify and add \$286 list
- -1569 use with 71" units
- -1565 use with 66" units
- -1560 use with 61" units

Wall Mount Overhead with 2 Doors	15	34 5/8	17 1/4	58	6	WE4BBW1-1535	\$2,871
	15	29 5/8	17 1/4	51	6	WE4BBW1-1530	\$2,783



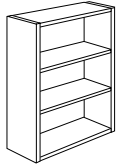
- without top
- mounting brackets included
- valance rail
- wire management grommet in back panel
- locking doors available, specify and add \$142 list
- -1535 use with 36" units

Wall Mount Storage Top	15 7/8	120 1/8	1 1/8	69	5	WE70TU1-16120	\$2,427
	15 7/8	90 1/2	1 1/8	52	4	WE70TU1-1691	\$1,472
	15 7/8	70 1/4	1 1/8	40	3	WE70TU1-1670	\$1,367
	15 7/8	66	1 1/8	38	3	WE70TU1-1666	\$1,142
	15 7/8	60 7/8	1 1/8	35	3	WE70TU1-1661	\$972
	15 7/8	36 1/4	1 1/8	21	2	WE70TU1-1636	\$843
	15 7/8	31 1/4	1 1/8	18	1	WE70TU1-1631	\$600



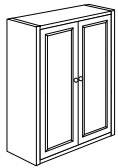
- shaped three sides
- flat cut for connection left or right end, specify and add \$753 list and indicate right or left end
- flat cut for connection on both ends available, specify and add \$1,151 list

Description	D	W	H	CTN WT	CU FT	① Model	List Price
Open Storage Tower	13	29 5/8	47	83	16	HU8047NB	\$2,552



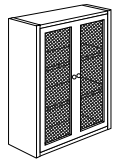
- two adjustable shelves
- glass shelves, specify and add \$341

Storage Tower with Wood Doors	13	29 5/8	47	95	16	HUWD8047NB	\$3,645
-------------------------------	----	--------	----	----	----	------------	---------



- two adjustable shelves
- locking doors available, specify and add \$142 list

Storage Tower with Grilled Doors	13	29 5/8	47	95	16	HUDGR8047NB	\$3,854
----------------------------------	----	--------	----	----	----	-------------	---------



- two adjustable shelves
- glass shelves, specify and add \$341
- locking doors available, specify and add \$142 list

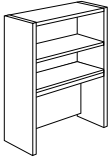
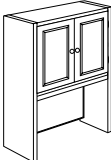
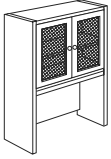
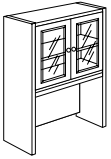
Storage Tower with Glass Doors	13	29 5/8	47	95	16	HUDGL8047NB	\$3,854
--------------------------------	----	--------	----	----	----	-------------	---------



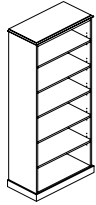
- two adjustable shelves
- glass shelves, specify and add \$341
- locking doors available, specify and add \$142 list

To Order, Specify:

- ① Model Number
- ② Wood Species - Cherry (CH1) or Walnut (WA1)
(see page WE18)
- ③ Finish Color - (see page WE18)
- ④ Pull Selection & Color - (see page WE18)
- ⑤ Product Modification - (see page WE9)

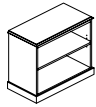
Description	D	W	H	CTN WT	CU FT	① Model	List Price No Tackboard	List Price With Tackboard
 <p>Open Bookcase Storage Tower</p> <ul style="list-style-type: none"> · upper shelf adjustable · lower shelf fixed · 1" wire access slot across bottom of back panel · task lights available, see accessories price list · glass shelves, specify and add \$179 · worksurface to valance rail: 19 1/4" · com ydg: 1 	13	29 5/8	47	78	16	HU8023NB	\$3,288	COM \$4,286 A \$4,301 B \$4,330 C \$4,382 D \$4,443 E \$4,508 F \$4,607 G \$4,714 H \$4,828 I \$5,009 J \$5,221
 <p>Storage Tower with Wood Doors</p> <ul style="list-style-type: none"> · one adjustable shelf · 1" wire access slot across bottom of back panel · task lights available, see accessories price list · locking doors available, specify and add \$142 list · worksurface to valance rail: 19 1/4" · com ydg: 1 	13	29 5/8	47	90	16	HUWD8023NB	\$4,337	COM \$5,336 A \$5,351 B \$5,378 C \$5,430 D \$5,494 E \$5,558 F \$5,657 G \$5,764 H \$5,876 I \$6,057 J \$6,268
 <p>Storage Tower with Grilled Doors</p> <ul style="list-style-type: none"> · one adjustable shelf · 1" wire access slot across bottom of back panel · task lights available, see accessories price list · glass shelves, specify and add \$179 · locking doors available, specify and add \$142 list · worksurface to valance rail: 19 1/4" · com ydg: 1 	13	29 5/8	47	90	16	HUDGR8023NB	\$4,555	COM \$5,557 A \$5,570 B \$5,599 C \$5,648 D \$5,714 E \$5,778 F \$5,876 G \$5,987 H \$6,099 I \$6,276 J \$6,488
 <p>Storage Tower with Beveled Glass Doors</p> <ul style="list-style-type: none"> · one adjustable shelf · 1" wire access slot across bottom of back panel · task lights available, see accessories price list · glass shelves, specify and add \$179 · locking doors available, specify and add \$142 list · worksurface to valance rail: 19 1/4" · com ydg: 1 	13	29 5/8	47	90	16	HUDGL8023NB	\$4,555	COM \$5,557 A \$5,570 B \$5,599 C \$5,648 D \$5,714 E \$5,778 F \$5,876 G \$5,987 H \$6,099 I \$6,276 J \$6,488

Description	D	W	H	CTN WT	CU FT	① Model	List Price
77 ¼" Bookcase	15 7/8	37 5/8	77 ¼	237	30	WE60BK1-3877	\$4,307



- top and base shaped three sides
- finished, inset back panel
- five adjustable shelves
- properly secure to prevent tipping (hardware not included)
- WE0HDS1-3501 (heavy duty shelf) specify and add \$179 list each
- flat cut for connection left or right end, specify and add \$753 list and indicate right or left end
- flat cut for connection on both ends available, specify and add \$1,151 list
- unfinished back panel, specify and deduct \$139 list

29" Bookcase	15 7/8	37 5/8	29	110	12	WE60BK1-3829	\$2,502
--------------	--------	--------	----	-----	----	--------------	---------

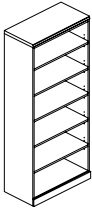


- top and base shaped three sides
- finished, inset back panel
- adjustable shelf
- properly secure to prevent tipping (hardware not included)
- WE0HDS1-3501 (heavy duty shelf) specify and add \$179 list each
- flat cut for connection left or right end, specify and add \$753 list and indicate right or left end
- flat cut for connection on both ends available, specify and add \$1,151 list
- unfinished back panel, specify and deduct \$72 list

To Order, Specify:

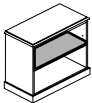
- ① Model Number
- ② Wood Species - Cherry (CH1) or Walnut (WA1)
(see page WE18)
- ③ Finish Color - (see page WE18)
- ④ Fabric - vendor, pattern, color
- ⑤ Pull Selection & Color - (see page WE18)
- ⑥ Product Modification - (see page WE9)

Description	D	W	H	CTN WT	CU FT	① Model	List Price
Open Bookcase with Shaped Front Top	15 7/8	36	84 3/8	240	26	WE60BK8-3684	\$4,132
	15 7/8	36	72 3/8	224	23	WE60BK8-3672	\$3,758
	15 7/8	36	60 3/8	190	19	WE60BK8-3660	\$3,287
	15 7/8	36	48 3/8	139	15	WE60BK8-3648	\$2,729
	15 7/8	36	36 3/8	120	12	WE60BK8-3636	\$2,415
	15 7/8	36	30 3/8	110	10	WE60BK8-3630	\$2,124

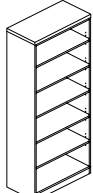


- top and base shaped front only
- properly secure to prevent tipping (hardware not included)
- WE0HDS1-3501 (heavy duty shelf) specify and add \$179 list each
- finished back panel, specify and add \$522 list
- -3684: six adjustable shelves
- -3672: five adjustable shelves
- -3660: four adjustable shelves
- -3648: three adjustable shelves
- -3636: two adjustable shelves
- -3630: one adjustable shelf

Heavy Duty Shelf	14	34 1/2	1	15	1	WE0HDS1-3501	\$282
------------------	----	--------	---	----	---	--------------	-------

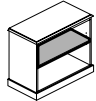


- use with WE60BK1- or WE60BK8-

Description	D	W	H	CTN WT	CU FT	① Model	List Price
	14 3/8	36	84	143	31	GP60BK1-3684	\$3,144
	14 3/8	36	72	130	27	GP60BK1-3672	\$2,870
	14 3/8	36	60	104	23	GP60BK1-3660	\$2,493
	14 3/8	36	48	130	20	GP60BK1-3648	\$2,074
	14 3/8	36	36	96	14	GP60BK1-3636	\$1,739
	14 3/8	36	30	61	12	GP60BK1-3630	\$1,528

- flat rimmed top
- finished, inset back panel
- properly secure to prevent tipping (hardware not included)
- GPOHDS1-3501 (heavy duty shelf) specify and add \$179 list each
- unfinished, inset back panel, -3684, -3672, -3660 specify and deduct \$139 list
- unfinished, inset back panel, -3648, -3636, -3630, specify and deduct \$72 list
- -3684: six adjustable shelves
- -3672: five adjustable shelves
- -3660: four adjustable shelves
- -3648: three adjustable shelves
- -3636: two adjustable shelves
- -3630: one adjustable shelf

Heavy Duty Shelf	13 1/4	34 1/2	1	15	1	GPOHDS1-3501	\$286
------------------	--------	--------	---	----	---	--------------	-------

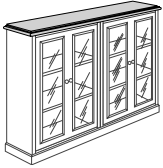


- use with GP60BK1-

To Order, Specify:

- ① Model Number
- ② Wood Species - Cherry (CH1) or Walnut (WA1)
(see page WE18)
- ③ Finish Color - (see page WE18)
- ④ Product Modification - (see page WE9)

Description	D	W	H	CTN WT	CU FT	① Model	List Price
Modular Storage Top	13 7/8	120	1 1/4	60	4	TU80118-14	\$2,463
	13 7/8	90 1/2	1 1/4	56	3	TU8088-14	\$1,473
	13 3/4	59 1/2	1 1/4	28	2	TU8059-14	\$958
	13 3/4	30 1/2	1 1/4	15	1	TU8029-14	\$583



- shaped three sides, back side flat
- flat cut for connection left or right end, specify and add \$753 list and indicate right or left end
- flat cut for connection on both ends available, specify and add \$1,151 list
- TU80118-14: use with four bookcases
- TU8088-14: use with three bookcases
- TU8059-14: use with two bookcases
- TU8029-14: use with one bookcase

Modular Storage Base	13 3/4	90	4 3/8	34	9	BU8088-14	\$1,196
	13 3/4	59 1/2	4 3/4	17	4	BU8059-14	\$907
	13 3/4	30 1/2	4 3/4	10	2	BU8030-14	\$596



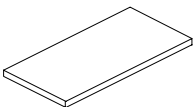
- shaped three sides, back side flat
- flat cut for connection left or right end, specify and add \$753 list and indicate right or left end
- flat cut for connection on both ends available, specify and add \$1,151 list
- BU8088-14: use with three bookcases
- BU8059-14: use with two bookcases
- BU8030-14: use with one bookcase

Modular Overhead Cornice Top	13	118	3	25	5	HT80120	\$1,839
	13	88	3	20	4	HT8091	\$1,350
	13	59	3	13	3	HT8061	\$910
	13	30	3	9	2	HT8031	\$611



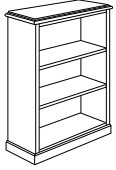
- shaped three sides, back side flat
- HT80120: use with four bookcases
- HT8091: use with two or three bookcases
- HT8061: use with two bookcases
- HT8031: use with one bookcase

Cornice Top Filler Panel	13	29 5/8	7/8	10	1	HFP8029	\$518
---------------------------------	----	--------	-----	----	---	---------	-------



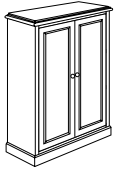
- use with HT8091 and two bookcases

Description	D	W	H	CTN WT	CU FT	① Model	List Price
Open Storage Cabinet	13 ⁷ / ₈	31 ³ / ₈	53	108	19	BC80-1	\$3,610



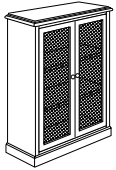
- top and base shaped three sides, back side flat
- two adjustable shelves
- glass shelves, specify and add \$341

Storage Cabinet with Wood Doors	13 ⁷ / ₈	31 ³ / ₈	53	118	19	BCWD80-1	\$4,821
---------------------------------	--------------------------------	--------------------------------	----	-----	----	----------	---------



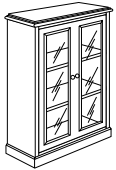
- top and base shaped three sides, back side flat
- two adjustable shelves
- locking doors available, specify and add \$142 list

Storage Cabinet with Grilled Doors	13 ⁷ / ₈	31 ³ / ₈	53	115	19	BCGR80-1	\$5,027
------------------------------------	--------------------------------	--------------------------------	----	-----	----	----------	---------



- top and base shaped three sides, back side flat
- two adjustable shelves
- glass shelves, specify and add \$341
- locking doors available, specify and add \$142 list

Storage Cabinet with Glass Doors	13 ⁷ / ₈	31 ³ / ₈	53	143	19	BCGL80-1	\$5,027
----------------------------------	--------------------------------	--------------------------------	----	-----	----	----------	---------

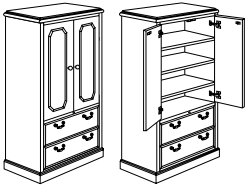


- top and base shaped three sides, back side flat
- two adjustable shelves
- glass shelves, specify and add \$341
- locking doors available, specify and add \$142 list

To Order, Specify:

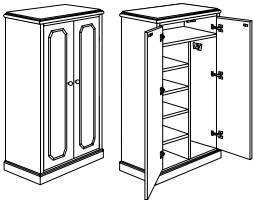
- ① Model Number
- ② Wood Species - Cherry (CH1) or Walnut (WA1)
(see page WE18)
- ③ Finish Color - (see page WE18)

Description	D	W	H	CTN WT	CU FT	① Model	Without Molding (WOM)	Wellington (WLM)	Westminster (WSM)
Storage Cabinet - File/File Lateral	19 ¾	30	77 ¼	310	29	WD8030S-2FS	\$9,936	\$10,185	\$10,185



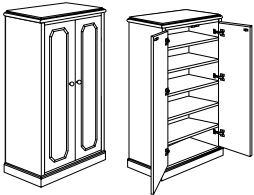
- top shaped all sides
- three adjustable shelves
- pedestal front locking
- locking doors available, specify and add \$142 list
- flat cut for connection left or right end, specify and add \$753 list and indicate right or left end
- flat cut for connection on both ends available, specify and add \$1,151 list

Storage Wardrobe Cabinet	19 ¾	30	77 ¼	285	29	WD8030BC	\$9,791	\$10,044	\$10,044
---------------------------------	------	----	------	-----	----	-----------------	---------	----------	----------



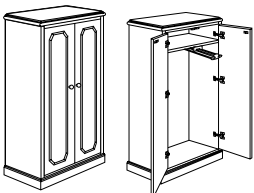
- top shaped all sides
- top shelf fixed
- four adjustable shelves on left
- coat storage on right
- locking doors available, specify and add \$142 list
- flat cut for connection left or right end, specify and add \$753 list and indicate right or left end
- flat cut for connection on both ends available, specify and add \$1,151 list

Storage Cabinet	19 ¾	30	77 ¼	260	29	WD8030S	\$9,584	\$9,835	\$9,835
------------------------	------	----	------	-----	----	----------------	---------	---------	---------



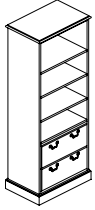
- top shaped all sides
- one fixed shelf
- four adjustable shelves
- locking doors available, specify and add \$142 list
- flat cut for connection left or right end, specify and add \$753 list and indicate right or left end
- flat cut for connection on both ends available, specify and add \$1,151 list

Wardrobe Cabinet	19 ¾	30	77 ¼	225	29	WD8030	\$8,857	\$9,109	\$9,109
-------------------------	------	----	------	-----	----	---------------	---------	---------	---------



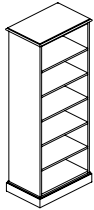
- top shaped all sides
- one fixed shelf and pull-out hanger
- locking doors available, specify and add \$142 list
- flat cut for connection left or right end, specify and add \$753 list and indicate right or left end
- flat cut for connection on both ends available, specify and add \$1,151 list

Description	D	W	H	CTN WT	CU FT	① Model	List Price
Open Storage Cabinet - File/File Lateral	19 ¾	30	77 ¼	292	29	WD8030S-2FS-ND	\$8,831



- top shaped all sides
- three adjustable shelves
- pedestal front locking
- flat cut for connection left or right end, specify and add \$753 list and indicate right or left end
- flat cut for connection on both ends available, specify and add \$1,151 list

Open Storage Cabinet	19 ¾	30	77 ¼	217	29	WD8030S-ND	\$8,274
----------------------	------	----	------	-----	----	------------	---------

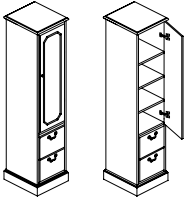


- top shaped all sides
- one fixed shelf
- four adjustable shelves
- flat cut for connection left or right end, specify and add \$753 list and indicate right or left end
- flat cut for connection on both ends available, specify and add \$1,151 list

To Order, Specify:

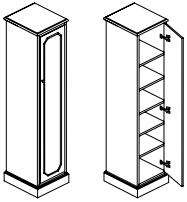
- ① Model Number
- ② Wood Species - Cherry (CH1) or Walnut (WA1)
(see page WE18)
- ③ Finish Color - (see page WE18)
- ④ Molding - (see page WE18)
- ⑤ Pull Selection & Color - (see page WE18)
- ⑥ Product Modification - (see page WE9)

Description	D	W	H	CTN WT	CU FT	① Model	Without Molding (WOM)	Wellington (WLM)	Westminster (WSM)
Storage Cabinet - File/File Pedestal	19 ¾	21 ¼	77 ¼	205	20	WD8018SR-2FS	\$6,668	\$7,050	\$7,050
	19 ¾	21 ¼	77 ¼	205	20	WD8018SL-2FS	\$6,668	\$7,050	\$7,050



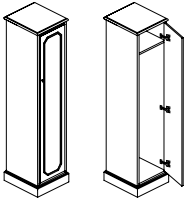
- top shaped all sides
- three adjustable shelves
- pedestal front locking
- locking doors available, specify and add \$142 list
- flat cut for connection left or right end, specify and add \$753 list and indicate right or left end
- flat cut for connection on both ends available, specify and add \$1,151 list

Storage Cabinet	19 ¾	21 ¼	77 ¼	185	20	WD8018SR	\$5,859	\$6,199	\$6,199
	19 ¾	21 ¼	77 ¼	185	20	WD8018SL	\$5,859	\$6,199	\$6,199



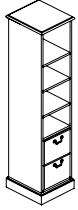
- top shaped all sides
- one fixed shelf
- four adjustable shelves
- locking doors available, specify and add \$142 list
- flat cut for connection left or right end, specify and add \$753 list and indicate right or left end
- flat cut for connection on both ends available, specify and add \$1,151 list

Wardrobe Cabinet	19 ¾	21 ¼	77 ¼	159	29	WD8018R	\$5,453	\$5,787	\$5,787
	19 ¾	21 ¼	77 ¼	159	29	WD8018L	\$5,453	\$5,787	\$5,787



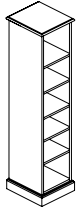
- top shaped all sides
- one fixed shelf and coat hook
- locking doors available, specify and add \$142 list
- flat cut for connection left or right end, specify and add \$753 list and indicate right or left end
- flat cut for connection on both ends available, specify and add \$1,151 list

Description	D	W	H	CTN WT	CU FT	① Model	List Price
Open Storage Cabinet - File/File Pedestal	19 ¾	21 ¼	77 ¼	188	20	WD8018S-2FS-ND	\$5,936



- top shaped all sides
- three adjustable shelves
- pedestal front locking
- flat cut for connection left or right end, specify and add \$753 list and indicate right or left end
- flat cut for connection on both ends available, specify and add \$1,151 list

Open Storage Cabinet	19 ¾	21 ¼	77 ¼	159	20	WD8018S-ND	\$5,455
----------------------	------	------	------	-----	----	------------	---------



- top shaped all sides
- one fixed shelf
- four adjustable shelves
- flat cut for connection left or right end, specify and add \$753 list and indicate right or left end
- flat cut for connection on both ends available, specify and add \$1,151 list

To Order, Specify:

- ① Model Number
- ② Wood Species - Cherry (CH1) or Walnut (WA1)
(see page WE18)
- ③ Finish Color - (see page WE18)
- ④ Molding - (see page WE18)
- ⑤ Pull Selection & Color - (see page WE18)
- ⑥ Product Modification - (see page WE9)

Description	D	W	H	CTN WT	CU FT	① Model	List Price
Four Drawer Lateral File	20 ¾	39 ¾	53 ¼	370	25	8TLFD-4	\$7,740



- top shaped all sides
- pedestal front locking
- finished back

Three Drawer Lateral File	20 ¾	39 ¾	49 ½	280	25	8TLFD-3	\$6,193
---------------------------	------	------	------	-----	----	---------	---------



- top shaped all sides
- pedestal front locking
- finished back

Two Drawer Lateral File	19 ¾	36	29	200	15	2FD8036	\$5,393
-------------------------	------	----	----	-----	----	---------	---------



- top shaped all sides
- pedestal front locking
- finished back

Description	D	W	H	CTN WT	CU FT	① Model	List Price
Four Drawer Lateral File without Top	19	37 ⁵ / ₈	52	348	25	8TLFD-4N	\$7,004



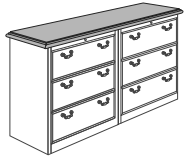
- pedestal front locking
- finished back

Three Drawer Lateral File without Top	19	37 ⁵ / ₈	47 ⁷ / ₈	255	25	8TLFD-3N	\$5,453
---------------------------------------	----	--------------------------------	--------------------------------	-----	----	----------	---------



- pedestal front locking
- finished back

Lateral File Top	20 ³ / ₄	114 ⁵ / ₈	1 ¹ / ₄	84	4	TU80114	\$2,863
	20 ³ / ₄	77	1 ¹ / ₄	58	3	TU8077	\$1,263

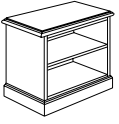


- top shaped all sides
- flat cut for connection left or right end, specify and add \$753 list and indicate right or left end
- flat cut for connection on both ends available, specify and add \$1,151 list
- TU80114 use with 3 lateral files
- TU8077 use with 2 lateral files

To Order, Specify:

- ① Model Number
- ② Wood Species - Cherry (CH1) or Walnut (WA1)
(see page WE18)
- ③ Finish Color - (see page WE18)
- ④ Molding - (see page WE18)
- ⑤ Pull Selection & Color - (see page WE18)
- ⑥ Base - (see page WE11)
- ⑦ Product Modification - (see page WE9)

Description	D	W	H	CTN WT	CU FT	① Model	List Price
Open Pedestal	19 ¾	31	29	105	13	B8031	\$3,171



- top shaped all sides
- one adjustable shelf

Box/Box/File Pedestal	19 ¾	31	29	142	13	FD8031	\$4,675
-----------------------	------	----	----	-----	----	--------	---------



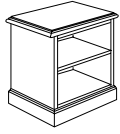
- top shaped all sides
- pedestal front locking

File/File Pedestal	19 ¾	31	29	142	13	2FD8031	\$4,675
--------------------	------	----	----	-----	----	---------	---------



- top shaped all sides
- pedestal front locking

Description	D	W	H	CTN WT	CU FT	① Model	List Price
Open Pedestal	19 ¾	21 ¼	29	70	9	B8020	\$2,925



- top shaped all sides
- one adjustable shelf

Box/Box/File Pedestal	19 ¾	21 ¼	29	100	9	F8020	\$3,551
-----------------------	------	------	----	-----	---	-------	---------



- top shaped all sides
- pedestal front locking

File/File Pedestal	19 ¾	21 ¼	29	100	9	2F8020	\$3,551
--------------------	------	------	----	-----	---	--------	---------

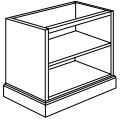


- top shaped all sides
- pedestal front locking
- finished back

To Order, Specify:

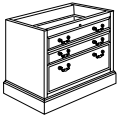
- ① Model Number
- ② Wood Species - Cherry (CH1) or Walnut (WA1)
(see page WE18)
- ③ Finish Color - (see page WE18)
- ④ Molding - (see page WE18)
- ⑤ Pull Selection & Color - (see page WE18)
- ⑥ Base - (see page WE11)
- ⑦ Product Modification - (see page WE9)

Description	D	W	H	CTN WT	CU FT	① Model	List Price
Open Pedestal without Top	19 ¼	30	27 ⅞	85	13	B8031N	\$2,595



- one adjustable shelf

Box/Box/File Pedestal without Top	19 ¼	30 ⅞	27 ⅞	122	13	FD8031N	\$4,094
-----------------------------------	------	------	------	-----	----	---------	---------



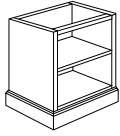
- pedestal front locking

File/File Pedestal without Top	19 ⅜	35 ½	27 ⅞	190	15	2FD8036N	\$4,463
	19 ¼	30 ⅞	27 ⅞	121	13	2FD8031N	\$4,094



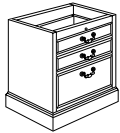
- pedestal front locking
- finished back

Description	D	W	H	CTN WT	CU FT	① Model	List Price
Open Pedestal without Top	19 ¼	21 ⅞	27 ⅞	63	9	B8020N	\$2,313



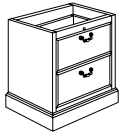
- one adjustable shelf

Box/Box/File Pedestal without Top	19 ¼	21 ⅞	27 ⅞	93	9	F8020N	\$2,940
-----------------------------------	------	------	------	----	---	--------	---------



- pedestal front locking

File/File Pedestal without Top	19 ¾	21 ⅞	27 ⅞	92	9	2F8020N	\$2,940
--------------------------------	------	------	------	----	---	---------	---------



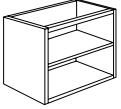
- pedestal front locking

To Order, Specify:

- ① Model Number
- ② Wood Species - Cherry (CH1) or Walnut (WA1)
(see page WE18)
- ③ Finish Color - (see page WE18)
- ④ Molding - (see page WE18)
- ⑤ Pull Selection & Color - (see page WE18)
- ⑥ Base - (see page WE11)
- ⑦ Product Modification - (see page WE9)

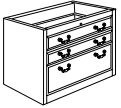
Description	D	W	H	CTN WT	CU FT	① Model	List Price
Open Pedestal without Top & Base	18	29 5/8	23 1/8	71	13	B8031NB	\$1,991

- one adjustable shelf



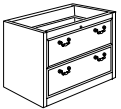
Box/Box/File Pedestal without Top & Base	18	29 5/8	23 1/8	108	13	FD8031NB	\$3,494
--	----	--------	--------	-----	----	----------	---------

- pedestal front locking



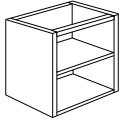
File/File Pedestal without Top & Base	18	34 1/4	23 1/8	170	15	2FD8036NB	\$3,869
	18	29 5/8	23 1/8	107	13	2FD8031NB	\$3,494

- pedestal front locking



Description	D	W	H	CTN WT	CU FT	① Model	List Price
Open Pedestal without Top & Base	18	19 7/8	23 1/8	51	9	B8020NB	\$1,875

- one adjustable shelf



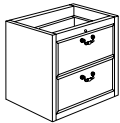
Box/Box/File Pedestal without Top & Base	18	19 7/8	23 1/8	81	9	F8020NB	\$2,501
--	----	--------	--------	----	---	---------	---------

- pedestal front locking



File/File Pedestal without Top & Base	18	19 7/8	23 1/8	80	9	2F8020NB	\$2,501
---------------------------------------	----	--------	--------	----	---	----------	---------

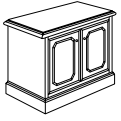
- pedestal front locking



To Order, Specify:

- ① Model Number
- ② Wood Species - Cherry (CH1) or Walnut (WA1)
(see page WE18)
- ③ Finish Color - (see page WE18)
- ④ Molding - (see page WE18)
- ⑤ Pull Selection & Color - (see page WE18)
- ⑥ Base - (see page WE11)
- ⑦ Product Modification - (see page WE9)

Description	D	W	H	CTN WT	CU FT	① Model	Without Molding (WOM)	Wellington (WLM)	Westminster (WSM)
Hinged Door Pedestal	19 ¾	31	29	122	13	HD8031	\$4,003	\$4,253	\$4,253



- top shaped all sides
- one adjustable shelf
- locking doors

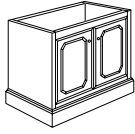
Hinged Door Pedestal	19 ¾	21 ¼	29	75	9	HD8020R	\$2,889	\$3,014	\$3,014
	19 ¾	21 ¼	29	75	9	HD8020L	\$2,889	\$3,014	\$3,014



right shown

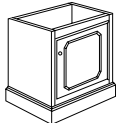
- top shaped all sides
- one adjustable shelf
- locking door
- hinge door determines left or right

Description	D	W	H	CTN WT	CU FT	① Model	Without Molding (WOM)	Wellington (WLM)	Westminster (WSM)
Hinged Door Pedestal without Top	19 ¼	30 7/8	27 7/8	102	13	HD8031N	\$3,426	\$3,677	\$3,677



- one adjustable shelf
- locking doors

Hinged Door Pedestal without Top	19 ¼	21 ½	27 7/8	69	9	HD8020NR	\$2,278	\$2,405	\$2,405
	19 ¼	21 ½	27 7/8	69	9	HD8020NL	\$2,278	\$2,405	\$2,405



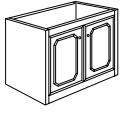
right shown

- one adjustable shelf
- locking door
- hinge door determines left or right

To Order, Specify:

- ① Model Number
- ② Wood Species - Cherry (CH1) or Walnut (WA1)
(see page WE18)
- ③ Finish Color - (see page WE18)
- ④ Molding - (see page WE18)
- ⑤ Pull Selection & Color - (see page WE18)
- ⑥ Base - (see page WE11)
- ⑦ Product Modification - (see page WE9)

Description	D	W	H	CTN WT	CU FT	① Model	Without Molding (WOM)	Wellington (WLM)	Westminster (WSM)
Hinged Door Pedestal without Top & Base	18	29 5/8	23 1/8	88	13	HD8031NB	\$2,822	\$3,073	\$3,073



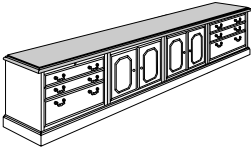
- one adjustable shelf
- locking doors

Hinged Door Pedestal without Top & Base	18	19 7/8	23 1/8	57	9	HD8020NBR	\$1,838	\$1,962	\$1,962
	18	19 7/8	23 1/8	57	9	HD8020NBL	\$1,838	\$1,962	\$1,962



right shown

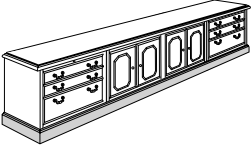
- one adjustable shelf
- locking door
- hinge door determines left or right

Description	D	W	H	CTN WT	CU FT	① Model	List Price
	19 ¾	120	1 ¼	85	5	TU80120	\$2,808
	19 ¾	90 ½	1 ¼	65	4	TU8091	\$1,591
	19 ¾	71	1 ¼	51	3	TU8071	\$1,234
	19 ¾	66	1 ¼	47	2	TU8066	\$1,025
	19 ¾	61	1 ¼	44	2	TU8061	\$980
	19 ¾	41 ⅞	1 ¼	30	2	TU8042	\$891
	19 ¾	36	1 ¼	27	2	TU8036	\$676
	19 ¾	31	1 ¼	20	1	TU8031	\$612
	19 ¾	21 ¼	1 ¼	15	1	TU8020	\$583

- top shaped all sides
- flat cut for connection left or right end, specify and add \$753 list and indicate right or left end
- flat cut for connection on both ends available, specify and add \$1,151 list
- TU80120: use with four 31" modular units
- TU8091: use with three 31" modular units
- TU8071: use with two 20" and one 31" modular units or two 36" lateral files
- TU8066: use with miscellaneous units
- TU8061: use with two 31" or three 20" modular units
- TU8042: use with two 20" modular units
- TU8031: use with one 31" modular unit
- TU8020: use with one 20" modular unit

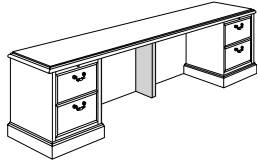
To Order, Specify:

- ① Model Number
- ② Wood Species - Cherry (CH1) or Walnut (WA1)
(see page WE18)
- ③ Finish Color - (see page WE18)
- ④ Molding - (see page WE18)
- ⑤ Pull Selection & Color - (see page WE18)
- ⑥ Base - (see page WE11)
- ⑦ Product Modification - (see page WE9)

Description	D	W	H	CTN WT	CU FT	① Model	List Price
	19 3/8	119 3/8	4 5/8	53	12	BU80119	\$2,787
	19 3/8	90	4 5/8	34	9	BU8090	\$1,367
	19 3/8	69 3/4	4 5/8	26	7	BU8071	\$1,097
	19 3/8	70 1/2	4 5/8	26	7	BU8070	\$1,046
	19 3/8	60 7/8	4 5/8	22	6	BU8061	\$937
	19 3/8	60 1/2	4 5/8	22	6	BU8060	\$937
	19 3/8	41	4 5/8	18	4	BU8041	\$760
	19 3/8	30 3/4	4 5/8	14	3	BU8031	\$606
	19 3/8	21	4 5/8	12	2	BU8020	\$447

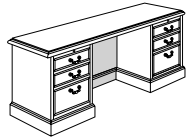
- flat cut for connection left or right end, specify and add \$753 list and indicate right or left end
- flat cut for connection on both ends available, specify and add \$1,151 list
- BU80119: use with four 31" lateral file units
- BU8090: use with three 31" modular units
- BU8071: use with two 36" lateral file units
- BU8070: use with two 20" and one 31" modular units
- BU8061: use with three 20" modular units
- BU8060: use with two 31" modular units
- BU8041: use with two 20" modular units
- BU8031: use with one 31" modular unit
- BU8020: use with one 20" modular unit

Description	D	W	H	CTN WT	CU FT	① Model	List Price
Modular Center Support Panel	11	1	27 3/4	14	1	PE8011	\$721



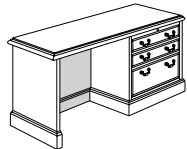
- used in making credenzas and workstations
- use under tops with a 48" span or greater

Modular Modesty Panel	7/8	29 5/8	27 7/8	24	2	MP8030	\$888
-----------------------	-----	--------	--------	----	---	--------	-------



- use in place of a 31" modular unit
- 1 7/8" x 3 7/8" grommet top center

Modular Modesty Panel	7/8	28 5/8	27 7/8	23	2	MP8029	\$888
-----------------------	-----	--------	--------	----	---	--------	-------

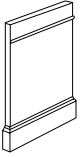


- use in place of a 31" modular unit with end panel
- 1 7/8" x 3 7/8" grommet top center

To Order, Specify:

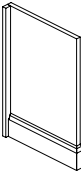
- ① Model Number
- ② Wood Species - Cherry (CH1) or Walnut (WA1)
(see page WE18)
- ③ Finish Color - (see page WE18)

Description	D	W	H	CTN WT	CU FT	① Model	Without Molding (WOM)	Windsor (WNM)	Wellington (WLM)	Westminster (WSM)
Modular End Panel	18	1	27 ⁷ / ₈	17	1	PE8028	\$754	\$788	\$916	\$916



- used in making freestanding credenzas
- modesty panel required

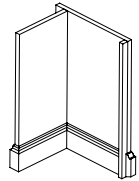
Modular End Panel	18	2 ¹³ / ₁₆	27 ⁷ / ₈	17	1	PE8028R	\$762	\$797	\$924	\$924
	18	2 ¹³ / ₁₆	27 ⁷ / ₈	17	1	PE8028L	\$762	\$797	\$924	\$924



right shown

- used in making handed credenzas
- modesty panel required

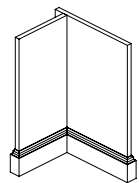
End L-Support Panel	19 ³ / ₈	12	27 ⁷ / ₈	25	5	PELC8028R	\$1,174	\$1,208	\$1,332	\$1,332
	19 ³ / ₈	12	27 ⁷ / ₈	25	5	PELC8028L	\$1,174	\$1,208	\$1,332	\$1,332



right shown

- used for connecting to a bridge or return

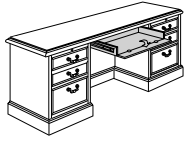
End L-Support Panel	19 ³ / ₈	12	27 ⁷ / ₈	25	5	PELF8028R	\$1,174	\$1,208	\$1,332	\$1,332
	19 ³ / ₈	12	27 ⁷ / ₈	25	5	PELF8028L	\$1,174	\$1,208	\$1,332	\$1,332



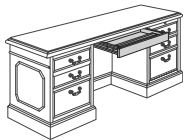
right shown

- freestanding

Description	D	W	H	CTN WT	CU FT	① Model	List Price
Keyboard Drawer with Flip Down Front	15 ¼	29 ½	4 ½	19	2	KBFD80-30	\$828



Center Drawer	17 ¼	29 ½	2 ⅞	23	2	CD8030	\$515
---------------	------	------	-----	----	---	--------	-------



· used in custom credenzas

Costumer	20	20	71 ¾	20	5	C08021	\$1,020
----------	----	----	------	----	---	--------	---------



To Order, Specify:

- ① Model Number
- ② Wood Species - Cherry (CH1) or Walnut (WA1)
(see page [WE18](#))
- ③ Finish Color - (see page [WE18](#))

Wellington Conference Product Information

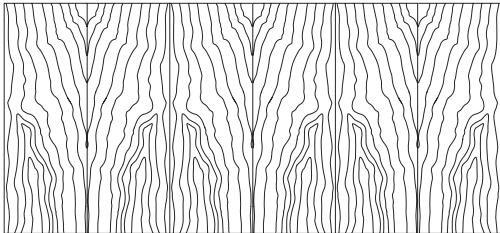


WELLINGTON

Wellington Product Information

Exterior Wood Materials

Exterior surfaces are made from the finest selected veneers to achieve clarity and consistency in the Wellington product line. To attain a pleasing, symmetrical pattern, all veneers in Wellington are book-matched. All exterior solid lumber is matched to coordinate with the veneer.



Book Matched Example

Alternating pieces of veneer are flipped over so they face each other like the pages within a book.

Wellington is available in flat cut cherry veneer and walnut veneer. A wide range of wood stains have been formulated to enhance the beauty of the veneer.

Work Surface Construction

Tops are 3-ply balanced construction, 1 3/16" thick with solid matching hardwood edges. Tops are available in federal edge style profile.

Matching or coordinating high pressure laminate in a veneer grain can be applied to the top surface and is available at no additional charge.

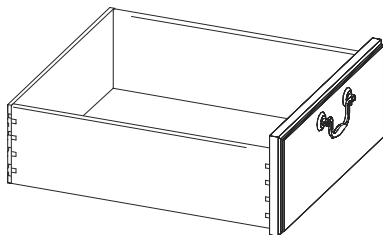
Base Construction

Panels are joined together by mortise and tenon construction. In addition to mortise and tenon joint construction. Leveling glides are set into solid hardwood with t-nut inserts, which helps to prevent the leveling glide from tear out. Tops are secured to the bases with top fastening cleats screwed to the inside of the panels.

Drawers

All drawer fronts are 5-ply construction with a hardwood core. Veneer grain runs in a vertical direction. Drawer sides and backs are solid wood with top edges of sides completely rounded. Drawers are joined at front using a French dovetail and the back by an English dovetail. Veneered bottoms are framed into grooves on four sides and heavily glue blocked. All drawer interiors are finished with special toner and covered with a clear coat. Drawer bottoms are sanded and hand-rubbed.

All drawer bottoms are glued, stapled and reinforced with hand-fitted glue blocks.



Drawer Suspension

The high quality black drawer suspensions carry a lifetime warranty. Slides feature steel ball bearings for longer life with cushioned in/out stops. File and box drawers have 100% full extension.

Locking

Locking is standard in all credenzas and modular units. Door locks are available as an option.

Units are shipped randomly keyed as standard. Key alike units are available upon request for no additional charges. Removable cores for in-field re-keying are standard.

Finish - Stain/Colors

We offer a variety of wood stains and paint colors on Waldon. Please see the chart below. Samples are available upon request.

CH1	Cherry	<i>Flat Cut Veneer</i>		
BBM	Bourbon Medium		CLL	Collectors
BRM	Brighton Medium		HRV	Harvest
CLA	Classic		PRL	Praline
WA1	Walnut	<i>Flat Cut Veneer</i>		
ESP	Espresso		TRF	Truffle
MCH	Mocha		UMB	Umber
SIE	Sienna			

Protective Top Coat

DuraTex™ offers exceptional hardness along with abrasion and impact resistance, it has been formulated to eliminate hazardous and harmful gases that are normally associated with wood finish.

DuraTex™ Features

- Safety - Significantly reduces hazardous formaldehyde emissions, which help improve the quality of the of the indoor air we breathe.
- Quality - Developed to be tough and durable with special attention to appearance. The DuraTex™ finish preserves the natural beauty of wood.
- Durability - Designed to meet a wide range of demanding performance and environmental standards to withstand even the highest wear and tear.

Wellington Product Information

Product Modification

Laminate Tops

Worksurface only, no additional upcharge if coordinating wood grain laminate is specified. Contact Customer Service for any other laminate request. Listed below are finishes that have coordinating wood grain HPL laminates.

CH1 Cherry *Flat Cut Veneer*

CLL Collectors

HRV Harvest

PRL Praline

WA1 Walnut *Flat Cut Veneer*

MCH Mocha

TRF Truffle

SIE Sienna

UMB Umber

Special Finishes

Special finishes can be requested by following the instruction in the general introduction section, page 5. There is a one time charge of \$372 list per order.

Finish Sheen

All veneer finishes, for Wellington, are standard in 35-sheen. All other finishes can have their sheen modified with a 15% upcharge added to the list price of each item.

Product Modification

Trim Molding

Wellington offers four different trim molding options:

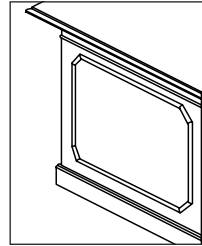
WLM Wellington

WSM Westminster

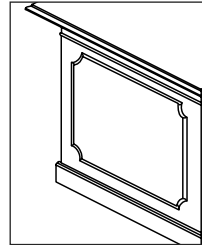
WNM Windsor

WOM Without Molding

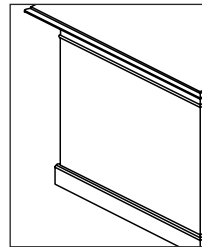
Tables and credenzas have molding on the side of the bases and panels, use the appropriate pricing column, when applicable.



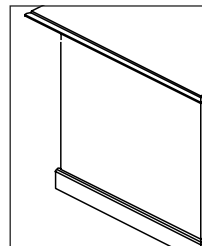
Wellington Molding
Use the **WLM** pricing column



Westminster Molding
Use the **WSM** pricing column



Windsor Molding
Use the **WNM** pricing column



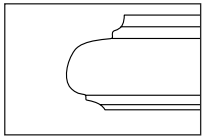
Without Molding
Use the **WOM** pricing column

Wellington Product Information

Edge, Hardware and Grommet

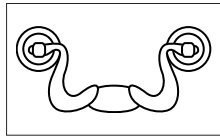
Wellington offers a traditional edge profile and the Wellington drawer pull in antique brass or burnished brass.

Edge Profile

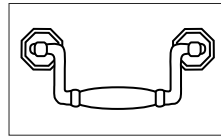


Federal Edge Profile
Accepts Laminate Top

Drawer Hardware

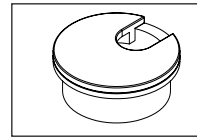


Wellington Hardware
Antique Brass (ANB)
Burnished Brass (BBR)



Windsor Hardware
Burnished Brass (BBR)

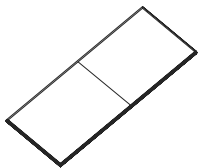
Grommet



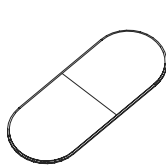
2" Dia. Antique Brass (G3C)
2" Dia. Burnish Brass (G3D)

add \$114 to list price for each grommet for electrical and data accessories

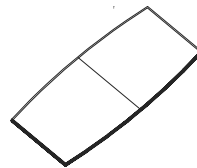
Top Shapes - size - base requirement - seating capacity top sizes 144" through 120" are 2 pieces



rectangular
144" x 60" 3 bases seats 14
144" x 48" 3 bases seats 12
120" x 48" 2-3* bases seats 8
96" x 48" 2 bases seats 8
72" x 36" 2 bases seats 6



racetrack
144" x 60" 3 bases seats 14
144" x 48" 3 bases seats 12
120" x 48" 2-3* bases seats 8
96" x 48" 2 bases seats 8
72" x 36" 2 bases seats 6



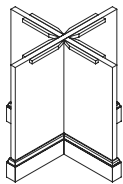
boat
144" x 48" 3 bases seats 12
120" x 48" 2-3* bases seats 8
96" x 48" 2 bases seats 8
72" x 36" 2 bases seats 6



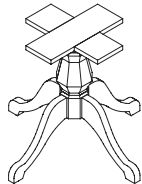
round*
60" dia. Seats 6
54" dia. Seats 6
48" dia. Seats 4
42" dia. Seats 4
36" dia. Seats 4

*requires 1 base

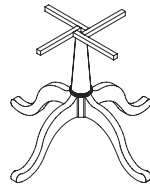
Traditional Bases for Wellington



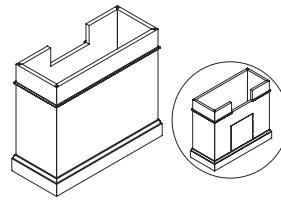
X base
25" width
29" width



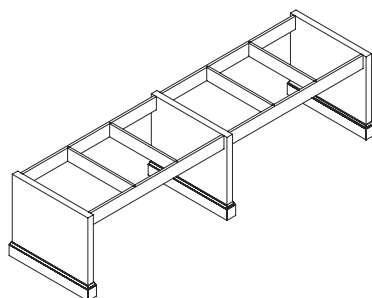
pedestal base
31" dia. span



pedestal base
38" dia. span



rectangular base
24" x 12"
30" x 12"
(access door models availability)
available with Wellington molding options
(diagram shows WNM molding)



panel base assembly (panels 2 1/4" thick)

base sizes	top sizes
114" x 43" width	144" x 60"
114" x 31" width	144" x 48"
90" x 31" width	120" x 48"
72" x 31" width	96" x 48"
48" x 25" width	72" x 36"

bases 114" and longer requires middle panel
available with Wellington molding options *(diagram shows WOM molding)*

WE66 Wellington

Wellington Product Information

Finish and Product Reference Codes

Select	Code
--------	------

Veneer

Cherry Flat Cut	CH1
Walnut Flat Cut	WA1

Finish

Cherry Finishes

Brighton Medium	BRM
Bourbon Medium	BBM
Classic	CLA
Collectors	CLL
Harvest	HRV
Praline	PRL
Saffron	SAF

Walnut Finishes

Espresso	ESP
Mocha	MCH
Sienna	SIE
Truffle	TRF
Umber	UMB

Select	Code
--------	------

Pull & Finishes Codes

Wellington - Antique Brass	ANB
Wellington - Burnished Brass	BBR
Windsor - Burnished Brass	BBR

Grommet Codes

2" dia. Antique Brass	G3C
2" dia. Burnished Brass	G3D

Wellington Molding Options

Wellington Molding	WLM
Westminster Molding	WSM
Windsor Molding	WNM
No Molding Trim	WOM

Select	Code
--------	------

Laminate Coordinates

Cherry Wood Grain Patterns	
Collectors	CLL
Harvest	HRV
Praline	PRL

Walnut Wood Grain Patterns

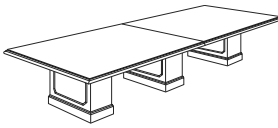
Mocha	MCH
Sienna	SIE
Truffle	TRF
Umber	UMB

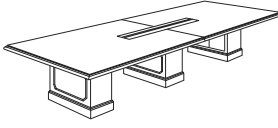
Order Check List:

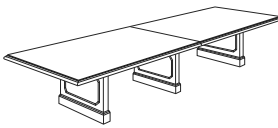
Specify:

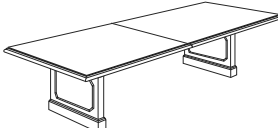
- 1. Model Number
- 2. Finish
- 3. Wood Species - cherry - walnut
- 4. Top Options - standard veneer - laminate surface Page [WE65](#)
- 5. Pull Selection **if applicable**
- 6. Other Product Options - (such as molding)
- 7. Power and Data Accessories (drawing showing location and orientation must accompany order)
- 8. Side Mark Information (i.e. room number, East Conference Room)
- 9. Shipping Address (contact name and phone number)
- 10. Special Delivery Instructions (i.e. call before delivery, deliver to job site)

Description	D	W	H	CTN WT	CU FT	① Model	Without Molding (WOM)	Windsor (WNM)	Wellington (WLM)	Westminster (WSM)
-------------	---	---	---	-----------	----------	---------	-----------------------------	------------------	---------------------	----------------------

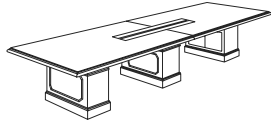
 <ul style="list-style-type: none"> · top shaped all sides · solid hardwood rims · top is two sections · ¾" h apron · base: (3) GP8NRT1-1230, 30" x 12" · hardwood solids and veneers · flat cut, book-matched vertical veneers · adjustable glides · seats 10 to 12 	60	144	29	434	41	WE8JRR4-60144	\$18,060	\$18,198	\$18,721	\$18,721
---	----	-----	----	-----	----	----------------------	----------	----------	----------	----------

 <ul style="list-style-type: none"> · top shaped all sides · solid hardwood rims · top is two sections · ¾" h apron · includes a 30" EC power and data unit · console with retractable doors · standard with silver pearl powder coat · brush stainless steel doors available; specify and add \$2,310 list · base: (2) GP8NRTK-1230, 30" x 12" · open wire access, top of panel · access door, 12 ½" x 11 ⅞", 6" from floor · (1) GP8NRTL-1230, 30" x 12" · open wire access, top of both sides · flat cut, book-matched vertical veneers · adjustable glides · seats 10 to 12 	60	144	29	434	42	WE8JRR4-60144	\$23,969	\$24,090	\$24,630	\$24,630
---	----	-----	----	-----	----	----------------------	----------	----------	----------	----------

 <ul style="list-style-type: none"> · top shaped all sides · solid hardwood rims · top is two sections · ¾" h apron · panels are 2 ¼" thick · base: WE8NPT1-31114, 113 ¾" x 31 ¼" · flat cut, book-matched vertical veneers · horizontal rail is 4 ¼" h · adjustable glides · seats 10 	48	144	29	374	38	WE8JRP4-48144	\$15,349	\$15,614	\$16,205	\$16,205
--	----	-----	----	-----	----	----------------------	----------	----------	----------	----------

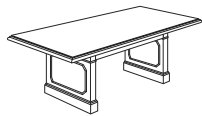
 <ul style="list-style-type: none"> · top shaped all sides · solid hardwood rims · top is two sections · ¾" h apron · panels are 2 ¼" thick · base: WE8NPT1-31190, 89 ⅝" x 31 ¼" · flat cut, book-matched vertical veneers · horizontal rail is 4 ¼" h · adjustable glides · seats 8 	48	120	29	283	24	WE8JRP4-48120	\$12,550	\$12,638	\$12,990	\$12,990
--	----	-----	----	-----	----	----------------------	----------	----------	----------	----------

Description	D	W	H	CTN WT	CU FT	① Model	Without Molding (WOM)	Windsor (WNM)	Wellington (WLM)	Westminster (WSM)
Rectangular Table with Power Console	48	144	29	374	38	WE8JRRC-48144	\$21,522	\$21,709	\$22,180	\$22,180
	48	120	29	252	18	WE8JRRC-48120	\$18,474	\$18,663	\$19,131	\$19,131



- top shaped all sides
- solid hardwood rims
- top is two sections
- 3/4" h apron
- includes a 30" EC power and data unit
- console with retractable doors
- standard with silver pearl powder coat
- brush stainless steel doors available; specify and add \$2,310 list
- base: (2) GP8NRTK-1224, 24" x 12"
- open wire access, top of panel
- access door, 12 1/8" x 11 7/8", 6" from floor
- (1) GPNRTL-1224, 24" x 12"
- open wire access, top of both sides
- flat cut, book-matched vertical veneers
- adjustable glides
- 144" seats 10
- 120" seats 8

Rectangular Table	48	96	29	323	37	WE8JRP4-4896	\$10,326	\$10,413	\$10,765	\$10,765
	36	72	29	200	14	WE8JRP4-3672	\$6,600	\$6,689	\$7,039	\$7,039



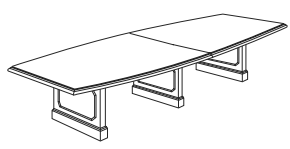
- top shaped all sides
- solid hardwood rims
- 3/4" h apron
- panels are 2 1/4" thick
- 96" base: WE8NPT1-3172
- 72" base: WE8NPT1-2548
- flat cut, book-matched vertical veneers
- horizontal rail is 4 1/4" h
- adjustable glides
- 96" seats 6 to 8
- 72" seats 6

To Order, Specify:

- ① Model Number
- ② Wood Species - Cherry (CH1) or Walnut (WA1)
(see page WE64)
- ③ Finish Color (see page WE64)
- ④ Top Option (see page WE66)
- ⑤ Product Modification (see page WE65)
- ⑥ Power and Data Accessories

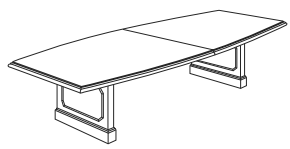
Description	D	W	H	CTN WT	CU FT	① Model	Without Molding (WOM)	Windsor (WNM)	Wellington (WLM)	Westminster (WSM)
-------------	---	---	---	-----------	----------	---------	-----------------------------	------------------	---------------------	----------------------

Boat Shaped Table	48	144	29	369	28	WE8JBP4-48144	\$16,170	\$16,307	\$16,830	\$16,830
--------------------------	----	-----	----	-----	----	----------------------	----------	----------	----------	----------



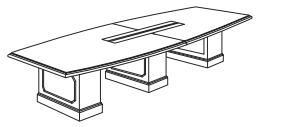
- top shaped all sides
- solid hardwood rims
- top is two sections
- ¾" h apron
- base: WE8NPT1-31114
- panels are 2 ¼" thick
- flat cut, book-matched vertical veneers
- horizontal rail is 4 ¼" h
- adjustable glides
- seats 10

Boat Shaped Table	48	120	29	283	24	WE8JBP4-48120	\$13,306	\$13,393	\$13,747	\$13,747
--------------------------	----	-----	----	-----	----	----------------------	----------	----------	----------	----------



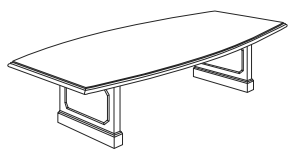
- top shaped all sides
- solid hardwood rims
- top is two sections
- ¾" h apron
- base: WE8NPT1-3190
- panels are 2 ¼" thick
- flat cut, book-matched vertical veneers
- horizontal rail is 4 ¼" h
- adjustable glides
- seats 8

Boat Shaped Table with Power Console	48	144	29	374	38	WE8JBRC-48144	\$22,339	\$22,407	\$22,804	\$22,804
	48	120	29	283	24	WE8JBRC-48120	\$19,230	\$19,420	\$19,894	\$19,894



- top shaped all sides
- solid hardwood rims
- top is two sections
- ¾" h apron
- includes a 30" EC power and data unit
- console with retractable doors
- standard with silver pearl powder coat
- brush stainless steel doors available; specify and add \$2,310 list
- base: (2) GP8NRTK-1224, 24" x 12"
- open wire access, top of panel
- access door, 12 ½" x 11 ⅞", 6" from floor
- (1) GP8NRTL-1224, 24" x 12"
- open wire access, top of both sides
- flat cut, book-matched vertical veneers
- adjustable glides
- 144" seats 10
- 120" seats 8

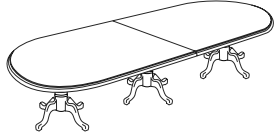
Boat Shaped Table	48	96	29			WE8JBP4-4896	\$11,011	\$11,096	\$11,451	\$11,451
--------------------------	----	----	----	--	--	---------------------	----------	----------	----------	----------



- top shaped all sides
- solid hardwood rims
- ¾" h apron
- panels are 2 ¼" thick
- base: WE8NPT1-3172
- flat cut, book-matched vertical veneers
- horizontal rail is 4 ¼" h
- adjustable glides
- seats 6 to 8

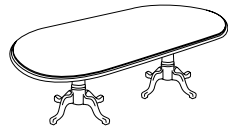
WELLINGTON

Description	D	W	H	CTN WT	CU FT	① Model	List Price
Racetrack Top Table	48	144	29	340	105	WE8JOT4-48144	\$18,488
	48	120	29	252	12	WE8JOT4-48120	\$16,676



- shaped top
- solid hardwood rims
- top is two sections
- 1 5/8" h apron
- base: (3) GP8NTR4-0038
- 37 1/2 " span between legs
- adjustable glides
- 144" seats 10
- 120" seats 8

Racetrack Top Table	48	96	29	221	70	WE8JOT4-4896	\$11,541
---------------------	----	----	----	-----	----	--------------	----------



- shaped top
- solid hardwood rims
- 1 5/8" h apron
- base: (2) GP8NTR4-0038
- 37 1/2 " span between legs
- adjustable glides
- seats 6 to 8

Round Table	48	48	29	87	20	WE8JDT4-0048	\$7,169
	42	42	29	87	21	WE8JDT4-0042	\$6,822



- shaped top
- solid hardwood rims
- 1 5/8" h apron
- base: GP8NTR4-0038
- 37 1/2 " span between legs
- adjustable glides
- seats 4


Round Table	36	36	29	67	8	WE8JDG4-0036	\$4,598
-------------	----	----	----	----	---	--------------	---------



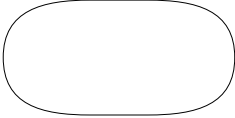
- shaped top
- solid hardwood rims
- 1 5/8" h apron
- base: GP8NFG4-0031
- 30 1/2 " span between legs
- adjustable glides
- seats 3

To Order, Specify:


- ① Model Number
- ② Wood Species - Cherry (CH1) or Walnut (WA1)
(see page WE64)
- ③ Finish Color (see page WE64)
- ④ Top Option (see page WE66)
- ⑤ Product Modification (see page WE65)
- ⑥ Power and Data Accessories

Description	D	W	H	CTN WT	CU FT	① Model	List Price
Rectangular Top 	60	144	1 ¼	330	30	WE8CTR1-60144	\$12,105
	48	144	1 ¼	280	28	WE8CTR1-48144	\$8,914
	48	120	1 ¼	250	22	WE8CTR1-48120	\$7,127
	48	96	1 ¼	220	20	WE8CTR1-4896	\$5,835
	36	72	1 ¼	190	10	WE8CTR1-3672	\$2,975

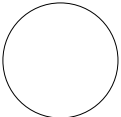
- top shaped all sides
- solid hardwood rims
- 120" and 144" tops are two sections

Description	D	W	H	CTN WT	CU FT	① Model	List Price
Racetrack Top 	60	144	1 ¼	320	30	WE8CTO1-60144	\$13,664
	48	144	1 ¼	368	28	WE8CTO1-48144	\$10,655
	48	120	1 ¼	148	22	WE8CTO1-48120	\$10,313
	48	96	1 ¼	220	20	WE8CTO1-4896	\$7,405
	36	72	1 ¼	92	10	WE8CTO1-3672	\$5,938

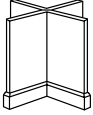
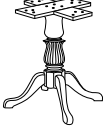
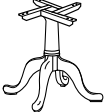
- top shaped all sides
- solid hardwood rims
- 1 5/8" h apron
- 120" and 144" tops are two sections

Description	D	W	H	CTN WT	CU FT	① Model	List Price
Boat Shaped Top 	48	144	1 ¼	178	28	WE8CTB1-48144	\$9,607
	48	120	1 ¼	148	22	WE8CTB1-48120	\$7,819
	48	96	1 ¼	221	20	WE8CTB1-4896	\$6,535
	36	72	1 ¼	87	10	WE8CTB1-3672	\$5,286

- top shaped all sides
- solid hardwood rims
- ¾" h apron
- 120" and 144" tops are two sections
- 96" - 144" w top size: 38/48" d
- 72" w top size: 26/36" d

Description	D	W	H	CTN WT	CU FT	① Model	List Price
Round Top 	60	60	1 ¼	120	14	WE8CTD1-0060	\$6,152
	54	54	1 ¼	90	11	WE8CTD1-0054	\$5,381
	48	48	1 ¼	70	9	WE8CTD1-0048	\$4,505
	42	42	1 ¼	50	7	WE8CTD1-0042	\$4,151
	36	36	1 ¼	45	6	WE8CTD1-0036	\$3,973

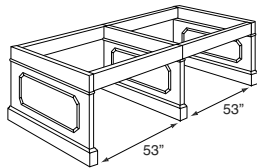
- top shaped all sides
- solid hardwood rims

Description	D	W	H	CTN WT	CU FT	① Model	List Price
Traditional X Base 	30 1/4	30 1/4	27 7/8	46	12	GP8NCR4-2929	\$3,229
	22 3/4	22 3/4	27 7/8	40	10	GP8NCR4-2525	\$3,229
						<ul style="list-style-type: none"> · hardwood solids · panels are 1 1/2" h thick · base molding is 4 3/4" · adjustable glides 	
Traditional Pedestal Base 	30 1/2	30 1/2	27 7/8	48	12	GP8NFG4-0031	\$1,416
						<ul style="list-style-type: none"> · hardwood solids · 30 1/2" leg span · adjustable glides 	
Traditional Pedestal Base 	37 1/2	37 1/2	27 7/8	50	15	GP8NTR4-0038	\$3,439
						<ul style="list-style-type: none"> · hardwood solids · 37 1/2" leg span · adjustable glides 	

To Order, Specify:

- ① Model Number
- ② Wood Species - Cherry (CH1) or Walnut (WA1)
(see page WE64)
- ③ Finish Color (see page WE64)
- ④ Top Option (see page WE66)
- ⑤ Product Modification (see page WE65)
- ⑥ Power and Data Accessories

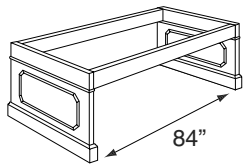
Description	D	W	H	CTN WT	CU FT	① Model	Without Molding (WOM)	Windsor (WNM)	Wellington (WLM)	Westminster (WSM)
144" Traditional Panel Base	43 1/4	113 3/4	27 7/8	105	15	WE8NPT1-43114	\$8,145	\$8,299	\$8,870	\$8,870
	31 1/4	113 3/4	27 7/8	95	13	WE8NPT1-31114	\$7,767	\$7,913	\$8,571	\$8,571



wellington molding shown

- hardwood solids and veneers
- flat cut, book-matched vertical veneers
- panels are 2 1/4" thick
- horizontal rail is 4 1/4" h
- WE8NPT1-43114 panel base with molding 43 1/4" w
- WE8NPT1-31114 panel with base molding 31 1/4" w
- adjustable glides

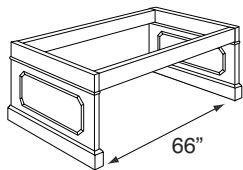
120" Traditional Panel Base	31 1/4	89 5/8	27 7/8	73	10	WE8NPT1-3190	\$6,230	\$6,328	\$6,717	\$6,717
-----------------------------	--------	--------	--------	----	----	--------------	---------	---------	---------	---------



wellington molding shown

- hardwood solids and veneers
- flat cut, book-matched vertical veneers
- panels are 2 1/4" thick
- horizontal rail is 4 1/4" h
- panel with base molding 31 1/4" w
- adjustable glides

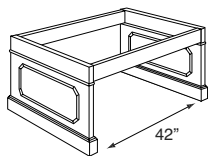
96" Traditional Panel Base	31 1/4	71 5/8	27 7/8	64	10	WE8NPT1-3172	\$5,087	\$5,183	\$5,575	\$5,575
----------------------------	--------	--------	--------	----	----	--------------	---------	---------	---------	---------



wellington molding shown

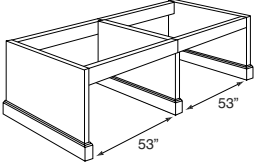
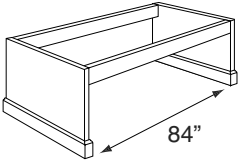
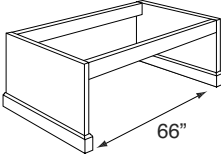
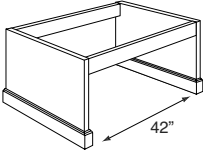
- hardwood solids and veneers
- flat cut, book-matched vertical veneers
- panels are 2 1/4" thick
- horizontal rail is 4 1/4" h
- panel with base molding 31 1/4" w
- adjustable glides

72" Traditional Panel Base	25 1/4	47 5/8	27 7/8	57	9	WE8NPT1-2548	\$4,072	\$4,174	\$4,561	\$4,561
----------------------------	--------	--------	--------	----	---	--------------	---------	---------	---------	---------



wellington molding shown

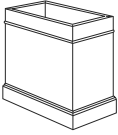
- hardwood solids and veneers
- flat cut, book-matched vertical veneers
- panels are 2 1/4" thick
- horizontal rail is 4 1/4" h
- panel with base molding 25 1/4" w
- adjustable glides

Description	D	W	H	CTN WT	CU FT	① Model	Without Molding (WOM)	Waldon Molding (WDM)
144" Traditional Panel Base  <ul style="list-style-type: none"> walnut solids and veneers flat cut, book-matched vertical veneers molding only on outside end panels panels are 1 1/4" thick horizontal rail is 4 1/4" h GP8NPT1-43114 panel base with molding 43 1/4" w GP8NPT1-31114 panel with base molding 31 1/4" w adjustable glides 	43 1/4	113 3/4	27 7/8			GP8NPT1-43114	\$5,125	\$5,353
	31 1/4	113 3/4	27 7/8			GP8NPT1-31114	\$4,936	\$5,167
120" Traditional Panel Base  <ul style="list-style-type: none"> walnut solids and veneers flat cut, book-matched vertical veneers molding only on outside end panels panels are 1 1/4" thick horizontal rail is 4 1/4" h panel with base molding 31 1/4" w adjustable glides 	31 1/4	89 5/8	27 7/8			GP8NPT1-3190	\$4,532	\$4,759
96" Traditional Panel Base  <ul style="list-style-type: none"> walnut solids and veneers flat cut, book-matched vertical veneers molding only on outside end panels panels are 1 1/4" thick horizontal rail is 4 1/4" h panel with base molding 31 1/4" w adjustable glides 	31 1/4	71 5/8	27 7/8			GP8NPT1-3172	\$3,926	\$4,156
72" Traditional Panel Base  <ul style="list-style-type: none"> walnut solids and veneers flat cut, book-matched vertical veneers molding only on outside end panels panels are 1 1/4" thick horizontal rail is 4 1/4" h panel with base molding 25 1/4" w adjustable glides 	25 1/4	47 5/8	27 7/8			GP8NPT1-2548	\$3,265	\$3,499

To Order, Specify:

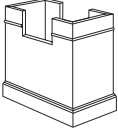
- ① Model Number
- ② Wood Species - Cherry (CH1) or Walnut (WA1)
(see page WE64)
- ③ Finish Color (see page WE64)
- ④ Product Modification (see page WE65)

Description	D	W	H	CTN WT	CU FT	① Model	Without Molding (WOM)	Windsor (WNM)	Wellington (WLM)	Westminster (WSM)
Traditional Rectangular Base- End Unit	12	30	27 ³ / ₈	95	8	GP8NRT1-1230	\$2,370	\$2,469	\$2,633	\$2,633
	12	24	27 ³ / ₈	67	6	GP8NRT1-1224	\$2,220	\$2,292	\$2,444	\$2,444



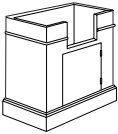
- hardwood solids and veneers
- flat cut, book-matched vertical veneers
- adjustable glides

Traditional Rectangular Base- Mid Unit	12	30	27 ³ / ₈	85	8	GP8NRTL-1230	\$2,471	\$2,574	\$2,729	\$2,729
	12	24	27 ³ / ₈	59	6	GP8NRTL-1224	\$2,314	\$2,386	\$2,535	\$2,535



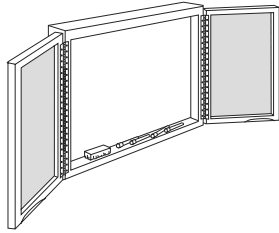
- hardwood solids and veneers
- flat cut, book-matched vertical veneers
- cut-out for wire pass-through
- adjustable glides

Traditional Rectangular Base- End Unit with Access Door	12	30	27 ³ / ₈	86	8	GP8NRTK-1230	\$2,874	\$2,976	\$3,136	\$3,136
	12	24	27 ³ / ₈	60	6	GP8NRTK-1224	\$2,687	\$2,760	\$2,909	\$2,909



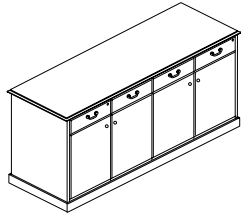
- hardwood solids and veneers
- flat cut, book-matched vertical veneers
- cut-out for wire pass-through
- adjustable glides
- access door opening: 12¹/₈" x 11⁷/₈"

Description	D	W	H	CTN WT	CU FT	① Model	List Price
Visual Board with Doors	5	48	48	135	8	GPOVIS1-0548	\$3,439



- two tackable cork panels
- porcelain magnetic non-glare writing surface
- mounted flip chart pad
- eraser and four markers
- finger grip doors
- wall mounting brackets

Meeting Room Credenza	24	71 3/8	36	330	44	MRC8072-36	\$10,092
-----------------------	----	--------	----	-----	----	------------	----------

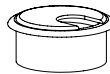
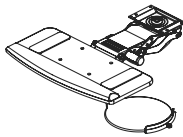


- four drawers
- top shaped all sides
- one adjustable shelf per double door
- locking doors available, specify and add \$286 list

Accessories/ Keyboard/ Tasklights

For a list of electrical units, grommets, keyboards, wire management, monitor arms & telecom jacks, please see our [accessories price list](#)

Contact your customer service representative for specific questions regarding which units can be used with Wellington



To Order, Specify:

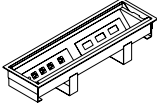
- ① Model Number
- ② Wood Species - Cherry (CH1) or Walnut (WA1)
(see page [WE64](#))
- ③ Finish Color (see page [WE64](#))
- ④ Top Option (see page [WE66](#))
- ⑤ Pull Style and Color
- ⑥ Product Modification (see page [WE65](#))



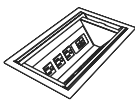
Accessories - Overview

Power Accessories

Pages [GP3-GP10](#)



Power and Data Tilt Out



15" Power and Data Unit



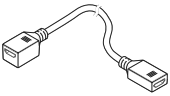
Dual Sided Power and Data Unit



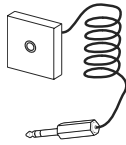
Single Sided Power and Data Unit

Telecom Jacks

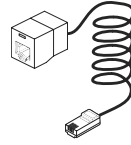
Pages [GP16-GP19](#)



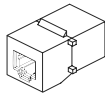
HDMI Connector



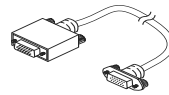
Mini Stereo Jack



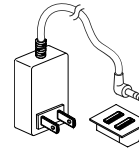
Network Jack



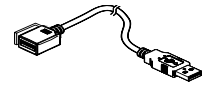
Voice Coupler



Data Jack



Dual Powered Charging USB



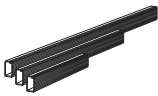
3.0 USB Connector

Wire Management Accessories

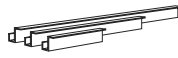
Page [GP11](#)



Vertical Wire Manager



Wire Management Channel



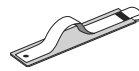
Wire Management Trough



Wire Management Channel



Cable Management Clip



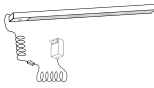
Velcro Straps

Tasklights

Pages [GP20-GP21](#)



Tasklights



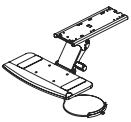
LED Tasklights



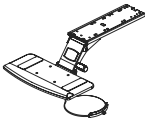
Motion Sensor for Tasklights

Keyboard Accessories

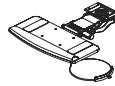
Pages [GP22-GP23](#)



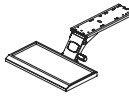
Articulating Keyboard Tray



Articulating Keyboard Tray



Articulating Keyboard Tray



Articulating Keyboard Tray






Keyboard Tray Mouse Pad

Monitor Support Arm

Page [GP24-GP25](#)



For Use with Desk and Conference Tables

Description	D	W	H	CTN WT	CU FT	① Model	List Price
 <p>Mini Power and Data Tilt Up</p> <ul style="list-style-type: none"> fluid one touch tilt up access one power receptacle - 120 volt; 15 amp and one opening for voice/data port data adapter kit provided to accept jacks from most port manufacturers (see page GP15) accepts one Type 3 Telecom Jack (see page GP19) 72" power cord with molded plug drop in field installation required cut out provided in top at specified location (see page GP14) UL listed component Black or Silver finish 	4 1/4	5 1/2		6	1	EC10	\$382
 <p>Mini Power Tilt Up</p> <ul style="list-style-type: none"> fluid one touch tilt up access two power receptacles - 120 volt; 15 amp 72" power cord with molded plug drop in field installation required cut out provided in top at specified location (see page GP14) UL listed component Black or Silver finish 	4 1/4	5 1/2		6	1	EC11	\$397
 <p>Mini Power and USB Tilt Up</p> <ul style="list-style-type: none"> fluid one touch tilt up access one power receptacle - 120 volt; 15 amp dual powered USB 72" power cord with molded plug drop in field installation required cut out provided in top at specified location (see page GP14) UL listed component Black or Silver finish 	4 1/4	5 1/2		6	1	EC12	\$428

To Order, Specify:

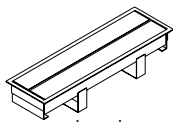
① Model number

Keyboard Accessories

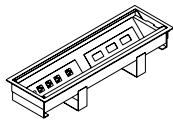
For Use with Desk Bookcases

ACCESSORIES

Description	D	W	H	CTN WT	CU FT	① Model	List Price
Power and Data Tilt Out	30	9		7	6	EC4	\$3,543



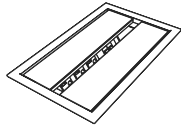
closed



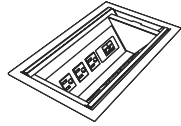
open

- 30" power and data unit
- retractable doors
- standard in silver pearl powder coat
- brush aluminum doors available; specify and add \$1,358 list
- door design allows cords/cables to exit while doors are in closed position
- seven power receptacles
- one dual powered USB
- accepts up to six (6) Type 1 Telecom Plates; additional plate configurations sold separately, see see page [GP15](#)
- unit ships standard with six (6) TCP101, three (3) TCP110 Telecom Plates and three (3) data adapter kits
- power inserts are UL or ETL listed
- two 108" power cords with molded plugs
- cannot be positioned over table support base

Description	D	W	H	CTN WT	CU FT	① Model	List Price
15" Power and Data Unit	15	9		4	2	EC5	\$2,084



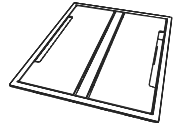
closed



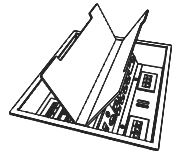
open

- retractable doors
- available in silver pearl powder coat
- brush aluminum doors available; specify and add \$873 list
- door design allows cords/cables to exit while doors are in closed position
- three power receptacles
- one dual powered USB
- accepts up to three (3) Type 1 Telecom Plates; additional plate configurations sold separately, see page [GP15](#)
- unit ships standard with three (3) TCP101, two (2) TCP110 Telecom Plates and two (2) data adapter kits
- power inserts are UL or ETL listed
- 108" power cord with molded plug

Dual Sided Power and Data Unit	11 1/2	14 3/4		7	2	EC6	\$1,448
---------------------------------------	--------	--------	--	---	---	------------	----------------



closed



open

- door design allows cords/cables to exit while doors are in closed position
- eight power receptacles, four per side
- accepts up to eight (8) Type 1 Telecom Plates; additional plate configurations sold separately, see page [GP15](#)
- unit ships standard with four (4) TCP101, four (4) TCP110 Telecom Plates and two (2) data adapter kits
- lids lift to open and contain an access slot to allow cords to exit while in use
- available in silver pearl and black texture powder coat
- units are UL listed and CSA certified
- 108" power cord with molded plug

Single Sided Power and Data Unit	5 3/8	9		4	1	EC7	\$562
---	-------	---	--	---	---	------------	--------------

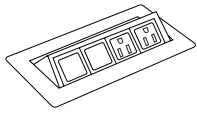


- two power receptacles
- accepts one (1) Type 1 Telecom Plates; additional plate configurations sold separately, see page [GP15](#)
- unit ships standard with one (1) TCP101, one (1) TCP110 Telecom Plate and one (1) data adapter kit
- additionally accepts up to (4) Type 2 Telecom Jacks
- lid lifts to open and contain an access slot to allow cords to exit while in use
- available in silver pearl or black textured powder coat finish
- units are UL listed and CSA certified
- 108" power cord with molded plug
- one under surface power receptacle

To Order, Specify:

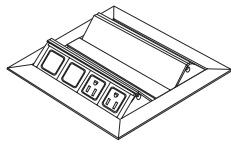
- ① Model number

Description	D	W	H	CTN WT	CU FT	① Model	List Price
Single Sided Power and Data Unit	8 3/8	4		3	1	EC9	\$509



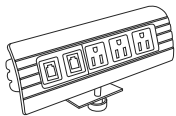
- two power receptacles - 120 volt, 15 amp and two openings for voice/data jacks
- data adapter kit provided to accept jacks from most port manufacturers (see page [GP15](#))
- accepts up to two Type 3 Telecom Jacks (see page [GP19](#))
- push to open pop up door
- clear anodized aluminum
- 72" power cord with molded plug
- UL listed

Dual Power and Data Tilt Up	8	8 3/8		16	1	EC13	\$1,011
------------------------------------	----------	--------------	--	-----------	----------	-------------	----------------



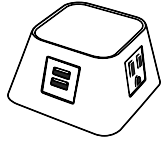
- fluid one touch tilt up access
- back to back tilt sections
- four power receptacles (2 per side) - 120 volt; 15 amp with four openings for voice/data jacks (2 per side)
- data adapter kit provided to accept jacks from most port manufacturers
- accepts up to four Type 3 Telecom Jacks (see page [GP19](#))
- two 72" power cord with molded plug
- drop in field installation required
- cut out provided in top at specified location (see page [GP14](#))
- UL listed component
- available in Silver (S)

Edge Mount Electrical	3	10		16	1	EC15	\$474
------------------------------	----------	-----------	--	-----------	----------	-------------	--------------



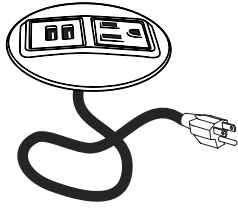
- clamp mounts to the edge of the worksurface - requiring minimum 2" surface overhang
- three power receptacles - 120 volt; 15 amp with two voice/data ports
- data adapter kit provided to accept jacks from most port manufacturers
- accepts up to two Type 3 Telecom Jacks (see page [GP19](#))
- 72" power cord with molded plug - exits back of unit
- UL listed component
- clear anodized aluminum

Description	D	W	H	CTN WT	CU FT	① Model	List Price
Comer Electrical Jumper Cable	3 3/8	3 3/8	2	5	1	EC23	\$481



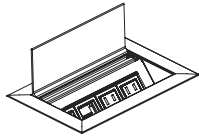
- 3 power & 1 Dual USB, 72" cord
- color: black or white

Node Power Unit	3 3/8	3 3/8	3/8	5	1	EC24	\$384
-----------------	-------	-------	-----	---	---	------	-------



- 1 power & 1 Dual USB, 72" cord
- color: black or white

Ellora Power Unit	5 1/2	8 1/2	3 1/2	5	1	EC25	\$736
-------------------	-------	-------	-------	---	---	------	-------

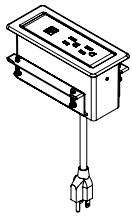


- used in Media Table or Media Credenza
- 2 power, 1 Dual USB & 1 opening for voice/data port, 72" power cord
- adapter kit provided to accept jacks for most port manufactures
- accepts one Type 3 telecom jack
- wire pass-through
- anodized aluminum

To Order, Specify:

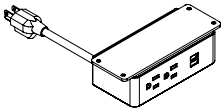
- ① Model number

Description	D	W	H	CTN WT	CU FT	① Model	List Price
Worksurface Power	2 5/8	6 3/8	3	3	1	EC26	\$516



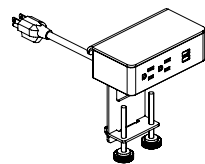
- two power receptacles - 120 volt; 15 amp dual powered USB
- 120" power cord with molded plug
- White (W) or Black (B) finish available, specify when ordering
- UL recognized
- meets UL spill requirements

Under Surface Power	3	6 1/2	1 13/16	2	1	EC27	\$406
---------------------	---	-------	---------	---	---	------	-------

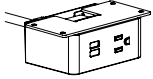
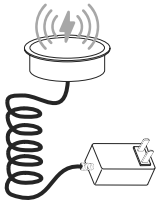
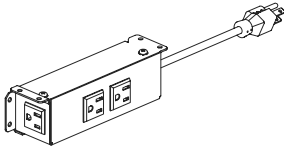


- two power receptacles - 120 volt; 15 amp dual powered USB
- 120" power cord with molded plug
- White (W) or Black (B) finish available, specify when ordering
- UL recognized

Edge Mount Power	3 1/2	5 1/2	7 1/2	3	1	EC28	\$414
------------------	-------	-------	-------	---	---	------	-------



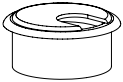
- two power receptacles - 120 volt; 15 amp dual powered USB
- 120" power cord with molded plug
- White (W) or Black (B) finish available, specify when ordering
- UL recognized

Description	D	W	H	CTN WT	CU FT	① Model	List Price
 <p>Power Center - Under Mount</p> <ul style="list-style-type: none"> · 10' cord · frame mounted simplex receptacle and two USB/10' - three prong plug power cord · specify black or white - cord color will match unit · optional graphite fabric cord available, specify and add \$187 list · overall mounting bracket tabs: 5"w 	2 3/4	4	2 5/6			EC30	\$363
 <p>Wireless Charging Unit</p> <ul style="list-style-type: none"> · wireless charging for use with Qi enabled devices · 72" power cord · black · UL Listed · CE/FCC certified 	3 1/2	3 1/2	1	3	1	EC33	\$337
 <p>Under Surface Convenience Power Unit</p> <ul style="list-style-type: none"> · three outlets · 120" power cord · black · ETL Listed for US 	3 1/8	7 1/8	2 1/8	3	1	EC34	\$294

To Order, Specify:

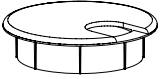
- ① Model number

Description	D	W	H	CTN WT	CU FT	① Model	List Price
2"dia. Grommet	2	2	7/8			GP02FIG	\$33



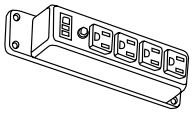
- use in panels 3/4" thick or greater
- plastic sleeve and removable lid
- matte black (MBK)
- interior 1 1/2" dia.
- recommended 1 3/4" dia. cut out for installation in field

3"dia. Grommet	3	3	3/4			GP03FIG	\$33
----------------	---	---	-----	--	--	---------	------



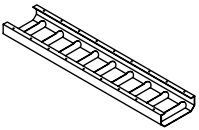
- use in panels 3/4" thick or greater
- plastic sleeve and removable lid
- matte black (MBK)
- interior 2 1/4" dia.
- recommended 2 5/8" dia. cut out for installation in field

Power Strip	1 1/2	1 7/8	8			GP9ACP1-0212	\$93
-------------	-------	-------	---	--	--	--------------	------


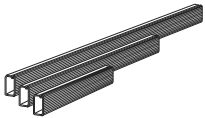
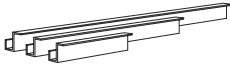
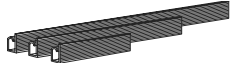
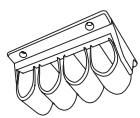
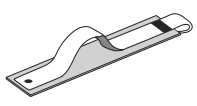


- includes switch
- power surge with 10' cord
- four electrical outlets

Wire Management Trays	7 1/2	45				GP9WMT1-0845	\$270
	7 1/2	35				GP9WMT1-0835	\$228
	7 1/2	25				GP9WMT1-0825	\$185

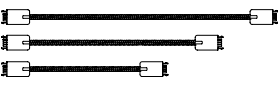


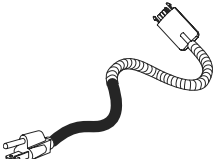
- silver powder-coated finish
- four hanging brackets (CI2C00)

Description	D	W	H	CTN WT	CU FT	① Model	List Price
Vertical Wire Manager  <ul style="list-style-type: none"> flexible, vertebrae-style construction field installed to bottom of worksurface with screws provided length can be adjusted by removing individual discs as required wire manager is 1 1/2" diameter weighted base is 4" diameter black plastic 	1 1/2	1 1/2	45	4	1	45VWM	\$131
Wire Management Channel  <ul style="list-style-type: none"> available in 12", 24" and 36" increments field installed with adhesive tape provided black 	1/2	36	1	4		36WC	\$79
	1/2	24	1	3		24WC	\$71
	1/2	12	1	2		12WC	\$62
Wire Management Trough  <ul style="list-style-type: none"> available in 12", 24" and 36" increments field installed with screws provided black 	2 1/2	36	2 1/2	3		36WCT	\$152
	2 1/2	24	2 1/2	3		24WCT	\$138
	2 1/2	12	2 1/2	2		12WCT	\$119
Wire Management Trough  <ul style="list-style-type: none"> available in 12", 24" and 36" increments field installed with adhesive tape provided mounts to edge of surface top black 	1 1/8	36	2 3/8	1		36WJC	\$65
	1 1/8	24	2 3/8	1		24WJC	\$47
	1 1/8	12	2 3/8	1		12WJC	\$25
Cable Management Clip  <ul style="list-style-type: none"> four retention loops field installed with screws provided mounts under surface black 	2 5/8	3 3/4	1 5/8	1		0304CMC	\$54
Wire Management Velcro Straps  <ul style="list-style-type: none"> set of four field installed with adhesive tape provided mounts under surface or on vertical panels black 	1 3/4	3 1/2	1/4	1		04WVS	\$56

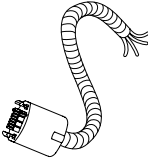
To Order, Specify:

- ① Model number


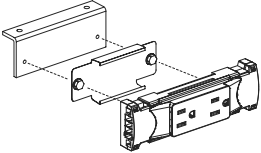
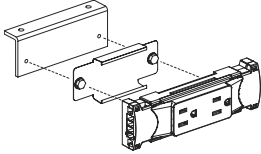
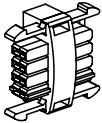
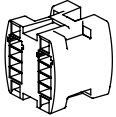
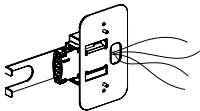
Description	D	W	H	CTN WT	CU FT	① Model	List Price
Jumper 		144		4	1	EC4T-144JK	\$252
		138		4	1	EC4T-138JK	\$245
		132		4	1	EC4T-132JK	\$239
		126		4	1	EC4T-126JK	\$235
		120		4	1	EC4T-120JK	\$230
		114		4	1	EC4T-114JK	\$226
		108		4	1	EC4T-108JK	\$223
		102		4	1	EC4T-102JK	\$216
		96		3	1	EC4T-96JK	\$211
		90		3	1	EC4T-90JK	\$205
		84		3	1	EC4T-84JK	\$200
		78		3	1	EC4T-78JK	\$194
		72		3	1	EC4T-72JK	\$190
		66		3	1	EC4T-66JK	\$181
		60		3	1	EC4T-60JK	\$170
		54		3	1	EC4T-54JK	\$166
		48		2	1	EC4T-48JK	\$159
		42		2	1	EC4T-42JK	\$150
		36		2	1	EC4T-36JK	\$146
		30		2	1	EC4T-30JK	\$141
	24		2	1	EC4T-24JK	\$137	
	18		2	1	EC4T-18JK	\$136	

Three Prong Power Infeed - Flex Metallic Conduit 		120		4	1	EC4T-120APE	\$381
		108		4	1	EC4T-108APE	\$372
		96		3	1	EC4T-96APE	\$362
		84		3	1	EC4T-84APE	\$359
		72		3	1	EC4T-72APE	\$304
		60		3	1	EC4T-60APE	\$259
		48		2	1	EC4T-48APE	\$252

- single circuit infeed
- two foot rubber cord transitions to metal conduit

Hardwire Power Infeed - Flex Metallic Conduit 		144		4	1	EC4T-144HPE	\$235
		132		4	1	EC4T-132HPE	\$225
		120		4	1	EC4T-120HPE	\$218
		108		4	1	EC4T-108HPE	\$211
		96		3	1	EC4T-96HPE	\$198
		84		3	1	EC4T-84HPE	\$188
	72		3	1	EC4T-72HPE	\$179	

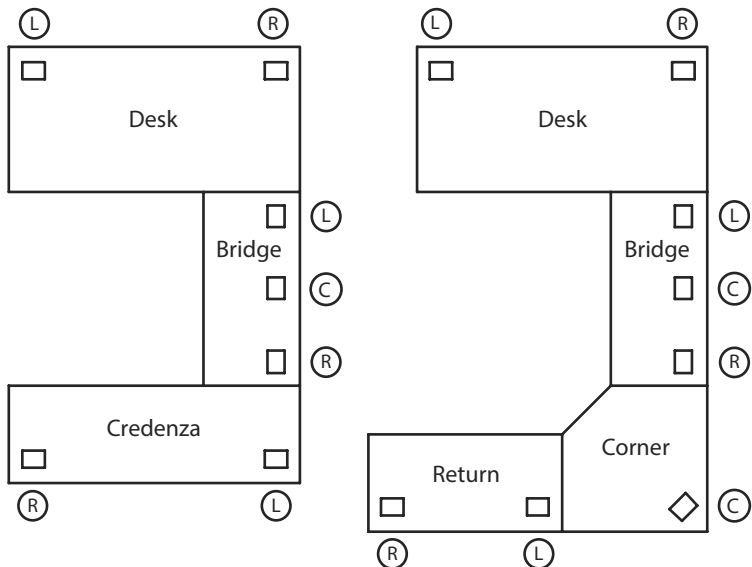
- single or double circuit infeed
- 4 wire 2 circuit system
- 13 duplexes available per each circuit

Description	D	W	H	CTN WT	CU FT	① Model	List Price
Conduit Clamp  <ul style="list-style-type: none"> · includes screw 				1	1	EC4T-CLAMP	\$13
Duplex Receptacle Kit Circuit 1  <ul style="list-style-type: none"> · used in single circuit and multi-circuit applications · vertical and horizontal mounting brackets included 				1	1	EC4T-DUP1K	\$130
Duplex Receptacle Kit Circuit 2  <ul style="list-style-type: none"> · used in multi-circuit applications · vertical and horizontal mounting brackets included 				1	1	EC4T-DUP2K	\$130
Receptacle to Receptacle Connector 				1	1	EC4T-R2R	\$78
H Block Connector Kit  <ul style="list-style-type: none"> · accepts one power infeed and connects up to three jumpers · mounting bracket included 				1	1	EC4T-4HCON	\$86
Quick Disconnect  <ul style="list-style-type: none"> · hardwire connection (4 wire), mounts to wall · accommodates single or multi-circuit · connects directly to jumper in place of power infeed 	1	2 3/4	4 5/8	1	1	EC4T-4QD	\$171

To Order, Specify:

① Model number

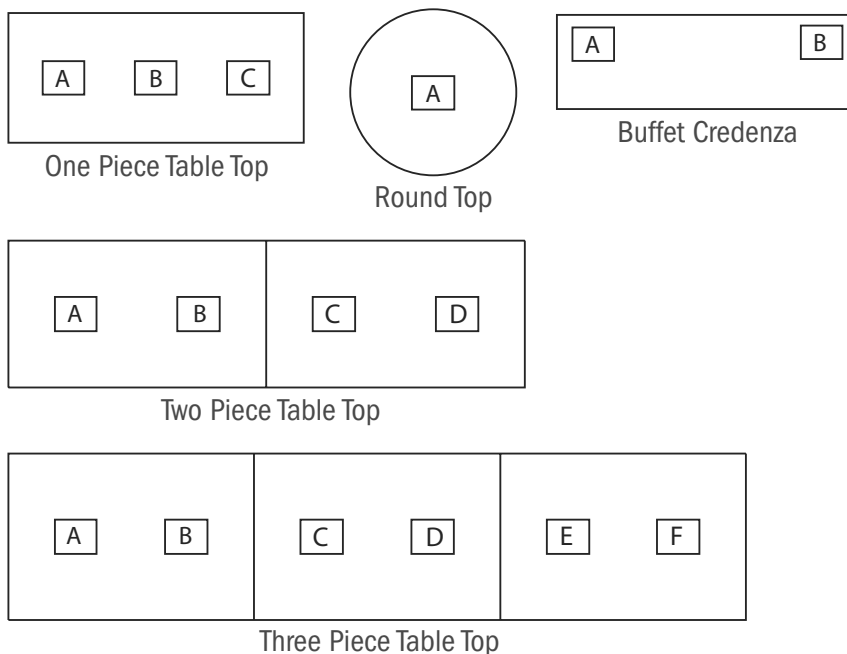
Standard Power and Data Locations for Casegoods:



- Specify - Location when ordering on desk, return, computer corner, bridge and credenza - please provide drawing.
- Computer corner units - power/data replaces grommet.
- Standard power and data unit locations are indicated from user side of desk, return, computer corner bridge or credenza.

NOTE: Verify fit of data jack in adapter before ordering large quantities as manufacturer designs may change without notice

Standard Power and Data Locations for Tables and Conference Units:

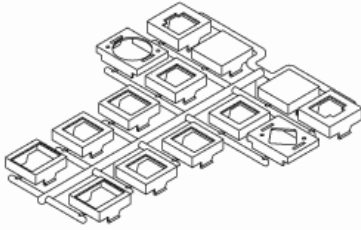


- Verify fit of jack in adapter before ordering large quantities as manufacturer designs may change without notice.
- Installation of Power and Data units on a seam of multi piece tops should be avoided when possible.
- Specify location when ordering conference tops or buffet credenza.
- Standard power and data units are indicated from the side of conference tops and user side of buffet credenza.

Data Adapter Applications

Data adapter kits ship with each power and data unit.

Adapter plates are marked on the back with letter designators to indicate the data jack manufacturer, series and style. Websites are listed below for quick reference to verify data jack series or style.

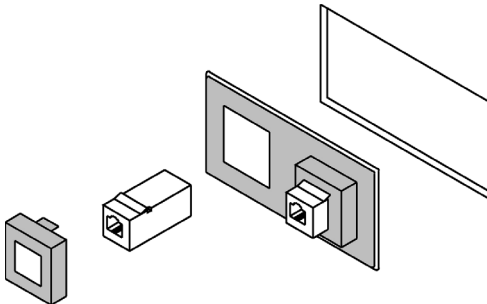


Included with EC9, EC10, EC13, EC15, TCP110 and CC9CNE1-0708.


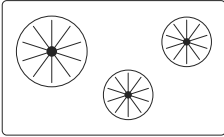
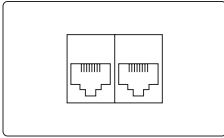
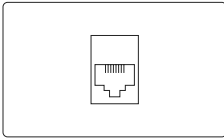
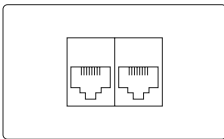
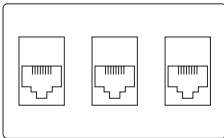
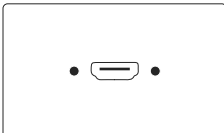
NOTE: Verify fit of data jack in adapter before ordering large quantities as manufacturer designs may change without notice.

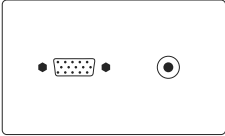
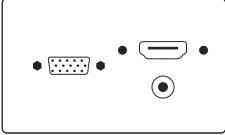
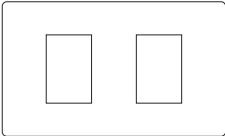
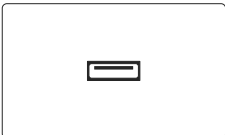
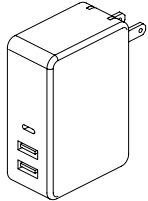
Adapter	Manufacturer	Website
AA	Uniprise/Systimax/Avaya	www.unipriseresolutions.com
BB	Tyco SL and 100 Connect Series Modular Jacks	www.ampconnect.com
BB	Siemon Keystone Style	www.siemon.com
BB	Allen Tel Versa Tap Series	www.allentel.com
BB	Leviton Quick Port® Series	www.leviton.com
BB	Nordx Keystone Style	www.nordx.com
CC	Tyco SL Coupler Series	www.ampconnect.com
CC	Krone 6000 Series	www.adc.com
CC	Hubbell Xcelerator™ Keystone Series	www.hubbell.com
DD	Blank (no coupler/jack)	
EE	Ortronics TracJack Series	www.ortronics.com
FF	Panduit Mini-Com Series	www.panduit.com
GG	Microphone jack/3-pin XLR, solder type only	
HH	Video Monitor jack/DB-15, panel mount solder style	

The TCP110 Type 1 Data plate comes with the adapter kit to allow installation of data jacks listed above. The TCP110 can be installed in the EC4, EC5, EC6, EC7.



Type 1 Telecom Plates/Jacks

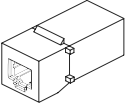
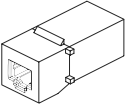
Description	D	W	H	CTN WT	CU FT	① Model	List Price
Data Plate - Blank Cap  <ul style="list-style-type: none"> · for use in EC4, EC5, EC6, EC7 		1 3/4	3 1/8			TCP101	\$16
Data Plate - Three Cord Bushings  <ul style="list-style-type: none"> · for use in EC4, EC5, EC6, EC7 		1 3/4	3 1/8			TCP102	\$76
Data Plate - Two Jacks  <ul style="list-style-type: none"> · one RJ11 Cat3 Jack · one RJ-45 Cat6 Jack · for use in EC4, EC5, EC6, EC7 		1 3/4	3 1/8			TCP103	\$136
Data Plate - One Jack  <ul style="list-style-type: none"> · one RJ-45 Cat6 jack · for use in EC4, EC5, EC6, EC7 		1 3/4	3 1/8			TCP104	\$97
Data Plate - Two Jacks  <ul style="list-style-type: none"> · two RJ-45 Cat6 jacks · for use in EC4, EC5, EC6, EC7 		1 3/4	3 1/8			TCP105	\$163
Data Plate - Three Jacks  <ul style="list-style-type: none"> · three RJ-45 Cat6 jacks · for use in EC4, EC5, EC6, EC7 		1 3/4	3 1/8			TCP106	\$229
Data Plate - HDMI  <ul style="list-style-type: none"> · one HDMI female to female with 36" cord · for use in EC4, EC5, EC6, EC7 		1 3/4	3 1/8			TCP107	\$216

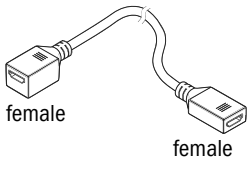
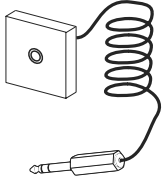
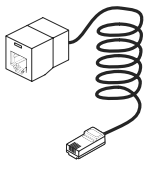
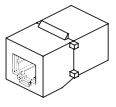
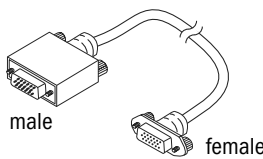
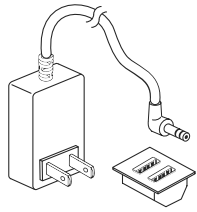
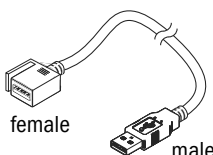
Description	D	W	H	CTN WT	CU FT	① Model	List Price
Data Plate - VGA and Mini-Stereo  <ul style="list-style-type: none"> · one VGA female to female with 72" cord · one Mini-Stereo Inline · for use in EC4, EC5, EC6, EC7 		1 ¾	3 ⅛			TCP108	\$209
Data Plate - VGA, HDMI and Mini-Stereo  <ul style="list-style-type: none"> · one VGA female to female with 72" cord · one HDMI female to female with 36" cord · one Mini-Stereo Inline · for use in EC4, EC5, EC6, EC7 		1 ¾	3 ⅛			TCP109	\$362
Data Plate - Two Open Data Ports  <ul style="list-style-type: none"> · used with two Type 3 Telecom Jacks; see page 531 · for use in EC4, EC5, EC6, EC7 		1 ¾	3 ⅛			TCP110	\$16
Data Plate - USB 3.0  <ul style="list-style-type: none"> · one USB 3.0 Type A/A with 36" patch cord with male end · for use in EC4, EC5, EC6, EC7 · data transfer port · can become powered USB charging port with addition of TCP111-POW power supply 		1 ¾	3 ⅛			TCP111	\$237
USB Charging - Power Supply  <ul style="list-style-type: none"> · USB power supply · for use with TCP111 · converts TCP111 into USB charging port · power source under table or from building required to power unit 						TCP111-POW	\$102

To Order, Specify:

- ① Model number

Type 2 Telecom Jacks

Description	D	W	H	CTN WT	CU FT	① Model	List Price
Phone Jack  <ul style="list-style-type: none"> · RJ-11 phone jack · for use in EC7 						TCP201	\$67
Data Jack  <ul style="list-style-type: none"> · CAT6-RJ45 data jack · for use in EC7 						TCP202	\$89

Description	D	W	H	CTN WT	CU FT	① Model	List Price
HDMI Connector  <ul style="list-style-type: none"> · HDMI coupler · 18" cord · female to female connection · for use in EC9, EC10, EC13, EC15 · uses data adapter kit CCC adapter plate 						TCP301	\$110
Mini Stereo Jack  <ul style="list-style-type: none"> · 3.5 mm Mini Stereo Jack · 10 foot cord · female to male connection · for use in EC9, EC10, EC13, EC15 · installs directly into unit without need of data adapter kit 						TCP302	\$56
Network Jack  <ul style="list-style-type: none"> · Cat5e RJ-45 Panduit Jack · Pre-terminated · 9 foot cord · 8-Pin · for use in EC9, EC10, EC13, EC15 · uses data adapter kit FFF adapter plate 						TCP303	\$101
Voice Coupler  <ul style="list-style-type: none"> · AMP Category 3, RJ-11 · 6-Pin · connects to standard phone cord · for use in EC9, EC10, EC13, EC15 · uses data adapter kit CCC adapter plate 						TCP304	\$41
Data Jack - VGA 15 Pin  <ul style="list-style-type: none"> · 120" M/F cable - female-to-male connection · 15 pin connections · provides electronic device to remove display connection · uses data adapter kit HHH adapter plate 						TCP305	\$136
Dual Powered USB Charging  <ul style="list-style-type: none"> · two (2) USB-A connections for USB powered devices or charging mobile electronics · 2000mA (2 amp) charging power per USB port · black or white option · for use in EC9, EC10, EC13, EC15 · installs directly into unit without need of data adapter kit · 72" cord 						TCP306	\$174
Data Jack - USB 3.0  <ul style="list-style-type: none"> · USB 3.0 data jack with 10' cord and male plug · for use in EC9, EC10, EC13, EC15 · data transfer port - no USB charging capability · data transfer speed up to 5gbs/sec · uses data adapter kit CCC adapter plate 						TCP307	\$95

To Order, Specify:

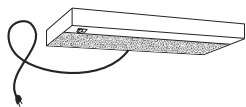
① Model number

Tasklights



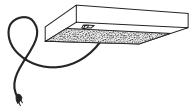
ACCESSORIES

Description	D	W	H	CTN WT	CU FT	① Model	List Price
48" w Tasklight	4 ½	48	1 ½	6	1	48T5L	\$350



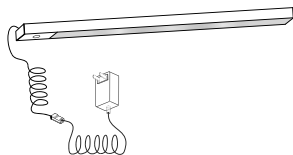
- use with overhead cabinets 60" wide and larger
- uses slim energy-efficient T5 - 3500k lamp (included)
- two position on - off switch
- prismatic lens with electronic ballast
- ETL listed component
- factory installation optional (no additional charge); please specify unit where light is to be installed

24" w Tasklight	4 ½	24	1 ½	4	1	24T5L	\$325
------------------------	-----	----	-----	---	---	--------------	--------------



- use with overhead cabinets 30" wide and larger
- uses slim energy-efficient T5 - 3500k lamp (included)
- two position on - off switch
- prismatic lens with electronic ballast
- ETL listed component
- factory installation optional (no additional charge); please specify unit where light is to be installed

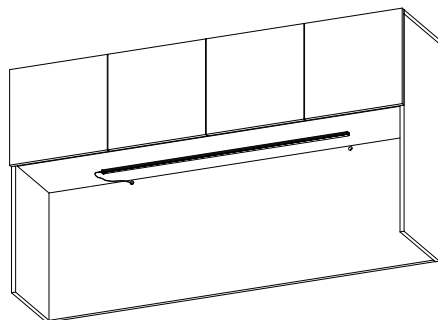
LED Tasklight	D	W	H	CTN WT	CU FT	Model	List Price
	½	60	¾	3	1	TL60LEDF	\$337
	½	45	¾	3	1	TL45LEDF	\$290
	½	39	¾	3	1	TL39LEDF	\$257
	½	27	¾	3	1	TL27LEDF	\$224







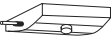
- low profile LED tasklight
- toggle on and off switch
- 4000K cool white
- 13ft cord
- dimmable
- includes attaching brackets, adhesive tape and wire manager
- recommended tasklight length for each cabinet size; see chart below

LED Tasklights

Tasklights are available for overhead cabinets. Specify separately. Grommet holes for wire management are 5/8" diameter for the LED tasklight. Refer to the chart to the right for the recommended tasklight length according to overhead cabinet width.



Overhead Width	Tasklight Model Number	Tasklight Length
96"	TL60LEDF	60"
90"	TL60LEDF	60"
84"	TL45LEDF	45"
78"	TL45LEDF	45"
72"	TL45LEDF	45"
66"	TL45LEDF	45"
60"	TL39LEDF	39"
54"	TL27LEDF	27"
48"	TL27LEDF	27"
42"	TL27LEDF	27"
36"	TL27LEDF	27"
30"	TL27LEDF	27"

Description	D	W	H	CTN WT	CU FT	① Model	List Price
31" w LED Starter Tasklight  <ul style="list-style-type: none"> • use with overhead cabinets 42" wide and larger • slim energy-efficient stand alone or starter LED lamp • soft touch switching with instant on to fade way off • infinite dimming with last state memory (dimming range 100% to 15%) • automatic time off after 10 hours • includes power supply • ETL listed component • GSA compliant • factory installation optional (no additional charge); please specify unit where light is to be installed 	2	31	½	4	1	TL31LED-S	\$525
31" w LED Linking Adder Tasklight  <ul style="list-style-type: none"> • use with overhead cabinets 42" wide and larger • slim energy-efficient LED lamp for linking to a starter tasklight • string may contain 1 starter with up to five adders • soft touch switching with instant on to fade way off • infinite dimming with last state memory (dimming range 100% to 15%) • automatic time off after 10 hours • ETL listed component • GSA compliant • factory installation optional (no additional charge); please specify unit where light is to be installed 	2	31	½	4	1	TL31LED-A	\$410
17" w LED Starter Tasklight  <ul style="list-style-type: none"> • use with overhead cabinets 30" wide and larger • slim energy-efficient stand alone or starter LED lamp • soft touch switching with instant on to fade way off • infinite dimming with last state memory (dimming range 100% to 15%) • automatic time off after 10 hours • includes power supply • ETL listed component • GSA compliant • factory installation optional (no additional charge); please specify unit where light is to be installed 	2	17	½	2	1	TL17LED-S	\$405
17" w LED Linking Adder Tasklight  <ul style="list-style-type: none"> • use with overhead cabinets 30" wide and larger • slim energy-efficient LED lamp for linking to a starter tasklight • string may contain 1 starter with up to five adders • soft touch switching with instant on to fade way off • infinite dimming with last state memory (dimming range 100% to 15%) • automatic time off after 10 hours • ETL listed component • GSA compliant • factory installation optional (no additional charge); please specify unit where light is to be installed 	2	17	½	2	1	TL17LED-A	\$349
Motion Sensor for Tasklights  <ul style="list-style-type: none"> • occupancy sensor for LED tasklights • integrates with TL31LED or TL17LED • shuts off after 30 minutes of inactivity • connects to end of light fixture (adds 3" to length of fixture) • one sensor controls starter and connected adders 	2	3	½	1	1	TL03-OCPS	\$448

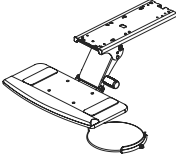
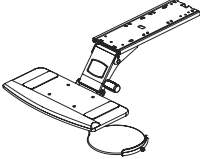
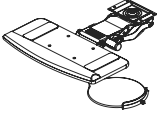
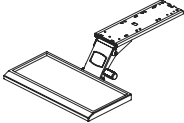

To Order, Specify:

- ① Model number

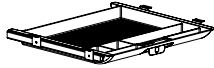
Keyboard Accessories



ACCESSORIES

Description	D	W	H	CTN WT	CU FT	① Model	List Price
Articulating Keyboard Tray  <ul style="list-style-type: none"> · articulating keyboard tray - black color · mouse tray included · 16" glide track · easy one-handed adjustment; vertical range of motion of 5.1" below glide track · tray tilt range +10 degree to -20 degree · unit swivels side-to-side · tray size is 19.4" wide x 9.4" deep · tray includes palm rest · tray is made with recyclable high density polyethylene 	13	24	7	14	2	AK2	\$520
Articulating Keyboard Tray  <ul style="list-style-type: none"> · articulating keyboard tray - black color · mouse tray included · 17" glide track · easy one-handed adjustment; vertical range of motion of 8.9"; (6.5" below the glide track and an additional 2.38" above) · tray tilt range +10 degree to -20 degree · unit swivels side-to-side · tray size is 19.4" wide x 9.4" deep · tray includes palm rest · tray is made with recyclable high density polyethylene 	13	24	7	12	2	AK3	\$550
Articulating Keyboard Tray  <ul style="list-style-type: none"> · trackless articulating keyboard tray - black color · mouse tray included · use when depth under work surface for mounting is limited; minimum of 9.38" depth recommended · easy one-handed adjustment; vertical range of motion of 5.73 · tray tilt range +10 degree to -15 degree · unit swivels side-to-side · tray size is 19.4" wide x 9.4" deep · tray includes palm rest · tray is made with recyclable high density polyethylene 	11	23	3	11	2	AK5	\$535
Articulating Keyboard Tray  <ul style="list-style-type: none"> · articulating keyboard tray - wood finish tray with black mechanism · recommended for spaces with 24" clearance side to side · mouse tray purchased separately - specify MT4 · 17" glide track · easy one-handed adjustment; vertical range of motion of 8.9"; (6.5" below the glide track and an additional 2.38" above) · tray tilt range +10 degree to -20 degree · unit swivels side-to-side · tray size is 21.75" wide x 11" deep · wood tray requires finish selection; see component finishes for the selection 	14	23	7	15	2	AK4	\$580
Keyboard Tray Mouse Pad  <ul style="list-style-type: none"> · adjusts for user comfort · 8" x 8" · for left or right hand operation · compatible with AK4 Keyboard Drawer only 	8	8	1/4	2		MT4	\$195

Description	D	W	H	CTN WT	CU FT	① Model	List Price
Wide Pencil Drawer	19 1/4	22	1 7/8	5	1	GP2219CD	\$125



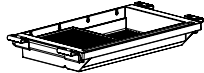
- plastic

Pencil Drawer	19 1/4	16 1/8	2 3/8	4	1	GP1619CD	\$115
---------------	--------	--------	-------	---	---	----------	-------



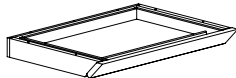
- plastic

Center Nook Drawer	8 1/4	15 1/4	2	2	1	GP1509CD	\$110
--------------------	-------	--------	---	---	---	----------	-------



- plastic

Angled Front Center Drawer	17 5/8	24 1/2	2 1/2	20	1	GP9CDRC-1524	\$409
----------------------------	--------	--------	-------	----	---	--------------	-------

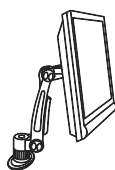


- not available on table desk with apron
- not available in makore or double cut
- wood drawer
- non-locking

To Order, Specify:

① Model number

Description	D	W	H	CTN WT	CU FT	① Model	List Price
Monitor Support Arm	12	6	17	9		AMA3B	\$646



- 360 degree swivel
- adjusts height, tilt and distance of monitor screen to user
- integrated cable management
- grommet and edge clamp mount included
- black finish
- monitor not included
- will fit monitors made to the VESA standard of 75 mm or 100 mm hole spacing in a square configuration

Conference

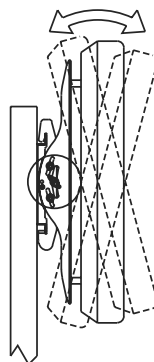
Flat Screen Mount - Universal Bracket (standard with TV, DTV and FSTV model)

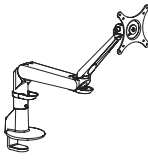
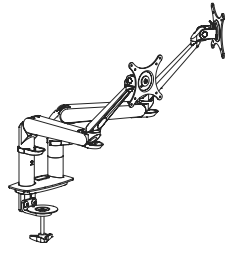
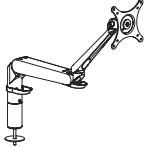
Peerless® ST650 universal tilting flat screen mount is supplied with the FSTV Flat Screen Mounting Frame.

- For use with 32"-50" screens
- Maximum weight 175 lbs. (79kg)
- Tilt 15° forward and -5° backward angles
- Mounting pattern allows up to 6" of vertical adjustment

NOTE: To verify TV interface to universal bracket

1. Access website - www.peerlessmounts.com
2. Locate "Mount Finder™" on home page side navigation bar
3. Enter make and/or model of your flat screen
4. Verify model: ST650 is listed as available model



Description	D	W	H	CTN WT	CU FT	① Model	List Price
Monitor Arm - Edge Mount  <ul style="list-style-type: none"> · mounts to edge of worksurface · silver or black 				9	1	GP5901MA	\$688
Dual Monitor Arm - Edge Mount  <ul style="list-style-type: none"> · mounts to edge of worksurface · supports two monitors · silver or black 				18	2	GP5902MA	\$1,239
Monitor Arm  <ul style="list-style-type: none"> · mounts through hole in worksurface · field drilled and field installed · supports up to 12 lbs and/or 27" monitor · silver or black 				9	1	GP5905MA	\$767

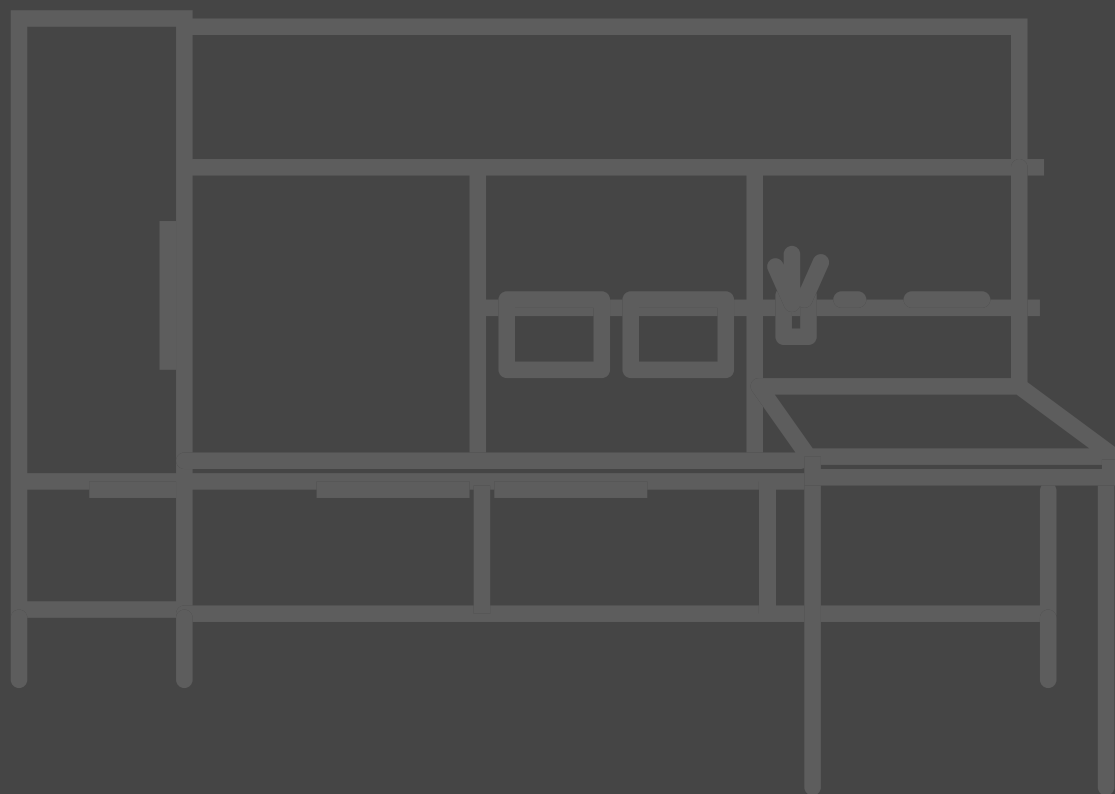
To Order, Specify:

① Model number

pricelist

effective April 3, 2023

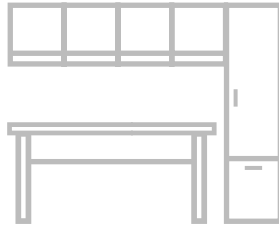
FLUX



JSI Price Lists

Tables + Casegoods

- [Apogee](#)
- [Bourne Tables](#)
- [Brogan](#)
- [Collective Conference](#)
- [Finale](#)
- [Lincoln](#)
- [Native](#)
- [Nosh](#)
- [Privacy Program](#)
- [Prost](#)
- [Reef](#)
- [Romy](#)
- [Strata](#)
- [Traditional](#)
- [Trail](#)
- [Walden](#)
- [Wellington](#)
- [Accessories](#)



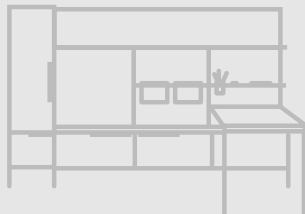
Lok

- [Training Tables](#)
- [Teamwork Tables](#)
- [Conference Tables](#)
- [Occasional Tables](#)



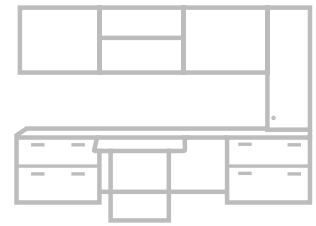
Flux

- [Private Office](#)



Vision

- [Casegoods](#)
- [Tables](#)



Seating

- | | |
|-----------------------------------|--------------------------|
| Addison | Madison |
| Americana | Melrose |
| Ansen | Millie |
| Arwyn | Moto |
| Avalon | Murphy |
| Avini | Newton |
| BeSpace | Oxley |
| Boston | Pillow |
| Bourne Seating | Poet |
| Bryn | Protocol |
| Caav | Proxy |
| Cabaret | Ramona |
| Class Act | Ria |
| Collective Motion | Sosa |
| Connect | Tara |
| Encore | Teekan |
| Esque | Totem |
| Finn | Trinity |
| Finn Nu | Tyler |
| Garvey R5 | Wink |
| Gatsby | Ziva |
| Harbor | |
| Hoopz | |
| Indie | |
| Jude | |
| Knox | |
| Kyla | |
| Laurel | |
| Mackey | |



Environmental Mission

Our vision and goal is a sustaining supplier, manufacturer and customer for the long term protection and preservation of our environment for future generations.

MISSION

To achieve this vision, we are dedicated to ensuring the health and wellbeing of all of our partners, reducing negative impact on the environment, and maintaining price structure by increasing efficiencies and reducing consumption.

JSI, and it's parent company, is an internal manufacturer and has been an environmentally conscious organization for more than 80 years.

We are proud to use wood as our primary sustainable material resource and all corporate policies and procedures support the efforts to "recover, recycle, reuse, repurpose, reduce, refuse, and re-engineer". In doing this, we are committed to the conservation of the environment and its natural resources as well as encouraging our suppliers and customers to do the same. A goal of a "Sustainable Partnership", supplier, manufacturer and customer, is essential for the long term protection preservation and sustainability of our environment for future generations.

LOCATION

Our manufacturing facilities are located in the center of Southern Indiana. With our diverse product offering and manufacturing capabilities, we provide a single source for all of your project needs allowing you to conserve our fossil fuels and reduce greenhouse gases.

PACKAGING

We place emphasis on the minimal use of disposable packaging while still providing adequate protection to the finished product. Our corrugated packaging is recyclable, reusable, and up to 100% recycled content. We reuse or recycle more than 175 tons of corrugated material annually.

REGULATORY

All of our manufacturing facilities are in compliance with applicable OSHA regulations and meet or exceed all applicable DEM and EPA regulations for air emissions, storm water and hazardous waste disposal.

MANUFACTURING FACILITIES

Our manufacturing facilities are geared toward eco-efficiency and are encouraged to continually improve and conserve. Solid wood not used in the direct manufacturing process is recovered for the operation of our dry kilns, thus reducing greenhouse gases, the use of fossil fuels, and the burden of waste placed on landfills. Composite panels not used in the direct manufacturing process are ground and sold for use as animal bedding and boiler fuel. In addition to other energy savings techniques, our manufacturing facilities use high efficient lighting, make use of power factor capacitors, and encourage all to conserve and reduce energy consumption and water usage. Condensation pumps are used to aid in water conservation as well as extending boiler life.

MANUFACTURING PROCESSES

Our finish processes utilize efficient spray guns and proper spray techniques to reduce wasted material. Excess finish material, solvents, and waste are recycled. Many of the assembly processes use water based glues that contain no hazardous ingredients.

TEXTILES

Many of our fabric options utilize up to 100% recycled content. Our leather alternative program includes selections that contain no toxic materials, plasticizers, heavy metals, or formaldehyde and have a 100% biodegradable back cloth. Some of the available panel fabric used, if discarded is a biological nutrient for the soil. Most of the components (foam, batting, and polycord) used in upholstered products are recyclable. Excess fabrics and leathers not utilized in the upholstery process go to recyclers and local charities for additional use.

WOOD

Wood is the most diverse, most process friendly, and most widely utilized natural resource in mankind's history. No other natural resource can match the environmental advantages of wood, including being renewable, recyclable, natural, carbon negative, and biodegradable. Utilizing the sun's energy, trees grow and remove carbon dioxide from the air while giving off oxygen to benefit the entire planet. Approximately 49% of wood's dry weight is carbon and harvesting mature trees in a sustainable forest, which has slowed in the absorption of carbon dioxide, allows the photosynthetic cycle to continue at full optimization and allow for the carbon to remain sequestered. We are proud to use wood as our primary "sustainable" renewable resource.

WOOD OPTIONS

Many environmentally friendly solid wood and engineered wood options are available for quote, including: Lyptus®, Plyboo®, reclaimed woods, agricultural and post-consumer waste fiber products, etc.

INDOOR AIR QUALITY

Our goal is to reduce the impact our products will have on the indoor air quality. We practice the latest technologies and utilize a third party to assure we meet this goal. GreenGuard, one of the leaders in IAQ certification, continues to certify our product offering with UL2818 - GreenGuard Indoor Air Quality certification.

PARTNERSHIPS

BIFMA
Business and Institutional Furniture Manufacturer Association

USGBC

United States Green Building Council

IIDA

International Interior Design Association

FSC

Forest Stewardship Council - Forestland

UL GreenGuard

Indiana Department of Natural/Resources - Division of Forestry - Classified Forest, Wildlands Program

Lifetime Warranty

JSI warrants to the original purchaser that each piece of furniture will be free from defects in workmanship, given normal use and care for as long as the original customer owns and uses the product. Normal use is defined as the equivalent of a single shift, 40-hour work week.

JSI will, at its option, repair or replace with comparable product within the terms of the warranty.

Exceptions to Warranty:

12 Years (from date of purchase)

- Wood Seating
- Seating Controls
- Veneer Surfaces
- Laminate Surfaces
- Pneumatic Cylinders

5 Years (from date of purchase)

- Glides · Casters · Task Lights
- Mesh/Knit Material · Foam
- Florette Plastic Frame Chairs
- Electrical Components
- Electric Height Adjustable Bases

This Warranty Does Not Cover:

- Natural variations in color, grain or texture of wood and other covering materials over which JSI has no control.
- Normal wear, color fastness, shrinkage, puddling, wrinkling and stretching of upholsteries including fabric, vinyl, leather and other textiles. This warranty does not cover any defects that may arise in the use of COM or COL upholstery materials. Textile manufacturer's warranty will apply.
- Damages resulting from transportation, improper assembly, installation, handling, accident, user modification attachments, misuse, or neglect of product care.
- Damage resulting from extreme climate conditions.
- Finish damages resulting from normal wear and tear, improper maintenance, water damage, exposure to sunlight, extreme high or low humidity or temperature, or other acts of nature.
- Damage created by loading file drawers with anything other than hanging folders.

JSI makes no expressed or implied warranties to any product and, in particular, makes no warranty of merchantability or fitness for any particular purpose. JSI will not be liable for any consequential or incidental damages under this warranty.

Unique Characteristic of Natural Woods and Veneers

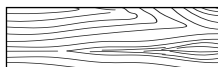
JSI uses high quality wood and veneer harvested from sustainably managed forests. Every tree has unique and defining characteristics, like fingerprints. These characteristics can be defined by differences in color, grain configuration, and textures. These characteristics will be more noticeable if the product has a clear or lighter finish.

Maple and Cherry species have a higher degree of uneven distribution of grain, small color streaks, and pin knots.

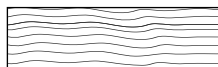
At JSI, we take care of selecting woods and veneers that are used in our products. With this in mind, we hope you appreciate the beauty of each tree's fingerprints. Products will not be replaced due to these natural characteristics.

Veneers can be sliced in a variety of ways to create unique patterns. JSI uses several different patterns, as shown below.

Flat (Plain) Cut as shown in diagram



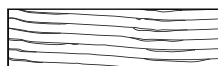
Quarter Sliced as shown in diagram



Double Cut as shown in diagram



Rift Cut as shown in diagram



Double Cut

The Double Cut veneer is a processed product that has at least two cuttings to create the final veneers. These cuts of veneer strands are dyed and layered into a block to create variation of patterns from a very tight grain pattern to an exotic figure grain pattern.

JSI uses select beech, cherry, maple, oak and walnut cut wood products to produce the desired look of our furniture products.

Laminates (Veneer Series)

An alternative HPL (Higher Pressure Laminate) laminate work surface can be specified on most of our casegood product lines. The specification pages will also list the available coordinating finishes.

Laminate Series

JSI laminate series offer a full laminated product with imprinted grain to hide finger prints and provide durability. The worksurface tops are HPL (High Pressure Laminate) or TFL (Thermal Fused Laminate). TFL is used on the product's chassis.

Please reference the featured highlights of each product line to identify the species, grain patterns, finishes for that product series

Finish - Top Coat

To reduce hazardous formaldehyde emissions, we use our proprietary specially designed top coat, DuraTex™. It significantly reduces hazardous formaldehyde emissions and helps improve indoor air quality.

Finish - Color/Stains

A wide range of stains are available to bring out the beautiful characteristics of each wood species. We coordinate finish color between our veneer stains and solid lumber stains; however, not all may be a perfect match. The stains are continually reviewed for accuracy of color, as well as a constant monitoring of the latest color trends in the furniture market.

Finish - Matching

Due to the natural characteristics of wood, environmental effects, and material upgrades, JSI cannot guarantee exact finish matches on existing furniture previously ordered.

If an exact match is required to accompany existing furniture, it must be specified at the time of order placement, so specific internal procedures can be followed to ensure a proper and acceptable finish match. We reserve the right to change our finish formula at any time to improve safety, quality, and appearance. Unless a finish match for existing furniture is requested at the time of ordering, we accept no liability for finish that may not match the existing furniture from prior orders.

Solid lumber may inherently have mineral streaks, pits, and various other natural occurrences. Care is taken in selecting the solid lumber to coordinate with the requested finish on our veneer products. This internal selection process is subject to availability of solid lumber parts.

Finish Sheen

All casegood veneer finishes are standard in 35-sheen, with the exception of Raven, which is only offered in 15 sheen. All other finishes are available in 15 sheen, with a 5% upcharge, per model

Custom/Special Finishes

JSI, upon request, will accommodate special finishes. A written request is required to proceed with custom finish orders. A sample reference is required for first time matches and must be included with the written request.

There is a one time charge of **\$372 list per order** for any non-standard wood finish.

Orders will be entered noting the special finish. A sample match will be provided to the customer. Written approval is needed before the finish process can be started. Delays in approval may have an impact on lead times.

Every effort will be made to create the requested match; however, an acceptable match may not be possible because of natural variations of wood. These natural variations can also cause minor differences in the final finish product.

Samples

Samples of standard wood finishes, paints colors, metal colors, and standard laminate are available upon request. The fastest way for requests to be filled is by using our website. See below for options to request samples.

Website – jsifurniture.com (click the resource tab)
JSI Sales representatives
Phone – 800.457.4511 – Customer Service
Email – customerservice@jaspergroup.us.com

Pricing

Prices found in this document or on our website are list prices in U.S. dollars for standard product delivery to one destination. Prices do not include storage, installation, or taxes. Possession of this price list does not constitute an offer to sell. Orders can only be received from approved authorized JSI dealers.

Prices and product information in this document, as well as our website, are subject to change without notice. Reference website for most up to date product offering and pricing.

Orders

Detailed specification pages are available in the price list at the beginning of each series.

Additional information may be obtained by consulting the Customer Service Department or our website.

Indicate shipping address if different from billing address.

Send Orders To:

US Mail – JSI
225 Clay Street
Jasper, IN 47546
Fax – 812-482-1548
Email – orders@jaspergroup.us.com

JSI reserves the right to make changes in dimensions, styles, or specifications if we believe these changes will improve the safety, quality, or appearance of the product.

Acceptance of orders will be subject to credit approval, barring any acts of governments, or any other causes beyond our control (e.g. strikes, fire, embargo of materials, etc).

Product Modifications

While we offer a wide range of products to accommodate many possible solutions, we also recognize the needs for our products to be modified from our standard offering.

In the series introduction section of each product, we address modification options for that series.

To see if the desired modification is possible, please contact our Customer Service Department for a quote. Note that order quantities and material availability can affect the quote. Additional information may be requested to fully quote modifications.

Order Acknowledgments

All orders will be acknowledged promptly upon entry of a clean order. The acknowledgment will show how the order was entered, ship date and any other information pertinent to the order. It is the purchaser's responsibility to verify all the information on the acknowledgment carefully and notify us immediately, in writing, of any discrepancies.

Every reasonable effort is made to ship as acknowledged; however, the acknowledged ship date is approximate. Company will generally ship within five (5) working days of the acknowledged ship date. If a firm ship date is necessary, customer must inform company at time of order and company will make all reasonable efforts to meet each customer's request. Acknowledged shipping dates are contingent upon the force majeure conditions contained in these terms and conditions.

Quickship

JSI offers select Vision models, with select options, in our Quickship program. These items ship within 10 business days after receipt of a clean, credit approved purchase order. Items should be placed on order separate from standard lead time models.

Product for up to 10 offices or 10 tables can be included on a single Quickship order. Available capacity is filled by orders as they are received. If normal 10 day Quickship is not available because capacity has been filled, you will be immediately notified by JSI customer service. Changes and cancellations to Quickship orders are not allowed under any circumstances, nor are modifications to the predetermined Quickship offering. Limit one order per project.

Delivery

Our freight policy consists of prepaid freight to the 48 contiguous states; all other shipments are prepaid to port of exit ONLY. JSI reserves the right to select the appropriate carrier and shipment routes, most shipments are on freight carriers that are dedicated furniture specialists. Standard deliveries require a DOCK that can accommodate **75 foot trucks**. Ownership and inspection of product is the responsibility of the buyer upon pickup by the freight carrier. Pricing in this book is for standard delivery only. Standard delivery does **not** include non-dock delivery, inside delivery, residential delivery or installation of product. Fees and changes for non-standard deliveries are listed below.

Standard Delivery Time

Between 8AM and 3PM Monday through Friday. Special delivery requests can be subject to additional fees to accommodate requests.

Cancellations and Changes

All orders are considered firm and are not subject to cancellation or change without approval from JSI. All approved changes are subject to additional charges and revised lead times

No Touch Freight

Our freight is considered "no touch". Therefore, customers are to be prepared to unload freight from inside the truck prior to arrival. In the instance that a driver must unload the shipment, driver assists fees will apply (see fees below).

On-Site Deliveries

Shipments to the installation site, and time deliveries are available on full truckloads or slightly less, at no additional charge. Shipments or timed deliveries for smaller shipments may not be available, or if available may require an additional charge.



Detention Fees

- Carriers are given two-hour maximum time allotment to unload for one-stop truckloads.
- Carriers are given one hour maximum time allotment to unload for multi-stop truckloads
- *Detention fees apply after allotted unloading time and will be at buyer's expense.

Fees

Orders of less than \$1,000 net \$90 net per order
 (If order is UPS shippable, the handling fee is waived and customer is invoiced for exact shipping charges.)
 Weekday deliveries outside of standard delivery times \$300
 Weekend deliveries (Saturday or Sunday) \$600
 Liftgate Deliveries. \$500 minimum 7% of net price
 Driver Assist \$90
 Jobsite Non-Dock Delivery \$150 per truck
 Inside Delivery (first floor inside only) - no installation or carton removal. \$250 minimum 7% of net price
 NO RESIDENTIAL DELIVERIES

Warehouse/Storage Fees

Additional storage time with a provided two-week approved notice is calculated at 3% per month of the product amount or per day.

Please be Advised

- Reconsignment fees are the responsibility of the buyer.
- Any charges arising from failure to meet shipment, re-routing while in transit or carrier storage charges are the responsibility of the buyer.
- Contact Customer Service to inquire about skidding of products, special crating of products and product installation. These requests must be approved by JSI and made at the time of order.
- Carriers have the right to refuse delivery to a specified location if it conflicts with their liability policy.

Freight Damage

JSI products are packed in cartons and meet or exceed existing codes for furniture and seating products. All shipments are delivered to the carrier in good condition and our liability ceases thereafter. If delivery arrives short or damaged, contact the carrier immediately to file a claim. In the event of concealed damage, notify the carrier and request immediate inspection. Failure to file a claim within 15 days after receipt of merchandise constitutes acceptance and a waiver of any such claims. Please inspect merchandise immediately upon receipt, otherwise there is no recourse. Keep all cartons and packing material, discarding these materials may negate your claim.

Storage of product in areas of uncontrolled humidity and temperature may cause damage to the product and void the JSI warranty.

Repairs

JSI will not issue credit allowance for any type of repairs without prior written consent.

Sales order, product model numbers, and reason for repair will be expected in order to process the repair request. A digital photo will help to expedite the request. JSI reserves the right to recommend solutions for repair.

Replacement Parts

Obtain information and pricing on replacement parts by contacting Customer Service. Please have the model number available when requesting replacement parts. Additional information may be required to ensure proper replacement parts.

Returns

JSI products are made to order and may not be returned for credit. No merchandise may be returned to JSI without a signed Return Good Authorization (RGA) form issued by our Customer Service Department. RGA's will be considered for the following reasons:

1. Manufacturing defect (validated by JSI representative).
2. JSI order processing error.
3. Shipping error.
4. Mis-marked cartons.
5. Duplicate shipments.

Liability for defective merchandise shall be limited to replacement or repair.

If you have questions as to whether your reason for return qualifies for consideration, please contact Customer Service. At the discretion of JSI, returns on stocked items may be considered with the following stipulations:

1. 60% restocking fee.
2. All return freight charges must be prepaid by dealer.
3. Product was never removed from the original carton.
4. Product must be returned within 30 days of RGA issue date.
5. Credit will not be issued if product returned is damaged.
6. Under no circumstances can we accept COD (Cash on Delivery) returns. Any such shipment will be refused.

Please note most models on Quickship are produced on demand and cannot be returned. Modified, special or custom-built product is not eligible for return.

Fire Retardancy

All JSI upholstered components comply with California Bureau of Home Furnishings and Thermal Insulation-Technical Bulletin 117-2013 issued by State of California Department of Consumer Affairs. This standard requires upholstered furniture to be safer from the hazards associated with smolder ignition in all four (4) categories of materials, as applicable.

Compliance with more stringent codes may require special manufacturing considerations and upcharges.

California Technical Bulletin 133 (CAL 133)

JSI uses a barrier material between the foam cushioning and the upholstery cover in order to comply with CAL 133. The standard upcharge on products specified to comply with CAL 133 is **\$78 list per yard** of textile.

JSI has performed a series of full scale fire tests on samples - representing worst case scenarios of upholstered units - to comply with the requirements of the state of California Technical Bulletin 133 (CAL 133). Products in compliance are labeled in accordance of the standards.

Some product designs and fabric cannot be combined to comply with CAL 133. Because of this, we reserve the right to reject any request for an upholstery cover, including COM, textile may not contain olefin or product style that we feel may compromise the integrity or safety of a product specified to comply with CAL 133.

Contact Customer Service for a quote if you require laboratory certification that a specific product and upholstery combination WILL PASS CAL 133. The quotation will include testing, video, and transportation charges plus the list cost of the sample.

Our standard lead time will apply to products that do not require certification. Allow an additional six weeks over the standard lead time for products that need actual laboratory certification.

The end user, specifier and/or dealer have the responsibility to make sure all products specified will meet the flammability and safety codes of the jurisdiction where the products will be located and used.

Flame Spread

All JSI may be required to comply with the requirements of Flame Spread based on ASTM standards/NFPA Life Safety Codes and general public knowledge are as follows:

Solid Wood - Class C
 Topcoats - Class A
 Carded Fabric - Class A
 Composite Panels - Class C
 Laminate - Class B

Plastics - According to the NFPA, the lack of stability of plastics under high temperature conditions and inherit combustibility have eliminated the use of plastics for applications requiring a flame spread rating.

Also be advised that improvements may be attained in certain instances with the addition of chemicals which may add additional costs, chemical exposure and/or compromise the integrity of the product.

Textile Carded Programs

JSI is proud to partner with Maharam, Momentum, Spradling, Stinson, Ultrafabrics, Camira and Cortina Leather. Please refer to our website for our standard patterns, along with the current grade.

<https://www.jsifurniture.com/finishes-and-materials/textiles>

Textile Grade-In Programs

For the convenience of our specifiers, we offer an extensive graded in program. Please reference our website for the most up to date information on our graded in program.

<https://www.jsifurniture.com/resources/textile-partner-info/overview/>

For additional specifications on the pattern or to order memo samples, please contact the textile suppliers directly:

Arc Com www.arc-com.com
 Camira www.camirafabrics.com
 Designtex www.designtex.com
 Maharam www.maharam.com
 Mayer www.mayerfabrics.com
 Momentum www.themomgroup.com
 Spradling www.spradlingvinyl.com
 Stinson www.cfstinson.com
 Ultrafabrics www.ultrafabricsllc.com
 Cortina Leather www.cortinaleathers.com

Any textile not graded in or pre-approved for COM/COL will require application test approval prior to order entry and shipment of fabric or leather to JSI. For current JSI grades and application status by series visit jsifurniture.com Resources > Graded-In + COM; jsifurniture.com Resources > Graded-In + COM.

Indicate on purchase order if JSI is to order the fabric.

Grades and availability of fabric are subject to change without notice. Changes could include but are not limited to price increase, discontinued patterns, discontinued colors, etc. See jsifurniture.com for up to date information.

Many textiles have repeats and the additional yardage required has been factored in for textiles ordered through the JSI Carded and Grade-In Programs. We reserve the right not to match textiles with a horizontal or vertical repeat greater than 17". Additional charges may apply for textile being applied with special instructions.

Some fabric thickness or stiffness may cause issue with proper upholstering of tackable wall panels or upholstery privacy screens. Please contact customer service with concerns on the fabric thickness for these items.

COM/COL Address

JSI
 Attn: COM/COL Department
 Receiving B
 Dock 71
 201 East Martin St.
 Orleans, IN 47452

Tag: Dealer Name / Purchase Order #

General COM Fabric/COL Hide Policy

Refer to the COM/COL Price Columns for list prices.

All yardage requirements listed in the price list are based upon 54" plain non-directional material. Additional yardage may be required based on fabric repeat and matching.

All square footage requirements for COL are based on an average hide size of 50 square feet.

Contact Customer Service for any of the following conditions:

- + approval of COM/COL to be used (see policy on the next page)
- + fabric repeats greater than 3"
- + fabric less than 54" wide
- + leather hides smaller than 50 square feet
- + special application requirements request

When requesting information from Customer Service on COM/COL please supply the following information:

- + model number and quantity of the product the COM/COL will be applied
- + COM/COL textile supplier's name
- + name of pattern and color of the textile
- + any special application request

Visit jsifurniture.com Resources > Graded-In + COM to see if the textile has already been approved. If there is no record for this particular textile then a Memo Sample will be required.

JSI takes no responsibility when additional materials must be ordered.

COM Fabric Repeat Guide

Roll Width	Plain Fabric	1" - 5" Repeat	6" - 10" Repeat	11" - 15" Repeat	16" - 20" Repeat	21" - 30" Repeat	31" - 40" Repeat	41" - 50" Repeat
54"	0%	10%	15%	20%	25%	30%	40%	50%
53" to 51"	15%	20%	25%	30%	35%	40%	50%	60%
50" to 48"	30%	35%	40%	45%	50%	55%	70%	90%
47" to 36"	60%	65%	70%	75%	80%	85%	100%	120%

The percentage represents the additional fabric yardage that needs to be added to the COM yardage. Contact Customer Service for repeats greater than 50".

All COM/COL must meet applicable codes and regulations, including TB117-2013. By selecting COM/COL, customer certifies that the material meets such codes. JSI assumes no responsibility for the applicable codes and regulation regarding flammability rating and safety rating of any COM/COL.

JSI cannot be held responsible for receipt of defective fabrics, as we apply all COM as first quality goods.

We can take no responsibility for tailoring, wear-ability or application of COM/COL textiles. Any warranty claims for the COM/COL Textile materials will fall to the original vendor of the textile, not JSI.



COM Fabric/COL Hide Process for JSI Seating

General COM Fabric and COL Hide Policy also apply.

JSI will approve or disapprove COM/COL on all products. An approval of a textile from JSI makes no claim that performance, durability or tailoring of COM/COL will result in satisfactory upholstery. Every effort will be made to meet customer's expectation, but fabrics/leathers have unforeseen inherent characteristics that may limit JSI's ability to deliver a well tailored product.

Approval COM Textile/COL Hide Process for Seating

Follow the Steps Below:

1. Send a Memo Sample of the COM/COL (recommended memo be at least 4" x 4")

JSI

Attn: COM/COL Approval Department

201 East Martin Street

Receiving B, Dock 71

Orleans, IN 47452

2. Call our Customer Service Department at 812-482-3204 to request an electronic version of approval form.

Guide Order Form for COM and COL

Please send sample to:

JSI

Attn: COM/COL Approval Depart.

201 East Martin St.

Receiving B, Dock 71

Orleans, IN 47452

① Order Information:

Quote #: _____ Purchase Order #: _____

Customer Service: _____

Dealer Name/Project Name: _____

Contact: _____

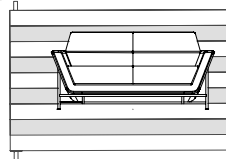
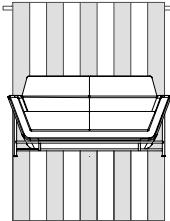
Address: _____

Phone: _____ Email: _____

Model Number(s) Receiving COM / COL: _____

② Select off the bolt application: (Check one of the boxes)

Up the roll (standard on most seating) Railroaded



③ Additional information:

④

Attach sample here.

JSI will review and test as needed all requests. You will be notified as soon as results are documented by our review personnel. JSI reserves the right to reject any COM/COL on our products. We will provide COM/COL explanation of any unapproved textile whenever possible.

Custom Options

Wood Laser Engraved Back

Many of our seating models are available with a custom wood laser engraved back. University seals, logos, unique designs, or any type of graphic can be designed into the seating back for a custom creation. Copyright approval may be required. Consult JSI Customer Service for pricing and artwork specifications. Artwork must be submitted as a JPG or PDF file.



Wood Laser Engraved Back General Pricing

* must order plain back when choosing these options

For Artwork 4" x 4" or Less	\$56 list per chair
For Artwork Less than 6" x 6"	\$99 list per chair
For Artwork Larger than 6" x 6"	Call For Pricing

For orders fewer than 50 pieces, add \$153 list per design, per order. This pricing reflects etching (leaving the wood dark). If additional painted colors are added to artwork please call customer service for pricing.

A \$134 list set-up fee applies.

Care and Maintenance

Care and Maintenance

Care of Upholstery Surfaces

Cleanability will vary based on the fabric type. For best results, a professional service is recommended. Dirt and crumbs may be gently brushed or vacuumed off. Spills should be wiped up immediately with a cloth. Vinyl textiles can be cleaned with warm soapy water and then wiped down with a warm damp cloth. For more details on any JSI carded fabric and vinyl, please visit our website at jsifurniture.com or consult the back of the appropriate swatch card for cleaning codes and any specific instructions. For COM materials, consult with the individual textile manufacturer for cleaning codes and any specific instructions pertaining to your particular fabric.

Maintenance of Mechanical Parts

Clean any lint or debris from the moving parts of the base mechanisms. Mechanisms have been designed and tested to not require lubrication under normal conditions; however, lubricant can be used if needed.

Care of Wood Edges and Veneer Surfaces

Clean all surfaces frequently with water dampened soft cloth, moving the cloth with the grain direction. Immediately remove any liquids that come in contact with wood surfaces with a blotting action to absorb liquid. Buff dry. Lift objects to move them, never pull them across the finished surface. For an additional safeguard, use a protective surface pad. This will ensure a lasting finish by protecting your furniture from possible damage caused by pens, cups and sharp objects. Avoid exposure of furniture to extremes of heat and cold, or to wide humidity variances. Avoid exposure of furniture to strong sunlight. Avoid exposure of furniture to harsh solvents such as nail polish remover, acetates, etc., as it will cause finish deterioration. If using a protective glass top, place spacer pads under the glass top to allow the wood to breath.

Care of Metal Finishes

Wash you powder-coated item at least one every six months. Use soft rags only - No abrasives. For stubborn stains and grease marks, use soap and water mixture. Combine 1 gallon of water and 1 cup of the neutral detergent in the bucket. Mix it up by swirling one of the rags around in it. Wipe down the powder coat with a rag that has been dampened with the cleaning solution. Do not scrub, but use gentle, repetitive pressure to remove any built-up grime. Rinse the powder coat off with a rag dampened with clear, clean water. Do not spray it down, but rather wipe it off with the rag. You may need to do this several times to get all the soap off. Wipe the powder coat down with a clean dry rag. This will prevent streaking and spotting.

Care of Frosted Glass

Use a clean, dry lint free cloth to wipe the surface. Follow with warm water and a clean rag; no soap or chemicals. Wipe dry with a clean, dry lint free cloth. Cleaning the frosted side is not recommended, if desired to clean use the above method but do not spray the water on the frosted side, use a clean rag. Please allow 48 hours for the frosted side to dry and not to show cloudiness.

Tempered Glass Information

JSI is aware of occasional occurrences of spontaneous glass breakage in various furniture products. Tempered glass makes it stronger and if it breaks, will cause it to break into many small pieces of "cubes" rather than sharp and potentially dangerous shards.

Glass breakage in furniture may occur for a variety of reasons. Tempered glass is particularly prone to breakage from damage (scratches, nicks, etc.) that may occur during shipping, handling, installation, use or maintenance. Exposure to rapid changes in temperature or concentrated temperature zones may also cause breakage.

Tempered glass may also break due to a specific type of imperfection or "inclusion" that occurs within the glass when manufactured. When this condition exists glass breakage may occur without any obvious cause. This is often referred to as "spontaneous" breakage but is a very isolated occurrence in the glass industry.

Care of Dry Erase Boards

Erase after every use to eliminate ghosting. Clean weekly with a Dry Erase Cleaner. Avoid the use of orange and red Dry Erase Markers. Follow manufacturers cleaning instructions for the eraser. If ghosting or staining remains use a small amount of rubbing alcohol on a clean, soft towel to remove.

Care of Solid Surface

Although liquids cannot penetrate Solid Surface, it is best to wipe up spills as they occur. Generally, a damp microfiber cloth used with a standard household kitchen spray should remove most stains.

For most residues, all you need to clean your Solid Surface countertops is a warm soapy water, ammonia-based household cleaner or a dedicated countertop cleaner. Do avoid window cleaners; however, as they can leave a waxy build-up that dulls the surface. Always clean using a circular motion.

Film will build up on countertops if water is left to dry on the surface. This film will dull the countertop surface, making the finish appear blotchy and uneven. To prevent film build-up, it is very important to wipe the countertop completely dry immediately after spills and cleaning.

Some color of Solid Surface may require more frequent cleaning to maintain a uniform finish. Darker colors tend to require more attention than lighter colors. Over time, even with proper care, your countertop will acquire a sheen. Dark colors may show light scratches more readily.

Specification Tools

JSI products are manufactured to order and provide a multitude of options to address your individual customer needs. As you process your order do not forget to include all the necessary information to allow the order entry process to be completed. Please see the order checklist at the beginning of every series.

JSI Customer Service edits every order for complete information. If details are not included with the purchase order, Customer Service will contact you to answer these questions. If information is not completed in a timely manner it will delay the entry process and could affect your product delivery date. To avoid delay in order entry and potential delay in delivery of your order, please double check the line items to ensure all selections have been completed.

To ensure completion of details on your purchase order, electronic catalogs and specification tools have been developed to aid in the process. These electronic tools include:

20-20 GIZA Studio and 20-20 CAP Studio software offers state-of-the-art design, specification, photo-realistic rendering and three-dimensional visualization capabilities for configurable products in the commercial interior design markets. 20-20 GIZA Studio and 20-20 CAP Studio are available for all JSI Casegood and Seating products, in 2D and 3D graphics and the Specifier Catalog. Updates are made monthly reflecting any changes that occurred. To be sure the most up to date information is provided on orders, users of this software program are responsible to update their catalogs.

CET Designer, by Configura is an all-in-one software solution for space planning and configuration of products. The intuitive workflow guides you through entire process from idea to reality - supporting every step of the sales process

ProjectMatrix, Inc. offers a full software solution for the contract furniture industry. Their software can help you create space plans to specifications for ease of specifying our JSI Casegood and Seating product lines. Updates are made monthly reflecting any changes that occurred. To be sure the most up to date information is provided on orders, users of this software program are responsible to update their catalogs.

GSAdvantage is a Federal Government electronic catalog site offered to assist GSA customers in specifying and pricing JSI product. Listed at this site are all contract items and prices under GSA Contract # GS-28F-0030U.

Our JSI website jsifurniture.com provides many tools to assist in the design and order selection. Included in the site are downloadable images, typicals, product symbols, brochures, contact information, price lists, sales representative locations, warranty and environmental information.

GSA Terms and Conditions



Contract Holder
Contract # GS-28F-0030U

In addition to the standard terms and conditions, the following terms and conditions apply to GSA contract.

Contract Number
GS-28F-0030U

Contract Period
June 24, 2013 - June 24, 2028

Statement of Intended Use
The furniture covered by special item number 33721 Office Furniture shall comply with the requirements defined in purchase description 3QSAB 09-608. All furniture offered under this SIN shall be GSA Chassis Grade 1, 2, 3 or NA, GSA Drawer Grade 1, 2, 3, 4 or NA, Design A B or C, as defined in 3QSAB 09-608.

Description of Special Item Number SIN #33721

Cooperative Purchasing
No

Set Aside
No

FSC/PSC Code
7125

NAICS 337211 Wood Office Furniture Manufacturing 1000 employees

Includes all furniture placed in an office, such as chairs, desks, etc. In addition, ancillary services are included, however services performed shall not be the primary purpose of the work ordered.

Lowest Price Model

SIN #	Model Number	Net Price
33721	VS-LBRKT-20	\$28.03

Maximum Order
\$250,000 net

Geographic Coverage
48 contiguous states and Washington D.C.

Point of Production
Jasper, Dubois County, Indiana
Orleans, Orange County, Indiana

Discount
Discount 61.6%* off list.

*Discount for Walden and Wellington is 61.71% off list.

Discount Quantity
Walden and Wellington only
\$300,000 to \$350,000 Net = 0.5%
\$350,001 to \$400,000 Net = 1%
\$400,001 to \$450,000 Net = 1.5%

Prompt Payment Terms
1% 15 - net 30 days from date of invoice.

Government purchase cards are accepted at or below the micro-purchase threshold

Government purchase cards are accepted above the micro-purchase threshold

Foreign Terms
Not applicable.

Time of Delivery
30-75 days after receipt of order, 90 days maximum.

Expedited Delivery
Contact Customer Service 800-457-4511

Overnight and 2-day Delivery
Not applicable.

Urgent Requirements
Contact Customer Service 800-457-4511

F.O.B. Points
F.O.B. destination, freight prepaid and allowed to 48 contiguous states and Washington D.C. excludes special delivery requirements.

GSA Terms and Conditions

Ordering Address

Jasper Seating Company, Inc. d/b/a JSI
Attn: Participating Dealer
225 Clay Street
Jasper, IN 47546
Fax: 812-482-1548
Phone: 800-457-4511
Email: orders@jaspergroup.us.com

Order Procedures:

Per contract

Payment Address

JSI
225 Clay Street
Jasper, IN 47546

Warranty Provision

Limited Lifetime

Export Package Charges

Quoted on project-by-project basis.

Terms of Government Commercial Credit Card Acceptance

Accepted.

Rental, Maintenance, and Repair

Not applicable.

Terms and Conditions of installation

12% of net purchase order for installation services up to \$250,000.00 of net purchase price.

Terms and conditions of repair parts, etc.

See warranty.

List of service and distribution points

Contact Customer Service 800-457-4511.

List of participating dealers

Contact Customer Service 800-457-4511.

Preventive Maintenance

N/A

Environmental Attributes

GreenGuard Certified and recycled wood waste and fabric remnants

Section 508 Compliance.

N/A

DUNS

00-636-7767

CCR and SAMS Registration

Jasper Seating Company, Inc. is registered
Cage Code #31881
Federal ID #35-0420370
UEI #DDJ2GKQM7M84

Product Modifications

We willingly accept customers' modifications to standard products. See product modification information by series at the start of each series under the "Product Modification" sections. If there is a modification you desire that is not listed in this section, please call Customer Service for a modification quote/price

Acceptance, Modification, Assignment

By placing this order for furniture, material or other products (sometimes collectively referred to as "goods"), customer agrees to these terms and conditions which shall prevail over inconsistent provisions in any other form or document of customer. No change or modification shall be applicable unless set forth in writing and signed by company. Neither this order nor any interest therein shall be assigned by customer except with the prior written consent of company.

Payment

Customer agrees to pay to company the amount indicated on the invoice, 1% 15 days, net 30 days from date of invoice (U.S. funds only), for goods ordered. Interest will be charged after 30 days from the date of invoice at the rate of one and a half percent (1.5%) per month. International sales will require additional payment arrangements. No goods shall be sold on consignment or conditional sales basis. Payment for the goods delivered hereunder shall constitute acceptance thereof.

Attorneys' Fees

Customer shall be responsible for all expenses and cost in connection with the enforcement by company of these terms and conditions and the cost of collection (including the fees of any collection agencies to whom the customer's account may be referred), plus reasonable attorneys' fees (which attorneys' fees shall not be less than 25% of the amount due, unless a lower amount is specified by applicable law).

Remedies

The remedies herein reserved shall be cumulative, and additional to any other or further remedies provided in law or equity. No waiver of a breach of any provision of these terms and conditions shall constitute waiver of any other breach or of such provision.

Insolvency

Company may forthwith cancel this order in the event of the happening of any of the following or any other comparable event: insolvency of the customer, the filing of a voluntary petition in bankruptcy, the filing of any involuntary petition to have customer declared bankrupt provided it is not vacated within thirty (30) days from the date of filing, the appointment of a receiver or trustee for customer provided such appointment is not vacated within thirty (30) days from the date of such appointment, or the execution by customer of an assignment for the benefit of creditors.

GSA Terms and Conditions

Limitation of Liability

The Company shall not under any circumstances be liable to the customer, owner of the goods or any third party for special, indirect, incidental, or consequential damages, including, without limitation, loss of profits or revenues, loss or damage to other property or equipment, cost of capital or of purchased or replacement goods, or expense, delay, or inconvenience cause by or arising from the purchase, sale, use, repair or inability to use the goods or by any performance or non-performance under, or breach of, these terms and conditions. The Company's sole liability for any defective goods shall be its repair or its replacement pursuant to the express warranties set forth above, or if amended, as applicable at the time of manufacture or repair of the goods. Some states do not allow the exclusion or limitation of incidental or consequential damages, so the above limitations or exclusion may not apply to all customers. Any action resulting from any breach on the part of company as to the goods or services delivered here under must be commenced within one year after the cause of action has occurred.

Returns and Allowances

Reasonable touch-up and deluxing is the dealer's responsibility. The Company will not make allowances for trip or delivery charges, but will only make allowance for actual work performed to correct manufacturing defects. Allowances maybe authorized only by a company officer. It is the responsibility of the field sales representative to inspect any defective merchandise and make suggestions and recommendations as to the proper disposition. Field personnel cannot obligate or bind the company by definite agreement, without final authorization by a company officer. Company will not accept automatic charge backs which do not have prior authorization. All defects must be called to the company's attention upon arrival at the customer's "ship to" destination. To initiate any type of claim or request for parts, it is imperative to have the model number or fabric number, which may be located on the tag attached to the frame of the unit. Authorization for return to the company via a return goods authorization. Company will not issue credit allowances for any repairs without company's prior consent. Under no circumstances shall the company accept COD (cash on delivery) returns, and any such shipment will be refused.

Security Agreement

The Company may require and customer shall grant a security interest in goods sold pursuant to any credit the company may extend to the customer.

Governing Law

All disputes between the parties, whether or not arising out of these terms and conditions, will be governed by the laws of the state of Indiana. Customer agrees to submit to the jurisdiction of and agrees all lawsuits relating to any disputes between the customer and the company will be brought only in a state court located in Dubois County, Indiana or the United States District Court for the Southern District of Indiana. The customer hereby waives the right to a trial by jury in any action, proceeding, claim, or counterclaim whether in contract or tort, at law or in equity, arising out of or relating in any way to these terms and conditions and all other disputes between the parties.

Mitigation

If the company repossesses the goods prior to payment by the customer of all amounts due hereunder, the company may sell the goods, as is, where is, free and clear of all rights of the customer at either public or private sales, and apply the net proceeds (after deducting expenses of repossession and sale) to the obligation of customer hereunder. The customer may dispose of the goods in any commercially reasonable place and manner and the customer waives any notice of time, place and manner of sale.

Integration

This order for goods, including these terms and conditions, along with any credit application, invoice, statement, dealer contract, acknowledgment, bill of lading (and any exhibits, addenda or amendments thereto) of which this order may be a part, constitutes the sole and complete agreement between the company and the customer with respect to the purchase of the goods.

Dimensions/Specifications/Finishes

All dimensions are approximate and may vary due to the upholstery technique of each craftsman. If exact dimensions are required, it is necessary for the customer to state such specifications with the order. Detailed specifications sheets are available for each series of goods, and customer should consult the company's customer service department for these specification sheets. Company reserves the right to make changes in dimensions, style, or specifications if company believes these changes will improve the goods' quality or appearance. Company reserves the right to substitute hardwoods due to availability at production. Due to the natural characteristics of wood, environmental effects, and material upgrades, the company cannot guarantee exact finish matches on existing goods previously ordered from company. If an exact march to customer's existing goods is required, it must be specified so that the proper procedures can be followed to ensure an acceptable finish. Company will accept no liability for the finish if this procedure isn't followed. Company reserves the right to make changes in a finish formula if company believes the change will improve the quality or appearance of company's goods.

Company's Performance of Its Obligation

The production and delivery of the goods to the extent delayed or hindered or prevented from the performance by reason of natural disasters, acts of god, strikes, lockouts, labor troubles, inability to procure materials, casualties, failure of power, restrictive governmental laws or regulations, riots, insurrections, acts of terrorism, war or other reason of a like nature not the fault of the company shall excuse for the period of the delay the company's performance and the period for the performance shall be extended for a period equivalent to the period of such delay.

General Information

Environmental Mission	II	Custom Options	VIII
Warranty.	III	Care and Maintenance.	IX
Laminate and Veneer Characteristics	III	Specification Tools	X
Samples.	IV	GSA Terms and Conditions.	XI
Order Procedures	IV		
Quickship Program.	IV		
Delivery	IV		
Freight Damage	V		
Repairs and Returns	V		
Fire Retardancy / CAL 133	V		
Textile Information / COM and COL Policy.	VI		

Flux - Private Office

Product Information

Overview	2-3
--------------------	-----

General Options

Material Offerings	5
Desk Pedestal Configurations	6
File Drawer Configurations	7
Top Edge Details.	8
Pull Options/Details	9
Casters	11
Modesty Panels	12

Applied Materials

Laminate Grain Directions	13
Veneer Grain Directions	14-15
Color Scheme	16

Product Details

Pedestal Desks	17
Peninsula Desks w/Secondary Creds.	18-20
Run-off Desks	21
Adjustable Height Desks & Tables	22-23
Credenza Options	24
Credenza Compartment Dimensions	26-27
Overhead Cabinet & Wall Panel Stack-ups	28
Wall Panel Installation	29

Product Details (cont.)

Overhead Cabinet Stack-ups	30-32
Overhead Cabinet Door Options	33
Tasklight Size Chart	33
Monitor Cabinets	34-35
Vertical Storage	36-38
Modular Components	39

Technology

Power and Data Wiring Examples.	40-41
Grommets and Power Units	42
Grommet and Power Unit Locations	43-49
Wire Manager Size Chart	50-51

Pricing Pages

Tables	52
Pedestal Desks	56
Peninsula Desks	88
Run-off Desks	112
Returns & Bridges	122
Primary Height Credenzas	128
Modular Credenzas/Pedestals	150
Kneespace Credenzas	154
Peninsula Credenzas.	164

Pricing Pages (cont.)

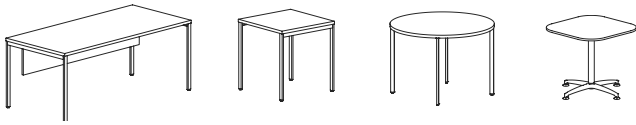
Primary Height Credenzas	168
Secondary Height Credenzas.	190
Cushions	214
Adjustable Height Units	216
Modular Units	254
Primary Height Overhead Cabinets	272
Primary Height Panels/Markerboards.	294
Secondary Height Overhead Cabinets	298
Secondary Height Panels/Markerboards.	308
Wall Mount Overhead Cabinets.	312
Wall Mount Cubbies	332
Wall Mount Panels/Tackboards.	338
Workwall Panels	354
Storage Towers.	364
Monitor Cabinets	370
Bookcases.	378
Lateral Filing.	380
Wardrobes/Vertical Cabinets.	382
Wardrobes/Vertical Cabinets with Legs	416
Pantries	444
Lockers	448

Accessories

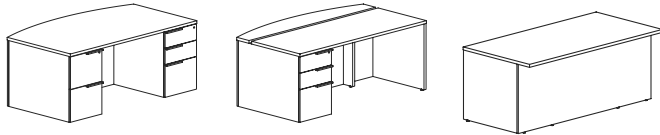
Keyboard Accessories	456
Monitor Arms	457
Tasklights	457
Drawers	458
Power and Data	458
Wire Management	460
Portable Slide on Screen.	461

Flux Overview

Tables [Page 50-53](#)



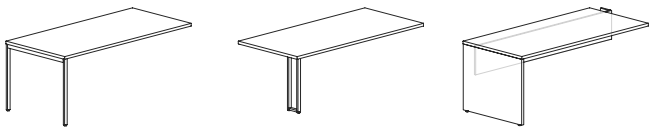
Pedestal Desks [Page 54-85](#)



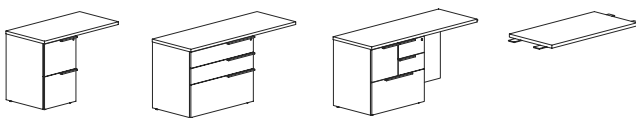
Peninsula Desks [Page 86-109](#)



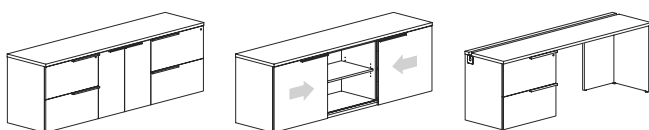
Run-off Desks [Page 110-119](#)



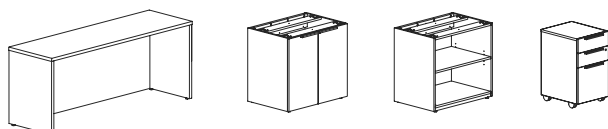
Returns & Bridges [Page 120-125](#)



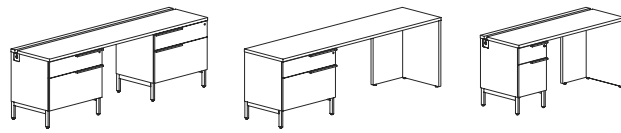
Primary Height Credenzas (to floor) [Page 126-147](#)



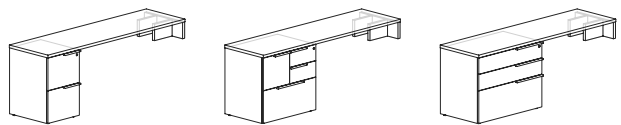
Modular Credenzas/Pedestals [Page 148-151](#)



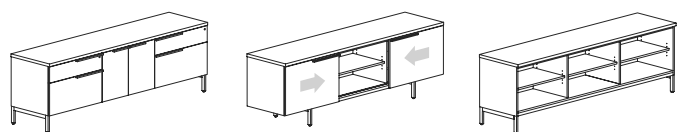
Kneespace Credenzas (on legs) [Page 152-161](#)



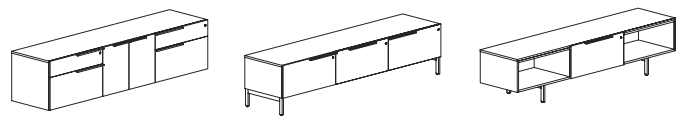
Peninsula Credenzas [Page 162-165](#)



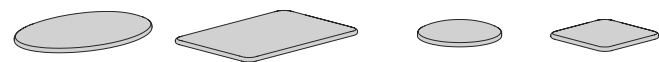
Primary Height Credenzas (on legs) [Page 166-187](#)



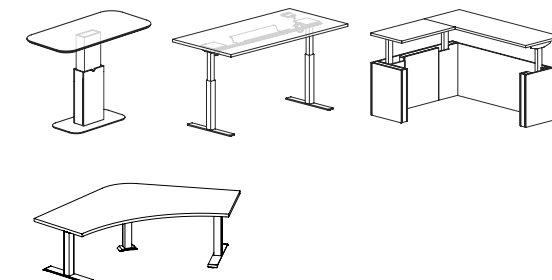
Secondary Height Credenzas [Page 188-211](#)



Cushions [Page 212-213](#)

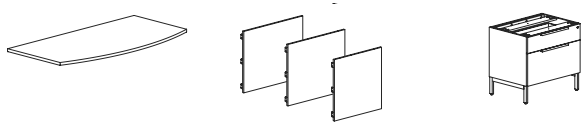


Adjustable Height Units [Page 214-251](#)

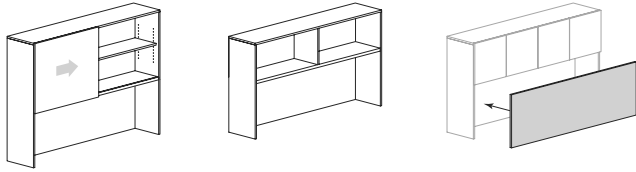


Flux Overview

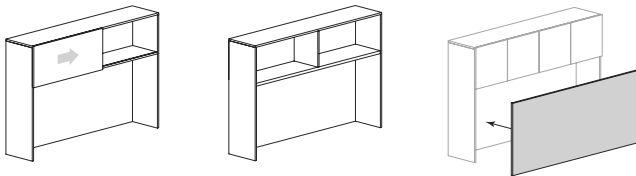
Modular Units [Page 252-269](#)



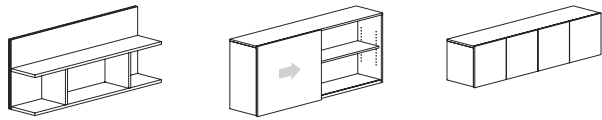
Overhead Cabinets/Panels (Primary Ht.) [Page 270-295](#)



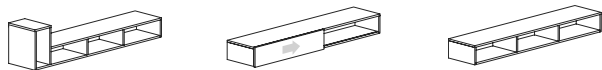
Overhead Cabinets/Panels (Secondary Ht.) [Page 296-309](#)



Wall Mount Overhead Cabinets [Page 310-329](#)



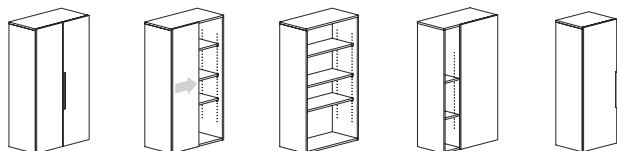
Wall Mount Cubbies [Page 330-335](#)



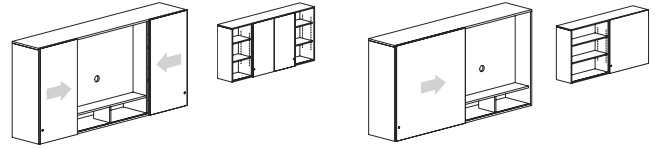
Wall Mount Panels/Accessories [Page 336-361](#)



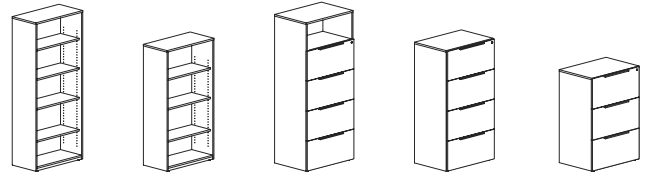
Storage Towers [Page 362-367](#)



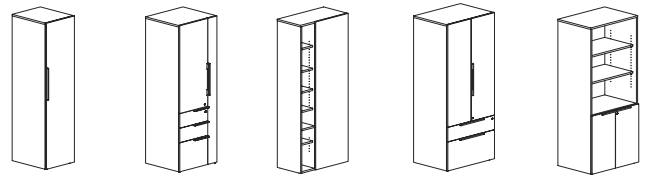
Monitor Cabinets [Page 368-375](#)



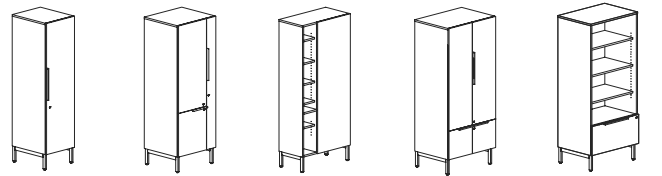
Bookcases/Vertical Filing [Page 376-379](#)



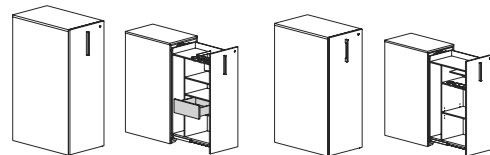
Wardrobes/Vertical Cabinets (to floor) [Page 380-413](#)



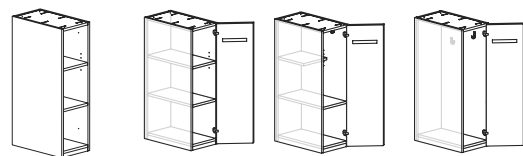
Wardrobes/Vertical Cabinets (on legs) [Page 414-441](#)



Pantries [Page 442-444](#)



Lockers [Page 446-453](#)



Accessories [Page 454-459](#)

Flux General Options

PRODUCT INFORMATION

Laminate Products

Flux Laminate features TFL (thermally fused laminate) chassis, lockers and components. Main worksurfaces* are available in a HPL (high pressure laminate).

Eased edges of the worksurface are impact resistant (PVC) on HPL tops. The laminate is offered in wood grain patterns and solid colors. The wood grain laminate features an embossed grain to hide finger prints and light scratches. The solid laminate is smooth to the touch with a semi-matte finish. All Flux Laminate products are indoor-air certified by GreenGuard.

Laminate Worksurface Construction

Worksurfaces have a 3-ply balanced construction. Tops are 1 3/16" thick with coordinating PVC edges. Primary worksurfaces feature 3mm PVC edges on the approach and user sides. Main worksurfaces are offered in HPL. Desk, bridge, return, and primary height credenza worksurfaces are profiled with a 3mm PVC edge on the user side only. Remaining edges are banded with 1mm PVC which creates a seamless appearance when units are mated end-to-end or back-to-back.

HPL Features on Main Worksurfaces*

- fusion of multiple layers create a higher impact resistant surface
- tops are 3-ply balanced construction
- matched to the TFL wood grain and solid patterns

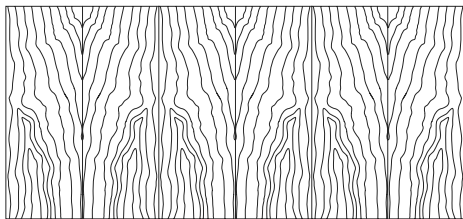
Case Construction

Panels for chassis consist of a 3/4" thick substrate with TFL surfaces and PVC bands on exposed edges. Pedestal and cabinets are constructed with dowels reinforced with screw and interior plates for increased stability. Leveling glides are set into metal housing corner plate to allow for maximum leveling.

*Main Worksurfaces include tops on desks, primary height credenzas, returns, bridges and transaction tops. Refer to pricing pages to confirm availability.

Veneer Products

Exterior wood surfaces are made from the finest selected veneers to achieve clarity and consistency in the Flux Veneer product line. To attain a pleasing, symmetrical pattern, all cherry, maple, and walnut veneers in Flux Veneer are book-matched. All exterior solid lumber is matched to coordinate with the veneer.

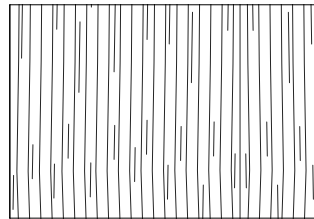


Veneer Book-Matched Example

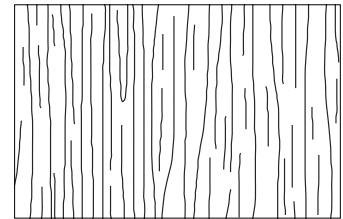
Alternating pieces of veneer are flipped over so they face each other like the pages within a book.

Flux Veneer is available in flat cut cherry, maple and walnut veneer. A wide range of wood stains have been formulated to enhance the beauty of the veneer.

Double Cut veneer is another choice on Flux Veneer product. This veneer is a processed product that has at least two cuttings to create the final veneers. These cuts of veneer strands are dyed and layered into a block to create a wide variety of patterns, from a very tight grain pattern to an exotic figure grain pattern. Double Cut veneer can be run vertical or horizontal. Please specify the grain direction.



Double Cut Veneer - Tight Grain Pattern



Double Cut Veneer - Natural Grain Example

Veneer Worksurface Construction

Tops are 5-ply balanced construction, 1 3/16" thick with matching 1.5mm wood edges. Surfaces are available in wood veneer or high pressure laminate. No additional charge for using our coordinating high pressure laminate with a veneer grain pattern with finish wood edges.

Protective Top Coat

DuraTex™ offers exceptional hardness along with abrasion and impact resistance. It has been formulated to eliminate hazardous and harmful gases that are normally associated with wood finish.

DuraTex™ Features

- Safety - Significantly reduces hazardous formaldehyde emissions which help improve the quality of the of the indoor air we breathe.
- Quality - Developed to be tough and durable with special attention to appearance. The DuraTex™ finish preserves the natural beauty of wood.
- Durability - Designed to meet a wide range of demanding performance and environmental standards to withstand even the highest wear and tear.

Special Finishes

Special finishes can be requested by following the instruction in the general introduction section, page V. There is a one-time charge of \$372 list per order.

Finish Sheen

All veneer finishes are standard in 35-sheen, with the exception of Raven. Raven is only offered in 15 sheen. All other finishes can have their sheen modified with a 15% upcharge added to the list price of each item.

Flux General Options

Flux Standard Laminate Offering

The chart below lists the laminates available on Flux.

Laminate Options

TFL - HPL Wood Grain Pattern Laminates

ALL Ale Light	MIN Mineral
BOL Bourbon Light	OAT Oatmeal Cookie
BZW Brazilwood	PIN Pinnacle Walnut
BGL Brighton Light	STU Studio Teak
CLL Collectors	UMB Umber
FAW Fawn	VAL Valley
FLO Florence Walnut	VIN Vintage
GRH Graphite	WEA Weathered Ash

TFL - HPL Solid Laminates

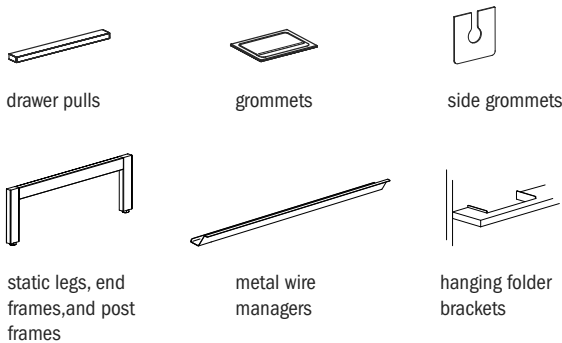
ALB Alabaster	DWH Designer White
BLK Black	SHD Shadow
BBL Bridal Blanco	SLG Slate Grey

Flux Color Scheme – Accent Colors

Metal Accents

ABZ Aged Bronze	PEW Pewter
ASL Arctic Silver	SBZ Soft Bronze
GLD Gold	SNK Soft Nickel
MBK Matte Black	

Items below are available in any of the seven color schemes listed above:

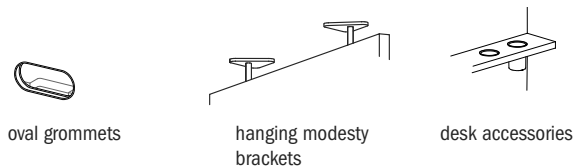


* Note: Height adjustable legs are not offered in all seven color schemes

Black Accents

MLK	Matte Black
-----	-------------

Items below are standard as matte black:



Flux Standard Veneer Finish Offering

The charts below list the veneer stains and paints available on Flux.

Finish/Stain Colors

CH1 Cherry	<i>Flat Cut Veneer</i>
BBM Bourbon Medium	CLL Collectors
BRM Brighton Medium	HRV Harvest
CLA Classic	PRL Praline

MA1 Maple	<i>Flat Cut Veneer</i>
ALM Ale Medium	FLX Flax
BUT Butterscotch	VEN Venetian

WA1 Walnut	<i>Flat Cut Veneer</i>
ESP Espresso	TRF Truffle
MCH Mocha	UMB Umber
SIE Sienna	

B01 Black Oak	<i>Flat Cut Veneer</i>
RAV Raven	

DC1 Double Cut Veneer	<i>Eased Edge Only</i>
BAR Barrel - Oak Pattern	KHK Khaki
BUF Buff - Oak Pattern	MIN Mineral - Oak Pattern
CND Cinder - Oak Pattern	RYE Rye - Oak Pattern
COF Coffee	SAB Sable - Oak Pattern
EGR Egret - Oak Pattern	SAD Saddle - Oak Pattern
FAW Fawn	STU Studio Teak
GRH Graphite	VAL Valley

PNT Paint	<i>Maple Flat Cut Veneer</i>
BKD Backdrop	GRV Greek Villa
BFX Black Fox	NET Network Gray
BWH Bright White	NWH Nonchalant White
CGP Cargo Pants	STM Storm
CHT Chatroom	TRC Tricorn Black
FRR French Roast	

Contact Customer Service for any additional veneer species. Samples available upon request.

Veneer Chassis with Laminate Tops

Worksurface only, no additional upcharge if Flux's coordinating wood grain laminate is specified. Contact Customer Service for any other laminate request. Listed below are finishes with coordinating wood grain HPL laminates.

CH1 Cherry	<i>Flat Cut Veneer</i>
CLL Collectors	
HRV Harvest	
PRL Praline	

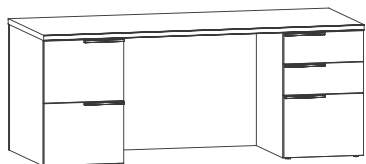
WA1 Walnut	<i>Flat Cut Veneer</i>
MCH Mocha	TRF Truffle
SIE Sienna	UMB Umber

DC1 Double Cut Veneer	
FAW Fawn	VAL Valley
MIN Mineral - Oak Pattern	

Flux General Options

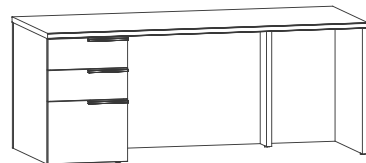
Desk Pedestal Configuration

The following are standard configurations for Flux pedestal desks.



Double Pedestal Desk

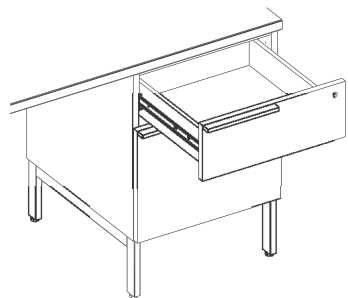
Left side: file/file
Right side: box/box/file



Single Pedestal Desk

box/box/file

The 18" w and 15- 5/8" w pedestal configuration can be switched from box/box/file to file/file or from file/file to box/box/file. This configuration change applies to desks, open corner credenzas and kneespace credenzas at primary height without legs. This must be specified on the order, with an upcharge of \$189 list per pedestal.



Drawer Information

Flux is standard with a unidirectional V-fold drawer box interior. The box is a durable, miter-fold drawer structure which is glued and doweled. The 1/2"-thick drawer sides are wrapped in a high-grade maple vinyl, with an attached front. The drawer front is attached to the four sided box.

Wood Drawer Boxes

Optional four corner dovetailed wood drawers are available. Specify and add 10% per unit.

Drawer Suspension

High quality black drawer suspension carries a lifetime warranty. File and box drawers have 100% full extension with over travel. Slides feature steel ball bearings for longer wear and positive, cushioned in/out stops.

Filing Hardware

All file drawers are constructed with a custom design for hanging folders. See filing diagram on next page.

Locking

All desks, credenzas, returns and mobile pedestals feature pedestal front locking to provide maximum security and flexibility in configuration. Units are shipped randomly keyed as standard. Key-alike units are available upon request for no additional charges. Removable cores for in-field re-keying are standard.

Lock face color is controlled by the metal color of the unit.

Aged Bronze, Gold, Pewter, Matte Black and Soft Bronze = Black Lock Face
Soft Nickel and Arctic Silver = Silver Lock Face

Interior compartment

Interior compartment sizes and specification matrix on pages 24-25 and 35.

Special Construction

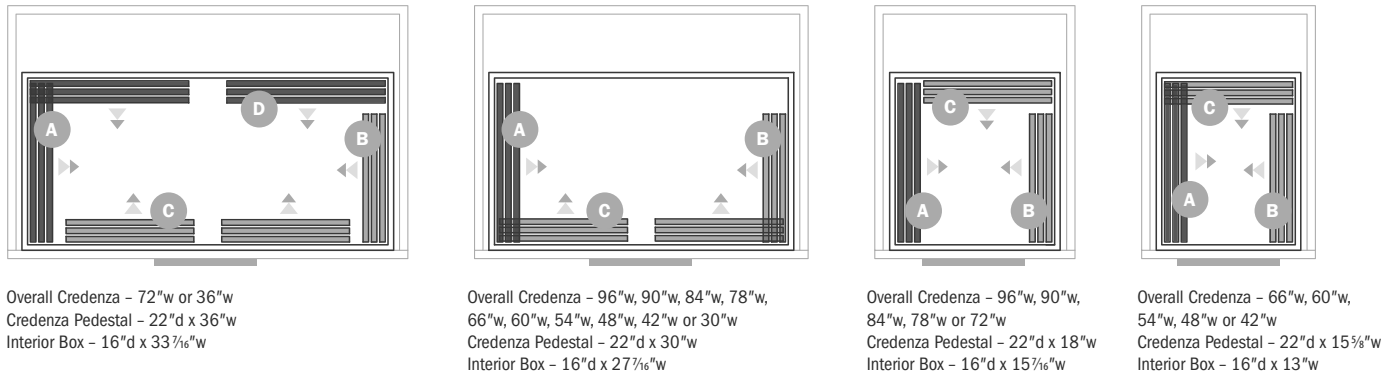
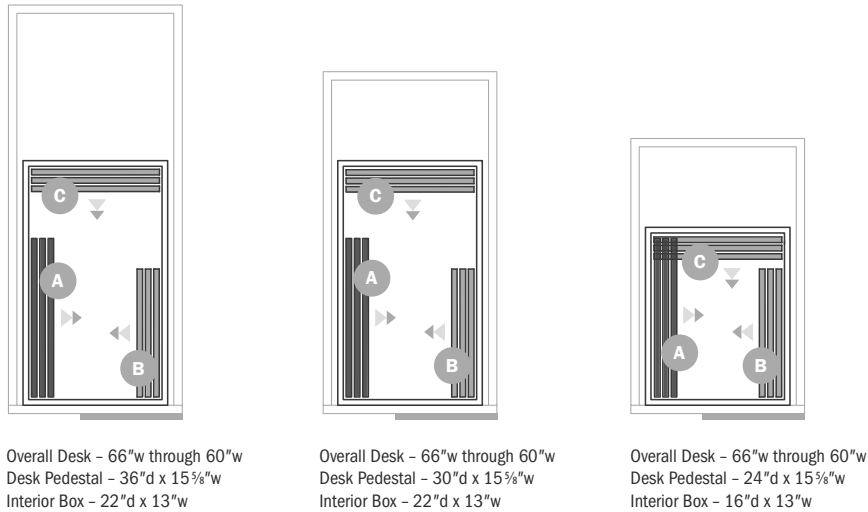
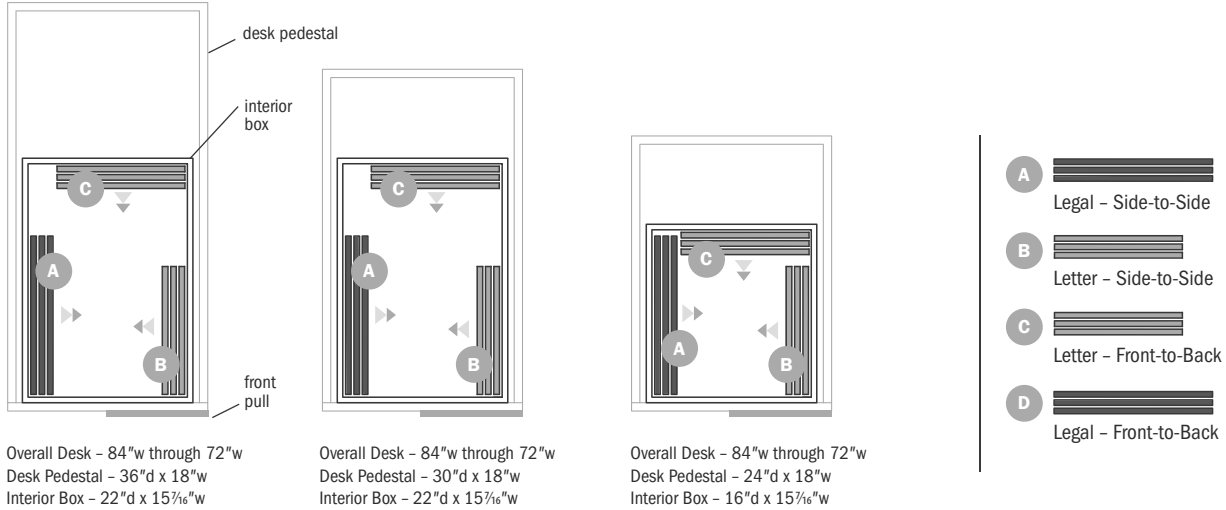
Flux has an extensive product offering to create many types of configurations. Contact Customer Service if you are having trouble with finding the right units to complete the desired configuration. Requests for special construction need to be approved by JSI engineering.

Flux General Options

Filing Drawer Details

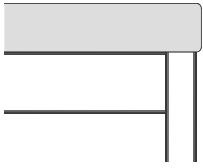
Desk and credenza pedestal filing drawers come with hardware to accommodate letter or legal files. File orientation options vary by pedestal size, as shown below. Legal and letter files may be arranged side-to-side in any pedestal, or front-to-back in larger pedestals. Select only one orientation for each filing drawer. Reference the following plan views for available options.

File Orientation Variations (top view)

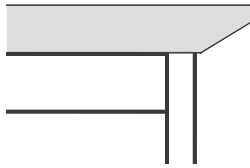


Flux General Options

Top Edge Profiles



Eased Edge
Standard on worksurface tops

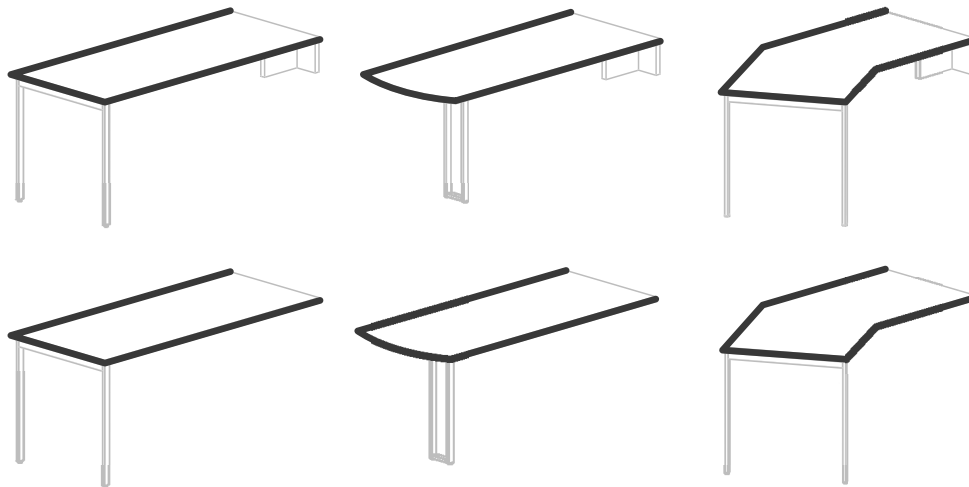


Reverse Bevel Edge
Optional on selected worksurfaces (see below)

Reverse Bevel Edge Location

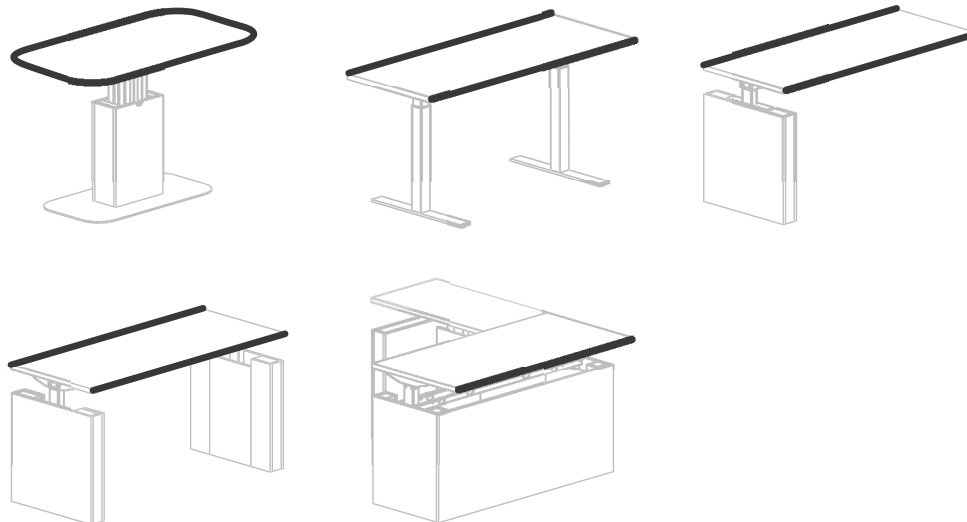
Peninsula and Run-off Desks

The reverse bevel edge appears on three sides of the worksurface top, as shown to the right, and increases the depth of the top by 2½".



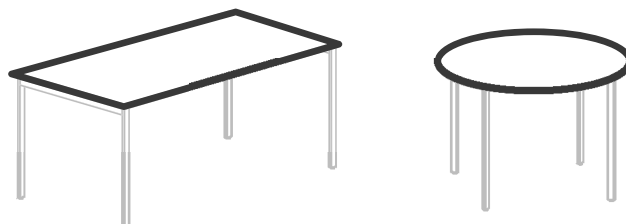
Adjustable Height Desks

The reverse bevel edge location varies according to its worksurface. When it appears on two sides, the depth of the worksurface increases by 2½". When the bevel appears on one side only, it increases the depth by 1¼". Dimension changes only happen when there is no overhang.



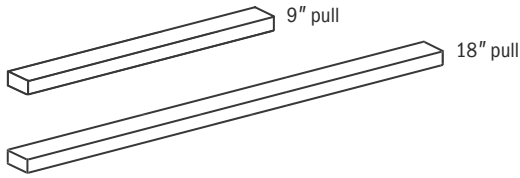
Tables

The reverse bevel edge location varies, as shown to the right, and increases the depth of the top by 2½" on the rectangle table.



Flux General Options

Pulls and Pull Orientation



Ledge Pull

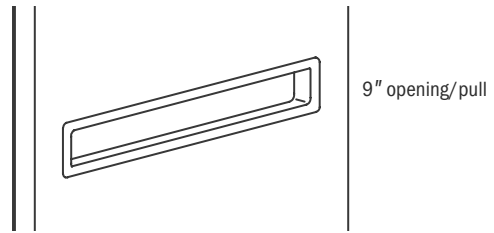
- Available in Aged Bronze, Arctic Silver, Gold, Matte Black, Soft Bronze, Soft Nickel or Pewter
- Ledge pull is considered part of the aesthetic of Flux and has unique orientation on the product. See chart below for these locations.
- Ledge pull length is determined by drawer/door width as follows:

9" pull	drawers/doors 18" wide or less
18" pull	drawers/doors wider than 18"



Prism Pull

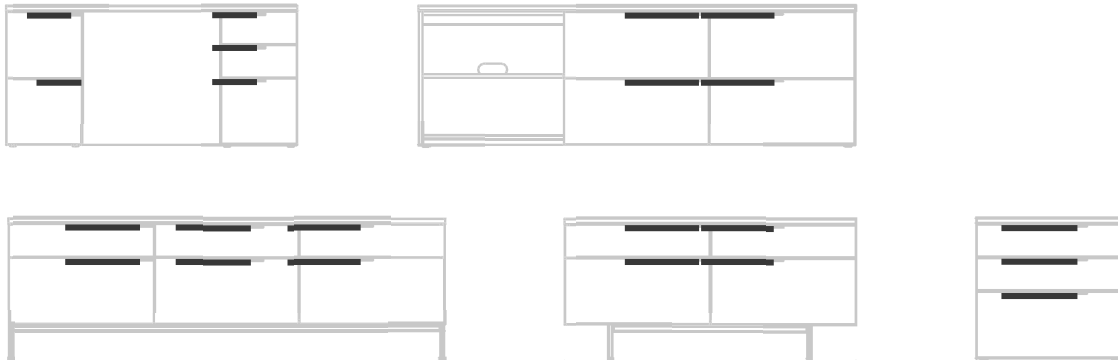
- Available in Aged Bronze, Arctic Silver, Gold, Matte Black, Soft Bronze, Soft Nickel or Pewter
- Prism pull is mounted in the center of drawers on all drawer and lower doors widths. Upper pulls on worksurface towers or wardrobes are mounted on the right door only.



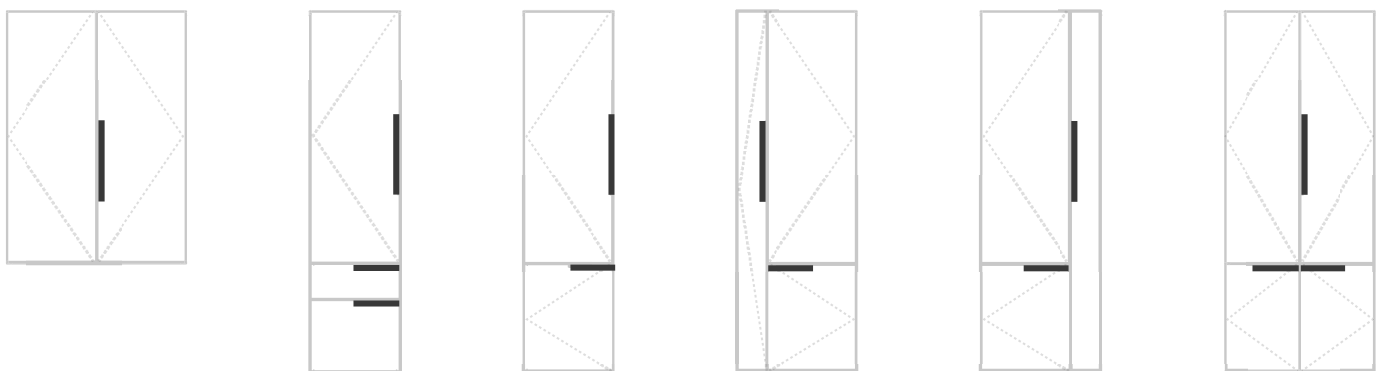
Mail Slot Pull (Lockers Only)

- In addition to Ledge and Prism pulls, mail slot is available on lockers only
- Available in Arctic Silver, Soft Nickel, Matte Black or Pewter

Lower Drawer/Door Ledge Pull Location



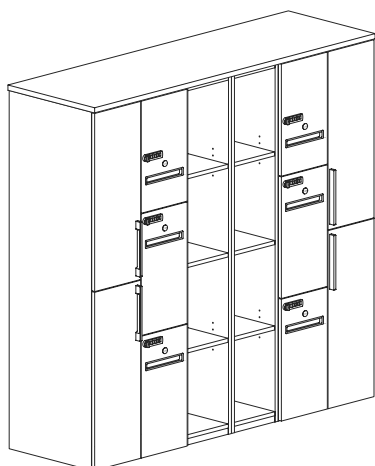
Tower/Wardrobe Ledge Pull Location



Flux General Options

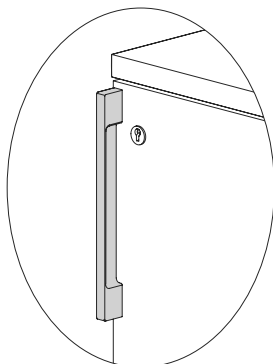
Locker Pull and Lock Options

PRODUCT INFORMATION

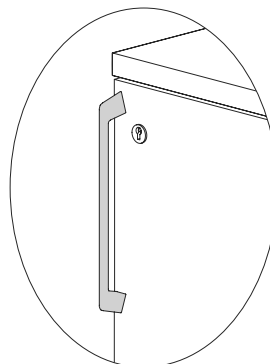


Lockers are available with a variety of pull and lock combinations.

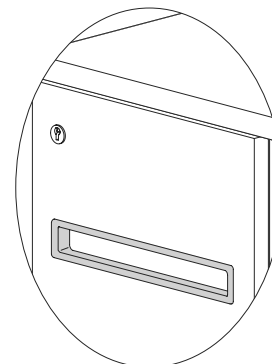
Pulls



Ledge

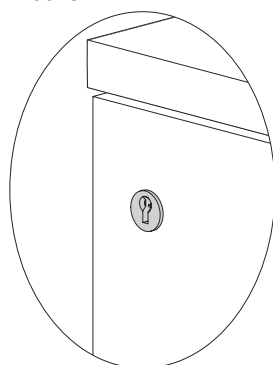


Prism



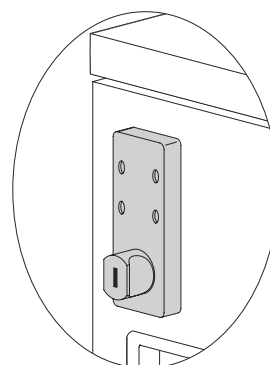
Mail Slot

Locks



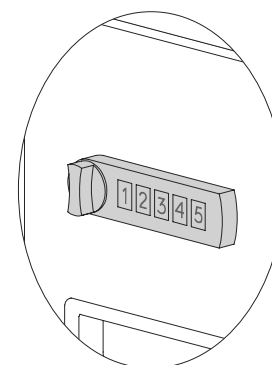
Standard

Standard lock and key. Black or silver finish. Ordered separately and field installed. Specify finish and number range. See page 455. \$98 upcharge per lock.



Keyless Radial

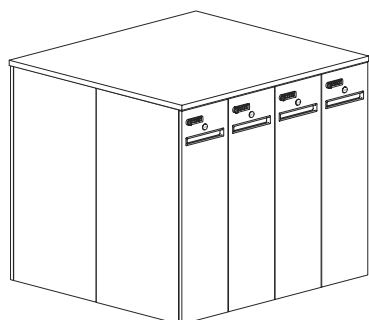
Temporary 4-digit code gets programmed by each user interaction. Built-in finger grip does not require additional pull. Prism and Ledge pulls not available. Satin Nickel finish. Master Key available, see page 455. \$351 upcharge per lock.



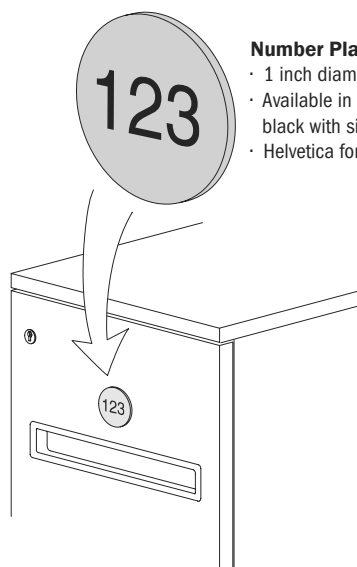
Digital Keypad

Temporary 4-digit code gets programmed by each user interaction (Locker Mode). May be reset to "Station Mode" for repeated use with a single code. Black or Silver finish. Master Key Fob available, see page 455. \$396 upcharge per lock.

Locker Number Plates



Locker number plates are available for identification. Adhesive backed for field installation. Ordered separately. Specify finish and number range, see page 455.



Number Plate

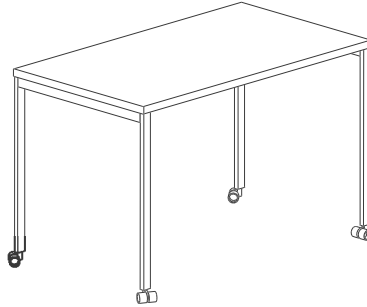
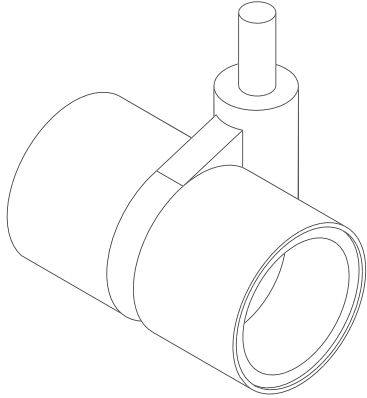
- 1 inch diameter aluminum
- Available in silver with black numbers or black with silver numbers
- Helvetica font, 1-3 characters

Flux General Options

Caster Option

Flux offers a dual wheel caster option with freestanding and four-star base tables, in place of standard feet.

Casters are gray when paired with Arctic Silver or Soft Nickel metal legs, or black with Aged Bronze, Gold, Matte Black, Soft Bronze or Pewter metal legs



Freestanding tables with legs

Available with 2 locking and 2 non-locking casters



4-star base tables

Available with 4 locking casters

Flux General Options

Modesty Panel Options

Flux offers optional modesty panels for table desks, adjustable height desks, returns, bridges and credenzas. Reference the diagrams below for the modesty panel location on each unit.

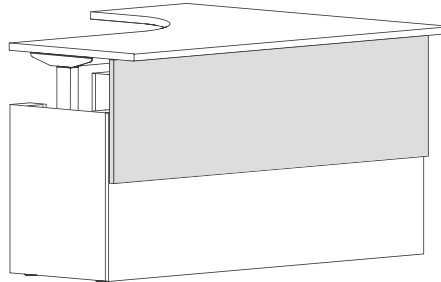
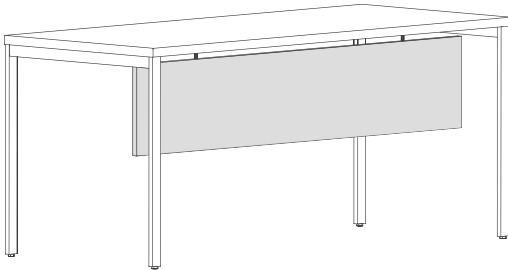
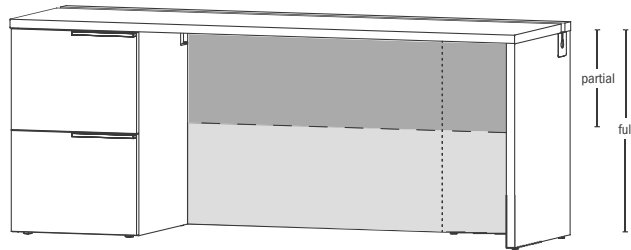
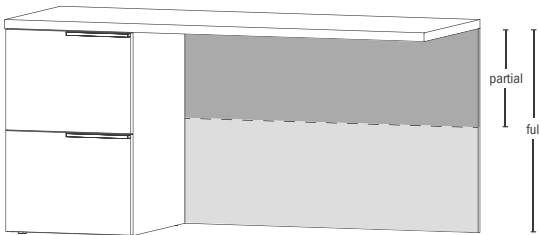


Table Desks

12" suspended modesty panels are available on table desks, peninsula desks, and run-off desks.

Adjustable Height Desks

Modesty panels are available on adjustable height desk shells. The modesty panel mounts in front of the desk and moves with the top.



Returns and Bridges

Partial or full modesty panels are available on return and bridge units.

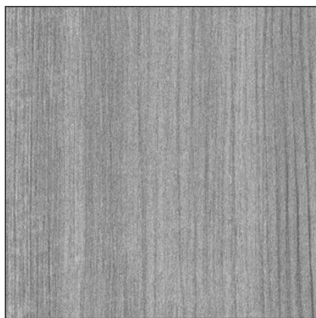
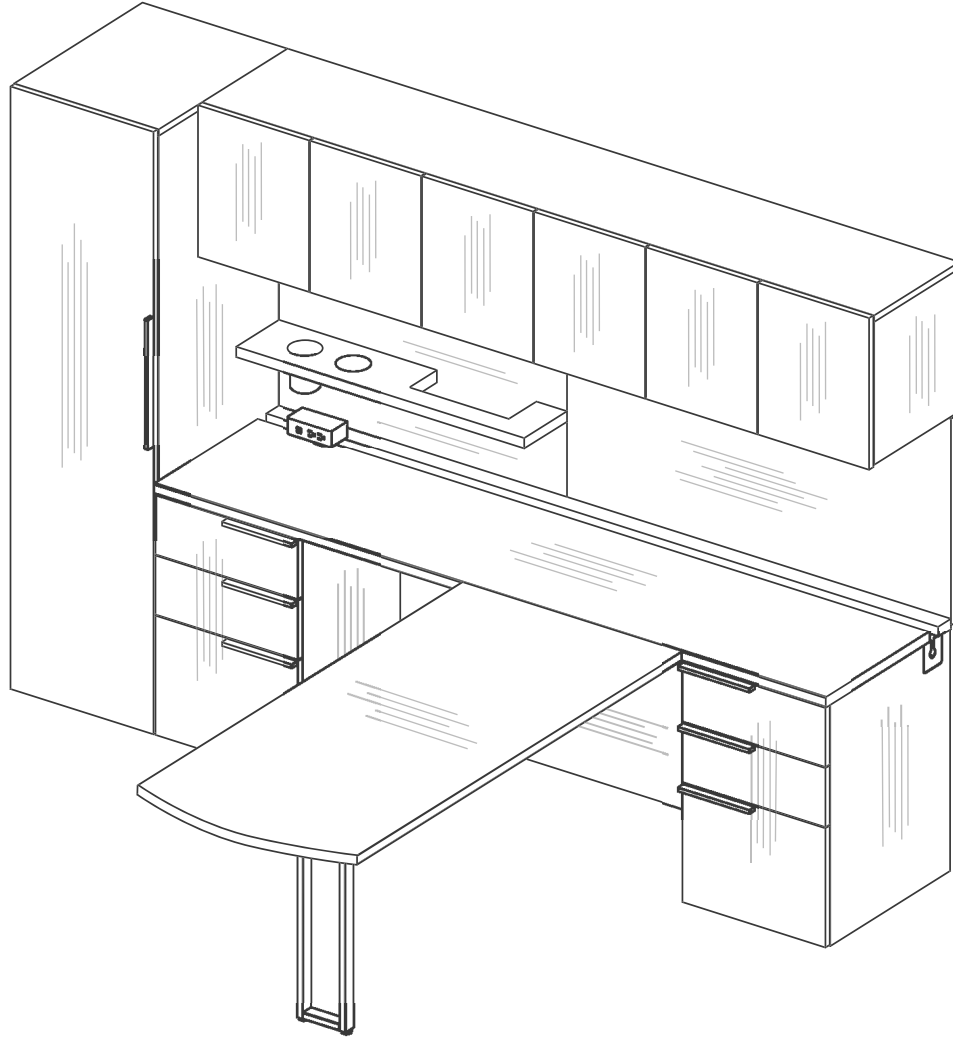
Credenzas

Partial, full or removable modesty panels are available on credenzas.

Flux Applied Materials

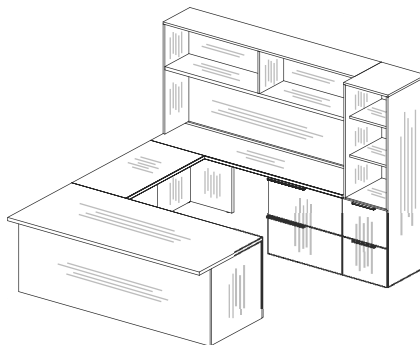
Laminate Grain Direction

Laminate grain runs vertical as standard on all vertical surfaces except back panels, wall panels, kneespace access panels, and desk fronts **wider than 60"**, **which run horizontal**. Worksurfaces run long grain except for bridges, returns, and peninsula and run-off tops **60" and shorter**, **which run short grain**. Below are typical examples of laminate grain direction.

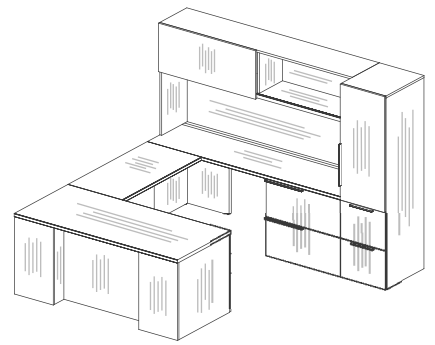


Laminate Grain

Laminate grain direction varies according to its casegood surface. Refer to the diagrams on this page for examples of standard direction.



Flush Front Desk U Unit with Open Storage

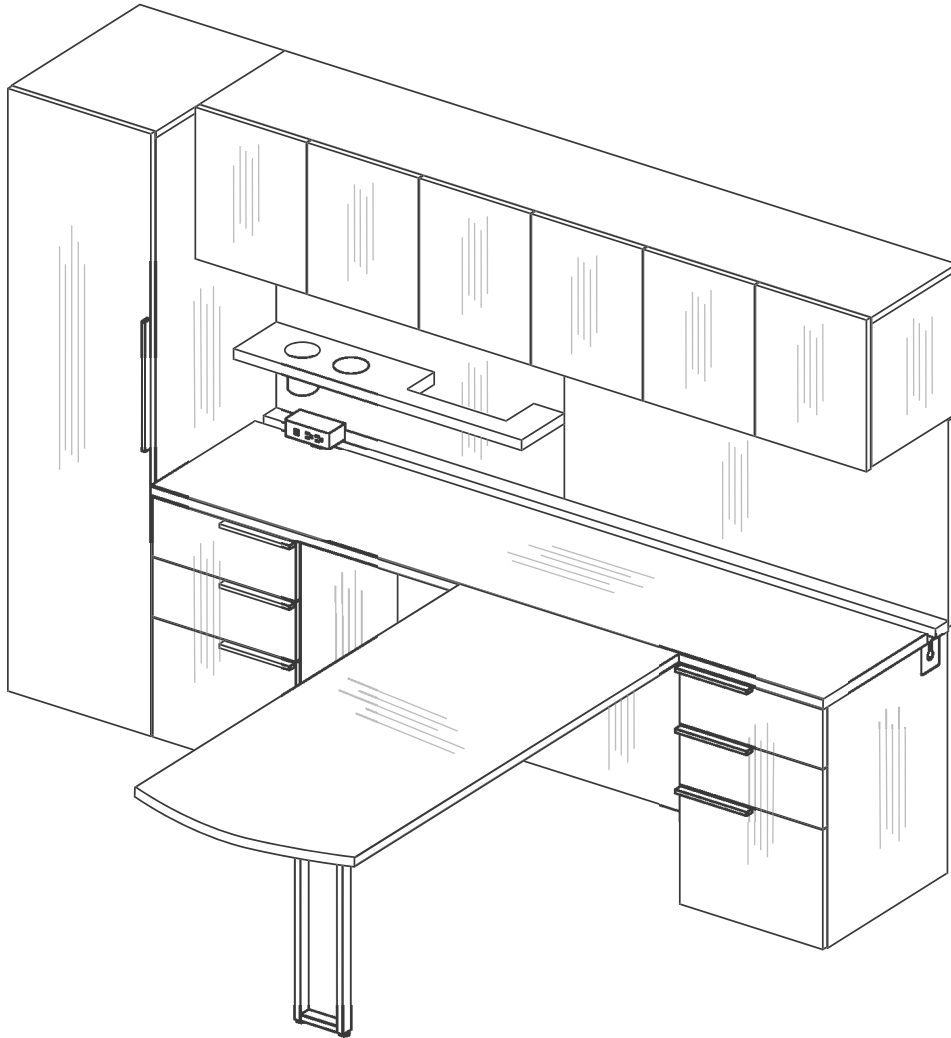


Breakfront Desk U Unit with Closed Storage

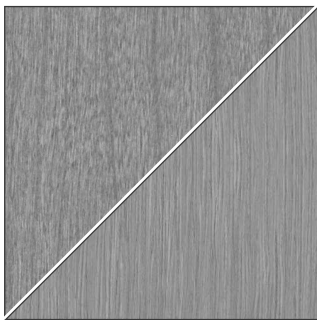
Flux Applied Materials

Flat Cut Veneer/Double Cut Veneer Grain Direction

Flat Cut and Double Cut veneer grain runs vertical on all vertical surfaces. Worksurfaces run long grain except for bridges, returns, peninsula and run-off tops, which run short grain. Below are typical examples of vertical veneer grain direction.

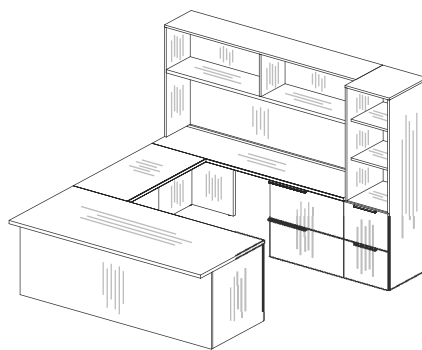


PRODUCT INFORMATION

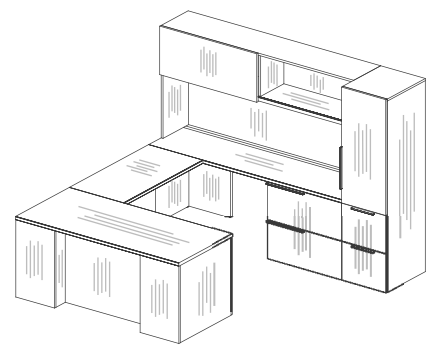


Flat Cut/ Double Cut Grain

Flat Cut grain runs vertical as standard. Double Cut grain may be specified to run vertical; specify at the time of order placement. See diagrams on this page for examples and exceptions.



Flush Front Desk U Unit with Open Storage

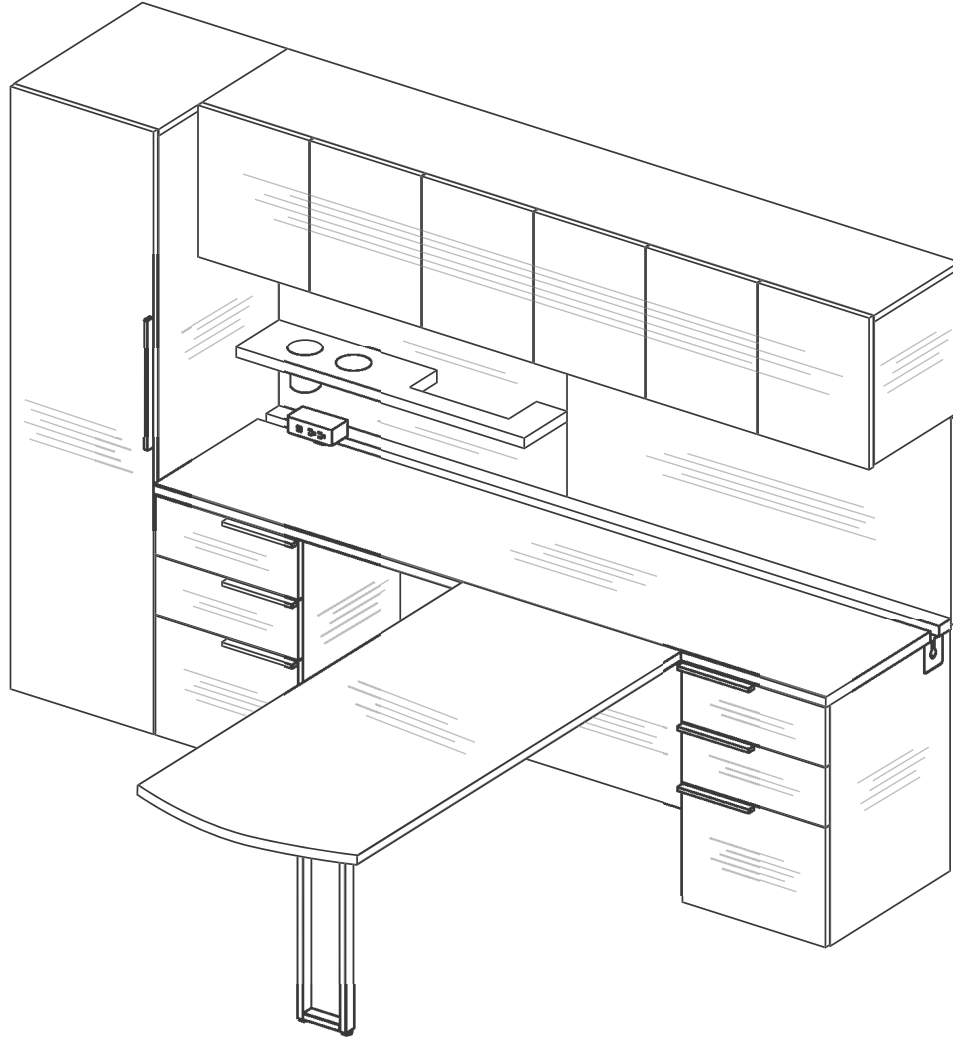


Breakfront Desk U Unit with Closed Storage

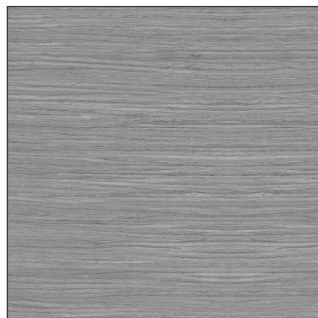
Flux Applied Materials

Double Cut Horizontal Grain Direction

Double Cut veneers may be specified with a horizontal grain direction on all surfaces. Worksurfaces run long grain except for bridges, returns, peninsula and run-off tops, which run short grain. Below are typical examples of horizontal Double Cut veneer grain direction.

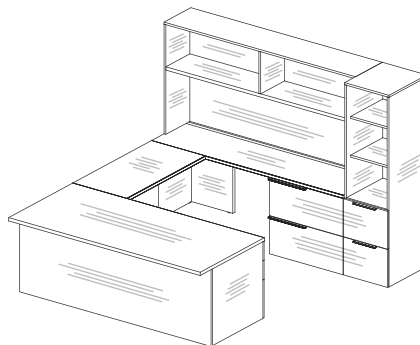


PRODUCT INFORMATION

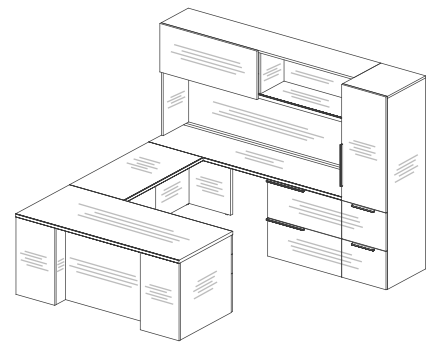


Double Cut Horizontal Grain

Double Cut grain may be specified to run horizontal; specify at the time of order placement. Refer to the diagrams on this page for examples.



Flush Front Desk U Unit with Open Storage



Breakfront Desk U Unit with Closed Storage

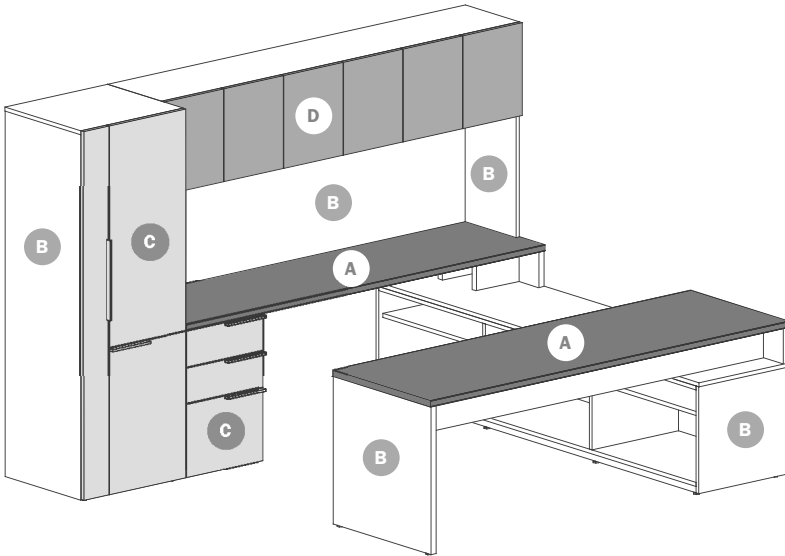
**Double Cuts with Oak Pattern are an exception to this and can not be specified to run horizontal.

Flux Applied Materials

Flux Color Scheme

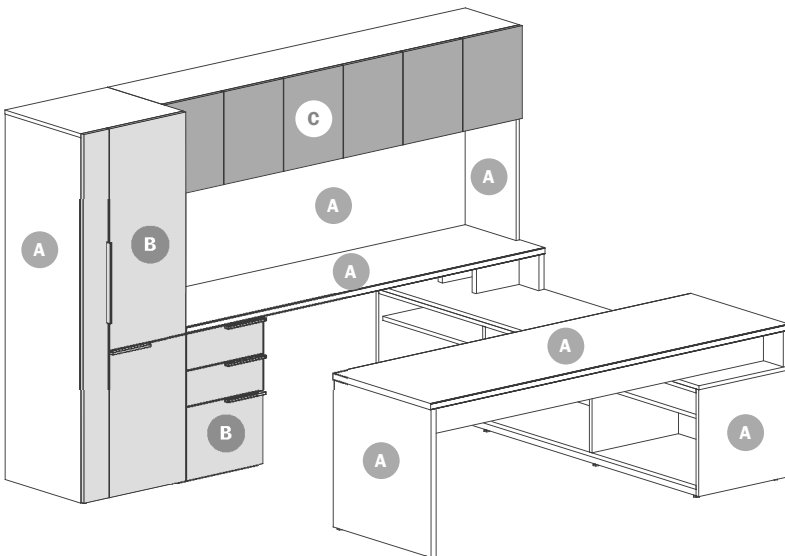
Flux offers the flexibility to specify contrasting drawer and door fronts, or a contrasting worksurface for laminates, separate from the standard chassis selection. See the options available below, depending on whether laminate or veneer is specified for the chassis.

PRODUCT INFORMATION



Laminate Surface Options

- A = Worksurface**
Laminate – see page 5 for selection
- B = Chassis**
Laminate – see page 5 for selection
- C = Drawer and Door Fronts**
 1. standard – same as chassis selection
 2. optional – contrasting laminate from standard selection
- D = Overhead and Worksurface Storage Doors**
 1. standard – same as chassis selection
 2. optional
 - a. contrasting laminate from standard selection
 - b. white back painted glass doors in an aluminum frame – see page 31
 - c. markerboard laminate with silver PVC edge see page 31



Veneer Surface Options

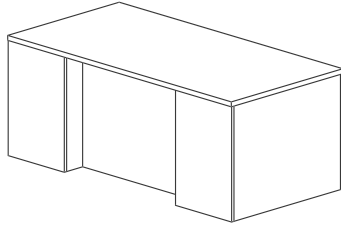
- A = Worksurface and Chassis**
Veneer – see page 5 for selection
- B = Drawer and Door Fronts**
 1. standard – same as chassis selection
 2. optional – paint color (vertical maple veneer substrate) – see page 5 for color selection
- C = Overhead and Worksurface Storage Doors**
 1. standard – same as chassis selection
 2. optional
 - a. paint color (vertical maple veneer substrate) see page 5 for color selection
 - b. white back painted glass doors in an aluminum frame – see page 31
 - c. markerboard laminate with silver PVC edge see page 31

Flux Desk Details

Pedestal Desks

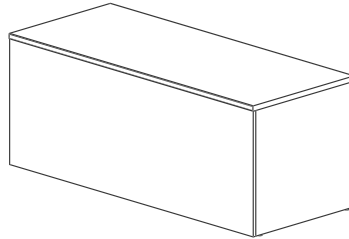
Product Overview

The Flux pedestal desk is available with a break front or flush front. Options for wire management vary depending on the selected desk.



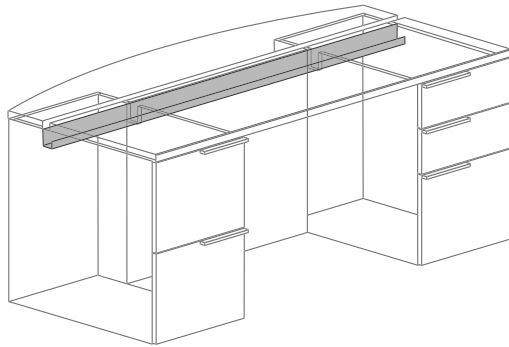
Break Front Desk

Pedestal access door optional



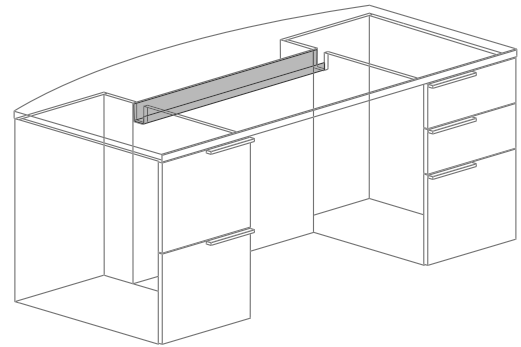
Flush Front Desk

Wire Manager Tray



Desks with a split top have a continuous wire manager tray as a standard feature.

Note: desks do not have side end panel grommets.



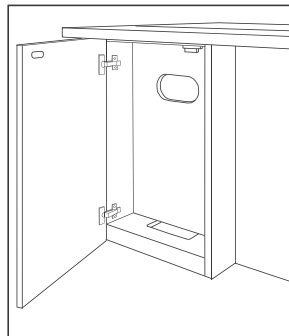
A wire manager tray can be ordered on desks with solid tops by optioning in the pedestal access door (available on break front desks) or by ordering a continuous wire manager tray.

Note: it is recommended that with either of these options, a top grommet be specified.

Pedestal Access Doors

Available on the front of break front desks to conceal cords.

Both right and left pedestals of desk will have the access door with this option.



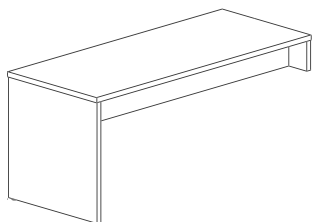
Flux Desk Details

Peninsula Desk with Secondary Credenza Support

Product Overview – Peninsula Desk

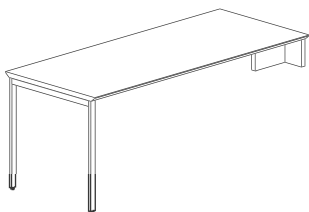
The Flux peninsula desk, which mounts to the top of a secondary height credenza for support, is available in a variety of top shapes and base styles. Edge profile and modesty panel options vary according to the style selected. Below are a few examples of top and base combinations.

PRODUCT INFORMATION



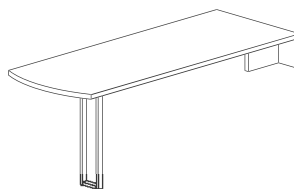
Rectangle Peninsula Table Desk with End Panel Support

Eased Edge only
Partial Modesty Panel standard



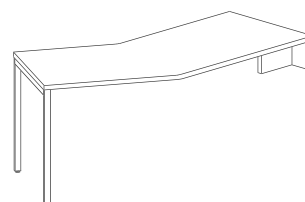
Rectangle Peninsula Table Desk with End Leg Assembly

Reverse Bevel Edge optional
Partial Modesty Panel optional



Arc End Peninsula Table Desk with Frame Base

Reverse Bevel Edge optional
Partial Modesty Panel optional



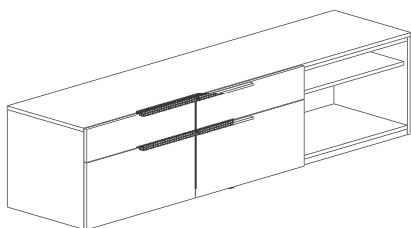
Boomerang Peninsula Table Desk with End Leg Assembly

Reverse Bevel Edge optional
Partial Modesty Panel optional

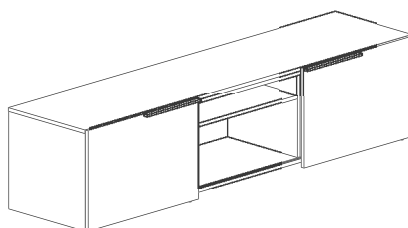
Product Overview – Secondary Height Credenza

The peninsula desk mounts to – and must be specified with – a secondary height credenza with an open compartment or sliding door compartment. See secondary height credenzas on pages 188-211 for pricing.

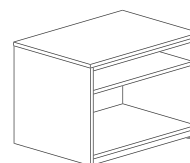
Secondary Credenza Examples



open compartment



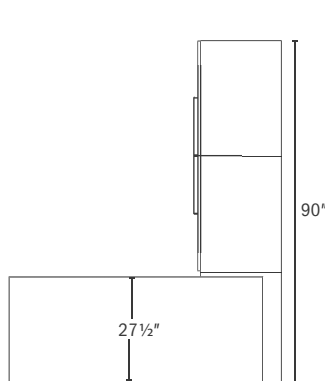
sliding door compartment



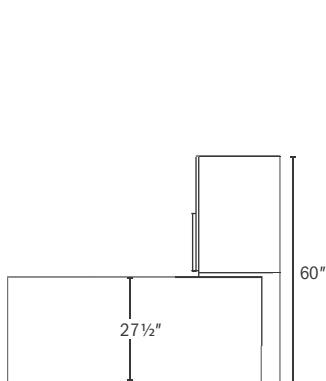
open compartment

Layout Requirements

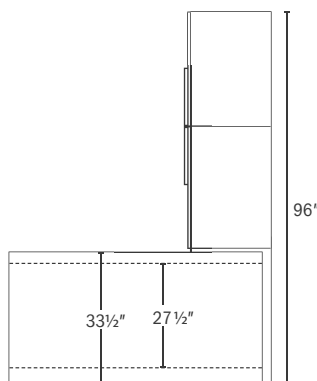
27 1/2" desk can pair with any open compartment. 33 1/2" desk pairs with an open compartment 32" or greater in width.



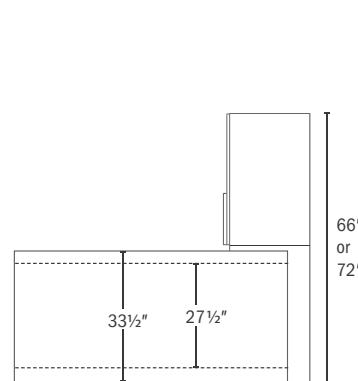
90" w credenza:
use 27 1/2" d desk



60" w credenza:
use 27 1/2" d desk



96" credenza:
use 27 1/2" d or 33 1/2" d desk



66" or 72" credenza:
use 27 1/2" d or 33 1/2" d desk

Flux Desk Details

Ordering the Secondary Height Credenza

When ordering the credenza, the mounting location for the peninsula desk must be specified as Left (L), Center (C) or Right (R), and the peninsula depth must be specified (22", 27 1/2" or 33 1/2"). A cut out for a power module in the credenza top may be specified by adding the letter E to the order code.

Mounting Code Table

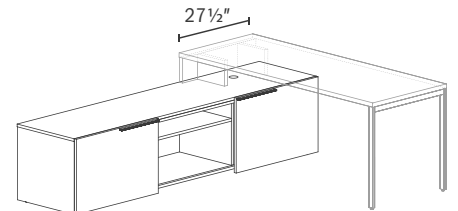
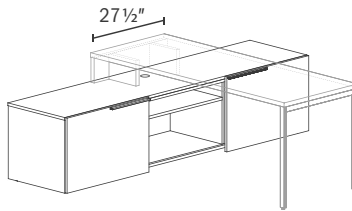
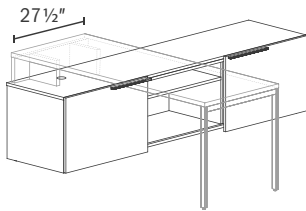
Peninsula Depth	Left Mount	Center Mount	Right Mount	Left Mount with Power	Center Mount with Power	Right Mount with Power
22"	L22	C22	R22	L22E	C22E	R22E
27 1/2"	L28	C28	R28	L28E	C28E	R28E
33 1/2"	L34	C34	R34	L34E	C34E	R34E

Mounting Code Examples

L 28 = mounts **Left**, with a **27 1/2"-deep** peninsula desk

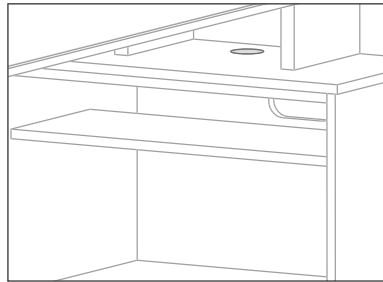
C 28 = mounts **Center**, with a **27 1/2"-deep** peninsula desk

R 28 = mounts **Right**, with a **27 1/2"-deep** peninsula desk

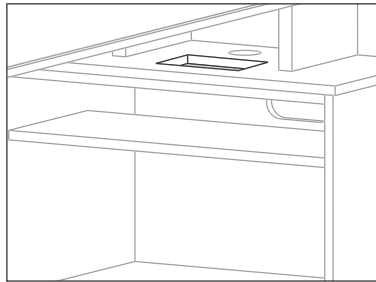


Technology Integration

Each mounting location comes with a 2 1/2"-diameter grommet for wire management. An EC26 power module cut out may also be added, and must be specified when ordering by adding the letter E to the mounting code. The power module must be ordered separately. See page 444.



2 1/2"-diameter grommet



EC26 power module cut out

Power Module Cut Out Code

L 28 E

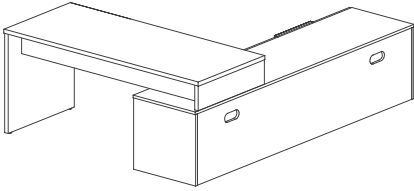
The grommet and EC26 power module locations are predetermined when selecting the peninsula mounting options; additional grommets or EC26 power modules can be specified at other locations on the secondary credenza. See page 45.

Flux Desk Details

Placement Locations

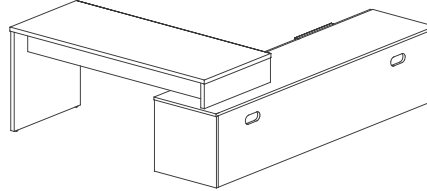
The peninsula desk may mount flush to the back panel of the credenza, or offset 5" to allow for an overhead hutch. Placement locations can be selected during field installation.

PRODUCT INFORMATION



Placement 1 – Flush with Credenza Back

Can be used when no overhead storage is specified in the layout.



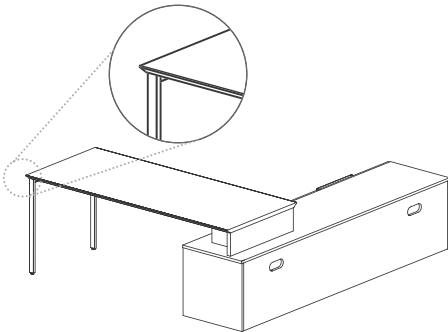
Placement 2 – Offset 5" from Back Panel

Must be used when placing an overhead on the secondary credenza.

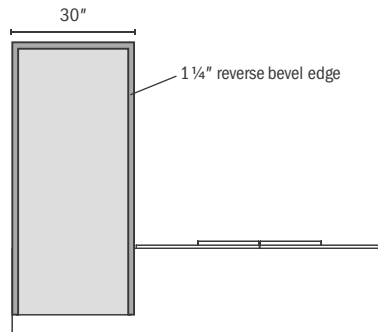
Note: the overall foot print grows by 5"

Reverse Bevel Edge Rules

A reverse bevel edge adds 1 1/4" to the front of the desk top. Overheads that mount on the secondary credenza cannot be used with peninsula desks with reverse bevel edges. For more on edge profiles, see page 8.

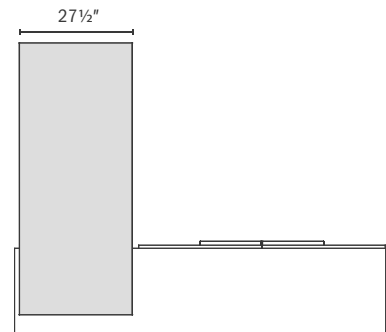


Peninsula desk with reverse bevel edge



Plan view of peninsula with reverse bevel edge

Note: lacks required space for overhead mounting



Plan view of peninsula with standard eased edge

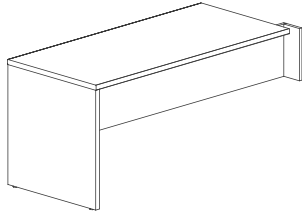
Note: allows room for overhead mounting

Flux Desk Details

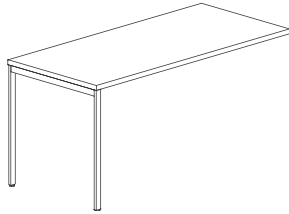
Run-off Desks

Product Overview

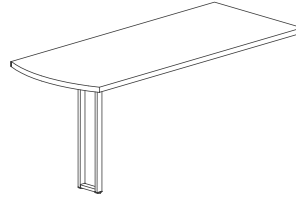
The Flux run-off desk, which mounts perpendicular to primary height credenzas, is available in a variety of top shapes and base styles. Edge profile and modesty panel options vary according to the style selected. Below are a few examples of top and base combinations.



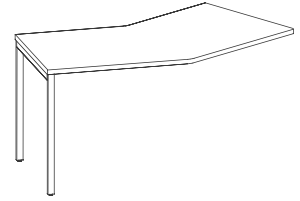
Rectangle Run-off Desk with End Panel Support
Eased Edge only
Partial Modesty Panel standard



Rectangle Run-off Desk with End Leg Assembly
Reverse Bevel Edge optional
Partial Modesty Panel optional



Arc End Run-off Desk with Frame Base
Reverse Bevel Edge optional
Partial Modesty Panel optional

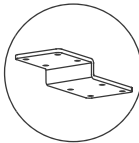
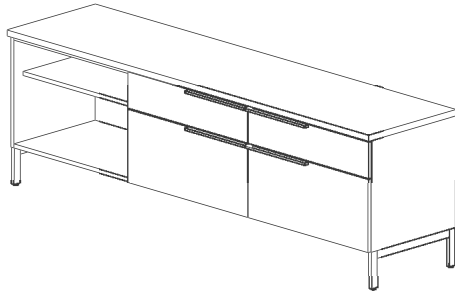


Boomerang Run-off Desk with End Leg Assembly
Reverse Bevel Edge optional
Partial Modesty Panel optional

Run-off Desk Attachment

The run-off desk mounts perpendicular to primary height units, and ships with two sets of brackets, for two types of credenzas attachments:

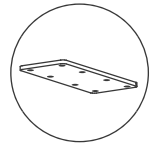
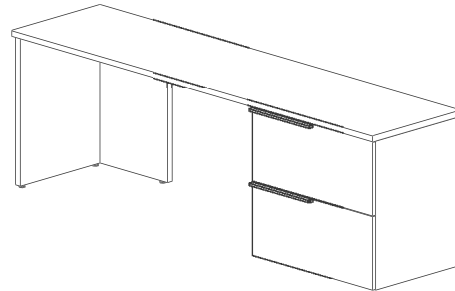
(1) Open Compartment Credenza



"Z" brackets

The run-off desk can be mounted to a credenza with open compartments. It attaches to the underside of the credenza with **"Z" brackets**. Run-off desks can not be mounted in sliding door compartments.

(2) Open Corner, Shell or Modular Credenza

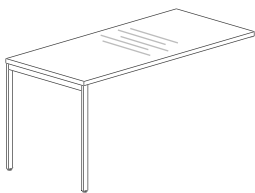


Flat brackets

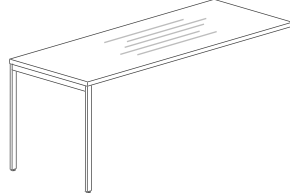
The run-off desk can be mounted to an open corner credenza, credenza shell, or modular credenza. It attaches to the underside of the credenza with **flat brackets**. Use this type of credenza with run-off desks that have End Panel Supports with standard modesty panels.

Grain Direction

Grain direction runs "short" on run-off tops, though laminate tops longer than 60" run long grain. For more details, please reference grain direction on pages 11-13



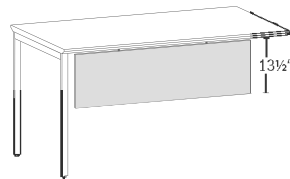
Short Grain
All veneer run-off tops
Laminate tops 60" or shorter



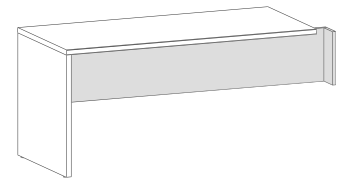
Long Grain
Laminate tops longer than 60"

Modesty Panels

13 1/2"-high hanging modesty panels are available for desks with End Leg Assembly or Frame Base. Desks with an End Panel Support come standard with an integrated modesty panel.



Hanging Modesty Panel
Optional for desks with metal bases



Integrated Modesty Panel
Standard with End Panel Support desks

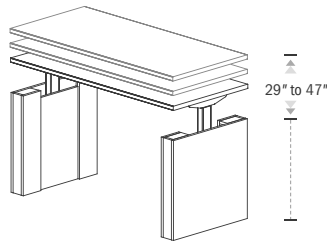
Flux Desk Details

Adjustable Height Desks and Tables

Product Overview

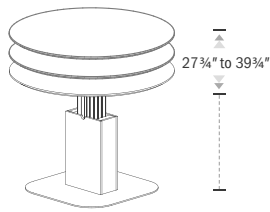
Flux adjustable height desks and tables are available in a variety of top shapes and base styles, with pneumatic or electrical lift mechanisms. Metal finishes, wire management and modesty panel options vary according to the style selected. Below are various styles with adjustable height ranges.

PRODUCT INFORMATION



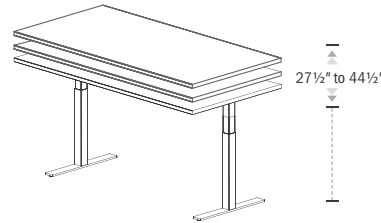
Adjustable Height Desks, Credenzas and Returns

Electrical lift mechanism
Adjustable range of 18"



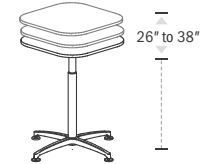
Adjustable Height Table Desks (meeting tables)

Electrical lift mechanism
Adjustable range of 18"
Round, square or rectangle shapes



Adjustable Height Tables

Electrical or pneumatic lift mechanism
Adjustable range of 17"



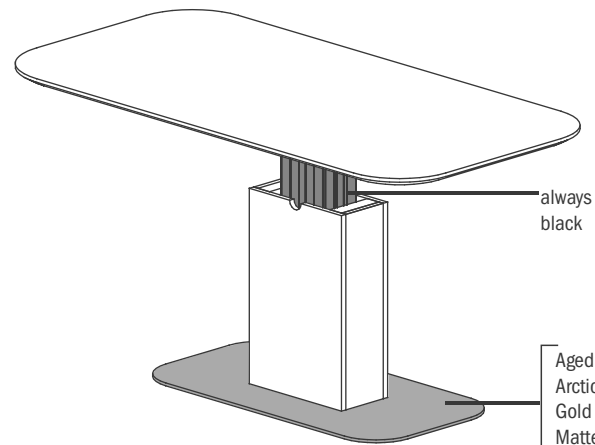
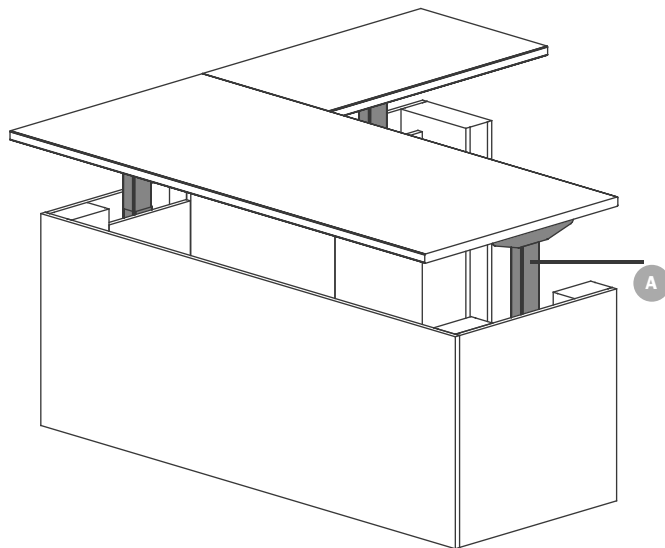
Side Tables

Pneumatic lift mechanism
Adjustable range of 12"
Round, square or rectangle shapes
Nest with primary worksurfaces

Color Scheme

The finish on the adjustable lift column **A** will automatically be silver if you select Arctic Silver or Soft Nickel metal.

If Aged Bronze, Gold, Matte Black, Soft Bronze or Pewter metal is selected, the lift column **A** will be black.



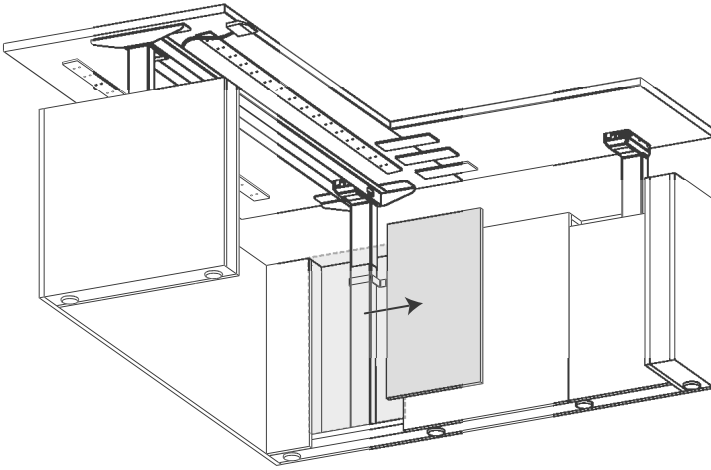
Metal finishes on electric adjustable height tables available in Alloy or Matte Black.

Metal finishes on pneumatic adjustable height tables available in Stardust Silver or Black Sandtex.

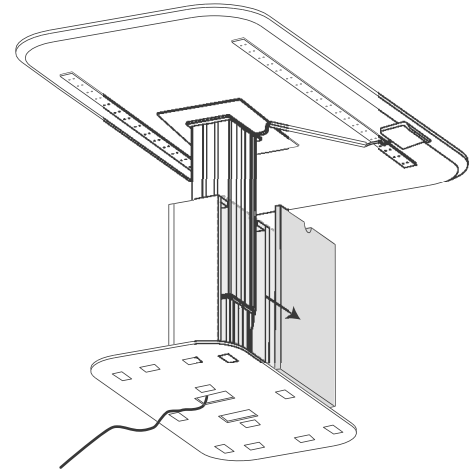
Flux Desk Details

Wire Management

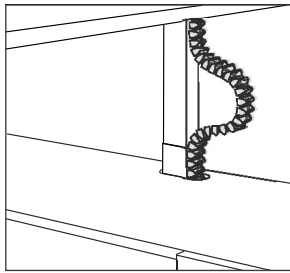
Removable panels allow access to the lift columns and also provide wire management.



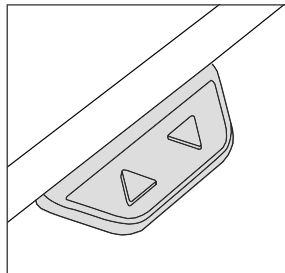
Removable panel shown from underside of adjustable height desk.



Electrical cord exits through the bottom side of the plate. Neoprene leveling pads allow the cord to lay flat.



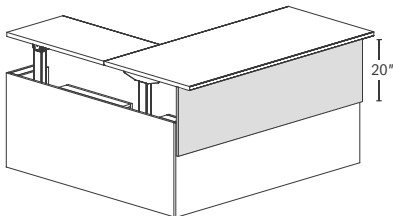
A flexible wire manager is included on adjustable desks, returns and credenzas.



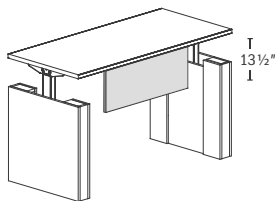
Controller can be mounted anywhere along top perimeter.

Optional Modesty Panel

An optional modesty panel can be added to an adjustable height desk or table desk.



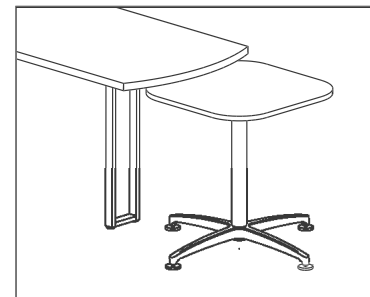
Adjustable Height Desk
Modesty panel mounts to the front of desk with overhang.



Adjustable Height Table Desk
Modesty panel mounts in between the end panels.

Nesting Side Table

Adjustable height side tables are designed to nest with primary height worksurfaces.



Flux Product Details

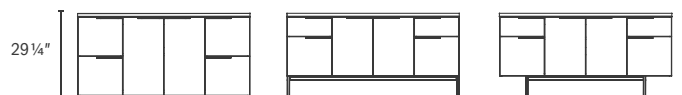
Credenzas

Product Overview

The Flux credenza is available as a 29 1/4" primary height credenza, or as a shorter, 21 1/4" secondary height credenza. Both heights come in three base styles as shown below.

PRODUCT INFORMATION

Primary Height



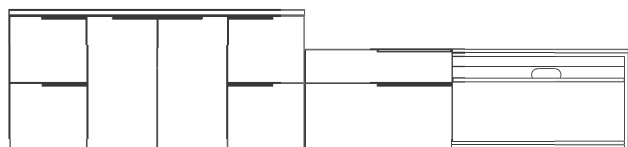
- 29F**
Primary height
Extends to the floor
- 29L**
Primary height
Elevated on legs
- 29S**
Primary height
Elevated on inset legs

Secondary Height

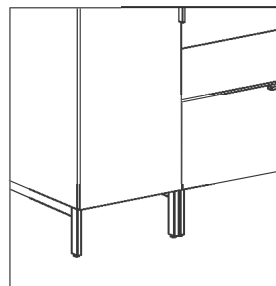


- 21F**
Secondary height
Extends to the floor
- 21L**
Secondary height
Elevated on legs
- 21S**
Secondary height
Elevated on inset legs

Drawer Alignment



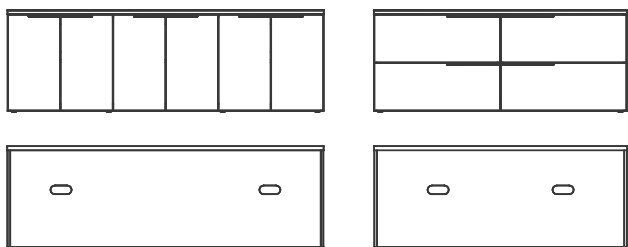
Drawers align between primary and secondary heights.



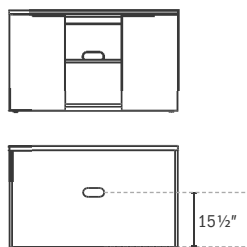
Legs pair up with adjacent units.

Credenza Oval Grommet Rules

Oval grommets for wire management are standard in all storage credenzas. Oval grommets in back panels can be eliminated upon request at no upcharge. Oval grommets are not offered in kneespace credenzas, open corner credenzas, modular pedestals, and pedestals under 18"w.



2 Grommets
Credenzas 60"w or greater with multiple storage compartments or drawer stacks have 2 grommets



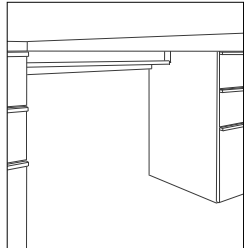
1 Grommet
Credenzas under 60"w have 1 grommet

Flux Product Details

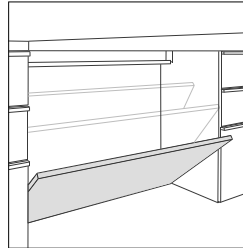
Credenza Options

Modesty Panel

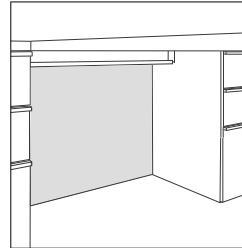
A modesty panel can be added as an option to Kneespace and Open Corner Credenzas. A partial modesty panel, full modesty panel or removable modesty panel are available.



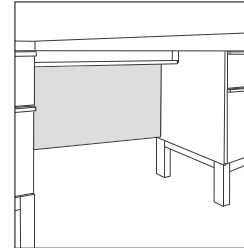
Standard without modesty panel



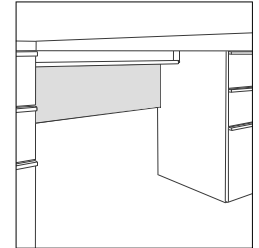
Removable modesty panel



Fixed full height modesty panel



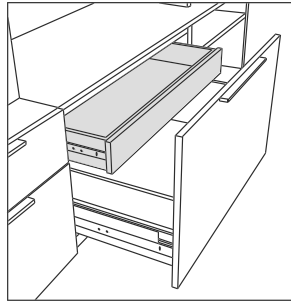
Fixed full height modesty panel with legs



Fixed partial modesty panel

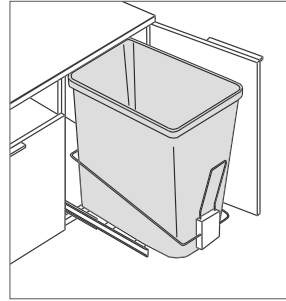
Concealed Drawers

Concealed drawers are available on credenzas with box/lateral file drawer configurations. This offers one continuous front.



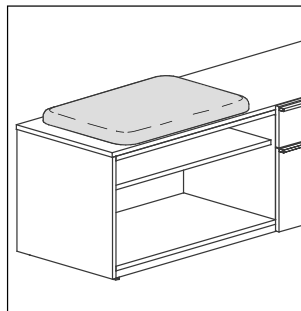
Trash Cans

Primary height credenzas with 18" wide hinge door storage can be outfitted with a trash can.

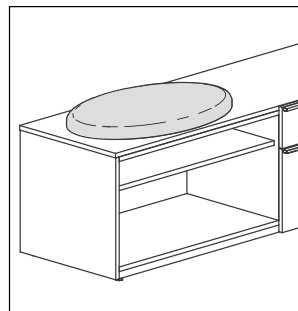


Seat Cushions

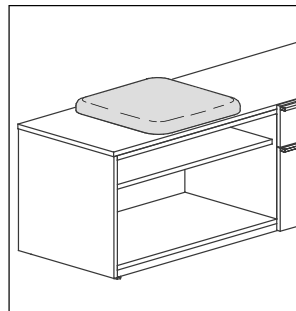
Seat Cushions are available in Rectangle, Oval, Square and Round and can be ordered separately for use on secondary credenzas.



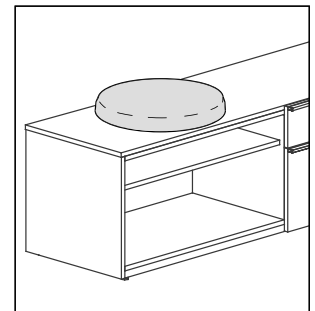
Rectangle seat cushion



Oval seat cushion



Square seat cushion

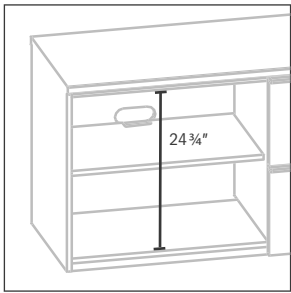


Round seat cushion

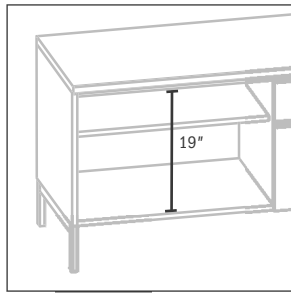
Flux General Options

Credenza Interior Compartment Heights

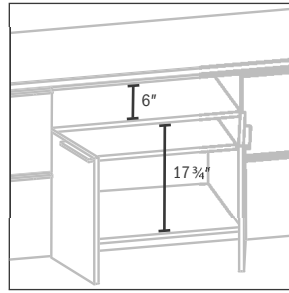
Primary height credenzas (29 1/4" h)



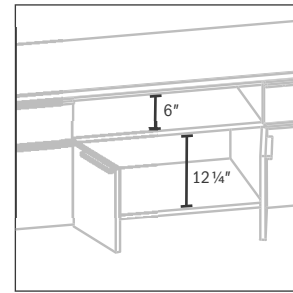
29F side compartment



29L & 29S side compartment

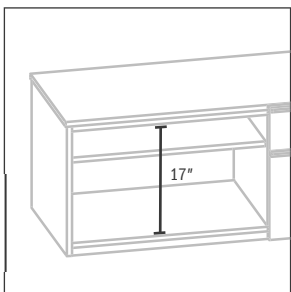


29F middle compartments

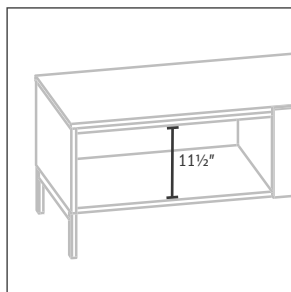


29L & 29S middle compartments

Secondary height credenzas (21 1/4" h)

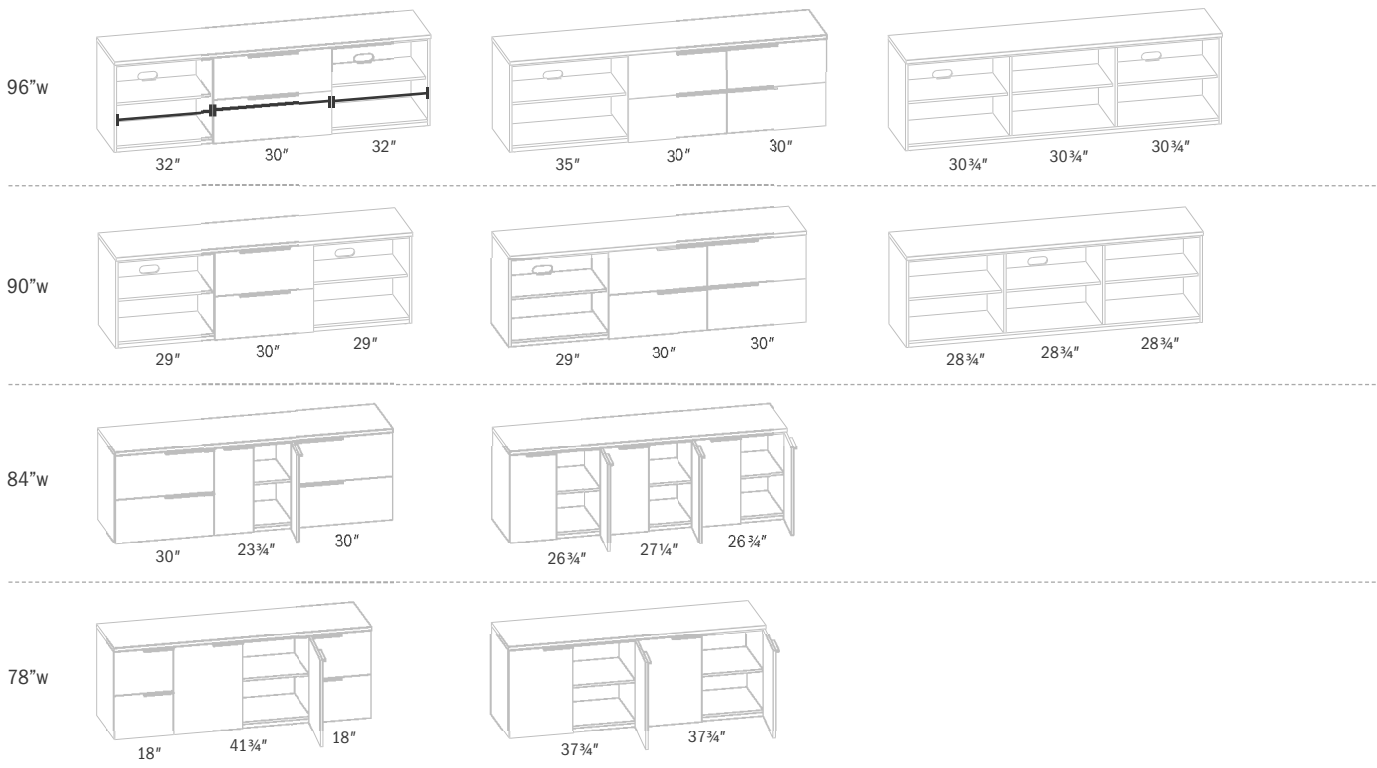


21F side compartment



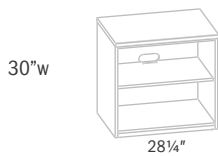
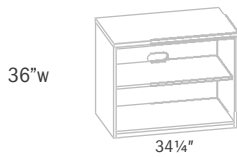
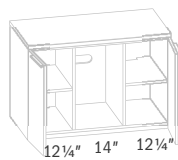
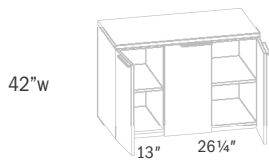
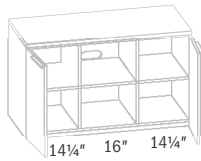
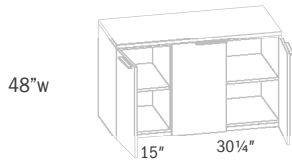
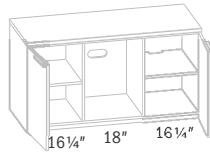
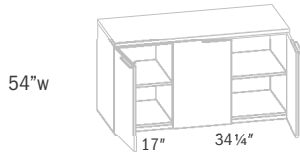
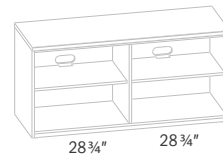
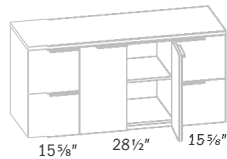
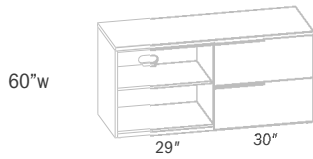
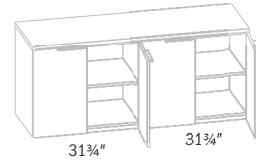
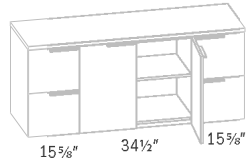
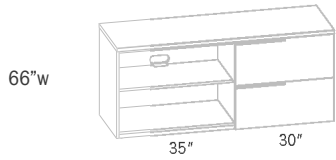
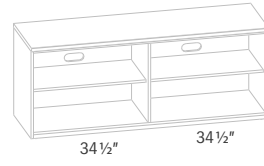
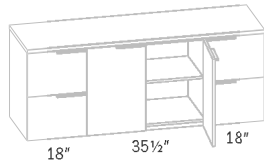
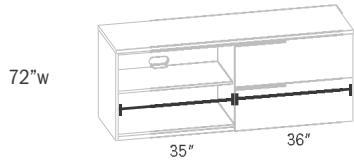
21L & 21S side compartment

Credenza Interior Compartment Widths



Flux General Options

Credenza Interior Compartment Widths (continued)



Credenza Interior Depths
 Standard shelf depth = 18"
 Interior cabinet depth = 20 1/4"

PRODUCT INFORMATION

All dimensions are rounded down to the nearest quarter inch. Call Customer Service if exact dimensions are needed.

Flux Product Details

Overhead Cabinets, Wall Mount Overheads and Wall Panel Stack-ups

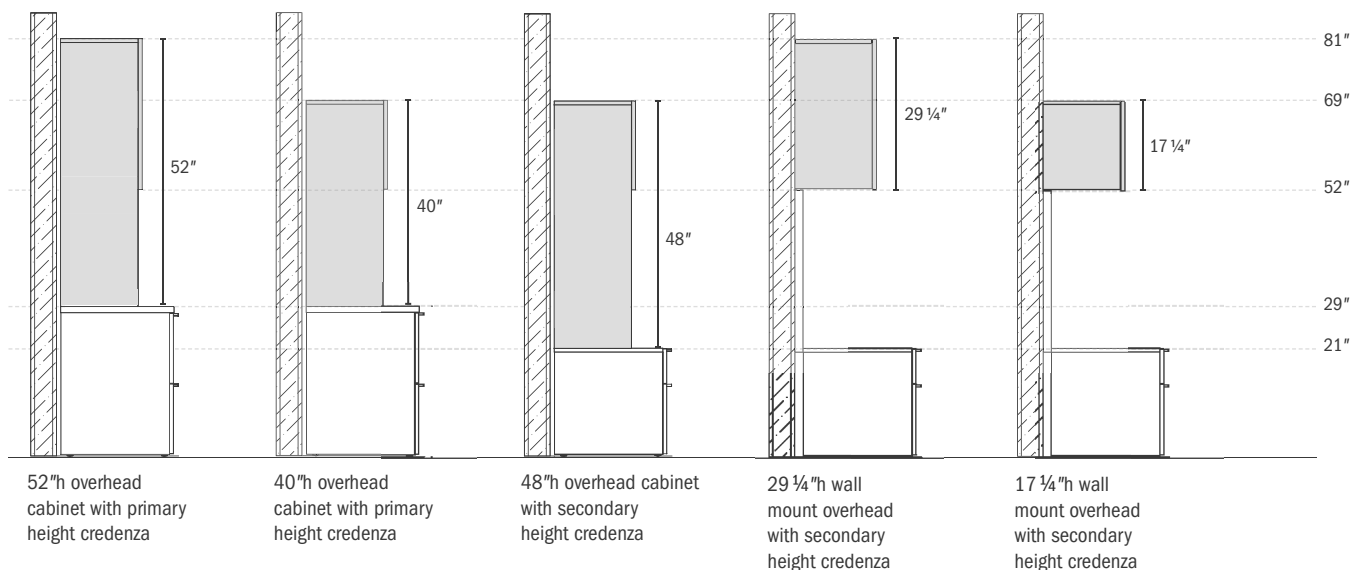
Product Overview

Flux overhead cabinets, wall mount overheads and wall panels, when combined with lower storage, create an overall height of 69 ¼" or 81 ¼". Overhead cabinets are available in three heights: 40", 48" or 52". Wall mount overheads are available in two heights: 17" or 29" (add ¼" to overall height for self-pull). Wall panels are available in four heights to accommodate various combinations of use to create the overall height of 69 ¼" or 81 ¼". Wall panels include laminate, veneer, tackboard, markerboard, magnetic glass, and workwall panels.

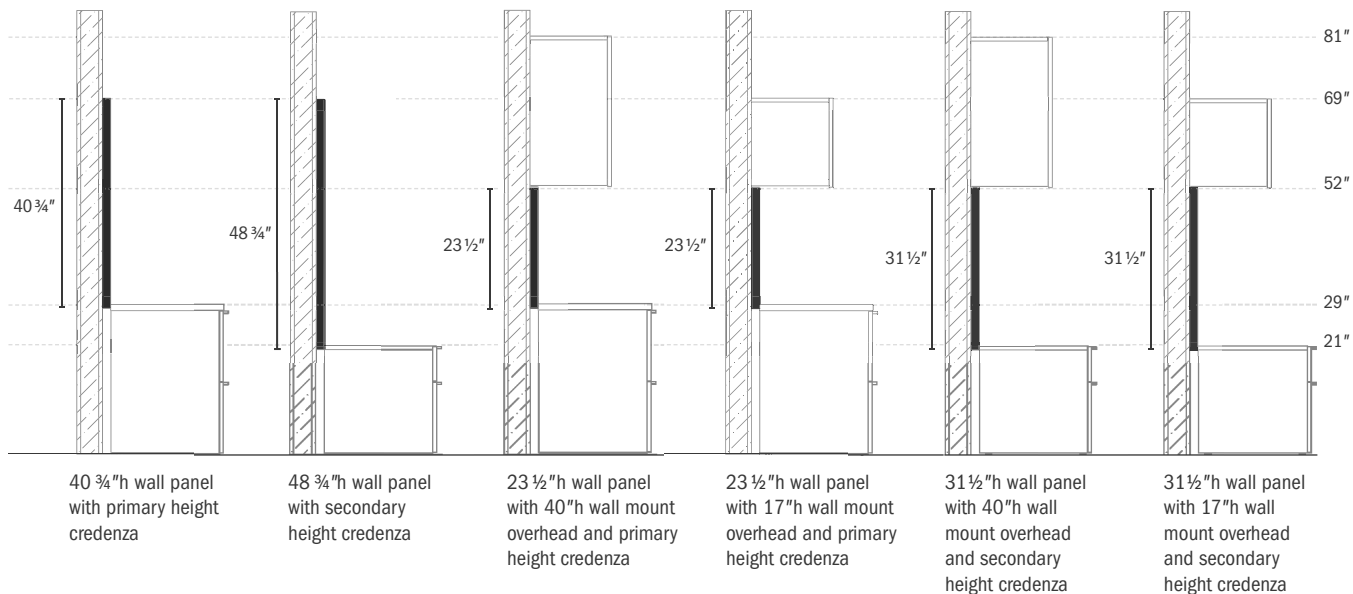
PRODUCT INFORMATION

Overhead Cabinets (side view)

Wall Mount Overheads (side view)



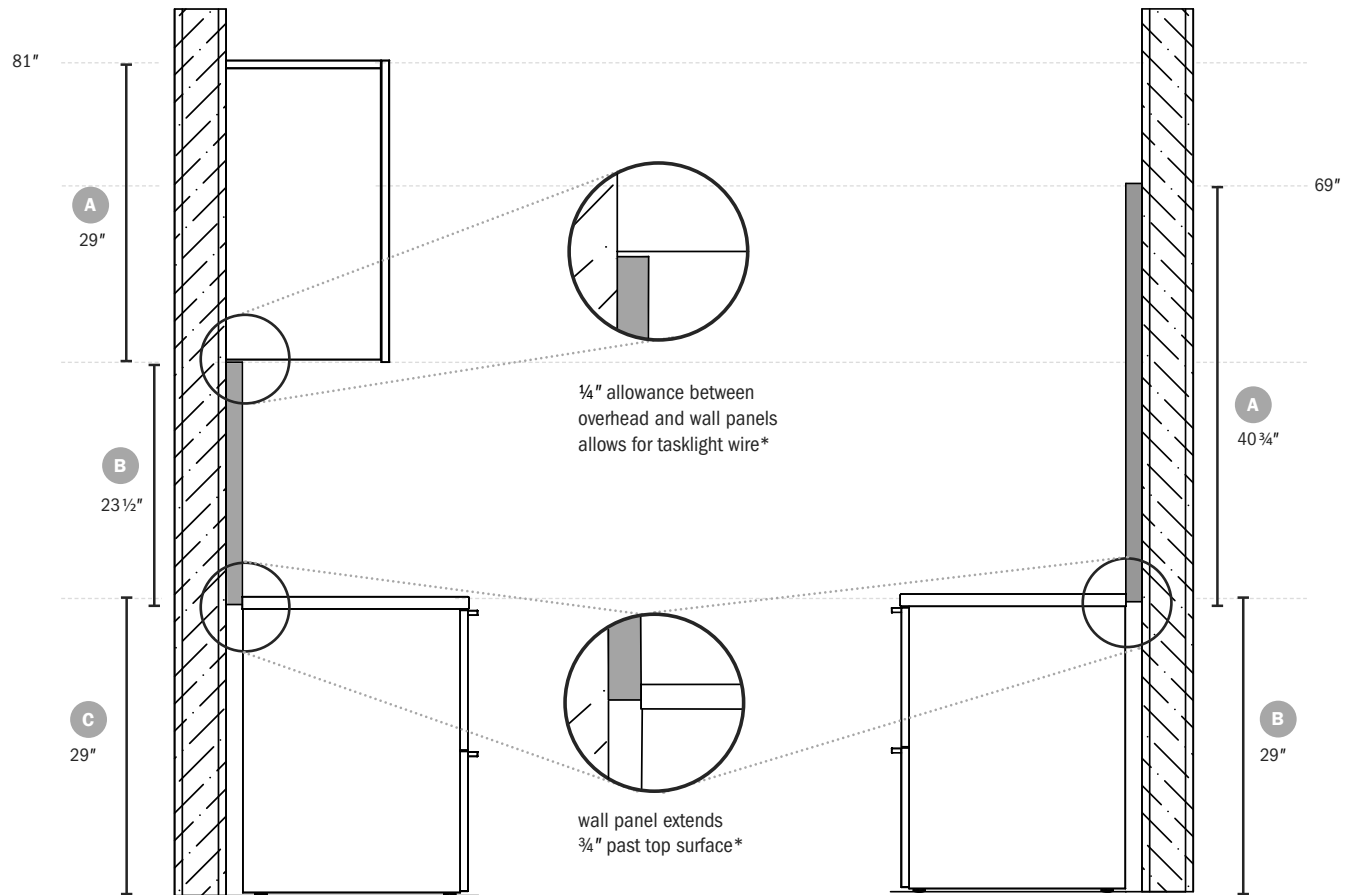
Wall Panels (side view)



Flux Product Details

Wall Panel Installation

Proper installation when using wall panels will result in proper alignment.



PRODUCT INFORMATION

	Height	Notes
A	29.00" wall side	29.25" overall with extended door for self pull
B	23.50" overall	0.75" of panel extends past the credenza
C	29.00" overall	
	81.50"	
	+ .25" between overhead and wall panel	
	- .75" extended panel	
	81.00" finished height	

	Height	Notes
	40.75" overall	0.75" of panel extends past the credenza
	29.00" overall	
	69.75"	
	- .75" extended panel	
	69.00" finished height	

*For correct alignment with other Flux components, these allowances must be factored into mounting of the overheads and wall panels during installation (instructions included).

Flux Product Details

40" Overhead Stack-up Options (with Primary Height Credenza)

A 40" overhead may be composed of: **A** storage cabinets/towers, **B** wall mount overheads paired with wall panels or **C** tall wall panels, creating an overall unit height of 69" when added to a primary height credenza.

PRODUCT INFORMATION

A

Open Storage Cabinet

Sliding Door Cabinet

Hinged Door Storage Tower

Sliding Door Storage Tower

Side Wardrobe with Open Shelf

See pages 314-323 and 396-399 for additional storage cabinet and tower options.

B

Open Storage

Sliding Door

Shelf

Cubby

Panel with Accessory File Shelf

Panel with Mini Shelf

Wall Panel
(laminated, veneer, tack panel, markerboard or glass)

See pages 321-335 for additional wall mount overhead options.

See pages 340-343 and 352-355 for additional wall mount wall panel options.

C

Markerboard

Glass Markerboard

Tack Panel

See pages 336-339 for additional wall mount wall panel options.

Flux Product Details

Double Height Overhead Stack-up Options (with Primary and Secondary Credenza)

A 52" overhead may be composed of: **A** double height storage cabinets/towers, or **B** double height wall mount overheads and wall panels, creating an overall unit height of 81" when added to a primary height credenza. A 60" overhead composed of **C** double height wall mount overheads and wall panels can create an overall unit height of 81" when added to a secondary height credenza.

A

52"

Open Storage Cabinet Sliding Door Cabinet Hinged Door Storage Tower Sliding Door Storage Tower Side Wardrobe with Open Shelf

See pages 270-281 and 350-351 for additional double height storage cabinet and tower options.

B

29 1/4"

23 1/2"

Open Storage Sliding Door Shelf

Panel with Accessory File Shelf Panel with Mini Shelf Wall Panel (laminated, veneer, tack panel, markerboard or glass)

See pages 310-321 for additional wall mount overhead options.

See pages 340-343 and 352-355 for additional wall mount overhead options.

C

29 1/4"

31 1/2"

Open Storage Sliding Door Shelf

Panel with Accessory File Shelf Panel with Mini Shelf Wall Panel (laminated, veneer, tack panel, markerboard or glass)

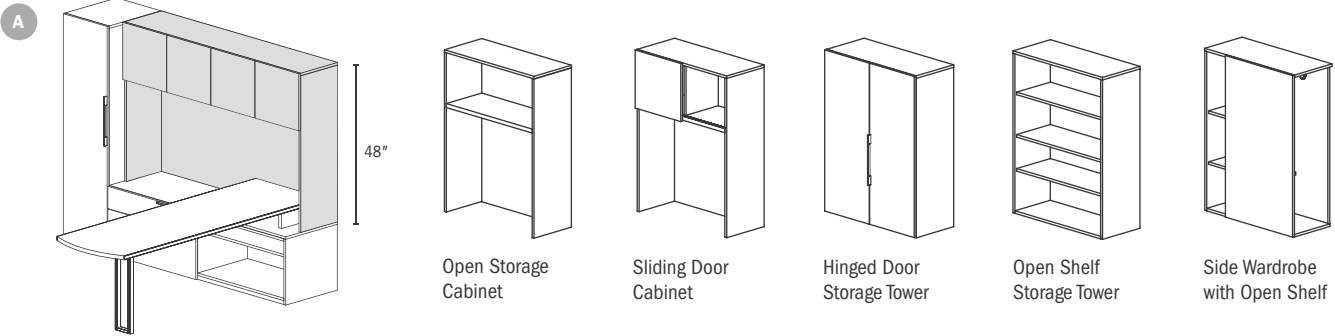
See pages 310-321 for additional wall mount overhead options.

See pages 344-347 and 356-359 for additional wall mount wall panel options.

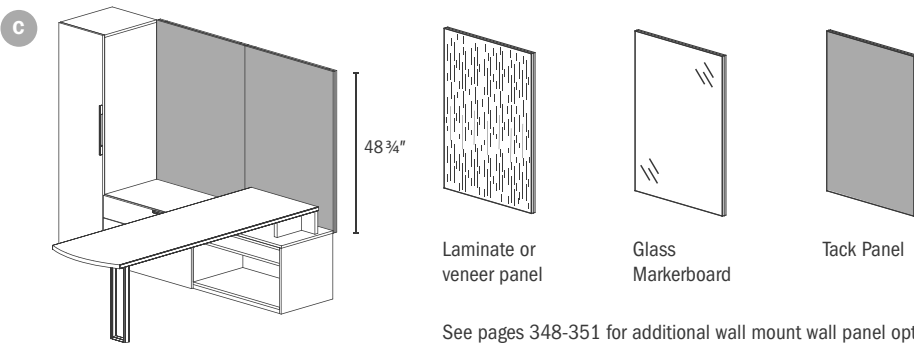
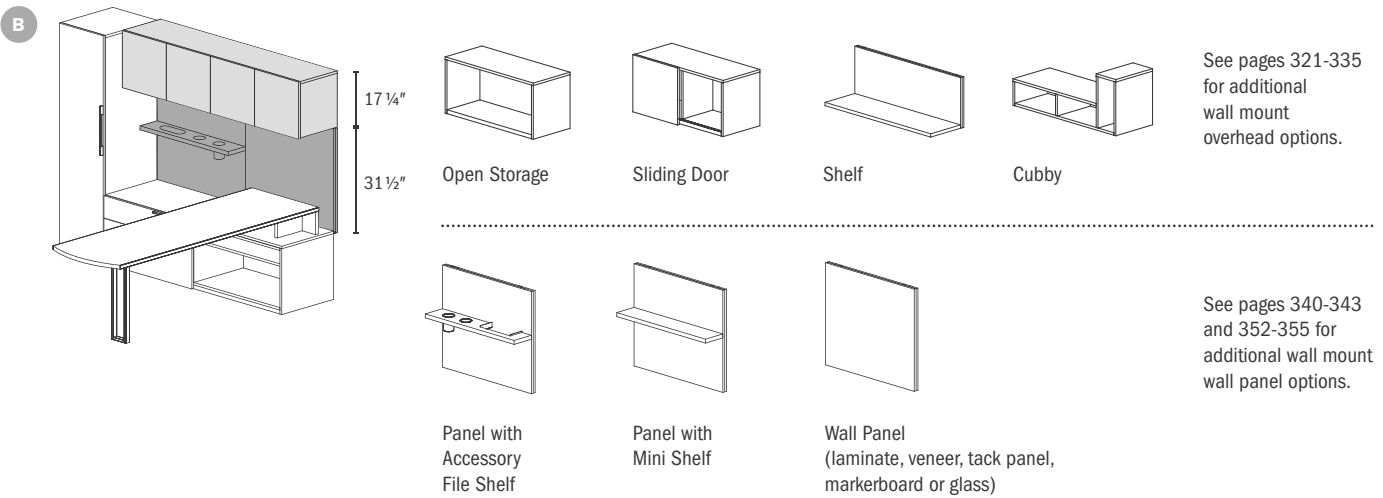
Flux Product Details

48" Overhead Stack-up Options (with Secondary Height Credenza)

A 48" overhead may be composed of: **A** storage cabinets/towers, **B** wall mount overheads paired with wall panels or **C** tall wall panels, creating an overall unit height of 69" when added to a secondary height credenza.



See pages 296-305 and 366-367 for additional storage cabinet and tower options.



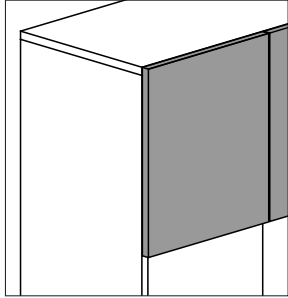
See pages 348-351 for additional wall mount wall panel options.

Flux Product Details

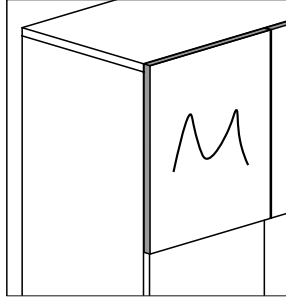
Overhead Options

Overhead Cabinet Doors

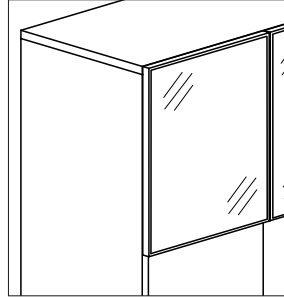
Contrasting door fronts, markerboard laminate fronts and white back painted glass fronts are available on overhead doors.



Contrasting laminate door fronts with any JSI standard laminate, or painted veneer fronts in JSI standard painted finishes.



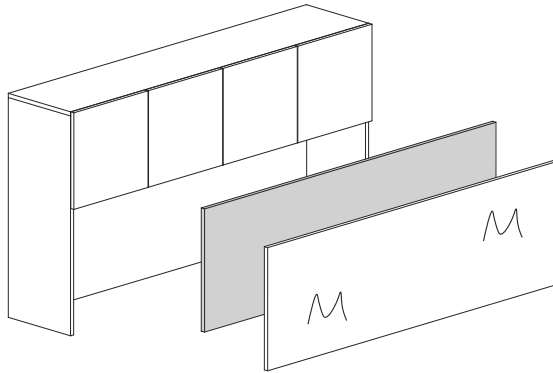
White markerboard laminate with silver vinyl wrapped door edges



White back painted glass in a thin aluminum frame, with markerboard surface (locking not available on overhead with glass doors)

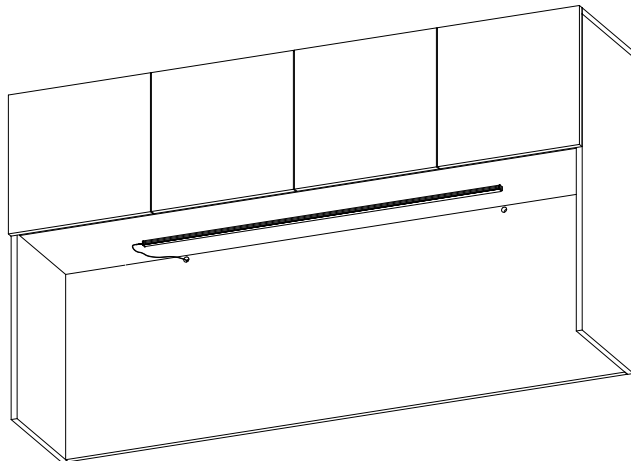
Overhead Cabinet Panels

Tackboard or laminate markerboard panels are available in overhead cabinets. Specify separately. Panels attach with dual lock fasteners.



Tasklights

Flux tasklights are available for overhead cabinets. Specify separately. Grommet holes for wire management are 5/8" diameter for the LED tasklight. Refer to the chart to the right for the recommended tasklight length according to overhead cabinet width.



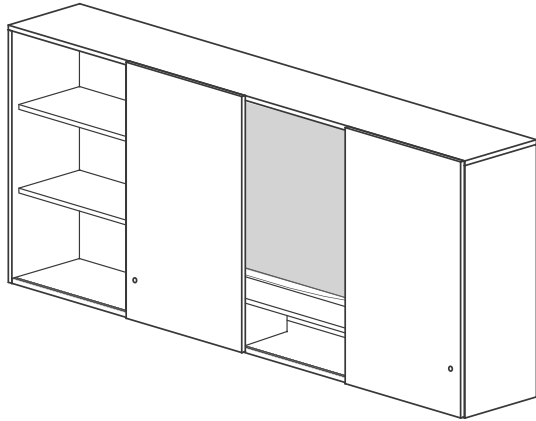
Overhead Width	Tasklight Model Number	Tasklight Length
96"	TL60LEDF	60"
90"	TL60LEDF	60"
84"	TL45LEDF	45"
78"	TL45LEDF	45"
72"	TL45LEDF	45"
66"	TL45LEDF	45"
60"	TL39LEDF	39"
54"	TL27LEDF	27"
48"	TL27LEDF	27"
42"	TL27LEDF	27"
36"	TL27LEDF	27"
30"	TL27LEDF	27"

Flux Product Details

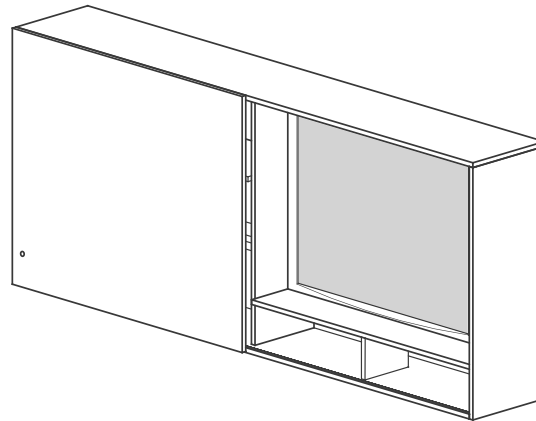
Monitor Cabinets

Monitor cabinets allow a dual purpose layout: personal storage compartment and media compartment are available in various widths (96", 90", 84", 78", 72", 66", and 60") and configurations. Monitor cabinets should be used with primary height credenzas.

PRODUCT INFORMATION

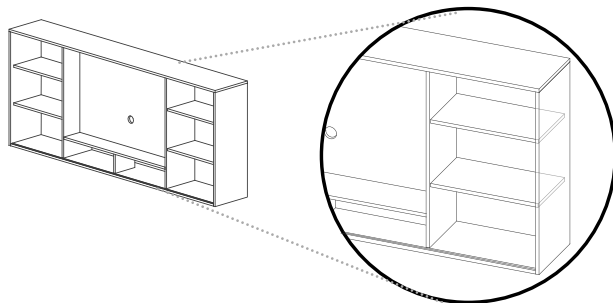


Center Monitor Cabinet



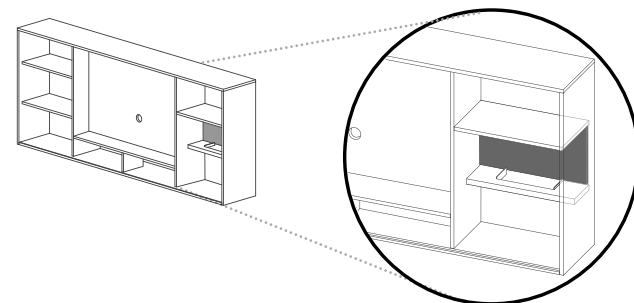
Right Monitor Cabinet

Center Monitor Cabinet Options



Center monitor with dual side shelf storage

Note: doors removed to show interior configurations

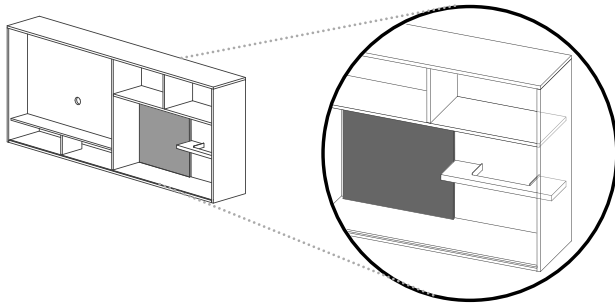


Center monitor with one side shelf storage and other side work-in-process storage (right or left), tackboard above filing shelf

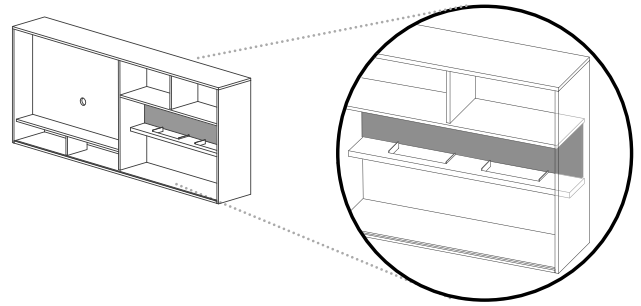
Note: doors removed to show interior configurations

Flux Product Details

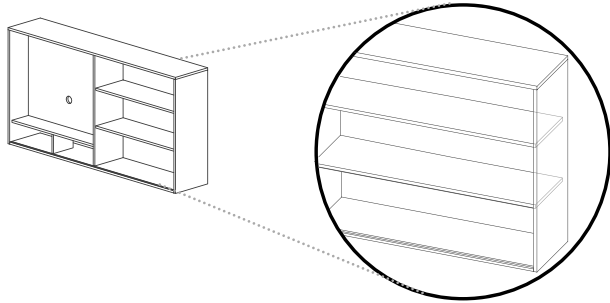
Right or Left Monitor Cabinet Options



Right or left monitor with side work-in-process storage and side tackboard
Available only on 96", 90", and 84" cabinet widths



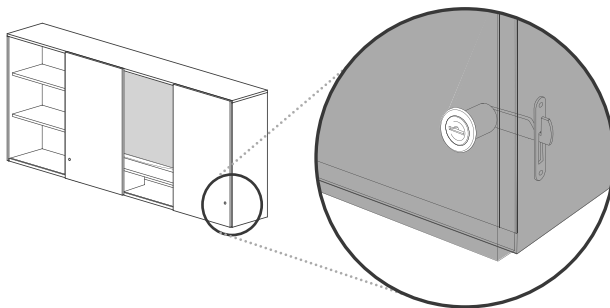
Right or left monitor with work-in-process storage and tackboard above filing shelf



Right or left monitor with side shelf storage
Available only on 78", 72", 66" and 60" cabinet widths

Locking

Locks are standard on all sliding doors on monitor cabinets. Only the personal storage locations lock; monitor sections do not lock.



Compartment Sizes

Use the chart below to determine the maximum monitor size allowed.

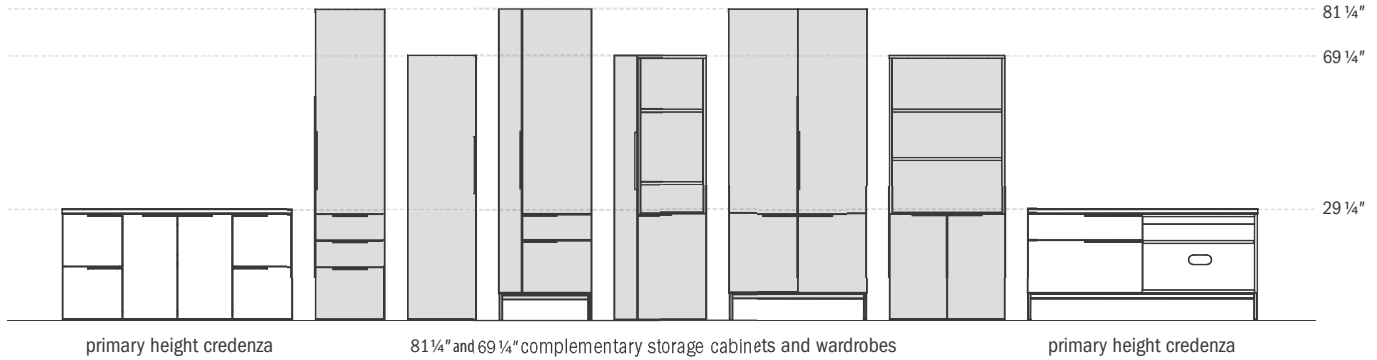
Cabinet Width	Monitor Section Interior Width	Maximum Monitor Size
95 7/8"	48"	45"w x 29"h
89 7/8"	45"	42"w x 29"h
83 7/8"	42"	39"w x 29"h
77 7/8"	39"	36"w x 29"h
71 7/8"	36"	33"w x 29"h
65 7/8"	33"	30"w x 29"h
59 7/8"	30"	27"w x 29"h

Flux Product Details

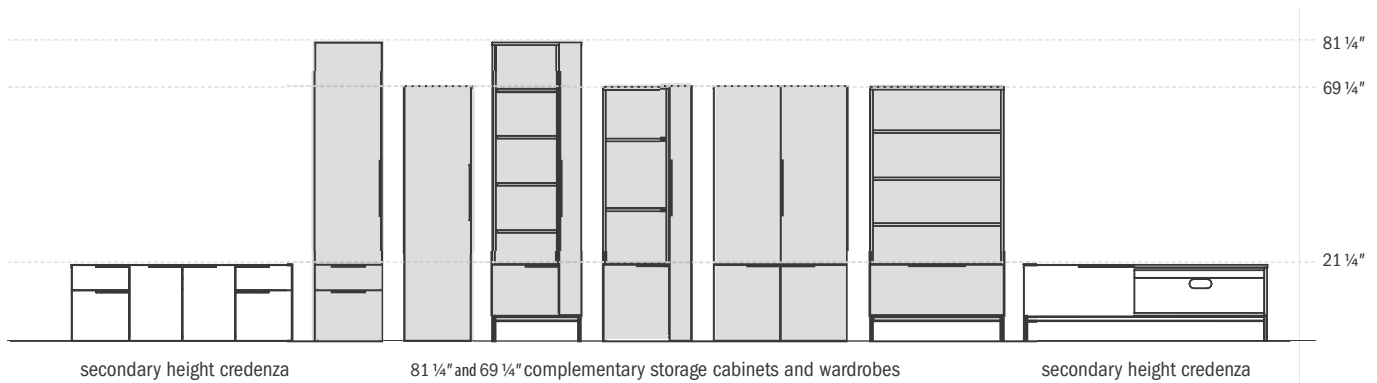
Storage Cabinets and Wardrobes

Flux offers a large range of storage cabinets to align with primary height credenzas (18", 24", 30" and 36" widths; with 81 1/4" and 69 1/4" heights).

PRODUCT INFORMATION

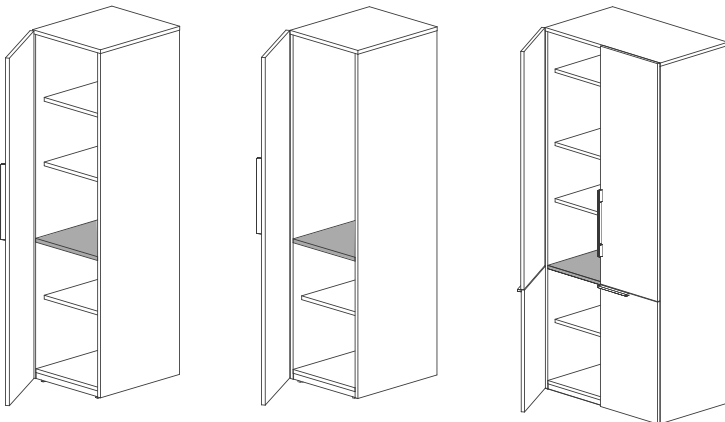


Flux offers a large range of storage cabinets to align with secondary height credenzas (18", 24", 30" and 36" widths; with 81 1/4" and 69 1/4" heights).



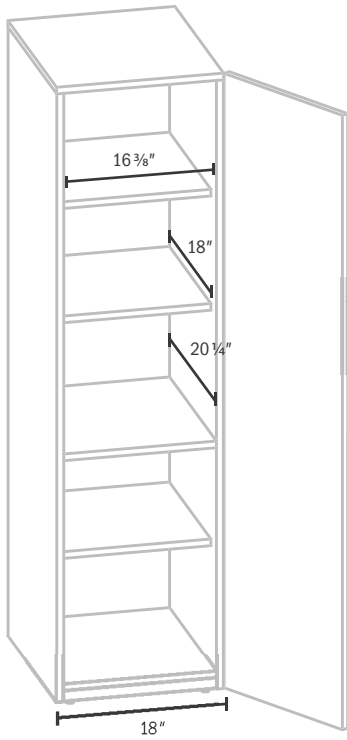
Fixed Shelf

All wardrobe cabinets with doors have a fixed shelf. All other shelves are adjustable.

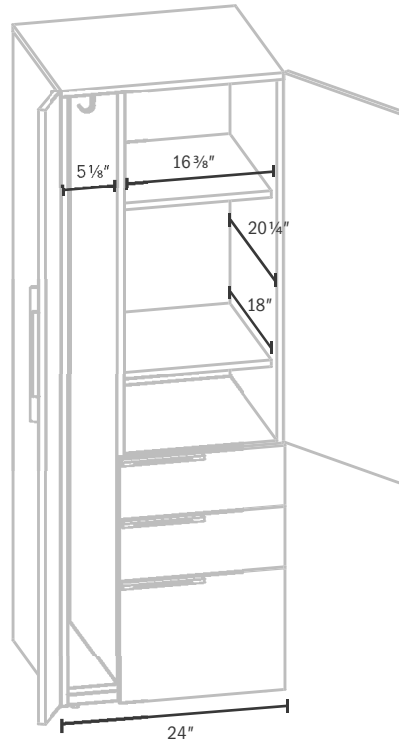


Flux Product Details

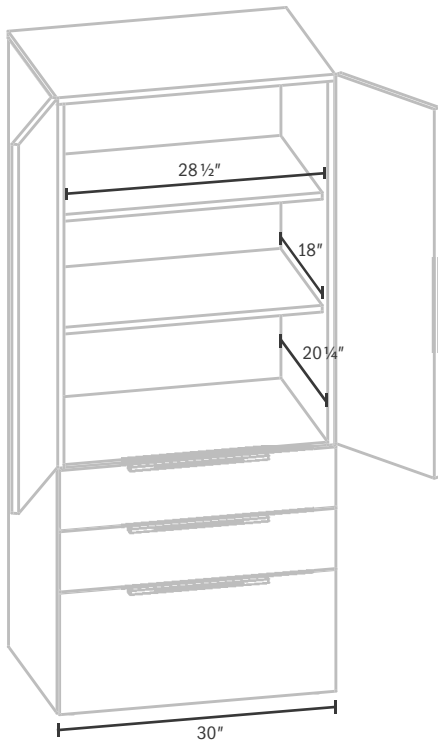
Vertical Storage Interior Dimensions



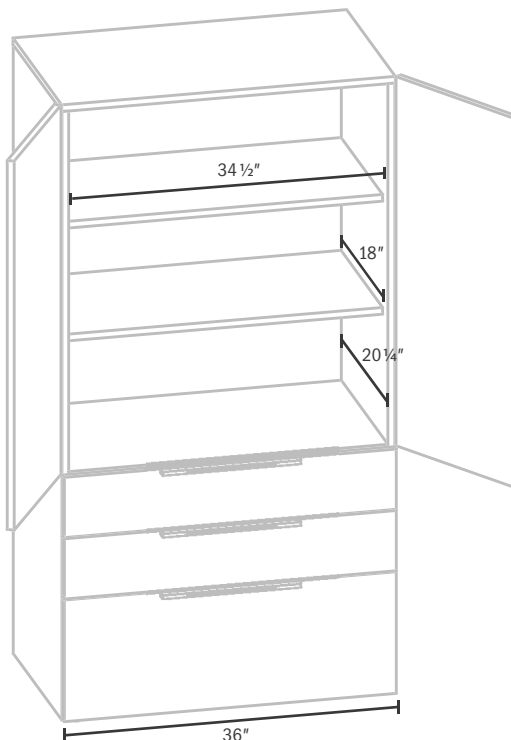
18" w full door storage cabinet



24" w side wardrobe with upper storage compartment



30" w upper storage compartment cabinet



36" w upper storage compartment cabinet

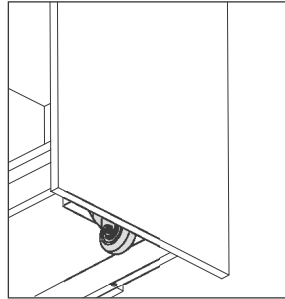
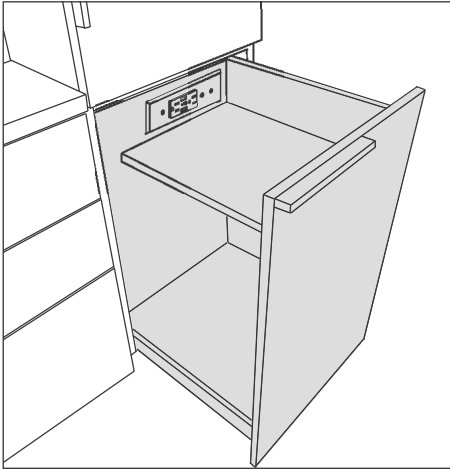
Flux Product Details

Storage Cabinet and Wardrobe Options

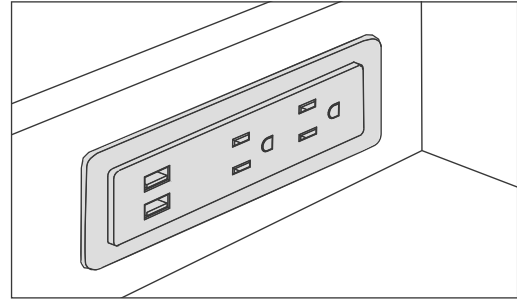
Pantry Drawer

A pantry pull out drawer is a standard offering in storage cabinets and wardrobes without legs. Drawers are equipped with a support caster on the front underside of the drawer.

PRODUCT INFORMATION



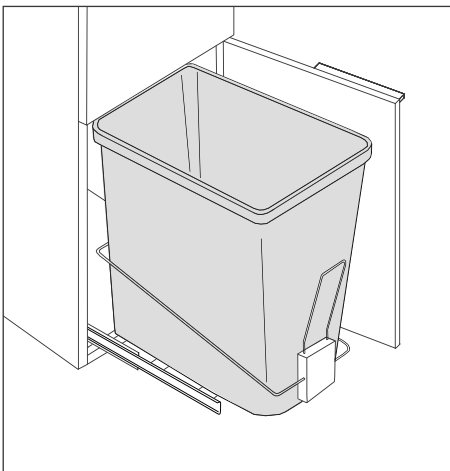
Underside of pantry pull out drawer highlighting support caster.



Optional electrical is available in the inside drawer and must be specified. Includes 2 grounded duplex and 2 USB charging outlets. Specify color.

Trash Cans

Storage Cabinets that work with primary height credenzas without legs, with lower hinge door storage, can be outfitted with a pull out trash can. Trash can is included.



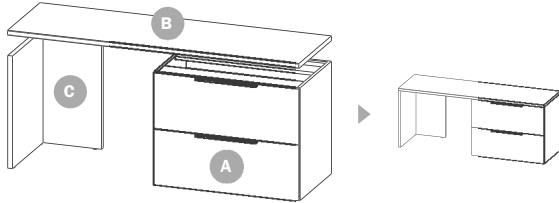
Flux Product Details

Modular Components

Modular items can be created by **(1)** adding tops to modular units or **(2)** using a credenza shell with a modular credenza shell pedestal. Hardware is included.

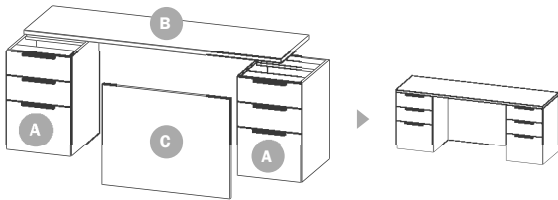
(1) Modular Top Construction

Example 1.1 - Open Corner Credenza



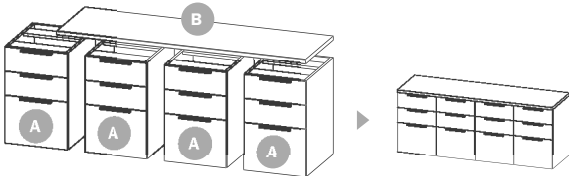
- A = 36" w x 22" d modular lateral file
- B = 72" w x 22" d modular primary height credenza top
- C = 18" w x 22" d modular credenza wing end (left)
(Open spans over 48" require special consideration, consult with Customer Service)

Example 2.1 - Kneespace Credenza



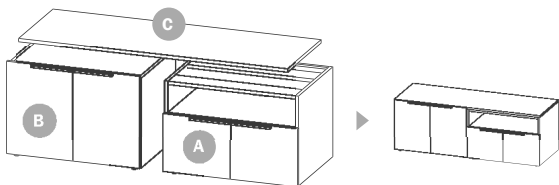
- A = (qty 2) 18" w x 22" d modular pedestal
- B = 72" w x 22" d modular primary height credenza top
- C = 28" h x 36" w modular credenza modesty panel
(Open spans over 48" require special consideration, consult with Customer Service)

Example 3.1 - Storage Credenza



- A = (qty 4) 18" w x 22" d modular pedestal
- B = 72" w x 22" d modular primary height credenza top

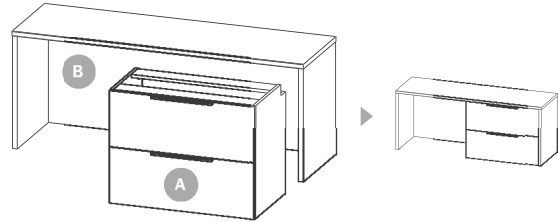
Example 4.1 - Secondary Height Credenza



- A = 30" w x 22" d modular hinged door storage with open shelf
- B = 30" w x 22" d modular hinged door storage
- C = 60" w x 21" d modular secondary height credenza top

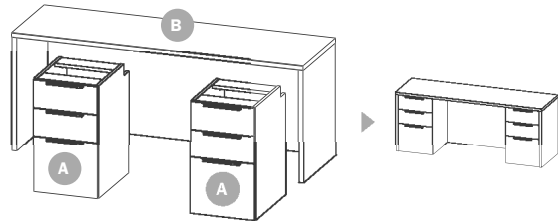
(2) Credenza Shell Construction

Example 1.2 - Open Corner Credenza

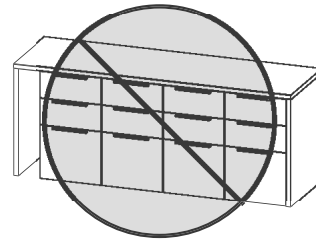


- A = 36" w x 21" d modular credenza shell lateral file
- B = 72" w x 22" d credenza shell
(Requires attachment to back of credenza and to underside of top)

Example 2.2 - Kneespace Credenza



- A = (qty 2) 18" w x 21" d modular credenza shell pedestal
- B = 72" w x 22" d credenza shell
(Requires attachment to back of credenza and to underside of top)



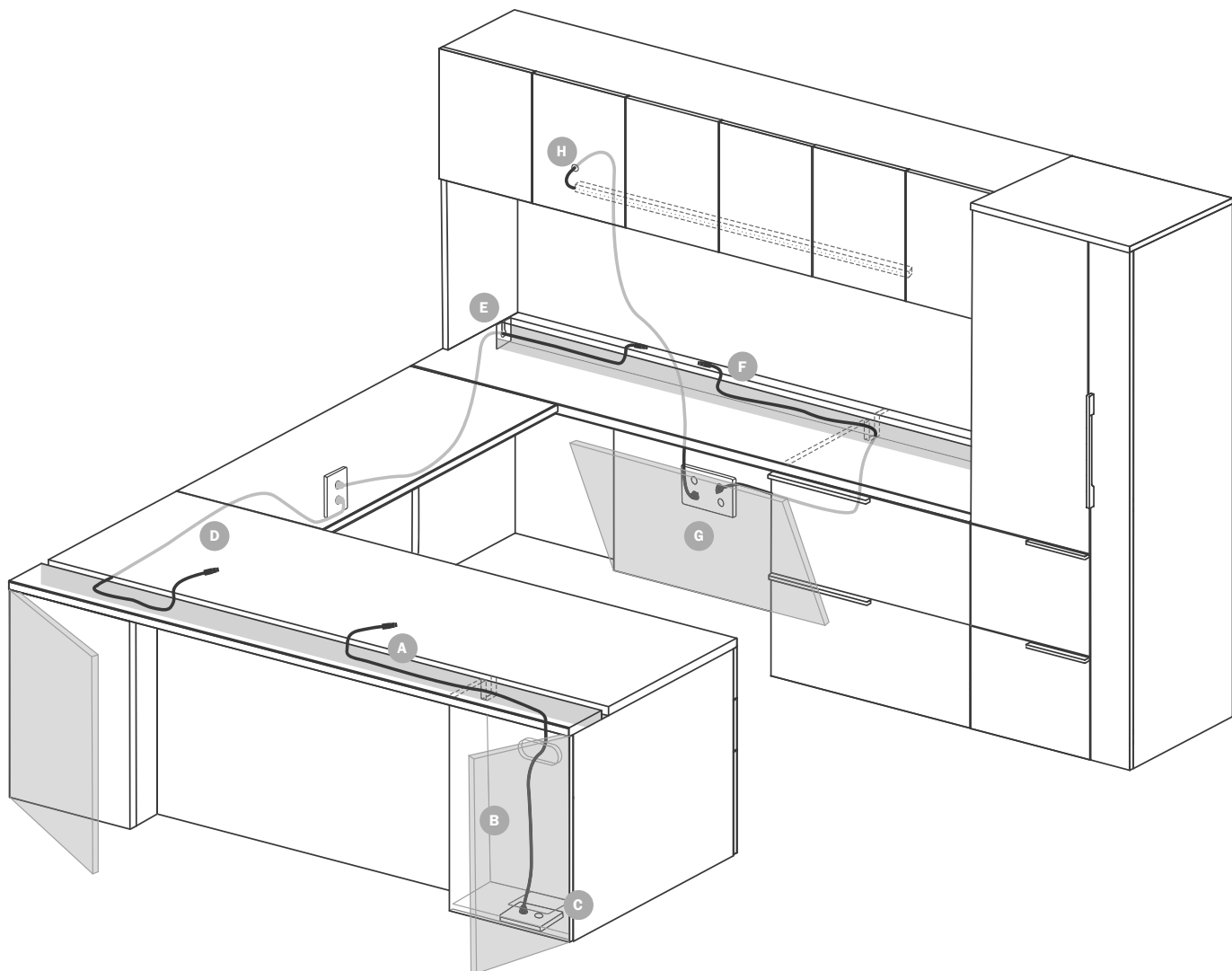
There is no combination of modular components that will allow a credenza shell to be filled between end panels; kneespace or open corner is required.

Flux Technology

Power Access and Wire Management

Breakfront Pedestal Desk U Unit

PRODUCT INFORMATION

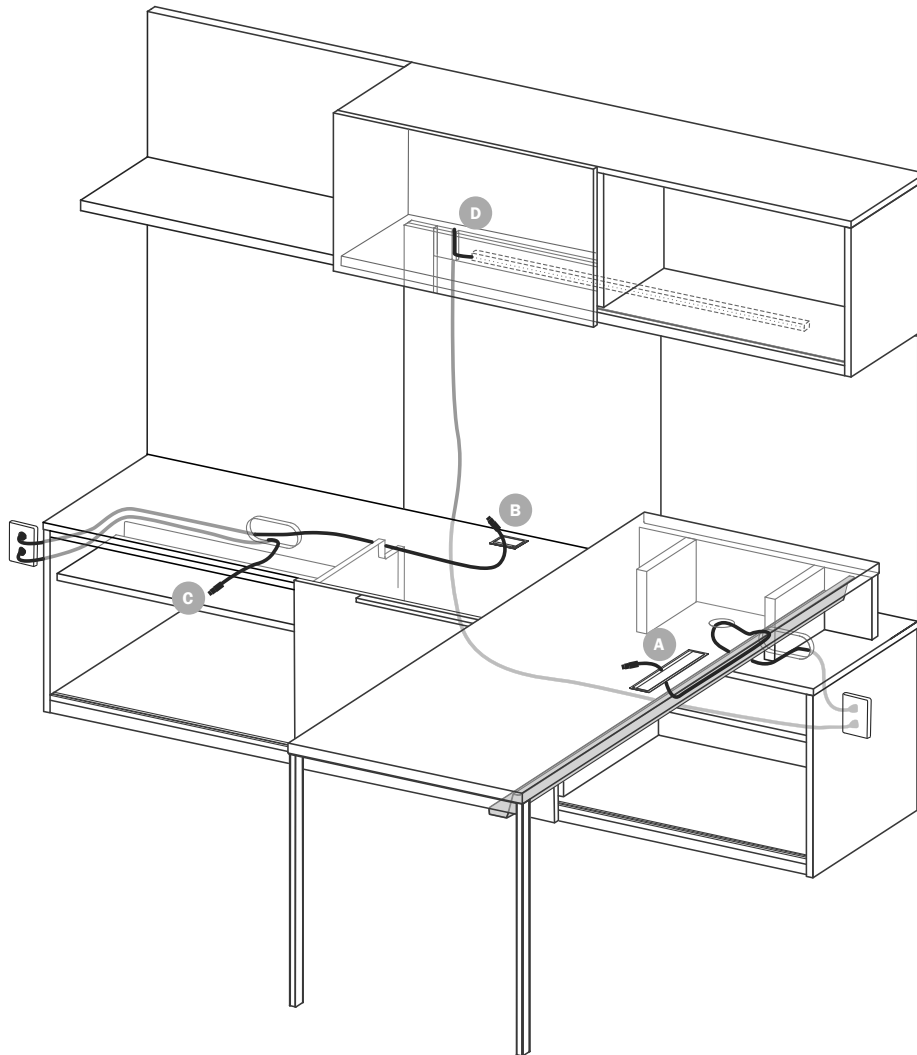


Wiring Paths

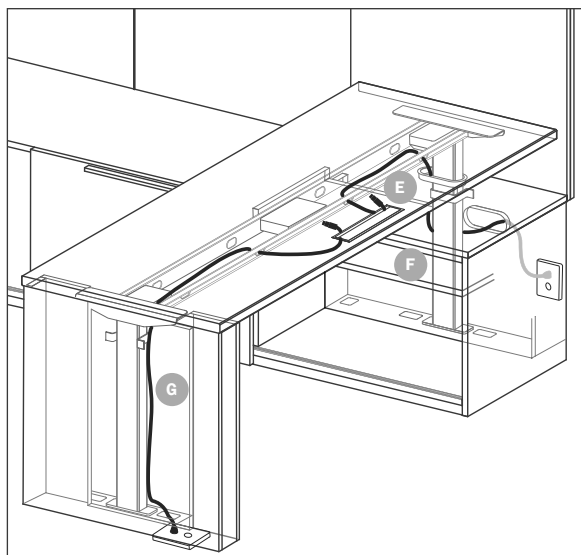
- A** = Split top allows wires to fall off at any location on the desk top
- B** = Pedestal access doors allow access to wiring or power supply
- C** = Hole in cabinet bottom allows for floor monument access
- D** = Wiring can be routed through the desk, under bridge and back to the credenza
- E** = End panel grommet in credenza allows wiring to exit the layout
- F** = Split top allows wires to fall off at any location on the credenza top
- G** = Optional removable modesty panel allows for access to wall electrical outlet
- H** = $\frac{5}{8}$ " holes in back panel allow TL-LED tasklight wires to be routed down the exterior of overhead back

Flux Technology

Power Access and Wire Management Peninsula Desk with Secondary Storage



Adjustable Height Peninsula Desk with Secondary Storage

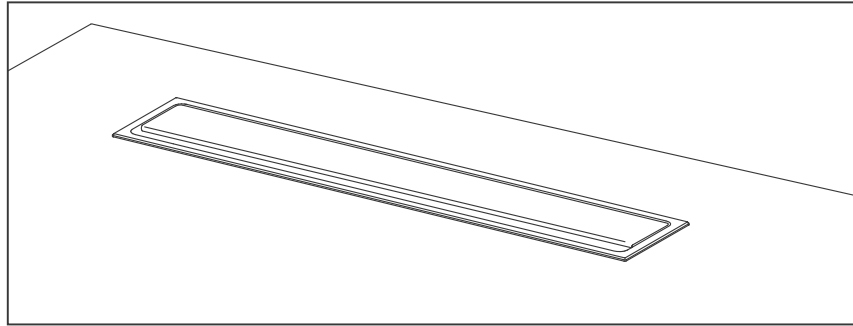
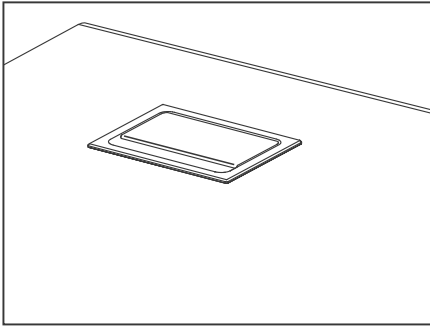


Wiring Paths

- A** = Optional 12" grommet allows wiring to run into optional wire channel, through the standard top credenza grommet and out the back panel's oval grommet
- B** = Optional 3" grommet allows wiring to enter the credenza compartment, move through the notched inside panels and out the back panel's oval grommet
- C** = Wiring for equipment can exit out the oval back grommet
- D** = Tasklight wiring can exit back side of the wall panels
- E** = Optional 12" grommet allows wiring to run into the adjustable height support rails then to a standard flexible wire manager into the lift mechanism compartment and out the back panel's oval grommet
- F** = Snap-on panel allows access to the lift mechanism compartment for access to the back oval grommet
- G** = Snap-on panel on the inside peninsula desk end allows access to the interior of the lift mechanism compartment to route wiring to floor monuments

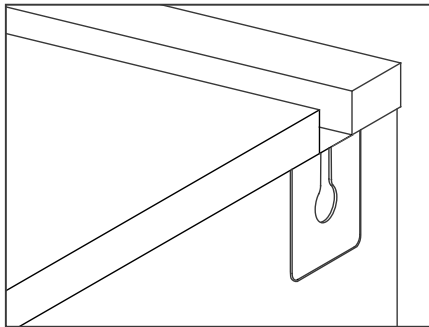
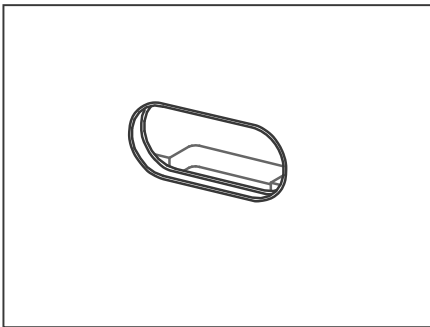
Flux Technology

Grommets and Worksurface Power



Optional Grommets

Flux offers two sizes of optional grommets: 3" (2½") and 12" (11½") grommets, available in arctic silver, soft nickel, matte black or pewter. Grommet locations are predetermined with a code; see the grommet and electrical locations in this section.

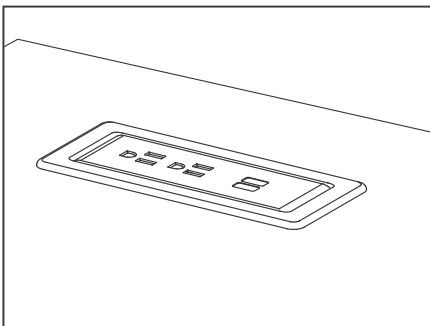


Oval Grommets

Oval grommets with a black trim ring are standard on the back of credenzas. See page 44 for actual location rules for the credenzas. These grommets can be eliminated at no charge. Must specify at the time of order entry.

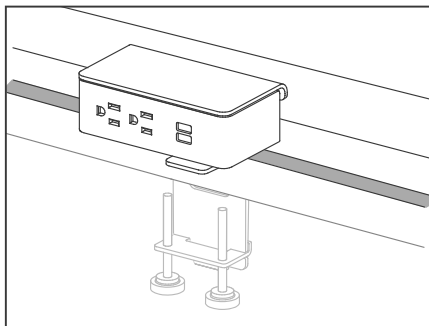
Side Grommets

Magnetic side grommets are standard on credenza with split tops, and include an interior wire channel.



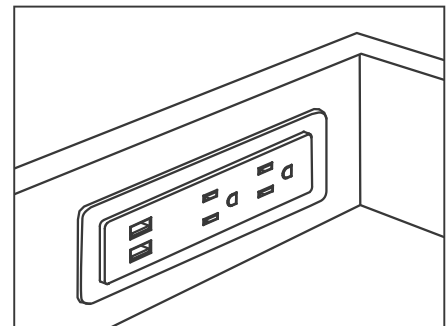
Optional EC26 Power Unit

Optional EC26 power unit can be located on tops, available in black or white; two power receptacles—120 volts and 15 amp dual powered USB. Locations are predetermined with a code; see the grommet and electrical locations in this section.



Optional EC28 Power Unit

Optional EC28 power unit can be clamped on desk or credenza with split tops, available in black or white; two power receptacles—120 volts and 15 amp dual power USB; 10 ft. cord.



Optional EC26 Pantry Power Unit

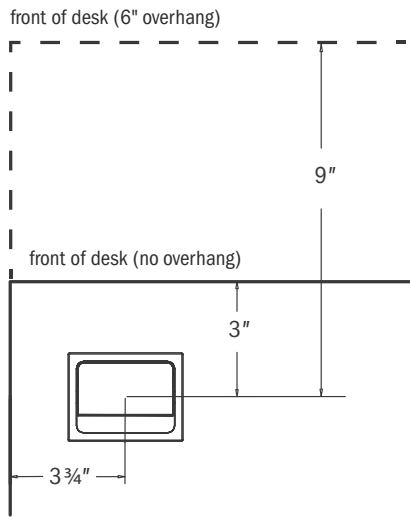
Optional EC26 power unit can be specified in the pantry drawer, available in black or white; two power receptacles—120 volts and 15 amp dual power USB.

Flux Technology

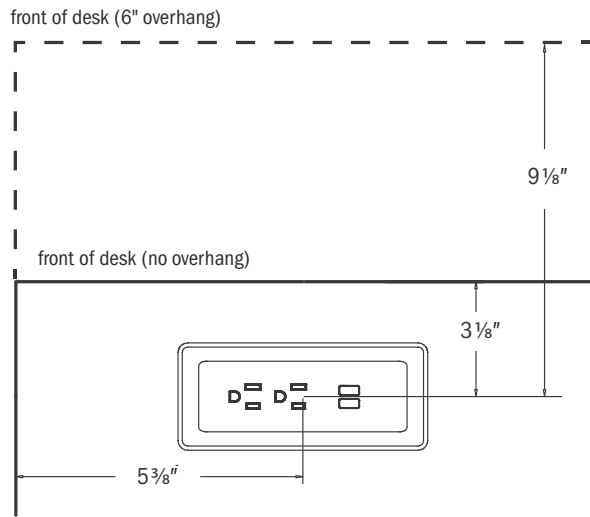
Dimensional Location of Grommets

The grommet locations below show standard dimensions for most products. If exact dimensional information is needed, contact Customer Service.

Desk (top view)



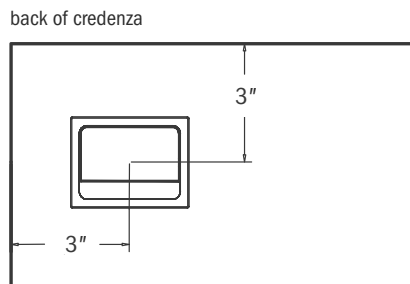
Grommet dimensions
 A and C positions on desk



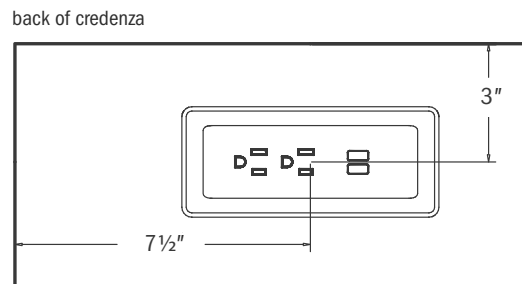
EC26 dimensions
 A and C positions on desk

Grommets or EC26 D position runs parallel to the side of the desk.

Credenza (top view)



Grommet dimensions
 A and C positions on desk

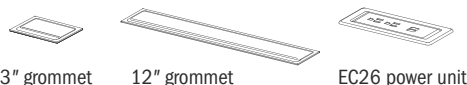


EC26 dimensions
 A and C positions on desk

Flux Technology

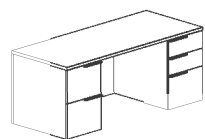
Location of Grommets and Worksurface Electrical

Reference the diagrams below to determine the letter code for specifying a desired grommet or power unit location. Available locations apply to all options listed within each category.

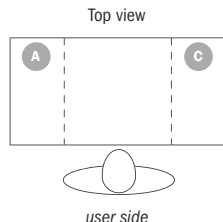


3" grommet 12" grommet EC26 power unit

Double Pedestal Desks



user side shown



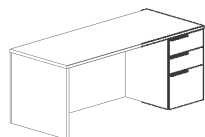
Available options:

- 3" grommet
- EC26 power unit

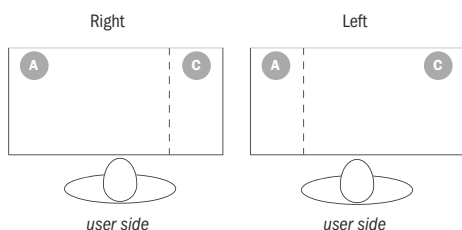
Available location codes:

- A or C
- Grommets are inset on desks with overhang tops

Single Pedestal Desks



right side, user side shown



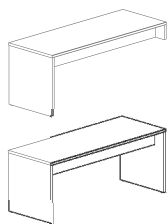
Available options:

- 3" grommet
- EC26 power unit

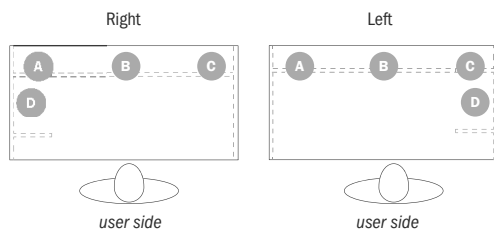
Available location codes:

- A or C
- Grommets are inset on desks with overhang tops

Peninsula Desks with End Panels



right side, approach view



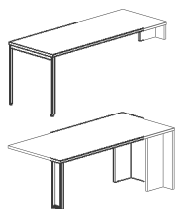
Available options:

- 3" grommet
- 12" grommet
- EC26 power unit

Available location codes:

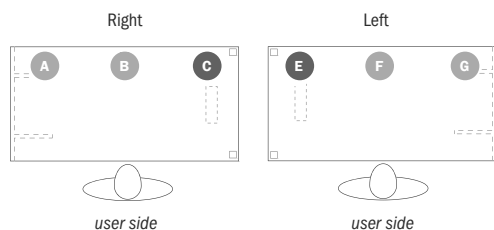
- A B C or D

Peninsula Desks with End Frames or Post Frames



(frame post)

non-handed product - grommets hand units



Dark gray locations (C & E) are not available on peninsula desks with frame post

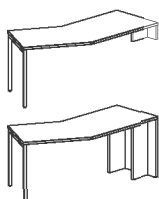
Available options:

- 3" grommet
- 12" grommet
- EC26 power unit

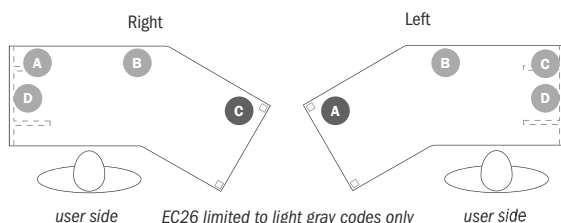
Available location codes:

- A B or C (right)
- E F or G (left)
- Locations apply to rectangular and arc shape tops with end frames

Boomerang Peninsula Desks with End Frames



right side, approach view



Available options:

- 3" grommet
- 12" grommet
- EC26 power unit (limited to 3 locations)

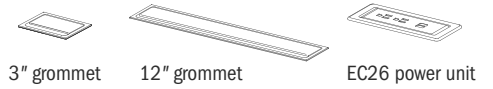
Available location codes:

- A B C or D
- EC26 power unit may not be located at outer end of bend

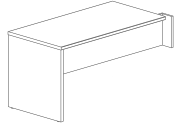
Flux Technology

Location of Grommets and Worksurface Electrical (continued)

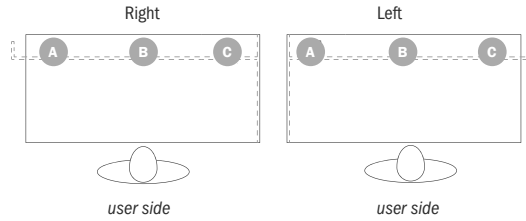
Available locations apply to all options listed within each category.



Rectangle Run-off Desks with End Panels



left side, approach view



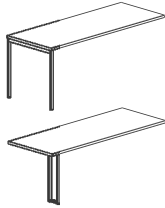
Available options:

- 3" grommet
- 12" grommet
- EC26 power unit

Available location codes:

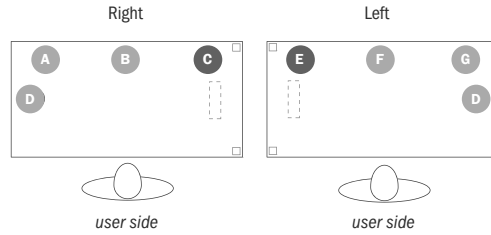
- A B or C

Run-off Desks with End Frames or Post Frames



(frame post)

non-handed product – grommets hand units



Dark gray locations (C & E) are not available on peninsula desks with frame post

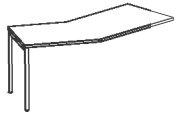
Available options:

- 3" grommet
- 12" grommet
- EC26 power unit

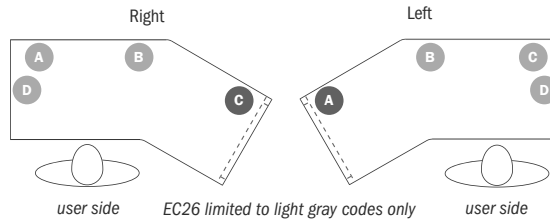
Available location codes:

- A B C or D (right)
- E F G or D (left)
- Locations apply to rectangular and arc shape tops with end frames

Boomerang Run-off Desks with End Frames



right side, approach view



EC26 limited to light gray codes only

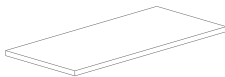
Available options:

- 3" grommet
- 12" grommet
- EC26 power unit (limited to 3 locations)

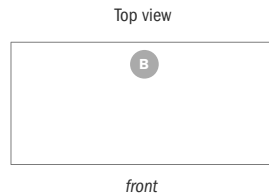
Available location codes:

- A B C or D
- EC26 power unit may not be located at outer end of bend

Bridge Tops



non-handed product



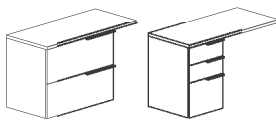
Available options:

- 3" grommet
- EC26 power unit

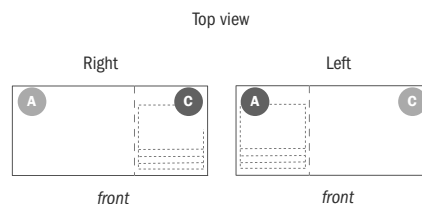
Available location codes:

- B

Returns



left side, user view



EC26 limited to light gray codes only

Available options:

- 3" grommet
- EC26 power unit (one location only)

Available location codes:

- A or C
- EC26 power unit may not be located above drawers

Flux Technology

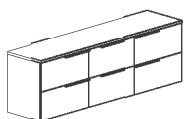
Location of Grommets and Worksurface Electrical (continued)

Available locations apply to all credenza widths listed (primary or secondary height). EC26 power units may not be located above drawers.

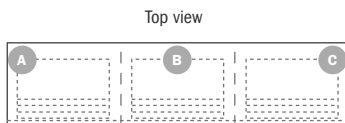


3" grommet EC26 power unit

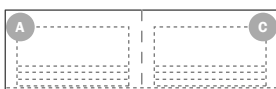
Lateral File Credenzas and Lateral File Pedestals



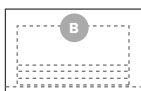
credenza with 3 file compartments, 90" w



credenza with 2 file compartments, 72" w or 60" w



lateral file pedestal, 36" w or 30" w



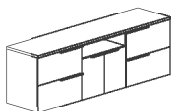
Available option:

- 3" grommet

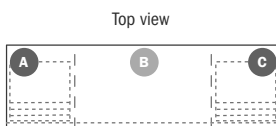
Available location codes:

- A, B or C (3 compartments)
- A or C (2 compartments)
- B (lateral file pedestal)
- Note: Grommets cannot be specified on secondary credenza at same location as the credenza mounts for a peninsula desk. See page 17 for additional information.

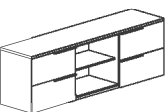
Storage Credenzas with Open Center Compartments



credenza with center storage/open compartment
96" w, 90" w, 84" w, 78" w, 72" w, 66" w or 60" w



EC26 limited to center location B only



credenza with open center compartment
96" w or 90" w



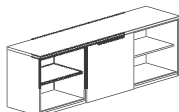
Available options:

- 3" grommet
- EC26 power unit (one location only)

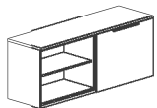
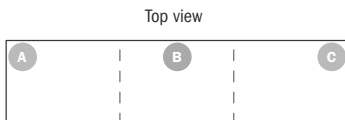
Available location codes:

- A, B or C
- EC26 power unit may not be located above drawers; limited to center location B only
- Note: Grommets or EC26 power units cannot be specified on secondary credenza at same location as the credenza mounts for a peninsula desk. See page 17 for additional information.

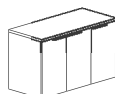
Credenzas with Open, Sliding or Hinge Door Compartments



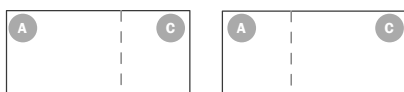
credenza without drawers, 96" w or 90" w



credenza without drawers, 72" w or 60" w



credenza without drawers, 54" w, 48" w or 42" w



storage unit without drawers, 36" w or 30" w



Available options:

- 3" grommet
- EC26 power unit

Available location codes:

- A, B or C (3 compartments)
- A or C (2 compartments)
- B (1 compartment)
- Note: Grommets or EC26 power units cannot be specified on secondary credenza at same location as the credenza mounts for a peninsula desk. See page 17 for additional information.

Flux Technology

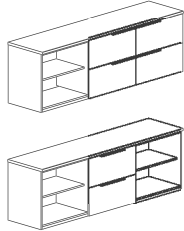
Location of Grommets and Worksurface Electrical (continued)

Available locations apply to all credenza widths listed (primary or secondary height). EC26 power units may not be located above drawers.

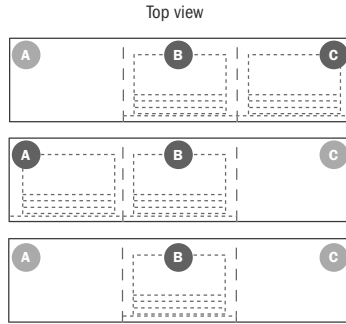


3" grommet EC26 power unit

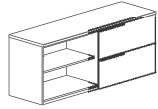
Lateral Storage Credenzas with End Open Compartment(s)



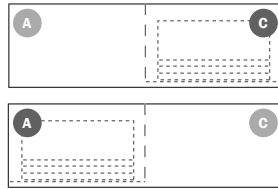
credenza with end open compartment(s)
96"w or 90"w



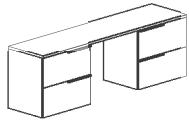
EC26 limited to open compartments only (light gray codes)



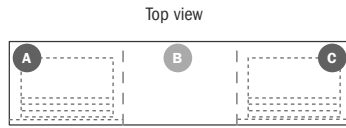
credenza with end open compartment
72"w, 66"w or 60"w



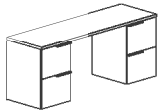
Kneespace Credenzas



lateral drawer kneespace credenza
96"w or 90"w



EC26 limited to center location B only



file drawer kneespace credenza
84"w, 78"w, 72"w, 66"w or 60"w



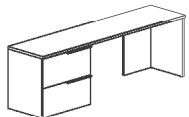
Available options:

- 3" grommet
- EC26 power unit (one location only)

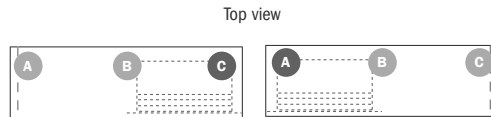
Available location codes:

- A, B or C (3 compartments)
- A or C (2 compartments)
- EC26 power unit may not be located above drawers; limited to center location B only

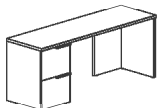
Lateral and File Credenzas



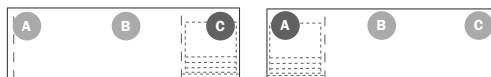
lateral drawer kneespace credenza
96"w, 90"w, 84"w, 78"w or 72"w



EC26 limited to open compartments only (light gray codes)



file drawer kneespace credenza
84"w, 78"w, 72"w, 66"w or 60"w



Available options:

- 3" grommet
- EC26 power unit (limited locations)

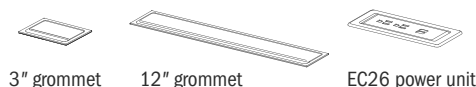
Available location codes:

- A, B or C (3 compartments)
- EC26 power unit may not be located above drawers

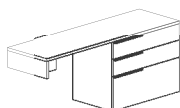
Flux Technology

Location of Grommets and Worksurface Electrical (continued)

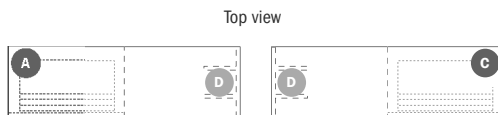
Available locations apply to all options listed within each category.
EC26 power units may not be located above drawers.



Peninsula Credenzas



peninsula credenza , user view
96"w, 90"w, 84"w, 78"w or 72"w



EC26 limited to location **D** only

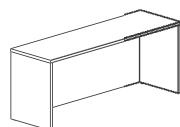
Available options:

- 3" grommet
- EC26 power unit (one location only)

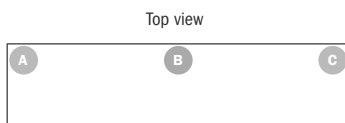
Available location codes:

- **A** **C** or **D**
- EC26 power unit may not be located above drawers; limited to center location **D** only

Credenza Shells and Return Shells



credenza shell and return
72"w or 66"w

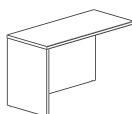


Available option:

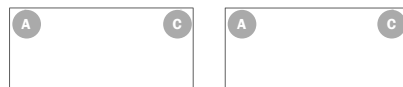
- 3" grommet

Available location codes:

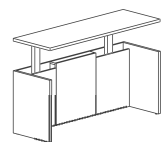
- **A** **B** or **C** (72"w or 66"w units)
- **A** or **C** (units 60"w or less)



credenza shell and return
60"w, 54"w, 48"w or 42"w



Adjustable Height Credenza Extensions and Return Shells



adjustable height credenza extension
72"w, 66"w, 60"w, 54"w or 48"w

Top view

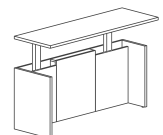


Available option:

- 3" grommet

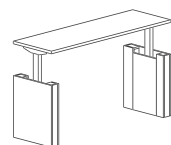
Available location codes:

- Codes apply only to adjustable height credenza extensions and adjustable height return shells.



adjustable height return shell
72"w, 66"w, 60"w, 54"w or 48"w

Adjustable Height Credenza



adjustable height credenza
72"w, 66"w, 60"w, 54"w or 48"w

Top view



Available option:

- 3" grommet

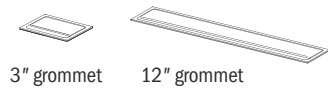
Available location codes:

- Codes apply only to adjustable height credenza.

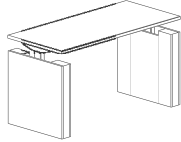
Flux Technology

Location of Grommets and Worksurface Electrical (continued)

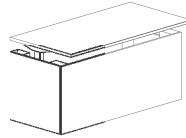
Available locations apply to all options listed within each category.



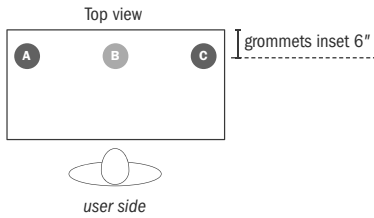
Adjustable Height Table Desks with End Panels



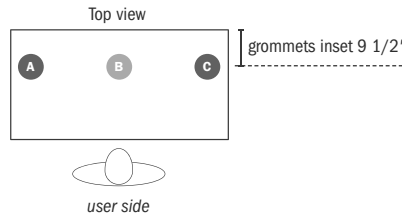
adjustable height table desks with end panels, approach view



adjustable height table desks with end panels and modesty, approach view



12" grommet limited to location B only



12" grommet limited to location B only

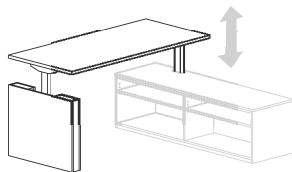
Available option:

- 3" grommet
- 12" grommet (one location only)

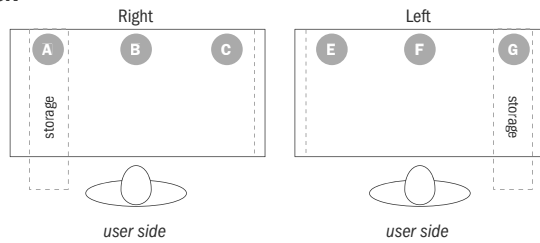
Available location codes:

- A, B or C
- 12" grommet limited to location B only
- Grommets are inset 6" to accommodate desk overhang
- Codes apply only to adjustable height table desks with end panels

Adjustable Height Peninsula Desk



non-handed product - grommets hand units



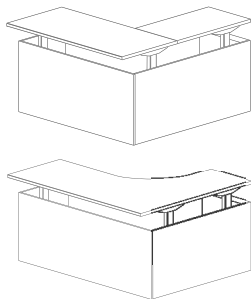
Available option:

- 3" grommet

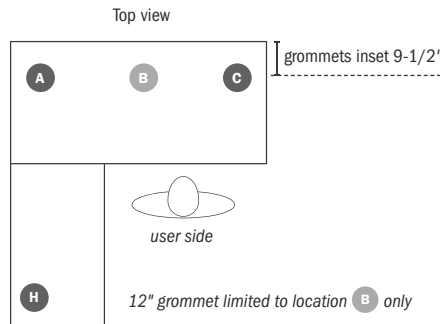
Available location codes:

- A, B or C (right)
- E, F or G (left)
- Locations apply to rectangular adjustable height peninsula desk

Adjustable Height L Configuration Desks and Returns



adjustable height L desks, left unit, approach view



Available option:

- 3" grommet
- 12" grommet (one location only)

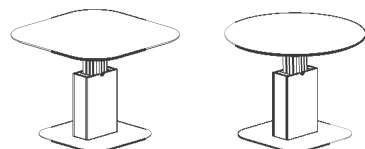
Available location codes:

- A, B or C (desk)
- H (return)
- 12" grommet limited to location B only
- Grommets are inset 6" to accommodate desk overhang

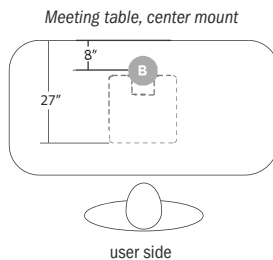
Adjustable Height Table Desks with Center Columns



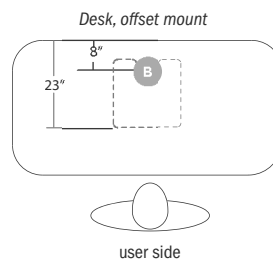
adjustable height rectangular table desk with center column



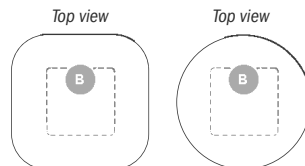
adjustable height square and round table desks with center column



user side



user side



Available option:

- 3" grommet (grommets are off-center)

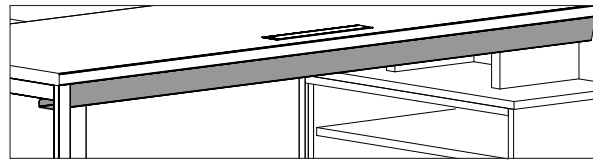
Available location codes:

- B
- Dimensional information for rectangular table desk is for a unit with a 36"d x 72"w top. Base can be mounted for a meeting table or a desk; grommet location remains the same on both mounting locations.

Flux Technology

Metal Wire Manager for Peninsula Desks and Run-off Desks

The wire manager is available in multiple lengths and four finishes: matte black, pewter, arctic silver and soft nickel. Use the charts on the following two pages to determine the appropriate wire manager model number for the selected peninsula or run-off desk.



Recommend Size with Peninsula or Run-off Desk

Laminate/Veneer Model Number	Wire Manager Model Number	
	Eased Edge	Knife Edge
FLT/FLV2848ARCTP	FLB0438MWM	FLB0438MWM
FLT/FLV2848RRTN	FLB0444MWM	FLB0444MWM
FLT/FLV2848RRTP	FLB0444MWM	FLB0444MWM
FLT/FLV2848TD	FLB0444MWM	FLB0438MWM
FLT/FLV2854ARCTP	FLB0444MWM	FLB0444MWM
FLT/FLV2854RDEPL/R	FLB0450MWM	NA
FLT/FLV2854RRTN	FLB0450MWM	FLB0450MWM
FLT/FLV2854RRTP	FLB0450MWM	FLB0450MWM
FLT/FLV2854TD	FLB0450MWM	FLB0444MWM
FLT/FLV2860ARCTP	FLB0450MWM	FLB0450MWM
FLT/FLV2860BMTNL/R	FLB0432MWM	FLB0432MWM
FLT/FLV2860RDEPL/R	FLB0456MWM	NA
FLT/FLV2860RRTN	FLB0456MWM	FLB0456MWM
FLT/FLV2860RRTP	FLB0456MWM	FLB0456MWM
FLT/FLV2860TD	FLB0456MWM	FLB0450MWM
FLT/FLV2866ARCTP	FLB0456MWM	FLB0456MWM
FLT/FLV2866BMTNL/R	FLB0432MWM	FLB0432MWM
FLT/FLV2866DTEPL/R	FLB0456MWM	NA
FLT/FLV2866PARCP	FLB0456MWM	FLB0456MWM
FLT/FLV2866PARCPEP	FLB0456MWM	NA
FLT/FLV2866PBMNEPL/R	FLB0432MWM	NA
FLT/FLV2866PBMNL/R	FLB0432MWM	FLB0432MWM
FLT/FLV2866PDEPL	FLB0462MWM	NA
FLT/FLV2866PDEPPL/R	FLB0462MWM	NA
FLT/FLV2866PDEPR	FLB0462MWM	NA
FLT/FLV2866PDN	FLB0462MWM	FLB0456MWM
FLT/FLV2866PDNEP	FLB0462MWM	NA
FLT/FLV2866PDP	FLB0462MWM	FLB0456MWM
FLT/FLV2866PDPEP	FLB0462MWM	NA
FLT/FLV2866PDTEPL/R	FLB0456MWM	NA
FLT/FLV2866RDEPL/R	FLB0462MWM	NA
FLT/FLV2866RRTN	FLB0462MWM	FLB0462MWM
FLT/FLV2866RRTP	FLB0462MWM	FLB0462MWM
FLT/FLV2866TD	FLB0462MWM	FLB0456MWM
FLT/FLV2872ARCTP	FLB0462MWM	FLB0462MWM
FLT/FLV2872BMTNL/R	FLB0438MWM	FLB0438MWM
FLT/FLV2872DTEPL/R	FLB0462MWM	NA

Laminate/Veneer Model Number	Wire Manager Model Number	
	Eased Edge	Knife Edge
FLT/FLV2872PARCP	FLB0462MWM	FLB0462MWM
FLT/FLV2872PARCPEP	FLB0462MWM	NA
FLT/FLV2872PBMNEPL/R	FLB0438MWM	NA
FLT/FLV2872PBMNL/R	FLB0438MWM	FLB0438MWM
FLT/FLV2872PDEPL	FLB0468MWM	NA
FLT/FLV2872PDEPPL/R	FLB0468MWM	NA
FLT/FLV2872PDEPR	FLB0468MWM	NA
FLT/FLV2872PDN	FLB0468MWM	FLB0462MWM
FLT/FLV2872PDNEP	FLB0468MWM	NA
FLT/FLV2872PDP	FLB0468MWM	FLB0462MWM
FLT/FLV2872PDPEP	FLB0468MWM	NA
FLT/FLV2872PDTEPL/R	FLB0462MWM	NA
FLT/FLV2872RDEPL/R	FLB0468MWM	NA
FLT/FLV2872RRTN	FLB0468MWM	FLB0468MWM
FLT/FLV2872RRTP	FLB0468MWM	FLB0468MWM
FLT/FLV2872TD	FLB0468MWM	FLB0462MWM
FLT/FLV2878DTEPL/R	FLB0468MWM	NA
FLT/FLV2878PARCP	FLB0468MWM	FLB0468MWM
FLT/FLV2878PARCPEP	FLB0468MWM	NA
FLT/FLV2878PBMNEPL/R	FLB0444MWM	NA
FLT/FLV2878PBMNL/R	FLB0444MWM	FLB0444MWM
FLT/FLV2878PDEPL	FLB0474MWM	NA
FLT/FLV2878PDEPPR	FLB0474MWM	NA
FLT/FLV2878PDEPR	FLB0474MWM	NA
FLT/FLV2878PDN	FLB0474MWM	FLB0468MWM
FLT/FLV2878PDNEP	FLB0474MWM	NA
FLT/FLV2878PDP	FLB0474MWM	FLB0468MWM
FLT/FLV2878PDPEP	FLB0474MWM	NA
FLT/FLV2878PDTEPL/R	FLB0468MWM	NA
FLT/FLV2884DTEPL/R	FLB0474MWM	NA
FLT/FLV2884PARCP	FLB0474MWM	FLB0474MWM
FLT/FLV2884PARCPEP	FLB0474MWM	NA
FLT/FLV2884PBMNEPL/R	FLB0450MWM	NA
FLT/FLV2884PBMNL/R	FLB0450MWM	FLB0450MWM
FLT/FLV2884PDEPL	FLB0480MWM	NA
FLT/FLV2884PDEPPL/R	FLB0480MWM	NA
FLT/FLV2884PDEPR	FLB0480MWM	NA

Flux Technology

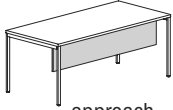
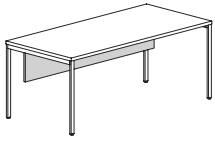
Recommend Size with Peninsula or Run-off Desk (continued)

Laminate/Veneer Model Number	Wire Manager Model Number	
	Eased Edge	Knife Edge
FLT/FLV2884PDN	FLB0480MWM	FLB0474MWM
FLT/FLV2884PDNEP	FLB0480MWM	NA
FLT/FLV2884PDP	FLB0480MWM	FLB0474MWM
FLT/FLV2884PDPEP	FLB0480MWM	NA
FLT/FLV2884PDTEPL/R	FLB0474MWM	NA
FLT/FLV3448ARCTP	FLB0438MWM	FLB0438MWM
FLT/FLV3448RRTN	FLB0444MWM	FLB0444MWM
FLT/FLV3448RRTP	FLB0444MWM	FLB0444MWM
FLT/FLV3454ARCTP	FLB0444MWM	FLB0444MWM
FLT/FLV3454RDEPL/R	FLB0450MWM	NA
FLT/FLV3454RRTN	FLB0450MWM	FLB0450MWM
FLT/FLV3454RRTP	FLB0450MWM	FLB0450MWM
FLT/FLV3460ARCTP	FLB0450MWM	FLB0450MWM
FLT/FLV3460BMTNL/R	FLB0432MWM	FLB0432MWM
FLT/FLV3460RDEPL/R	FLB0456MWM	NA
FLT/FLV3460RRTN	FLB0456MWM	FLB0456MWM
FLT/FLV3460RRTP	FLB0456MWM	FLB0456MWM
FLT/FLV3466ARCTP	FLB0456MWM	FLB0456MWM
FLT/FLV3466BMTNL/R	FLB0432MWM	FLB0432MWM
FLT/FLV3466DTEPL/R	FLB0456MWM	NA
FLT/FLV3466PARCP	FLB0456MWM	FLB0456MWM
FLT/FLV3466PARCPEP	FLB0456MWM	NA
FLT/FLV3466PBMNEPL/R	FLB0432MWM	NA
FLT/FLV3466PBMNL/R	FLB0432MWM	FLB0432MWM
FLT/FLV3466PDEPL	FLB0462MWM	NA
FLT/FLV3466PDEPPL/R	FLB0462MWM	NA
FLT/FLV3466PDEPR	FLB0462MWM	NA
FLT/FLV3466PDN	FLB0462MWM	FLB0456MWM
FLT/FLV3466PDNEP	FLB0462MWM	NA
FLT/FLV3466PDP	FLB0462MWM	FLB0456MWM
FLT/FLV3466PDPEP	FLB0462MWM	NA
FLT/FLV3466PDTEPL/R	FLB0456MWM	NA
FLT/FLV3466RDEPL/R	FLB0462MWM	NA
FLT/FLV3466RRTN	FLB0462MWM	FLB0462MWM
FLT/FLV3466RRTP	FLB0462MWM	FLB0462MWM
FLT/FLV3466TD	FLB0462MWM	FLB0456MWM
FLT/FLV3472ARCTP	FLB0462MWM	FLB0462MWM
FLT/FLV3472BMTNL/R	FLB0438MWM	FLB0438MWM
FLT/FLV3472DTEPL/R	FLB0462MWM	NA
FLT/FLV3472PARCP	FLB0462MWM	FLB0462MWM
FLT/FLV3472PARCPEP	FLB0462MWM	NA

Laminate/Veneer Model Number	Wire Manager Model Number	
	Eased Edge	Knife Edge
FLT/FLV3472PBMNEPL/R	FLB0438MWM	NA
FLT/FLV3472PBMNL/R	FLB0438MWM	FLB0438MWM
FLT/FLV3472PDEPL	FLB0468MWM	NA
FLT/FLV3472PDEPPL/R	FLB0468MWM	NA
FLT/FLV3472PDEPR	FLB0468MWM	NA
FLT/FLV3472PDN	FLB0468MWM	FLB0462MWM
FLT/FLV3472PDNEP	FLB0468MWM	NA
FLT/FLV3472PDP	FLB0468MWM	FLB0462MWM
FLT/FLV3472PDPEP	FLB0468MWM	NA
FLT/FLV3472PDTEPL/R	FLB0462MWM	NA
FLT/FLV3472RDEPL/R	FLB0468MWM	NA
FLT/FLV3472RRTN	FLB0468MWM	FLB0468MWM
FLT/FLV3472RRTP	FLB0468MWM	FLB0468MWM
FLT/FLV3472TD	FLB0468MWM	FLB0462MWM
FLT/FLV3478DTEPL/R	FLB0468MWM	NA
FLT/FLV3478PARCP	FLB0468MWM	FLB0468MWM
FLT/FLV3478PARCPEP	FLB0468MWM	NA
FLT/FLV3478PBMNEPL/R	FLB0444MWM	NA
FLT/FLV3478PBMNL/R	FLB0444MWM	FLB0444MWM
FLT/FLV3478PDEPL	FLB0474MWM	NA
FLT/FLV3478PDEPPL/R	FLB0474MWM	NA
FLT/FLV3478PDEPR	FLB0474MWM	NA
FLT/FLV3478PDN	FLB0474MWM	FLB0468MWM
FLT/FLV3478PDNEP	FLB0474MWM	NA
FLT/FLV3478PDP	FLB0474MWM	FLB0468MWM
FLT/FLV3478PDPEP	FLB0474MWM	NA
FLT/FLV3478PDTEPL/R	FLB0468MWM	NA
FLT/FLV3484DTEPL/R	FLB0474MWM	NA
FLT/FLV3484PARCP	FLB0474MWM	FLB0474MWM
FLT/FLV3484PARCPEP	FLB0474MWM	NA
FLT/FLV3484PBMNEPL/R	FLB0450MWM	NA
FLT/FLV3484PBMNL/R	FLB0450MWM	FLB0450MWM
FLT/FLV3484PDEPL	FLB0480MWM	NA
FLT/FLV3484PDEPPL/R	FLB0480MWM	NA
FLT/FLV3484PDEPR	FLB0480MWM	NA
FLT/FLV3484PDN	FLB0480MWM	FLB0474MWM
FLT/FLV3484PDNEP	FLB0480MWM	NA
FLT/FLV3484PDP	FLB0480MWM	FLB0474MWM
FLT/FLV3484PDPEP	FLB0480MWM	NA
FLT/FLV3484PDTEPL/R	FLB0474MWM	NA

PRODUCT INFORMATION

Description	D	W	H	CTN WT	CU FT	① Model	HPL Laminate	Flat Cut Veneer	Double Cut Veneer
Table Desk	33½	72	29	139	22	FLT3472TD	\$1,981		
	33½	72	29	139	22	FLV3472TD		\$2,419	\$2,662
	33½	66	29	130	20	FLT3466TD	\$1,958		
	33½	66	29	130	20	FLV3466TD		\$2,390	\$2,632



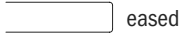
approach

Features:

- eased edge profile on approach and user sides

Options:

- reverse bevel edge available on approach and user sides, specify; add \$429 list for laminate or \$168 list for veneer; see page 8 for details
- casters available, two locking and two non-locking, specify and add \$98 list
- 13 ½" h modesty panel available, specify; add \$427 list for laminate or \$594 list for veneer; see page 21 for details
- 3" top grommet available, specify A or C location; add \$128 list each

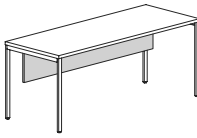

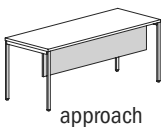


eased



reverse bevel

edges

Description	D	W	H	CTN WT	CU FT	① Model	HPL Laminate	Flat Cut Veneer	Double Cut Veneer
   eased reverse bevel edges	27 1/2	72	29	112	18	FLT2872TD	\$1,891		
	27 1/2	72	29	112	18	FLV2872TD		\$2,322	\$2,554
	27 1/2	66	29	105	17	FLT2866TD	\$1,876		
	27 1/2	66	29	105	17	FLV2866TD		\$2,303	\$2,531
	27 1/2	60	29	99	15	FLT2860TD	\$1,859		
	27 1/2	60	29	99	15	FLV2860TD		\$2,280	\$2,508
	27 1/2	54	29	93	14	FLT2854TD	\$1,843		
	27 1/2	54	29	93	14	FLV2854TD		\$2,260	\$2,487
	27 1/2	48	29	87	12	FLT2848TD	\$1,820		
	27 1/2	48	29	87	12	FLV2848TD		\$2,234	\$2,341

Features:

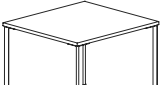
- eased edge profile on approach and user sides

Options:

- reverse bevel edge available on approach and user sides, specify; add \$429 list for laminate or \$168 list for veneer; see page 8 for details
- casters available, two locking and two non-locking, specify and add \$98 list
- 13 1/2" h modesty panel available, specify; add \$427 list for laminate or \$594 list for veneer; see page 21 for details
- 3" top grommet available, specify A or C location; add \$128 list each

To Order, Specify:

① Laminate Model #	② Laminate Type	③ Laminate Selection		④ Metal Color	⑤ Other Product Options
Laminate (FLT)	HPL	See Laminate Selection		See Metal Finish Color Options	See list of options for each specific unit; Specify and add accordingly.
① Veneer Model #	② Wood Species	③ Wood Finish		④ Metal Color	⑤ Other Product Options
Veneer (FLV)	Flat Cut CH1 Cherry MA1 Maple WA1 Walnut BO1 Black Oak	See Flat Cut Wood Finish Options		See Metal Finish Color Options	See list of options for each specific unit; Specify and add accordingly.
	Double Cut DC1 Double Cut	ⓐ Wood Finish	ⓑ Chassis Grain Direction		
		See Double Cut Wood Finish Options	For Double Cut Only: Vertical Horizontal		

Description	D	W	H	CTN WT	CU FT	① Model	HPL Laminate	Flat Cut Veneer	Double Cut Veneer
	48	48	29	94	14	FLT4848T	\$1,665		
	48	48	29	94	14	FLV4848T		\$2,190	\$2,409
	42	42	29	75	12	FLT4242T	\$1,415		
	42	42	29	75	12	FLV4242T		\$1,861	\$2,047

Features

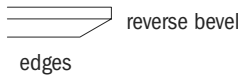
- eased edge profile all sides

Options:


- reverse bevel edge available on top perimeter, specify; add \$429 list for laminate or \$168 list for veneer; see page 8 for details
- casters available, two locking and two non-locking, specify and add \$98 list



eased



reverse bevel edges

	33½	33½	29	69	10	FLT3434T	\$1,344		
	33½	33½	29	69	10	FLV3434T		\$1,768	\$1,945
	27½	27½	29	51	9	FLT2828T	\$1,279		
	27½	27½	29	51	9	FLV2828T		\$1,679	\$1,849

Features:

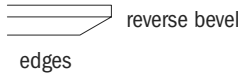
- eased edge profile all sides

Options:

- reverse bevel edge available on top perimeter, specify; add \$429 list for laminate or \$168 list for veneer; see page 8 for details
- casters available, two locking and two non-locking, specify and add \$98 list



eased



reverse bevel edges

	48	48	29	301	46	FLT4848RT	\$1,745		
	48	48	29	77	14	FLV4848RT		\$2,296	\$2,526
	42	42	29	62	12	FLT4242RT	\$1,482		
	42	42	29	62	12	FLV4242RT		\$1,949	\$2,145

Features:

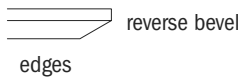
- eased edge profile

Options:


- reverse bevel edge available on top perimeter, specify; add \$429 list for laminate or \$168 list for veneer; see page 8 for details
- casters available, two locking and two non-locking, specify and add \$98 list



eased



reverse bevel edges

Description	D	W	H	CTN WT	CU FT	1 Model	HPL Laminate	Flat Cut Veneer	Double Cut Veneer
Square Stationary Height Table with Eased Edge Profile - Four Star Base 	30	30	29	39	19	FLT3030ST4B	\$1,479		
	30	30	29	39	19	FLV3030ST4B		\$1,942	\$2,136
	24	24	29	31	13	FLT2424ST4B	\$1,440		
	24	24	29	31	13	FLV2424ST4B		\$1,893	\$2,084

Features:

- ¾" top with flat edge
- 4-star cast aluminum base

Options:

- casters available, two locking and two non-locking, specify and add \$98 list

Description	D	W	H	CTN WT	CU FT	Model	HPL Laminate	Flat Cut Veneer	Double Cut Veneer
Round Stationary Height Table 	36	36	29	43	27	FLT3636R4B	\$1,516		
	36	36	29	43	27	FLV3636R4B		\$1,993	\$2,191
	30	30	29	36	19	FLT3030R4B	\$1,479		
	30	30	29	36	19	FLV3030R4B		\$1,942	\$2,136

Features:

- ¾" top with flat edge
- 4-star cast aluminum base

Options:

- casters available, two locking and two non-locking, specify and add \$98 list

Description	D	W	H	CTN WT	CU FT	Model	HPL Laminate	Flat Cut Veneer	Double Cut Veneer
Oval Stationary Height Table 	26	36	29	39	20	FLT2636O4B	\$1,557		
	26	36	29	39	20	FLV2636O4B		\$2,043	\$2,247

Features:

- ¾" top with flat edge
- 4-star cast aluminum base

Options:

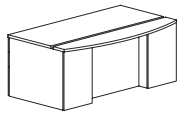
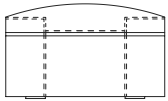
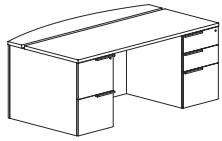
- casters available, two locking and two non-locking, specify and add \$98 list

To Order, Specify:

1 Laminate Model #	2 Laminate Type	3 Laminate Selection	4 Metal Color	5 Other Product Options
Laminate (FLT)	HPL	See Laminate Selection	See Metal Finish Color Options	See list of options for each specific unit; Specify and add accordingly.

1 Veneer Model #	2 Wood Species	3 Wood Finish	4 Metal Color	5 Other Product Options
Veneer (FLV)	Flat Cut CH1 Cherry MA1 Maple WA1 Walnut BO1 Black Oak	See Flat Cut Wood Finish Options	See Metal Finish Color Options	See list of options for each specific unit; Specify and add accordingly.
	Double Cut DC1 Double Cut	3a Wood Finish See Double Cut Wood Finish Options		

Description	D	W	H	CTN WT	CU FT	① Model	HPL Laminate	Flat Cut Veneer	Double Cut Veneer
Bow Front Double Pedestal Desk with Break Front Modesty Continuous Wire Channel - Split Top	42	84	29	359	69	FLT4284BDST	\$3,550		
	42	84	29	359	69	FLV4284BDST		\$4,876	\$5,363
	42	78	29	348	64	FLT4278BDST	\$3,467		
	42	78	29	348	64	FLV4278BDST		\$4,764	\$5,238
	42	72	29	337	59	FLT4272BDST	\$3,388		
	42	72	29	337	59	FLV4272BDST		\$4,652	\$5,116



approach

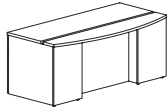
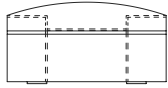
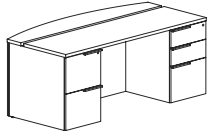
Features:

- eased edge profile on approach and user sides
- built in horizontal wire channel
- 6" overhang on approach side
- pedestal front locking
- FLT4284BDST or FLV4284BDST - chassis 36" x 84"
- FLT4278BDST or FLV4278BDST - chassis 36" x 78"
- FLT4272BDST or FLV4272BDST - chassis 36" x 72"
- FLT4284BDST or FLV4284BDST - kneespace 48"
- FLT4278BDST or FLV4278BDST - kneespace 42"
- FLT4272BDST or FLV4272BDST - kneespace 36"

Options:

- must specify chassis grain direction on double cut veneer, see pages 13-15 for details
- veneer drawer fronts in paint available, specify paint color; add \$337 list; see page 16 for details
- on laminate units, contrasting worksurface tops and drawer fronts available, no upcharge; specify color, see page 16 for details
- must specify ledge or prism pull, specify and see page 9 for details
- pedestal access doors available, specify; add \$283 list for laminate or \$337 list for veneer; see page 17 for details

Description	D	W	H	CTN WT	CU FT	① Model	HPL Laminate	Flat Cut Veneer	Double Cut Veneer
Bow Front Double Pedestal Desk with Break Front Modesty - Continuous Wire Channel - Split Top	36	84	29	341	60	FLT3684BDST	\$3,441		
	36	84	29	341	60	FLV3684BDST		\$4,647	\$5,111
	36	78	29	331	55	FLT3678BDST	\$3,369		
	36	78	29	331	55	FLV3678BDST		\$4,543	\$4,995
	36	72	29	320	51	FLT3672BDST	\$3,296		
	36	72	29	320	51	FLV3672BDST		\$4,442	\$4,886
	36	66	29	309	47	FLT3666BDST	\$3,239		
	36	66	29	309	47	FLV3666BDST		\$4,361	\$4,797
	36	60	29	298	43	FLT3660BDST	\$3,181		
	36	60	29	298	43	FLV3660BDST		\$4,284	\$4,710



approach

Features:

- eased edge profile on approach and user sides
- built in horizontal wire channel
- 6" overhang on approach side
- pedestal front locking
- FLT3684BDST or FLV3684BDST - chassis 30" x 84"
- FLT3678BDST or FLV3678BDST - chassis 30" x 78"
- FLT3672BDST or FLV3672BDST - chassis 30" x 72"
- FLT3666BDST or FLV3666BDST - chassis 30" x 66"
- FLT3660BDST or FLV3660BDST - chassis 30" x 60"
- FLT3684BDST or FLV3684BDST - kneespace 48"
- FLT3678BDST or FLV3678BDST - kneespace 42"
- FLT3672BDST or FLV3672BDST - kneespace 36"
- FLT3666BDST or FLV3666BDST - kneespace 34 3/4"
- FLT3660BDST or FLV3660BDST - kneespace 28 3/4"

Options:

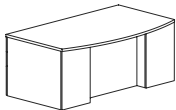
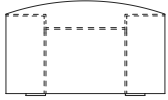
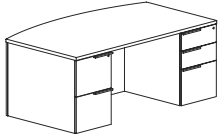
- veneer drawer fronts in paint available, specify paint color; add \$337 list; see page 16 for details
- on laminate units, contrasting worksurface tops and drawer fronts available, no upcharge; specify color, see page 16 for details
- ledge pulls standard; prism pulls available, specify and see page 9
- pedestal access doors available, specify; add \$283 list for laminate or \$337 list for veneer; see page 17 for details

To Order, Specify:

① Laminate Model #	② Laminate Type	③ Laminate Selection		④ Metal Color	⑤ Other Product Options
Laminate (FLT)	HPL	See Laminate Selection		See Metal Finish Color Options	See list of options for each specific unit; Specify and add accordingly.

① Veneer Model #	② Wood Species	③ Wood Finish		④ Metal Color	⑤ Other Product Options
Veneer (FLV)	Flat Cut CH1 Cherry MA1 Maple WA1 Walnut BO1 Black Oak	See Flat Cut Wood Finish Options		See Metal Finish Color Options	See list of options for each specific unit; Specify and add accordingly.
		ⓐ Wood Finish	ⓑ Chassis Grain Direction		
	Double Cut DC1 Double Cut	See Double Cut Wood Finish Options	For Double Cut Only: Vertical Horizontal		

Description	D	W	H	CTN WT	CU FT	① Model	HPL Laminate	Flat Cut Veneer	Double Cut Veneer
Bow Front Double Pedestal Desk with Break Front Modesty	42	84	29	359	69	FLT4284BD	\$3,351		
	42	84	29	359	69	FLV4284BD		\$4,680	\$5,147
	42	78	29	348	64	FLT4278BD	\$3,271		
	42	78	29	348	64	FLV4278BD		\$4,567	\$5,024
	42	72	29	337	59	FLT4272BD	\$3,192		
	42	72	29	337	59	FLV4272BD		\$4,453	\$4,900



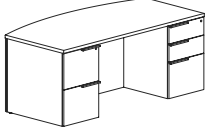
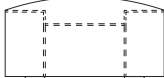
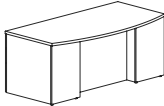
approach

Features:

- eased edge profile on approach and user sides
- 6" overhang on approach side
- pedestal front locking
- FLT4284BD or FLV4284BD - chassis 36" x 84"
- FLT4278BD or FLV4278BD - chassis 36" x 78"
- FLT4272BD or FLV4272BD - chassis 36" x 72"
- FLT4284BD or FLV4284BD - kneespace 48"
- FLT4278BD or FLV4278BD - kneespace 42"
- FLT4272BD or FLV4272BD - kneespace 36"

Options:

- must specify chassis grain direction on double cut veneer, see pages 13-15 for details
- veneer drawer fronts in paint available, specify paint color; add \$337 list; see page 16 for details
- on laminate units, contrasting worksurface tops and drawer fronts available, no upcharge; specify color, see page 16 for details
- ledge pulls standard; prism pulls available, specify and see page 9
- top grommet available, specify location; add \$128 list each; see page 44 for details
- worksurface power available, specify "to accommodate EC26" on your purchase order; EC26 unit must be ordered separately, see page 44
- pedestal access door with wire manager available, use with top grommet, specify; add \$337 list for laminate or \$390 list for veneer; see page 17 for details
- interior kneespace wire manager available, use with top grommet or power unit, specify and add \$114 list; see page 17 for details

Description	D	W	H	CTN WT	CU FT	① Model	HPL Laminate	Flat Cut Veneer	Double Cut Veneer
   approach	36	84	29	341	60	FLT3684BD	\$3,245		
	36	84	29	341	60	FLV3684BD		\$4,448	\$4,896
	36	78	29	331	55	FLT3678BD	\$3,172		
	36	78	29	331	55	FLV3678BD		\$4,343	\$4,779
	36	72	29	320	51	FLT3672BD	\$3,098		
	36	72	29	320	51	FLV3672BD		\$4,246	\$4,668
	36	66	29	309	47	FLT3666BD	\$3,044		
	36	66	29	309	47	FLV3666BD		\$4,165	\$4,581
	36	60	29	298	43	FLT3660BD	\$2,984		
	36	60	29	298	43	FLV3660BD		\$4,087	\$4,494

Features:

- eased edge profile on approach and user sides
- 6" overhang on approach side
- pedestal front locking
- FLT3684BD or FLV3684BD - chassis 30" x 84"
- FLT3678BD or FLV3678BD - chassis 30" x 78"
- FLT3672BD or FLV3672BD - chassis 30" x 72"
- FLT3666BD or FLV3666BD - chassis 30" x 66"
- FLT3660BD or FLV3660BD - chassis 30" x 60"
- FLT3684BD or FLV3684BD - kneespace 48"
- FLT3678BD or FLV3678BD - kneespace 42"
- FLT3672BD or FLV3672BD - kneespace 36"
- FLT3666BD or FLV3666BD - kneespace 34 3/4"
- FLT3660BD or FLV3660BD - kneespace 28 3/4"

Options:

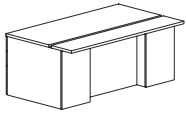
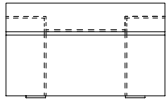
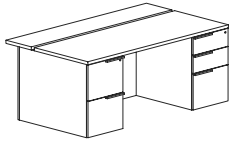
- must specify chassis grain direction on double cut veneer, see pages 13-15 for details
- veneer drawer fronts in paint available, specify paint color; add \$337 list; see page 16 for details
- on laminate units, contrasting worksurface tops and drawer fronts available, no upcharge; specify laminate color, see page 16 for details
- ledge pulls standard; prism pulls available, specify and see page 9
- top grommet available, specify location; add \$128 list each; see page 44 for details
- worksurface power available, specify "to accommodate EC26" on your purchase order; EC26 unit must be ordered separately, see page 44
- pedestal access door with wire manager available, use with top grommet, specify; add \$337 list for laminate or \$390 list for veneer; see page 17 for details

To Order, Specify:

① Laminate Model #	② Laminate Type	③ Laminate Selection		④ Metal Color	⑤ Other Product Options
Laminate (FLT)	HPL	See Laminate Selection		See Metal Finish Color Options	See list of options for each specific unit; Specify and add accordingly.

① Veneer Model #	② Wood Species	③ Wood Finish		④ Metal Color	⑤ Other Product Options
Veneer (FLV)	Flat Cut CH1 Cherry MA1 Maple WA1 Walnut BO1 Black Oak	See Flat Cut Wood Finish Options		See Metal Finish Color Options	See list of options for each specific unit; Specify and add accordingly.
		ⓐ Wood Finish	ⓑ Chassis Grain Direction		
	Double Cut DC1 Double Cut	See Double Cut Wood Finish Options	For Double Cut Only: Vertical Horizontal		

Description	D	W	H	CTN WT	CU FT	① Model	HPL Laminate	Flat Cut Veneer	Double Cut Veneer
Double Pedestal Desk with Break	42	84	29	370	69	FLT4284EDST	\$3,394		
Front Modesty Modesty Continuous Wire Channel - Split Top	42	84	29	370	69	FLV4284EDST		\$4,661	\$5,127
	42	78	29	357	64	FLT4278EDST	\$3,315		
	42	78	29	357	64	FLV4278EDST		\$4,550	\$5,009
	42	72	29	359	59	FLT4272EDST	\$3,241		
	42	72	29	359	59	FLV4272EDST		\$4,445	\$4,889



approach

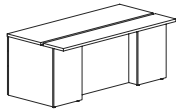
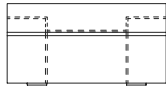
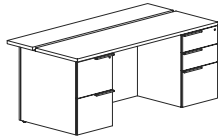
Features:

- eased edge profile on approach and user sides
- built in horizontal wire channel
- 6" overhang on approach side
- pedestal front locking
- FLT4284EDST or FLV4284EDST - chassis 36" x 84"
- FLT4278EDST or FLV4278EDST - chassis 36" x 78"
- FLT4272EDST or FLV4272EDST - chassis 36" x 72"
- FLT4284EDST or FLV4284EDST - kneespace 48"
- FLT4278EDST or FLV4278EDST - kneespace 42"
- FLT4272EDST or FLV4272EDST - kneespace 36"

Options:

- must specify chassis grain direction on double cut veneer, see pages 13-15 for details
- veneer drawer fronts in paint available, specify paint color; add \$337 list; see page 16 for details
- on laminate units, contrasting worksurface tops and drawer fronts available, no upcharge; specify color, see page 16 for details
- ledge pulls standard; prism pulls available, specify and see page 9
- pedestal access doors available, specify; add \$283 list for laminate or \$337 list for veneer; see page 17 for details

Description	D	W	H	CTN WT	CU FT	① Model	HPL Laminate	Flat Cut Veneer	Double Cut Veneer
Double Pedestal Desk with Break	36	84	29	325	60	FLT3684EDST	\$3,236		
Front Modesty - Continuous Wire Channel - Split Top	36	84	29	325	60	FLV3684EDST		\$4,441	\$4,885
	36	78	29	314	55	FLT3678EDST	\$3,162		
	36	78	29	314	55	FLV3678EDST		\$4,336	\$4,771
	36	72	29	303	51	FLT3672EDST	\$3,090		
	36	72	29	303	51	FLV3672EDST		\$4,235	\$4,659
	36	66	29	315	47	FLT3666EDST	\$3,030		
	36	66	29	315	47	FLV3666EDST		\$4,155	\$4,572
	36	60	29	304	43	FLT3660EDST	\$2,975		
	36	60	29	304	43	FLV3660EDST		\$4,077	\$4,484



approach

Features:

- eased edge profile on approach and user sides
- built in horizontal wire channel
- 6" overhang on approach side
- pedestal front locking
- FLT3684EDST or FLV3684EDST - chassis 30" x 84"
- FLT3678EDST or FLV3678EDST - chassis 30" x 78"
- FLT3672EDST or FLV3672EDST - chassis 30" x 72"
- FLT3666EDST or FLV3666EDST - chassis 30" x 66"
- FLT3660EDST or FLV3660EDST - chassis 30" x 60"
- FLT3684EDST or FLV3684EDST - kneespace 48"
- FLT3678EDST or FLV3678EDST - kneespace 42"
- FLT3672EDST or FLV3672EDST - kneespace 36"
- FLT3666EDST or FLV3666EDST - kneespace 34 3/4"
- FLT3660EDST or FLV3660EDST - kneespace 28 3/4"

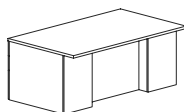
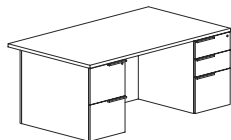
Options:

- must specify chassis grain direction on double cut veneer, see pages 13-15 for details
- veneer drawer fronts in paint available, specify paint color; add \$337 list; see page 16 for details
- on laminate units, contrasting worksurface tops and drawer fronts available, no upcharge; specify laminate color, see page 16 for details
- ledge pulls standard; prism pulls available, specify and see page 9
- pedestal access doors available, specify; add \$283 list for laminate or \$337 list for veneer; see page 17 for details

To Order, Specify:

① Laminate Model #	② Laminate Type	③ Laminate Selection		④ Metal Color	⑤ Other Product Options
Laminate (FLT)	HPL	See Laminate Selection		See Metal Finish Color Options	See list of options for each specific unit; Specify and add accordingly.
① Veneer Model #	② Wood Species	③ Wood Finish		④ Metal Color	⑤ Other Product Options
Veneer (FLV)	Flat Cut CH1 Cherry MA1 Maple WA1 Walnut BO1 Black Oak	See Flat Cut Wood Finish Options		See Metal Finish Color Options	See list of options for each specific unit; Specify and add accordingly.
	Double Cut DC1 Double Cut	ⓐ Wood Finish	ⓑ Chassis Grain Direction		
		See Double Cut Wood Finish Options	For Double Cut Only: Vertical Horizontal		

Description	D	W	H	CTN WT	CU FT	① Model	HPL Laminate	Flat Cut Veneer	Double Cut Veneer
Double Pedestal Desk with Break Front Modesty	42	84	29	357	69	FLT4284ED	\$3,198		
	42	84	29	357	69	FLV4284ED		\$4,465	\$4,912
	42	78	29	359	64	FLT4278ED	\$3,120		
	42	78	29	359	64	FLV4278ED		\$4,355	\$4,791
	42	72	29	349	59	FLT4272ED	\$3,045		
	42	72	29	349	59	FLV4272ED		\$4,249	\$4,672



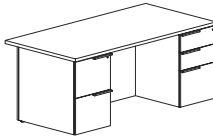
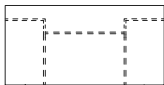
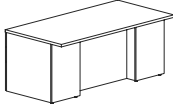
approach

Features:

- eased edge profile on approach and user sides
- 6" overhang on approach side
- pedestal front locking
- FLT4284ED or FLV4284ED - chassis 36" x 84"
- FLT4278ED or FLV4278ED - chassis 36" x 78"
- FLT4272ED or FLV4272ED - chassis 36" x 72"
- FLT4284ED or FLV4284ED - kneespace 48"
- FLT4278ED or FLV4278ED - kneespace 42"
- FLT4272ED or FLV4272ED - kneespace 36"

Options:

- must specify chassis grain direction on double cut veneer, see pages 13-15 for details
- veneer drawer fronts in paint available, specify paint color; add \$337 list; see page 16 for details
- on laminate units, contrasting worksurface tops and drawer fronts available, no upcharge; specify color, see page 16 for details
- ledge pulls standard; prism pulls available, specify and see page 9
- top grommet available, specify location; add \$128 list each; see page 44 for details
- worksurface power available, specify "to accommodate EC26" on your purchase order; EC26 unit must be ordered separately, see page 44
- pedestal access door with wire manager available, use with top grommet, specify; add \$337 list for laminate or \$390 list for veneer; see page 17 for details
- interior kneespace wire manager available, use with top grommet or power unit, specify and add \$114 list; see page 17 for details

Description	D	W	H	CTN WT	CU FT	① Model	HPL Laminate	Flat Cut Veneer	Double Cut Veneer
Double Pedestal Desk with Break Front Modesty    approach	36	84	29	325	60	FLT3684ED	\$3,040		
	36	84	29	325	60	FLV3684ED		\$4,244	\$4,667
	36	78	29	314	55	FLT3678ED	\$2,966		
	36	78	29	314	55	FLV3678ED		\$4,140	\$4,554
	36	72	29	303	51	FLT3672ED	\$2,894		
	36	72	29	303	51	FLV3672ED		\$4,038	\$4,443
	36	66	29	315	47	FLT3666ED	\$2,836		
	36	66	29	315	47	FLV3666ED		\$3,959	\$4,355
	36	60	29	304	43	FLT3660ED	\$2,779		
	36	60	29	304	43	FLV3660ED		\$3,881	\$4,268

Features:

- eased edge profile on approach and user sides
- 6" overhang on approach side
- pedestal front locking
- FLT3684ED or FLV3684ED - chassis 30" x 84"
- FLT3678ED or FLV3678ED - chassis 30" x 78"
- FLT3672ED or FLV3672ED - chassis 30" x 72"
- FLT3666ED or FLV3666ED - chassis 30" x 66"
- FLT3660ED or FLV3660ED - chassis 30" x 72"
- FLT3684ED or FLV3684ED - kneespace 48"
- FLT3678ED or FLV3678ED - kneespace 42"
- FLT3672ED or FLV3672ED - kneespace 36"
- FLT3666ED or FLV3666ED - kneespace 28 3/4"
- FLT3660ED or FLV3660ED - kneespace 28 3/4"

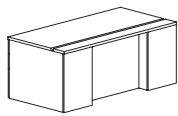
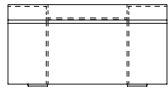
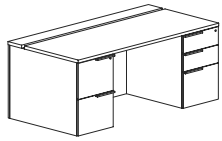
Options:

- must specify chassis grain direction on double cut veneer, see pages 13-15 for details
- veneer drawer fronts in paint available, specify paint color; add \$337 list; see page 16 for details
- on laminate units, contrasting worksurface tops and drawer fronts available, no upcharge; specify laminate color, see page 16 for details
- ledge pulls standard; prism pulls available, specify and see page 9
- top grommet available, specify location; add \$128 list each; see page 44 for details
- worksurface power available, specify "to accommodate EC26" on your purchase order; EC26 unit must be ordered separately, see page 44
- pedestal access door with wire manager available, use with top grommet, specify; add \$337 list for laminate or \$390 list for veneer; see page 17 for details

To Order, Specify:

① Laminate Model #	② Laminate Type	③ Laminate Selection		④ Metal Color	⑤ Other Product Options
Laminate (FLT)	HPL	See Laminate Selection		See Metal Finish Color Options	See list of options for each specific unit; Specify and add accordingly.
① Veneer Model #	② Wood Species	③ Wood Finish		④ Metal Color	⑤ Other Product Options
Veneer (FLV)	Flat Cut CH1 Cherry MA1 Maple WA1 Walnut BO1 Black Oak	See Flat Cut Wood Finish Options		See Metal Finish Color Options	See list of options for each specific unit; Specify and add accordingly.
	Double Cut DC1 Double Cut	3a Wood Finish See Double Cut Wood Finish Options	3b Chassis Grain Direction For Double Cut Only: Vertical Horizontal		

Description	D	W	H	CTN WT	CU FT	① Model	HPL Laminate	Flat Cut Veneer	Double Cut Veneer
Double Pedestal Desk with Break	36	84	29	352	60	FLT3684DDST	\$3,330		
Front Modesty Continuous Wire Channel - Split Top	36	84	29	352	60	FLV3684DDST		\$4,572	\$5,029
	36	78	29	342	55	FLT3678DDST	\$3,255		
	36	78	29	342	55	FLV3678DDST		\$4,465	\$4,912
	36	72	29	331	51	FLT3672DDST	\$3,180		
	36	72	29	331	51	FLV3672DDST		\$4,360	\$4,796



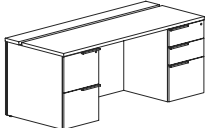

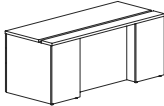
approach

Features:

- eased edge profile on approach and user sides
- built in horizontal wire channel
- pedestal front locking
- FLT3684DDST or FLV3684DDST - chassis 36" x 84"
- FLT3678DDST or FLV3678DDST - chassis 36" x 78"
- FLT3672DDST or FLV3672DDST - chassis 36" x 72"
- FLT3684DDST or FLV3684DDST - kneespace - 48"
- FLT3678DDST or FLV3678DDST - kneespace - 42"
- FLT3672DDST or FLV3672DDST - kneespace - 36"

Options:

- must specify chassis grain direction on double cut veneer, see pages 13-15 for details
- veneer drawer fronts in paint available, specify paint color; add \$337 list; see page 16 for details
- on laminate units, contrasting worksurface tops and drawer fronts available, no upcharge; specify color, see page 16 for details
- ledge pulls standard; prism pulls available, specify and see page 9
- pedestal access doors available, specify; add \$283 list for laminate or \$337 list for veneer; see page 17 for details

Description	D	W	H	CTN WT	CU FT	① Model	HPL Laminate	Flat Cut Veneer	Double Cut Veneer
Double Pedestal Desk with Break Front Modesty - Continuous Wire Channel - Split Top    <p>approach</p>	30	84	29	307	50	FLT3084DDST	\$3,203		
	30	84	29	307	50	FLV3084DDST		\$4,394	\$4,832
	30	78	29	297	47	FLT3078DDST	\$3,130		
	30	78	29	297	47	FLV3078DDST		\$4,290	\$4,721
	30	72	29	287	43	FLT3072DDST	\$3,058		
	30	72	29	287	43	FLV3072DDST		\$4,191	\$4,611
	30	66	29	278	40	FLT3066DDST	\$2,987		
	30	66	29	278	40	FLV3066DDST		\$4,094	\$4,505
	30	60	29	269	36	FLT3060DDST	\$2,920		
	30	60	29	269	36	FLV3060DDST		\$4,000	\$4,400

Features:

- eased edge profile on approach and user sides
- built in horizontal wire channel
- pedestal front locking
- FLT3084DDST or FLV3084DDST - chassis 30" x 84"
- FLT3078DDST or FLV3078DDST - chassis 30" x 78"
- FLT3072DDST or FLV3072DDST - chassis 30" x 72"
- FLT3066DDST or FLV3066DDST - chassis 30" x 66"
- FLT3060DDST or FLV3060DDST - chassis 30" x 60"
- FLT3084DDST or FLV3084DDST - kneespace - 48"
- FLT3078DDST or FLV3078DDST - kneespace - 42"
- FLT3072DDST or FLV3072DDST - kneespace - 36"
- FLT3066DDST or FLV3066DDST - kneespace 34 3/4"
- FLT3060DDST or FLV3060DDST - kneespace 28 3/4"

Options:

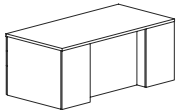
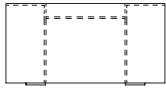
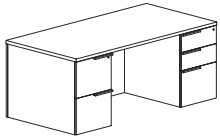
- must specify chassis grain direction on double cut veneer, see pages 13-15 for details
- veneer drawer fronts in paint available, specify paint color; add \$337 list; see page 16 for details
- on laminate units, contrasting worksurface tops and drawer fronts available, no upcharge; specify laminate color, see page 16 for details
- pedestal access doors available, specify; add \$283 list for laminate or \$337 list for veneer; see page 17 for details

To Order, Specify:

① Laminate Model #	② Laminate Type	③ Laminate Selection		④ Metal Color	⑤ Other Product Options
Laminate (FLT)	HPL	See Laminate Selection		See Metal Finish Color Options	See list of options for each specific unit; Specify and add accordingly.

① Veneer Model #	② Wood Species	③ Wood Finish		④ Metal Color	⑤ Other Product Options
Veneer (FLV)	Flat Cut CH1 Cherry MA1 Maple WA1 Walnut BO1 Black Oak	See Flat Cut Wood Finish Options		See Metal Finish Color Options	See list of options for each specific unit; Specify and add accordingly.
		ⓐ Wood Finish	ⓑ Chassis Grain Direction		
	Double Cut DC1 Double Cut	See Double Cut Wood Finish Options	For Double Cut Only: Vertical Horizontal		

Description	D	W	H	CTN WT	CU FT	① Model	HPL Laminate	Flat Cut Veneer	Double Cut Veneer
Double Pedestal Desk with Break Front Modesty	36	84	29	352	60	FLT3684DD	\$3,133		
	36	84	29	352	60	FLV3684DD		\$4,374	\$4,812
	36	78	29	342	55	FLT3678DD	\$3,058		
	36	78	29	342	55	FLV3678DD		\$4,268	\$4,696
	36	72	29	331	51	FLT3672DD	\$2,983		
	36	72	29	331	51	FLV3672DD		\$4,164	\$4,580



approach

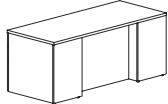
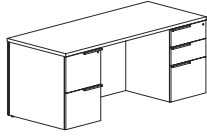
Features:

- eased edge profile on approach and user sides
- pedestal front locking
- FLT3684DD or FLV3684DD - chassis 36" x 84"
- FLT3678DD or FLV3678DD - chassis 36" x 78"
- FLT3672DD or FLV3672DD - chassis 36" x 72"
- FLT3684DD or FLV3684DD - kneespace 48"
- FLT3678DD or FLV3678DD - kneespace 42"
- FLT3672DD or FLV3672DD - kneespace 36"

Options:

- must specify chassis grain direction on double cut veneer, see pages 13-15 for details
- veneer drawer fronts in paint available, specify paint color; add \$337 list; see page 16 for details
- on laminate units, contrasting worksurface tops and drawer fronts available, no upcharge; specify color, see page 16 for details
- ledge pulls standard; prism pulls available, specify and see page 9
- top grommet available, specify location; add \$128 list each; see page 44 for details
- worksurface power available, specify "to accommodate EC26" on your purchase order; EC26 unit must be ordered separately, see page 44
- pedestal access door with wire manager available, use with top grommet, specify; add \$337 list for laminate or \$390 list for veneer; see page 17 for details
- interior kneespace wire manager available, use with top grommet or power unit, specify and add \$114 list; see page 17 for details

Description	D	W	H	CTN WT	CU FT	① Model	HPL Laminate	Flat Cut Veneer	Double Cut Veneer
Double Pedestal Desk with Break Front Modesty	30	84	29	307	50	FLT3084DD	\$3,007		
	30	84	29	307	50	FLV3084DD		\$4,196	\$4,616
	30	78	29	297	47	FLT3078DD	\$2,934		
	30	78	29	297	47	FLV3078DD		\$4,094	\$4,505
	30	72	29	287	43	FLT3072DD	\$2,862		
	30	72	29	287	43	FLV3072DD		\$3,995	\$4,395
	30	66	29	278	40	FLT3066DD	\$2,792		
	30	66	29	278	40	FLV3066DD		\$3,898	\$4,288
	30	60	29	269	36	FLT3060DD	\$2,723		
	30	60	29	269	36	FLV3060DD		\$3,804	\$4,184



approach

Features:

- eased edge profile on approach and user sides
- pedestal front locking
- FLT3084DD or FLV3084DD - chassis 30" x 84"
- FLT3078DD or FLV3078DD - chassis 30" x 78"
- FLT3072DD or FLV3072DD - chassis 30" x 72"
- FLT3066DD or FLV3066DD - chassis 30" x 60"
- FLT3060DD or FLV3060DD - chassis 30" x 60"
- FLT3084DD or FLV3084DD - kneespace 48"
- FLT3078DD or FLV3078DD - kneespace 42"
- FLT3072DD or FLV3072DD - kneespace 36"
- FLT3066DD or FLV3066DD - kneespace 34 3/4"
- FLT3060DD or FLV3060DD - kneespace 28 3/4"

Options:

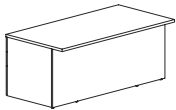
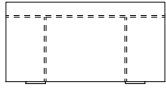
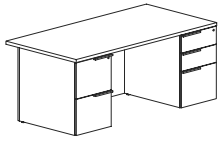
- must specify chassis grain direction on double cut veneer, see pages 13-15 for details
- veneer drawer fronts in paint available, specify paint color; add \$337 list; see page 16 for details
- on laminate units, contrasting worksurface tops and drawer fronts available, no upcharge; specify laminate color, see page 16 for details
- ledge pulls standard; prism pulls available, specify and see page 9
- top grommet available, specify location; add \$128 list each; see page 44 for details
- worksurface power available, specify "to accommodate EC26" on your purchase order; EC26 unit must be ordered separately, see page 44
- pedestal access door with wire manager available, use with top grommet, specify; add \$337 list for laminate or \$390 list for veneer; see page 17 for details

To Order, Specify:

① Laminate Model #	② Laminate Type	③ Laminate Selection		④ Metal Color	⑤ Other Product Options
Laminate (FLT)	HPL	See Laminate Selection		See Metal Finish Color Options	See list of options for each specific unit; Specify and add accordingly.

① Veneer Model #	② Wood Species	③ Wood Finish		④ Metal Color	⑤ Other Product Options
Veneer (FLV)	Flat Cut CH1 Cherry MA1 Maple WA1 Walnut BO1 Black Oak	See Flat Cut Wood Finish Options		See Metal Finish Color Options	See list of options for each specific unit; Specify and add accordingly.
		ⓐ Wood Finish	ⓑ Chassis Grain Direction		

Description	D	W	H	CTN WT	CU FT	① Model	HPL Laminate	Flat Cut Veneer	Double Cut Veneer
Double Pedestal Desk with Flush Modesty	36	84	29	333	60	FLT3684EDF	\$3,160		
	36	84	29	333	60	FLV3684EDF		\$4,141	\$4,555
	36	78	29	322	55	FLT3678EDF	\$3,083		
	36	78	29	322	55	FLV3678EDF		\$4,040	\$4,445
	36	72	29	312	51	FLT3672EDF	\$3,007		
	36	72	29	312	51	FLV3672EDF		\$3,941	\$4,334



approach

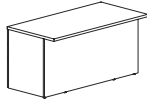
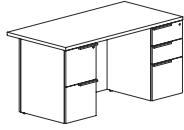
Features:

- eased edge profile on approach and user sides
- 6" overhang on approach side
- pedestal front locking
- FLT3684EDF or FLV3684EDF - chassis 30" x 84"
- FLT3678EDF or FLV3678EDF - chassis 30" x 78"
- FLT3672EDF or FLV3672EDF - chassis 30" x 72"
- FLT3684EDF or FLV3684EDF - kneespace 48"
- FLT3678EDF or FLV3678EDF - kneespace 42"
- FLT3672EDF or FLV3672EDF - kneespace 36"

Options:

- must specify chassis grain direction on double cut veneer, see pages 13-15 for details
- veneer drawer fronts in paint available, specify paint color; add \$337 list; see page 16 for details
- on laminate units, contrasting worksurface tops and drawer fronts available, no upcharge; specify laminate color, see page 16 for details
- ledge pulls standard; prism pulls available, specify and see page 9
- top grommet available, specify location; add \$128 list each; see page 44 for details
- worksurface power available, specify "to accommodate EC26" on your purchase order; EC26 unit must be ordered separately, see page 44
- interior kneespace wire manager available, use with top grommet or power unit, specify and add \$114 list; see page 17 for details

Description	D	W	H	CTN WT	CU FT	① Model	HPL Laminate	Flat Cut Veneer	Double Cut Veneer
Double Pedestal Desk with Flush Modesty	30	72	29	268	43	FLT3072EDF	\$2,722		
	30	72	29	268	43	FLV3072EDF		\$3,800	\$4,178
	30	66	29	261	40	FLT3066EDF	\$2,669		
	30	66	29	261	40	FLV3066EDF		\$3,723	\$4,096
	30	60	29	254	36	FLT3060EDF	\$2,614		
	30	60	29	254	36	FLV3060EDF		\$3,649	\$4,015



approach

Features:

- eased edge profile on approach and user sides
- 6" overhang on approach side
- pedestal front locking
- FLT3072EDF or FLV3072EDF - chassis 24" x 72"
- FLT3066EDF or FLV3066EDF - chassis 24" x 66"
- FLT3060EDF or FLV3060EDF - chassis 24" x 60"
- FLT3072EDF or FLV3072EDF - kneespace 36"
- FLT3066EDF or FLV3066EDF - kneespace 34 3/4"
- FLT3060EDF or FLV3060EDF - kneespace 28 3/4"

Options:

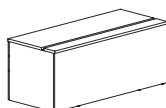
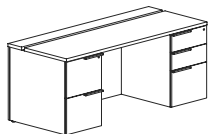
- must specify chassis grain direction on double cut veneer, see pages 13-15 for details
- veneer drawer fronts in paint available, specify paint color; add \$337 list; see page 16 for details
- on laminate units, contrasting worksurface tops and drawer fronts available, no upcharge; specify laminate color, see page 16 for details
- ledge pulls standard; prism pulls available, specify and see page 9
- top grommet available, specify location; add \$128 list each; see page 44 for details
- worksurface power available, specify "to accommodate EC26" on your purchase order; EC26 unit must be ordered separately, see page 44
- interior kneespace wire manager available, use with top grommet or power unit, specify and add \$114 list; see page 17 for details

To Order, Specify:

① Laminate Model #	② Laminate Type	③ Laminate Selection		④ Metal Color	⑤ Other Product Options
Laminate (FLT)	HPL	See Laminate Selection		See Metal Finish Color Options	See list of options for each specific unit; Specify and add accordingly.

① Veneer Model #	② Wood Species	③ Wood Finish		④ Metal Color	⑤ Other Product Options
Veneer (FLV)	Flat Cut CH1 Cherry MA1 Maple WA1 Walnut BO1 Black Oak	See Flat Cut Wood Finish Options		See Metal Finish Color Options	See list of options for each specific unit; Specify and add accordingly.
		③a Wood Finish	③b Chassis Grain Direction		

Description	D	W	H	CTN WT	CU FT	① Model	HPL Laminate	Flat Cut Veneer	Double Cut Veneer
Double Pedestal Desk with Flush Modesty - Continuous Wire Channel - Split Top	30	84	29	307	50	FLT3084DDSTF	\$3,109		
	30	84	29	307	50	FLV3084DDSTF		\$4,463	\$4,909
	30	78	29	297	47	FLT3078DDSTF	\$3,039		
	30	78	29	297	47	FLV3078DDSTF		\$4,259	\$4,685
	30	72	29	287	43	FLT3072DDSTF	\$2,968		
	30	72	29	287	43	FLV3072DDSTF		\$4,067	\$4,472
	30	66	29	278	40	FLT3066DDSTF	\$2,911		
	30	66	29	278	40	FLV3066DDSTF		\$3,988	\$4,390
	30	60	29	269	36	FLT3060DDSTF	\$2,859		
	30	60	29	269	36	FLV3060DDSTF		\$3,914	\$4,304



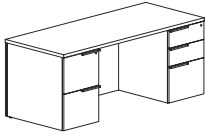
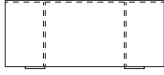
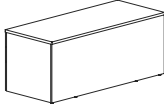
approach

Features:

- eased edge profile on approach and user sides
- built in horizontal wire channel
- pedestal front locking
- FLT3084DDSTF or FLV3084DDSTF - chassis 30" x 84"
- FLT3078DDSTF or FLV3078DDSTF - chassis 30" x 78"
- FLT3072DDSTF or FLV3072DDSTF - chassis 30" x 72"
- FLT3066DDSTF or FLV3066DDSTF - chassis 30" x 66"
- FLT3060DDSTF or FLV3060DDSTF - chassis 30" x 60"
- FLT3084DDSTF or FLV3084DDSTF - kneespace 48"
- FLT3078DDSTF or FLV3078DDSTF - kneespace 42"
- FLT3072DDSTF or FLV3072DDSTF - kneespace 36"
- FLT3066DDSTF or FLV3066DDSTF - kneespace 34 3/4"
- FLT3060DDSTF or FLV3060DDSTF - kneespace 28 3/4"

Options:

- must specify chassis grain direction on double cut veneer, see pages 13-15 for details
- veneer drawer fronts in paint available, specify paint color; add \$337 list; see page 16 for details
- on laminate units, contrasting worksurface tops and drawer fronts available, no upcharge; specify laminate color, see page 16 for details
- ledge pulls standard; prism pulls available, specify and see page 9

Description	D	W	H	CTN WT	CU FT	① Model	HPL Laminate	Flat Cut Veneer	Double Cut Veneer
   approach	30	84	29	307	50	FLT3084DDF	\$2,911		
	30	84	29	307	50	FLV3084DDF		\$4,266	\$4,693
	30	78	29	297	47	FLT3078DDF	\$2,841		
	30	78	29	297	47	FLV3078DDF		\$4,064	\$4,468
	30	72	29	287	43	FLT3072DDF	\$2,770		
	30	72	29	287	43	FLV3072DDF		\$3,869	\$4,255
	30	66	29	278	40	FLT3066DDF	\$2,716		
	30	66	29	278	40	FLV3066DDF		\$3,791	\$4,172
	30	60	29	269	36	FLT3060DDF	\$2,662		
	30	60	29	269	36	FLV3060DDF		\$3,717	\$4,089

Features:

- eased edge profile on approach and user sides
- pedestal front locking
- FLT3084DDF or FLV3084DDF - chassis 30" x 84"
- FLT3078DDF or FLV3078DDF - chassis 30" x 78"
- FLT3072DDF or FLV3072DDF - chassis 30" x 72"
- FLT3066DDF or FLV3066DDF - chassis 30" x 60"
- FLT3060DDF or FLV3060DDF - chassis 30" x 60"
- FLT3084DDF or FLV3084DDF - kneespace 48"
- FLT3078DDF or FLV3078DDF - kneespace 42"
- FLT3072DDF or FLV3072DDF - kneespace 36"
- FLT3066DDF or FLV3066DDF - kneespace 34 3/4"
- FLT3060DDF or FLV3060DDF - kneespace 28 3/4"

Options:

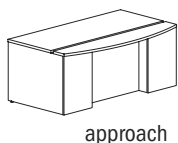
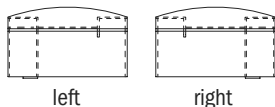
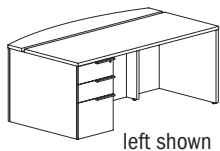
- must specify chassis grain direction on double cut veneer, see pages 13-15 for details
- veneer drawer fronts in paint available, specify paint color; add \$337 list; see page 16 for details
- on laminate units, contrasting worksurface tops and drawer fronts available, no upcharge; specify laminate color, see page 16 for details
- ledge pulls standard; prism pulls available, specify and see page 9
- top grommet available, specify location; add \$128 list each; see page 44 for details
- worksurface power available, specify "to accommodate EC26" on your purchase order; EC26 unit must be ordered separately, see page 44

To Order, Specify:

① Laminate Model #	② Laminate Type	③ Laminate Selection		④ Metal Color	⑤ Other Product Options
Laminate (FLT)	HPL	See Laminate Selection		See Metal Finish Color Options	See list of options for each specific unit; Specify and add accordingly.

① Veneer Model #	② Wood Species	③ Wood Finish		④ Metal Color	⑤ Other Product Options
Veneer (FLV)	Flat Cut CH1 Cherry MA1 Maple WA1 Walnut BO1 Black Oak	See Flat Cut Wood Finish Options		See Metal Finish Color Options	See list of options for each specific unit; Specify and add accordingly.
		ⓐ Wood Finish	ⓑ Chassis Grain Direction		

Description	D	W	H	CTN WT	CU FT	① Model	HPL Laminate	Flat Cut Veneer	Double Cut Veneer
Bow Front Single Pedestal Desk with Break Front Modesty Continuous Wire Channel - Split Top	42	84	29	318	69	FLT4284RBDST	\$3,097		
	42	84	29	318	69	FLV4284RBDST		\$4,166	\$4,582
	42	84	29	318	69	FLT4284LBDST	\$3,097		
	42	84	29	318	69	FLV4284LBDST		\$4,166	\$4,582
	42	78	29	307	64	FLT4278RBDST	\$3,030		
	42	78	29	307	64	FLV4278RBDST		\$4,074	\$4,482
	42	78	29	307	64	FLT4278LBDST	\$3,030		
	42	78	29	307	64	FLV4278LBDST		\$4,074	\$4,482
	42	72	29	296	59	FLT4272RBDST	\$2,968		
	42	72	29	296	59	FLV4272RBDST		\$3,985	\$4,381
	42	72	29	296	59	FLT4272LBDST	\$2,968		
	42	72	29	296	59	FLV4272LBDST		\$3,985	\$4,381



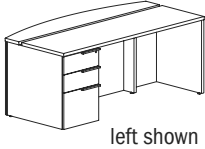
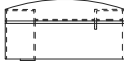
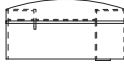
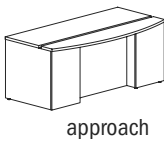
Features:

- eased edge profile on approach and user sides
- built in horizontal wire channel
- 6" overhang on approach side
- pedestal front locking
- FLT4284RBDST or FLT4284LBDST and FLV4284RBDST or FLV4284LBDST - chassis 36" x 84"
- FLT4278RBDST or FLT4278LBDST and FLV4278RBDST or FLV4278LBDST - chassis 36" x 78"
- FLT4272RBDST or FLT4272LBDST and FLV4272RBDST or FLV4272LBDST - chassis 36" x 72"

Options:

- must specify chassis grain direction on double cut veneer, see pages 13-15 for details
- veneer drawer fronts in paint available, specify paint color; add \$337 list; see page 16 for details
- on laminate units, contrasting worksurface tops and drawer fronts available, no upcharge; specify color, see page 16 for details
- ledge pulls standard; prism pulls available, specify and see page 9
- pedestal access doors available, specify; add \$283 list for laminate or \$337 list for veneer; see page 17 for details

FLUX - PRIVATE OFFICE

Description	D	W	H	CTN WT	CU FT	① Model	HPL Laminate	Flat Cut Veneer	Double Cut Veneer
Bow Front Single Pedestal Desk with Break Front Modesty Continuous Wire Channel - Split Top	36	84	29	285	60	FLT3684RBDST	\$2,950		
	36	84	29	285	60	FLV3684RBDST		\$4,040	\$4,445
	36	84	29	285	60	FLT3684LBDST	\$2,950		
	36	84	29	285	60	FLV3684LBDST		\$4,040	\$4,445
 	36	78	29	276	55	FLT3678RBDST	\$2,882		
	36	78	29	276	55	FLV3678RBDST		\$3,948	\$4,340
	36	78	29	276	55	FLT3678LBDST	\$2,882		
	36	78	29	276	55	FLV3678LBDST		\$3,948	\$4,340
	36	72	29	267	51	FLT3672RBDST	\$2,819		
	36	72	29	267	51	FLV3672RBDST		\$3,854	\$4,241
	36	72	29	267	51	FLT3672LBDST	\$2,819		
	36	72	29	267	51	FLV3672LBDST		\$3,854	\$4,241
	36	66	29	258	47	FLT3666RBDST	\$2,755		
	36	66	29	258	47	FLV3666RBDST		\$3,767	\$4,144
	36	66	29	258	47	FLT3666LBDST	\$2,755		
	36	66	29	258	47	FLV3666LBDST		\$3,767	\$4,144
	36	60	29	249	43	FLT3660RBDST	\$2,691		
	36	60	29	249	43	FLV3660RBDST		\$3,680	\$4,048
	36	60	29	249	43	FLT3660LBDST	\$2,691		
	36	60	29	249	43	FLV3660LBDST		\$3,680	\$4,048

Features:

- eased edge profile on approach and user sides
- built in horizontal wire channel
- 6" overhang on approach side
- pedestal front locking
- FLT3684RBDST or FLT3684LBDST and FLV3684RBDST or FLV3684LBDST - chassis 30" x 84"
- FLT3678RBDST or FLT3678LBDST and FLV3678RBDST or FLV3678LBDST - chassis 30" x 78"
- FLT3672RBDST or FLT3672LBDST and FLV3672RBDST or FLV3672LBDST - chassis 30" x 72"
- FLT3666RBDST or FLT3666LBDST and FLV3666RBDST or FLV3666LBDST - chassis 30" x 66"
- FLT3660RBDST or FLT3660LBDST and FLV3660RBDST or FLV3660LBDST - chassis 30" x 60"

Options:

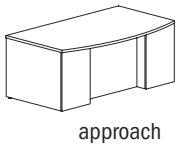
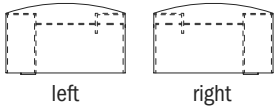
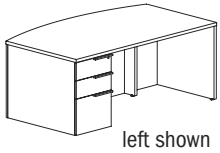
- must specify chassis grain direction on double cut veneer, see pages 13-15 for details
- veneer drawer fronts in paint available, specify paint color; add \$337 list; see page 16 for details
- on laminate units, contrasting worksurface tops and drawer fronts available, no upcharge; specify laminate color, see page 16 for details
- ledge pulls standard; prism pulls available, specify and see page 9
- pedestal access doors available, specify; add \$283 list for laminate or \$337 list for veneer; see page 17 for details

To Order, Specify:

① Laminate Model #	② Laminate Type	③ Laminate Selection		④ Metal Color	⑤ Other Product Options
Laminate (FLT)	HPL	See Laminate Selection		See Metal Finish Color Options	See list of options for each specific unit; Specify and add accordingly.

① Veneer Model #	② Wood Species	③ Wood Finish		④ Metal Color	⑤ Other Product Options
Veneer (FLV)	Flat Cut CH1 Cherry MA1 Maple WA1 Walnut BO1 Black Oak	See Flat Cut Wood Finish Options		See Metal Finish Color Options	See list of options for each specific unit; Specify and add accordingly.
	Double Cut DC1 Double Cut	ⓐ Wood Finish See Double Cut Wood Finish Options	ⓑ Chassis Grain Direction For Double Cut Only: Vertical Horizontal		

Description	D	W	H	CTN WT	CU FT	① Model	HPL Laminate	Flat Cut Veneer	Double Cut Veneer
Bow Front Single Pedestal Desk with Break Front Modesty	42	84	29	318	69	FLT4284RBD	\$2,901		
	42	84	29	318	69	FLV4284RBD		\$3,968	\$4,365
	42	84	29	318	69	FLT4284LBD	\$2,901		
	42	84	29	318	69	FLV4284LBD		\$3,968	\$4,365
	42	78	29	307	64	FLT4278RBD	\$2,836		
	42	78	29	307	64	FLV4278RBD		\$3,878	\$4,266
	42	78	29	307	64	FLT4278LBD	\$2,836		
	42	78	29	307	64	FLV4278LBD		\$3,878	\$4,266
	42	72	29	296	59	FLT4272RBD	\$2,770		
	42	72	29	296	59	FLV4272RBD		\$3,788	\$4,166
	42	72	29	296	59	FLT4272LBD	\$2,770		
	42	72	29	296	59	FLV4272LBD		\$3,788	\$4,166

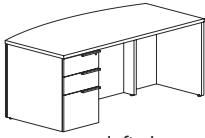
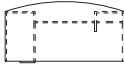
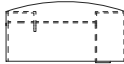
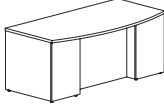


Features:

- eased edge profile on approach and user sides
- 6" overhang on approach side
- pedestal front locking
- FLT4284RBD or FLT4284LBD and FLV4284RBD or FLV4284LBD - chassis 36" x 84"
- FLT4278RBD or FLT4278LBD and FLV4278RBD or FLV4278LBD - chassis 36" x 78"
- FLT4272RBD or FLT4272LBD and FLV4272RBD or FLV4272LBD - chassis 36" x 72"

Options:

- must specify chassis grain direction on double cut veneer, see pages 13-15 for details
- veneer drawer fronts in paint available, specify paint color and add \$337 list; see page 16 for details
- on laminate units, contrasting worksurface tops and drawer fronts available, no upcharge; specify laminate color, see page 16 for details
- ledge pulls standard; prism pulls available, specify and see page 9
- top grommet available, specify location; add \$128 list each; see page 44 for details
- worksurface power available, specify "to accommodate EC26" on your purchase order; EC26 unit must be ordered separately, see page 44
- pedestal access door with wire manager available, use with top grommet, specify; add \$337 list for laminate or \$390 list for veneer; see page 17 for details
- interior kneespace wire manager available, use with top grommet or power unit, specify and add \$114 list; see page 17 for details

Description	D	W	H	CTN WT	CU FT	① Model	HPL Laminate	Flat Cut Veneer	Double Cut Veneer
Bow Front Single Pedestal Desk with Break Front Modesty	36	84	29	285	60	FLT3684RBD	\$2,755		
	36	84	29	285	60	FLV3684RBD		\$3,844	\$4,228
	36	84	29	285	60	FLT3684LBD	\$2,755		
	36	84	29	285	60	FLV3684LBD		\$3,844	\$4,228
 	36	78	29	276	55	FLT3678RBD	\$2,687		
	36	78	29	276	55	FLV3678RBD		\$3,751	\$4,125
	36	78	29	276	55	FLT3678LBD	\$2,687		
	36	78	29	276	55	FLV3678LBD		\$3,751	\$4,125
	36	72	29	267	51	FLT3672RBD	\$2,621		
	36	72	29	267	51	FLV3672RBD		\$3,659	\$4,026
	36	72	29	267	51	FLT3672LBD	\$2,621		
	36	72	29	267	51	FLV3672LBD		\$3,659	\$4,026
	36	66	29	258	47	FLT3666RBD	\$2,559		
	36	66	29	258	47	FLV3666RBD		\$3,571	\$3,926
	36	66	29	258	47	FLT3666LBD	\$2,559		
	36	66	29	258	47	FLV3666LBD		\$3,571	\$3,926
	36	60	29	249	43	FLT3660RBD	\$2,495		
	36	60	29	249	43	FLV3660RBD		\$3,482	\$3,832
	36	60	29	249	43	FLT3660LBD	\$2,495		
	36	60	29	249	43	FLV3660LBD		\$3,482	\$3,832

Features:

- eased edge profile on approach and user sides
- 6" overhang on approach side
- pedestal front locking
- FLT3684RBD or FLT3684LBD and FLV3684RBD or FLV3684LBD - chassis 30" x 84"
- FLT3678RBD or FLT3678LBD and FLV3678RBD or FLV3678LBD - chassis 30" x 78"
- FLT3672RBD or FLT3672LBD and FLV3672RBD or FLV3672LBD - chassis 30" x 72"
- FLT3666RBD or FLT3666LBD and FLV3666RBD or FLV3666LBD - chassis 30" x 66"
- FLT3660RBD or FLT3660LBD and FLV3660RBD or FLV3660LBD - chassis 30" x 60"

Options:

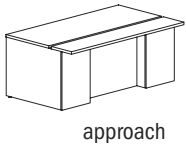
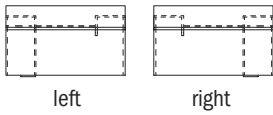
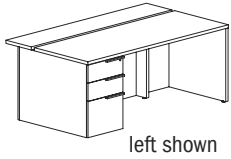
- must specify chassis grain direction on double cut veneer, see pages 13-15 for details
- veneer drawer fronts in paint available, specify paint color; add \$337 list; see page 16 for details
- on laminate units, contrasting worksurface tops and drawer fronts available, no upcharge; specify laminate color, see page 16 for details
- ledge pulls standard; prism pulls available, specify and see page 9
- top grommet available, specify location; add \$128 list each; see page 44 for details
- worksurface power available, specify "to accommodate EC26" on your purchase order; EC26 unit must be ordered separately, see page 44
- pedestal access door with wire manager available, use with top grommet, specify; add \$337 list for laminate or \$390 list for veneer; see page 17 for details
- interior kneespace wire manager available, use with top grommet or power unit, specify and add \$114 list; see page 17 for details

To Order, Specify:

① Laminate Model #	② Laminate Type	③ Laminate Selection	④ Metal Color	⑤ Other Product Options
Laminate (FLT)	TFL	See Laminate Selection	See Metal Finish Color Options	See list of options for each specific unit; Specify and add accordingly.
	HPL			
	HLP			

① Veneer Model #	② Wood Species	③ Wood Finish	④ Metal Color	⑤ Other Product Options	
Veneer (FLV)	Flat Cut CH1 Cherry MA1 Maple WA1 Walnut BO1 Black Oak	See Flat Cut Wood Finish Options	See Metal Finish Color Options	See list of options for each specific unit; Specify and add accordingly.	
	Double Cut BC1 Double Cut	<table border="1"> <tr> <th>③a Wood Finish</th> <th>③b Chassis Grain Direction</th> </tr> <tr> <td>See Double Cut Wood Finish Options</td> <td>For Double Cut Only: Vertical Horizontal</td> </tr> </table>			③a Wood Finish
③a Wood Finish	③b Chassis Grain Direction				
See Double Cut Wood Finish Options	For Double Cut Only: Vertical Horizontal				

Description	D	W	H	CTN WT	CU FT	① Model	HPL Laminate	Flat Cut Veneer	Double Cut Veneer
Single Pedestal Desk with Break	42	84	29	325	69	FLT4284REDST	\$2,893		
Front Modesty - Continuous Wire Channel - Split Top	42	84	29	325	69	FLV4284REDST		\$3,960	\$4,357
	42	84	29	325	69	FLT4284LEDST	\$2,893		
	42	84	29	325	69	FLV4284LEDST		\$3,960	\$4,357
	42	78	29	314	64	FLT4278REDST	\$2,827		
	42	78	29	314	64	FLV4278REDST		\$3,869	\$4,255
	42	78	29	314	64	FLT4278LEDST	\$2,827		
	42	78	29	314	64	FLV4278LEDST		\$3,869	\$4,255
	42	72	29	303	59	FLT4272REDST	\$2,762		
	42	72	29	303	59	FLV4272REDST		\$3,779	\$4,156
	42	72	29	303	59	FLT4272LEDST	\$2,762		
	42	72	29	303	59	FLV4272LEDST		\$3,779	\$4,156



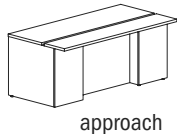
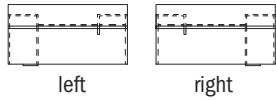
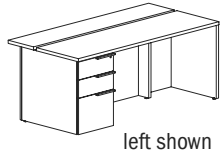
Features:

- eased edge profile on approach and user sides
- built in horizontal wire channel
- 6" overhang on approach side
- pedestal front locking
- FLT4284REDST or FLT4284LEDST and FLV4284REDST or FLV4284LEDST - chassis 36" x 84"
- FLT4278REDST or FLT4278LEDST and FLV4278REDST or FLV4278LEDST - chassis 36" x 78"
- FLT4272REDST or FLT4272LEDST and FLV4272REDST or FLV4272LEDST - chassis 36" x 72"

Options:

- must specify chassis grain direction on double cut veneer, see pages 13-15 for details
- veneer drawer fronts in paint available, specify paint color; add \$337 list; see page 16 for details
- on laminate units, contrasting worksurface tops and drawer fronts available, no upcharge; specify laminate color, see page 16 for details
- ledge pulls standard; prism pulls available, specify and see page 9
- pedestal access doors available, specify; add \$283 list for laminate or \$337 list for veneer; see page 17 for details

Description	D	W	H	CTN WT	CU FT	① Model	HPL Laminate	Flat Cut Veneer	Double Cut Veneer
Single Pedestal Desk with Break Front Modesty -Continuous Wire Channel - Split Top	36	84	29	289	60	FLT3684REDST	\$2,764		
	36	84	29	289	60	FLV3684REDST		\$3,781	\$4,160
	36	84	29	289	60	FLT3684LEDST	\$2,764		
	36	84	29	289	60	FLV3684LEDST		\$3,781	\$4,160
	36	78	29	280	55	FLT3678REDST	\$2,701		
	36	78	29	280	55	FLV3678REDST		\$3,696	\$4,065
	36	78	29	280	55	FLT3678LEDST	\$2,701		
	36	78	29	280	55	FLV3678LEDST		\$3,696	\$4,065
	36	72	29	271	51	FLT3672REDST	\$2,641		
	36	72	29	271	51	FLV3672REDST		\$3,607	\$3,968
	36	72	29	271	51	FLT3672LEDST	\$2,641		
	36	72	29	271	51	FLV3672LEDST		\$3,607	\$3,968
	36	66	29	264	47	FLT3666REDST	\$2,592		
	36	66	29	264	47	FLV3666REDST		\$3,540	\$3,893
	36	66	29	264	47	FLT3666LEDST	\$2,592		
	36	66	29	264	47	FLV3666LEDST		\$3,540	\$3,893
	36	60	29	255	43	FLT3660REDST	\$2,544		
	36	60	29	255	43	FLV3660REDST		\$3,474	\$3,822
	36	60	29	255	43	FLT3660LEDST	\$2,544		
	36	60	29	255	43	FLV3660LEDST		\$3,474	\$3,822



Features:

- eased edge profile on approach and user sides
- built in horizontal wire channel
- 6" overhang on approach side
- pedestal front locking
- FLT3684REDST or FLT3684LEDST and FLV3684REDST or FLV3684LEDST - chassis 30" x 84"
- FLT3678REDST or FLT3678LEDST and FLV3678REDST or FLV3678LEDST - chassis 30" x 78"
- FLT3672REDST or FLT3672LEDST and FLV3672REDST or FLV3672LEDST - chassis 30" x 72"
- FLT3666REDST or FLT3666LEDST and FLV3666REDST or FLV3666LEDST - chassis 30" x 66"
- FLT3660REDST or FLT3660LEDST and FLV3660REDST or FLV3660LEDST - chassis 30" x 60"

Options:

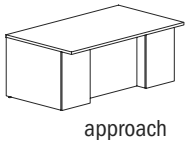
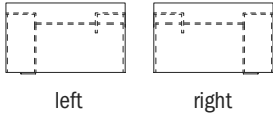
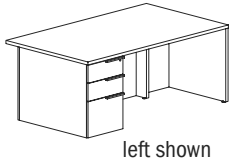
- must specify chassis grain direction on double cut veneer, see pages 13-15 for details
- veneer drawer fronts in paint available, specify paint color; add \$337 list; see page 16 for details
- on laminate units, contrasting worksurface tops and drawer fronts available, no upcharge; specify laminate color, see page 16 for details
- ledge pulls standard; prism pulls available, specify and see page 9
- pedestal access doors available, specify; add \$283 list for laminate or \$337 list for veneer; see page 17 for details

To Order, Specify:

① Laminate Model #	② Laminate Type	③ Laminate Selection	④ Metal Color	⑤ Other Product Options
Laminate (FLT)	HPL	See Laminate Selection	See Metal Finish Color Options	See list of options for each specific unit; Specify and add accordingly.

① Veneer Model #	② Wood Species	③ Wood Finish	④ Metal Color	⑤ Other Product Options
Veneer (FLV)	Flat Cut CH1 Cherry MA1 Maple WA1 Walnut BO1 Black Oak	See Flat Cut Wood Finish Options	See Metal Finish Color Options	See list of options for each specific unit; Specify and add accordingly.
	Double Cut DC1 Double Cut	③a Wood Finish See Double Cut Wood Finish Options ③b Chassis Grain Direction For Double Cut Only: Vertical Horizontal		

Description	D	W	H	CTN WT	CU FT	① Model	HPL Laminate	Flat Cut Veneer	Double Cut Veneer
Single Pedestal Desk with Break Front Modesty	42	84	29	325	69	FLT4284RED	\$2,695		
	42	84	29	325	69	FLV4284RED		\$3,764	\$4,140
	42	84	29	325	69	FLT4284LED	\$2,695		
	42	84	29	325	69	FLV4284LED		\$3,764	\$4,140
	42	78	29	314	64	FLT4278RED	\$2,632		
	42	78	29	314	64	FLV4278RED		\$3,671	\$4,038
	42	78	29	314	64	FLT4278LED	\$2,632		
	42	78	29	314	64	FLV4278LED		\$3,671	\$4,038
	42	72	29	303	59	FLT4272RED	\$2,567		
	42	72	29	303	59	FLV4272RED		\$3,583	\$3,941
	42	72	29	303	59	FLT4272LED	\$2,567		
	42	72	29	303	59	FLV4272LED		\$3,583	\$3,941



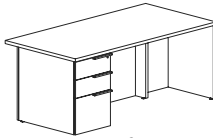

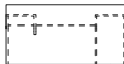
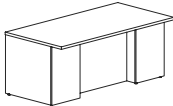
Features:

- eased edge profile on approach and user sides
- 6" overhang on approach side
- pedestal front locking
- FLT4284RED or FLT4284LED and FLV4284RED or FLV4284LED - chassis 36" X 84"
- FLT4278RED or FLT4278LED and FLV4278RED or FLV4278LED - chassis 36" X 78"
- FLT4272RED or FLT4272LED and FLV4272RED or FLV4272LED - chassis 36" X 72"

Options:

- must specify chassis grain direction on double cut veneer, see pages 13-15 for details
- veneer drawer fronts in paint available, specify paint color and add \$337 list; see page 16 for details
- on laminate units, contrasting worksurface tops and drawer fronts available, no upcharge; specify laminate color, see page 16 for details
- ledge pulls standard; prism pulls available, specify and see page 9
- top grommet available, specify location; add \$128 list each; see page 44 for details
- worksurface power available, specify "to accommodate EC26" on your purchase order; EC26 unit must be ordered separately, see page 44
- pedestal access door with wire manager available, use with top grommet, specify; add \$337 list for laminate or \$390 list for veneer; see page 17 for details
- interior kneespace wire manager available, use with top grommet or power unit, specify and add \$114 list; see page 17 for details

FLUX - PRIVATE OFFICE

Description	D	W	H	CTN WT	CU FT	① Model	HPL Laminate	Flat Cut Veneer	Double Cut Veneer
Single Pedestal Desk with Break Front Modesty	36	84	29	289	60	FLT3684RED	\$2,568		
	36	84	29	289	60	FLV3684RED		\$3,585	\$3,944
 left shown	36	84	29	289	60	FLT3684LED	\$2,568		
	36	84	29	289	60	FLV3684LED		\$3,585	\$3,944
 left	36	78	29	280	55	FLT3678RED	\$2,504		
	36	78	29	280	55	FLV3678RED		\$3,499	\$3,847
 right	36	78	29	280	55	FLT3678LED	\$2,504		
	36	78	29	280	55	FLV3678LED		\$3,499	\$3,847
 approach	36	72	29	271	51	FLT3672RED	\$2,444		
	36	72	29	271	51	FLV3672RED		\$3,412	\$3,753
	36	72	29	271	51	FLT3672LED	\$2,444		
	36	72	29	271	51	FLV3672LED		\$3,412	\$3,753
	36	66	29	264	47	FLT3666RED	\$2,395		
	36	66	29	264	47	FLV3666RED		\$3,344	\$3,678
	36	66	29	264	47	FLT3666LED	\$2,395		
	36	66	29	264	47	FLV3666LED		\$3,344	\$3,678
	36	60	29	255	43	FLT3660RED	\$2,348		
	36	60	29	255	43	FLV3660RED		\$3,277	\$3,605
	36	60	29	255	43	FLT3660LED	\$2,348		
	36	60	29	255	43	FLV3660LED		\$3,277	\$3,605

Features:

- eased edge profile on approach and user sides
- 6" overhang on approach side
- pedestal locking
- FLT3684RED or FLT3684LED and FLV3684RED or FLV3684LED - chassis 30" x 84"
- FLT3678RED or FLT3678LED and FLV3678RED or FLV3678LED - chassis 30" x 78"
- FLT3672RED or FLT3672LED and FLV3672RED or FLV3672LED - chassis 30" x 72"
- FLV3666RED or FLV3666LED and FLT3666RED or FLT3666LED - chassis 30" x 66"
- FLT3660RED or FLT3660LED and FLV3660RED or FLV3660LED - chassis 30" x 60"

Options:

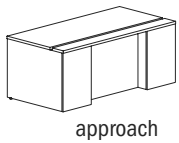
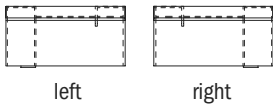
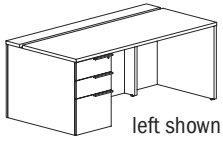
- must specify chassis grain direction on double cut veneer, see pages 13-15 for details
- veneer drawer fronts in paint available, specify paint color; add \$337 list; see page 16 for details
- on laminate units, contrasting worksurface tops and drawer fronts available, no upcharge; specify laminate color, see page 16 for details
- ledge pulls standard; prism pulls available, specify and see page 9
- top grommet available, specify location; add \$128 list each; see page 44 for details
- worksurface power available, specify "to accommodate EC26" on your purchase order; EC26 unit must be ordered separately, see page 44
- pedestal access door with wire manager available, use with top grommet, specify; add \$337 list for laminate or \$390 list for veneer; see page 17 for details
- interior kneespace wire manager available, use with top grommet or power unit, specify and add \$114 list; see page 17 for details

To Order, Specify:

① Laminate Model #	② Laminate Type	③ Laminate Selection	④ Metal Color	⑤ Other Product Options
Laminate (FLT)	TFL	See Laminate Selection	See Metal Finish Color Options	See list of options for each specific unit; specify and add accordingly.
	HPL			
	HLP			

① Veneer Model #	② Wood Species	③ Wood Finish - Finishes with an asterisk (*) have a coordinating laminate available	④ Metal Color	⑤ Other Product Options	
Veneer (FLV)	Flat Cut CH1 Cherry MA1 Maple WA1 Walnut BO1 Black Oak	See Flat Cut Wood Finish Options	See Metal Finish Color Options	See list of options for each specific unit; specify and add accordingly.	
	Double Cut DC1 Double Cut	<table border="1"> <thead> <tr> <th>ⓐ Wood Finish</th> <th>ⓑ Chassis Grain Direction</th> </tr> </thead> <tbody> <tr> <td>See Double Cut Wood Finish Options</td> <td>For Double Cut Only: Vertical Horizontal</td> </tr> </tbody> </table>			ⓐ Wood Finish
ⓐ Wood Finish	ⓑ Chassis Grain Direction				
See Double Cut Wood Finish Options	For Double Cut Only: Vertical Horizontal				

Description	D	W	H	CTN WT	CU FT	① Model	HPL Laminate	Flat Cut Veneer	Double Cut Veneer
Single Pedestal Desk with Break	36	84	29	306	60	FLT3684RDST	\$2,828		
Front Modesty - Continuous Wire Channel - Split Top	36	84	29	306	60	FLV3684RDST		\$3,871	\$4,258
	36	84	29	306	60	FLT3684LDST	\$2,828		
	36	84	29	306	60	FLV3684LDST		\$3,871	\$4,258
	36	78	29	295	55	FLT3678RDST	\$2,764		
	36	78	29	295	55	FLV3678RDST		\$3,781	\$4,160
	36	78	29	295	55	FLT3678LDST	\$2,764		
	36	78	29	295	55	FLV3678LDST		\$3,781	\$4,160
	36	72	29	284	51	FLT3672RDST	\$2,752		
	36	72	29	284	51	FLV3672RDST		\$3,695	\$4,064
	36	72	29	284	51	FLT3672LDST	\$2,752		
	36	72	29	284	51	FLV3672LDST		\$3,695	\$4,064

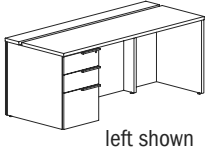
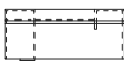
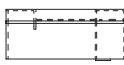
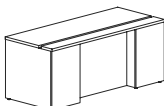


Features:

- eased edge profile on approach and user sides
- built in horizontal wire channel
- pedestal front locking
- FLT3684RDST or FLT3684LDST and FLV3684RDST or FLV3684LDST - chassis 36" x 84"
- FLT3678RDST or FLT3678LDST and FLV3678RDST or FLV3678LDST - chassis 36" x 78"
- FLT3672RDST or FLT3672LDST and FLV3672RDST or FLV3672LDST - chassis 36" x 72"

Options:

- must specify chassis grain direction on double cut veneer, see pages 13-15 for details
- veneer drawer fronts in paint available, specify paint color and add \$337 list; see page 16 for details
- on laminate units, contrasting worksurface tops and drawer fronts available, no upcharge; specify laminate color, see page 16 for details
- ledge pulls standard; prism pulls available, specify and see page 9
- pedestal access doors available, specify; add \$283 list for laminate or \$337 list for veneer; see page 17 for details

Description	D	W	H	CTN WT	CU FT	1 Model	HPL Laminate	Flat Cut Veneer	Double Cut Veneer
Single Pedestal Desk with Break Front Modesty -Continuous Wire Channel - Split Top  left shown  left  right  approach	30	84	29	272	50	FLT3084RDST	\$2,730		
	30	84	29	272	50	FLV3084RDST		\$3,733	\$4,107
	30	84	29	272	50	FLT3084LDST	\$2,730		
	30	84	29	272	50	FLV3084LDST		\$3,733	\$4,107
	30	78	29	264	47	FLT3078RDST	\$2,671		
	30	78	29	264	47	FLV3078RDST		\$3,647	\$4,012
	30	78	29	264	47	FLT3078LDST	\$2,671		
	30	78	29	264	47	FLV3078LDST		\$3,647	\$4,012
	30	72	29	256	43	FLT3072RDST	\$2,609		
	30	72	29	256	43	FLV3072RDST		\$3,564	\$3,919
	30	72	29	256	43	FLT3072LDST	\$2,609		
	30	72	29	256	43	FLV3072LDST		\$3,564	\$3,919
	30	66	29	248	40	FLT3066RDST	\$2,550		
	30	66	29	248	40	FLV3066RDST		\$3,481	\$3,831
	30	66	29	248	40	FLT3066LDST	\$2,550		
	30	66	29	248	40	FLV3066LDST		\$3,481	\$3,831
	30	60	29	240	36	FLT3060RDST	\$2,494		
	30	60	29	240	36	FLV3060RDST		\$3,401	\$3,743
30	60	29	240	36	FLT3060LDST	\$2,494			
30	60	29	240	36	FLV3060LDST		\$3,401	\$3,743	

Features:

- eased edge profile on approach and user sides
- built in horizontal wire channel
- pedestal front locking
- FLT3084RDST or FLT3084LDST and FLV3084RDST or FLV3084LDST - chassis 30" x 84"
- FLT3078RDST or FLT3078LDST and FLV3078RDST or FLV3078LDST - chassis 30" x 78"
- FLT3072RDST or FLT3072LDST and FLV3072RDST or FLV3072LDST - chassis 30" x 72"
- FLT3066RDST or FLT3066LDST and FLV3066RDST or FLV3066LDST - chassis 30" x 66"
- FLT3060RDST or FLT3060LDST and FLV3060RDST or FLV3060LDST - chassis 30" x 60"

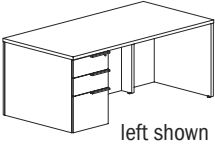

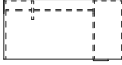
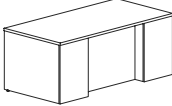
Options:

- must specify chassis grain direction on double cut veneer, see pages 13-15 for details
- veneer drawer fronts in paint available, specify paint color; add \$337 list; see page 16 for details
- on laminate units, contrasting worksurface tops and drawer fronts available, no upcharge; specify laminate color, see page 16 for details
- ledge pulls standard; prism pulls available, specify and see page 9
- pedestal access doors available, specify; add \$283 list for laminate or \$337 list for veneer; see page 17 for details

To Order, Specify:

1 Laminate Model #	2 Laminate Type	3 Laminate Selection		4 Metal Color	5 Other Product Options
Laminate (FLT)	HPL	See Laminate Selection		See Metal Finish Color Options	See list of options for each specific unit; Specify and add accordingly.

1 Veneer Model #	2 Wood Species	3 Wood Finish		4 Metal Color	5 Other Product Options
Veneer (FLV)	Flat Cut CH1 Cherry MA1 Maple WA1 Walnut BO1 Black Oak	See Flat Cut Wood Finish Options		See Metal Finish Color Options	See list of options for each specific unit; Specify and add accordingly.
		3a Wood Finish	3b Chassis Grain Direction		
	Double Cut DC1 Double Cut	See Double Cut Wood Finish Options	For Double Cut Only: Vertical Horizontal		

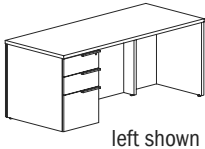
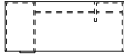

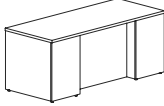
Description	D	W	H	CTN WT	CU FT	① Model	HPL Laminate	Flat Cut Veneer	Double Cut Veneer
   	36	84	29	306	60	FLT3684RD	\$2,633		
	36	84	29	306	60	FLV3684RD		\$3,674	\$4,041
	36	84	29	306	60	FLT3684LD	\$2,633		
	36	84	29	306	60	FLV3684LD		\$3,674	\$4,041
	36	78	29	295	55	FLT3678RD	\$2,568		
	36	78	29	295	55	FLV3678RD		\$3,585	\$3,944
	36	78	29	295	55	FLT3678LD	\$2,568		
	36	78	29	295	55	FLV3678LD		\$3,585	\$3,944
	36	72	29	284	51	FLT3672RD	\$2,554		
	36	72	29	284	51	FLV3672RD		\$3,498	\$3,846
	36	72	29	284	51	FLT3672LD	\$2,554		
	36	72	29	284	51	FLV3672LD		\$3,498	\$3,846

Features:

- eased edge profile on approach and user sides
- pedestal front locking
- FLT3684RD or FLT3684LD and FLV3684RD or FLV3684LD - chassis 36" x 84"
- FLT3678RD or FLT3678LD and FLV3678RD or FLV3678LD - chassis 36" x 78"
- FLT3672RD or FLT3672LD and FLV3672RD or FLV3672LD - chassis 36" x 72"

Options:

- must specify chassis grain direction on double cut veneer, see pages 13-15 for details
- veneer drawer fronts in paint available, specify paint color and add \$337 list; see page 16 for details
- on laminate units, contrasting worksurface tops and drawer fronts available, no upcharge; specify laminate color, see page 16 for details
- ledge pulls standard; prism pulls available, specify and see page 9
- top grommet available, specify location; add \$128 list each; see page 44 for details
- worksurface power available, specify "to accommodate EC26" on your purchase order; EC26 unit must be ordered separately, see page 44
- pedestal access door with wire manager available, use with top grommet, specify; add \$337 list for laminate or \$390 list for veneer; see page 17 for details
- interior kneespace wire manager available, use with top grommet or power unit, specify and add \$114 list; see page 17 for details

Description	D	W	H	CTN WT	CU FT	1 Model	HPL Laminate	Flat Cut Veneer	Double Cut Veneer
Single Pedestal Desk with Break Front Modesty	30	84	29	272	50	FLT3084RD	\$2,532		
	30	84	29	272	50	FLV3084RD		\$3,536	\$3,891
	30	84	29	272	50	FLT3084LD	\$2,532		
	30	84	29	272	50	FLV3084LD		\$3,536	\$3,891
 	30	78	29	264	47	FLT3078RD	\$2,471		
	30	78	29	264	47	FLV3078RD		\$3,452	\$3,795
	30	78	29	264	47	FLT3078LD	\$2,471		
	30	78	29	264	47	FLV3078LD		\$3,452	\$3,795
	30	72	29	256	43	FLT3072RD	\$2,413		
	30	72	29	256	43	FLV3072RD		\$3,368	\$3,703
	30	72	29	256	43	FLT3072LD	\$2,413		
	30	72	29	256	43	FLV3072LD		\$3,368	\$3,703
	30	66	29	248	40	FLT3066RD	\$2,353		
	30	66	29	248	40	FLV3066RD		\$3,285	\$3,615
	30	66	29	248	40	FLT3066LD	\$2,353		
	30	66	29	248	40	FLV3066LD		\$3,285	\$3,615
	30	60	29	240	36	FLT3060RD	\$2,296		
	30	60	29	240	36	FLV3060RD		\$3,205	\$3,526
	30	60	29	240	36	FLT3060LD	\$2,296		
	30	60	29	240	36	FLV3060LD		\$3,205	\$3,526

Features:

- eased edge profile on approach and user sides
- pedestal front locking
- FLT3084RD or FLT3084LD and FLV3084RD or FLV3084LD - chassis 30" x 84"
- FLT3078RD or FLT3078LD and FLV3078RD or FLV3078LD - chassis 30" x 78"
- FLT3072RD or FLT3072LD and FLV3072RD or FLV3072LD - chassis 30" x 72"
- FLT3066RD or FLT3066LD and FLV3066RD or FLV3066LD - chassis 30" x 66"
- FLT3060RD or FLT3060LD and FLV3060RD or FLV3060LD - chassis 30" x 60"

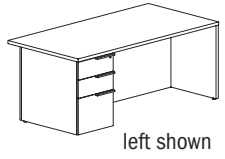
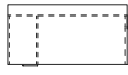
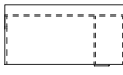
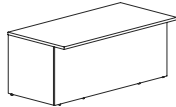
Options:

- must specify chassis grain direction on double cut veneer, see pages 13-15 for details
- veneer drawer fronts in paint available, specify paint color; add \$337 list; see page 16 for details
- on laminate units, contrasting worksurface tops and drawer fronts available, no upcharge; specify laminate color, see page 16 for details
- ledge pulls standard; prism pulls available, specify and see page 9
- top grommet available, specify location; add \$128 list each; see page 44 for details
- worksurface power available, specify "to accommodate EC26" on your purchase order; EC26 unit must be ordered separately, see page 44
- pedestal access door with wire manager available, use with top grommet, specify; add \$337 list for laminate or \$390 list for veneer; see page 17 for details
- interior kneespace wire manager available, use with top grommet or power unit, specify and add \$114 list; see page 17 for details

To Order, Specify:

1 Laminate Model #	2 Laminate Type	3 Laminate Selection	4 Metal Color	5 Other Product Options
Laminate (FLT)	HPL	See Laminate Selection	See Metal Finish Color Options	See list of options for each specific unit; Specify and add accordingly.

1 Veneer Model #	2 Wood Species	3 Wood Finish	4 Metal Color	5 Other Product Options	
Veneer (FLV)	Flat Cut CH1 Cherry MA1 Maple WA1 Walnut BO1 Black Oak	See Flat Cut Wood Finish Options	See Metal Finish Color Options	See list of options for each specific unit; Specify and add accordingly.	
	Double Cut DC1 Double Cut	<table border="1"> <thead> <tr> <th>3a Wood Finish</th> <th>3b Chassis Grain Direction</th> </tr> </thead> <tbody> <tr> <td>See Double Cut Wood Finish Options</td> <td>For Double Cut Only: Vertical Horizontal</td> </tr> </tbody> </table>			3a Wood Finish
3a Wood Finish	3b Chassis Grain Direction				
See Double Cut Wood Finish Options	For Double Cut Only: Vertical Horizontal				

Description	D	W	H	CTN WT	CU FT	① Model	HPL Laminate	Flat Cut Veneer	Double Cut Veneer
 <p>left shown</p>  <p>left</p>  <p>right</p>  <p>approach</p>	36	84	29	272	60	FLT3684REDF	\$2,436		
	36	84	29	272	60	FLV3684REDF		\$3,400	\$3,742
	36	84	29	272	60	FLT3684LEDF	\$2,436		
	36	84	29	272	60	FLV3684LEDF		\$3,400	\$3,742
	36	78	29	263	55	FLT3678REDF	\$2,377		
	36	78	29	263	55	FLV3678REDF		\$3,317	\$3,649
	36	78	29	263	55	FLT3678LEDF	\$2,377		
	36	78	29	263	55	FLV3678LEDF		\$3,317	\$3,649
	36	72	29	254	51	FLT3672REDF	\$2,320		
	36	72	29	254	51	FLV3672REDF		\$3,237	\$3,562
	36	72	29	254	51	FLT3672LEDF	\$2,320		
	36	72	29	254	51	FLV3672LEDF		\$3,237	\$3,562

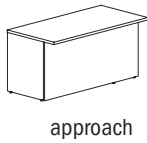
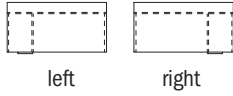
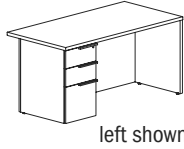
Features:

- eased edge profile on approach and user sides
- 6" overhang on approach side
- pedestal front locking
- FLT3684REDF or FLT3684LEDF and FLV3684REDF or FLV3684LEDF - chassis 30" x 84"
- FLT3678REDF or FLV3678LEDF and FLV3678REDF or FLV3678LEDF - chassis 30" x 78"
- FLT3672REDF or FLT3672LEDF and FLV3672REDF or FLV3672LEDF - chassis 30" x 72"

Options:

- must specify chassis grain direction on double cut veneer, see pages 13-15 for details
- veneer drawer fronts in paint available, specify paint color and add \$337 list; see page 16 for details
- on laminate units, contrasting worksurface tops and drawer fronts available, no upcharge; specify laminate color, see page 16 for details
- ledge pulls standard; prism pulls available, specify and see page 9
- top grommet available, specify location; add \$128 list each; see page 44 for details
- worksurface power available, specify "to accommodate EC26" on your purchase order; EC26 unit must be ordered separately, see page 44
- interior kneespace wire manager available, use with top grommet or power unit, specify and add \$114 list; see page 17 for details

Description	D	W	H	CTN WT	CU FT	① Model	HPL Laminate	Flat Cut Veneer	Double Cut Veneer
Single Pedestal Desk with Flush Modesty	30	72	29	219	43	FLT3072REDF	\$2,212		
	30	72	29	219	43	FLV3072REDF		\$3,089	\$3,398
	30	72	29	219	43	FLT3072LEDF	\$2,212		
	30	72	29	219	43	FLV3072LEDF		\$3,089	\$3,398
	30	66	29	212	40	FLT3066REDF	\$2,159		
	30	66	29	212	40	FLV3066REDF		\$3,013	\$3,314
	30	66	29	212	40	FLT3066LEDF	\$2,159		
	30	66	29	212	40	FLV3066LEDF		\$3,013	\$3,314
	30	60	29	205	36	FLT3060REDF	\$2,107		
	30	60	29	205	36	FLV3060REDF		\$2,940	\$3,235
	30	60	29	205	36	FLT3060LEDF	\$2,107		
	30	60	29	205	36	FLV3060LEDF		\$2,940	\$3,235



Features:

- eased edge profile on approach and user sides
- 6" overhang on approach side
- pedestal front locking
- FLT3072REDF or FLT3072LEDF and FLV3072REDF or FLV3072LEDF - chassis 24" x 72"
- FLT3066REDF or FLT3066LEDF and FLV3066REDF or FLV3066LEDF - chassis 24" x 66"
- FLT3060REDF or FLT3060LEDF and FLV3060REDF or FLV3060LEDF - chassis 24" x 60"

Options:

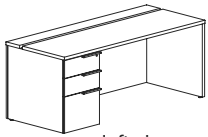
- must specify chassis grain direction on double cut veneer, see pages 13-15 for details
- veneer drawer fronts in paint available, specify paint color and add \$337 list; see page 16 for details
- on laminate units, contrasting worksurface tops and drawer fronts available, no upcharge; specify laminate color, see page 16 for details
- ledge pulls standard; prism pulls available, specify and see page 9
- top grommet available, specify location; add \$128 list each; see page 44 for details
- worksurface power available, specify "to accommodate EC26" on your purchase order; EC26 unit must be ordered separately, see page 44
- interior kneespace wire manager available, use with top grommet or power unit, specify and add \$114 list; see page 17 for details

To Order, Specify:

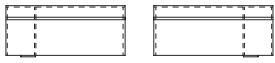
① Laminate Model #	② Laminate Type	③ Laminate Selection		④ Metal Color	⑤ Other Product Options
Laminate (FLT)	HPL	See Laminate Selection		See Metal Finish Color Options	See list of options for each specific unit; Specify and add accordingly.

① Veneer Model #	② Wood Species	③ Wood Finish		④ Metal Color	⑤ Other Product Options
Veneer (FLV)	Flat Cut CH1 Cherry MA1 Maple WA1 Walnut BO1 Black Oak	See Flat Cut Wood Finish Options		See Metal Finish Color Options	See list of options for each specific unit; Specify and add accordingly.
		ⓐ Wood Finish	ⓑ Chassis Grain Direction		
	Double Cut DC1 Double Cut	See Double Cut Wood Finish Options	For Double Cut Only: Vertical Horizontal		

Description	D	W	H	CTN WT	CU FT	① Model	HPL Laminate	Flat Cut Veneer	Double Cut Veneer
Single Pedestal Desk with Flush Modesty - Continuous Wire Channel - Split Top	30	84	29	259	50	FLT3084RDSTF	\$2,568		
	30	84	29	259	50	FLV3084RDSTF		\$3,505	\$3,856
	30	84	29	259	50	FLT3084LDSTF	\$2,568		
	30	84	29	259	50	FLV3084LDSTF		\$3,505	\$3,856
	30	78	29	251	47	FLT3078RDSTF	\$2,509		
	30	78	29	251	47	FLV3078RDSTF		\$3,426	\$3,769
	30	78	29	251	47	FLT3078LDSTF	\$2,509		
	30	78	29	251	47	FLV3078LDSTF		\$3,426	\$3,769
	30	72	29	243	43	FLT3072RDSTF	\$2,564		
	30	72	29	243	43	FLV3072RDSTF		\$3,346	\$3,681
	30	72	29	243	43	FLT3072LDSTF	\$2,564		
	30	72	29	243	43	FLV3072LDSTF		\$3,346	\$3,681
	30	66	29	235	40	FLT3066RDSTF	\$2,407		
	30	66	29	235	40	FLV3066RDSTF		\$3,283	\$3,613
	30	66	29	235	40	FLT3066LDSTF	\$2,407		
	30	66	29	235	40	FLV3066LDSTF		\$3,283	\$3,613
	30	60	29	227	36	FLT3060RDSTF	\$2,365		
	30	60	29	227	36	FLV3060RDSTF		\$3,221	\$3,544
	30	60	29	227	36	FLT3060LDSTF	\$2,365		
	30	60	29	227	36	FLV3060LDSTF		\$3,221	\$3,544

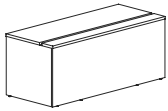


left shown



left

right



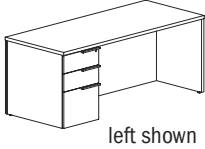


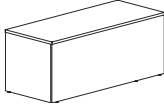
approach

Features:

- eased edge profile on approach and user sides
- built in horizontal wire channel
- pedestal front locking
- FLT3084RDSTF or FLT3084LDSTF and FLV3084RDSTF or FLV3084LDSTF - chassis 30" x 84"
- FLT3078RDSTF or FLT3078LDSTF and FLV3078RDSTF or FLV3078LDSTF - chassis 30" x 78"
- FLT3072RDSTF or FLT3072LDSTF and FLV3072RDSTF or FLV3072LDSTF - chassis 30" x 72"
- FLT3066RDSTF or FLT3066LDSTF and FLV3066RDSTF or FLV3066LDSTF - chassis 30" x 66"
- FLT3060RDSTF or FLT3060LDSTF and FLV3060RDSTF or FLV3060LDSTF - chassis 30" x 60"

Options:

- must specify chassis grain direction on double cut veneer, see pages 13-15 for details
- veneer drawer fronts in paint available, specify paint color; add \$337 list; see page 16 for details
- on laminate units, contrasting worksurface tops and drawer fronts available, no upcharge; specify laminate color, see page 16 for details
- ledge pulls standard; prism pulls available, specify and see page 9

Description	D	W	H	CTN WT	CU FT	① Model	HPL Laminate	Flat Cut Veneer	Double Cut Veneer
Single Pedestal Desk with Flush Modesty	30	84	29	259	50	FLT3084RDF	\$2,371		
	30	84	29	259	50	FLV3084RDF		\$3,309	\$3,640
	30	84	29	259	50	FLT3084LDF	\$2,371		
	30	84	29	259	50	FLV3084LDF		\$3,309	\$3,640
 	30	78	29	251	47	FLT3078RDF	\$2,313		
	30	78	29	251	47	FLV3078RDF		\$3,229	\$3,553
	30	78	29	251	47	FLT3078LDF	\$2,313		
	30	78	29	251	47	FLV3078LDF		\$3,229	\$3,553
	30	72	29	243	43	FLT3072RDF	\$2,259		
	30	72	29	243	43	FLV3072RDF		\$3,150	\$3,464
	30	72	29	243	43	FLT3072LDF	\$2,259		
	30	72	29	243	43	FLV3072LDF		\$3,150	\$3,464
	30	66	29	235	40	FLT3066RDF	\$2,210		
	30	66	29	235	40	FLV3066RDF		\$3,087	\$3,395
	30	66	29	235	40	FLT3066LDF	\$2,210		
	30	66	29	235	40	FLV3066LDF		\$3,087	\$3,395
	30	60	29	227	36	FLT3060RDF	\$2,168		
	30	60	29	227	36	FLV3060RDF		\$3,024	\$3,328
	30	60	29	227	36	FLT3060LDF	\$2,168		
	30	60	29	227	36	FLV3060LDF		\$3,024	\$3,328

Features:

- eased edge profile on approach and user sides
- pedestal front locking
- FLT3084RDF or FLT3084LDF and FLV3084RDF or FLV3084LDF - chassis 30" x 84"
- FLT3078RDF or FLT3078LDF and FLV3078RDF or FLV3078LDF - chassis 30" x 78"
- FLT3072RDF or FLT3072LDF and FLV3072RDF or FLV3072LDF - chassis 30" x 72"
- FLT3066RDF or FLT3066LDF and FLV3066RDF or FLV3066LDF - chassis 30" x 66"
- FLT3060RDF or FLT3060LDF and FLV3060RDF or FLV3060LDF - chassis 30" x 60"

Options:

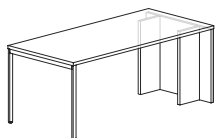

- must specify chassis grain direction on double cut veneer, see pages 13-15 for details
- veneer drawer fronts in paint available, specify paint color; add \$337 list; see page 16 for details
- on laminate units, contrasting worksurface tops and drawer fronts available, no upcharge; specify laminate color, see page 16 for details
- ledge pulls standard; prism pulls available, specify and see page 9
- top grommet available, specify location; add \$128 list each; see page 44 for details
- worksurface power available, specify "to accommodate EC26" on your purchase order; EC26 unit must be ordered separately, see page 44
- interior kneespace wire manager available, use with top grommet or power unit, specify and add \$114 list; see page 17 for details

To Order, Specify:

① Laminate Model #	② Laminate Type	③ Laminate Selection	④ Metal Color	⑤ Other Product Options
Laminate (FLT)	HPL	See Laminate Selection	See Metal Finish Color Options	See list of options for each specific unit; Specify and add accordingly.

① Veneer Model #	② Wood Species	③ Wood Finish	④ Metal Color	⑤ Other Product Options	
Veneer (FLV)	Flat Cut CH1 Cherry MA1 Maple WA1 Walnut BO1 Black Oak	See Flat Cut Wood Finish Options	See Metal Finish Color Options	See list of options for each specific unit; Specify and add accordingly.	
	Double Cut DC1 Double Cut	<table border="1"> <thead> <tr> <th>ⓐ Wood Finish</th> <th>ⓑ Chassis Grain Direction</th> </tr> </thead> <tbody> <tr> <td>See Double Cut Wood Finish Options</td> <td>For Double Cut Only: Vertical Horizontal</td> </tr> </tbody> </table>			ⓐ Wood Finish
ⓐ Wood Finish	ⓑ Chassis Grain Direction				
See Double Cut Wood Finish Options	For Double Cut Only: Vertical Horizontal				

FLUX - PRIVATE OFFICE

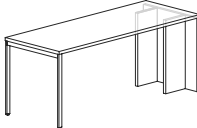
Description	D	W	H	CTN WT	CU FT	① Model	HPL Laminate	Flat Cut Veneer	Double Cut Veneer
Rectangular Peninsula Table Desk with End Leg Assembly and Panel End  	33½	84	29	169	56	FLT3484PDNEP	\$2,193		
	33½	84	29	169	56	FLV3484PDNEP		\$2,893	\$3,182
	33½	78	29	161	52	FLT3478PDNEP	\$2,157		
	33½	78	29	161	52	FLV3478PDNEP		\$2,842	\$3,128
	33½	72	29	153	48	FLT3472PDNEP	\$2,120		
	33½	72	29	153	48	FLV3472PDNEP		\$2,795	\$3,074
	33½	66	29	145	44	FLT3466PDNEP	\$2,085		
	33½	66	29	145	44	FLV3466PDNEP		\$2,747	\$3,022

Features:

- intended to be used with bridges or return units, see pages 154-159
- eased edge profile on approach and user sides

Options:

- must specify support panels grain direction on double cut veneer, see pages 13-15 for details
- on laminate units, contrasting worksurface tops and chassis available, no upcharge; specify color see page 16 for details
- 13½" h modesty panel available, specify; add \$427 list for laminate or \$594 list for veneer; see page 21 for details
- top grommet available, specify location; add \$128 list each; see page 44 for details
- 12" wide top grommet available, specify location; add \$168 list each; see page 44 for details
- worksurface power available, specify "to accommodate EC26" on your purchase order; EC26 unit must be ordered separately, see page 44
- wire manager tray available see accessory section on pages 50-51 for details

Description	D	W	H	CTN WT	CU FT	① Model	HPL Laminate	Flat Cut Veneer	Double Cut Veneer
Rectangular Peninsula Table	27 1/2	84	29	145	46	FLT2884PDNEP	\$2,116		
Desk with End Leg Assembly and Panel End 	27 1/2	84	29	145	46	FLV2884PDNEP		\$2,791	\$3,069
	27 1/2	78	29	139	43	FLT2878PDNEP	\$2,081		
	27 1/2	78	29	139	43	FLV2878PDNEP		\$2,744	\$3,018
	27 1/2	72	29	133	40	FLT2872PDNEP	\$2,047		
	27 1/2	72	29	133	40	FLV2872PDNEP		\$2,695	\$2,966
	27 1/2	66	29	127	37	FLT2866PDNEP	\$2,022		
	27 1/2	66	29	127	37	FLV2866PDNEP		\$2,662	\$2,930



Features:

- intended to be used with bridges or return units, see pages 154-159
- eased edge profile on approach and user sides

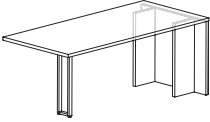
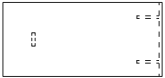
Options:

- must specify support panels grain direction on double cut veneer, see pages 13-15 for details
- on laminate units, contrasting worksurface tops and chassis available, no upcharge; specify color see page 16 for details
- 13 1/2" h modesty panel available, specify; add \$427 list for laminate or \$594 list for veneer; see page 21 for details
- top grommet available, specify location; add \$128 list each; see page 44 for details
- 12" wide top grommet available, specify location; add \$168 list each; see page 44 for details
- worksurface power available, specify "to accommodate EC26" on your purchase order; EC26 unit must be ordered separately, see page 44
- wire manager tray available see accessory section on pages 50-51 for details

To Order, Specify:

① Laminate Model #	② Laminate Type	③ Laminate Selection		④ Metal Color	⑤ Other Product Options
Laminate (FLT)	HPL	See Laminate Selection		See Metal Finish Color Options	See list of options for each specific unit; Specify and add accordingly.

① Veneer Model #	② Wood Species	③ Wood Finish		④ Metal Color	⑤ Other Product Options
Veneer (FLV)	Flat Cut CH1 Cherry MA1 Maple WA1 Walnut BO1 Black Oak	See Flat Cut Wood Finish Options		See Metal Finish Color Options	See list of options for each specific unit; Specify and add accordingly.
	Double Cut DC1 Double Cut	③a Wood Finish See Double Cut Wood Finish Options	③b Chassis Grain Direction For Double Cut Only: Vertical Horizontal		

Description	D	W	H	CTN WT	CU FT	① Model	HPL Laminate	Flat Cut Veneer	Double Cut Veneer
Rectangular Peninsula Table Desk with Frame Base and Panel End  	33½	84	29	169	56	FLT3484PDPEP	\$2,193		
	33½	84	29	169	56	FLV3484PDPEP		\$2,893	\$3,182
	33½	78	29	161	52	FLT3478PDPEP	\$2,157		
	33½	78	29	161	52	FLV3478PDPEP		\$2,842	\$3,128
	33½	72	29	153	48	FLT3472PDPEP	\$2,120		
	33½	72	29	153	48	FLV3472PDPEP		\$2,795	\$3,074
	33½	66	29	145	44	FLT3466PDPEP	\$2,085		
	33½	66	29	145	44	FLV3466PDPEP		\$2,747	\$3,022

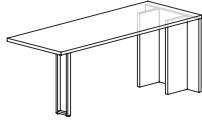
Features:

- must be used with run-off credenza or return units, see pages 154-159
- eased edge profile on approach and user sides

Options:

- must specify support panels grain direction on double cut veneer, see pages 13-15 for details
- on laminate units, contrasting worksurface tops and chassis available, no upcharge; specify color see page 16 for details
- 13½”h modesty panel available, specify; add \$427 list for laminate or \$594 list for veneer; see page 21 for details
- top grommet available, specify location; add \$128 list each; see page 44 for details
- 12” wide top grommet available, specify location; add \$168 list each; see page 44 for details
- worksurface power available, specify “to accommodate EC26” on your purchase order; EC26 unit must be ordered separately, see page 44
- wire manager tray available see accessory section on pages 50-51 for details

Description	D	W	H	CTN WT	CU FT	① Model	HPL Laminate	Flat Cut Veneer	Double Cut Veneer
Rectangular Peninsula Table	27 1/2	84	29	145	46	FLT2884PDPEP	\$2,116		
Desk with Frame Base and Panel End	27 1/2	84	29	145	46	FLV2884PDPEP		\$2,791	\$3,069
	27 1/2	78	29	139	43	FLT2878PDPEP	\$2,081		
	27 1/2	78	29	139	43	FLV2878PDPEP		\$2,744	\$3,018
	27 1/2	72	29	133	40	FLT2872PDPEP	\$2,047		
	27 1/2	72	29	133	40	FLV2872PDPEP		\$2,695	\$2,966
	27 1/2	66	29	127	37	FLT2866PDPEP	\$2,022		
	27 1/2	66	29	127	37	FLV2866PDPEP		\$2,662	\$2,930



Features:

- must be used with run-off credenza or return units, see pages 154-159
- eased edge profile on approach and user sides

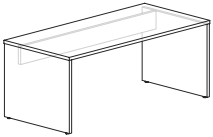
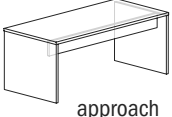
Options:

- must specify support panels grain direction on double cut veneer, see pages 13-15 for details
- on laminate units, contrasting worksurface tops and chassis available, no upcharge; specify color see page 16 for details
- 13 1/2" h modesty panel available, specify; add \$427 list for laminate or \$594 list for veneer; see page 21 for details
- top grommet available, specify location; add \$128 list each; see page 44 for details
- 12" wide top grommet available, specify location; add \$168 list each; see page 44 for details
- worksurface power available, specify "to accommodate EC26" on your purchase order; EC26 unit must be ordered separately, see page 44
- wire manager tray available see accessory section on pages 50-51 for details

To Order, Specify:

① Laminate Model #	② Laminate Type	③ Laminate Selection		④ Metal Color	⑤ Other Product Options
Laminate (FLT)	HPL	See Laminate Selection		See Metal Finish Color Options	See list of options for each specific unit; Specify and add accordingly.

① Veneer Model #	② Wood Species	③ Wood Finish		④ Metal Color	⑤ Other Product Options
Veneer (FLV)	Flat Cut CH1 Cherry MA1 Maple WA1 Walnut BO1 Black Oak	See Flat Cut Wood Finish Options		See Metal Finish Color Options	See list of options for each specific unit; Specify and add accordingly.
	Double Cut DC1 Double Cut	③a Wood Finish See Double Cut Wood Finish Options	③b Chassis Grain Direction For Double Cut Only: Vertical Horizontal		

Description	D	W	H	CTN WT	CU FT	① Model	HPL Laminate	Flat Cut Veneer	Double Cut Veneer
  approach	33½	84	29	181	56	FLT3484PDEPPR	\$1,447		
	33½	84	29	181	56	FLV3484PDEPPR		\$2,190	\$2,409
	33½	84	29	181	56	FLT3484PDEPPL	\$1,447		
	33½	84	29	181	56	FLV3484PDEPPL		\$2,190	\$2,409
	33½	78	29	172	52	FLT3478PDEPPR	\$1,412		
	33½	78	29	172	52	FLV3478PDEPPR		\$2,136	\$2,351
	33½	78	29	172	52	FLT3478PDEPPL	\$1,412		
	33½	78	29	172	52	FLV3478PDEPPL		\$2,136	\$2,351
	33½	72	29	163	48	FLT3472PDEPPR	\$1,378		
	33½	72	29	163	48	FLV3472PDEPPR		\$2,085	\$2,294
	33½	72	29	163	48	FLT3472PDEPPL	\$1,378		
	33½	72	29	163	48	FLV3472PDEPPL		\$2,085	\$2,294
	33½	66	29	154	44	FLT3466PDEPPR	\$1,359		
	33½	66	29	154	44	FLV3466PDEPPR		\$2,055	\$2,260
	33½	66	29	154	44	FLT3466PDEPPL	\$1,359		
	33½	66	29	154	44	FLV3466PDEPPL		\$2,055	\$2,260

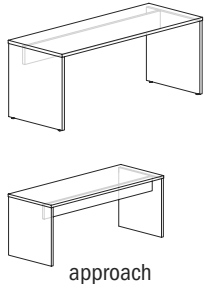
*desks are handed when grommets are applied; see page 44

Features:

- eased edge profile on approach and user sides
- 6¾" h modesty with horizontal wire channel

Options:

- must specify support panels grain direction on double cut veneer, see pages 13-15 for details
- on laminate units, contrasting worksurface tops and chassis available, no upcharge; specify color see page 16 for details
- top grommet available, specify location; add \$128 list each; see page 44 for details
- 12" wide top grommet available, specify location; add \$168 list each; see page 44 for details
- worksurface power available, specify "to accommodate EC26" on your purchase order; EC26 unit must be ordered separately, see page 44
- wire manager tray available see accessory section on pages 50-51 for details

Description	D	W	H	CTN WT	CU FT	① Model	HPL Laminate	Flat Cut Veneer	Double Cut Veneer
 <p>approach</p>	27 1/2	84	29	154	46	FLT2884PDEPPR	\$1,368		
	27 1/2	84	29	154	46	FLV2884PDEPPR		\$2,071	\$2,278
	27 1/2	84	29	154	46	FLT2884PDEPPL	\$1,368		
	27 1/2	84	29	154	46	FLV2884PDEPPL		\$2,071	\$2,278
	27 1/2	78	29	148	43	FLT2878PDEPPR	\$1,336		
	27 1/2	78	29	148	43	FLV2878PDEPPR		\$2,020	\$2,222
	27 1/2	78	29	148	43	FLT2878PDEPPL	\$1,336		
	27 1/2	78	29	148	43	FLV2878PDEPPL		\$2,020	\$2,222
	27 1/2	72	29	142	40	FLT2872PDEPPR	\$1,301		
	27 1/2	72	29	142	40	FLV2872PDEPPR		\$1,972	\$2,169
	27 1/2	72	29	142	40	FLT2872PDEPPL	\$1,301		
	27 1/2	72	29	142	40	FLV2872PDEPPL		\$1,972	\$2,169
	27 1/2	66	29	136	37	FLT2866PDEPPR	\$1,283		
	27 1/2	66	29	136	37	FLV2866PDEPPR		\$1,941	\$2,135
	27 1/2	66	29	136	37	FLT2866PDEPPL	\$1,283		
27 1/2	66	29	136	37	FLV2866PDEPPL		\$1,941	\$2,135	

*desks are handed when grommets are applied; see page 44

Features:

- eased edge profile on approach and user sides
- 6 3/4" h modesty with horizontal wire channel

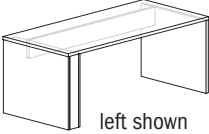
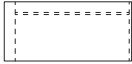
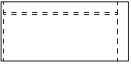
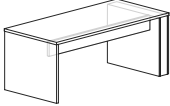
Options:

- must specify support panels grain direction on double cut veneer, see pages 13-15 for details
- on laminate units, contrasting worksurface tops and chassis available, no upcharge; specify color see page 16 for details
- top grommet available, specify location; add \$128 list each; see page 44 for details
- 12" wide top grommet available, specify location; add \$168 list each; see page 44 for details
- worksurface power available, specify "to accommodate EC26" on your purchase order; EC26 unit must be ordered separately, see page 44
- wire manager tray available see accessory section on pages 50-51 for details

To Order, Specify:

① Laminate Model #	② Laminate Type	③ Laminate Selection	④ Metal Color	⑤ Other Product Options
Laminate (FLT)	HPL	See Laminate Selection	See Metal Finish Color Options	See list of options for each specific unit; Specify and add accordingly.

① Veneer Model #	② Wood Species	③ Wood Finish	④ Metal Color	⑤ Other Product Options	
Veneer (FLV)	Flat Cut CH1 Cherry MA1 Maple WA1 Walnut BO1 Black Oak	See Flat Cut Wood Finish Options	See Metal Finish Color Options	See list of options for each specific unit; Specify and add accordingly.	
	Double Cut DC1 Double Cut	<table border="1"> <thead> <tr> <th>ⓐ Wood Finish</th> <th>ⓑ Chassis Grain Direction</th> </tr> </thead> <tbody> <tr> <td>See Double Cut Wood Finish Options</td> <td>For Double Cut Only: Vertical Horizontal</td> </tr> </tbody> </table>			ⓐ Wood Finish
ⓐ Wood Finish	ⓑ Chassis Grain Direction				
See Double Cut Wood Finish Options	For Double Cut Only: Vertical Horizontal				

Description	D	W	H	CTN WT	CU FT	① Model	HPL Laminate	Flat Cut Veneer	Double Cut Veneer
Rectangular Peninsula Table	33½	84	29	207	56	FLT3484PDTEPR	\$1,943		
Desk with 6" w Full Support Panel and Panel End	33½	84	29	207	56	FLV3484PDTEPR		\$2,943	\$3,239
	33½	84	29	207	56	FLT3484PDTEPL	\$1,943		
 left shown	33½	84	29	207	56	FLV3484PDTEPL		\$2,943	\$3,239
	33½	78	29	198	52	FLT3478PDTEPR	\$1,896		
 left	33½	78	29	198	52	FLV3478PDTEPR		\$2,872	\$3,159
	33½	78	29	198	52	FLT3478PDTEPL	\$1,896		
 right	33½	78	29	198	52	FLV3478PDTEPL		\$2,872	\$3,159
	33½	72	29	189	48	FLT3472PDTEPR	\$1,851		
 approach - left	33½	72	29	189	48	FLV3472PDTEPR		\$2,802	\$3,083
	33½	72	29	189	48	FLT3472PDTEPL	\$1,851		
	33½	72	29	189	48	FLV3472PDTEPL		\$2,802	\$3,083
	33½	66	29	180	44	FLT3466PDTEPR	\$1,823		
	33½	66	29	180	44	FLV3466PDTEPR		\$2,760	\$3,038
	33½	66	29	180	44	FLT3466PDTEPL	\$1,823		
	33½	66	29	180	44	FLV3466PDTEPL		\$2,760	\$3,038

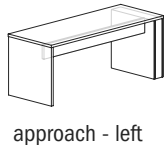
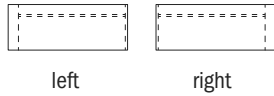
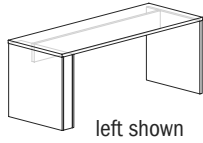
Features:

- eased edge profile on approach and user sides
- 6¾" h modesty with horizontal wire channel

Options:

- must specify support panels grain direction on double cut veneer, see pages 13-15 for details
- on laminate units, contrasting worksurface tops and chassis available, no upcharge; specify color see page 16 for details
- top grommet available, specify location; add \$128 list each; see page 44 for details
- 12" wide top grommet available, specify location; add \$168 list each; see page 44 for details
- worksurface power available, specify "to accommodate EC26" on your purchase order; EC26 unit must be ordered separately, see page 44
- wire manager tray available see accessory section on pages 50-51 for details

Description	D	W	H	CTN WT	CU FT	① Model	HPL Laminate	Flat Cut Veneer	Double Cut Veneer
Rectangular Peninsula Table Desk with 6" w Full Support Panel and Panel End	27 1/2	84	29	177	46	FLT2884PDTEPR	\$1,850		
	27 1/2	84	29	177	46	FLV2884PDTEPR		\$2,800	\$3,081
	27 1/2	84	29	177	46	FLT2884PDTEPL	\$1,850		
	27 1/2	84	29	177	46	FLV2884PDTEPL		\$2,800	\$3,081
	27 1/2	78	29	171	43	FLT2878PDTEPR	\$1,806		
	27 1/2	78	29	171	43	FLV2878PDTEPR		\$2,731	\$3,006
	27 1/2	78	29	171	43	FLT2878PDTEPL	\$1,806		
	27 1/2	78	29	171	43	FLV2878PDTEPL		\$2,731	\$3,006
	27 1/2	72	29	165	40	FLT2872PDTEPR	\$1,760		
	27 1/2	72	29	165	40	FLV2872PDTEPR		\$2,667	\$2,934
	27 1/2	72	29	165	40	FLT2872PDTEPL	\$1,760		
	27 1/2	72	29	165	40	FLV2872PDTEPL		\$2,667	\$2,934
	27 1/2	66	29	159	37	FLT2866PDTEPR	\$1,735		
	27 1/2	66	29	159	37	FLV2866PDTEPR		\$2,626	\$2,890
	27 1/2	66	29	159	37	FLT2866PDTEPL	\$1,735		
	27 1/2	66	29	159	37	FLV2866PDTEPL		\$2,626	\$2,890



Features:

- eased edge profile on approach and user sides
- 6 3/4" h modesty with horizontal wire channel

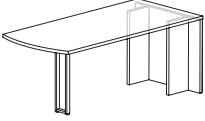

Options:

- must specify support panels grain direction on double cut veneer, see pages 13-15 for details
- on laminate units, contrasting worksurface tops and chassis available, no upcharge; specify color see page 16 for details
- top grommet available, specify location; add \$128 list each; see page 44 for details
- 12" wide top grommet available, specify location; add \$168 list each; see page 44 for details
- worksurface power available, specify "to accommodate EC26" on your purchase order; EC26 unit must be ordered separately, see page 44
- wire manager tray available see accessory section on pages 50-51 for details

To Order, Specify:

① Laminate Model #	② Laminate Type	③ Laminate Selection	④ Metal Color	⑤ Other Product Options
Laminate (FLT)	HPL	See Laminate Selection	See Metal Finish Color Options	See list of options for each specific unit; Specify and add accordingly.

① Veneer Model #	② Wood Species	③ Wood Finish	④ Metal Color	⑤ Other Product Options	
Veneer (FLV)	Flat Cut CH1 Cherry MA1 Maple WA1 Walnut BO1 Black Oak	See Flat Cut Wood Finish Options	See Metal Finish Color Options	See list of options for each specific unit; Specify and add accordingly.	
	Double Cut DC1 Double Cut	<table border="1"> <thead> <tr> <th>ⓐ Wood Finish</th> <th>ⓑ Chassis Grain Direction</th> </tr> </thead> <tbody> <tr> <td>See Double Cut Wood Finish Options</td> <td>For Double Cut Only: Vertical Horizontal</td> </tr> </tbody> </table>			ⓐ Wood Finish
ⓐ Wood Finish	ⓑ Chassis Grain Direction				
See Double Cut Wood Finish Options	For Double Cut Only: Vertical Horizontal				

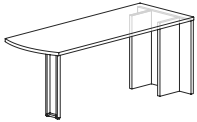

Description	D	W	H	CTN WT	CU FT	① Model	HPL Laminate	Flat Cut Veneer	Double Cut Veneer
Arc Peninsula Table Desk with Frame Base and Panel End  	33½	84	29	169	56	FLT3484PARCPEP	\$2,371		
	33½	84	29	169	56	FLV3484PARCPEP		\$3,133	\$3,447
	33½	78	29	161	52	FLT3478PARCPEP	\$2,321		
	33½	78	29	161	52	FLV3478PARCPEP		\$3,065	\$3,372
	33½	72	29	153	48	FLT3472PARCPEP	\$2,273		
	33½	72	29	153	48	FLV3472PARCPEP		\$3,002	\$3,302
	33½	66	29	145	44	FLT3466PARCPEP	\$2,253		
	33½	66	29	145	44	FLV3466PARCPEP		\$2,974	\$3,271

Features:

- must be used with run-off credenza or return units, see pages 122-127
- eased edge profile on approach and user sides

Options:

- must specify support panels grain direction on double cut veneer, see pages 13-15 for details
- on laminate units, contrasting worksurface tops and chassis available, no upcharge; specify color see page 16 for details
- 13 ½”h modesty panel available, specify; add \$427 list for laminate or \$594 list for veneer; see page 21 for details
- top grommet available, specify location; add \$128 list each; see page 44 for details
- 12” wide top grommet available, specify location; add \$168 list each; see page 44 for details
- worksurface power available, specify “to accommodate EC26” on your purchase order; EC26 unit must be ordered separately, see page 44
- wire manager tray available see accessory section on pages 50-51 for details

Description	D	W	H	CTN WT	CU FT	① Model	HPL Laminate	Flat Cut Veneer	Double Cut Veneer
Arc Peninsula Table Desk with Frame Base and Panel End  	27 1/2	84	29	145	46	FLT2884PARCPEP	\$2,295		
	27 1/2	84	29	145	46	FLV2884PARCPEP		\$3,028	\$3,333
	27 1/2	78	29	139	43	FLT2878PARCPEP	\$2,246		
	27 1/2	78	29	139	43	FLV2878PARCPEP		\$2,966	\$3,264
	27 1/2	72	29	133	40	FLT2872PARCPEP	\$2,199		
	27 1/2	72	29	133	40	FLV2872PARCPEP		\$2,901	\$3,193
	27 1/2	66	29	127	37	FLT2866PARCPEP	\$2,181		
	27 1/2	66	29	127	37	FLV2866PARCPEP		\$2,876	\$3,164

Features:

- must be used with run-off credenza or return units, see pages 122-127
- eased edge profile on approach and user sides

Options:

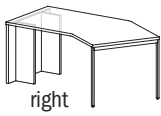
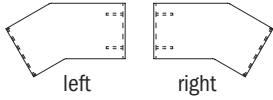
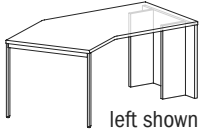
- must specify support panels grain direction on double cut veneer, see pages 13-15 for details
- on laminate units, contrasting worksurface tops and chassis available, no upcharge; specify color see page 16 for details
- 13 1/2" h modesty panel available, specify; add \$427 list for laminate or \$594 list for veneer; see page 21 for details
- top grommet available, specify location; add \$128 list each; see page 44 for details
- 12" wide top grommet available, specify location; add \$168 list each; see page 44 for details
- worksurface power available, specify "to accommodate EC26" on your purchase order; EC26 unit must be ordered separately, see page 44
- wire manager tray available see accessory section on pages 50-51 for details

To Order, Specify:

① Laminate Model #	② Laminate Type	③ Laminate Selection	④ Metal Color	⑤ Other Product Options
Laminate (FLT)	HPL	See Laminate Selection	See Metal Finish Color Options	See list of options for each specific unit; Specify and add accordingly.

① Veneer Model #	② Wood Species	③ Wood Finish	④ Metal Color	⑤ Other Product Options
Veneer (FLV)	Flat Cut CH1 Cherry MA1 Maple WA1 Walnut BO1 Black Oak	See Flat Cut Wood Finish Options	See Metal Finish Color Options	See list of options for each specific unit; Specify and add accordingly.
	Double Cut DC1 Double Cut	③a Wood Finish See Double Cut Wood Finish Options		

Description	D	W	H	CTN WT	CU FT	① Model	HPL Laminate	Flat Cut Veneer	Double Cut Veneer
Boomerang Peninsula Table Desk with End Leg Assembly and Panel End	33½	84	29	169	56	FLT3484PBMNEPR	\$3,010		
	33½	84	29	169	56	FLV3484PBMNEPR		\$3,998	\$4,398
	33½	84	29	169	56	FLT3484PBMNEPL	\$3,010		
	33½	84	29	169	56	FLV3484PBMNEPL		\$3,998	\$4,398
	33½	78	29	161	52	FLT3478PBMNEPR	\$2,944		
	33½	78	29	161	52	FLV3478PBMNEPR		\$3,910	\$4,299
	33½	78	29	161	52	FLT3478PBMNEPL	\$2,944		
	33½	78	29	161	52	FLV3478PBMNEPL		\$3,910	\$4,299
	33½	72	29	153	48	FLT3472PBMNEPR	\$2,880		
	33½	72	29	153	48	FLV3472PBMNEPR		\$3,824	\$4,206
	33½	72	29	153	48	FLT3472PBMNEPL	\$2,880		
	33½	72	29	153	48	FLV3472PBMNEPL		\$3,824	\$4,206
	33½	66	29	145	44	FLT3466PBMNEPR	\$2,842		
	33½	66	29	145	44	FLV3466PBMNEPR		\$3,771	\$4,150
	33½	66	29	145	44	FLT3466PBMNEPL	\$2,842		
	33½	66	29	145	44	FLV3466PBMNEPL		\$3,771	\$4,150

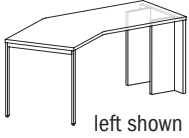

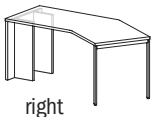


Features:

- must be used with run-off credenza or return units, see pages 122-127
- eased edge profile on approach and user sides

Options:

- must specify support panels grain direction on double cut veneer, see pages 13-15 for details
- on laminate units, contrasting worksurface tops and chassis available, no upcharge; specify color see page 16 for details
- 13 ½" h modesty panel available for 84" w and 78" w desk, specify; add \$427 list for laminate or \$594 list for veneer; see page 21 for details
- top grommet available, specify location; add \$128 list each; see page 44 for details
- 12" wide top grommet available, specify location; add \$168 list each; see page 44 for details
- worksurface power available, specify "to accommodate EC26" on your purchase order; EC26 unit must be ordered separately, see page 44
- wire manager tray available see accessory section on pages 50-51 for details

Description	D	W	H	CTN WT	CU FT	① Model	HPL Laminate	Flat Cut Veneer	Double Cut Veneer
Boomerang Peninsula Table	27 1/2	84	29	145	46	FLT2884PBMNEPR	\$2,952		
Desk with End Leg Assembly and Panel End	27 1/2	84	29	145	46	FLV2884PBMNEPR		\$3,919	\$4,313
	27 1/2	84	29	145	46	FLT2884PBMNEPL	\$2,952		
	27 1/2	84	29	145	46	FLV2884PBMNEPL		\$3,919	\$4,313
	27 1/2	78	29	139	43	FLT2878PBMNEPR	\$2,890		
	27 1/2	78	29	139	43	FLV2878PBMNEPR		\$3,833	\$4,217
	27 1/2	78	29	133	43	FLT2878PBMNEPL	\$2,890		
	27 1/2	78	29	133	43	FLV2878PBMNEPL		\$3,833	\$4,217
	27 1/2	72	29	133	40	FLT2872PBMNEPR	\$2,826		
	27 1/2	72	29	133	40	FLV2872PBMNEPR		\$3,749	\$4,123
	27 1/2	72	29	133	40	FLT2872PBMNEPL	\$2,826		
	27 1/2	72	29	133	40	FLV2872PBMNEPL		\$3,749	\$4,123
	27 1/2	66	29	127	37	FLT2866PBMNEPR	\$2,775		
	27 1/2	66	29	127	37	FLV2866PBMNEPR		\$3,698	\$4,068
	27 1/2	66	29	127	37	FLT2866PBMNEPL	\$2,775		
	27 1/2	66	29	127	37	FLV2866PBMNEPL		\$3,698	\$4,068

Features:

- must be used with run-off credenza or return units, see pages 122-127
- eased edge profile on approach and user sides

Options:

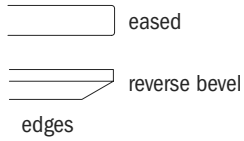
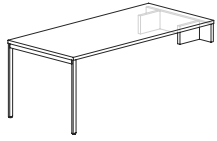
- must specify support panels grain direction on double cut veneer, see pages 13-15 for details
- on laminate units, contrasting worksurface tops and chassis available, no upcharge; specify color see page 16 for details
- 13 1/2" h modesty panel available for 84" w and 78" w desk, specify; add \$427 list for laminate or \$594 list for veneer; see page 21 for details
- top grommet available, specify location; add \$128 list each; see page 44 for details
- 12" wide top grommet available, specify location; add \$168 list each; see page 44 for details
- worksurface power available, specify "to accommodate EC26" on your purchase order; EC26 unit must be ordered separately, see page 44
- wire manager tray available see accessory section on pages 50-51 for details

To Order, Specify:

① Laminate Model #	② Laminate Type	③ Laminate Selection	④ Metal Color	⑤ Other Product Options
Laminate (FLT)	HPL	See Laminate Selection	See Metal Finish Color Options	See list of options for each specific unit; Specify and add accordingly.

① Veneer Model #	② Wood Species	③ Wood Finish	④ Metal Color	⑤ Other Product Options	
Veneer (FLV)	Flat Cut CH1 Cherry MA1 Maple WA1 Walnut BO1 Black Oak	See Flat Cut Wood Finish Options	See Metal Finish Color Options	See list of options for each specific unit; Specify and add accordingly.	
	Double Cut DC1 Double Cut	<table border="1"> <thead> <tr> <th>ⓐ Wood Finish</th> <th>ⓑ Chassis Grain Direction</th> </tr> </thead> <tbody> <tr> <td>See Double Cut Wood Finish Options</td> <td>For Double Cut Only: Vertical Horizontal</td> </tr> </tbody> </table>			ⓐ Wood Finish
ⓐ Wood Finish	ⓑ Chassis Grain Direction				
See Double Cut Wood Finish Options	For Double Cut Only: Vertical Horizontal				

Description	D	W	H	CTN WT	CU FT	① Model	HPL Laminate	Flat Cut Veneer	Double Cut Veneer
Rectangular Peninsula Table Desk with End Leg Assembly and Secondary Support End	33½	84	29	149	31	FLT3484PDN	\$2,066		
	33½	84	29	149	31	FLV3484PDN		\$2,720	\$2,993
	33½	78	29	140	28	FLT3478PDN	\$2,030		
	33½	78	29	140	28	FLV3478PDN		\$2,673	\$2,939
	33½	72	29	131	26	FLT3472PDN	\$1,993		
	33½	72	29	131	26	FLV3472PDN		\$2,622	\$2,884
	33½	66	29	122	24	FLT3466PDN	\$1,958		
	33½	66	29	122	24	FLV3466PDN		\$2,574	\$2,833



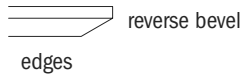
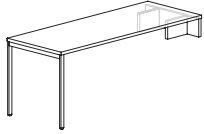
Features:

- peninsula desk mounting included in the list price of the unit, but must be specified when ordering secondary credenza; see pages 18-20 for details
- eased edge profile on approach and user sides

Options:

- must specify support panels grain direction on double cut veneer, see pages 13-15 for details
- on laminate units, contrasting worksurface tops and chassis available, no upcharge; specify color see page 16 for details
- reverse bevel edge available on three sides, specify; add \$429 list for laminate or \$168 list for veneer; see page 8 for details
- 13 ½" h modesty panel available, specify; add \$427 list for laminate or \$594 list for veneer; see page 21 for details
- top grommet available, specify location; add \$128 list each; see page 47 for details
- 12" wide top grommet available, specify location; add \$168 list each; see page 44 for details
- worksurface power available, specify "to accommodate EC26" on your purchase order; EC26 unit must be ordered separately, see page 44
- wire manager tray available see accessory section on pages 50-51 for details

Description	D	W	H	CTN WT	CU FT	1 Model	HPL Laminate	Flat Cut Veneer	Double Cut Veneer
Rectangular Peninsula Table	27 1/2	84	29	128	25	FLT2884PDN	\$1,991		
Desk with End Leg Assembly and Secondary Support End	27 1/2	84	29	128	25	FLV2884PDN		\$2,617	\$2,880
	27 1/2	78	29	122	24	FLT2878PDN	\$1,955		
	27 1/2	78	29	122	24	FLV2878PDN		\$2,571	\$2,828
	27 1/2	72	29	116	22	FLT2872PDN	\$1,920		
	27 1/2	72	29	116	22	FLV2872PDN		\$2,524	\$2,778
	27 1/2	66	29	110	20	FLT2866PDN	\$1,895		
	27 1/2	66	29	110	20	FLV2866PDN		\$2,491	\$2,740



Features:

- peninsula desk mounting included in the list price of the unit, but must be specified when ordering secondary credenza; see pages 18-20 for details
- eased edge profile on approach and user sides

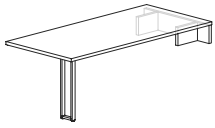
Options:

- must specify support panels grain direction on double cut veneer, see pages 13-15 for details
- on laminate units, contrasting worksurface tops and chassis available, no upcharge; specify color see page 16 for details
- reverse bevel edge available on three sides, specify; add \$429 list for laminate or \$168 list for veneer; see page 8 for details
- 13 1/2" h modesty panel available, specify; add \$427 list for laminate or \$594 list for veneer; see page 21 for details
- top grommet available, specify location; add \$128 list each; see page 47 for details
- 12" wide top grommet available, specify location; add \$168 list each; see page 44 for details
- worksurface power available, specify "to accommodate EC26" on your purchase order; EC26 unit must be ordered separately, see page 44
- wire manager tray available see accessory section on pages 50-51 for details

To Order, Specify:

1 Laminate Model #	2 Laminate Type	3 Laminate Selection		4 Metal Color	5 Other Product Options
Laminate (FLT)	HPL	See Laminate Selection		See Metal Finish Color Options	See list of options for each specific unit; Specify and add accordingly.
1 Veneer Model #	2 Wood Species	3 Wood Finish		4 Metal Color	5 Other Product Options
Veneer (FLV)	Flat Cut CH1 Cherry MA1 Maple WA1 Walnut BO1 Black Oak	See Flat Cut Wood Finish Options		See Metal Finish Color Options	See list of options for each specific unit; Specify and add accordingly.
	Double Cut DC1 Double Cut	3a Wood Finish	3b Chassis Grain Direction		
		See Double Cut Wood Finish Options	For Double Cut Only: Vertical Horizontal		

Description	D	W	H	CTN WT	CU FT	① Model	HPL Laminate	Flat Cut Veneer	Double Cut Veneer
Rectangular Peninsula Table Desk with Frame Base and Secondary Support End	33½	84	29	149	31	FLT3484PDP	\$2,066		
	33½	84	29	149	31	FLV3484PDP		\$2,720	\$2,993
	33½	78	29	140	28	FLT3478PDP	\$2,030		
	33½	78	29	140	28	FLV3478PDP		\$2,673	\$2,939
	33½	72	29	131	26	FLT3472PDP	\$1,993		
	33½	72	29	131	26	FLV3472PDP		\$2,622	\$2,884
	33½	66	29	122	24	FLT3466PDP	\$1,958		
	33½	66	29	122	24	FLV3466PDP		\$2,574	\$2,833



eased



reverse bevel

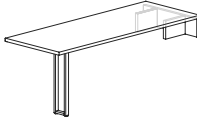
edges

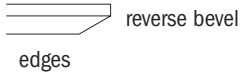
Features:

- peninsula desk mounting included in the list price of the unit, but must be specified when ordering secondary credenza; see pages 18-20 for details
- eased edge profile on approach and user sides

Options:

- must specify support panels grain direction on double cut veneer, see pages 13-15 for details
- on laminate units, contrasting worksurface tops and chassis available, no upcharge; specify color see page 16 for details
- reverse bevel edge available on three sides, specify; add \$429 list for laminate or \$168 list for veneer; see page 8 for details
- 13 ½”h modesty panel available, specify; add \$427 list for laminate or \$594 list for veneer; see page 21 for details
- top grommet available, specify location; add \$128 list each; see page 47 for details
- 12” wide top grommet available, specify location; add \$168 list each; see page 44 for details
- worksurface power available, specify “to accommodate EC26” on your purchase order; EC26 unit must be ordered separately, see page 44
- wire manager tray available see accessory section on pages 50-51 for details

Description	D	W	H	CTN WT	CU FT	① Model	HPL Laminate	Flat Cut Veneer	Double Cut Veneer
Rectangular Peninsula Table Desk with Frame Base and Secondary Support End 	27 1/2	84	29	128	25	FLT2884PDP	\$1,991		
	27 1/2	84	29	128	25	FLV2884PDP		\$2,617	\$2,880
	27 1/2	78	29	122	24	FLT2878PDP	\$1,955		
	27 1/2	78	29	122	24	FLV2878PDP		\$2,571	\$2,828
	27 1/2	72	29	116	22	FLT2872PDP	\$1,920		
	27 1/2	72	29	116	22	FLV2872PDP		\$2,524	\$2,778
	27 1/2	66	29	110	20	FLT2866PDP	\$1,895		
	27 1/2	66	29	110	20	FLV2866PDP		\$2,491	\$2,740



Features:

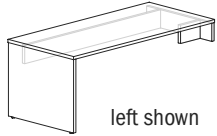
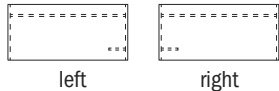
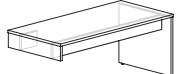
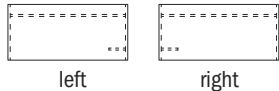
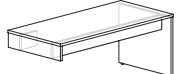
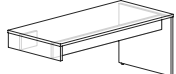
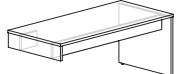
- peninsula desk mounting included in the list price of the unit, but must be specified when ordering secondary credenza; see pages 18-20 for details
- eased edge profile on approach and user sides

Options:

- must specify support panels grain direction on double cut veneer, see pages 13-15 for details
- on laminate units, contrasting worksurface tops and chassis available, no upcharge; specify color see page 16 for details
- reverse bevel edge available on three sides, specify; add \$429 list for laminate or \$168 list for veneer; see page 8 for details
- 13 1/2" h modesty panel available, specify; add \$427 list for laminate or \$594 list for veneer; see page 21 for details
- top grommet available, specify location; add \$128 list each; see page 47 for details
- 12" wide top grommet available, specify location; add \$168 list each; see page 44 for details
- worksurface power available, specify "to accommodate EC26" on your purchase order; EC26 unit must be ordered separately, see page 44
- wire manager tray available see accessory section on pages 50-51 for details

To Order, Specify:

① Laminate Model #	② Laminate Type	③ Laminate Selection		④ Metal Color	⑤ Other Product Options
Laminate (FLT)	HPL	See Laminate Selection		See Metal Finish Color Options	See list of options for each specific unit; Specify and add accordingly.
① Veneer Model #	② Wood Species	③ Wood Finish		④ Metal Color	⑤ Other Product Options
Veneer (FLV)	Flat Cut CH1 Cherry MA1 Maple WA1 Walnut BO1 Black Oak	See Flat Cut Wood Finish Options		See Metal Finish Color Options	See list of options for each specific unit; Specify and add accordingly.
	Double Cut DC1 Double Cut	3a Wood Finish See Double Cut Wood Finish Options	3b Chassis Grain Direction For Double Cut Only: Vertical Horizontal		

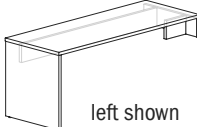

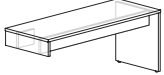
Description	D	W	H	CTN WT	CU FT	① Model	HPL Laminate	Flat Cut Veneer	Double Cut Veneer
Rectangular Peninsula Table	33½	84	29	163	56	FLT3484PDEPR	\$1,445		
Desk with Full Support Panel and Secondary Support End	33½	84	29	163	56	FLV3484PDEPR		\$2,187	\$2,405
	33½	84	29	163	56	FLT3484PDEPL	\$1,445		
	33½	84	29	163	56	FLV3484PDEPL		\$2,187	\$2,405
	33½	78	29	154	52	FLT3478PDEPR	\$1,410		
	33½	78	29	154	52	FLV3478PDEPR		\$2,132	\$2,347
	33½	78	29	154	52	FLT3478PDEPL	\$1,410		
	33½	78	29	154	52	FLV3478PDEPL		\$2,132	\$2,347
	33½	72	29	146	48	FLT3472PDEPR	\$1,374		
	33½	72	29	146	48	FLV3472PDEPR		\$2,079	\$2,289
	33½	72	29	146	48	FLT3472PDEPL	\$1,374		
	33½	72	29	146	48	FLV3472PDEPL		\$2,079	\$2,289
	33½	66	29	158	44	FLT3466PDEPR	\$1,347		
	33½	66	29	158	44	FLV3466PDEPR		\$2,040	\$2,243
	33½	66	29	158	44	FLT3466PDEPL	\$1,347		
	33½	66	29	158	44	FLV3466PDEPL		\$2,040	\$2,243

Features:

- peninsula desk mounting included in the list price of the unit, but must be specified when ordering secondary credenza; see pages 18-20 for details
- eased edge profile on approach and user sides
- 6¾" h modesty with horizontal wire channel

Options:

- must specify support panels grain direction on double cut veneer, see pages 13-15 for details
- on laminate units, contrasting worksurface tops and drawer fronts available, no upcharge; specify laminate color, see page 16 for details
- top grommet available, specify location; add \$128 list each; see page 44 for details
- 12" wide top grommet available, specify location; add \$168 list each; see page 44 for details
- worksurface power available, specify "to accommodate EC26" on your purchase order; EC26 unit must be ordered separately, see page 44
- wire manager tray available see accessory section on pages 50-51 for details

Description	D	W	H	CTN WT	CU FT	① Model	HPL Laminate	Flat Cut Veneer	Double Cut Veneer
Rectangular Peninsula Table	27 1/2	84	29	144	46	FLT2884PDEPR	\$1,195		
Desk with Full Support Panel and Secondary Support End	27 1/2	84	29	144	46	FLV2884PDEPR		\$1,809	\$1,991
	27 1/2	84	29	144	46	FLT2884PDEPL	\$1,195		
 left shown  left right  approach - left	27 1/2	84	29	144	46	FLV2884PDEPL		\$1,809	\$1,991
	27 1/2	78	29	137	43	FLT2878PDEPR	\$1,166		
	27 1/2	78	29	137	43	FLV2878PDEPR		\$1,765	\$1,941
	27 1/2	78	29	137	43	FLT2878PDEPL	\$1,166		
	27 1/2	78	29	137	43	FLV2878PDEPL		\$1,765	\$1,941
	27 1/2	72	29	130	40	FLT2872PDEPR	\$1,138		
	27 1/2	72	29	130	40	FLV2872PDEPR		\$1,722	\$1,895
	27 1/2	72	29	130	40	FLT2872PDEPL	\$1,138		
	27 1/2	72	29	130	40	FLV2872PDEPL		\$1,722	\$1,895
	27 1/2	66	29	123	37	FLT2866PDEPR	\$1,116		
	27 1/2	66	29	123	37	FLV2866PDEPR		\$1,688	\$1,856
	27 1/2	66	29	123	37	FLT2866PDEPL	\$1,116		
	27 1/2	66	29	123	37	FLV2866PDEPL		\$1,688	\$1,856

Features:

- peninsula desk mounting included in the list price of the unit, but must be specified when ordering secondary credenza; see pages 18-20 for details
- eased edge profile on approach and user sides
- 6 3/4" h modesty with horizontal wire channel

Options:

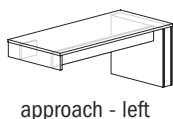
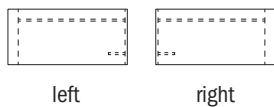
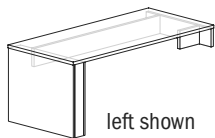
- must specify support panels grain direction on double cut veneer, see pages 13-15 for details
- on laminate units, contrasting worksurface tops and drawer fronts available, no upcharge; specify laminate color, see page 16 for details
- top grommet available, specify location; add \$128 list each; see page 44 for details
- 12" wide top grommet available, specify location; add \$168 list each; see page 44 for details
- worksurface power available, specify "to accommodate EC26" on your purchase order; EC26 unit must be ordered separately, see page 44
- wire manager tray available see accessory section on pages 50-51 for details

To Order, Specify:

① Laminate Model #	② Laminate Type	③ Laminate Selection	④ Metal Color	⑤ Other Product Options
Laminate (FLT)	HPL	See Laminate Selection	See Metal Finish Color Options	See list of options for each specific unit; Specify and add accordingly.

① Veneer Model #	② Wood Species	③ Wood Finish	④ Metal Color	⑤ Other Product Options
Veneer (FLV)	Flat Cut CH1 Cherry MA1 Maple WA1 Walnut BO1 Black Oak	See Flat Cut Wood Finish Options	See Metal Finish Color Options	See list of options for each specific unit; Specify and add accordingly.
	Double Cut DC1 Double Cut	③a Wood Finish See Double Cut Wood Finish Options ③b Chassis Grain Direction For Double Cut Only: Vertical Horizontal		

Description	D	W	H	CTN WT	CU FT	① Model	HPL Laminate	Flat Cut Veneer	Double Cut Veneer
Rectangular Peninsula Table Desk with 6" w Full Support Panel and Secondary Support End	33½	84	29	189	56	FLT3484DTEPR	\$1,941		
	33½	84	29	189	56	FLV3484DTEPR		\$2,939	\$3,233
	33½	84	29	189	56	FLT3484DTEPL	\$1,941		
	33½	84	29	189	56	FLV3484DTEPL		\$2,939	\$3,233
	33½	78	29	181	52	FLT3478DTEPR	\$1,893		
	33½	78	29	181	52	FLV3478DTEPR		\$2,868	\$3,154
	33½	78	29	181	52	FLT3478DTEPL	\$1,893		
	33½	78	29	181	52	FLV3478DTEPL		\$2,868	\$3,154
	33½	72	29	173	48	FLT3472DTEPR	\$1,849		
	33½	72	29	173	48	FLV3472DTEPR		\$2,798	\$3,078
	33½	72	29	173	48	FLT3472DTEPL	\$1,849		
	33½	72	29	173	48	FLV3472DTEPL		\$2,798	\$3,078
	33½	66	29	165	44	FLT3466DTEPR	\$1,810		
	33½	66	29	165	44	FLV3466DTEPR		\$2,743	\$3,016
	33½	66	29	165	44	FLT3466DTEPL	\$1,810		
33½	66	29	165	44	FLV3466DTEPL		\$2,743	\$3,016	



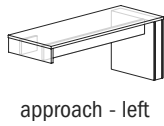
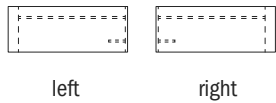
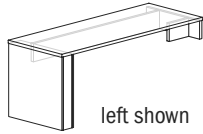
Features:

- peninsula desk mounting included in the list price of the unit, but must be specified when ordering secondary credenza; see pages 18-20 for details
- eased edge profile on approach and user sides
- 6¾" h modesty with horizontal wire channel

Options:

- must specify support panels grain direction on double cut veneer, see pages 13-15 for details
- on laminate units, contrasting worksurface tops and drawer fronts available, no upcharge; specify laminate color, see page 16 for details
- top grommet available, specify location; add \$128 list each; see page 44 for details
- 12" wide top grommet available, specify location; add \$168 list each; see page 44 for details
- worksurface power available, specify "to accommodate EC26" on your purchase order; EC26 unit must be ordered separately, see page 44
- wire manager tray available see accessory section on pages 50-51 for details

Description	D	W	H	CTN WT	CU FT	① Model	HPL Laminate	Flat Cut Veneer	Double Cut Veneer
Rectangular Peninsula Table Desk with 6" Full Support Panel and Secondary Support End	27 1/2	84	29	162	46	FLT2884DTEPR	\$1,675		
	27 1/2	84	29	162	46	FLV2884DTEPR		\$2,539	\$2,793
	27 1/2	84	29	162	46	FLT2884DTEPL	\$1,675		
	27 1/2	84	29	162	46	FLV2884DTEPL		\$2,539	\$2,793
	27 1/2	78	29	155	43	FLT2878DTEPR	\$1,634		
	27 1/2	78	29	155	43	FLV2878DTEPR		\$2,478	\$2,724
	27 1/2	78	29	155	43	FLT2878DTEPL	\$1,634		
	27 1/2	78	29	155	43	FLV2878DTEPL		\$2,478	\$2,724
	27 1/2	72	29	148	40	FLT2872DTEPR	\$1,597		
	27 1/2	72	29	148	40	FLV2872DTEPR		\$2,417	\$2,657
	27 1/2	72	29	148	40	FLT2872DTEPL	\$1,597		
	27 1/2	72	29	148	40	FLV2872DTEPL		\$2,417	\$2,657
	27 1/2	66	29	141	37	FLT2866DTEPR	\$1,564		
	27 1/2	66	29	141	37	FLV2866DTEPR		\$2,368	\$2,606
	27 1/2	66	29	141	37	FLT2866DTEPL	\$1,564		
	27 1/2	66	29	141	37	FLV2866DTEPL		\$2,368	\$2,606



Features:

- peninsula desk mounting included in the list price of the unit, but must be specified when ordering secondary credenza; see pages 18-20 for details
- eased edge profile on approach and user sides
- 6 3/4" h modesty with horizontal wire channel

Options:

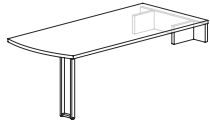
- must specify support panels grain direction on double cut veneer, see pages 13-15 for details
- on laminate units, contrasting worksurface tops and drawer fronts available, no upcharge; specify laminate color, see page 16 for details
- top grommet available, specify location; add \$128 list each; see page 44 for details
- 12" wide top grommet available, specify location; add \$168 list each; see page 44 for details
- worksurface power available, specify "to accommodate EC26" on your purchase order; EC26 unit must be ordered separately, see page 44
- wire manager tray available see accessory section on pages 50-51 for details

To Order, Specify:

① Laminate Model #	② Laminate Type	③ Laminate Selection	④ Metal Color	⑤ Other Product Options
Laminate (FLT)	HPL	See Laminate Selection	See Metal Finish Color Options	See list of options for each specific unit; Specify and add accordingly.

① Veneer Model #	② Wood Species	③ Wood Finish	④ Metal Color	⑤ Other Product Options
Veneer (FLV)	Flat Cut CH1 Cherry MA1 Maple WA1 Walnut BO1 Black Oak	See Flat Cut Wood Finish Options	See Metal Finish Color Options	See list of options for each specific unit; Specify and add accordingly.
		<table border="1"> <thead> <tr> <th>ⓐ Wood Finish</th> <th>ⓑ Chassis Grain Direction</th> </tr> </thead> <tbody> <tr> <td>See Double Cut Wood Finish Options</td> <td>For Double Cut Only: Vertical Horizontal</td> </tr> </tbody> </table>		
ⓐ Wood Finish	ⓑ Chassis Grain Direction			
See Double Cut Wood Finish Options	For Double Cut Only: Vertical Horizontal			

Description	D	W	H	CTN WT	CU FT	① Model	HPL Laminate	Flat Cut Veneer	Double Cut Veneer
Arc Peninsula Table Desk with Frame Base and Secondary Support End	33½	84	29	149	31	FLT3484PARCP	\$2,243		
	33½	84	29	149	31	FLV3484PARCP		\$2,963	\$3,258
	33½	78	29	140	28	FLT3478PARCP	\$2,195		
	33½	78	29	140	28	FLV3478PARCP		\$2,894	\$3,183
	33½	72	29	131	26	FLT3472PARCP	\$2,146		
	33½	72	29	131	26	FLV3472PARCP		\$2,828	\$3,112
	33½	66	29	122	24	FLT3466PARCP	\$2,126		
	33½	66	29	122	24	FLV3466PARCP		\$2,802	\$3,083



eased



reverse bevel

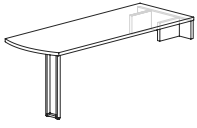

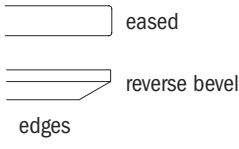
edges

Features:

- peninsula desk mounting included in the list price of the unit, but must be specified when ordering secondary credenza; see pages 18-20 for details
- eased edge profile on approach and user sides

Options:

- must specify support panels grain direction on double cut veneer, see pages 13-15 for details
- on laminate units, contrasting worksurface tops and chassis available, no upcharge; specify color see page 16 for details
- reverse bevel edge available on three sides, specify; add \$429 list for laminate or \$168 list for veneer; see page 8 for details
- 13 ½”h modesty panel available, specify; add \$427 list for laminate or \$594 list for veneer; see page 21 for details
- top grommet available, specify location; add \$128 list each; see page 47 for details
- 12” wide top grommet available, specify location; add \$168 list each; see page 44 for details
- worksurface power available, specify “to accommodate EC26” on your purchase order; EC26 unit must be ordered separately, see page 44
- wire manager tray available see accessory section on pages 50-51 for details

Description	D	W	H	CTN WT	CU FT	① Model	HPL Laminate	Flat Cut Veneer	Double Cut Veneer
Arc Peninsula Table Desk with Frame Base and Secondary Support End   	27 1/2	84	29	128	25	FLT2884PARCP	\$2,168		
	27 1/2	84	29	128	25	FLV2884PARCP		\$2,859	\$3,143
	27 1/2	78	29	122	24	FLT2878PARCP	\$2,120		
	27 1/2	78	29	122	24	FLV2878PARCP		\$2,795	\$3,074
	27 1/2	72	29	116	22	FLT2872PARCP	\$2,072		
	27 1/2	72	29	116	22	FLV2872PARCP		\$2,730	\$3,005
	27 1/2	66	29	110	20	FLT2866PARCP	\$2,055		
	27 1/2	66	29	110	20	FLV2866PARCP		\$2,705	\$2,976

Features:

- peninsula desk mounting included in the list price of the unit, but must be specified when ordering secondary credenza; see pages 18-20 for details
- eased edge profile on approach and user sides

Options:

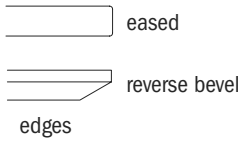
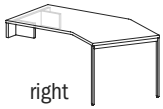
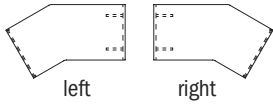
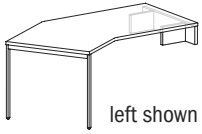
- must specify support panels grain direction on double cut veneer, see pages 13-15 for details
- on laminate units, contrasting worksurface tops and chassis available, no upcharge; specify color see page 16 for details
- reverse bevel edge available on three sides, specify; add \$429 list for laminate or \$168 list for veneer; see page 8 for details
- 13 1/2" h modesty panel available, specify; add \$427 list for laminate or \$594 list for veneer; see page 21 for details
- top grommet available, specify location; add \$128 list each; see page 47 for details
- 12" wide top grommet available, specify location; add \$168 list each; see page 44 for details
- worksurface power available, specify "to accommodate EC26" on your purchase order; EC26 unit must be ordered separately, see page 44
- wire manager tray available see accessory section on pages 50-51 for details

To Order, Specify:

① Laminate Model #	② Laminate Type	③ Laminate Selection		④ Metal Color	⑤ Other Product Options
Laminate (FLT)	HPL	See Laminate Selection		See Metal Finish Color Options	See list of options for each specific unit; Specify and add accordingly.

① Veneer Model #	② Wood Species	③ Wood Finish		④ Metal Color	⑤ Other Product Options
Veneer (FLV)	Flat Cut CH1 Cherry MA1 Maple WA1 Walnut BO1 Black Oak	See Flat Cut Wood Finish Options		See Metal Finish Color Options	See list of options for each specific unit; Specify and add accordingly.
		ⓐ Wood Finish	ⓑ Chassis Grain Direction		
	Double Cut DC1 Double Cut	See Double Cut Wood Finish Options	For Double Cut Only: Vertical Horizontal		

Description	D	W	H	CTN WT	CU FT	① Model	HPL Laminate	Flat Cut Veneer	Double Cut Veneer
Boomerang Peninsula Table Desk with End Leg Assembly and Secondary Support End	33½	84	29	149	31	FLT3484PBMNR	\$2,687		
	33½	84	29	149	31	FLV3484PBMNR		\$3,629	\$3,992
	33½	84	29	149	31	FLT3484PBMNL	\$2,687		
	33½	84	29	149	31	FLV3484PBMNL		\$3,629	\$3,992
	33½	78	29	140	28	FLT3478PBMNR	\$2,621		
	33½	78	29	140	28	FLV3478PBMNR		\$3,541	\$3,894
	33½	78	29	140	28	FLT3478PBMNL	\$2,621		
	33½	78	29	140	28	FLV3478PBMNL		\$3,541	\$3,894
	33½	72	29	131	26	FLT3472PBMNR	\$2,559		
	33½	72	29	131	26	FLV3472PBMNR		\$3,455	\$3,801
	33½	72	29	131	26	FLT3472PBMNL	\$2,559		
	33½	72	29	131	26	FLV3472PBMNL		\$3,455	\$3,801
	33½	66	29	122	24	FLT3466PBMNR	\$2,519		
	33½	66	29	122	24	FLV3466PBMNR		\$3,402	\$3,744
	33½	66	29	122	24	FLT3466PBMNL	\$2,519		
	33½	66	29	122	24	FLV3466PBMNL		\$3,402	\$3,744



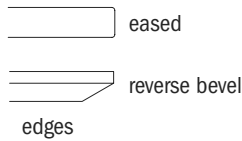
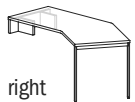
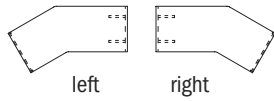
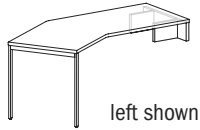
Features:

- peninsula desk mounting included in the list price of the unit, but must be specified when ordering secondary credenza; see pages 18-20 for details
- eased edge profile on approach and user sides

Options:

- must specify support panels grain direction on double cut veneer, see pages 13-15 for details
- on laminate units, contrasting worksurface tops and chassis available, no upcharge; specify color see page 16 for details
- reverse bevel edge available on three sides, specify; add \$429 list for laminate or \$168 list for veneer; see page 8 for details
- 13½" h modesty panel available for 84" w and 78" w desk, specify; add \$427 list for laminate or \$594 list for veneer; see page 21 for details
- top grommet available, specify location; add \$128 list each; see page 44 for details
- 12" wide top grommet available, specify location; add \$168 list each; see page 44 for details
- worksurface power available, specify "to accommodate EC26" on your purchase order; EC26 unit must be ordered separately, see page 44
- wire manager tray available see accessory section on pages 50-51 for details

Description	D	W	H	CTN WT	CU FT	① Model	HPL Laminate	Flat Cut Veneer	Double Cut Veneer
Boomerang Peninsula Table	27 1/2	84	29	128	25	FLT2884PBMNR	\$2,630		
Desk with End Leg Assembly and Secondary Support End	27 1/2	84	29	128	25	FLV2884PBMNR		\$3,552	\$3,906
	27 1/2	84	29	128	25	FLT2884PBMNL	\$2,630		
	27 1/2	84	29	128	25	FLV2884PBMNL		\$3,552	\$3,906
	27 1/2	78	29	122	24	FLT2878PBMNR	\$2,565		
	27 1/2	78	29	122	24	FLV2878PBMNR		\$3,464	\$3,812
	27 1/2	78	29	122	24	FLT2878PBMNL	\$2,565		
	27 1/2	78	29	122	24	FLV2878PBMNL		\$3,464	\$3,812
	27 1/2	72	29	116	22	FLT2872PBMNR	\$2,501		
	27 1/2	72	29	116	22	FLV2872PBMNR		\$3,380	\$3,718
	27 1/2	72	29	116	22	FLT2872PBMNL	\$2,501		
	27 1/2	72	29	116	22	FLV2872PBMNL		\$3,380	\$3,718
	27 1/2	66	29	110	20	FLT2866PBMNR	\$1,824		
	27 1/2	66	29	110	20	FLV2866PBMNR		\$2,465	\$2,713
	27 1/2	66	29	110	20	FLT2866PBMNL	\$1,824		
	27 1/2	66	29	110	20	FLV2866PBMNL		\$2,465	\$2,713



Features:

- peninsula desk mounting included in the list price of the unit, but must be specified when ordering secondary credenza; see pages 18-20 for details
- eased edge profile on approach and user sides



Options:

- must specify support panels grain direction on double cut veneer, see pages 13-15 for details
- on laminate units, contrasting worksurface tops and chassis available, no upcharge; specify color see page 16 for details
- reverse bevel edge available on three sides, specify; add \$429 list for laminate or \$168 list for veneer; see page 8 for details
- 13 1/2" h modesty panel available for 84" w and 78" w desk, specify; add \$427 list for laminate or \$594 list for veneer; see page 21 for details
- top grommet available, specify location; add \$128 list each; see page 44 for details
- 12" wide top grommet available, specify location; add \$168 list each; see page 44 for details
- worksurface power available, specify "to accommodate EC26" on your purchase order; EC26 unit must be ordered separately, see page 44
- wire manager tray available see accessory section on pages 50-51 for details

To Order, Specify:

① Laminate Model #	② Laminate Type	③ Laminate Selection	④ Metal Color	⑤ Other Product Options
Laminate (FLT)	HPL	See Laminate Selection	See Metal Finish Color Options	See list of options for each specific unit; Specify and add accordingly.

① Veneer Model #	② Wood Species	③ Wood Finish	④ Metal Color	⑤ Other Product Options
Veneer (FLV)	Flat Cut CH1 Cherry MA1 Maple WA1 Walnut BO1 Black Oak	See Flat Cut Wood Finish Options	See Metal Finish Color Options	See list of options for each specific unit; Specify and add accordingly.
		③a Wood Finish See Double Cut Wood Finish Options		

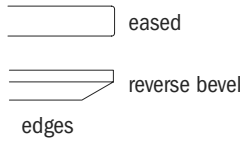
Description	D	W	H	CTN WT	CU FT	① Model	HPL Laminate	Flat Cut Veneer	Double Cut Veneer
Rectangular Run-off Desk with End Leg Assembly  	33½	72	29	119	22	FLT3472RRTN	\$1,639		
	33½	72	29	119	22	FLV3472RRTN		\$2,145	\$2,360
	33½	66	29	112	20	FLT3466RRTN	\$1,604		
	33½	66	29	112	20	FLV3466RRTN		\$2,098	\$2,307
	33½	60	29	105	18	FLT3460RRTN	\$1,569		
	33½	60	29	105	18	FLV3460RRTN		\$2,052	\$2,258
	33½	54	29	98	17	FLT3454RRTN	\$1,537		
	33½	54	29	98	17	FLV3454RRTN		\$2,004	\$2,205
	33½	48	29	91	16	FLT3448RRTN	\$1,516		
	33½	48	29	91	16	FLV3448RRTN		\$1,980	\$2,178



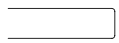
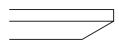
Features:

- mounts perpendicular to primary height units
- eased edge profile on approach and user sides
- laminate tops wider than 60" are long grain

Options:

- reverse bevel edge available on three sides, specify; add \$429 list for laminate or \$168 list for veneer; see page 8 for details
- 13 ½" h modesty panel available, specify; add \$427 list for laminate or \$594 list for veneer; see page 21 for details
- top grommet available, specify location; add \$128 list each; see page 45 for details
- 12" wide top grommet available, specify location; add \$168 list each; see page 45 for details
- worksurface power available, specify "to accommodate EC26" on your purchase order; EC26 unit must be ordered separately, see page 45
- wire manager tray available see accessory section on pages 50-51 for details



Description	D	W	H	CTN WT	CU FT	① Model	HPL Laminate	Flat Cut Veneer	Double Cut Veneer
Rectangular Run-off Desk with End Leg Assembly    eased  reverse bevel edges	27 1/2	72	29	101	18	FLT2872RRTN	\$1,618		
	27 1/2	72	29	101	18	FLV2872RRTN		\$2,114	\$2,326
	27 1/2	66	29	94	17	FLT2866RRTN	\$1,582		
	27 1/2	66	29	94	17	FLV2866RRTN		\$2,067	\$2,274
	27 1/2	60	29	87	15	FLT2860RRTN	\$1,548		
	27 1/2	60	29	87	15	FLV2860RRTN		\$2,021	\$2,223
	27 1/2	54	29	80	14	FLT2854RRTN	\$1,515		
	27 1/2	54	29	80	14	FLV2854RRTN		\$1,978	\$2,175
	27 1/2	48	29	80	13	FLT2848RRTN	\$1,495		
	27 1/2	48	29	80	13	FLV2848RRTN		\$1,951	\$2,146

Features:

- mounts perpendicular to primary height units
- eased edge profile on approach and user sides
- laminate tops wider than 60" are long grain

Options:

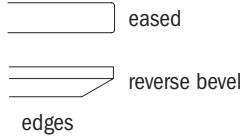
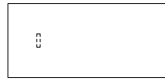
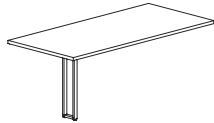
- reverse bevel edge available on three sides, specify; add \$429 list for laminate or \$168 list for veneer; see page 8 for details
- 13 1/2" h modesty panel available, specify; add \$427 list for laminate or \$594 list for veneer; see page 21 for details
- top grommet available, specify location; add \$128 list each; see page 45 for details
- 12" wide top grommet available, specify location; add \$168 list each; see page 45 for details
- worksurface power available, specify "to accommodate EC26" on your purchase order; EC26 unit must be ordered separately, see page 45
- wire manager tray available see accessory section on pages 50-51 for details

To Order, Specify:

① Laminate Model #	② Laminate Type	③ Laminate Selection	④ Metal Color	⑤ Other Product Options
Laminate (FLT)	HPL	See Laminate Selection	See Metal Finish Color Options	See list of options for each specific unit; Specify and add accordingly.

① Veneer Model #	② Wood Species	③ Wood Finish	④ Metal Color	⑤ Other Product Options
Veneer (FLV)	Flat Cut CH1 Cherry MA1 Maple WA1 Walnut BO1 Black Oak	See Flat Cut Wood Finish Options	See Metal Finish Color Options	See list of options for each specific unit; Specify and add accordingly.
	Double Cut DC1 Double Cut	See Double Cut Wood Finish Options ③b Chassis Grain Direction For Double Cut Only: Vertical Horizontal		

Description	D	W	H	CTN WT	CU FT	① Model	HPL Laminate	Flat Cut Veneer	Double Cut Veneer
Rectangular Run-off Desk with Frame Base	33½	72	29	119	22	FLT3472RRTP	\$1,639		
	33½	72	29	119	22	FLV3472RRTP		\$2,145	\$2,360
	33½	66	29	112	20	FLT3466RRTP	\$1,604		
	33½	66	29	112	20	FLV3466RRTP		\$2,098	\$2,307
	33½	60	29	105	18	FLT3460RRTP	\$1,569		
	33½	60	29	105	18	FLV3460RRTP		\$2,052	\$2,258
	33½	54	29	98	17	FLT3454RRTP	\$1,537		
	33½	54	29	98	17	FLV3454RRTP		\$2,004	\$2,205
	33½	48	29	91	16	FLT3448RRTP	\$1,516		
	33½	48	29	91	16	FLV3448RRTP		\$1,980	\$2,178



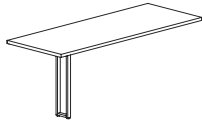
Features:

- mounts perpendicular to primary height units
- eased edge profile on approach and user sides
- laminate tops wider than 60" are long grain

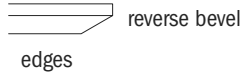
Options:

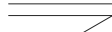
- reverse bevel edge available on three sides, specify; add \$429 list for laminate or \$168 list for veneer; see page 8 for details
- 13 ½" h modesty panel available, specify; add \$427 list for laminate or \$594 list for veneer; see page 21 for details
- top grommet available, specify location; add \$128 list each; see page 45 for details
- 12" wide top grommet available, specify location; add \$168 list each; see page 45 for details
- worksurface power available, specify "to accommodate EC26" on your purchase order; EC26 unit must be ordered separately, see page 45
- wire manager tray available see accessory section on pages 50-51 for details

Description	D	W	H	CTN WT	CU FT	① Model	HPL Laminate	Flat Cut Veneer	Double Cut Veneer
Rectangular Run-off Desk with Frame Base	27 1/2	72	29	101	18	FLT2872RRTP	\$1,618		
	27 1/2	72	29	101	18	FLV2872RRTP		\$2,114	\$2,326
	27 1/2	66	29	94	17	FLT2866RRTP	\$1,582		
	27 1/2	66	29	94	17	FLV2866RRTP		\$2,067	\$2,274
	27 1/2	60	29	87	15	FLT2860RRTP	\$1,548		
	27 1/2	60	29	87	15	FLV2860RRTP		\$2,021	\$2,223
	27 1/2	54	29	80	14	FLT2854RRTP	\$1,515		
	27 1/2	54	29	80	14	FLV2854RRTP		\$1,978	\$2,175
	27 1/2	48	29	80	13	FLT2848RRTP	\$1,495		
	27 1/2	48	29	80	13	FLV2848RRTP		\$1,951	\$2,146



 eased



 reverse bevel
edges

Features:

- mounts perpendicular to primary height units
- eased edge profile on approach and user sides
- laminate tops wider than 60" are long grain

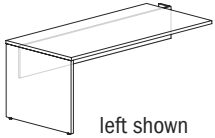
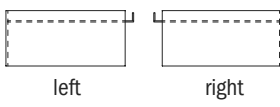
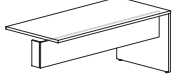
Options:

- reverse bevel edge available on three sides, specify; add \$429 list for laminate or \$168 list for veneer; see page 8 for details
- 13 1/2" h modesty panel available, specify; add \$427 list for laminate or \$594 list for veneer; see page 21 for details
- top grommet available, specify location; add \$128 list each; see page 45 for details
- 12" wide top grommet available, specify location; add \$168 list each; see page 45 for details
- worksurface power available, specify "to accommodate EC26" on your purchase order; EC26 unit must be ordered separately, see page 45
- wire manager tray available see accessory section on pages 50-51 for details

To Order, Specify:

① Laminate Model #	② Laminate Type	③ Laminate Selection	④ Metal Color	⑤ Other Product Options
Laminate (FLT)	HPL	See Laminate Selection	See Metal Finish Color Options	See list of options for each specific unit; Specify and add accordingly.

① Veneer Model #	② Wood Species	③ Wood Finish	④ Metal Color	⑤ Other Product Options	
Veneer (FLV)	Flat Cut CH1 Cherry MA1 Maple WA1 Walnut BO1 Black Oak	See Flat Cut Wood Finish Options	See Metal Finish Color Options	See list of options for each specific unit; Specify and add accordingly.	
	Double Cut DC1 Double Cut	<table border="1"> <thead> <tr> <th>ⓐ Wood Finish</th> <th>ⓑ Chassis Grain Direction</th> </tr> </thead> <tbody> <tr> <td>See Double Cut Wood Finish Options</td> <td>For Double Cut Only: Vertical Horizontal</td> </tr> </tbody> </table>			ⓐ Wood Finish
ⓐ Wood Finish	ⓑ Chassis Grain Direction				
See Double Cut Wood Finish Options	For Double Cut Only: Vertical Horizontal				

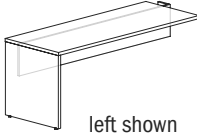
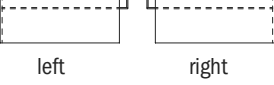
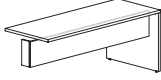
Description	D	W	H	CTN WT	CU FT	① Model	HPL Laminate	Flat Cut Veneer	Double Cut Veneer
 <p>left shown</p>  <p>left right</p>  <p>approach - left</p>	33½	72	29	141	48	FLT3472RDEPR	\$1,364		
	33½	72	29	141	48	FLV3472RDEPR		\$2,064	\$2,270
	33½	72	29	141	48	FLT3472RDEPL	\$1,364		
	33½	72	29	141	48	FLV3472RDEPL		\$2,064	\$2,270
	33½	66	29	130	44	FLT3466RDEPR	\$1,337		
	33½	66	29	130	44	FLV3466RDEPR		\$2,022	\$2,226
	33½	66	29	130	44	FLT3466RDEPL	\$1,337		
	33½	66	29	130	44	FLV3466RDEPL		\$2,022	\$2,226
	33½	60	29	119	40	FLT3460RDEPR	\$1,308		
	33½	60	29	119	40	FLV3460RDEPR		\$1,982	\$2,180
	33½	60	29	119	40	FLT3460RDEPL	\$1,308		
	33½	60	29	119	40	FLV3460RDEPL		\$1,982	\$2,180
	33½	54	29	108	36	FLT3454RDEPR	\$1,285		
	33½	54	29	108	36	FLV3454RDEPR		\$1,942	\$2,136
	33½	54	29	108	36	FLT3454RDEPL	\$1,285		
	33½	54	29	108	36	FLV3454RDEPL		\$1,942	\$2,136

Features:

- to be used with open corner primary height credenzas; see page 19
- mounts perpendicular to primary height units
- eased edge profile on approach and user sides
- laminate tops wider than 60" are long grain
- 6¾" h modesty with horizontal wire channel

Options:

- must specify support panels grain direction on double cut veneer, see pages 13-15 for details
- on laminate units, contrasting worksurface tops and chassis available, no upcharge; specify color, see page 16 for details
- top grommet available, specify location; add \$128 list each; see page 45 for details
- 12" wide top grommet available, specify location; add \$168 list each; see page 45 for details
- worksurface power available, specify "to accommodate EC26" on your purchase order; EC26 unit must be ordered separately, see page 45
- wire manager tray available see accessory section on pages 50-51 for details

Description	D	W	H	CTN WT	CU FT	① Model	HPL Laminate	Flat Cut Veneer	Double Cut Veneer
 left shown  left right  approach - left	27 1/2	72	29	120	40	FLT2872RDEPR	\$1,125		
	27 1/2	72	29	120	40	FLV2872RDEPR		\$1,705	\$1,876
	27 1/2	72	29	120	40	FLT2872RDEPL	\$1,125		
	27 1/2	72	29	120	40	FLV2872RDEPL		\$1,705	\$1,876
	27 1/2	66	29	111	37	FLT2866RDEPR	\$1,104		
	27 1/2	66	29	111	37	FLV2866RDEPR		\$1,671	\$1,840
	27 1/2	66	29	111	37	FLT2866RDEPL	\$1,104		
	27 1/2	66	29	111	37	FLV2866RDEPL		\$1,671	\$1,840
	27 1/2	60	29	102	34	FLT2860RDEPR	\$1,082		
	27 1/2	60	29	102	34	FLV2860RDEPR		\$1,636	\$1,802
	27 1/2	60	29	102	34	FLT2860RDEPL	\$1,082		
	27 1/2	60	29	102	34	FLV2860RDEPL		\$1,636	\$1,802
	27 1/2	54	29	93	30	FLT2854RDEPR	\$1,061		
	27 1/2	54	29	93	30	FLV2854RDEPR		\$1,604	\$1,766
	27 1/2	54	29	93	30	FLT2854RDEPL	\$1,061		
	27 1/2	54	29	93	30	FLV2854RDEPL		\$1,604	\$1,766

Features:

- to be used with open corner primary height credenzas; see page 19
- mounts perpendicular to primary height units
- eased edge profile on approach and user sides
- laminate tops wider than 60" are long grain
- 6 3/4" h modesty with horizontal wire channel

Options:

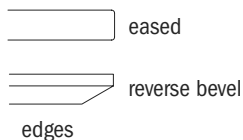
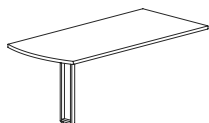
- must specify support panels grain direction on double cut veneer, see pages 13-15 for details
- on laminate units, contrasting worksurface tops and chassis available, no upcharge; specify color, see page 16 for details
- top grommet available, specify location; add \$128 list each; see page 45 for details
- 12" wide top grommet available, specify location; add \$168 list each; see page 45 for details
- worksurface power available, specify "to accommodate EC26" on your purchase order; EC26 unit must be ordered separately, see page 45
- wire manager tray available see accessory section on pages 50-51 for details

To Order, Specify:

① Laminate Model #	② Laminate Type	③ Laminate Selection		④ Metal Color	⑤ Other Product Options
Laminate (FLT)	HPL	See Laminate Selection		See Metal Finish Color Options	See list of options for each specific unit; Specify and add accordingly.

① Veneer Model #	② Wood Species	③ Wood Finish		④ Metal Color	⑤ Other Product Options
Veneer (FLV)	Flat Cut CH1 Cherry MA1 Maple WA1 Walnut BO1 Black Oak	See Flat Cut Wood Finish Options		See Metal Finish Color Options	See list of options for each specific unit; Specify and add accordingly.
		ⓐ Wood Finish	ⓑ Chassis Grain Direction		
	Double Cut DC1 Double Cut	See Double Cut Wood Finish Options	For Double Cut Only: Vertical Horizontal		

Description	D	W	H	CTN WT	CU FT	① Model	HPL Laminate	Flat Cut Veneer	Double Cut Veneer
Arc End Run-off Desk with Frame Base	33½	72	29	119	22	FLT3472ARCTP	\$1,799		
	33½	72	29	119	22	FLV3472ARCTP		\$2,362	\$2,598
	33½	66	29	112	20	FLT3466ARCTP	\$1,760		
	33½	66	29	112	20	FLV3466ARCTP		\$2,310	\$2,540
	33½	60	29	105	18	FLT3460ARCTP	\$1,722		
	33½	60	29	105	18	FLV3460ARCTP		\$2,258	\$2,482
	33½	54	29	98	17	FLT3454ARCTP	\$1,700		
	33½	54	29	98	17	FLV3454ARCTP		\$2,227	\$2,450
	33½	48	29	91	16	FLT3448ARCTP	\$1,677		
	33½	48	29	91	16	FLV3448ARCTP		\$2,197	\$2,417

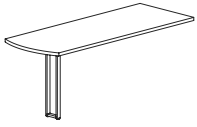





Features:

- mounts perpendicular to primary height units
- eased edge profile on approach and user sides
- laminate tops wider than 60" are long grain

Options:

- reverse bevel edge available on three sides, specify; add \$429 list for laminate or \$168 list for veneer; see page 8 for details
- 13 ½" h modesty panel available, specify; add \$427 list for laminate or \$594 list for veneer; see page 21 for details
- top grommet available, specify location; add \$128 list each; see page 45 for details
- 12" wide top grommet available, specify location; add \$168 list each; see page 45 for details
- worksurface power available, specify "to accommodate EC26" on your purchase order; EC26 unit must be ordered separately, see page 45
- wire manager tray available see accessory section on pages 50-51 for details

Description	D	W	H	CTN WT	CU FT	① Model	HPL Laminate	Flat Cut Veneer	Double Cut Veneer
Arc End Run-off Desk with Frame Base    eased  reverse bevel edges	27 1/2	72	29	101	18	FLT2872ARCTP	\$1,755		
	27 1/2	72	29	101	18	FLV2872ARCTP		\$2,303	\$2,531
	27 1/2	66	29	94	17	FLT2866ARCTP	\$1,716		
	27 1/2	66	29	94	17	FLV2866ARCTP		\$2,251	\$2,477
	27 1/2	60	29	87	15	FLT2860ARCTP	\$1,679		
	27 1/2	60	29	87	15	FLV2860ARCTP		\$2,200	\$2,421
	27 1/2	54	29	80	14	FLT2854ARCTP	\$1,644		
	27 1/2	54	29	80	14	FLV2854ARCTP		\$2,151	\$2,367
	27 1/2	48	29	80	13	FLT2848ARCTP	\$1,623		
	27 1/2	48	29	80	13	FLV2848ARCTP		\$2,124	\$2,334

Features:

- mounts perpendicular to primary height units
- eased edge profile on approach and user sides
- laminate tops wider than 60" are long grain

Options:

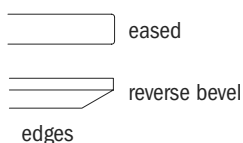
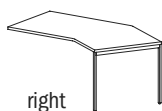
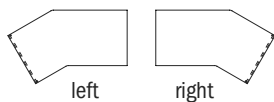
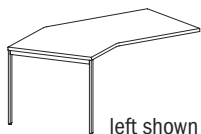
- reverse bevel edge available on three sides, specify; add \$429 list for laminate or \$168 list for veneer; see page 8 for details
- 13 1/2" h modesty panel available, specify; add \$427 list for laminate or \$594 list for veneer; see page 21 for details
- top grommet available, specify location; add \$128 list each; see page 45 for details
- 12" wide top grommet available, specify location; add \$168 list each; see page 45 for details
- worksurface power available, specify "to accommodate EC26" on your purchase order; EC26 unit must be ordered separately, see page 45
- wire manager tray available see accessory section on pages 50-51 for details

To Order, Specify:

① Laminate Model #	② Laminate Type	③ Laminate Selection	④ Metal Color	⑤ Other Product Options
Laminate (FLT)	HPL	See Laminate Selection	See Metal Finish Color Options	See list of options for each specific unit; Specify and add accordingly.

① Veneer Model #	② Wood Species	③ Wood Finish	④ Metal Color	⑤ Other Product Options
Veneer (FLV)	Flat Cut CH1 Cherry MA1 Maple WA1 Walnut BO1 Black Oak	See Flat Cut Wood Finish Options	See Metal Finish Color Options	See list of options for each specific unit; Specify and add accordingly.
		③a Wood Finish See Double Cut Wood Finish Options		

Description	D	W	H	CTN WT	CU FT	① Model	HPL Laminate	Flat Cut Veneer	Double Cut Veneer
Boomerang Run-off Desk with End Leg Assembly	33½	72	29	119	22	FLT3472BMTNR	\$2,400		
	33½	72	29	119	22	FLV3472BMTNR		\$3,173	\$3,491
	33½	72	29	119	22	FLT3472BMTNL	\$2,400		
	33½	72	29	119	22	FLV3472BMTNL		\$3,173	\$3,491
	33½	66	29	112	20	FLT3466BMTNR	\$2,356		
	33½	66	29	112	20	FLV3466BMTNR		\$3,115	\$3,426
	33½	66	29	112	20	FLT3466BMTNL	\$2,356		
	33½	66	29	112	20	FLV3466BMTNL		\$3,115	\$3,426
	33½	60	29	105	18	FLT3460BMTNR	\$2,313		
	33½	60	29	105	18	FLV3460BMTNR		\$3,056	\$3,361
	33½	60	29	105	18	FLT3460BMTNL	\$2,313		
	33½	60	29	105	18	FLV3460BMTNL		\$3,056	\$3,361



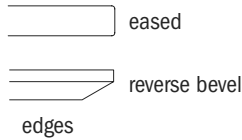
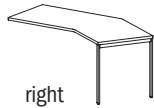
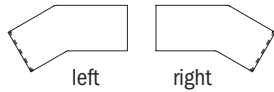
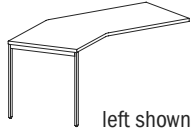
Features:

- mounts perpendicular to primary height units
- eased edge profile on approach and user sides
- laminate tops wider than 60" are long grain

Options:

- reverse bevel edge available on three sides, specify; add \$429 list for laminate or \$168 list for veneer; see page 8 for details
- 13½" h modesty panel available, specify; add \$427 list for laminate or \$594 list for veneer; see page 21 for details
- top grommet available, specify location; add \$128 list each; see page 45 for details
- 12" wide top grommet available, specify location; add \$168 list each; see page 45 for details
- worksurface power available, specify "to accommodate EC26" on your purchase order; EC26 unit must be ordered separately, see page 45
- wire manager tray available see accessory section on pages 50-51 for details

Description	D	W	H	CTN WT	CU FT	① Model	HPL Laminate	Flat Cut Veneer	Double Cut Veneer
Boomerang Run-off Desk with End Leg Assembly	27 1/2	72	29	101	18	FLT2872BMTNR	\$2,345		
	27 1/2	72	29	101	18	FLV2872BMTNR		\$3,097	\$3,409
	27 1/2	66	29	94	17	FLT2866BMTNL	\$2,304		
	27 1/2	66	29	94	17	FLV2866BMTNL		\$3,041	\$3,345
	27 1/2	60	29	87	15	FLT2860BMTNR	\$2,261		
	27 1/2	60	29	87	15	FLV2860BMTNR		\$2,984	\$3,283
	27 1/2	72	29	101	18	FLT2872BMTNL	\$2,345		
	27 1/2	72	29	101	18	FLV2872BMTNL		\$3,097	\$3,409
	27 1/2	66	29	94	17	FLT2866BMTNR	\$2,304		
	27 1/2	66	29	94	17	FLV2866BMTNR		\$3,041	\$3,345
	27 1/2	60	29	87	15	FLT2860BMTNL	\$2,261		
	27 1/2	60	29	87	15	FLV2860BMTNL		\$2,984	\$3,283



Features:

- mounts perpendicular to primary height units
- eased edge profile on approach and user sides
- laminate tops wider than 60" are long grain


Options:

- reverse bevel edge available on three sides, specify; add \$429 list for laminate or \$168 list for veneer; see page 8 for details
- 13 1/2" h modesty panel available, specify; add \$427 list for laminate or \$594 list for veneer; see page 21 for details
- top grommet available, specify location; add \$128 list each; see page 45 for details
- 12" wide top grommet available, specify location; add \$168 list each; see page 45 for details
- worksurface power available, specify "to accommodate EC26" on your purchase order; EC26 unit must be ordered separately, see page 45
- wire manager tray available see accessory section on pages 50-51 for details

To Order, Specify:

① Laminate Model #	② Laminate Type	③ Laminate Selection	④ Metal Color	⑤ Other Product Options
Laminate (FLT)	HPL	See Laminate Selection	See Metal Finish Color Options	See list of options for each specific unit; Specify and add accordingly.

① Veneer Model #	② Wood Species	③ Wood Finish	④ Metal Color	⑤ Other Product Options
Veneer (FLV)	Flat Cut CH1 Cherry MA1 Maple WA1 Walnut BO1 Black Oak	See Flat Cut Wood Finish Options	See Metal Finish Color Options	See list of options for each specific unit; Specify and add accordingly.
		③a Wood Finish See Double Cut Wood Finish Options		
	Double Cut DC1 Double Cut			


Description	D	W	H	CTN WT	CU FT	① Model	HPL Laminate	Flat Cut Veneer	Double Cut Veneer
 left shown	22	60	29	129	27	FLT2260-29FERR	\$1,598		
	22	60	29	129	27	FLV2260-29FERR		\$2,231	\$2,453
	22	60	29	129	27	FLT2260-29FELR	\$1,598		
	22	60	29	129	27	FLV2260-29FELR		\$2,231	\$2,453
	22	54	29	124	25	FLT2254-29FERR	\$1,566		
	22	54	29	124	25	FLV2254-29FERR		\$2,187	\$2,405
	22	54	29	124	25	FLT2254-29FELR	\$1,566		
	22	54	29	124	25	FLV2254-29FELR		\$2,187	\$2,405
	22	48	29	119	22	FLT2248-29FERR	\$1,537		
	22	48	29	119	22	FLV2248-29FERR		\$2,145	\$2,360
	22	48	29	119	22	FLT2248-29FELR	\$1,537		
	22	48	29	119	22	FLV2248-29FELR		\$2,145	\$2,360
	22	42	29	114	20	FLT2242-29FERR	\$1,506		
	22	42	29	114	20	FLV2242-29FERR		\$2,103	\$2,312
	22	42	29	114	20	FLT2242-29FELR	\$1,506		
	22	42	29	114	20	FLV2242-29FELR		\$2,103	\$2,312

Features:

- eased edge user side only
- pedestal front locking

Options:

- must specify chassis grain direction on double cut veneer, see pages 13-15 for details
- standard without kneespace modesty panel, partial and full modesty panels available; add \$161 list for laminate or \$201 list for veneer; see page 12 for details
- veneer drawer fronts in paint available, specify paint color; add \$337 list; see page 16 for details
- on laminate units, contrasting worksurface tops and drawer fronts available, no upcharge; specify color, see page 16 for details
- ledge pulls standard; prism pulls available, specify and see page 9
- interior wire manager from side to side in upper back, specify and add \$114 list; see page 17 for details
- top grommet available, specify location and add \$128 list each; see page 45 for details
- worksurface power available, specify "to accommodate EC26" on your purchase order; EC26 unit must be ordered separately, see page 45

Description	D	W	H	CTN WT	CU FT	① Model	HPL Laminate	Flat Cut Veneer	Double Cut Veneer
 left shown	22	60	29	129	27	FLT2260-29FERY	\$1,606		
	22	60	29	129	27	FLV2260-29FERY		\$2,238	\$2,460
	22	60	29	129	27	FLT2260-29FELY	\$1,606		
	22	60	29	129	27	FLV2260-29FELY		\$2,238	\$2,460
	22	54	29	124	25	FLT2254-29FERY	\$1,575		
	22	54	29	124	25	FLV2254-29FERY		\$2,195	\$2,415
	22	54	29	124	25	FLT2254-29FELY	\$1,575		
	22	54	29	124	25	FLV2254-29FELY		\$2,195	\$2,415
	22	48	29	119	22	FLT2248-29FERY	\$1,545		
	22	48	29	119	22	FLV2248-29FERY		\$2,151	\$2,367
	22	48	29	119	22	FLT2248-29FELY	\$1,545		
	22	48	29	119	22	FLV2248-29FELY		\$2,151	\$2,367
	22	42	29	114	20	FLT2242-29FERY	\$1,514		
	22	42	29	114	20	FLV2242-29FERY		\$2,109	\$2,320
	22	42	29	114	20	FLT2242-29FELY	\$1,514		
	22	42	29	114	20	FLV2242-29FELY		\$2,109	\$2,320

Features:

- eased edge user side only
- pedestal front locking

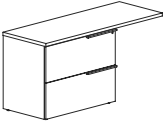
Options:

- must specify chassis grain direction on double cut veneer, see pages 13-15 for details
- standard without kneespace modesty panel, partial and full modesty panels available; add \$161 list for laminate or \$201 list for veneer; see page 12 for details
- veneer drawer fronts in paint available, specify paint color; add \$337 list; see page 16 for details
- on laminate units, contrasting worksurface tops and drawer fronts available, no upcharge; specify color, see page 16 for details
- ledge pulls standard; prism pulls available, specify and see page 9
- interior wire manager from side to side in upper back, specify and add \$114 list; see page 17 for details
- top grommet available, specify location and add \$128 list each; see page 45 for details
- worksurface power available, specify "to accommodate EC26" on your purchase order; EC26 unit must be ordered separately, see page 45

To Order, Specify:

① Laminate Model #	② Laminate Type	③ Laminate Selection		④ Metal Color	⑤ Other Product Options
Laminate (FLT)	HPL	See Laminate Selection		See Metal Finish Color Options	See list of options for each specific unit; Specify and add accordingly.

① Veneer Model #	② Wood Species	③ Wood Finish		④ Metal Color	⑤ Other Product Options
Veneer (FLV)	Flat Cut CH1 Cherry MA1 Maple WA1 Walnut BO1 Black Oak	See Flat Cut Wood Finish Options		See Metal Finish Color Options	See list of options for each specific unit; Specify and add accordingly.
		ⓐ Wood Finish	ⓑ Chassis Grain Direction		
	Double Cut DC1 Double Cut	See Double Cut Wood Finish Options	For Double Cut Only: Vertical Horizontal		

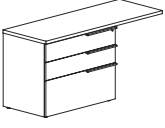
Description	D	W	H	CTN WT	CU FT	① Model	HPL Laminate	Flat Cut Veneer	Double Cut Veneer
 left shown	22	60	29	185	27	FLT2260-29FLRR	\$1,886		
	22	60	29	185	27	FLV2260-29FLRR		\$2,634	\$2,896
	22	60	29	185	27	FLT2260-29FLLR	\$1,886		
	22	60	29	185	27	FLV2260-29FLLR		\$2,634	\$2,896
	22	54	29	180	25	FLT2254-29FLRR	\$1,841		
	22	54	29	180	25	FLV2254-29FLRR		\$2,569	\$2,826
	22	54	29	180	25	FLT2254-29FLLR	\$1,841		
	22	54	29	180	25	FLV2254-29FLLR		\$2,569	\$2,826
	22	48	29	175	22	FLT2248-29FLRR	\$1,796		
	22	48	29	175	22	FLV2248-29FLRR		\$2,507	\$2,759
	22	48	29	175	22	FLT2248-29FLLR	\$1,796		
	22	48	29	175	22	FLV2248-29FLLR		\$2,507	\$2,759

Features:

- eased edge user side only
- pedestal front locking

Options:

- must specify chassis grain direction on double cut veneer, see pages 13-15 for details
- standard without kneespace modesty panel, partial and full modesty panels available; add \$161 list for laminate or \$201 list for veneer; see page 12 for details
- veneer drawer fronts in paint available, specify paint color; add \$337 list; see page 16 for details
- on laminate units, contrasting worksurface tops and drawer fronts available, no upcharge; specify color, see page 16 for details
- ledge pulls standard; prism pulls available, specify and see page 9
- interior wire manager from side to side in upper back, specify and add \$114 list; see page 17 for details
- top grommet available, specify location and add \$128 list each; see page 45 for details
- worksurface power available, specify "to accommodate EC26" on your purchase order; EC26 unit must be ordered separately, see page 45

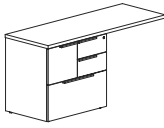
Description	D	W	H	CTN WT	CU FT	① Model	HPL Laminate	Flat Cut Veneer	Double Cut Veneer
 left shown	22	60	29	185	27	FLT2260-29FLRY	\$1,896		
	22	60	29	185	27	FLV2260-29FLRY		\$2,647	\$2,911
	22	60	29	185	27	FLT2260-29FLLY	\$1,896		
	22	60	29	185	27	FLV2260-29FLLY		\$2,647	\$2,911
	22	54	29	180	25	FLT2254-29FLRY	\$1,851		
	22	54	29	180	25	FLV2254-29FLRY		\$2,582	\$2,841
	22	54	29	180	25	FLT2254-29FLLY	\$1,851		
	22	54	29	180	25	FLV2254-29FLLY		\$2,582	\$2,841
	22	48	29	175	22	FLT2248-29FLRY	\$1,806		
	22	48	29	175	22	FLV2248-29FLRY		\$2,520	\$2,771
	22	48	29	175	22	FLT2248-29FLLY	\$1,806		
	22	48	29	175	22	FLV2248-29FLLY		\$2,520	\$2,771

Features:

- eased edge user side only
- pedestal front locking

Options:

- must specify chassis grain direction on double cut veneer, see pages 13-15 for details
- standard without kneespace modesty panel, partial and full modesty panels available; add \$161 list for laminate or \$201 list for veneer; see page 12 for details
- veneer drawer fronts in paint available, specify paint color; add \$337 list; see page 16 for details
- on laminate units, contrasting worksurface tops and drawer fronts available, no upcharge; specify color, see page 16 for details
- ledge pulls standard; prism pulls available, specify and see page 9
- interior wire manager from side to side in upper back, specify and add \$114 list; see page 17 for details
- top grommet available, specify location and add \$128 list each; see page 45 for details
- worksurface power available, specify "to accommodate EC26" on your purchase order; EC26 unit must be ordered separately, see page 45

Description	D	W	H	CTN WT	CU FT	① Model	HPL Laminate	Flat Cut Veneer	Double Cut Veneer
 <p>left shown</p>	22	60	29	191	27	FLT2260-29FMRR	\$2,017		
	22	60	29	191	27	FLV2260-29FMRR		\$2,818	\$3,097
	22	60	29	191	27	FLT2260-29FMLR	\$2,017		
	22	60	29	191	27	FLV2260-29FMLR		\$2,818	\$3,097
	22	54	29	186	25	FLT2254-29FMRR	\$1,970		
	22	54	29	186	25	FLV2254-29FMRR		\$2,749	\$3,023
	22	54	29	186	25	FLT2254-29FMLR	\$1,970		
	22	54	29	186	25	FLV2254-29FMLR		\$2,749	\$3,023
	22	48	29	181	22	FLT2248-29FMRR	\$1,920		
	22	48	29	181	22	FLV2248-29FMRR		\$2,682	\$2,950
	22	48	29	181	22	FLT2248-29FMLR	\$1,920		
	22	48	29	181	22	FLV2248-29FMLR		\$2,682	\$2,950

Features:

- eased edge user side only
- pedestal front locking

Options:

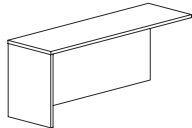
- must specify chassis grain direction on double cut veneer, see pages 13-15 for details
- standard without kneespace modesty panel, partial and full modesty panels available; add \$161 list for laminate or \$201 list for veneer; see page 12 for details
- veneer drawer fronts in paint available, specify paint color; add \$337 list; see page 16 for details
- on laminate units, contrasting worksurface tops and drawer fronts available, no upcharge; specify color, see page 16 for details
- ledge pulls standard; prism pulls available, specify and see page 9
- interior wire manager from side to side in upper back, specify and add \$114 list; see page 17 for details
- top grommet available, specify location and add \$128 list each; see page 45 for details
- worksurface power available, specify "to accommodate EC26" on your purchase order; EC26 unit must be ordered separately, see page 45

FLUX - PRIVATE OFFICE

To Order, Specify:

① Laminate Model #	② Laminate Type	③ Laminate Selection		④ Metal Color	⑤ Other Product Options
Laminate (FLT)	HPL	See Laminate Selection		See Metal Finish Color Options	See list of options for each specific unit; Specify and add accordingly.

① Veneer Model #	② Wood Species	③ Wood Finish		④ Metal Color	⑤ Other Product Options
Veneer (FLV)	Flat Cut CH1 Cherry MA1 Maple WA1 Walnut BO1 Black Oak	See Flat Cut Wood Finish Options		See Metal Finish Color Options	See list of options for each specific unit; Specify and add accordingly.
		ⓐ Wood Finish	ⓑ Chassis Grain Direction		
	Double Cut DC1 Double Cut	See Double Cut Wood Finish Options	For Double Cut Only: Vertical Horizontal		


Description	D	W	H	CTN WT	CU FT	① Model	HPL Laminate	Flat Cut Veneer	Double Cut Veneer	
 left shown	22	72	29	119	33	FLT2272RSHR	\$1,130			
	22	72	29	119	33	FLV2272RSHR		\$1,710	\$1,882	
	22	72	29	119	33	FLT2272LSHR	\$1,130			
	22	72	29	119	33	FLV2272LSHR		\$1,710	\$1,882	
	22	66	29	114	30	FLT2266RSHR	\$1,099			
	22	66	29	114	30	FLV2266RSHR		\$1,661	\$1,825	
	22	66	29	114	30	FLT2266LSHR	\$1,099			
	22	66	29	114	30	FLV2266LSHR		\$1,661	\$1,825	
	22	60	29	109	27	FLT2260RSHR	\$1,064			
	22	60	29	109	27	FLV2260RSHR		\$1,610	\$1,772	
	22	60	29	109	27	FLT2260LSHR	\$1,064			
	22	60	29	109	27	FLV2260LSHR		\$1,610	\$1,772	
	22	54	29	104	25	FLT2254RSHR	\$1,033			
	22	54	29	104	25	FLV2254RSHR		\$1,562	\$1,719	
	22	54	29	104	25	FLT2254LSHR	\$1,033			
	22	54	29	104	25	FLV2254LSHR		\$1,562	\$1,719	
	22	48			99	22	FLT2248RSHR	\$1,001		
	22	48	29		99	22	FLV2248RSHR		\$1,515	\$1,668
	22	48	29		99	22	FLT2248LSHR	\$1,001		
	22	48	29		99	22	FLV2248LSHR		\$1,515	\$1,668
22	42	29		94	20	FLT2242RSHR	\$971			
22	42	29		94	20	FLV2242RSHR		\$1,471	\$1,618	
22	42	29		94	20	FLT2242LSHR	\$971			
22	42	29		94	20	FLV2242LSHR		\$1,471	\$1,618	
22	36	29		89	17	FLT2236RSHR	\$943			
22	36	29		89	17	FLV2236RSHR		\$1,427	\$1,568	
22	36	29		89	17	FLT2236LSHR	\$943			
22	36	29		89	17	FLV2236LSHR		\$1,427	\$1,568	

Features:

- eased edge user side only
- laminate tops wider than 60" are long grain

Options:

- must specify chassis grain direction on double cut veneer, see pages 13-15 for details
- top grommet available, specify location; add \$128 list each; see page 45 for details

Description	D	W	H	CTN WT	CU FT	① Model	HPL Laminate	Flat Cut Veneer	Double Cut Veneer
Bridge 	22	50	1 3/16	69	3	FLT2250EB	\$596		
	22	50	1 3/16	69	3	FLV2250EB		\$743	\$817
	22	44	1 3/16	64	3	FLT2244EB	\$557		
	22	44	1 3/16	64	3	FLV2244EB		\$696	\$767
	22	38	1 3/16	59	2	FLT2238EB	\$548		
	22	38	1 3/16	59	2	FLV2238EB		\$685	\$753

Features:

- eased edge user side only

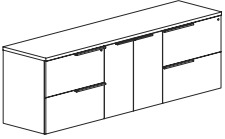
Options:

- standard without kneespace modesty panel, partial and full modesty panels available; add \$161 list for laminate or \$201 list for veneer; see page 12 for details
- when specify modesty with double cut veneer, specify grain direction, see pages 13-15 for details
- top grommet available, specify location; add \$128 list each; see page 45 for details
- worksurface power available, specify "to accommodate EC26" on your purchase order; EC26 unit must be ordered separately, see page 45

To Order, Specify:

① Laminate Model #	② Laminate Type	③ Laminate Selection	④ Metal Color	⑤ Other Product Options
Laminate (FLT)	HPL	See Laminate Selection	See Metal Finish Color Options	See list of options for each specific unit; Specify and add accordingly.

① Veneer Model #	② Wood Species	③ Wood Finish	④ Metal Color	⑤ Other Product Options
Veneer (FLV)	Flat Cut CH1 Cherry MA1 Maple WA1 Walnut BO1 Black Oak	See Flat Cut Wood Finish Options	See Metal Finish Color Options	See list of options for each specific unit; Specify and add accordingly.
	Double Cut DC1 Double Cut	See Double Cut Wood Finish Options For Double Cut Only: Vertical Horizontal		

Description	D	W	H	CTN WT	CU FT	① Model	HPL Laminate	Flat Cut Veneer	Double Cut Veneer
Storage Credenza 	22	96	29	437	43	FLT2296-29F474	\$3,488		
	22	96	29	437	43	FLV2296-29F474		\$4,866	\$5,354
	22	90	29	416	40	FLT2290-29F474	\$3,386		
	22	90	29	416	40	FLV2290-29F474		\$4,726	\$5,199
	22	84	29	395	38	FLT2284-29F474	\$3,285		
	22	84	29	395	38	FLV2284-29F474		\$4,588	\$5,047

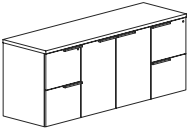
Features:

- eased edge profile user side
- pedestal front locking
- hinged door compartment has one adjustable shelf

Options:

- must specify chassis grain direction on double cut veneer, see pages 13-15 for details
- locking doors available, specify and add \$142 list
- veneer door and drawer fronts in paint available, specify paint color and add \$337; see page 16 for details
- on laminate units, contrasting worksurface tops and door fronts available, no upcharge; specify laminate color, see page 16 for details
- ledge pulls standard; prism pulls available, specify and see page 9
- oval grommets in back panel can be eliminated upon request, no upcharge
- interior horizontal wire manager with end grommets available, specify and add \$180 list; see page 40 for details
- top grommet available, specify location; add \$128 list each; see page 45 for details
- worksurface power available, specify "to accommodate EC26" on your purchase order; EC26 unit must be ordered separately, see page 45

FLUX - PRIVATE OFFICE

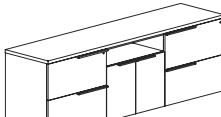
Storage Credenza 	22	78	29	354	35	FLT2278-29F272	\$2,884		
	22	78	29	354	35	FLV2278-29F272		\$4,028	\$4,431
	22	72	29	333	32	FLT2272-29F272	\$2,801		
	22	72	29	333	32	FLV2272-29F272		\$3,910	\$4,299
	22	66	29	310	30	FLT2266-29F272	\$2,745		
	22	66	29	310	30	FLV2266-29F272		\$3,832	\$4,216
	22	60	29	289	27	FLT2260-29F272	\$2,689		
	22	60	29	289	27	FLV2260-29F272		\$3,754	\$4,132

Features:

- eased edge profile user side
- pedestal front locking
- hinged door compartment has one adjustable shelf

Options:

- must specify chassis grain direction on double cut veneer, see pages 13-15 for details
- locking doors available, specify and add \$142 list
- veneer door and drawer fronts in paint available, specify paint color and add \$337; see page 16 for details
- on laminate units, contrasting worksurface tops and door fronts available, no upcharge; specify laminate color, see page 16 for details
- ledge pulls standard; prism pulls available, specify and see page 9
- oval grommets in back panel can be eliminated upon request, no upcharge
- interior horizontal wire manager with end grommets available, specify and add \$180 list; see page 40 for details
- top grommet available, specify location; add \$128 list each; see page 45 for details
- worksurface power available, specify "to accommodate EC26" on your purchase order; EC26 unit must be ordered separately, see page 45

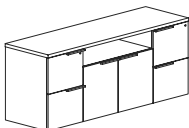
Description	D	W	H	CTN WT	CU FT	① Model	HPL Laminate	Flat Cut Veneer	Double Cut Veneer
Storage Credenza with Open Center 	22	96	29	447	43	FLT2296-29F484	\$3,566		
	22	96	29	447	43	FLV2296-29F484		\$4,980	\$5,478
	22	90	29	425	40	FLT2290-29F484	\$3,462		
	22	90	29	425	40	FLV2290-29F484		\$4,835	\$5,316
	22	84	29	402	38	FLT2284-29F484	\$3,361		
	22	84	29	402	38	FLV2284-29F484		\$4,695	\$5,163

Features:

- eased edge profile user side
- pedestal front locking
- hinged door compartment has one adjustable shelf

Options:

- must specify chassis grain direction on double cut veneer, see pages 13-15 for details
- locking doors available, specify and add \$142 list
- veneer door and drawer fronts in paint available, specify paint color and add \$337; see page 16 for details
- on laminate units, contrasting worksurface tops and door fronts available, no upcharge; specify laminate color, see page 16 for details
- ledge pulls standard; prism pulls available, specify and see page 9
- oval grommets in back panel can be eliminated upon request, no upcharge
- interior horizontal wire manager with end grommets available, specify and add \$180 list; see page 40 for details
- top grommet available, specify location; add \$128 list each; see page 45 for details
- worksurface power available, specify "to accommodate EC26" on your purchase order; EC26 unit must be ordered separately, see page 45

Description	D	W	H	CTN WT	CU FT	① Model	HPL Laminate	Flat Cut Veneer	Double Cut Veneer
Storage Credenza with Open Center 	22	78	29	366	35	FLT2278-29F282	\$2,900		
	22	78	29	366	35	FLV2278-29F282		\$4,048	\$4,452
	22	72	29	344	32	FLT2272-29F282	\$2,816		
	22	72	29	344	32	FLV2272-29F282		\$3,930	\$4,324
	22	66	29	320	30	FLT2266-29F282	\$2,759		
	22	66	29	320	30	FLV2266-29F282		\$3,852	\$4,239
	22	60	29	298	27	FLT2260-29F282	\$2,704		
	22	60	29	298	27	FLV2260-29F282		\$3,775	\$4,153

Features:

- eased edge profile user side
- pedestal front locking
- hinged door compartment has one adjustable shelf

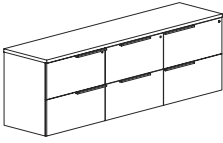
Options:

- must specify chassis grain direction on double cut veneer, see pages 13-15 for details
- locking doors available, specify and add \$142 list
- veneer door and drawer fronts in paint available, specify paint color and add \$337; see page 16 for details
- on laminate units, contrasting worksurface tops and door fronts available, no upcharge; specify laminate color, see page 16 for details
- ledge pulls standard; prism pulls available, specify and see page 9
- oval grommets in back panel can be eliminated upon request, no upcharge
- interior horizontal wire manager with end grommets available, specify and add \$180 list; see page 40 for details
- top grommet available, specify location; add \$128 list each; see page 45 for details
- worksurface power available, specify "to accommodate EC26" on your purchase order; EC26 unit must be ordered separately, see page 45

To Order, Specify:

① Laminate Model #	② Laminate Type	③ Laminate Selection		④ Metal Color	⑤ Other Product Options
Laminate (FLT)	TFL	See Laminate Selection		See Metal Finish Color Options	See list of options for each specific unit; Specify and add accordingly.
	HLP				
① Veneer Model #	② Wood Species	③ Wood Finish		④ Metal Color	⑤ Other Product Options
Veneer (FLV)	Flat Cut CH1 Cherry MA1 Maple WA1 Walnut BO1 Black Oak	See Flat Cut Wood Finish Options		See Metal Finish Color Options	See list of options for each specific unit; Specify and add accordingly.
	Double Cut DC1 Double Cut	3a Wood Finish See Double Cut Wood Finish Options	3b Chassis Grain Direction For Double Cut Only: Vertical Horizontal		

Description	D	W	H	CTN WT	CU FT	① Model	HPL Laminate	Flat Cut Veneer	Double Cut Veneer
Lateral File Credenza	22	90	29	448	40	FLT2290-29F444	\$3,153		
	22	90	29	448	40	FLV2290-29F444		\$4,396	\$4,836



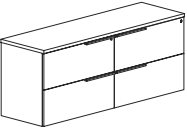
Features:

- eased edge profile user side
- pedestal front locking

Options:

- must specify chassis grain direction on double cut veneer, see pages 13-15 for details
- veneer drawer fronts in paint available, specify paint color and add \$337 list; see page 16 for details
- on laminate units, contrasting worksurface tops and drawer fronts available, no upcharge; specify color, see page 16 for details
- ledge pulls standard; prism pulls available, specify and see page 9
- oval grommets in back panel can be eliminated upon request, no upcharge
- top grommet available, specify location and add \$128 list each; see page 45 for details

Lateral File Credenza	22	72	29	354	32	FLT2272-29F44	\$2,357		
	22	72	29	354	32	FLV2272-29F44		\$3,291	\$3,620
	22	60	29	310	27	FLT2260-29F44	\$2,267		
	22	60	29	310	27	FLV2260-29F44		\$3,163	\$3,480



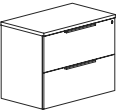
Features:

- eased edge profile user side
- pedestal front locking

Options:

- must specify chassis grain direction on double cut veneer, see pages 13-15 for details
- veneer drawer fronts in paint available, specify paint color and add \$337 list; see page 16 for details
- on laminate units, contrasting worksurface tops and drawer fronts available, no upcharge; specify color, see page 16 for details
- ledge pulls standard; prism pulls available, specify and see page 9
- oval grommets in back panel can be eliminated upon request, no upcharge
- top grommet available, specify location and add \$128 list each; see page 45 for details

Lateral File Pedestal	22	36	29	166	17	FLT2236-29F4	\$1,744		
	22	36	29	166	17	FLV2236-29F4		\$2,435	\$2,679
	22	30	29	150	14	FLT2230-29F4	\$1,494		
	22	30	29	150	17	FLV2230-29F4		\$2,085	\$2,294



Features:

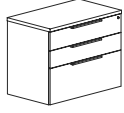
- eased edge profile user side
- pedestal front locking
- anti-tip interlock mechanism

Options:

- must specify chassis grain direction on double cut veneer, see pages 13-15 for details
- veneer drawer fronts in paint available, specify paint color and add \$337 list; see page 16 for details
- on laminate units, contrasting worksurface tops and drawer fronts available, no upcharge; specify color, see page 16 for details
- ledge pulls standard; prism pulls available, specify and see page 9
- oval grommet in back panel can be eliminated upon request, no upcharge
- top grommet available, specify location and add \$128 list each; see page 45 for details

FLUX - PRIVATE OFFICE

Description	D	W	H	CTN WT	CU FT	① Model	HPL Laminate	Flat Cut Veneer	Double Cut Veneer
Box/Box/Lateral File Pedestal	22	36	29	166	17	FLT2236-29F3	\$1,756		
	22	36	29	166	17	FLV2236-29F3		\$2,447	\$2,692
	22	30	29	150	14	FLT2230-29F3	\$1,505		
	22	30	29	150	17	FLV2230-29F3		\$2,096	\$2,306



Features:

- eased edge profile user side
- pedestal front locking
- anti-tip interlock mechanism

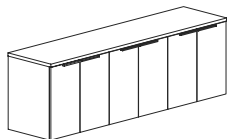
Options:

- must specify chassis grain direction on double cut veneer, see pages 13-15 for details
- veneer drawer fronts in paint available, specify paint color and add \$337 list; see page 16 for details
- on laminate units, contrasting worksurface tops and drawer fronts available, no upcharge; specify color, see page 16 for details
- ledge pulls standard; prism pulls available, specify and see page 9
- oval grommet in back panel can be eliminated upon request, no upcharge
- top grommet available, specify location and add \$128 list each; see page 45 for details

To Order, Specify:

① Laminate Model #	② Laminate Type	③ Laminate Selection	④ Metal Color	⑤ Other Product Options
Laminate (FLT)	HPL	See Laminate Selection	See Metal Finish Color Options	See list of options for each specific unit; Specify and add accordingly.

① Veneer Model #	② Wood Species	③ Wood Finish	④ Metal Color	⑤ Other Product Options	
Veneer (FLV)	Flat Cut CH1 Cherry MA1 Maple WA1 Walnut BO1 Black Oak	See Flat Cut Wood Finish Options	See Metal Finish Color Options	See list of options for each specific unit; Specify and add accordingly.	
	Double Cut DC1 Double Cut	<table border="1"> <thead> <tr> <th>③a Wood Finish</th> <th>③b Chassis Grain Direction</th> </tr> </thead> <tbody> <tr> <td>See Double Cut Wood Finish Options</td> <td>For Double Cut Only: Vertical Horizontal</td> </tr> </tbody> </table>			③a Wood Finish
③a Wood Finish	③b Chassis Grain Direction				
See Double Cut Wood Finish Options	For Double Cut Only: Vertical Horizontal				

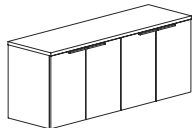
Description	D	W	H	CTN WT	CU FT	① Model	HPL Laminate	Flat Cut Veneer	Double Cut Veneer
Six Door Storage Credenza 	22	96	29	386	43	FLT2296-29F777	\$2,874		
	22	96	29	386	43	FLV2296-29F777		\$4,225	\$4,649
	22	90	29	365	40	FLT2290-29F777	\$2,791		
	22	90	29	365	40	FLV2290-29F777		\$4,102	\$4,513
	22	84	29	344	38	FLT2284-29F777	\$2,720		
	22	84	29	344	38	FLV2284-29F777		\$4,000	\$4,400

Features:

- eased edge profile user side
- each hinged door compartment has one adjustable shelf

Options:

- must specify chassis grain direction on double cut veneer, see pages 13-15 for details
- locking doors available, specify and add \$426 list
- veneer door fronts in paint available, specify paint color and add \$337 list; see page 16 for details
- on laminate units, contrasting worksurface tops and door fronts available, no upcharge; specify color, see page 16 for details
- ledge pulls standard; prism pulls available, specify and see page 9
- oval grommets in back panel can be eliminated upon request, no upcharge
- interior horizontal wire manager with end grommets available, specify and add \$180 list; see page 40 for details
- top grommet available, specify location; add \$128 list each; see page 45 for details
- worksurface power available, specify "to accommodate EC26" on your purchase order; EC26 unit must be ordered separately, see page 45

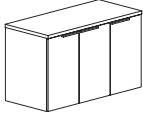
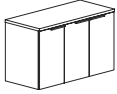
Four Door Storage Credenza 	22	78	29	312	34	FLT2278-29F77	\$2,496		
	22	78	29	312	34	FLV2278-29F77		\$3,667	\$4,034
	22	72	29	291	32	FLT2272-29F77	\$2,424		
	22	72	29	291	32	FLV2272-29F77		\$3,562	\$3,917
	22	66	29	270	29	FLT2266-29F77	\$2,326		
	22	66	29	270	29	FLV2266-29F77		\$3,419	\$3,761
	22	60	29	265	27	FLT2260-29F77	\$2,234		
	22	60	29	265	27	FLV2260-29F77		\$3,283	\$3,613

Features:

- eased edge profile user side
- each hinged door compartment has one adjustable shelf

Options:

- must specify chassis grain direction on double cut veneer, see pages 13-15 for details
- locking doors available, specify and add \$284 list
- veneer door fronts in paint available, specify paint color and add \$337 list; see page 16 for details
- on laminate units, contrasting worksurface tops and door fronts available, no upcharge; specify color, see page 16 for details
- ledge pulls standard; prism pulls available, specify and see page 9
- oval grommets in back panel can be eliminated upon request, no upcharge
- interior horizontal wire manager with end grommets available, specify and add \$180 list; see page 40 for details
- top grommet available, specify location; add \$128 list each; see page 45 for details
- worksurface power available, specify "to accommodate EC26" on your purchase order; EC26 unit must be ordered separately, see page 45

Description	D	W	H	CTN WT	CU FT	① Model	HPL Laminate	Flat Cut Veneer	Double Cut Veneer
 right shown  left	22	54	29	228	24	FLT2254-29F77R	\$2,034		
	22	54	29	228	24	FLV2254-29F77R		\$2,986	\$3,285
	22	54	29	228	24	FLT2254-29F77L	\$2,034		
	22	54	29	228	24	FLV2254-29F77L		\$2,986	\$3,285
	22	48	29	206	22	FLT2248-29F77R	\$1,931		
	22	48	29	206	22	FLV2248-29F77R		\$2,838	\$3,124
	22	48	29	206	22	FLT2248-29F77L	\$1,931		
	22	48	29	206	22	FLV2248-29F77L		\$2,838	\$3,124
	22	42	29	185	19	FLT2242-29F77R	\$1,834		
	22	42	29	185	19	FLV2242-29F77R		\$2,695	\$2,966
	22	42	29	185	19	FLT2242-29F77L	\$1,834		
	22	42	29	185	19	FLV2242-29F77L		\$2,695	\$2,966

Features:

- eased edge profile user side
- each hinged door compartment has one adjustable shelf

Options:

- must specify chassis grain direction on double cut veneer, see pages 13-15 for details
- locking doors available, specify and add \$284 list
- veneer door fronts in paint available, specify paint color and add \$337 list; see page 16 for details
- on laminate units, contrasting worksurface tops and door fronts available, no upcharge; specify color, see page 16 for details
- ledge pulls standard; prism pulls available, specify and see page 9
- oval grommets in back panel can be eliminated upon request, no upcharge
- interior horizontal wire manager with end grommets available, specify and add \$180 list; see page 40 for details
- top grommet available, specify location; add \$128 list each; see page 45 for details
- worksurface power available, specify "to accommodate EC26" on your purchase order; EC26 unit must be ordered separately, see page 45
- pull out trash can available, specify and add \$456 list; see page 36 for details

	22	36	29	156	17	FLT2236-29F7	\$1,303		
	22	36	29	156	17	FLV2236-29F7		\$1,917	\$2,108
	22	30	29	132	14	FLT2230-29F7	\$1,252		
	22	30	29	132	14	FLV2230-29F7		\$1,840	\$2,023

Features:

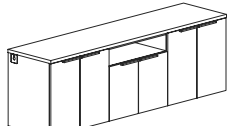
- eased edge profile user side
- each hinged door compartment has one adjustable shelf

Options:

- must specify chassis grain direction on double cut veneer, see pages 13-15 for details
- locking doors available, specify and add \$142 list
- veneer door fronts in paint available, specify paint color and add \$337 list; see page 16 for details
- on laminate units, contrasting worksurface tops and door fronts available, no upcharge; specify color, see page 16 for details
- ledge pulls standard; prism pulls available, specify and see page 9
- oval grommets in back panel can be eliminated upon request, no upcharge
- interior horizontal wire manager with end grommets available, specify and add \$180 list; see page 40 for details
- top grommet available, specify location; add \$128 list each; see page 45 for details
- worksurface power available, specify "to accommodate EC26" on your purchase order; EC26 unit must be ordered separately, see page 45

To Order, Specify:

① Laminate Model #	② Laminate Type	③ Laminate Selection	④ Metal Color	⑤ Other Product Options
Laminate (FLT)	TFL	See Laminate Selection	See Metal Finish Color Options	See list of options for each specific unit; Specify and add accordingly.
	HLP			
① Veneer Model #	② Wood Species	③ Wood Finish	④ Metal Color	⑤ Other Product Options
Veneer (FLV)	Flat Cut CH1 Cherry MA1 Maple WA1 Walnut BO1 Black Oak	See Flat Cut Wood Finish Options	See Metal Finish Color Options	See list of options for each specific unit; Specify and add accordingly.
	Double Cut DC1 Double Cut	③a Wood Finish See Double Cut Wood Finish Options ③b Chassis Grain Direction For Double Cut Only: Vertical Horizontal		

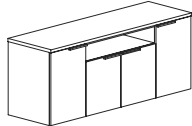
Description	D	W	H	CTN WT	CU FT	① Model	HPL Laminate	Flat Cut Veneer	Double Cut Veneer
Six Door Credenza with Open Center 	22	96	29	394	43	FLT2296-29F787	\$2,995		
	22	96	29	394	43	FLV2296-29F787		\$4,180	\$4,598
	22	90	29	372	40	FLT2290-29F787	\$2,908		
	22	90	29	372	40	FLV2290-29F787		\$4,062	\$4,466
	22	84	29	353	38	FLT2284-29F787	\$2,823		
	22	84	29	353	38	FLV2284-29F787		\$3,941	\$4,334

Features:

- eased edge profile user side
- each hinged door compartment has one adjustable shelf

Options:

- must specify chassis grain direction on double cut veneer, see pages 13-15 for details
- locking doors available, specify and add \$426 list
- veneer door and drawer fronts in paint available, specify paint color and add \$337; see page 16 for details
- on laminate units, contrasting worksurface tops and door fronts available, no upcharge; specify color, see page 16 for details
- ledge pulls standard; prism pulls available, specify and see page 9
- oval grommets in back panel can be eliminated upon request, no upcharge
- interior horizontal wire manager with end grommets available, specify and add \$180 list; see page 40 for details
- top grommet available, specify location; add \$128 list each; see page 45 for details
- worksurface power available, specify "to accommodate EC26" on your purchase order; EC26 unit must be ordered separately, see page 45

Four Door Credenza with Open Center 	22	78	29	339	35	FLT2278-29F787	\$2,582		
	22	78	29	339	35	FLV2278-29F787		\$3,795	\$4,176
	22	72	29	310	32	FLT2272-29F787	\$2,496		
	22	72	29	310	32	FLV2272-29F787		\$3,667	\$4,034
	22	66	29	288	30	FLT2266-29F787	\$2,421		
	22	66	29	288	30	FLV2266-29F787		\$3,560	\$3,916
	22	60	29	266	27	FLT2260-29F787	\$2,350		
	22	60	29	266	27	FLV2260-29F787		\$3,453	\$3,796

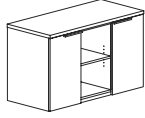
Features:

- eased edge profile user side
- each hinged door compartment has one adjustable shelf

Options:

- must specify chassis grain direction on double cut veneer, see pages 13-15 for details
- locking doors available, specify and add \$426 list
- veneer door and drawer fronts in paint available, specify paint color and add \$337; see page 16 for details
- on laminate units, contrasting worksurface tops and door fronts available, no upcharge; specify color, see page 16 for details
- ledge pulls standard; prism pulls available, specify and see page 9
- oval grommets in back panel can be eliminated upon request, no upcharge
- interior horizontal wire manager with end grommets available, specify and add \$180 list; see page 40 for details
- top grommet available, specify location; add \$128 list each; see page 45 for details
- worksurface power available, specify "to accommodate EC26" on your purchase order; EC26 unit must be ordered separately, see page 45
- pull out trash can available, specify and add \$456 list; see page 40 for details

Description	D	W	H	CTN WT	CU FT	① Model	HPL Laminate	Flat Cut Veneer	Double Cut Veneer
Two Door Credenza with Open Storage Compartment	22	54	29	228	25	FLT2254-29F707	\$2,138		
	22	54	29	228	25	FLV2254-29F707		\$3,140	\$3,457
	22	48	29	208	22	FLT2248-29F707	\$2,033		
	22	48	29	208	22	FLV2248-29F707		\$2,985	\$3,284
	22	42	29	189	19	FLT2242-29F707	\$1,930		
	22	42	29	189	19	FLV2242-29F707		\$2,836	\$3,121



Features:

- eased edge profile user side
- each compartment has one adjustable shelf

Options:

- must specify chassis grain direction on double cut veneer, see pages 13-15 for details
- locking doors available, specify and add \$284 list
- veneer door fronts in paint available, specify paint color and add \$337 list; see page 16 for details
- on laminate units, contrasting worksurface tops and door fronts available, no upcharge; specify color, see page 16 for details
- ledge pulls standard; prism pulls available, specify and see page 9
- oval grommets in back panel can be eliminated upon request, no upcharge
- interior horizontal wire manager with end grommets available, specify and add \$180 list; see page 40 for details
- top grommet available, specify location; add \$128 list each; see page 45 for details
- worksurface power available, specify "to accommodate EC26" on your purchase order; EC26 unit must be ordered separately, see page 45
- pull out trash can available, specify and add \$456 list; see page 40 for details

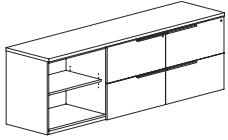
FLUX - PRIVATE OFFICE

To Order, Specify:

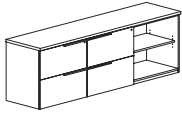
① Laminate Model #	② Laminate Type	③ Laminate Selection		④ Metal Color	⑤ Other Product Options
Laminate (FLT)	HPL	See Laminate Selection		See Metal Finish Color Options	See list of options for each specific unit; Specify and add accordingly.

① Veneer Model #	② Wood Species	③ Wood Finish		④ Metal Color	⑤ Other Product Options
Veneer (FLV)	Flat Cut CH1 Cherry MA1 Maple WA1 Walnut BO1 Black Oak	See Flat Cut Wood Finish Options		See Metal Finish Color Options	See list of options for each specific unit; Specify and add accordingly.
	Double Cut DC1 Double Cut	ⓐ Wood Finish See Double Cut Wood Finish Options	ⓑ Chassis Grain Direction For Double Cut Only: Vertical Horizontal		

Description	D	W	H	CTN WT	CU FT	① Model	HPL Laminate	Flat Cut Veneer	Double Cut Veneer
Lateral File and Open Storage Credenza	22	96	29	426	43	FLT2296-29F044	\$3,080		
	22	96	29	426	43	FLV2296-29F044		\$4,296	\$4,727
	22	96	29	436	43	FLT2296-29F440	\$3,080		
	22	96	29	436	43	FLV2296-29F440		\$4,296	\$4,727
	22	90	29	409	40	FLT2290-29F044	\$2,985		
	22	90	29	409	40	FLV2290-29F044		\$4,168	\$4,586
	22	90	29	409	40	FLT2290-29F440	\$2,985		
	22	90	29	409	40	FLV2290-29F440		\$4,168	\$4,586



*044 shown



*440

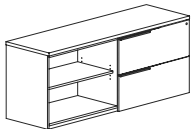
Features:

- eased edge profile user side
- pedestal front locking
- open compartment with adjustable shelf
- shelf 12 1/2"d

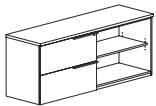
Options:

- must specify chassis grain direction on double cut veneer, see pages 13-15 for details
- veneer drawer fronts in paint available, specify paint color and add \$337 list; see page 16 for details
- on laminate units, contrasting worksurface tops and drawer fronts available, no upcharge; specify color, see page 16 for details
- ledge pulls standard; prism pulls available, specify and see page 9
- oval grommets in back panel can be eliminated upon request, no upcharge
- interior horizontal wire manager with end grommets available, specify and add \$180 list; see page 40 for details
- top grommet available, specify location; add \$128 list each; see page 45 for details
- worksurface power available, specify "to accommodate EC26" on your purchase order; EC26 unit must be ordered separately, see page 45

Lateral File and Open Storage Credenza	22	72	29	295	32	FLT2272-29F04	\$2,373		
	22	72	29	295	32	FLV2272-29F04		\$3,313	\$3,644
	22	72	29	295	32	FLT2272-29F40	\$2,373		
	22	72	29	295	32	FLV2272-29F40		\$3,313	\$3,644
	22	66	29	273	30	FLT2266-29F04	\$2,257		
	22	66	29	273	30	FLV2266-29F04		\$3,148	\$3,462
	22	66	29	273	30	FLT2266-29F40	\$2,257		
	22	66	29	273	30	FLV2266-29F40		\$3,148	\$3,462
	22	60	29	256	27	FLT2260-29F04	\$2,144		
	22	60	29	256	27	FLV2260-29F04		\$2,989	\$3,289
	22	60	29	256	27	FLT2260-29F40	\$2,144		
	22	60	29	256	27	FLV2260-29F40		\$2,989	\$3,289



*04 shown



*40

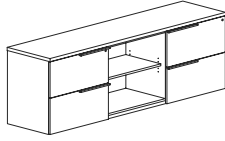
Features:

- eased edge profile user side
- pedestal front locking
- open compartment with adjustable shelf
- shelf 12 1/2"d

Options:

- must specify chassis grain direction on double cut veneer, see pages 13-15 for details
- veneer drawer fronts in paint available, specify paint color and add \$337 list; see page 16 for details
- on laminate units, contrasting worksurface tops and drawer fronts available, no upcharge; specify color, see page 14 for details
- ledge pulls standard; prism pulls available, specify and see page 9
- oval grommets in back panel can be eliminated upon request, no upcharge
- interior horizontal wire manager with end grommets available, specify and add \$180 list; see page 40 for details
- top grommet available, specify location; add \$128 list each; see page 45 for details
- worksurface power available, specify "to accommodate EC26" on your purchase order; EC26 unit must be ordered separately, see page 44

Description	D	W	H	CTN WT	CU FT	① Model	HPL Laminate	Flat Cut Veneer	Double Cut Veneer
Lateral Files and Open Storage Credenza	22	96	29	416	43	FLT2296-29F404	\$3,080		
	22	96	29	416	43	FLV2296-29F404		\$4,296	\$4,727
	22	90	29	399	40	FLT2290-29F404	\$2,985		
	22	90	29	399	40	FLV2290-29F404		\$4,168	\$4,586



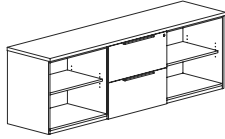
Features:

- eased edge profile user side
- pedestal front locking
- open compartment with adjustable shelf
- shelf 12 1/2" d

Options:

- must specify chassis grain direction on double cut veneer, see pages 13-15 for details
- veneer drawer fronts in paint available, specify paint color and add \$337 list; see page 16 for details
- on laminate units, contrasting worksurface tops and drawer fronts available, no upcharge; specify color, see page 16 for details
- ledge pulls standard; prism pulls available, specify and see page 9
- oval grommets in back panel can be eliminated upon request, no upcharge
- interior horizontal wire manager with end grommets available, specify and add \$180 list; see page 40 for details
- top grommet available, specify location; add \$128 list each; see page 45 for details
- worksurface power available, specify "to accommodate EC26" on your purchase order; EC26 unit must be ordered separately, see page 45

Lateral File and Open Storage Credenza	22	96	29	375	43	FLT2296-29F040	\$2,855		
	22	96	29	375	43	FLV2296-29F040		\$3,986	\$4,384
	22	90	29	353	40	FLT2290-29F040	\$2,768		
	22	90	29	353	40	FLV2290-29F040		\$3,867	\$4,253



Features:

- eased edge profile user side
- pedestal front locking
- open compartment with adjustable shelf
- shelf 12 1/2" d

Options:

- must specify chassis grain direction on double cut veneer, see pages 13-15 for details
- veneer drawer fronts in paint available, specify paint color and add \$337 list; see page 16 for details
- on laminate units, contrasting worksurface tops and drawer fronts available, no upcharge; specify color, see page 16 for details
- ledge pulls standard; prism pulls available, specify and see page 9
- oval grommets in back panel can be eliminated upon request, no upcharge
- interior horizontal wire manager with end grommets available, specify and add \$180 list; see page 40 for details
- top grommet available, specify location; add \$128 list each; see page 45 for details
- worksurface power available, specify "to accommodate EC26" on your purchase order; EC26 unit must be ordered separately, see page 45

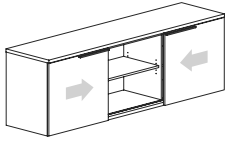
To Order, Specify:

① Laminate Model #	② Laminate Type	③ Laminate Selection	④ Metal Color	⑤ Other Product Options
Laminate (FLT)	HPL	See Laminate Selection	See Metal Finish Color Options	See list of options for each specific unit; Specify and add accordingly.

① Veneer Model #	② Wood Species	③ Wood Finish	④ Metal Color	⑤ Other Product Options
Veneer (FLV)	Flat Cut CH1 Cherry MA1 Maple WA1 Walnut BO1 Black Oak	See Flat Cut Wood Finish Options	See Metal Finish Color Options	See list of options for each specific unit; Specify and add accordingly.
		<table border="1"> <thead> <tr> <th>ⓐ Wood Finish</th> <th>ⓑ Chassis Grain Direction</th> </tr> </thead> <tbody> <tr> <td>See Double Cut Wood Finish Options</td> <td>For Double Cut Only: Vertical Horizontal</td> </tr> </tbody> </table>		
ⓐ Wood Finish	ⓑ Chassis Grain Direction			
See Double Cut Wood Finish Options	For Double Cut Only: Vertical Horizontal			

FLUX - PRIVATE OFFICE

Description	D	W	H	CTN WT	CU FT	① Model	HPL Laminate	Flat Cut Veneer	Double Cut Veneer
Double Sliding Door Credenza	22	90	29	345	40	FLT2290-29F909	\$2,474		
	22	90	29	345	40	FLV2290-29F909		\$3,634	\$3,999

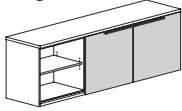
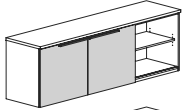


Features:

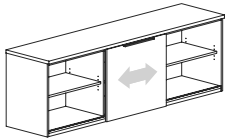
- eased edge profile user side
- locking doors not available
- each compartment has one adjustable shelf
- shelves 12 1/2"d

Options:

- must specify chassis grain direction on double cut veneer, see pages 13-15 for details
- veneer door fronts in paint available, specify paint color and add \$337 list; see page 16 for details
- on laminate units, contrasting worksurface tops and door fronts available, no upcharge; specify color, see page 16 for details
- ledge pulls standard; prism pulls available, specify and see page 9
- oval grommets in back panel can be eliminated upon request, no upcharge
- interior horizontal wire manager with end grommets available, specify and add \$180 list; see page 40 for details
- top grommet available, specify location; add \$128 list each; see page 45 for details
- worksurface power available, specify "to accommodate EC26" on your purchase order; EC26 unit must be ordered separately, see page 45



Sliding Door Credenza	22	90	29	327	40	FLT2290-29F090	\$2,350		
	22	90	29	327	40	FLV2290-29F090		\$3,453	\$3,796

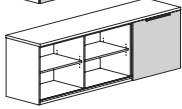
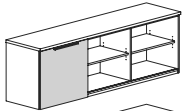


Features:

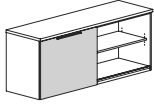
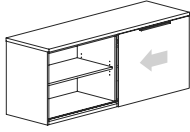
- eased edge profile user side
- locking doors not available
- each compartment has one adjustable shelf
- shelves 12 1/2"d

Options:

- must specify chassis grain direction on double cut veneer, see pages 13-15 for details
- veneer door fronts in paint available, specify paint color and add \$337 list; see page 16 for details
- on laminate units, contrasting worksurface tops and door fronts available, no upcharge; specify color, see page 16 for details
- ledge pulls standard; prism pulls available, specify and see page 9
- oval grommets in back panel can be eliminated upon request, no upcharge
- interior horizontal wire manager with end grommets available, specify and add \$180 list; see page 40 for details
- top grommet available, specify location; add \$128 list each; see page 45 for details
- worksurface power available, specify "to accommodate EC26" on your purchase order; EC26 unit must be ordered separately, see page 45



Description	D	W	H	CTN WT	CU FT	① Model	HPL Laminate	Flat Cut Veneer	Double Cut Veneer
Sliding Door Credenza	22	72	29	268	32	FLT2272-29F09	\$2,067		
	22	72	29	268	32	FLV2272-29F09		\$3,039	\$3,343
	22	60	29	228	27	FLT2260-29F09	\$1,951		
	22	60	29	228	27	FLV2260-29F09		\$2,867	\$3,153



Features:

- eased edge profile user side
- locking doors not available
- each compartment has one adjustable shelf
- shelves 12 1/2"d

Options:

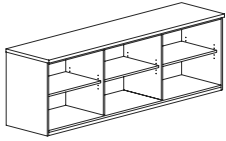
- must specify chassis grain direction on double cut veneer, see pages 13-15 for details
- veneer door fronts in paint available, specify paint color and add \$337 list; see page 16 for details
- on laminate units, contrasting worksurface tops and door fronts available, no upcharge; specify color, see page 16 for details
- ledge pulls standard; prism pulls available, specify and see page 9
- oval grommets in back panel can be eliminated upon request, no upcharge
- interior horizontal wire manager with end grommets available, specify and add \$180 list; see page 40 for details
- top grommet available, specify location; add \$128 list each; see page 45 for details
- worksurface power available, specify "to accommodate EC26" on your purchase order; EC26 unit must be ordered separately, see page 45

To Order, Specify:

① Laminate Model #	② Laminate Type	③ Laminate Selection	④ Metal Color	⑤ Other Product Options
Laminate (FLT)	HPL	See Laminate Selection	See Metal Finish Color Options	See list of options for each specific unit; Specify and add accordingly.

① Veneer Model #	② Wood Species	③ Wood Finish	④ Metal Color	⑤ Other Product Options	
Veneer (FLV)	Flat Cut CH1 Cherry MA1 Maple WA1 Walnut BO1 Black Oak	See Flat Cut Wood Finish Options	See Metal Finish Color Options	See list of options for each specific unit; Specify and add accordingly.	
	Double Cut DC1 Double Cut	<table border="1"> <thead> <tr> <th>ⓐ Wood Finish</th> <th>ⓑ Chassis Grain Direction</th> </tr> </thead> <tbody> <tr> <td>See Double Cut Wood Finish Options</td> <td>For Double Cut Only: Vertical Horizontal</td> </tr> </tbody> </table>			ⓐ Wood Finish
ⓐ Wood Finish	ⓑ Chassis Grain Direction				
See Double Cut Wood Finish Options	For Double Cut Only: Vertical Horizontal				

Description	D	W	H	CTN WT	CU FT	① Model	HPL Laminate	Flat Cut Veneer	Double Cut Veneer
Open Compartment Credenza	22	96	29	325	43	FLT2296-29F000	\$2,198		
	22	96	29	325	43	FLV2296-29F000		\$3,230	\$3,554
	22	90	29	308	40	FLT2290-29F000	\$2,134		
	22	90	29	308	40	FLV2290-29F000		\$3,136	\$3,452



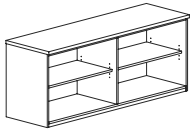
Features:

- eased edge profile user side
- each open compartment has one adjustable shelf
- shelves 12 1/2" d

Options:

- must specify chassis grain direction on double cut veneer, see pages 13-15 for details
- contrasting laminate worksurface tops, no upcharge; specify laminate color, see page 16 for details
- oval grommets in back panel can be eliminated upon request, no upcharge
- interior horizontal wire manager with end grommets available, specify and add \$180 list; see page 40 for details
- top grommet available, specify location and add \$128 list each; see page 45 for details
- worksurface power available, specify "to accommodate EC26" on your purchase order; EC26 unit must be ordered separately, see page 45

Open Compartment Credenza	22	72	29	245	32	FLT2272-29F00	\$1,945		
	22	72	29	245	32	FLV2272-29F00		\$2,861	\$3,146
	22	60	29	210	27	FLT2260-29F00	\$1,836		
	22	60	29	210	27	FLV2260-29F00		\$2,696	\$2,967



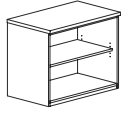
Features:

- eased edge profile user side
- each open compartment has one adjustable shelf
- shelves 12 1/2" d

Options:

- must specify chassis grain direction on double cut veneer, see pages 13-15 for details
- contrasting laminate worksurface tops, no upcharge; specify laminate color, see page 16 for details
- oval grommets in back panel can be eliminated upon request, no upcharge
- interior horizontal wire manager with end grommets available, specify and add \$180 list; see page 40 for details
- top grommet available, specify location and add \$128 list each; see page 45 for details
- worksurface power available, specify "to accommodate EC26" on your purchase order; EC26 unit must be ordered separately, see page 45

Description	D	W	H	CTN WT	CU FT	① Model	HPL Laminate	Flat Cut Veneer	Double Cut Veneer
Open Compartment	22	36	29	131	17	FLT2236-29F0	\$1,243		
	22	36	29	131	17	FLV2236-29F0		\$1,824	\$2,005
	22	30	29	113	14	FLT2230-29F0	\$1,194		
	22	30	29	113	14	FLV2230-29F0		\$1,755	\$1,931



Features:

- eased edge profile user side
- open compartment with adjustable shelf
- shelf 12 1/2" d

Options:

- must specify chassis grain direction on double cut veneer, see pages 13-15 for details
- contrasting laminate worksurface tops, no upcharge; specify laminate color, see page 16 for details
- oval grommet in back panel can be eliminated upon request, no upcharge
- top grommet available, specify location; add \$128 list each; see page 45 for details
- worksurface power available, specify "to accommodate EC26" on your purchase order; EC26 unit must be ordered separately, see page 45

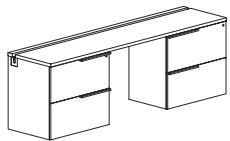
FLUX - PRIVATE OFFICE

To Order, Specify:

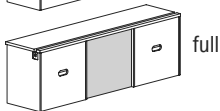
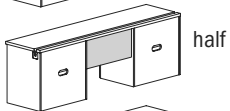
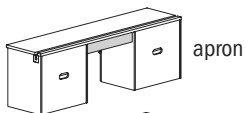
① Laminate Model #	② Laminate Type	③ Laminate Selection	④ Metal Color	⑤ Other Product Options
Laminate (FLT)	HPL	See Laminate Selection	See Metal Finish Color Options	See list of options for each specific unit; Specify and add accordingly.

① Veneer Model #	② Wood Species	③ Wood Finish	④ Metal Color	⑤ Other Product Options	
Veneer (FLV)	Flat Cut CH1 Cherry MA1 Maple WA1 Walnut BO1 Black Oak	See Flat Cut Wood Finish Options	See Metal Finish Color Options	See list of options for each specific unit; Specify and add accordingly.	
	Double Cut DC1 Double Cut	<table border="1"> <thead> <tr> <th>ⓐ Wood Finish</th> <th>ⓑ Chassis Grain Direction</th> </tr> </thead> <tbody> <tr> <td>See Double Cut Wood Finish Options</td> <td>For Double Cut Only: Vertical Horizontal</td> </tr> </tbody> </table>			ⓐ Wood Finish
ⓐ Wood Finish	ⓑ Chassis Grain Direction				
See Double Cut Wood Finish Options	For Double Cut Only: Vertical Horizontal				

Description	D	W	H	CTN WT	CU FT	① Model	HPL Laminate	Flat Cut Veneer	Double Cut Veneer
Split Top Lateral File	22	96	29	336	43	FLT2296-29F4K4ST	\$3,560		
Kneespace Credenza	22	96	29	336	43	FLV2296-29F4K4ST		\$4,859	\$5,345
	22	90	29	328	40	FLT2290-29F4K4ST	\$3,479		
	22	90	29	328	40	FLV2290-29F4K4ST		\$4,746	\$5,225



modesty panel options:



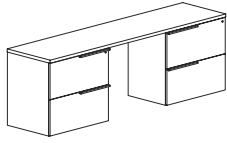
Features:

- eased edge profile user side
- built in horizontal wire channel
- 5”h back apron rail standard in kneespace
- pedestal front locking

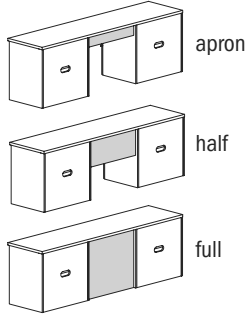
Options:

- must specify chassis grain direction on double cut veneer, see pages 13-15 for details
- fixed half or full modesty panel available, specify style; add \$161 list for laminate panel or \$201 list for veneer panel, see page 25 for details
- removable modesty panel available, specify; add \$245 list for laminate or \$324 for veneer panel, see page 25 for details
- veneer drawer fronts in paint available, specify paint color and add \$337 list; see page 16 for details
- on laminate units, contrasting worksurface tops and drawer fronts available, no upcharge; specify color, see page 16 for details
- ledge pulls standard; prism pulls available, specify and see page 9

Description	D	W	H	CTN WT	CU FT	① Model	HPL Laminate	Flat Cut Veneer	Double Cut Veneer
Lateral File Kneespace Credenza	22	96	29	343	43	FLT2296-29F4K4	\$3,284		
	22	96	29	343	43	FLV2296-29F4K4		\$4,584	\$5,042
	22	90	29	235	40	FLT2290-29F4K4	\$3,204		
	22	90	29	235	40	FLV2290-29F4K4		\$4,473	\$4,920



modesty panel options:



Features:

- eased edge profile user side
- 5”h back apron rail standard in kneespace
- pedestal front locking

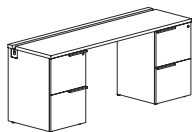
Options:

- must specify chassis grain direction on double cut veneer, see pages 13-15 for details
- fixed half or full modesty panel available, specify style; add \$161 list for laminate panel or \$201 list for veneer panel, see page 25 for details
- removable modesty panel available, specify; add \$245 list for laminate or \$324 for veneer panel, see page 25 for details
- veneer drawer fronts in paint available, specify paint color and add \$337 list; see page 16 for details
- on laminate units, contrasting worksurface tops and drawer fronts available, no upcharge; specify color, see page 16 for details
- ledge pulls standard; prism pulls available, specify and see page 9
- interior horizontal wire manager with end grommets available, specify and add \$180 list; see page 40 for details
- top grommet available, specify location; add \$128 list each; see page 45 for details
- worksurface power available, specify “to accommodate EC26” on your purchase order; EC26 unit must be ordered separately, see page 45

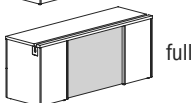
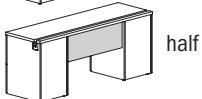
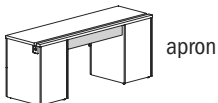
To Order, Specify:

① Laminate Model #	② Laminate Type	③ Laminate Selection	④ Metal Color	⑤ Other Product Options
Laminate (FLT)	HPL	See Laminate Selection	See Metal Finish Color Options	See list of options for each specific unit; Specify and add accordingly.

① Veneer Model #	② Wood Species	③ Wood Finish	④ Metal Color	⑤ Other Product Options	
Veneer (FLV)	Flat Cut CH1 Cherry MA1 Maple WA1 Walnut BO1 Black Oak	See Flat Cut Wood Finish Options	See Metal Finish Color Options	See list of options for each specific unit; Specify and add accordingly.	
	Double Cut DC1 Double Cut	<table border="1"> <thead> <tr> <th>ⓐ Wood Finish</th> <th>ⓑ Chassis Grain Direction</th> </tr> </thead> <tbody> <tr> <td>See Double Cut Wood Finish Options</td> <td>For Double Cut Only: Vertical Horizontal</td> </tr> </tbody> </table>			ⓐ Wood Finish
ⓐ Wood Finish	ⓑ Chassis Grain Direction				
See Double Cut Wood Finish Options	For Double Cut Only: Vertical Horizontal				

Description	D	W	H	CTN WT	CU FT	① Model	HPL Laminate	Flat Cut Veneer	Double Cut Veneer
Split Top File/File	22	84	29	261	38	FLT2284-29F2K2ST	\$3,077		
Kneespace Credenza	22	84	29	261	38	FLV2284-29F2K2ST		\$4,185	\$4,603
	22	78	29	253	35	FLT2278-29F2K2ST	\$3,008		
	22	78	29	253	35	FLV2278-29F2K2ST		\$4,089	\$4,499
	22	72	29	245	32	FLT2272-29F2K2ST	\$2,941		
	22	72	29	245	32	FLV2272-29F2K2ST		\$3,997	\$4,396
	22	66	29	227	30	FLT2266-29F2K2ST	\$2,874		
	22	66	29	227	30	FLV2266-29F2K2ST		\$3,904	\$4,294
	22	60	29	219	27	FLT2260-29F2K2ST	\$2,808		
	22	60	29	219	27	FLV2260-29F2K2ST		\$3,812	\$4,194

modesty panel options:

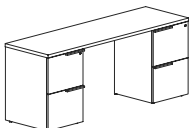


Features:

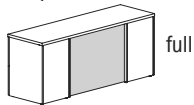
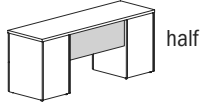
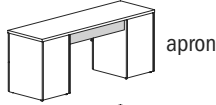
- eased edge profile user side
- built in horizontal wire channel
- 5”h back apron rail standard in kneespace
- pedestal front locking

Options:

- must specify chassis grain direction on double cut veneer, see pages 13-15 for details
- fixed half or full modesty panel available, specify style; add \$161 list for laminate panel or \$201 list for veneer panel, see page 25 for details
- removable modesty panel available, specify; add \$245 list for laminate or \$324 for veneer panel, see page 25 for details
- veneer drawer fronts in paint available, specify paint color and add \$337 list; see page 16 for details
- on laminate units, contrasting worksurface tops and drawer fronts available, no upcharge; specify color, see page 16 for details
- ledge pulls standard; prism pulls available, specify and see page 9

Description	D	W	H	CTN WT	CU FT	① Model	HPL Laminate	Flat Cut Veneer	Double Cut Veneer
File/File Kneespace Credenza 	22	84	29	265	38	FLT2284-29F2K2	\$2,801		
	22	84	29	265	38	FLV2284-29F2K2		\$3,910	\$4,299
	22	78	29	257	35	FLT2278-29F2K2	\$2,733		
	22	78	29	257	35	FLV2278-29F2K2		\$3,813	\$4,195
	22	72	29	249	32	FLT2272-29F2K2	\$2,667		
	22	72	29	249	32	FLV2272-29F2K2		\$3,720	\$4,093
	22	66	29	230	30	FLT2266-29F2K2	\$2,601		
	22	66	29	230	30	FLV2266-29F2K2		\$3,629	\$3,992
	22	60	29	222	27	FLT2260-29F2K2	\$2,532		
	22	60	29	222	27	FLV2260-29F2K2		\$3,536	\$3,891

modesty panel options:



Features:

- eased edge profile user side
- 5”h back apron rail standard in kneespace
- pedestal front locking

Options:

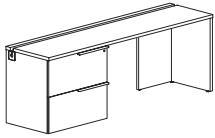
- must specify chassis grain direction on double cut veneer, see pages 13-15 for details
- fixed half or full modesty panel available, specify style; add \$161 list for laminate panel or \$201 list for veneer panel, see page 25 for details
- removable modesty panel available, specify; add \$245 list for laminate or \$324 for veneer panel, see page 25 for details
- veneer drawer fronts in paint available, specify paint color and add \$337 list; see page 16 for details
- on laminate units, contrasting worksurface tops and drawer fronts available, no upcharge; specify color, see page 16 for details
- ledge pulls standard; prism pulls available, specify and see page 9
- interior horizontal wire manager with end grommets available, specify and add \$180 list; see page 40 for details
- top grommet available, specify location; add \$128 list each; see page 45 for details
- worksurface power available, specify “to accommodate EC26” on your purchase order; EC26 unit must be ordered separately, see page 45

To Order, Specify:

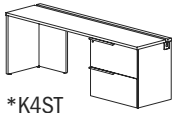
① Laminate Model #	② Laminate Type	③ Laminate Selection		④ Metal Color	⑤ Other Product Options
Laminate (FLT)	HPL	See Laminate Selection		See Metal Finish Color Options	See list of options for each specific unit; Specify and add accordingly.

① Veneer Model #	② Wood Species	③ Wood Finish		④ Metal Color	⑤ Other Product Options
Veneer (FLV)	Flat Cut CH1 Cherry MA1 Maple WA1 Walnut BO1 Black Oak	See Flat Cut Wood Finish Options		See Metal Finish Color Options	See list of options for each specific unit; Specify and add accordingly.
		ⓐ Wood Finish	ⓑ Chassis Grain Direction		
	Double Cut DC1 Double Cut	See Double Cut Wood Finish Options	For Double Cut Only: Vertical Horizontal		

Description	D	W	H	CTN WT	CU FT	① Model	HPL Laminate	Flat Cut Veneer	Double Cut Veneer
Lateral File Pedestal Credenza with Continuous Wire Channel - Split Top	22	96	29	269	43	FLT2296-29FK4ST	\$2,716		
	22	96	29	269	43	FLV2296-29FK4ST		\$3,681	\$4,049
	22	96	29	269	43	FLT2296-29F4KST	\$2,716		
	22	96	29	269	43	FLV2296-29F4KST		\$3,681	\$4,049
	22	90	29	261	40	FLT2290-29FK4ST	\$2,642		
	22	90	29	261	40	FLV2290-29FK4ST		\$3,582	\$3,939
	22	90	29	261	40	FLT2290-29F4KST	\$2,642		
	22	90	29	261	40	FLV2290-29F4KST		\$3,582	\$3,939
	22	84	29	254	38	FLT2284-29FK4ST	\$2,571		
	22	84	29	254	38	FLV2284-29FK4ST		\$3,480	\$3,830
	22	84	29	254	38	FLT2284-29F4KST	\$2,571		
	22	84	29	254	38	FLV2284-29F4KST		\$3,480	\$3,830
	22	78	29	246	35	FLT2278-29FK4ST	\$2,503		
	22	78	29	246	35	FLV2278-29FK4ST		\$3,386	\$3,723
	22	78	29	246	35	FLT2278-29F4KST	\$2,503		
	22	78	29	246	35	FLV2278-29F4KST		\$3,386	\$3,723
	22	72	29	238	32	FLT2272-29FK4ST	\$2,436		
	22	72	29	238	32	FLV2272-29FK4ST		\$3,292	\$3,622
	22	72	29	238	32	FLT2272-29F4KST	\$2,436		
	22	72	29	238	32	FLV2272-29F4KST		\$3,292	\$3,622

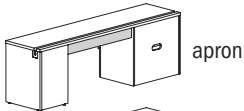


*4KST shown

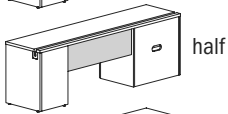


*K4ST

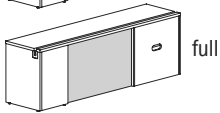
modesty panel options:



apron



half



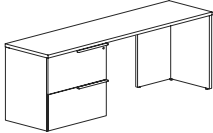
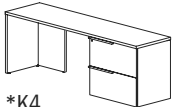
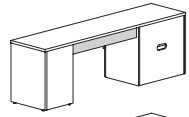
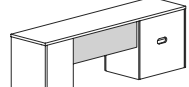
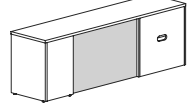
full

Features:

- eased edge profile user side
- built in horizontal wire channel
- 5”h back apron rail standard in kneespace
- pedestal front locking

Options:

- must specify chassis grain direction on double cut veneer, see pages 13-15 for details
- fixed half or full modesty panel available, specify style; add \$161 list for laminate panel or \$201 list for veneer panel, see page 25 for details
- removable modesty panel available, specify; add \$245 list for laminate or \$324 for veneer panel, see page 25 for details
- veneer drawer fronts in paint available, specify paint color and add \$337 list; see page 16 for details
- on laminate units, contrasting worksurface tops and drawer fronts available, no upcharge; specify color, see page 16 for details
- ledge pulls standard; prism pulls available, specify and see page 9
- knee clearance end panel available 13” depth, specify; no upcharge

Description	D	W	H	CTN WT	CU FT	① Model	HPL Laminate	Flat Cut Veneer	Double Cut Veneer
 <p>*4K shown</p>  <p>*K4</p> <p>modesty panel options:</p>  <p>apron</p>  <p>half</p>  <p>full</p>	22	96	29	275	43	FLT2296-29FK4	\$2,440		
	22	96	29	275	43	FLV2296-29FK4		\$3,406	\$3,747
	22	96	29	275	43	FLT2296-29F4K	\$2,440		
	22	96	29	275	43	FLV2296-29F4K		\$3,406	\$3,747
	22	90	29	267	40	FLT2290-29FK4	\$2,367		
	22	90	29	267	40	FLV2290-29FK4		\$3,306	\$3,636
	22	90	29	267	40	FLT2290-29F4K	\$2,367		
	22	90	29	267	40	FLV2290-29F4K		\$3,306	\$3,636
	22	84	29	259	38	FLT2284-29FK4	\$2,296		
	22	84	29	259	38	FLV2284-29FK4		\$3,205	\$3,526
	22	84	29	259	38	FLT2284-29F4K	\$2,296		
	22	84	29	259	38	FLV2284-29F4K		\$3,205	\$3,526
	22	78	29	251	35	FLT2278-29FK4	\$2,229		
	22	78	29	251	35	FLV2278-29FK4		\$3,110	\$3,422
	22	78	29	251	35	FLT2278-29F4K	\$2,229		
	22	78	29	251	35	FLV2278-29F4K		\$3,110	\$3,422
	22	72	29	243	32	FLT2272-29FK4	\$2,161		
	22	72	29	243	32	FLV2272-29FK4		\$3,017	\$3,317
22	72	29	243	32	FLT2272-29F4K	\$2,161			
22	72	29	243	32	FLV2272-29F4K		\$3,017	\$3,317	

Features:

- eased edge profile user side
- 5”h back apron rail standard in kneespace
- pedestal front locking

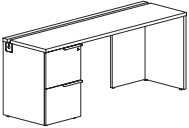
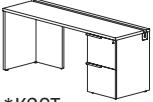
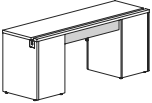
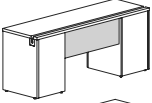
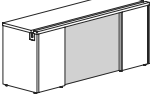
Options:

- must specify chassis grain direction on double cut veneer, see pages 13-15 for details
- fixed half or full modesty panel available, specify style; add \$161 list for laminate panel or \$201 list for veneer panel, see page 25 for details
- removable modesty panel available, specify; add \$245 list for laminate or \$324 for veneer panel, see page 25 for details
- veneer drawer fronts in paint available, specify paint color and add \$337 list; see page 16 for details
- on laminate units, contrasting worksurface tops and drawer fronts available, no upcharge; specify color, see page 16 for details
- ledge pulls standard; prism pulls available, specify and see page 9
- interior horizontal wire manager with end grommets available, specify and add \$180 list; see page 40 for details
- top grommet available, specify location; add \$128 list each; see page 45 for details
- worksurface power available, specify “to accommodate EC26” on your purchase order; EC26 unit must be ordered separately, see page 45
- knee clearance end panel available 13” depth, specify; no upcharge

To Order, Specify:

① Laminate Model #	② Laminate Type	③ Laminate Selection		④ Metal Color	⑤ Other Product Options
Laminate (FLT)	HPL	See Laminate Selection		See Metal Finish Color Options	See list of options for each specific unit; Specify and add accordingly.

① Veneer Model #	② Wood Species	③ Wood Finish		④ Metal Color	⑤ Other Product Options
Veneer (FLV)	Flat Cut CH1 Cherry MA1 Maple WA1 Walnut BO1 Black Oak	See Flat Cut Wood Finish Options		See Metal Finish Color Options	See list of options for each specific unit; Specify and add accordingly.
		ⓐ Wood Finish	ⓑ Chassis Grain Direction		
	Double Cut DC1 Double Cut	See Double Cut Wood Finish Options	For Double Cut Only: Vertical Horizontal		

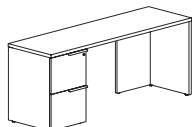
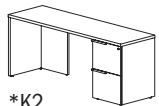
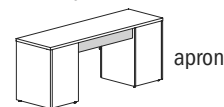
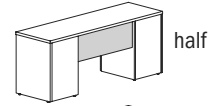
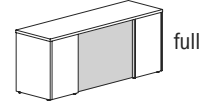
Description	D	W	H	CTN WT	CU FT	① Model	HPL Laminate	Flat Cut Veneer	Double Cut Veneer
File/File Pedestal Credenza with Continuous Wire Channel - Split Top	22	84	29	224	38	FLT2284-29FK2ST	\$2,427		
	22	84	29	224	38	FLV2284-29FK2ST		\$3,278	\$3,606
 *2KST shown	22	84	29	224	38	FLT2284-29F2KST	\$2,427		
	22	84	29	224	38	FLV2284-29F2KST		\$3,278	\$3,606
 *K2ST	22	78	29	216	35	FLT2278-29FK2ST	\$2,362		
	22	78	29	216	35	FLV2278-29FK2ST		\$3,190	\$3,509
modesty panel options:	22	78	29	216	35	FLT2278-29F2KST	\$2,362		
	22	78	29	216	35	FLV2278-29F2KST		\$3,190	\$3,509
 apron	22	72	29	208	32	FLT2272-29FK2ST	\$2,301		
	22	72	29	208	32	FLV2272-29FK2ST		\$3,099	\$3,412
 half	22	72	29	208	32	FLT2272-29F2KST	\$2,301		
	22	72	29	208	32	FLV2272-29F2KST		\$3,099	\$3,412
 full	22	66	29	193	30	FLT2266-29FK2ST	\$2,239		
	22	66	29	193	30	FLV2266-29FK2ST		\$3,017	\$3,317
	22	66	29	193	30	FLT2266-29F2KST	\$2,239		
	22	66	29	193	30	FLV2266-29F2KST		\$3,017	\$3,317
	22	60	29	185	27	FLT2260-29FK2ST	\$2,180		
	22	60	29	185	27	FLV2260-29FK2ST		\$2,935	\$3,227
	22	60	29	185	27	FLT2260-29F2KST	\$2,180		
	22	60	29	185	27	FLV2260-29F2KST		\$2,935	\$3,227

Features:

- eased edge profile user side
- built in horizontal wire channel
- 5”h back apron rail standard in kneespace
- pedestal front locking

Options:

- must specify chassis grain direction on double cut veneer, see pages 13-15 for details
- fixed half or full modesty panel available, specify style; add \$161 list for laminate panel or \$201 list for veneer panel, see page 25 for details
- removable modesty panel available, specify; add \$245 list for laminate or \$324 for veneer panel, see page 25 for details
- veneer drawer fronts in paint available, specify paint color and add \$337 list; see page 16 for details
- on laminate units, contrasting worksurface tops and drawer fronts available, no upcharge; specify color, see page 16 for details
- ledge pulls standard; prism pulls available, specify and see page 9
- knee clearance end panel available 13” depth, specify; no upcharge

Description	D	W	H	CTN WT	CU FT	① Model	HPL Laminate	Flat Cut Veneer	Double Cut Veneer
File/File Pedestal Credenza	22	84	29	228	38	FLT2284-29FK2	\$2,150		
	22	84	29	228	38	FLV2284-29FK2		\$3,005	\$3,305
 *2K shown	22	84	29	228	38	FLT2284-29F2K	\$2,150		
	22	84	29	228	38	FLV2284-29F2K		\$3,005	\$3,305
 *K2	22	78	29	220	35	FLT2278-29FK2	\$2,086		
	22	78	29	220	35	FLV2278-29FK2		\$2,913	\$3,205
modesty panel options:	22	78	29	220	35	FLT2278-29F2K	\$2,086		
	22	78	29	220	35	FLV2278-29F2K		\$2,913	\$3,205
 apron	22	72	29	212	32	FLT2272-29FK2	\$2,025		
	22	72	29	212	32	FLV2272-29FK2		\$2,826	\$3,109
 half	22	72	29	212	32	FLT2272-29F2K	\$2,025		
	22	72	29	212	32	FLV2272-29F2K		\$2,826	\$3,109
 full	22	66	29	200	30	FLT2266-29FK2	\$1,962		
	22	66	29	200	30	FLV2266-29FK2		\$2,743	\$3,016
	22	66	29	200	30	FLT2266-29F2K	\$1,962		
	22	66	29	200	30	FLV2266-29F2K		\$2,743	\$3,016
	22	60	29	192	27	FLT2260-29FK2	\$1,906		
	22	60	29	192	27	FLV2260-29FK2		\$2,657	\$2,927
	22	60	29	192	27	FLT2260-29F2K	\$1,906		
	22	60	29	192	27	FLV2260-29F2K		\$2,657	\$2,927

Features:

- eased edge profile user side
- 5”h back apron rail standard in kneespace
- pedestal front locking


Options:

- must specify chassis grain direction on double cut veneer, see pages 13-15 for details
- fixed half or full modesty panel available, specify style; add \$161 list for laminate panel or \$201 list for veneer panel, see page 25 for details
- removable modesty panel available, specify; add \$245 list for laminate or \$324 for veneer panel, see page 25 for details
- veneer drawer fronts in paint available, specify paint color and add \$337 list; see page 16 for details
- on laminate units, contrasting worksurface tops and drawer fronts available, no upcharge; specify color, see page 16 for details
- ledge pulls standard; prism pulls available, specify and see page 9
- interior horizontal wire manager with end grommets available, specify and add \$180 list; see page 40 for details
- top grommet available, specify location; add \$128 list each; see page 45 for details
- worksurface power available, specify “to accommodate EC26” on your purchase order; EC26 unit must be ordered separately, see page 45
- knee clearance end panel available 13” depth, specify; no upcharge

To Order, Specify:

① Laminate Model #	② Laminate Type	③ Laminate Selection		④ Metal Color	⑤ Other Product Options
Laminate (FLT)	HPL	See Laminate Selection		See Metal Finish Color Options	See list of options for each specific unit; Specify and add accordingly.

① Veneer Model #	② Wood Species	③ Wood Finish		④ Metal Color	⑤ Other Product Options
Veneer (FLV)	Flat Cut CH1 Cherry MA1 Maple WA1 Walnut BO1 Black Oak	See Flat Cut Wood Finish Options		See Metal Finish Color Options	See list of options for each specific unit; Specify and add accordingly.
		Ⓐ Wood Finish	Ⓑ Chassis Grain Direction		
	Double Cut DC1 Double Cut	See Double Cut Wood Finish Options	For Double Cut Only: Vertical Horizontal		


Description	D	W	H	CTN WT	CU FT	① Model	HPL Laminate	Flat Cut Veneer	Double Cut Veneer
	22	72	29	151	32	FLT2272-29FK	\$1,370		
	22	72	29	151	32	FLV2272-29FK		\$2,073	\$2,280
	22	66	29	142	30	FLT2266-29FK	\$1,329		
	22	66	29	142	30	FLV2266-29FK		\$2,013	\$2,213

Features:

- freestanding shell, modular pedestal units below and on the following two pages may be ordered: see page 39 for details
- eased edge profile user side

Options:

- must specify chassis grain direction on double cut veneer, see pages 13-15 for details
- top grommet available, specify location and add \$128 list each; see page 46 for details


	Modular File/File Credenza Shell Pedestal	20 15/16	18	28	74	9	FLT2118-CSM2	\$1,117		
		20 15/16	18	28	74	9	FLV2118-CSM2		\$1,675	\$1,845
		20 15/16	15 5/8	28	74	9	FLT2116-CSM2	\$1,104		
		20 15/16	15 5/8	28	74	9	FLV2116-CSM2		\$1,658	\$1,823

Features:

- use inside of credenza shells or return shells, see page 39
- pedestal front locking

Options:

- must specify chassis grain direction on double cut veneer, see pages 13-15 for details
- veneer drawer fronts in paint available, specify paint color and add \$337 list; see page 16 for details
- on laminate units, contrasting fronts available, no upcharge; specify color, see page 16 for details
- ledge pulls standard; prism pulls available, specify and see page 9

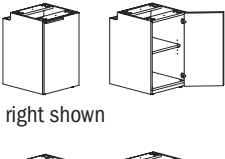
	Modular Box/Box/File Credenza Shell Pedestal	20 15/16	18	28	87	9	FLT2118-CSM1	\$1,122		
		20 15/16	18	28	87	9	FLV2118-CSM1		\$1,685	\$1,854
		20 15/16	15 5/8	28	80	8	FLT2116-CSM1	\$1,109		
		20 15/16	15 5/8	28	80	8	FLV2116-CSM1		\$1,665	\$1,830

Features:

- use inside of credenza shells or return shells, see page 39
- pedestal front locking

Options:

- must specify chassis grain direction on double cut veneer, see pages 13-15 for details
- veneer drawer fronts in paint available, specify paint color and add \$337 list; see page 16 for details
- on laminate units, contrasting fronts available, no upcharge; specify color, see page 16 for details
- ledge pulls standard; prism pulls available, specify and see page 9

	Modular Hinge Door Shell Storage Pedestal	20 15/16	18	28	68	8	FLT2118-CSM7R	\$690		
		20 15/16	18	28	68	8	FLV2118-CSM7R		\$1,038	\$1,141
		20 15/16	18	28	68	8	FLT2118-CSM7L	\$690		
		20 15/16	18	28	68	8	FLV2118-CSM7L		\$1,038	\$1,141
		20 15/16	15 5/8	28	141	16	FLT2116-CSM7R	\$679		
		20 15/16	15 5/8	28	141	16	FLV2116-CSM7R		\$1,018	\$1,120
		20 15/16	15 5/8	28	129	14	FLT2116-CSM7L	\$679		
		20 15/16	15 5/8	28	129	14	FLV2116-CSM7L		\$1,018	\$1,120

Features:

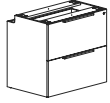
- use inside of credenza shells or return shells, see page 39

Options:

- hinged door compartment has one adjustable shelf
- must specify chassis grain direction on double cut veneer, see pages 13-15 for details
- locking door available, specify and add \$142 list
- veneer door fronts in paint available, specify paint color and add \$337 list; see page 16 for details
- on laminate units, contrasting fronts available, no upcharge; specify color, see page 16 for details
- ledge pulls standard; prism pulls available, specify and see page 9

FLUX - PRIVATE OFFICE

Description	D	W	H	CTN WT	CU FT	① Model	HPL Laminate	Flat Cut Veneer	Double Cut Veneer
Modular Lateral Credenza	20 ¹⁵ / ₁₆	36	28	141	16	FLT2136-CSM4	\$1,358		
Shell Pedestal	20 ¹⁵ / ₁₆	36	28	141	16	FLV2136-CSM4		\$2,036	\$2,240
	20 ¹⁵ / ₁₆	30	28	128	14	FLT2130-CSM4	\$1,323		
	20 ¹⁵ / ₁₆	30	28	128	14	FLV2130-CSM4		\$1,985	\$2,186



Features:

- use inside of credenza shells or return shells, see page 39
- pedestal front locking

Options:

- must specify chassis grain direction on double cut veneer, see pages 13-15 for details
- veneer drawer fronts in paint available, specify paint color and add \$337 list; see page 16 for details
- on laminate units, contrasting fronts available, no upcharge; specify color, see page 16 for details
- ledge pulls standard; prism pulls available, specify and see page 9

Description	D	W	H	CTN WT	CU FT	Model	HPL Laminate	Flat Cut Veneer	Double Cut Veneer
Modular Lateral Credenza	20 ¹⁵ / ₁₆	36	28	141	16	FLT2136-CSM3	\$1,364		
Shell Pedestal	20 ¹⁵ / ₁₆	36	28	141	16	FLV2136-CSM3		\$2,047	\$2,252
	20 ¹⁵ / ₁₆	30	28	128	14	FLT2130-CSM3	\$1,329		
	20 ¹⁵ / ₁₆	30	28	128	14	FLV2130-CSM3		\$1,996	\$2,197



Features:

- use inside of credenza shells or return shells, see page 39
- pedestal front locking

Options:

- must specify chassis grain direction on double cut veneer, see pages 13-15 for details
- veneer drawer fronts in paint available, specify paint color and add \$337 list; see page 16 for details
- on laminate units, contrasting fronts available, no upcharge; specify color, see page 16 for details
- ledge pulls standard; prism pulls available, specify and see page 9

To Order, Specify:

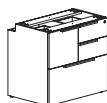
① Laminate Model #	② Laminate Type	③ Laminate Selection	④ Metal Color	⑤ Other Product Options
Laminate (FLT)	HPL	See Laminate Selection	See Metal Finish Color Options	See list of options for each specific unit; Specify and add accordingly.

① Veneer Model #	② Wood Species	③ Wood Finish	④ Metal Color	⑤ Other Product Options	
Veneer (FLV)	Flat Cut CH1 Cherry MA1 Maple WA1 Walnut BO1 Black Oak	See Flat Cut Wood Finish Options	See Metal Finish Color Options	See list of options for each specific unit; Specify and add accordingly.	
	Double Cut DC1 Double Cut	<table border="1"> <thead> <tr> <th>ⓐ Wood Finish</th> <th>ⓑ Chassis Grain Direction</th> </tr> </thead> <tbody> <tr> <td>See Double Cut Wood Finish Options</td> <td>For Double Cut Only: Vertical Horizontal</td> </tr> </tbody> </table>			ⓐ Wood Finish
ⓐ Wood Finish	ⓑ Chassis Grain Direction				
See Double Cut Wood Finish Options	For Double Cut Only: Vertical Horizontal				

Description	D	W	H	CTN WT	CU FT	① Model	HPL Laminate	Flat Cut Veneer	Double Cut Veneer
Modular Credenza Shell	20 15/16	30	28	138	14	FLT2130-CSMRM	\$1,438		
Multi-File Pedestal	20 15/16	30	28	138	14	FLV2130-CSMRM		\$2,160	\$2,376
	20 15/16	30	28	138	14	FLT2130-CSMLM	\$1,438		
	20 15/16	30	28	138	14	FLV2130-CSMLM		\$2,160	\$2,376



right shown



left

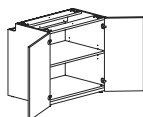
Features:

- use inside of credenza shells or return shells, see page 39
- pedestal front locking

Options:

- must specify chassis grain direction on double cut veneer, see pages 13-15 for details
- veneer drawer fronts in paint available, specify paint color and add \$337 list; see page 16 for details
- on laminate units, contrasting fronts available, no upcharge; specify color, see page 16 for details
- ledge pulls standard; prism pulls available, specify and see page 9

Modular Hinge Door Credenza Shell Pedestal	20 15/16	36	28	122	16	FLT2136-CSM7	\$1,151		
	20 15/16	36	28	122	16	FLV2136-CSM7		\$1,728	\$1,898
	20 15/16	30	28	108	14	FLT2130-CSM7	\$1,104		
	20 15/16	30	28	108	14	FLV2130-CSM7		\$1,659	\$1,824



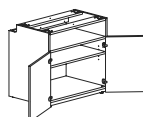
Features:

- use inside of credenza shells or return shells, see page 39
- hinged door compartment has one adjustable shelf

Options:

- must specify chassis grain direction on double cut veneer, see pages 13-15 for details
- locking doors available, specify and add \$142 list
- veneer door fronts in paint available, specify paint color and add \$337 list; see page 16 for details
- on laminate units, contrasting laminate door fronts available, no upcharge; specify laminate color, see page 16 for details
- ledge pulls standard; prism pulls available, specify and see page 9

Modular Hinge Door Credenza Shell Pedestal	20 15/16	36	28	132	16	FLT2136-CSM8	\$1,168		
	20 15/16	36	28	132	16	FLV2136-CSM8		\$1,753	\$1,930
	20 15/16	30	28	116	14	FLT2130-CSM8	\$1,123		
	20 15/16	30	28	116	14	FLV2130-CSM8		\$1,688	\$1,856



Features:

- use inside of credenza shells or return shells, see page 39
- hinged door compartment has one adjustable shelf

Options:

- must specify chassis grain direction on double cut veneer, see pages 13-15 for details
- locking doors available, specify and add \$142 list
- veneer door fronts in paint available, specify paint color and add \$337 list; see page 16 for details
- on laminate units, contrasting laminate door fronts available, no upcharge; specify laminate color, see page 16 for details
- ledge pulls standard; prism pulls available, specify and see page 9

Modular Open Credenza Shell Compartment	20 15/16	36	28	101	16	FLT2136-CSM0	\$1,019		
	20 15/16	36	28	101	16	FLV2136-CSM0		\$1,530	\$1,684
	20 15/16	30	28	91	14	FLT2130-CSM0	\$995		
	20 15/16	30	28	91	14	FLV2130-CSM0		\$1,493	\$1,642



Features:

- use inside of credenza shells or return shells, see page 39
- compartment has one adjustable shelf

Options:

- must specify chassis grain direction on double cut veneer, see pages 13-15 for details

Description	D	W	H	CTN WT	CU FT	① Model	HPL Laminate	Flat Cut Veneer	Double Cut Veneer
Mobile Pedestal	18	15 ½	25	91	6	FLT1816-25FMP	\$1,348		
	18	15 ½	25	91	6	FLV1816-25FMP		\$1,807	\$1,986



Features:

- box, box file only; letter width pedestal
- pedestal front locking
- no additional top needed
- dual wheel casters

Options:

- must specify chassis grain direction on double cut veneer, see pages 13-15 for details
- ledge pulls standard; prism pulls available, specify and see page 9

Box/File Mobile Pedestal	D	W	H	CTN WT	CU FT	Model	HPL Laminate	Flat Cut Veneer	Double Cut Veneer
Box/File Mobile Pedestal	18	15 ¾	21	67	5	FLT1816-21FMP	\$1,213		
	18	15 ¾	21	67	5	FLV1816-21FMP		\$1,691	\$1,859



Features:

- dual wheel casters
- pedestal front locking

Options:

- must specify chassis grain direction on double cut veneer, see pages 13-15 for details
- veneer drawer fronts in paint available, specify paint color and add \$337 list; see page 16 for details
- on laminate units, contrasting fronts available, no upcharge; specify color, see page 16 for details
- ledge pulls standard; prism pulls available, specify and see page 9
- round or square seat cushion available, see page 17 for more details and page 213 for pricing

Mobile Pedestal - Top Storage	D	W	H	CTN WT	CU FT	Model	HPL Laminate	Flat Cut Veneer	Double Cut Veneer
Mobile Pedestal - Top Storage	12 ¾	15 ¾	22	65	7	FLT1816-21FMPT	\$1,330		
	12 ¾	15 ¾	22	65	7	FLV1816-21FMPT		\$1,819	\$2,000



Features:

- pedestal front locking

Options:

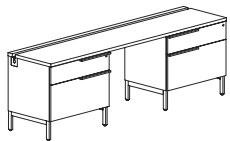
- must specify chassis grain direction on double cut veneer, see pages 13-15 for details
- veneer drawer front available in contrasting paint color, specify paint color and add \$337 list
- laminate drawer fronts available in contrasting color, no upcharge, specify color; see pages 14 for details

To Order, Specify:

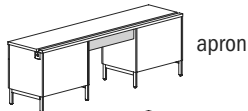
① Laminate Model #	② Laminate Type	③ Laminate Selection	④ Metal Color	⑤ Other Product Options
Laminate (FLT)	HPL	See Laminate Selection	See Metal Finish Color Options	See list of options for each specific unit; Specify and add accordingly.

① Veneer Model #	② Wood Species	③ Wood Finish	④ Metal Color	⑤ Other Product Options	
Veneer (FLV)	Flat Cut CH1 Cherry MA1 Maple WA1 Walnut BO1 Black Oak	See Flat Cut Wood Finish Options	See Metal Finish Color Options	See list of options for each specific unit; Specify and add accordingly.	
	Double Cut DC1 Double Cut	<table border="1"> <thead> <tr> <th>ⓐ Wood Finish</th> <th>ⓑ Chassis Grain Direction</th> </tr> </thead> <tbody> <tr> <td>See Double Cut Wood Finish Options</td> <td>For Double Cut Only: Vertical Horizontal</td> </tr> </tbody> </table>			ⓐ Wood Finish
ⓐ Wood Finish	ⓑ Chassis Grain Direction				
See Double Cut Wood Finish Options	For Double Cut Only: Vertical Horizontal				

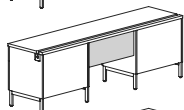
Description	D	W	H	CTN WT	CU FT	① Model	HPL Laminate	Flat Cut Veneer	Double Cut Veneer
Split Top Box/File Kneespace	22	96	29	314	43	FLT2296-29L6K6ST	\$3,898		
Credenza - Flush Legs	22	96	29	314	43	FLV2296-29L6K6ST		\$4,979	\$5,476
	22	90	29	307	40	FLT2290-29L6K6ST	\$3,792		
	22	90	29	307	40	FLV2290-29L6K6ST		\$4,841	\$5,325



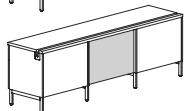
modesty panel options:



apron



half



full

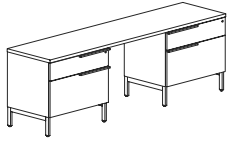
Features:

- eased edge profile user side
- built in horizontal wire channel
- 5”h back apron rail standard in kneespace
- pedestal front locking

Options:

- must specify chassis grain direction on double cut veneer, see pages 13-15 for details
- concealed box drawer(s) available, specify location in unit; add \$234 list for each laminate drawer or \$357 for each veneer drawer, see page 25 for details
- fixed half or full modesty panel available, specify style; add \$161 list for laminate panel or \$201 list for veneer panel, see page 25 for details
- veneer drawer fronts in paint available, specify paint color and add \$337 list; see page 16 for details
- on laminate units, contrasting worksurface tops and drawer fronts available, no upcharge; specify color, see page 16 for details
- ledge pulls standard; prism pulls available, specify and see page 9

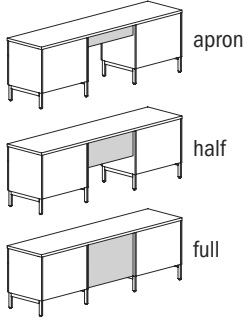
Description	D	W	H	CTN WT	CU FT	1 Model	HPL Laminate	Flat Cut Veneer	Double Cut Veneer
Box/File Kneespace Credenza - Flush Legs	22	96	29	320	43	FLT2296-29L6K6	\$3,623		
	22	96	29	320	43	FLV2296-29L6K6		\$4,703	\$5,174
	22	90	29	320	40	FLT2290-29L6K6	\$3,518		
	22	90	29	320	40	FLV2290-29L6K6		\$4,567	\$5,024



Features:

- eased edge profile user side
- 5" h back apron rail standard in kneespace
- pedestal front locking

modesty panel options:



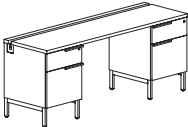
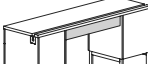
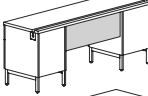
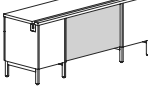
Options:

- must specify chassis grain direction on double cut veneer, see pages 13-15 for details
- concealed box drawer(s) available, specify location in unit; add \$234 list for each laminate drawer or \$357 for each veneer drawer, see page 25 for details
- fixed half or full modesty panel available, specify style; add \$161 list for laminate panel or \$201 list for veneer panel, see page 25 for details
- veneer drawer fronts in paint available, specify paint color and add \$337 list; see page 16 for details
- on laminate units, contrasting worksurface tops and drawer fronts available, no upcharge; specify color, see page 16 for details
- ledge pulls standard; prism pulls available, specify and see page 9
- interior horizontal wire manager with end grommets available, specify and add \$180 list; see page 40 for details
- top grommet available, specify location; add \$128 list each; see page 45 for details
- worksurface power available, specify "to accommodate EC26" on your purchase order; EC26 unit must be ordered separately, see page 45

To Order, Specify:

1 Laminate Model #	2 Laminate Type	3 Laminate Selection	4 Metal Color	5 Other Product Options
Laminate (FLT)	HPL	See Laminate Selection	See Metal Finish Color Options	See list of options for each specific unit; Specify and add accordingly.

1 Veneer Model #	2 Wood Species	3 Wood Finish	4 Metal Color	5 Other Product Options	
Veneer (FLV)	Flat Cut CH1 Cherry MA1 Maple WA1 Walnut BO1 Black Oak	See Flat Cut Wood Finish Options	See Metal Finish Color Options	See list of options for each specific unit; Specify and add accordingly.	
	Double Cut DC1 Double Cut	<table border="1"> <thead> <tr> <th>3a Wood Finish</th> <th>3b Chassis Grain Direction</th> </tr> </thead> <tbody> <tr> <td>See Double Cut Wood Finish Options</td> <td>For Double Cut Only: Vertical Horizontal</td> </tr> </tbody> </table>			3a Wood Finish
3a Wood Finish	3b Chassis Grain Direction				
See Double Cut Wood Finish Options	For Double Cut Only: Vertical Horizontal				

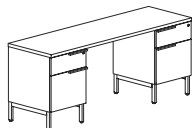
Description	D	W	H	CTN WT	CU FT	① Model	HPL Laminate	Flat Cut Veneer	Double Cut Veneer
Split Top Box/File Kneespace Credenza - Flush Legs	22	84	29	247	38	FLT2284-29L5K5ST	\$3,414		
	22	84	29	247	38	FLV2284-29L5K5ST		\$4,352	\$4,786
 modesty panel options:  apron  half  full	22	78	29	240	35	FLT2278-29L5K5ST	\$3,323		
	22	78	29	240	35	FLV2278-29L5K5ST		\$4,230	\$4,656
	22	72	29	233	32	FLT2272-29L5K5ST	\$3,235		
	22	72	29	233	32	FLV2272-29L5K5ST		\$4,115	\$4,527
	22	66	29	219	30	FLT2266-29L5K5ST	\$3,160		
	22	66	29	219	30	FLV2266-29L5K5ST		\$4,022	\$4,423
	22	60	29	212	27	FLT2260-29L5K5ST	\$3,088		
	22	60	29	212	27	FLV2260-29L5K5ST		\$3,926	\$4,321

Features:

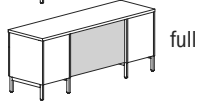
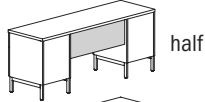
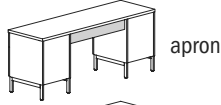
- eased edge profile user side
- built in horizontal wire channel
- 5”h back apron rail standard in kneespace
- pedestal front locking

Options:

- must specify chassis grain direction on double cut veneer, see pages 13-15 for details
- fixed half or full modesty panel available, specify style; add \$161 list for laminate panel or \$201 list for veneer panel, see page 25 for details
- veneer drawer fronts in paint available, specify paint color and add \$337 list; see page 16 for details
- on laminate units, contrasting worksurface tops and drawer fronts available, no upcharge; specify color, see page 16 for details
- ledge pulls standard; prism pulls available, specify and see page 9

Description	D	W	H	CTN WT	CU FT	① Model	HPL Laminate	Flat Cut Veneer	Double Cut Veneer
Box/File Kneespace Credenza - Flush Legs 	22	84	29	252	38	FLT2284-29L5K5	\$3,138		
	22	84	29	252	38	FLV2284-29L5K5		\$4,075	\$4,483
	22	78	29	245	35	FLT2278-29L5K5	\$3,048		
	22	78	29	245	35	FLV2278-29L5K5		\$3,957	\$4,353
	22	72	29	237	32	FLT2272-29L5K5	\$2,958		
	22	72	29	237	32	FLV2272-29L5K5		\$3,841	\$4,225
	22	66	29	222	30	FLT2266-29L5K5	\$2,884		
	22	66	29	222	30	FLV2266-29L5K5		\$3,746	\$4,120
	22	60	29	215	27	FLT2260-29L5K5	\$2,813		
	22	60	29	215	27	FLV2260-29L5K5		\$3,652	\$4,020

modesty panel options:



Features:

- eased edge profile user side
- 5”h back apron rail standard in kneespace
- pedestal front locking

Options:

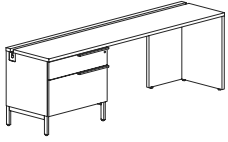
- must specify chassis grain direction on double cut veneer, see pages 13-15 for details
- fixed half or full modesty panel available, specify style; add \$161 list for laminate panel or \$201 list for veneer panel, see page 25 for details
- veneer drawer fronts in paint available, specify paint color and add \$337 list; see page 16 for details
- on laminate units, contrasting worksurface tops and drawer fronts available, no upcharge; specify color, see page 16 for details
- ledge pulls standard; prism pulls available, specify and see page 9
- interior horizontal wire manager with end grommets available, specify and add \$180 list; see page 40 for details
- top grommet available, specify location; add \$128 list each; see page 45 for details
- worksurface power available, specify “to accommodate EC26” on your purchase order; EC26 unit must be ordered separately, see page 45

To Order, Specify:

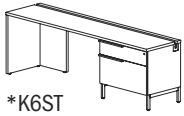
① Laminate Model #	② Laminate Type	③ Laminate Selection	④ Metal Color	⑤ Other Product Options
Laminate (FLT)	HPL	See Laminate Selection	See Metal Finish Color Options	See list of options for each specific unit; Specify and add accordingly.

① Veneer Model #	② Wood Species	③ Wood Finish	④ Metal Color	⑤ Other Product Options
Veneer (FLV)	Flat Cut CH1 Cherry MA1 Maple WA1 Walnut BO1 Black Oak	See Flat Cut Wood Finish Options	See Metal Finish Color Options	See list of options for each specific unit; Specify and add accordingly.
		③a Wood Finish See Double Cut Wood Finish Options		

Description	D	W	H	CTN WT	CU FT	① Model	HPL Laminate	Flat Cut Veneer	Double Cut Veneer
Split Top Open Corner Lateral Credenza - Flush Legs	22	96	29	251	43	FLT2296-29LK6ST	\$3,004		
	22	96	29	251	43	FLV2296-29LK6ST		\$3,815	\$4,196
	22	96	29	251	43	FLT2296-29L6KST	\$3,004		
	22	96	29	251	43	FLV2296-29L6KST		\$3,815	\$4,196
	22	90	29	244	40	FLT2290-29LK6ST	\$2,936		
	22	90	29	244	40	FLV2290-29LK6ST		\$3,728	\$4,102
	22	90	29	256	40	FLT2290-29L6KST	\$2,936		
	22	90	29	256	40	FLV2290-29L6KST		\$3,728	\$4,102



*6KST shown



*K6ST

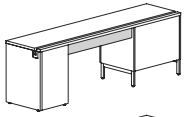
Features:

- eased edge profile user side
- built in horizontal wire channel
- 5”h back apron rail standard in kneespace
- pedestal front locking

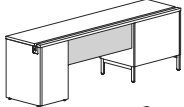
Options:

- must specify chassis grain direction on double cut veneer, see pages 13-15 for details
- concealed box drawer available, specify; add \$234 list for each laminate drawer or \$357 for each veneer drawer, see page 25 for details
- fixed half or full modesty panel available, specify style; add \$161 list for laminate panel or \$201 list for veneer panel, see page 25 for details
- veneer drawer fronts in paint available, specify paint color and add \$337 list; see page 16 for details
- on laminate units, contrasting worksurface tops and drawer fronts available, no upcharge; specify color, see page 16 for details
- ledge pulls standard; prism pulls available, specify and see page 9
- knee clearance end panel available 13” depth, specify; no upcharge

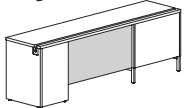
modesty panel options:



apron

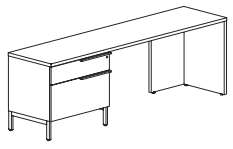


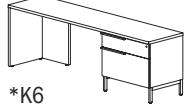
half



full

FLUX - PRIVATE OFFICE

Description	D	W	H	CTN WT	CU FT	① Model	HPL Laminate	Flat Cut Veneer	Double Cut Veneer
Open Corner Lateral Credenza - Flush Legs  *6K shown	22	96	29	256	43	FLT2296-29LK6	\$2,727		
	22	96	29	256	43	FLV2296-29LK6		\$3,540	\$3,893
	22	96	29	256	43	FLT2296-29L6K	\$2,727		
	22	96	29	256	43	FLV2296-29L6K		\$3,540	\$3,893
	22	90	29	249	40	FLT2290-29LK6	\$2,658		
	22	90	29	249	40	FLV2290-29LK6		\$3,454	\$3,800
	22	90	29	249	40	FLT2290-29L6K	\$2,658		
	22	90	29	249	40	FLV2290-29L6K		\$3,454	\$3,800



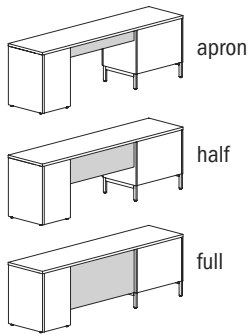
Features:

- eased edge profile user side
- 5" h back apron rail standard in kneespace
- pedestal front locking

Options:

- must specify chassis grain direction on double cut veneer, see pages 13-15 for details
- concealed box drawer available, specify; add \$234 list for each laminate drawer or \$357 for each veneer drawer, see page 25 for details
- fixed half or full modesty panel available, specify style; add \$161 list for laminate panel or \$201 list for veneer panel, see page 25 for details
- veneer drawer fronts in paint available, specify paint color and add \$337 list; see page 16 for details
- on laminate units, contrasting worksurface tops and drawer fronts available, no upcharge; specify color, see page 16 for details
- ledge pulls standard; prism pulls available, specify and see page 9
- interior horizontal wire manager with end grommets available, specify and add \$180 list; see page 40 for details
- top grommet available, specify location; add \$128 list each; see page 45 for details
- worksurface power available, specify "to accommodate EC26" on your purchase order; EC26 unit must be ordered separately, see page 45
- knee clearance end panel available 13" depth, specify; no upcharge

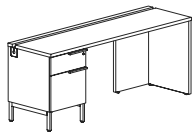

modesty panel options:



To Order, Specify:

① Laminate Model #	② Laminate Type	③ Laminate Selection		④ Metal Color	⑤ Other Product Options
Laminate (FLT)	HPL	See Laminate Selection		See Metal Finish Color Options	See list of options for each specific unit; Specify and add accordingly.

① Veneer Model #	② Wood Species	③ Wood Finish		④ Metal Color	⑤ Other Product Options
Veneer (FLV)	Flat Cut CH1 Cherry MA1 Maple WA1 Walnut BO1 Black Oak	See Flat Cut Wood Finish Options		See Metal Finish Color Options	See list of options for each specific unit; Specify and add accordingly.
		③a Wood Finish	③b Chassis Grain Direction		
	Double Cut DC1 Double Cut	See Double Cut Wood Finish Options	For Double Cut Only: Vertical Horizontal		

Description	D	W	H	CTN WT	CU FT	① Model	HPL Laminate	Flat Cut Veneer	Double Cut Veneer
Split Top Open Corner Credenza - Flush Legs	22	84	29	211	38	FLT2284-29LK5ST	\$2,921		
	22	84	29	211	38	FLV2284-29LK5ST		\$3,665	\$4,032
 *5KST shown	22	84	29	211	38	FLT2284-29L5KST	\$2,921		
	22	84	29	211	38	FLV2284-29L5KST		\$3,665	\$4,032
 *K5ST	22	78	29	218	35	FLT2278-29LK5ST	\$2,868		
	22	78	29	218	35	FLV2278-29LK5ST		\$3,598	\$3,959
	22	78	29	218	35	FLT2278-29L5KST	\$2,868		
	22	78	29	218	35	FLV2278-29L5KST		\$3,598	\$3,959
	22	72	29	177	32	FLT2272-29LK5ST	\$2,818		
	22	72	29	177	32	FLV2272-29LK5ST		\$3,532	\$3,885
	22	72	29	177	32	FLT2272-29L5KST	\$2,818		
	22	72	29	177	32	FLV2272-29L5KST		\$3,532	\$3,885

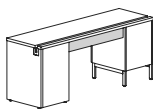
Features:

- eased edge profile user side
- built in horizontal wire channel
- 5”h back apron rail standard in kneespace
- pedestal front locking

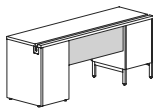
Options:

- must specify chassis grain direction on double cut veneer, see pages 13-15 for details
- fixed half or full modesty panel available, specify style; add \$161 list for laminate panel or \$201 list for veneer panel, see page 25 for details
- veneer drawer fronts in paint available, specify paint color and add \$337 list; see page 16 for details
- ledge pulls standard; prism pulls available, specify and see page 9
- knee clearance end panel available 13” depth, specify; no upcharge

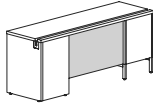
modesty panel options:



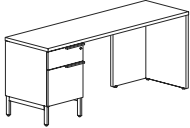
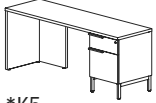
apron



half



full

Description	D	W	H	CTN WT	CU FT	① Model	HPL Laminate	Flat Cut Veneer	Double Cut Veneer
Open Corner Credenza - Flush Legs  *5K shown  *K5	22	84	29	216	38	FLT2284-29LK5	\$2,646		
	22	84	29	216	38	FLV2284-29LK5		\$3,390	\$3,729
	22	84	29	216	38	FLT2284-29L5K	\$2,646		
	22	84	29	216	38	FLV2284-29L5K		\$3,390	\$3,729
	22	78	29	208	35	FLT2278-29LK5	\$2,592		
	22	78	29	208	35	FLV2278-29LK5		\$3,324	\$3,657
	22	78	29	208	35	FLT2278-29L5K	\$2,592		
	22	78	29	208	35	FLV2278-29L5K		\$3,324	\$3,657
	22	72	29	201	32	FLT2272-29LK5	\$2,541		
	22	72	29	201	32	FLV2272-29LK5		\$3,257	\$3,584
	22	72	29	201	32	FLT2272-29L5K	\$2,541		
	22	72	29	201	32	FLV2272-29L5K		\$3,257	\$3,584

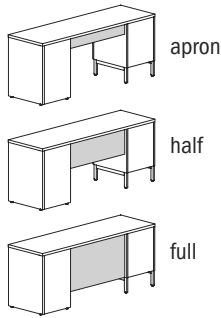
Features:

- eased edge profile user side
- 5”h back apron rail standard in kneespace
- pedestal front locking

Options:

- must specify chassis grain direction on double cut veneer, see pages 13-15 for details
- fixed half or full modesty panel available, specify style; add \$161 list for laminate panel or \$201 list for veneer panel, see page 25 for details
- veneer drawer fronts in paint available, specify paint color and add \$337 list; see page 16 for details
- on laminate units, contrasting worksurface tops and drawer fronts available, no upcharge; specify color, see page 16 for details
- ledge pulls standard; prism pulls available, specify and see page 9
- interior horizontal wire manager with end grommets available, specify and add \$180 list; see page 40 for details
- top grommet available, specify location; add \$128 list each; see page 45 for details
- worksurface power available, specify “to accommodate EC26” on your purchase order; EC26 unit must be ordered separately, see page 45
- knee clearance end panel available 13” depth, specify; no upcharge

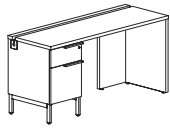
modesty panel options:



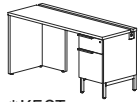
To Order, Specify:

① Laminate Model #	② Laminate Type	③ Laminate Selection		④ Metal Color	⑤ Other Product Options
Laminate (FLT)	HPL	See Laminate Selection		See Metal Finish Color Options	See list of options for each specific unit; Specify and add accordingly.
① Veneer Model #	② Wood Species	③ Wood Finish		④ Metal Color	⑤ Other Product Options
Veneer (FLV)	Flat Cut CH1 Cherry MA1 Maple WA1 Walnut BO1 Black Oak	See Flat Cut Wood Finish Options		See Metal Finish Color Options	See list of options for each specific unit; Specify and add accordingly.
	Double Cut DC1 Double Cut	3a Wood Finish See Double Cut Wood Finish Options	3b Chassis Grain Direction For Double Cut Only: Vertical Horizontal		

Description	D	W	H	CTN WT	CU FT	① Model	HPL Laminate	Flat Cut Veneer	Double Cut Veneer
Split Top Open Corner Credenza - Flush Legs	22	66	29	184	30	FLT2266-29LK5ST	\$2,208		
	22	66	29	184	30	FLV2266-29LK5ST		\$2,755	\$3,027
	22	66	29	184	30	FLT2266-29L5KST	\$2,208		
	22	66	29	184	30	FLV2266-29L5KST		\$2,755	\$3,027
	22	60	29	177	27	FLT2260-29LK5ST	\$2,170		
	22	60	29	177	27	FLV2260-29LK5ST		\$2,704	\$2,975
	22	60	29	177	27	FLT2260-29L5KST	\$2,170		
	22	60	29	177	27	FLV2260-29L5KST		\$2,704	\$2,975



*5KST shown



*K5ST

Features:

- eased edge profile user side
- built in horizontal wire channel
- 5”h back apron rail standard in kneespace
- pedestal front locking

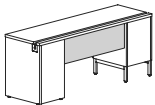
Options:

- must specify chassis grain direction on double cut veneer, see pages 13-15 for details
- fixed half or full modesty panel available, specify style; add \$161 list for laminate panel or \$201 list for veneer panel, see page 25 for details
- veneer drawer fronts in paint available, specify paint color and add \$337 list; see page 16 for details
- on laminate units, contrasting worksurface tops and drawer fronts available, no upcharge; specify color, see page 16 for details
- ledge pulls standard; prism pulls available, specify and see page 9
- knee clearance end panel available 13” depth, specify; no upcharge

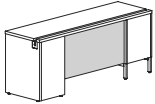
modesty panel options:



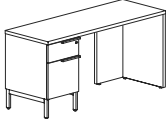
apron

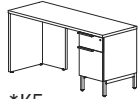


half



full

Description	D	W	H	CTN WT	CU FT	① Model	HPL Laminate	Flat Cut Veneer	Double Cut Veneer
Open Corner Credenza - Flush Legs  *5K shown	22	66	29	187	30	FLT2266-29LK5	\$1,933		
	22	66	29	187	30	FLV2266-29LK5		\$2,479	\$2,726
	22	66	29	187	30	FLT2266-29L5K	\$1,933		
	22	66	29	187	30	FLV2266-29L5K		\$2,479	\$2,726
	22	60	29	180	27	FLT2260-29LK5	\$1,895		
	22	60	29	180	27	FLV2260-29LK5		\$2,429	\$2,674
	22	60	29	180	27	FLT2260-29L5K	\$1,895		
	22	60	29	180	27	FLV2260-29L5K		\$2,429	\$2,674



*K5

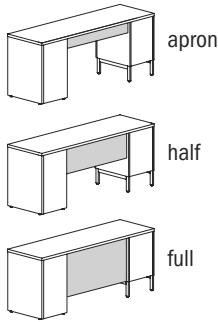
Features:

- eased edge profile user side
- 5”h back apron rail standard in kneespace
- pedestal front locking

Options:

- must specify chassis grain direction on double cut veneer, see pages 13-15 for details
- fixed half or full modesty panel available, specify style; add \$161 list for laminate panel or \$201 list for veneer panel, see page 25 for details
- veneer drawer fronts in paint available, specify paint color and add \$337 list; see page 16 for details
- on laminate units, contrasting worksurface tops and drawer fronts available, no upcharge; specify color, see page 16 for details
- ledge pulls standard; prism pulls available, specify and see page 9
- interior horizontal wire manager with end grommets available, specify and add \$180 list; see page 40 for details
- top grommet available, specify location; add \$128 list each; see page 45 for details
- worksurface power available, specify “to accommodate EC26” on your purchase order; EC26 unit must be ordered separately, see page 45
- knee clearance end panel available 13” depth, specify; no upcharge

modesty panel options:



To Order, Specify:

① Laminate Model #	② Laminate Type	③ Laminate Selection		④ Metal Color	⑤ Other Product Options
Laminate (FLT)	HPL	See Laminate Selection		See Metal Finish Color Options	See list of options for each specific unit; Specify and add accordingly.
① Veneer Model #	② Wood Species	③ Wood Finish		④ Metal Color	⑤ Other Product Options
Veneer (FLV)	Flat Cut CH1 Cherry MA1 Maple WA1 Walnut BO1 Black Oak	See Flat Cut Wood Finish Options		See Metal Finish Color Options	See list of options for each specific unit; Specify and add accordingly.
	Double Cut DC1 Double Cut	③a Wood Finish See Double Cut Wood Finish Options	③b Chassis Grain Direction For Double Cut Only: Vertical Horizontal		

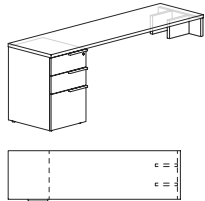
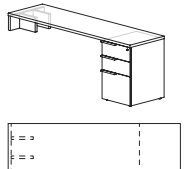







Description	D	W	H	CTN WT	CU FT	① Model	HPL Laminate	Flat Cut Veneer	Double Cut Veneer
<p>*2K shown</p> <p>*K2</p>	22	96	29	172	43	FLT2296-29FPCK2	\$2,268		
	22	96	29	172	43	FLV2296-29FPCK2		\$3,164	\$3,481
	22	96	29	172	43	FLT2296-29FPC2K	\$2,268		
	22	96	29	172	43	FLV2296-29FPC2K		\$3,164	\$3,481
	22	90	29	171	40	FLT2290-29FPCK2	\$2,212		
	22	90	29	171	40	FLV2290-29FPCK2		\$3,089	\$3,398
	22	90	29	171	40	FLT2290-29FPC2K	\$2,212		
	22	90	29	171	40	FLV2290-29FPC2K		\$3,089	\$3,398
	22	84	29	166	38	FLT2284-29FPCK2	\$2,159		
	22	84	29	166	38	FLV2284-29FPCK2		\$3,013	\$3,314
	22	84	29	166	38	FLT2284-29FPC2K	\$2,159		
	22	84	29	166	38	FLV2284-29FPC2K		\$3,013	\$3,314
	22	78	29	161	35	FLT2278-29FPCK2	\$2,107		
	22	78	29	161	35	FLV2278-29FPCK2		\$2,940	\$3,235
	22	78	29	161	35	FLT2278-29FPC2K	\$2,107		
	22	78	29	161	35	FLV2278-29FPC2K		\$2,940	\$3,235
	22	72	29	156	32	FLT2272-29FPCK2	\$2,056		
	22	72	29	156	32	FLV2272-29FPCK2		\$2,868	\$3,154
22	72	29	156	32	FLT2272-29FPC2K	\$2,056			
22	72	29	156	32	FLV2272-29FPC2K		\$2,868	\$3,154	

Features:

- intended to be used with secondary height credenzas; specify mounting location when ordering credenzas, see page 17
- eased edge profile user side
- pedestal front locking

Options:

- must specify chassis grain direction on double cut veneer, see pages 13-15 for details
- veneer drawer fronts in paint available, specify paint color and add \$337 list; see page 16 for details
- on laminate units, contrasting fronts available, no upcharge; specify color, see page 16 for details
- ledge pulls standard; prism pulls available, specify and see page 9
- top grommet available, specify location and add \$128 list each; see page 46 for details
- worksurface power available, specify "to accommodate EC26" on your purchase order; EC26 unit must be ordered separately, see page 46

Description	D	W	H	CTN WT	CU FT	1 Model	HPL Laminate	Flat Cut Veneer	Double Cut Veneer
Box/Box/File Peninsula Credenza	22	96	29	174	43	FLT2296-29FPCK1	\$2,274		
	22	96	29	174	43	FLV2296-29FPCK1		\$3,174	\$3,492
	22	96	29	174	43	FLT2296-29FPC1K	\$2,274		
	22	96	29	174	43	FLV2296-29FPC1K		\$3,174	\$3,492
	22	90	29	173	40	FLT2290-29FPCK1	\$2,220		
	22	90	29	173	40	FLV2290-29FPCK1		\$3,096	\$3,408
	22	90	29	173	40	FLT2290-29FPC1K	\$2,220		
	22	90	29	173	40	FLV2290-29FPC1K		\$3,096	\$3,408
	22	84	29	168	38	FLT2284-29FPCK1	\$2,165		
	22	84	29	168	38	FLV2284-29FPCK1		\$3,020	\$3,324
	22	84	29	168	38	FLT2284-29FPC1K	\$2,165		
	22	84	29	168	38	FLV2284-29FPC1K		\$3,020	\$3,324
	22	78	29	165	35	FLT2278-29FPCK1	\$2,112		
	22	78	29	165	35	FLV2278-29FPCK1		\$2,946	\$3,243
	22	78	29	165	35	FLT2278-29FPC1K	\$2,112		
	22	78	29	165	35	FLV2278-29FPC1K		\$2,946	\$3,243
	22	72	29	158	32	FLT2272-29FPCK1	\$2,062		
	22	72	29	158	32	FLV2272-29FPCK1		\$2,875	\$3,163
	22	72	29	158	32	FLT2272-29FPC1K	\$2,062		
	22	72	29	158	32	FLV2272-29FPC1K		\$2,875	\$3,163

*1K shown

*K1

Features:

- intended to be used with secondary height credenzas; specify mounting location when ordering credenzas, see page 17
- eased edge profile user side
- pedestal front locking

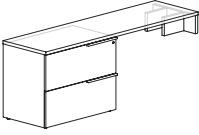

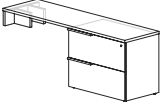

Options:

- must specify chassis grain direction on double cut veneer, see pages 13-15 for details
- veneer drawer fronts in paint available, specify paint color and add \$337 list; see page 16 for details
- on laminate units, contrasting fronts available, no upcharge; specify color, see page 16 for details
- ledge pulls standard; prism pulls available, specify and see page 9
- top grommet available, specify location and add \$128 list each; see page 46 for details
- worksurface power available, specify "to accommodate EC26" on your purchase order; EC26 unit must be ordered separately, see page 46

To Order, Specify:

1 Laminate Model #	2 Laminate Type	3 Laminate Selection	4 Metal Color	5 Other Product Options
Laminate (FLT)	HPL	See Laminate Selection	See Metal Finish Color Options	See list of options for each specific unit; Specify and add accordingly.

1 Veneer Model #	2 Wood Species	3 Wood Finish	4 Metal Color	5 Other Product Options	
Veneer (FLV)	Flat Cut CH1 Cherry MA1 Maple WA1 Walnut BO1 Black Oak	See Flat Cut Wood Finish Options	See Metal Finish Color Options	See list of options for each specific unit; Specify and add accordingly.	
	Double Cut DC1 Double Cut	<table border="1"> <thead> <tr> <th>3a Wood Finish</th> <th>3b Chassis Grain Direction</th> </tr> </thead> <tbody> <tr> <td>See Double Cut Wood Finish Options</td> <td>For Double Cut Only: Vertical Horizontal</td> </tr> </tbody> </table>			3a Wood Finish
3a Wood Finish	3b Chassis Grain Direction				
See Double Cut Wood Finish Options	For Double Cut Only: Vertical Horizontal				

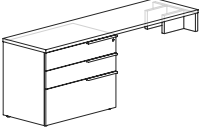



Description	D	W	H	CTN WT	CU FT	① Model	HPL Laminate	Flat Cut Veneer	Double Cut Veneer
Lateral File Peninsula Credenza   *4K shown   *K4	22	96	29	224	43	FLT2296-29FPCK4	\$2,497		
	22	96	29	224	43	FLV2296-29FPCK4		\$3,483	\$3,833
	22	96	29	224	43	FLT2296-29FPC4K	\$2,497		
	22	96	29	224	43	FLV2296-29FPC4K		\$3,483	\$3,833
	22	90	29	219	40	FLT2290-29FPCK4	\$2,435		
	22	90	29	219	40	FLV2290-29FPCK4		\$3,400	\$3,742
	22	90	29	219	40	FLT2290-29FPC4K	\$2,435		
	22	90	29	219	40	FLV2290-29FPC4K		\$3,400	\$3,742
	22	84	29	214	38	FLT2284-29FPCK4	\$2,376		
	22	84	29	214	38	FLV2284-29FPCK4		\$3,316	\$3,648
	22	84	29	214	38	FLT2284-29FPC4K	\$2,376		
	22	84	29	214	38	FLV2284-29FPC4K		\$3,316	\$3,648
	22	78	29	209	35	FLT2278-29FPCK4	\$2,319		
	22	78	29	209	35	FLV2278-29FPCK4		\$3,237	\$3,562
	22	78	29	209	35	FLT2278-29FPC4K	\$2,319		
	22	78	29	209	35	FLV2278-29FPC4K		\$3,237	\$3,562
	22	72	29	205	32	FLT2272-29FPCK4	\$2,262		
	22	72	29	205	32	FLV2272-29FPCK4		\$3,157	\$3,473
22	72	29	205	32	FLT2272-29FPC4K	\$2,262			
22	72	29	205	32	FLV2272-29FPC4K		\$3,157	\$3,473	

Features:

- intended to be used with secondary height credenzas; specify mounting location when ordering credenzas, see page 17
- eased edge profile user side
- pedestal front locking

Options:

- must specify chassis grain direction on double cut veneer, see pages 13-15 for details
- veneer drawer fronts in paint available, specify paint color and add \$337 list; see page 16 for details
- on laminate units, contrasting fronts available, no upcharge; specify color, see page 16 for details
- ledge pulls standard; prism pulls available, specify and see page 9
- top grommet available, specify location and add \$128 list each; see page 46 for details
- worksurface power available, specify "to accommodate EC26" on your purchase order; EC26 unit must be ordered separately, see page 46

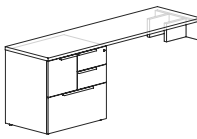
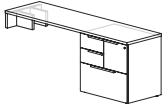
Box/Box/File Lateral Peninsula Credenza   *3K shown   *K3	22	96	29	224	43	FLT2296-29FPCK3	\$2,506		
	22	96	29	224	43	FLV2296-29FPCK3		\$3,499	\$3,847
	22	96	29	224	43	FLT2296-29FPC3K	\$2,506		
	22	96	29	224	43	FLV2296-29FPC3K		\$3,499	\$3,847
	22	90	29	220	40	FLT2290-29FPCK3	\$2,444		
	22	90	29	220	40	FLV2290-29FPCK3		\$3,413	\$3,754
	22	90	29	220	40	FLT2290-29FPC3K	\$2,444		
	22	90	29	220	40	FLV2290-29FPC3K		\$3,413	\$3,754
	22	84	29	215	38	FLT2284-29FPCK3	\$2,386		
	22	84	29	215	38	FLV2284-29FPCK3		\$3,330	\$3,662
	22	84	29	215	38	FLT2284-29FPC3K	\$2,386		
	22	84	29	215	38	FLV2284-29FPC3K		\$3,330	\$3,662
	22	78	29	211	35	FLT2278-29FPCK3	\$2,327		
	22	78	29	211	35	FLV2278-29FPCK3		\$3,248	\$3,574
	22	78	29	211	35	FLT2278-29FPC3K	\$2,327		
	22	78	29	211	35	FLV2278-29FPC3K		\$3,248	\$3,574
	22	72	29	206	32	FLT2272-29FPCK3	\$2,270		
	22	72	29	206	32	FLV2272-29FPCK3		\$3,170	\$3,488
22	72	29	206	32	FLT2272-29FPC3K	\$2,270			
22	72	29	206	32	FLV2272-29FPC3K		\$3,170	\$3,488	

Features:

- intended to be used with secondary height credenzas; specify mounting location when ordering credenzas, see page 17
- eased edge profile user side
- pedestal front locking

Options:

- must specify chassis grain direction on double cut veneer, see pages 13-15 for details
- veneer drawer fronts in paint available, specify paint color and add \$337 list; see page 16 for details
- on laminate units, contrasting fronts available, no upcharge; specify color, see page 16 for details
- ledge pulls standard; prism pulls available, specify and see page 9
- top grommet available, specify location and add \$128 list each; see page 46 for details
- worksurface power available, specify "to accommodate EC26" on your purchase order; EC26 unit must be ordered separately, see page 46

Description	D	W	H	CTN WT	CU FT	1 Model	HPL Laminate	Flat Cut Veneer	Double Cut Veneer
 left shown  right	22	96	29	225	43	FLT2296-29FPMRR	\$2,635		
	22	96	29	225	43	FLV2296-29FPMRR		\$3,678	\$4,044
	22	96	29	225	43	FLT2296-29FPMLR	\$2,635		
	22	96	29	225	43	FLV2296-29FPMLR		\$3,678	\$4,044
	22	90	29	220	40	FLT2290-29FPMRR	\$2,570		
	22	90	29	220	40	FLV2290-29FPMRR		\$3,588	\$3,948
	22	90	29	220	40	FLT2290-29FPMLR	\$2,570		
	22	90	29	220	40	FLV2290-29FPMLR		\$3,588	\$3,948
	22	84	29	214	38	FLT2284-29FPMRR	\$2,507		
	22	84	29	214	38	FLV2284-29FPMRR		\$3,501	\$3,850
	22	84	29	214	38	FLT2284-29FPMLR	\$2,507		
	22	84	29	214	38	FLV2284-29FPMLR		\$3,501	\$3,850
	22	78	29	209	35	FLT2278-29FPMRR	\$2,447		
	22	78	29	209	35	FLV2278-29FPMRR		\$3,416	\$3,758
	22	78	29	209	35	FLT2278-29FPMLR	\$2,447		
	22	78	29	209	35	FLV2278-29FPMLR		\$3,416	\$3,758
	22	72	29	204	32	FLT2272-29FPMRR	\$2,387		
	22	72	29	204	32	FLV2272-29FPMRR		\$3,331	\$3,664
	22	72	29	204	32	FLT2272-29FPMLR	\$2,387		
	22	72	29	204	32	FLV2272-29FPMLR		\$3,331	\$3,664

Features:

- intended to be used with secondary height credenzas; specify mounting location when ordering credenzas, see page 17
- eased edge profile user side
- pedestal front locking

Options:

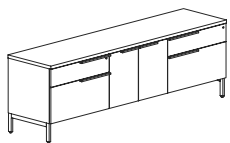
- must specify chassis grain direction on double cut veneer, see pages 13-15 for details
- veneer drawer fronts in paint available, specify paint color and add \$337 list; see page 16 for details
- on laminate units, contrasting fronts available, no upcharge; specify color, see page 16 for details
- ledge pulls standard; prism pulls available, specify and see page 9
- top grommet available, specify location and add \$128 list each; see page 46 for details
- worksurface power available, specify "to accommodate EC26" on your purchase order; EC26 unit must be ordered separately, see page 46

To Order, Specify:

1 Laminate Model #	2 Laminate Type	3 Laminate Selection	4 Metal Color	5 Other Product Options
Laminate (FLT)	HPL	See Laminate Selection	See Metal Finish Color Options	See list of options for each specific unit; Specify and add accordingly.

1 Veneer Model #	2 Wood Species	3 Wood Finish	4 Metal Color	5 Other Product Options
Veneer (FLV)	Flat Cut CH1 Cherry MA1 Maple WA1 Walnut BO1 Black Oak	See Flat Cut Wood Finish Options	See Metal Finish Color Options	See list of options for each specific unit; Specify and add accordingly.
	Double Cut DC1 Double Cut	3a Wood Finish See Double Cut Wood Finish Options		

Description	D	W	H	CTN WT	CU FT	① Model	HPL Laminate	Flat Cut Veneer	Double Cut Veneer
Storage Credenza - Flush Legs	22	96	29	377	43	FLT2296-29L676	\$4,225		
	22	96	29	377	43	FLV2296-29L676		\$5,486	\$6,036
	22	90	29	359	40	FLT2290-29L676	\$4,100		
	22	90	29	359	40	FLV2290-29L676		\$5,324	\$5,858
	22	84	29	340	38	FLT2284-29L676	\$3,980		
	22	84	29	340	38	FLV2284-29L676		\$5,168	\$5,685



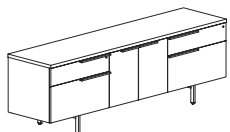
Features:

- eased edge profile user side
- pedestal front locking
- hinged door compartment has one adjustable shelf

Options:

- must specify chassis grain direction on double cut veneer, see pages 13-15 for details
- locking door available, specify and add \$142 list
- concealed box drawer(s) available, specify location in unit; add \$234 list for each laminate drawer or \$357 for each veneer drawer, see page 25 for details
- veneer door and drawer fronts in paint available, specify paint color and add \$337; see page 16 for details
- on laminate units, contrasting worksurface tops and door fronts available, no upcharge; specify laminate color, see page 16 for details
- ledge pulls standard; prism pulls available, specify and see page 9
- oval grommets in back panel can be eliminated upon request, no upcharge
- interior horizontal wire manager with end grommets available, specify and add \$180 list; see page 40 for details
- top grommet available, specify location; add \$128 list each; see page 46 for details
- worksurface power available, specify "to accommodate EC26" on your purchase order; EC26 unit must be ordered separately, see page 46

Storage Credenza - Inset Legs	22	90	29	369	40	FLT2290-29S676	\$4,100		
	22	90	29	369	40	FLV2290-29S676		\$5,324	\$5,858



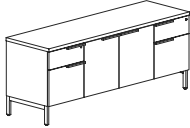
Features:

- eased edge profile user side
- pedestal front locking
- hinged door compartment has one adjustable shelf

Options:

- must specify chassis grain direction on double cut veneer, see pages 13-15 for details
- locking door available, specify and add \$142 list
- concealed box drawer(s) available, specify location in unit; add \$234 list for each laminate drawer or \$357 for each veneer drawer, see page 25 for details
- veneer door and drawer fronts in paint available, specify paint color and add \$337; see page 16 for details
- on laminate units, contrasting worksurface tops and door fronts available, no upcharge; specify laminate color, see page 16 for details
- ledge pulls standard; prism pulls available, specify and see page 9
- oval grommets in back panel can be eliminated upon request, no upcharge
- interior horizontal wire manager with end grommets available, specify and add \$180 list; see page 40 for details
- top grommet available, specify location; add \$128 list each; see page 46 for details
- worksurface power available, specify "to accommodate EC26" on your purchase order; EC26 unit must be ordered separately, see page 46

FLUX - PRIVATE OFFICE

Description	D	W	H	CTN WT	CU FT	① Model	HPL Laminate	Flat Cut Veneer	Double Cut Veneer
	22	78	29	311	35	FLT2278-29L575	\$3,727		
	22	78	29	311	35	FLV2278-29L575		\$4,838	\$5,322
	22	72	29	292	32	FLT2272-29L575	\$3,622		
	22	72	29	292	32	FLV2272-29L575		\$4,701	\$5,171
	22	66	29	273	30	FLT2266-29L575	\$3,562		
	22	66	29	273	30	FLV2266-29L575		\$4,622	\$5,086
	22	60	29	255	27	FLT2260-29L575	\$3,498		
	22	60	29	255	27	FLV2260-29L575		\$4,539	\$4,993

Features:

- eased edge profile user side
- pedestal front locking
- hinged door compartment has one adjustable shelf

Options:

- must specify chassis grain direction on double cut veneer, see pages 13-15 for details
- locking door available, specify and add \$142 list
- concealed box drawer(s) available, specify location in unit; add \$234 list for each laminate drawer or \$357 for each veneer drawer, see page 25 for details
- veneer door and drawer fronts in paint available, specify paint color and add \$337; see page 16 for details
- on laminate units, contrasting worksurface tops and door fronts available, no upcharge; specify laminate color, see page 16 for details
- ledge pulls standard; prism pulls available, specify and see page 9
- oval grommets in back panel can be eliminated upon request, no upcharge
- interior horizontal wire manager with end grommets available, specify and add \$180 list; see page 40 for details
- top grommet available, specify location; add \$128 list each; see page 46 for details
- worksurface power available, specify "to accommodate EC26" on your purchase order; EC26 unit must be ordered separately, see page 46

Description	D	W	H	CTN WT	CU FT	① Model	HPL Laminate	Flat Cut Veneer	Double Cut Veneer
	22	72	29	298	32	FLT2272-29S575	\$3,622		
	22	72	29	298	32	FLV2272-29S575		\$4,701	\$5,171
	22	60	29	254	27	FLT2260-29S575	\$3,498		
	22	60	29	254	27	FLV2260-29S575		\$4,539	\$4,993

Features:

- eased edge profile user side
- pedestal front locking
- hinged door compartment has one adjustable shelf

Options:

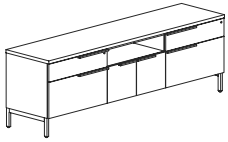
- must specify chassis grain direction on double cut veneer, see pages 13-15 for details
- locking door available, specify and add \$142 list
- concealed box drawer(s) available, specify location in unit; add \$234 list for each laminate drawer or \$357 for each veneer drawer, see page 25 for details
- veneer door and drawer fronts in paint available, specify paint color and add \$337; see page 16 for details
- on laminate units, contrasting worksurface tops and door fronts available, no upcharge; specify laminate color, see page 16 for details
- ledge pulls standard; prism pulls available, specify and see page 9
- oval grommets in back panel can be eliminated upon request, no upcharge
- interior horizontal wire manager with end grommets available, specify and add \$180 list; see page 40 for details
- top grommet available, specify location; add \$128 list each; see page 46 for details
- worksurface power available, specify "to accommodate EC26" on your purchase order; EC26 unit must be ordered separately, see page 46

To Order, Specify:

① Laminate Model #	② Laminate Type	③ Laminate Selection	④ Metal Color	⑤ Other Product Options
Laminate (FLT)	TFL	See Laminate Selection	See Metal Finish Color Options	See list of options for each specific unit; Specify and add accordingly.
	HLP			

① Veneer Model #	② Wood Species	③ Wood Finish	④ Metal Color	⑤ Other Product Options
Veneer (FLV)	Flat Cut CH1 Cherry MA1 Maple WA1 Walnut BO1 Black Oak	See Flat Cut Wood Finish Options	See Metal Finish Color Options	See list of options for each specific unit; Specify and add accordingly.
	Double Cut DC1 Double Cut	③a Wood Finish See Double Cut Wood Finish Options		

Description	D	W	H	CTN WT	CU FT	① Model	HPL Laminate	Flat Cut Veneer	Double Cut Veneer
Box/Lateral Storage Credenza with Open Center - Flush Legs	22	96	29	365	43	FLT2296-29L686	\$4,267		
	22	96	29	365	43	FLV2296-29L686		\$5,540	\$6,095
	22	90	29	355	40	FLT2290-29L686	\$4,144		
	22	90	29	355	40	FLV2290-29L686		\$5,379	\$5,919
	22	84	29	332	38	FLT2284-29L686	\$4,023		
	22	84	29	332	38	FLV2284-29L686		\$5,225	\$5,747



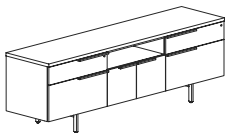
Features:

- eased edge profile user side
- pedestal front locking
- hinged door compartment has one adjustable shelf

Options:

- must specify chassis grain direction on double cut veneer, see pages 13-15 for details
- locking door available, specify and add \$142 list
- concealed box drawer(s) available, specify location in unit; add \$234 list for each laminate drawer or \$357 for each veneer drawer, see page 25 for details
- veneer door and drawer fronts in paint available, specify paint color and add \$337; see page 16 for details
- on laminate units, contrasting worksurface tops and door fronts available, no upcharge; specify laminate color, see page 16 for details
- ledge pulls standard; prism pulls available, specify and see page 9
- oval grommets in back panel can be eliminated upon request, no upcharge
- interior horizontal wire manager with end grommets available, specify and add \$180 list; see page 40 for details
- top grommet available, specify location; add \$128 list each; see page 46 for details
- worksurface power available, specify "to accommodate EC26" on your purchase order; EC26 unit must be ordered separately, see page 46

Box/Lateral Storage Credenza with Open Center - Inset Legs	22	90	29	390	40	FLT2290-29S686	\$4,144		
	22	90	29	390	40	FLV2290-29S686		\$5,379	\$5,919

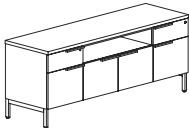


Features:

- eased edge profile user side
- pedestal front locking
- hinged door compartment has one adjustable shelf

Options:

- must specify chassis grain direction on double cut veneer, see pages 13-15 for details
- locking door available, specify and add \$142 list
- concealed box drawer(s) available, specify location in unit; add \$234 list for each laminate drawer or \$357 for each veneer drawer, see page 25 for details
- veneer door and drawer fronts in paint available, specify paint color and add \$337; see page 16 for details
- on laminate units, contrasting worksurface tops and door fronts available, no upcharge; specify laminate color, see page 16 for details
- ledge pulls standard; prism pulls available, specify and see page 9
- oval grommets in back panel can be eliminated upon request, no upcharge
- interior horizontal wire manager with end grommets available, specify and add \$180 list; see page 40 for details
- top grommet available, specify location; add \$128 list each; see page 46 for details
- worksurface power available, specify "to accommodate EC26" on your purchase order; EC26 unit must be ordered separately, see page 46

Description	D	W	H	CTN WT	CU FT	① Model	HPL Laminate	Flat Cut Veneer	Double Cut Veneer
Box/Lateral Storage Credenza with Open Center - Flush Legs 	22	78	29	300	35	FLT2278-29L585	\$3,769		
	22	78	29	300	35	FLV2278-29L585		\$4,893	\$5,383
	22	72	29	288	32	FLT2272-29L585	\$3,662		
	22	72	29	288	32	FLV2272-29L585		\$4,755	\$5,231
	22	66	29	269	30	FLT2266-29L585	\$3,602		
	22	66	29	269	30	FLV2266-29L585		\$4,679	\$5,146
	22	60	29	252	27	FLT2260-29L585	\$3,538		
	22	60	29	252	27	FLV2260-29L585		\$4,595	\$5,054

Features:

- eased edge profile user side
- pedestal front locking
- hinged door compartment has one adjustable shelf

Options:

- must specify chassis grain direction on double cut veneer, see pages 13-15 for details
- locking doors available, specify and add \$142 list
- veneer door and drawer fronts in paint available, specify paint color and add \$337; see page 16 for details
- on laminate units, contrasting worksurface tops and door fronts available, no upcharge; specify laminate color, see page 16 for details
- ledge pulls standard; prism pulls available, specify and see page 9
- oval grommets in back panel can be eliminated upon request, no upcharge
- interior horizontal wire manager with end grommets available, specify and add \$180 list; see page 40 for details
- top grommet available, specify location; add \$128 list each; see page 46 for details
- worksurface power available, specify "to accommodate EC26" on your purchase order; EC26 unit must be ordered separately, see page 46

Box/Lateral Storage Credenza with Open Center - Inset Legs 	22	72	29	295	32	FLT2272-29S585	\$3,662		
	22	72	29	295	32	FLV2272-29S585		\$4,755	\$5,231
	22	60	29	250	27	FLT2260-29S585	\$3,538		
	22	60	29	250	27	FLV2260-29S585		\$4,595	\$5,054

Features:

- eased edge profile user side
- pedestal front locking
- hinged door compartment has one adjustable shelf

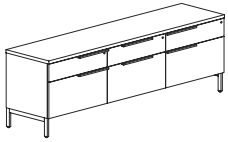
Options:

- must specify chassis grain direction on double cut veneer, see pages 13-15 for details
- locking doors available, specify and add \$142 list
- veneer door and drawer fronts in paint available, specify paint color and add \$337; see page 16 for details
- on laminate units, contrasting worksurface tops and door fronts available, no upcharge; specify laminate color, see page 16 for details
- ledge pulls standard; prism pulls available, specify and see page 9
- oval grommets in back panel can be eliminated upon request, no upcharge
- interior horizontal wire manager with end grommets available, specify and add \$180 list; see page 40 for details
- top grommet available, specify location; add \$128 list each; see page 46 for details
- worksurface power available, specify "to accommodate EC26" on your purchase order; EC26 unit must be ordered separately, see page 46

To Order, Specify:

① Laminate Model #	② Laminate Type	③ Laminate Selection		④ Metal Color	⑤ Other Product Options
Laminate (FLT)	TFL	See Laminate Selection		See Metal Finish Color Options	See list of options for each specific unit; Specify and add accordingly.
	HLP				
① Veneer Model #	② Wood Species	③ Wood Finish		④ Metal Color	⑤ Other Product Options
Veneer (FLV)	Flat Cut CH1 Cherry MA1 Maple WA1 Walnut BO1 Black Oak	See Flat Cut Wood Finish Options		See Metal Finish Color Options	See list of options for each specific unit; Specify and add accordingly.
	Double Cut DC1 Double Cut	③a Wood Finish See Double Cut Wood Finish Options	③b Chassis Grain Direction For Double Cut Only: Vertical Horizontal		

Description	D	W	H	CTN WT	CU FT	① Model	HPL Laminate	Flat Cut Veneer	Double Cut Veneer
Box/Lateral File Credenza - Flush Legs	22	90	29	392	40	FLT2290-29L666	\$4,043		
	22	90	29	392	40	FLV2290-29L666		\$5,251	\$5,777



Features:

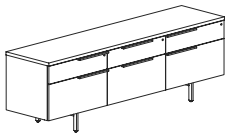
- eased edge profile user side
- pedestal front locking

Options:

- must specify chassis grain direction on double cut veneer, see pages 13-15 for details
- concealed box drawer(s) available, specify location in unit; add \$234 list for each laminate drawer or \$357 for each veneer drawer, see page 25 for details
- veneer drawer fronts in paint available, specify paint color and add \$337 list; see page 16 for details
- on laminate units, contrasting worksurface tops and drawer fronts available, no upcharge; specify color, see page 16 for details
- ledge pulls standard; prism pulls available, specify and see page 9
- oval grommets in back panel can be eliminated upon request, no upcharge
- interior horizontal wire manager with end grommets available, specify and add \$180 list; see page 40 for details
- top grommet available, specify location; add \$128 list each; see page 46 for details

FLUX - PRIVATE OFFICE

Box/Lateral File Credenza - Inset Legs	22	90	29	301	32	FLT2290-29S666	\$4,043		
	22	90	29	301	32	FLV2290-29S666		\$5,251	\$5,777




Features:

- eased edge profile user side
- pedestal front locking

Options:

- must specify chassis grain direction on double cut veneer, see pages 13-15 for details
- concealed box drawer(s) available, specify location in unit; add \$234 list for each laminate drawer or \$357 for each veneer drawer, see page 25 for details
- veneer drawer fronts in paint available, specify paint color and add \$337 list; see page 16 for details
- on laminate units, contrasting worksurface tops and drawer fronts available, no upcharge; specify color, see page 16 for details
- ledge pulls standard; prism pulls available, specify and see page 9
- oval grommets in back panel can be eliminated upon request, no upcharge
- interior horizontal wire manager with end grommets available, specify and add \$180 list; see page 40 for details
- top grommet available, specify location; add \$128 list each; see page 46 for details

Description	D	W	H	CTN WT	CU FT	① Model	HPL Laminate	Flat Cut Veneer	Double Cut Veneer
Box/Lateral File Credenza - Flush Legs 	22	72	29	303	32	FLT2272-29L66	\$3,172		
	22	72	29	303	32	FLV2272-29L66		\$4,115	\$4,527
	22	60	29	268	27	FLT2260-29L66	\$3,071		
	22	60	29	268	27	FLV2260-29L66		\$3,989	\$4,391

Features:

- eased edge profile user side
- pedestal front locking

Options:

- must specify chassis grain direction on double cut veneer, see pages 13-15 for details
- concealed box drawer(s) available, specify location in unit; add \$234 list for each laminate drawer or \$357 for each veneer drawer, see page 25 for details
- veneer drawer fronts in paint available, specify paint color and add \$337 list; see page 16 for details
- on laminate units, contrasting worksurface tops and drawer fronts available, no upcharge; specify color, see page 16 for details
- ledge pulls standard; prism pulls available, specify and see page 9
- oval grommets in back panel can be eliminated upon request, no upcharge
- interior horizontal wire manager with end grommets available, specify and add \$180 list; see page 40 for details
- top grommet available, specify location; add \$128 list each; see page 46 for details

Description	D	W	H	CTN WT	CU FT	Model	HPL Laminate	Flat Cut Veneer	Double Cut Veneer
Box/Lateral File Credenza - Inset Legs 	22	72	29	266	27	FLT2272-29S66	\$3,172		
	22	72	29	266	27	FLV2272-29S66		\$4,115	\$4,527
	22	60	29	323	40	FLT2260-29S66	\$3,071		
	22	60	29	323	40	FLV2260-29S66		\$3,989	\$4,391

Features:

- eased edge profile user side
- pedestal front locking

Options:

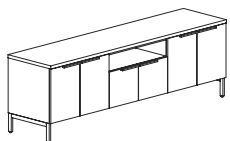
- must specify chassis grain direction on double cut veneer, see pages 13-15 for details
- concealed box drawer(s) available, specify location in unit; add \$234 list for each laminate drawer or \$357 for each veneer drawer, see page 25 for details
- veneer drawer fronts in paint available, specify paint color and add \$337 list; see page 16 for details
- on laminate units, contrasting worksurface tops and drawer fronts available, no upcharge; specify color, see page 16 for details
- ledge pulls standard; prism pulls available, specify and see page 9
- oval grommets in back panel can be eliminated upon request, no upcharge
- interior horizontal wire manager with end grommets available, specify and add \$180 list; see page 40 for details
- top grommet available, specify location; add \$128 list each; see page 46 for details

To Order, Specify:

① Laminate Model #	② Laminate Type	③ Laminate Selection	④ Metal Color	⑤ Other Product Options
Laminate (FLT)	HPL	See Laminate Selection	See Metal Finish Color Options	See list of options for each specific unit; Specify and add accordingly.

① Veneer Model #	② Wood Species	③ Wood Finish	④ Metal Color	⑤ Other Product Options
Veneer (FLV)	Flat Cut CH1 Cherry MA1 Maple WA1 Walnut BO1 Black Oak	See Flat Cut Wood Finish Options	See Metal Finish Color Options	See list of options for each specific unit; Specify and add accordingly.
		③a Wood Finish See Double Cut Wood Finish Options		

Description	D	W	H	CTN WT	CU FT	① Model	HPL Laminate	Flat Cut Veneer	Double Cut Veneer
Six Door Credenza Open Center - Flush Legs	22	96	29	332	43	FLT2296-29L787	\$3,879		
	22	96	29	332	43	FLV2296-29L787		\$5,035	\$5,540
	22	90	29	321	40	FLT2290-29L787	\$3,785		
	22	90	29	321	40	FLV2290-29L787		\$4,916	\$5,407
	22	84	29	296	38	FLT2284-29L787	\$3,686		
	22	84	29	296	38	FLV2284-29L787		\$4,786	\$5,265



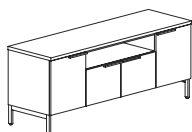
Features:

- eased edge profile user side
- each end compartment has one adjustable shelf

Options:

- must specify chassis grain direction on double cut veneer, see pages 13-15 for details
- locking doors available, specify and add \$426 list
- veneer door fronts in paint available, specify paint color and add \$337 list; see page 16 for details
- on laminate units, contrasting worksurface tops and door fronts available, no upcharge; specify laminate color, see page 16 for details
- ledge pulls standard; prism pulls available, specify and see page 9
- oval grommets in back panel can be eliminated upon request, no upcharge
- interior horizontal wire manager with end grommets available, specify and add \$180 list; see page 40 for details
- top grommet available, specify location; add \$128 list each; see page 46 for details
- worksurface power available, specify "to accommodate EC26" on your purchase order; EC26 unit must be ordered separately, see page 46

Four Door Credenza Open Center - Flush Legs	22	78	29	279	35	FLT2278-29L787	\$3,575		
	22	78	29	279	35	FLV2278-29L787		\$4,642	\$5,105
	22	72	29	265	32	FLT2272-29L787	\$3,461		
	22	72	29	265	32	FLV2272-29L787		\$4,493	\$4,943
	22	66	29	247	30	FLT2266-29L787	\$3,378		
	22	66	29	247	30	FLV2266-29L787		\$4,385	\$4,824
	22	60	29	229	27	FLT2260-29L787	\$3,289		
	22	60	29	229	27	FLV2260-29L787		\$4,270	\$4,699



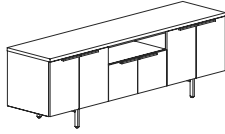
Features:

- eased edge profile user side
- each end compartment has one adjustable shelf

Options:

- must specify chassis grain direction on double cut veneer, see pages 13-15 for details
- locking doors available, specify and add \$426 list
- veneer door fronts in paint available, specify paint color and add \$337 list; see page 16 for details
- on laminate units, contrasting worksurface tops and door fronts available, no upcharge; specify laminate color, see page 16 for details
- ledge pulls standard; prism pulls available, specify and see page 9
- oval grommets in back panel can be eliminated upon request, no upcharge
- interior horizontal wire manager with end grommets available, specify and add \$180 list; see page 40 for details
- top grommet available, specify location; add \$128 list each; see page 46 for details
- worksurface power available, specify "to accommodate EC26" on your purchase order; EC26 unit must be ordered separately, see page 46

Description	D	W	H	CTN WT	CU FT	① Model	HPL Laminate	Flat Cut Veneer	Double Cut Veneer
Six Door Storage with Open Center - Inset Legs	22	90	29	318	40	FLT2290-29S787	\$3,785		
	22	90	29	318	40	FLV2290-29S787		\$4,916	\$5,407



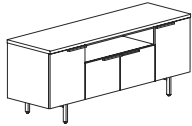
Features:

- eased edge profile user side
- each end compartment has one adjustable shelf

Options:

- must specify chassis grain direction on double cut veneer, see pages 13-15 for details
- locking doors available, specify and add \$426 list
- veneer door fronts in paint available, specify paint color and add \$337 list; see page 16 for details
- on laminate units, contrasting worksurface tops and door fronts available, no upcharge; specify color, see page 16 for details
- ledge pulls standard; prism pulls available, specify and see page 9
- oval grommets in back panel can be eliminated upon request, no upcharge
- interior horizontal wire manager with end grommets available, specify and add \$180 list; see page 40 for details
- top grommet available, specify location; add \$128 list each; see page 46 for details
- worksurface power available, specify "to accommodate EC26" on your purchase order; EC26 unit must be ordered separately, see page 46

Hinge Door Storage with Open Center - Inset Legs	D	W	H	CTN WT	CU FT	① Model	HPL Laminate	Flat Cut Veneer	Double Cut Veneer
	22	72	29	270	32	FLT2272-29S787	\$3,461		
	22	72	29	270	32	FLV2272-29S787		\$4,493	\$4,943
	22	60	29	234	27	FLT2260-29S787	\$3,289		
	22	60	29	234	27	FLV2260-29S787		\$4,270	\$4,699



Features:

- eased edge profile user side
- each end compartment has one adjustable shelf

Options:

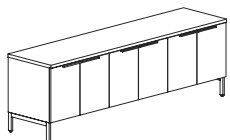
- must specify chassis grain direction on double cut veneer, see pages 13-15 for details
- locking doors available, specify and add \$426 list
- veneer door fronts in paint available, specify paint color and add \$337 list; see page 16 for details
- on laminate units, contrasting worksurface tops and door fronts available, no upcharge; specify color, see page 16 for details
- ledge pulls standard; prism pulls available, specify and see page 9
- oval grommets in back panel can be eliminated upon request, no upcharge
- interior horizontal wire manager with end grommets available, specify and add \$180 list; see page 40 for details
- top grommet available, specify location; add \$128 list each; see page 46 for details
- worksurface power available, specify "to accommodate EC26" on your purchase order; EC26 unit must be ordered separately, see page 46

To Order, Specify:

① Laminate Model #	② Laminate Type	③ Laminate Selection	④ Metal Color	⑤ Other Product Options
Laminate (FLT)	HPL	See Laminate Selection	See Metal Finish Color Options	See list of options for each specific unit; Specify and add accordingly.

① Veneer Model #	② Wood Species	③ Wood Finish	④ Metal Color	⑤ Other Product Options	
Veneer (FLV)	Flat Cut CH1 Cherry MA1 Maple WA1 Walnut BO1 Black Oak	See Flat Cut Wood Finish Options	See Metal Finish Color Options	See list of options for each specific unit; Specify and add accordingly.	
	Double Cut DC1 Double Cut	<table border="1"> <thead> <tr> <th>ⓐ Wood Finish</th> <th>ⓑ Chassis Grain Direction</th> </tr> </thead> <tbody> <tr> <td>See Double Cut Wood Finish Options</td> <td>For Double Cut Only: Vertical Horizontal</td> </tr> </tbody> </table>			ⓐ Wood Finish
ⓐ Wood Finish	ⓑ Chassis Grain Direction				
See Double Cut Wood Finish Options	For Double Cut Only: Vertical Horizontal				

Description	D	W	H	CTN WT	CU FT	① Model	HPL Laminate	Flat Cut Veneer	Double Cut Veneer
Six Door Storage Credenza - Flush Legs	22	96	29	336	43	FLT2296-29L777	\$3,914		
	22	96	29	336	43	FLV2296-29L777		\$5,081	\$5,591
	22	90	29	326	40	FLT2290-29L777	\$3,819		
	22	90	29	326	40	FLV2290-29L777		\$4,958	\$5,455
	22	84	29	302	38	FLT2284-29L777	\$3,730		
	22	84	29	302	38	FLV2284-29L777		\$4,845	\$5,330



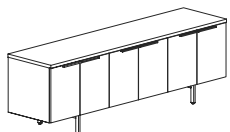
Features:

- eased edge profile user side
- each hinged door compartment has one adjustable shelf

Options:

- must specify chassis grain direction on double cut veneer, see pages 13-15 for details
- locking doors available, specify and add \$426 list
- veneer door fronts in paint available, specify paint color and add \$337 list; see page 16 for details
- on laminate units, contrasting worksurface tops and door fronts available, no upcharge; specify color, see page 16 for details
- ledge pulls standard; prism pulls available, specify and see page 9
- oval grommets in back panel can be eliminated upon request, no upcharge
- interior horizontal wire manager with end grommets available, specify and add \$180 list; see page 40 for details
- top grommet available, specify location; add \$128 list each; see page 46 for details
- worksurface power available, specify "to accommodate EC26" on your purchase order; EC26 unit must be ordered separately, see page 46

Six Door Storage Credenza - Inset Legs	22	90	29	320	40	FLT2290-29S777	\$3,819		
	22	90	29	320	40	FLV2290-29S777		\$4,958	\$5,455

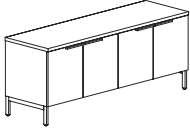


Features:

- eased edge profile user side
- each hinged door compartment has one adjustable shelf

Options:

- must specify chassis grain direction on double cut veneer, see pages 13-15 for details
- locking doors available, specify and add \$426 list
- veneer door fronts in paint available, specify paint color and add \$337 list; see page 16 for details
- on laminate units, contrasting worksurface tops and door fronts available, no upcharge; specify color, see page 16 for details
- ledge pulls standard; prism pulls available, specify and see page 9
- oval grommets in back panel can be eliminated upon request, no upcharge
- interior horizontal wire manager with end grommets available, specify and add \$180 list; see page 40 for details
- top grommet available, specify location; add \$128 list each; see page 46 for details
- worksurface power available, specify "to accommodate EC26" on your purchase order; EC26 unit must be ordered separately, see page 46

Description	D	W	H	CTN WT	CU FT	① Model	HPL Laminate	Flat Cut Veneer	Double Cut Veneer
Four Door Storage Credenza - Flush Legs 	22	78	29	277	35	FLT2278-29L77	\$3,475		
	22	78	29	277	35	FLV2278-29L77		\$4,514	\$4,965
	22	72	29	263	32	FLT2272-29L77	\$3,379		
	22	72	29	263	32	FLV2272-29L77		\$4,387	\$4,826
	22	66	29	239	30	FLT2266-29L77	\$3,270		
	22	66	29	239	30	FLV2266-29L77		\$4,246	\$4,668
	22	60	29	226	27	FLT2260-29L77	\$3,159		
	22	60	29	226	27	FLV2260-29L77		\$4,102	\$4,513

Features:

- eased edge profile user side
- each hinged door compartment has one adjustable shelf

Options:

- must specify chassis grain direction on double cut veneer, see pages 13-15 for details
- locking doors available, specify and add \$284 list
- veneer door fronts in paint available, specify paint color and add \$337 list; see page 16 for details
- on laminate units, contrasting worksurface tops and door fronts available, no upcharge; specify color, see page 16 for details
- ledge pulls standard; prism pulls available, specify and see page 9
- oval grommets in back panel can be eliminated upon request, no upcharge
- interior horizontal wire manager with end grommets available, specify and add \$180 list; see page 40 for details
- top grommet available, specify location; add \$128 list each; see page 46 for details
- worksurface power available, specify "to accommodate EC26" on your purchase order; EC26 unit must be ordered separately, see page 46

Four Door Storage Credenza - Inset Legs 	22	72	29	258	32	FLT2272-29S77	\$3,379		
	22	72	29	258	32	FLV2272-29S77		\$4,387	\$4,826
	22	60	29	224	27	FLT2260-29S77	\$3,159		
	22	60	29	224	27	FLV2260-29S77		\$4,102	\$4,513

Features:

- eased edge profile user side
- each hinged door compartment has one adjustable shelf

Options:

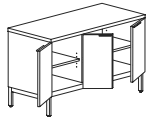
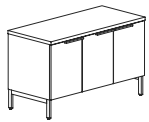
- must specify chassis grain direction on double cut veneer, see pages 13-15 for details
- locking doors available, specify and add \$284 list
- veneer door fronts in paint available, specify paint color and add \$337 list; see page 16 for details
- on laminate units, contrasting worksurface tops and door fronts available, no upcharge; specify color, see page 16 for details
- ledge pulls standard; prism pulls available, specify and see page 9
- oval grommets in back panel can be eliminated upon request, no upcharge
- interior horizontal wire manager with end grommets available, specify and add \$180 list; see page 40 for details
- top grommet available, specify location; add \$128 list each; see page 46 for details
- worksurface power available, specify "to accommodate EC26" on your purchase order; EC26 unit must be ordered separately, see page 46

To Order, Specify:

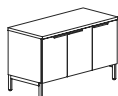
① Laminate Model #	② Laminate Type	③ Laminate Selection	④ Metal Color	⑤ Other Product Options
Laminate (FLT)	HPL	See Laminate Selection	See Metal Finish Color Options	See list of options for each specific unit; Specify and add accordingly.

① Veneer Model #	② Wood Species	③ Wood Finish	④ Metal Color	⑤ Other Product Options
Veneer (FLV)	Flat Cut CH1 Cherry MA1 Maple WA1 Walnut BO1 Black Oak	See Flat Cut Wood Finish Options	See Metal Finish Color Options	See list of options for each specific unit; Specify and add accordingly.
	Double Cut DC1 Double Cut	ⓐ Wood Finish See Double Cut Wood Finish Options		

Description	D	W	H	CTN WT	CU FT	① Model	HPL Laminate	Flat Cut Veneer	Double Cut Veneer
Three Door Storage Credenza - Flush Legs	22	54	29	207	25	FLT2254-29L77R	\$2,921		
	22	54	29	207	25	FLV2254-29L77R		\$3,792	\$4,173
	22	54	29	207	25	FLT2254-29L77L	\$2,921		
	22	54	29	207	25	FLV2254-29L77L		\$3,792	\$4,173
	22	42	29	171	19	FLT2242-29L77R	\$2,798		
	22	42	29	171	19	FLV2242-29L77R		\$3,632	\$3,995
	22	42	29	171	19	FLT2242-29L77L	\$2,798		
	22	42	29	171	19	FLV2242-29L77L		\$3,632	\$3,995



left shown



right

Features:

- eased edge profile user side
- each hinged door compartment has one adjustable shelf

Options:

- must specify chassis grain direction on double cut veneer, see pages 13-15 for details
- locking doors available, specify and add \$284 list
- veneer door fronts in paint available, specify paint color and add \$337 list; see page 16 for details
- on laminate units, contrasting worksurface tops and door fronts available, no upcharge; specify color, see page 16 for details
- ledge pulls standard; prism pulls available, specify and see page 9
- oval grommet in back panel can be eliminated upon request, no upcharge
- interior horizontal wire manager with end grommets available, specify and add \$180 list; see page 40 for details
- top grommet available, specify location; add \$128 list each; see page 46 for details
- worksurface power available, specify "to accommodate EC26" on your purchase order; EC26 unit must be ordered separately, see page 46

Description	D	W	H	CTN WT	CU FT	① Model	HPL Laminate	Flat Cut Veneer	Double Cut Veneer
Two Door Storage - Flush Legs	22	36	29	144	17	FLT2236-29L7	\$2,688		
	22	36	29	144	17	FLV2236-29L7		\$3,490	\$3,837
	22	30	29	126	14	FLT2230-29L7	\$2,635		
	22	30	29	126	14	FLV2230-29L7		\$3,419	\$3,761



Features:

- eased edge profile user side
- hinged door compartment has one adjustable shelf

Options:

- must specify chassis grain direction on double cut veneer, see pages 13-15 for details
- locking doors available, specify and add \$142 list
- veneer door fronts in paint available, specify paint color and add \$337 list; see page 16 for details
- on laminate units, contrasting worksurface tops and door fronts available, no upcharge; specify color, see page 16 for details
- ledge pulls standard; prism pulls available, specify and see page 9
- oval grommet in back panel can be eliminated upon request, no upcharge
- interior horizontal wire manager with end grommets available, specify and add \$180 list; see page 40 for details
- top grommet available, specify location; add \$128 list each; see page 46 for details
- worksurface power available, specify "to accommodate EC26" on your purchase order; EC26 unit must be ordered separately, see page 46

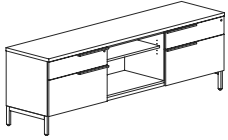
FLUX - PRIVATE OFFICE

To Order, Specify:

① Laminate Model #	② Laminate Type	③ Laminate Selection	④ Metal Color	⑤ Other Product Options
Laminate (FLT)	HPL	See Laminate Selection	See Metal Finish Color Options	See list of options for each specific unit; Specify and add accordingly.

① Veneer Model #	② Wood Species	③ Wood Finish	④ Metal Color	⑤ Other Product Options	
Veneer (FLV)	Flat Cut CH1 Cherry MA1 Maple WA1 Walnut BO1 Black Oak	See Flat Cut Wood Finish Options	See Metal Finish Color Options	See list of options for each specific unit; Specify and add accordingly.	
	Double Cut DC1 Double Cut	<table border="1"> <thead> <tr> <th>③a Wood Finish</th> <th>③b Chassis Grain Direction</th> </tr> </thead> <tbody> <tr> <td>See Double Cut Wood Finish Options</td> <td>For Double Cut Only: Vertical Horizontal</td> </tr> </tbody> </table>			③a Wood Finish
③a Wood Finish	③b Chassis Grain Direction				
See Double Cut Wood Finish Options	For Double Cut Only: Vertical Horizontal				

Description	D	W	H	CTN WT	CU FT	① Model	HPL Laminate	Flat Cut Veneer	Double Cut Veneer
Box/Lateral with Open Storage Credenza - Flush Legs	22	96	29	352	43	FLT2296-29L606	\$3,966		
	22	96	29	352	43	FLV2296-29L606		\$5,150	\$5,666
	22	90	29	345	40	FLT2290-29L606	\$3,871		
	22	90	29	345	40	FLV2290-29L606		\$5,025	\$5,528



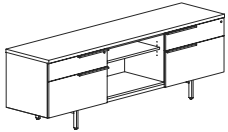
Features:

- eased edge profile user side
- pedestal front locking
- open compartment with adjustable shelf
- shelf 12 1/2"d

Options:

- must specify chassis grain direction on double cut veneer, see pages 13-15 for details
- concealed box drawer(s) available, specify location in unit; add \$234 list for each laminate drawer or \$357 for each veneer drawer, see page 25 for details
- veneer drawer fronts in paint available, specify paint color and add \$337 list; see page 16 for details
- on laminate units, contrasting worksurface tops and drawer fronts available, no upcharge; specify color, see page 16 for details
- ledge pulls standard; prism pulls available, specify and see page 9
- oval grommets in back panel can be eliminated upon request, no upcharge
- interior horizontal wire manager with end grommets available, specify and add \$180 list; see page 40 for details
- top grommet available, specify location; add \$128 list each; see page 46 for details
- worksurface power available, specify "to accommodate EC26" on your purchase order; EC26 unit must be ordered separately, see page 46

Box/Lateral File with Open Storage Credenza - Inset Legs	22	90	29	367	40	FLT2290-29S606	\$3,871		
	22	90	29	367	40	FLV2290-29S606		\$5,025	\$5,528



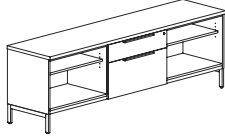
Features:

- eased edge profile user side
- pedestal front locking
- open compartment with adjustable shelf
- shelf 12 1/2"d

Options:

- must specify chassis grain direction on double cut veneer, see pages 13-15 for details
- concealed box drawer(s) available, specify location in unit; add \$234 list for each laminate drawer or \$357 for each veneer drawer, see page 25 for details
- veneer drawer fronts in paint available, specify paint color and add \$337 list; see page 16 for details
- on laminate units, contrasting worksurface tops and drawer fronts available, no upcharge; specify color, see page 16 for details
- ledge pulls standard; prism pulls available, specify and see page 9
- oval grommets in back panel can be eliminated upon request, no upcharge
- interior horizontal wire manager with end grommets available, specify and add \$180 list; see page 40 for details
- top grommet available, specify location; add \$128 list each; see page 46 for details
- worksurface power available, specify "to accommodate EC26" on your purchase order; EC26 unit must be ordered separately, see page 46

Description	D	W	H	CTN WT	CU FT	① Model	HPL Laminate	Flat Cut Veneer	Double Cut Veneer
Box/Lateral with Open Storage Credenza - Flush Legs	22	96	29	320	43	FLT2296-29L060	\$3,727		
	22	96	29	320	43	FLV2296-29L060		\$4,840	\$5,324
	22	90	29	312	40	FLT2290-29L060	\$3,637		
	22	90	29	312	40	FLV2290-29L060		\$4,723	\$5,195



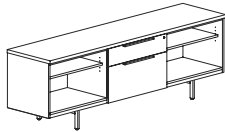
Features:

- eased edge profile user side
- pedestal front locking
- each open compartment has one adjustable shelf
- shelves 12 1/2"d

Options:

- must specify chassis grain direction on double cut veneer, see pages 13-15 for details
- concealed box drawer available, specify; add \$234 list for each laminate drawer or \$357 for each veneer drawer, see page 25 for details
- veneer drawer fronts in paint available, specify paint color and add \$337 list; see page 16 for details
- on laminate units, contrasting worksurface tops and drawer fronts available, no upcharge; specify color, see page 16 for details
- ledge pulls standard; prism pulls available, specify and see page 9
- oval grommets in back panel can be eliminated upon request, no upcharge
- interior horizontal wire manager with end grommets available, specify and add \$180 list; see page 40 for details
- top grommet available, specify location; add \$128 list each; see page 46 for details
- worksurface power available, specify "to accommodate EC26" on your purchase order; EC26 unit must be ordered separately, see page 46

Box/File with Open Storage Credenza - Inset Legs	22	90	29	330	40	FLT2290-29S060	\$3,637		
	22	90	29	330	40	FLV2290-29S060		\$4,723	\$5,195



Features:

- eased edge profile user side
- pedestal front locking
- each open compartment has one adjustable shelf
- shelves 12 1/2"d

Options:

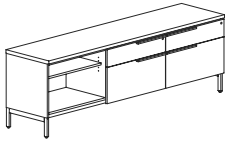
- must specify chassis grain direction on double cut veneer, see pages 13-15 for details
- concealed box drawer available, specify; add \$234 list for each laminate drawer or \$357 for each veneer drawer, see page 25 for details
- veneer drawer fronts in paint available, specify paint color and add \$337 list; see page 16 for details
- on laminate units, contrasting worksurface tops and drawer fronts available, no upcharge; specify color, see page 16 for details
- ledge pulls standard; prism pulls available, specify and see page 9
- oval grommets in back panel can be eliminated upon request, no upcharge
- interior horizontal wire manager with end grommets available, specify and add \$180 list; see page 40 for details
- top grommet available, specify location; add \$128 list each; see page 46 for details
- worksurface power available, specify "to accommodate EC26" on your purchase order; EC26 unit must be ordered separately, see page 46

To Order, Specify:

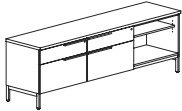
① Laminate Model #	② Laminate Type	③ Laminate Selection	④ Metal Color	⑤ Other Product Options
Laminate (FLT)	HPL	See Laminate Selection	See Metal Finish Color Options	See list of options for each specific unit; Specify and add accordingly.

① Veneer Model #	② Wood Species	③ Wood Finish	④ Metal Color	⑤ Other Product Options	
Veneer (FLV)	Flat Cut CH1 Cherry MA1 Maple WA1 Walnut BO1 Black Oak	See Flat Cut Wood Finish Options	See Metal Finish Color Options	See list of options for each specific unit; Specify and add accordingly.	
	Double Cut DC1 Double Cut	<table border="1"> <thead> <tr> <th>ⓐ Wood Finish</th> <th>ⓑ Chassis Grain Direction</th> </tr> </thead> <tbody> <tr> <td>See Double Cut Wood Finish Options</td> <td>For Double Cut Only: Vertical Horizontal</td> </tr> </tbody> </table>			ⓐ Wood Finish
ⓐ Wood Finish	ⓑ Chassis Grain Direction				
See Double Cut Wood Finish Options	For Double Cut Only: Vertical Horizontal				

Description	D	W	H	CTN WT	CU FT	① Model	HPL Laminate	Flat Cut Veneer	Double Cut Veneer
Box/Lateral File with Open Storage Credenza - Flush Legs	22	96	29	360	43	FLT2296-29L066	\$3,966		
	22	96	29	360	43	FLV2296-29L066		\$5,150	\$5,666
	22	96	29	360	43	FLT2296-29L660	\$3,966		
	22	96	29	360	43	FLV2296-29L660		\$5,150	\$5,666
	22	90	29	353	40	FLT2290-29L066	\$3,871		
	22	90	29	353	40	FLV2290-29L066		\$5,025	\$5,528
	22	90	29	353	40	FLT2290-29L660	\$3,871		
	22	90	29	353	40	FLV2290-29L660		\$5,025	\$5,528



*066 shown



*660

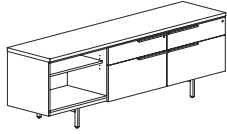
Features:

- eased edge profile user side
- pedestal front locking
- open compartment with adjustable shelf
- shelf 12 1/2"d

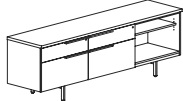
Options:

- must specify chassis grain direction on double cut veneer, see pages 13-15 for details
- concealed box drawer(s) available, specify location in unit; add \$234 list for each laminate drawer or \$357 for each veneer drawer, see page 25 for details
- veneer drawer fronts in paint available, specify paint color and add \$337 list; see page 16 for details
- on laminate units, contrasting worksurface tops and drawer fronts available, no upcharge; specify color, see page 16 for details
- ledge pulls standard; prism pulls available, specify and see page 9
- oval grommets in back panel can be eliminated upon request, no upcharge
- interior horizontal wire manager with end grommets available, specify and add \$180 list; see page 40 for details
- top grommet available, specify location; add \$128 list each; see page 47 for details
- worksurface power available, specify "to accommodate EC26" on your purchase order; EC26 unit must be ordered separately, see page 47

Description	D	W	H	CTN WT	CU FT	① Model	HPL Laminate	Flat Cut Veneer	Double Cut Veneer
Box/Lateral File with Open Storage Credenza - Inset Legs	22	90	29	350	40	FLT2290-29S066	\$3,871		
	22	90	29	350	40	FLV2290-29S066		\$5,025	\$5,528
	22	90	29	350	40	FLT2290-29S660	\$3,871		
	22	90	29	350	40	FLV2290-29S660		\$5,025	\$5,528



*066 shown



*660

Features:

- eased edge profile user side
- pedestal front locking
- open compartment with adjustable shelf
- shelf 12 1/2" d

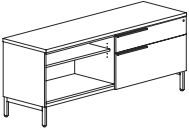

Options:

- must specify chassis grain direction on double cut veneer, see pages 13-15 for details
- concealed box drawer(s) available, specify location in unit; add \$234 list for each laminate drawer or \$357 for each veneer drawer, see page 25 for details
- veneer drawer fronts in paint available, specify paint color and add \$337 list; see page 16 for details
- on laminate units, contrasting worksurface tops and drawer fronts available, no upcharge; specify color, see page 16 for details
- ledge pulls standard; prism pulls available, specify and see page 9
- oval grommets in back panel can be eliminated upon request, no upcharge
- interior horizontal wire manager with end grommets available, specify and add \$180 list; see page 40 for details
- top grommet available, specify location; add \$128 list each; see page 47 for details
- worksurface power available, specify "to accommodate EC26" on your purchase order; EC26 unit must be ordered separately, see page 47

To Order, Specify:

① Laminate Model #	② Laminate Type	③ Laminate Selection		④ Metal Color	⑤ Other Product Options
Laminate (FLT)	HPL	See Laminate Selection		See Metal Finish Color Options	See list of options for each specific unit; Specify and add accordingly.

① Veneer Model #	② Wood Species	③ Wood Finish		④ Metal Color	⑤ Other Product Options
Veneer (FLV)	Flat Cut CH1 Cherry MA1 Maple WA1 Walnut BO1 Black Oak	See Flat Cut Wood Finish Options		See Metal Finish Color Options	See list of options for each specific unit; Specify and add accordingly.
		③a Wood Finish	③b Chassis Grain Direction		

Description	D	W	H	CTN WT	CU FT	① Model	HPL Laminate	Flat Cut Veneer	Double Cut Veneer
Box/Lateral File with Open Storage Credenza - Flush Legs  *06 shown  *60	22	72	29	265	32	FLT2272-29L06	\$3,189		
	22	72	29	265	32	FLV2272-29L06		\$4,139	\$4,551
	22	72	29	265	32	FLT2272-29L60	\$3,189		
	22	72	29	265	32	FLV2272-29L60		\$4,139	\$4,551
	22	66	29	238	30	FLT2266-29L06	\$3,060		
	22	66	29	238	30	FLV2266-29L06		\$3,973	\$4,370
	22	66	29	238	30	FLT2266-29L60	\$3,060		
	22	66	29	238	30	FLV2266-29L60		\$3,973	\$4,370
	22	60	29	238	27	FLT2260-29L06	\$2,935		
	22	60	29	238	27	FLV2260-29L06		\$3,810	\$4,191
	22	60	29	228	27	FLT2260-29L60	\$2,935		
	22	60	29	228	27	FLV2260-29L60		\$3,810	\$4,191

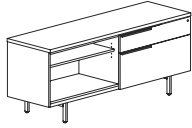
Features:

- eased edge profile user side
- pedestal front locking
- open compartment with adjustable shelf
- shelf 12 1/2"d

Options:

- must specify chassis grain direction on double cut veneer, see pages 13-15 for details
- concealed box drawer available, specify; add \$234 list for each laminate drawer or \$357 for each veneer drawer, see page 25 for details
- veneer drawer fronts in paint available, specify paint color and add \$337 list; see page 16 for details
- on laminate units, contrasting worksurface tops and drawer fronts available, no upcharge; specify color, see page 16 for details
- ledge pulls standard; prism pulls available, specify and see page 9
- oval grommets in back panel can be eliminated upon request, no upcharge
- interior horizontal wire manager with end grommets available, specify and add \$180 list; see page 40 for details
- top grommet available, specify location; add \$128 list each; see page 47 for details
- worksurface power available, specify "to accommodate EC26" on your purchase order; EC26 unit must be ordered separately, see page 47

Description	D	W	H	CTN WT	CU FT	① Model	HPL Laminate	Flat Cut Veneer	Double Cut Veneer
Box/Lateral File with Open Storage Credenza - Inset Legs	22	72	29	265	32	FLT2272-29S06	\$3,189		
	22	72	29	265	32	FLV2272-29S06		\$4,139	\$4,551
	22	72	29	265	32	FLT2272-29S60	\$3,189		
	22	72	29	265	32	FLV2272-29S60		\$4,139	\$4,551
	22	60	29	226	27	FLT2260-29S06	\$2,935		
	22	60	29	226	27	FLV2260-29S06		\$3,810	\$4,191
	22	60	29	226	27	FLT2260-29S60	\$2,935		
	22	60	29	226	27	FLV2260-29S60		\$3,810	\$4,191



*06 shown



*60

Features:

- eased edge profile user side
- pedestal front locking
- open compartment with adjustable shelf
- shelf 12 1/2" d

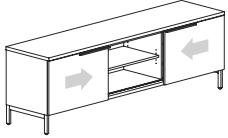
Options:

- must specify chassis grain direction on double cut veneer, see pages 13-15 for details
- concealed box drawer available, specify; add \$234 list for each laminate drawer or \$357 for each veneer drawer, see page 25 for details
- veneer drawer fronts in paint available, specify paint color and add \$337 list; see page 16 for details
- on laminate units, contrasting worksurface tops and drawer fronts available, no upcharge; specify color, see page 16 for details
- ledge pulls standard; prism pulls available, specify and see page 9
- oval grommets in back panel can be eliminated upon request, no upcharge
- interior horizontal wire manager with end grommets available, specify and add \$180 list; see page 40 for details
- top grommet available, specify location; add \$128 list each; see page 47 for details
- worksurface power available, specify "to accommodate EC26" on your purchase order; EC26 unit must be ordered separately, see page 47

To Order, Specify:

① Laminate Model #	② Laminate Type	③ Laminate Selection		④ Metal Color	⑤ Other Product Options
Laminate (FLT)	HPL	See Laminate Selection		See Metal Finish Color Options	See list of options for each specific unit; Specify and add accordingly.
① Veneer Model #	② Wood Species	③ Wood Finish		④ Metal Color	⑤ Other Product Options
Veneer (FLV)	Flat Cut CH1 Cherry MA1 Maple WA1 Walnut BO1 Black Oak	See Flat Cut Wood Finish Options		See Metal Finish Color Options	See list of options for each specific unit; Specify and add accordingly.
	Double Cut DC1 Double Cut	ⓐ Wood Finish	ⓑ Chassis Grain Direction		
		See Double Cut Wood Finish Options	For Double Cut Only: Vertical Horizontal		

Description	D	W	H	CTN WT	CU FT	① Model	HPL Laminate	Flat Cut Veneer	Double Cut Veneer
Double Sliding Door Credenza - Flush Legs	22	90	29	336	40	FLT2290-29L909	\$3,459		
	22	90	29	336	40	FLV2290-29L909		\$4,488	\$4,939

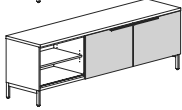
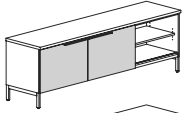


Features:

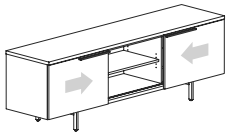
- eased edge profile user side
- locking doors not available
- open compartment with adjustable shelf
- shelves 12 1/2" d

Options:

- must specify chassis grain direction on double cut veneer, see pages 13-15 for details
- veneer door fronts in paint available, specify paint color and add \$337 list; see page 16 for details
- on laminate units, contrasting worksurface tops and door fronts available, no upcharge; specify color, see page 16 for details
- ledge pulls standard; prism pulls available, specify and see page 9
- oval grommets in back panel can be eliminated upon request, no upcharge
- interior horizontal wire manager with end grommets available, specify and add \$180 list; see page 40 for details
- top grommet available, specify location; add \$128 list each; see page 47 for details
- worksurface power available, specify "to accommodate EC26" on your purchase order; EC26 unit must be ordered separately, see page 47



Double Sliding Door Credenza - Inset Legs	22	90	29	333	40	FLT2290-29S909	\$3,459		
	22	90	29	333	40	FLV2290-29S909		\$4,488	\$4,939

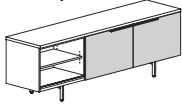
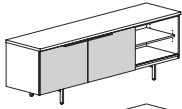


Features:

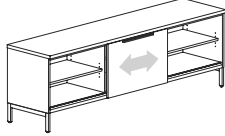
- eased edge profile user side
- locking doors not available
- open compartment with adjustable shelf
- shelves 12 1/2" d

Options:

- must specify chassis grain direction on double cut veneer, see pages 13-15 for details
- veneer door fronts in paint available, specify paint color and add \$337 list; see page 16 for details
- on laminate units, contrasting worksurface tops and door fronts available, no upcharge; specify color, see page 16 for details
- ledge pulls standard; prism pulls available, specify and see page 9
- oval grommets in back panel can be eliminated upon request, no upcharge
- interior horizontal wire manager with end grommets available, specify and add \$180 list; see page 40 for details
- top grommet available, specify location; add \$128 list each; see page 47 for details
- worksurface power available, specify "to accommodate EC26" on your purchase order; EC26 unit must be ordered separately, see page 47

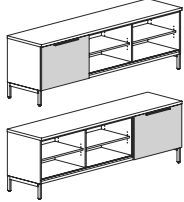


Description	D	W	H	CTN WT	CU FT	① Model	HPL Laminate	Flat Cut Veneer	Double Cut Veneer
Sliding Door Credenza - Flush Legs	22	90	29	319	40	FLT2290-29L090	\$3,317		
	22	90	29	319	40	FLV2290-29L090		\$4,307	\$4,739



Features:

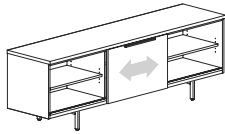
- eased edge profile user side
- locking door not available
- open compartment with adjustable shelf
- shelves 12 1/2"d



Options:

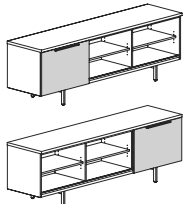
- must specify chassis grain direction on double cut veneer, see pages 13-15 for details
- veneer door fronts in paint available, specify paint color and add \$337 list; see page 16 for details
- on laminate units, contrasting worksurface tops and door fronts available, no upcharge; specify color, see page 16 for details
- ledge pulls standard; prism pulls available, specify and see page 9
- oval grommets in back panel can be eliminated upon request, no upcharge
- interior horizontal wire manager with end grommets available, specify and add \$180 list; see page 40 for details
- top grommet available, specify location; add \$128 list each; see page 47 for details
- worksurface power available, specify "to accommodate EC26" on your purchase order; EC26 unit must be ordered separately, see page 47

Sliding Door Credenza - Flush Legs	22	90	29	316	40	FLT2290-29S090	\$3,317		
	22	90	29	316	40	FLV2290-29S090		\$4,307	\$4,739



Features:

- eased edge profile user side
- locking door not available
- open compartment with adjustable shelf
- shelves 12 1/2"d



Options:

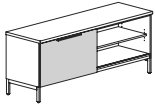
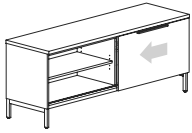
- must specify chassis grain direction on double cut veneer, see pages 13-15 for details
- veneer door fronts in paint available, specify paint color and add \$337 list; see page 16 for details
- on laminate units, contrasting worksurface tops and door fronts available, no upcharge; specify color, see page 16 for details
- ledge pulls standard; prism pulls available, specify and see page 9
- oval grommets in back panel can be eliminated upon request, no upcharge
- interior horizontal wire manager with end grommets available, specify and add \$180 list; see page 40 for details
- top grommet available, specify location; add \$128 list each; see page 47 for details
- worksurface power available, specify "to accommodate EC26" on your purchase order; EC26 unit must be ordered separately, see page 47

To Order, Specify:

① Laminate Model #	② Laminate Type	③ Laminate Selection	④ Metal Color	⑤ Other Product Options
Laminate (FLT)	HPL	See Laminate Selection	See Metal Finish Color Options	See list of options for each specific unit; Specify and add accordingly.

① Veneer Model #	② Wood Species	③ Wood Finish	④ Metal Color	⑤ Other Product Options	
Veneer (FLV)	Flat Cut CH1 Cherry MA1 Maple WA1 Walnut BO1 Black Oak	See Flat Cut Wood Finish Options	See Metal Finish Color Options	See list of options for each specific unit; Specify and add accordingly.	
	Double Cut DC1 Double Cut	<table border="1"> <thead> <tr> <th>ⓐ Wood Finish</th> <th>ⓑ Chassis Grain Direction</th> </tr> </thead> <tbody> <tr> <td>See Double Cut Wood Finish Options</td> <td>For Double Cut Only: Vertical Horizontal</td> </tr> </tbody> </table>			ⓐ Wood Finish
ⓐ Wood Finish	ⓑ Chassis Grain Direction				
See Double Cut Wood Finish Options	For Double Cut Only: Vertical Horizontal				

Description	D	W	H	CTN WT	CU FT	① Model	HPL Laminate	Flat Cut Veneer	Double Cut Veneer
Sliding Door Credenza - Flush Legs	22	72	29	250	32	FLT2272-29L09	\$2,975		
	22	72	29	250	32	FLV2272-29L09		\$3,863	\$4,250
	22	60	29	215	27	FLT2260-29L09	\$2,838		
	22	60	29	215	27	FLV2260-29L09		\$3,685	\$4,052



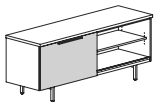
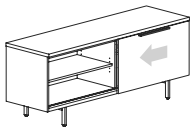
Features:

- eased edge profile user side
- locking door not available
- each compartment has one adjustable shelf
- shelves 12 1/2" d

Options:

- must specify chassis grain direction on double cut veneer, see pages 13-15 for details
- veneer door fronts in paint available, specify paint color and add \$337 list; see page 16 for details
- on laminate units, contrasting worksurface tops and door fronts available, no upcharge; specify color, see page 16 for details
- ledge pulls standard; prism pulls available, specify and see page 9
- oval grommets in back panel can be eliminated upon request, no upcharge
- interior horizontal wire manager with end grommets available, specify and add \$180 list; see page 40 for details
- top grommet available, specify location; add \$128 list each; see page 47 for details
- worksurface power available, specify "to accommodate EC26" on your purchase order; EC26 unit must be ordered separately, see page 47

Sliding Door Credenza - Inset Legs	22	72	29	244	32	FLT2272-29S09	\$2,975		
	22	72	29	244	32	FLV2272-29S09		\$3,863	\$4,250
	22	60	29	210	27	FLT2260-29S09	\$2,838		
	22	60	29	210	27	FLV2260-29S09		\$3,685	\$4,052




Features:

- eased edge profile user side
- locking door not available
- each compartment has one adjustable shelf
- shelves 12 1/2" d

Options:

- must specify chassis grain direction on double cut veneer, see pages 13-15 for details
- veneer door fronts in paint available, specify paint color and add \$337 list; see page 16 for details
- on laminate units, contrasting worksurface tops and door fronts available, no upcharge; specify color, see page 16 for details
- ledge pulls standard; prism pulls available, specify and see page 9
- oval grommets in back panel can be eliminated upon request, no upcharge
- interior horizontal wire manager with end grommets available, specify and add \$180 list; see page 40 for details
- top grommet available, specify location; add \$128 list each; see page 47 for details
- worksurface power available, specify "to accommodate EC26" on your purchase order; EC26 unit must be ordered separately, see page 47

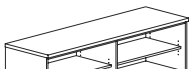
Description	D	W	H	CTN WT	CU FT	① Model	HPL Laminate	Flat Cut Veneer	Double Cut Veneer
Open Compartment Credenza - Flush Legs 	22	96	29	310	43	FLT2296-29L000	\$3,147		
	22	96	29	310	43	FLV2296-29L000		\$4,087	\$4,494
	22	90	29	301	40	FLT2290-29L000	\$3,075		
	22	90	29	301	40	FLV2290-29L000		\$3,992	\$4,393

Features:

- eased edge profile user side
- each open compartment has one adjustable shelf
- shelves 12 1/2"d

Options:

- must specify chassis grain direction on double cut veneer, see pages 13-15 for details
- contrasting laminate worksurface tops, no upcharge; specify laminate color, see page 16 for details
- oval grommets in back panel can be eliminated upon request, no upcharge
- interior horizontal wire manager with end grommets available, specify and add \$180 list; see page 40 for details
- top grommet available, specify location and add \$128 list each; see page 47 for details

Open Compartment Credenza - Flush Legs 	22	72	29	230	32	FLT2272-29L00	\$2,838		
	22	72	29	230	32	FLV2272-29L00		\$3,685	\$4,052
	22	60	29	199	27	FLT2260-29L00	\$2,710		
	22	60	29	199	27	FLV2260-29L00		\$3,516	\$3,869

Features:

- eased edge profile user side
- each open compartment has one adjustable shelf
- shelves 12 1/2"d

Options:

- must specify chassis grain direction on double cut veneer, see pages 13-15 for details
- contrasting laminate worksurface tops, no upcharge; specify laminate color, see page 16 for details
- oval grommets in back panel can be eliminated upon request, no upcharge
- interior horizontal wire manager with end grommets available, specify and add \$180 list; see page 40 for details
- top grommet available, specify location and add \$128 list each; see page 47 for details

Open Compartment - Flush Legs 	22	36	29	136	17	FLT2236-29L0	\$2,042		
	22	36	29	136	17	FLV2236-29L0		\$2,650	\$2,914
	22	30	29	111	14	FLT2230-29L0	\$1,983		
	22	30	29	111	14	FLV2230-29L0		\$2,573	\$2,832

Features:

- eased edge profile user side
- open compartment with adjustable shelf
- shelves 12 1/2"d

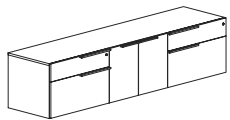
Options:

- must specify chassis grain direction on double cut veneer, see pages 13-15 for details
- contrasting laminate worksurface tops, no upcharge; specify laminate color, see page 16 for details
- oval grommets in back panel can be eliminated upon request, no upcharge
- interior horizontal wire manager with end grommets available, specify and add \$180 list; see page 40 for details
- top grommet available, specify location and add \$128 list each; see page 47 for details

To Order, Specify:

① Laminate Model #	② Laminate Type	③ Laminate Selection	④ Metal Color	⑤ Other Product Options
Laminate (FLT)	TFL	See Laminate Selection	See Metal Finish Color Options	See list of options for each specific unit; Specify and add accordingly.
	HLP			

① Veneer Model #	② Wood Species	③ Wood Finish	④ Metal Color	⑤ Other Product Options	
Veneer (FLV)	Flat Cut CH1 Cherry MA1 Maple WA1 Walnut BO1 Black Oak	See Flat Cut Wood Finish Options	See Metal Finish Color Options	See list of options for each specific unit; Specify and add accordingly.	
	Double Cut DC1 Double Cut	<table border="1"> <thead> <tr> <th>③a Wood Finish</th> <th>③b Chassis Grain Direction</th> </tr> </thead> <tbody> <tr> <td>See Double Cut Wood Finish Options</td> <td>For Double Cut Only: Vertical Horizontal</td> </tr> </tbody> </table>			③a Wood Finish
③a Wood Finish	③b Chassis Grain Direction				
See Double Cut Wood Finish Options	For Double Cut Only: Vertical Horizontal				

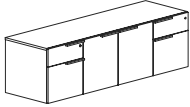
Description	D	W	H	CTN WT	CU FT	① Model	HPL Laminate	Flat Cut Veneer	Double Cut Veneer
Storage Credenza 	22	96	21	350	32	FLT2296-21F676	\$2,696		
	22	96	21	350	32	FLV2296-21F676		\$3,765	\$4,143
	22	90	21	335	30	FLT2290-21F676	\$2,633		
	22	90	21	335	30	FLV2290-21F676		\$3,674	\$4,041
	22	84	21	311	28	FLT2284-21F676	\$2,568		
	22	84	21	311	28	FLV2284-21F676		\$3,585	\$3,944

Features:

- pedestal front locking
- hinged door compartment has one adjustable shelf

Options:

- must specify chassis grain direction on double cut veneer, see pages 13-15 for details
- concealed box drawer(s) available, specify location in unit; add \$234 list for each laminate drawer or \$357 for each veneer drawer, see page 25 for details
- locking doors available, specify and add \$142 list
- veneer door and drawer fronts in paint available, specify paint color and add \$337; see page 16 for details
- on laminate units, contrasting door and drawer fronts available, no upcharge; specify color, see page 16 for details
- ledge pulls standard; prism pulls available, specify and see page 9
- oval grommets in back panel can be eliminated upon request, no upcharge
- oval or rectangular seat cushion available, see page 25 for more details and page 212 for pricing
- interior horizontal wire manager with end grommets available, specify and add \$180 list; see page 40 for details
- top grommet available, specify location; add \$128 list each; see page 46 for details
- worksurface power available, specify "to accommodate EC26" on your purchase order; EC26 unit must be ordered separately, see page 46

Description	D	W	H	CTN WT	CU FT	① Model	HPL Laminate	Flat Cut Veneer	Double Cut Veneer
Storage Credenza 	22	78	21	310	26	FLT2278-21F575	\$2,168		
	22	78	21	310	26	FLV2278-21F575		\$3,025	\$3,329
	22	72	21	288	24	FLT2272-21F575	\$2,114		
	22	72	21	288	24	FLV2272-21F575		\$2,951	\$3,246
	22	66	21	273	22	FLT2266-21F575	\$2,072		
	22	66	21	273	22	FLV2266-21F575		\$2,893	\$3,182
	22	60	21	257	20	FLT2260-21F575	\$2,033		
	22	60	21	257	20	FLV2260-21F575		\$2,834	\$3,120

Features:

- pedestal front locking
- hinged door compartment has one adjustable shelf

Options:

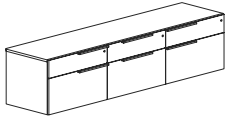
- must specify chassis grain direction on double cut veneer, see pages 13-15 for details
- locking doors available, specify and add \$142 list
- veneer door and drawer fronts in paint available, specify paint color and add \$337; see page 16 for details
- on laminate units, contrasting door and drawer fronts available, no upcharge; specify color, see page 16 for details
- ledge pulls standard; prism pulls available, specify and see page 9
- oval grommets in back panels can be eliminated upon request, no upcharge
- oval or rectangular seat cushion available, see page 25 for more details and page 212 for pricing
- interior horizontal wire manager with end grommets available, specify and add \$180 list; see page 40 for details
- top grommet available, specify location; add \$128 list each; see page 46 for details
- worksurface power available, specify "to accommodate EC26" on your purchase order; EC26 unit must be ordered separately, see page 46

To Order, Specify:

① Laminate Model #	② Laminate Type	③ Laminate Selection		④ Metal Color	⑤ Other Product Options
Laminate (FLT)	HPL	See Laminate Selection		See Metal Finish Color Options	See list of options for each specific unit; Specify and add accordingly.

① Veneer Model #	② Wood Species	③ Wood Finish		④ Metal Color	⑤ Other Product Options
Veneer (FLV)	Flat Cut CH1 Cherry MA1 Maple WA1 Walnut BO1 Black Oak	See Flat Cut Wood Finish Options		See Metal Finish Color Options	See list of options for each specific unit; Specify and add accordingly.
		ⓐ Wood Finish	ⓑ Chassis Grain Direction		

Description	D	W	H	CTN WT	CU FT	① Model	HPL Laminate	Flat Cut Veneer	Double Cut Veneer
Box/Lateral File Credenza	22	90	21	371	30	FLT2290-21F666	\$3,055		
	22	90	21	371	30	FLV2290-21F666		\$4,266	\$4,693



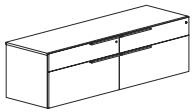
Features:

- pedestal front locking

Options:

- must specify chassis grain direction on double cut veneer, see pages 13-15 for details
- concealed box drawer(s) available, specify location in unit; add \$234 list for each laminate drawer or \$357 for each veneer drawer, see page 25 for details
- veneer drawer fronts in paint available, specify paint color and add \$337 list; see page 16 for details
- on laminate units, contrasting fronts available, no upcharge; specify color, see page 16 for details
- ledge pulls standard; prism pulls available, specify and see page 9
- oval grommets in back panel can be eliminated upon request, no upcharge
- oval or rectangular seat cushion available, see page 25 for more details and page 212 for pricing
- interior horizontal wire manager with end grommets available, specify and add \$180 list; see page 40 for details
- top grommet available, specify location; add \$128 list each; see page 46 for details

Box/Lateral File Credenza	22	72	21	289	24	FLT2272-21F66	\$2,274		
	22	72	21	289	24	FLV2272-21F66		\$3,174	\$3,492
	22	60	21	251	20	FLT2260-21F66	\$2,183		
	22	60	21	251	20	FLV2260-21F66		\$3,049	\$3,353



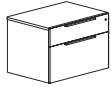
Features:

- pedestal front locking

Options:

- must specify chassis grain direction on double cut veneer, see pages 13-15 for details
- concealed box drawer(s) available, specify location in unit; add \$234 list for each laminate drawer or \$357 for each veneer drawer, see page 25 for details
- veneer drawer fronts in paint available, specify paint color and add \$337 list; see page 16 for details
- on laminate units, contrasting fronts available, no upcharge; specify color, see page 16 for details
- ledge pulls standard; prism pulls available, specify and see page 9
- oval grommets in back panel can be eliminated upon request, no upcharge
- oval or rectangular seat cushion available, see page 25 for more details and page 212 for pricing
- interior horizontal wire manager with end grommets available, specify and add \$180 list; see page 40 for details
- top grommet available, specify location; add \$128 list each; see page 46 for details

Description	D	W	H	CTN WT	CU FT	① Model	HPL Laminate	Flat Cut Veneer	Double Cut Veneer
Box/Lateral File Pedestal	22	36	21	146	13	FLT2236-21F6	\$1,322		
	22	36	21	146	13	FLV2236-21F6		\$1,845	\$2,030
	22	30	21	126	11	FLT2230-21F6	\$1,291		
	22	30	21	126	11	FLV2230-21F6		\$1,799	\$1,981



Features:

- pedestal front locking

Options:

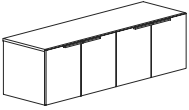
- must specify chassis grain direction on double cut veneer, see pages 13-15 for details
- concealed box drawer available, specify; add \$234 list for each laminate drawer or \$357 for each veneer drawer, see page 25 for details
- veneer drawer fronts in paint available, specify paint color and add \$337 list; see page 16 for details
- on laminate units, contrasting fronts available, no upcharge; specify color, see page 16 for details
- ledge pulls standard; prism pulls available, specify and see page 9
- oval grommet in back panel can be eliminated upon request, no upcharge
- oval or rectangular seat cushion available, see page 25 for more details and page 212 for pricing
- interior horizontal wire manager with end grommets available, specify and add \$180 list; see page 40 for details
- top grommet available, specify location; add \$128 list each; see page 46 for details

FLUX - PRIVATE OFFICE

To Order, Specify:

① Laminate Model #	② Laminate Type	③ Laminate Selection	④ Metal Color	⑤ Other Product Options
Laminate (FLT)	HPL	See Laminate Selection	See Metal Finish Color Options	See list of options for each specific unit; Specify and add accordingly.

① Veneer Model #	② Wood Species	③ Wood Finish	④ Metal Color	⑤ Other Product Options	
Veneer (FLV)	Flat Cut CH1 Cherry MA1 Maple WA1 Walnut BO1 Black Oak	See Flat Cut Wood Finish Options	See Metal Finish Color Options	See list of options for each specific unit; Specify and add accordingly.	
	Double Cut DC1 Double Cut	<table border="1"> <thead> <tr> <th>③a Wood Finish</th> <th>③b Chassis Grain Direction</th> </tr> </thead> <tbody> <tr> <td>See Double Cut Wood Finish Options</td> <td>For Double Cut Only: Vertical Horizontal</td> </tr> </tbody> </table>			③a Wood Finish
③a Wood Finish	③b Chassis Grain Direction				
See Double Cut Wood Finish Options	For Double Cut Only: Vertical Horizontal				

Description	D	W	H	CTN WT	CU FT	① Model	HPL Laminate	Flat Cut Veneer	Double Cut Veneer
	22	78	21	254	26	FLT2278-21F77	\$1,874		
	22	78	21	254	26	FLV2278-21F77		\$2,755	\$3,027
	22	72	21	238	24	FLT2272-21F77	\$1,828		
	22	72	21	238	24	FLV2272-21F77		\$2,687	\$2,955
	22	66	21	220	22	FLT2266-21F77	\$1,755		
	22	66	21	220	22	FLV2266-21F77		\$2,579	\$2,837
	22	60	21	205	20	FLT2260-21F77	\$1,686		
	22	60	21	205	20	FLV2260-21F77		\$2,477	\$2,723

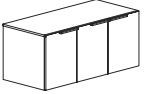
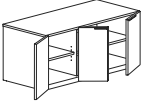

Features:

- each hinged door compartment has one adjustable shelf

Options:

- must specify chassis grain direction on double cut veneer, see pages 13-15 for details
- locking doors available, specify and add \$284 list
- veneer door fronts in paint available, specify paint color and add \$337 list; see page 16 for details
- on laminate units, contrasting laminate door fronts available, no upcharge; specify laminate color, see page 16 for details
- ledge pulls standard; prism pulls available, specify and see page 9
- oval grommets in back panel can be eliminated upon request, no upcharge
- oval or rectangular seat cushion available, see page 25 for more details and page 212 for pricing
- interior horizontal wire manager with end grommets available, specify and add \$180 list; see page 40 for details
- top grommet available, specify location; add \$128 list each; see page 45 for details
- worksurface power available, specify "to accommodate EC26" on your purchase order; EC26 unit must be ordered separately, see page 46

FLUX - PRIVATE OFFICE

Description	D	W	H	CTN WT	CU FT	① Model	HPL Laminate	Flat Cut Veneer	Double Cut Veneer
  <p>left shown</p>   <p>right</p>	22	54	21	188	18	FLT2254-21F77R	\$1,534		
	22	54	21	188	18	FLV2254-21F77R		\$2,254	\$2,480
	22	54	21	185	18	FLT2254-21F77L	\$1,534		
	22	54	21	185	18	FLV2254-21F77L		\$2,254	\$2,480
	22	48	21	169	16	FLT2248-21F77R	\$1,456		
	22	48	21	169	16	FLV2248-21F77R		\$2,143	\$2,356
	22	48	21	163	16	FLT2248-21F77L	\$1,456		
	22	48	21	163	16	FLV2248-21F77L		\$2,143	\$2,356
	22	42	21	153	15	FLT2242-21F77R	\$1,383		
	22	42	21	153	15	FLV2242-21F77R		\$2,035	\$2,238
	22	42	21	150	15	FLT2242-21F77L	\$1,383		
	22	42	21	150	15	FLV2242-21F77L		\$2,035	\$2,238

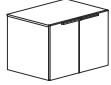
Features:

- each hinged door compartment has one adjustable shelf

Options:

- must specify chassis grain direction on double cut veneer, see pages 13-15 for details
- locking doors available, specify and add \$284 list
- veneer door fronts in paint available, specify paint color and add \$337 list; see page 16 for details
- on laminate units, contrasting laminate door fronts available, no upcharge; specify laminate color, see page 16 for details
- ledge pulls standard; prism pulls available, specify and see page 9
- oval grommet in back panel can be eliminated upon request, no upcharge
- oval or rectangular seat cushion available, see page 25 for more details and page 212 for pricing
- interior horizontal wire manager with end grommets available, specify and add \$180 list; see page 40 for details
- top grommet available, specify location; add \$128 list each; see page 45 for details
- worksurface power available, specify "to accommodate EC26" on your purchase order; EC26 unit must be ordered separately, see page 46

Description	D	W	H	CTN WT	CU FT	① Model	HPL Laminate	Flat Cut Veneer	Double Cut Veneer
Two Door Storage	22	36	21	127	13	FLT2236-21F7	\$986		
	22	36	21	127	13	FLV2236-21F7		\$1,446	\$1,591
	22	30	21	109	11	FLT2230-21F7	\$946		
	22	30	21	109	11	FLV2230-21F7		\$1,386	\$1,527



Features:

- compartment has one adjustable shelf

Options:

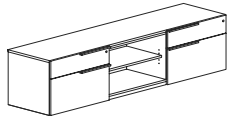
- must specify chassis grain direction on double cut veneer, see pages 13-15 for details
- locking doors available, specify and add \$142 list
- veneer door fronts in paint available, specify paint color and add \$337 list; see page 16 for details
- on laminate units, contrasting laminate door fronts available, no upcharge; specify laminate color, see page 16 for details
- ledge pulls standard; prism pulls available, specify and see page 9
- oval grommets in back panel can be eliminated upon request, no upcharge
- oval or rectangular seat cushion available, see page 25 for more details and page 212 for pricing
- interior horizontal wire manager with end grommets available, specify and add \$180 list; see page 40 for details
- top grommet available, specify location; add \$128 list each; see page 45 for details
- worksurface power available, specify "to accommodate EC26" on your purchase order; EC26 unit must be ordered separately, see page 46

To Order, Specify:

① Laminate Model #	② Laminate Type	③ Laminate Selection	④ Metal Color	⑤ Other Product Options
Laminate (FLT)	HPL	See Laminate Selection	See Metal Finish Color Options	See list of options for each specific unit; Specify and add accordingly.

① Veneer Model #	② Wood Species	③ Wood Finish	④ Metal Color	⑤ Other Product Options	
Veneer (FLV)	Flat Cut CH1 Cherry MA1 Maple WA1 Walnut BO1 Black Oak	See Flat Cut Wood Finish Options	See Metal Finish Color Options	See list of options for each specific unit; Specify and add accordingly.	
	Double Cut DC1 Double Cut	<table border="1"> <thead> <tr> <th>ⓐ Wood Finish</th> <th>ⓑ Chassis Grain Direction</th> </tr> </thead> <tbody> <tr> <td>See Double Cut Wood Finish Options</td> <td>For Double Cut Only: Vertical Horizontal</td> </tr> </tbody> </table>			ⓐ Wood Finish
ⓐ Wood Finish	ⓑ Chassis Grain Direction				
See Double Cut Wood Finish Options	For Double Cut Only: Vertical Horizontal				

Description	D	W	H	CTN WT	CU FT	① Model	HPL Laminate	Flat Cut Veneer	Double Cut Veneer
Box/Lateral File with Open Storage Credenza	22	96	21	327	32	FLT2296-21F606	\$2,836		
	22	96	21	327	32	FLV2296-21F606		\$3,959	\$4,355
	22	90	21	323	30	FLT2290-21F606	\$2,755		
	22	90	21	323	30	FLV2290-21F606		\$3,844	\$4,228



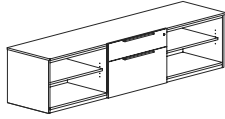
Features:

- pedestal front locking
- compartment has one adjustable shelf
- shelves 12 1/2" d

Options:

- must specify chassis grain direction on double cut veneer, see pages 13-15 for details
- peninsula desk mounting must be specified when ordering secondary credenza; see page 17 for details
- concealed box drawer(s) available, specify location in unit; add \$234 list for each laminate drawer or \$357 for each veneer drawer, see page 25 for details
- veneer drawer fronts in paint available, specify paint color and add \$337 list; see page 16 for details
- on laminate units, contrasting fronts available, no upcharge; specify color, see page 16 for details
- ledge pulls standard; prism pulls available, specify and see page 9
- oval grommets in back panel can be eliminated upon request, no upcharge
- oval or rectangular seat cushion available, see page 25 for more details and page 212 for pricing
- interior horizontal wire manager with end grommets available, specify and add \$180 list; see page 40 for details
- top grommet available, specify location; add \$128 list each; see page 46 for details
- worksurface power available, specify "to accommodate EC26" on your purchase order; EC26 unit must be ordered separately, see page 46

Description	D	W	H	CTN WT	CU FT	① Model	HPL Laminate	Flat Cut Veneer	Double Cut Veneer
Box/Lateral File with Open Storage Credenza	22	96	21	291	32	FLT2296-21F060	\$2,634		
	22	96	21	291	32	FLV2296-21F060		\$3,677	\$4,043
	22	90	21	288	30	FLT2290-21F060	\$2,559		
	22	90	21	288	30	FLV2290-21F060		\$3,569	\$3,925



Features:

- pedestal front locking
- each open compartment has one adjustable shelf
- shelves 12 1/2”d

Options:

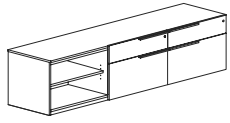
- must specify chassis grain direction on double cut veneer, see pages 13-15 for details
- peninsula desk mounting must be specified when ordering secondary credenza; see page 17 for details
- concealed box drawer available, specify; add \$234 list for each laminate drawer or \$357 for each veneer drawer, see page 25 for details
- veneer drawer fronts in paint available, specify paint color and add \$337 list; see page 16 for details
- on laminate units, contrasting fronts available, no upcharge; specify color, see page 16 for details
- ledge pulls standard; prism pulls available, specify and see page 9
- oval grommets in back panel can be eliminated upon request, no upcharge
- oval or rectangular seat cushion available, see page 25 for more details and page 212 for pricing
- interior horizontal wire manager with end grommets available, specify and add \$180 list; see page 40 for details
- top grommet available, specify location; add \$128 list each; see page 46 for details
- worksurface power available, specify “to accommodate EC26” on your purchase order; EC26 unit must be ordered separately, see page 46

To Order, Specify:

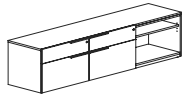
① Laminate Model #	② Laminate Type	③ Laminate Selection	④ Metal Color	⑤ Other Product Options
Laminate (FLT)	HPL	See Laminate Selection	See Metal Finish Color Options	See list of options for each specific unit; Specify and add accordingly.

① Veneer Model #	② Wood Species	③ Wood Finish	④ Metal Color	⑤ Other Product Options	
Veneer (FLV)	Flat Cut CH1 Cherry MA1 Maple WA1 Walnut BO1 Black Oak	See Flat Cut Wood Finish Options	See Metal Finish Color Options	See list of options for each specific unit; Specify and add accordingly.	
	Double Cut DC1 Double Cut	<table border="1"> <thead> <tr> <th>ⓐ Wood Finish</th> <th>ⓑ Chassis Grain Direction</th> </tr> </thead> <tbody> <tr> <td>See Double Cut Wood Finish Options</td> <td>For Double Cut Only: Vertical Horizontal</td> </tr> </tbody> </table>			ⓐ Wood Finish
ⓐ Wood Finish	ⓑ Chassis Grain Direction				
See Double Cut Wood Finish Options	For Double Cut Only: Vertical Horizontal				

Description	D	W	H	CTN WT	CU FT	① Model	HPL Laminate	Flat Cut Veneer	Double Cut Veneer
Box/Lateral File with Open Storage Credenza	22	96	21	364	32	FLT2296-21F066	\$2,836		
	22	96	21	364	32	FLV2296-21F066		\$3,959	\$4,355
	22	96	21	332	32	FLT2296-21F660	\$2,836		
	22	96	21	332	32	FLV2296-21F660		\$3,959	\$4,355
	22	90	21	320	30	FLT2290-21F066	\$2,755		
	22	90	21	320	30	FLV2290-21F066		\$3,844	\$4,228
	22	90	21	320	30	FLT2290-21F660	\$2,755		
	22	90	21	320	30	FLV2290-21F660		\$3,844	\$4,228



*066 shown



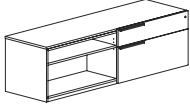
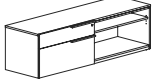
*660

Features:

- pedestal front locking
- compartment has one adjustable shelf
- shelf 12 1/2"d

Options:

- must specify chassis grain direction on double cut veneer, see pages 13-15 for details
- peninsula desk mounting must be specified when ordering secondary credenza; see page 17 for details
- concealed box drawer(s) available, specify location in unit; add \$234 list for each laminate drawer or \$357 for each veneer drawer, see page 25 for details
- veneer drawer fronts in paint available, specify paint color and add \$337 list; see page 16 for details
- on laminate units, contrasting fronts available, no upcharge; specify color, see page 16 for details
- ledge pulls standard; prism pulls available, specify and see page 9
- oval grommets in back panel can be eliminated upon request, no upcharge
- oval or rectangular seat cushion available, see page 25 for more details and page 212 for pricing
- interior horizontal wire manager with end grommets available, specify and add \$180 list; see page 40 for details
- top grommet available, specify location; add \$128 list each; see page 47 for details
- worksurface power available, specify "to accommodate EC26" on your purchase order; EC26 unit must be ordered separately, see page 47

Description	D	W	H	CTN WT	CU FT	① Model	HPL Laminate	Flat Cut Veneer	Double Cut Veneer
 <p>*06 shown</p>  <p>*60</p>	22	72	21	232	24	FLT2272-21F06	\$2,253		
	22	72	21	232	24	FLV2272-21F06		\$3,019	\$3,323
	22	72	21	232	24	FLT2272-21F60	\$2,253		
	22	72	21	232	24	FLV2272-21F60		\$3,019	\$3,323
	22	66	21	214	22	FLT2266-21F06	\$2,188		
	22	66	21	214	22	FLV2266-21F06		\$2,933	\$3,225
	22	66	21	214	22	FLT2266-21F60	\$2,188		
	22	66	21	214	22	FLV2266-21F60		\$2,933	\$3,225
	22	60	21	203	20	FLT2260-21F06	\$2,125		
	22	60	21	203	20	FLV2260-21F06		\$2,844	\$3,130
	22	60	21	203	20	FLT2260-21F60	\$2,125		
	22	60	21	203	20	FLV2260-21F60		\$2,844	\$3,130

Features:

- pedestal front locking
- compartment has one adjustable shelf
- shelf 12 1/2" d

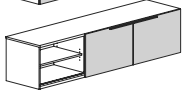
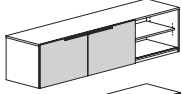
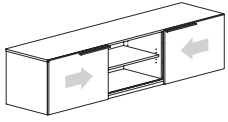
Options:

- must specify chassis grain direction on double cut veneer, see pages 13-15 for details
- peninsula desk mounting must be specified when ordering secondary credenza; see page 17 for details
- concealed box drawer available, specify; add \$234 list for each laminate drawer or \$357 for each veneer drawer, see page 25 for details
- veneer drawer fronts in paint available, specify paint color and add \$337 list; see page 16 for details
- on laminate units, contrasting fronts available, no upcharge; specify color, see page 16 for details
- ledge pulls standard; prism pulls available, specify and see page 9
- oval grommets in back panel can be eliminated upon request, no upcharge
- oval or rectangular seat cushion available, see page 25 for more details and page 212 for pricing
- interior horizontal wire manager with end grommets available, specify and add \$180 list; see page 40 for details
- top grommet available, specify location; add \$128 list each; see page 47 for details
- worksurface power available, specify "to accommodate EC26" on your purchase order; EC26 unit must be ordered separately, see page 47

To Order, Specify:

① Laminate Model #	② Laminate Type	③ Laminate Selection		④ Metal Color	⑤ Other Product Options
Laminate (FLT)	HPL	See Laminate Selection		See Metal Finish Color Options	See list of options for each specific unit; Specify and add accordingly.
① Veneer Model #	② Wood Species	③ Wood Finish		④ Metal Color	⑤ Other Product Options
Veneer (FLV)	Flat Cut CH1 Cherry MA1 Maple WA1 Walnut BO1 Black Oak	See Flat Cut Wood Finish Options		See Metal Finish Color Options	See list of options for each specific unit; Specify and add accordingly.
	Double Cut DC1 Double Cut	ⓐ Wood Finish See Double Cut Wood Finish Options	ⓑ Chassis Grain Direction For Double Cut Only: Vertical Horizontal		

Description	D	W	H	CTN WT	CU FT	① Model	HPL Laminate	Flat Cut Veneer	Double Cut Veneer
Double Sliding Door Credenza	22	90	21	291	30	FLT2290-21F909	\$2,362		
	22	90	21	291	30	FLV2290-21F909		\$3,296	\$3,627



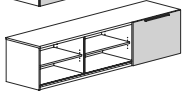
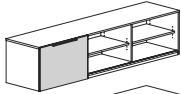
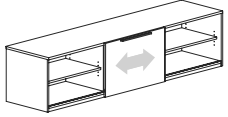
Features:

- locking doors not available
- each compartment has one adjustable shelf
- shelves 12 1/2" d

Options:

- must specify chassis grain direction on double cut veneer, see pages 13-15 for details
- peninsula desk mounting must be specified when ordering secondary credenza; see page 17 for details
- veneer door fronts in paint available, specify paint color and add \$337 list; see page 16 for details
- on laminate units, contrasting laminate door fronts available, no upcharge; specify laminate color, see page 16 for details
- ledge pulls standard; prism pulls available, specify and see page 9
- oval grommets in back panel can be eliminated upon request, no upcharge
- oval or rectangular seat cushion available, see page 25 for more details and page 212 for pricing
- interior horizontal wire manager with end grommets available, specify and add \$180 list; see page 40 for details
- top grommet available, specify location; add \$128 list each; see page 47 for details
- worksurface power available, specify "to accommodate EC26" on your purchase order; EC26 unit must be ordered separately, see page 47

Sliding Door Credenza	22	90	21	274	30	FLT2290-21F090	\$2,248		
	22	90	21	274	30	FLV2290-21F090		\$3,139	\$3,455



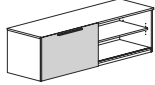
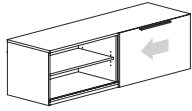
Features:

- locking doors not available
- each compartment has one adjustable shelf
- shelves 12 1/2" d

Options:

- must specify chassis grain direction on double cut veneer, see pages 13-15 for details
- peninsula desk mounting must be specified when ordering secondary credenza; see page 17 for details
- veneer door fronts in paint available, specify paint color and add \$337 list; see page 16 for details
- on laminate units, contrasting laminate door fronts available, no upcharge; specify laminate color, see page 16 for details
- ledge pulls standard; prism pulls available, specify and see page 9
- oval grommets in back panel can be eliminated upon request, no upcharge
- oval or rectangular seat cushion available, see page 25 for more details and page 212 for pricing
- interior horizontal wire manager with end grommets available, specify and add \$180 list; see page 40 for details
- top grommet available, specify location; add \$128 list each; see page 47 for details
- worksurface power available, specify "to accommodate EC26" on your purchase order; EC26 unit must be ordered separately, see page 47

Description	D	W	H	CTN WT	CU FT	① Model	HPL Laminate	Flat Cut Veneer	Double Cut Veneer
Sliding Door Credenza	22	72	21	211	24	FLT2272-21F09	\$2,050		
	22	72	21	211	24	FLV2272-21F09		\$2,863	\$3,150
	22	60	21	185	20	FLT2260-21F09	\$1,934		
	22	60	21	185	20	FLV2260-21F09		\$2,699	\$2,971



Features:

- locking doors not available
- each compartment has one adjustable shelf
- shelves 12 1/2"d

Options:

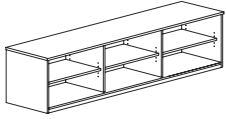
- must specify chassis grain direction on double cut veneer, see pages 13-15 for details
- peninsula desk mounting must be specified when ordering secondary credenza; see page 17 for details
- veneer door fronts in paint available, specify paint color and add \$337 list; see page 16 for details
- on laminate units, contrasting laminate door fronts available, no upcharge; specify laminate color, see page 16 for details
- ledge pulls standard; prism pulls available, specify and see page 9
- oval grommets in back panel can be eliminated upon request, no upcharge
- oval or rectangular seat cushion available, see page 25 for more details and page 212 for pricing
- interior horizontal wire manager with end grommets available, specify and add \$180 list; see page 40 for details
- top grommet available, specify location; add \$128 list each; see page 47 for details
- worksurface power available, specify "to accommodate EC26" on your purchase order; EC26 unit must be ordered separately, see page 47

To Order, Specify:

① Laminate Model #	② Laminate Type	③ Laminate Selection	④ Metal Color	⑤ Other Product Options
Laminate (FLT)	HPL	See Laminate Selection	See Metal Finish Color Options	See list of options for each specific unit; Specify and add accordingly.

① Veneer Model #	② Wood Species	③ Wood Finish	④ Metal Color	⑤ Other Product Options	
Veneer (FLV)	Flat Cut CH1 Cherry MA1 Maple WA1 Walnut BO1 Black Oak	See Flat Cut Wood Finish Options	See Metal Finish Color Options	See list of options for each specific unit; Specify and add accordingly.	
	Double Cut DC1 Double Cut	<table border="1"> <thead> <tr> <th>ⓐ Wood Finish</th> <th>ⓑ Chassis Grain Direction</th> </tr> </thead> <tbody> <tr> <td>See Double Cut Wood Finish Options</td> <td>For Double Cut Only: Vertical Horizontal</td> </tr> </tbody> </table>			ⓐ Wood Finish
ⓐ Wood Finish	ⓑ Chassis Grain Direction				
See Double Cut Wood Finish Options	For Double Cut Only: Vertical Horizontal				

Description	D	W	H	CTN WT	CU FT	① Model	HPL Laminate	Flat Cut Veneer	Double Cut Veneer
Open Compartment Storage	22	90	21	246	30	FLT2290-21F000	\$1,952		
Credenza	22	90	21	246	30	FLV2290-21F000		\$2,723	\$2,997



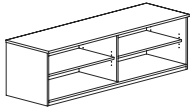
Features:

- square edge on top
- each open compartment has one adjustable shelf
- shelves 12 1/2" d

Options:

- must specify chassis grain direction on double cut veneer, see pages 13-15 for details
- peninsula desk mounting must be specified when ordering secondary credenza; see page 17 for details
- oval or rectangular seat cushion available, see page 25 for more details and page 212 for pricing
- oval grommets in back panel can be eliminated upon request, no upcharge
- interior horizontal wire manager with end grommets available, specify and add \$180 list; see page 40 for details
- top grommet available, specify location and add \$128 list each; see page 46 for details
- worksurface power available, specify "to accommodate EC26" on your purchase order; EC26 unit must be ordered separately, see page 46

Open Compartment Storage	22	72	21	193	24	FLT2272-21F00	\$1,779		
Credenza	22	72	21	193	24	FLV2272-21F00		\$2,484	\$2,733
	22	60	21	169	20	FLT2260-21F00	\$1,665		
	22	60	21	169	20	FLV2260-21F00		\$2,343	\$2,575



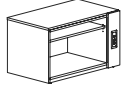
Features:

- square edge on top
- each open compartment has one adjustable shelf
- shelves 12 1/2" d

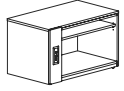
Options:

- must specify chassis grain direction on double cut veneer, see pages 13-15 for details
- peninsula desk mounting must be specified when ordering secondary credenza; see page 17 for details
- oval or rectangular seat cushion available, see page 25 for more details and page 212 for pricing
- oval grommets in back panel can be eliminated upon request, no upcharge
- interior horizontal wire manager with end grommets available, specify and add \$180 list; see page 40 for details
- top grommet available, specify location and add \$128 list each; see page 46 for details
- worksurface power available, specify "to accommodate EC26" on your purchase order; EC26 unit must be ordered separately, see page 46

Description	D	W	H	CTN WT	CU FT	① Model	HPL Laminate	Flat Cut Veneer	Double Cut Veneer
Open Storage with Side Power Access	22	36	21	118	13	FLT2236-21FE0	\$1,601		
	22	36	21	118	13	FLV2236-21FE0		\$2,077	\$2,285
	22	36	21	124	13	FLT2236-21FOE	\$1,601		
	22	36	21	124	13	FLV2236-21FOE		\$2,077	\$2,285
	22	30	21	101	11	FLT2230-21FE0	\$1,554		
	22	30	21	101	11	FLV2230-21FE0		\$2,016	\$2,218
	22	30	21	107	11	FLT2230-21FOE	\$1,554		
	22	30	21	107	11	FLV2230-21FOE		\$2,016	\$2,218



*OE shown



*E0

Features:

- square edge on top
- electrical power unit - EC26 included, specify color
- open compartment with adjustable shelf
- shelf 12 1/2" d

Options:

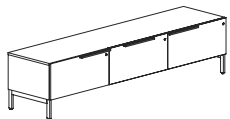
- must specify chassis grain direction on double cut veneer, see pages 13-15 for details
- oval or rectangular seat cushion available, see page 25 for more details and page 212 for pricing
- oval grommet in back panel can be eliminated upon request, no upcharge

To Order, Specify:

① Laminate Model #	② Laminate Type	③ Laminate Selection		④ Metal Color	⑤ Other Product Options
Laminate (FLT)	HPL	See Laminate Selection		See Metal Finish Color Options	See list of options for each specific unit; Specify and add accordingly.

① Veneer Model #	② Wood Species	③ Wood Finish		④ Metal Color	⑤ Other Product Options
Veneer (FLV)	Flat Cut CH1 Cherry MA1 Maple WA1 Walnut BO1 Black Oak	See Flat Cut Wood Finish Options		See Metal Finish Color Options	See list of options for each specific unit; Specify and add accordingly.
	Double Cut DC1 Double Cut	ⓐ Wood Finish See Double Cut Wood Finish Options	ⓑ Chassis Grain Direction For Double Cut Only: Vertical Horizontal		

Description	D	W	H	CTN WT	CU FT	① Model	HPL Laminate	Flat Cut Veneer	Double Cut Veneer
Lateral File Pedestal Credenza -	22	90	21	285	30	FLT2290-21L666	\$3,771		
Flush Legs	22	90	21	285	30	FLV2290-21L666		\$4,898	\$5,387



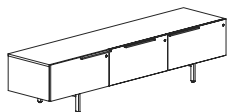
Features:

- pedestal front locking

Options:

- must specify chassis grain direction on double cut veneer, see pages 13-15 for details
- veneer drawer fronts in paint available, specify paint color and add \$337 list; see page 16 for details
- on laminate units, contrasting fronts available, no upcharge; specify color, see page 16 for details
- ledge pulls standard; prism pulls available, specify and see page 9
- oval or rectangular seat cushion available, see page 25 for more details and page 212 for pricing
- oval grommets in back panel can be eliminated upon request, no upcharge
- interior horizontal wire manager with end grommets available, specify and add \$180 list; see page 40 for details
- top grommet available, specify location and add \$128 list each; see page 46 for details

Lateral Credenza - Inset Legs	22	90	21	280	30	FLT2290-21S666	\$3,771		
	22	90	21	280	30	FLV2290-21S666		\$4,898	\$5,387



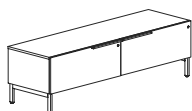
Features:

- pedestal front locking

Options:

- must specify chassis grain direction on double cut veneer, see pages 13-15 for details
- veneer drawer fronts in paint available, specify paint color and add \$337 list; see page 16 for details
- on laminate units, contrasting fronts available, no upcharge; specify color, see page 16 for details
- ledge pulls standard; prism pulls available, specify and see page 9
- oval or rectangular seat cushion available, see page 25 for more details and page 212 for pricing
- oval grommets in back panel can be eliminated upon request, no upcharge
- interior horizontal wire manager with end grommets available, specify and add \$180 list; see page 40 for details
- top grommet available, specify location and add \$128 list each; see page 46 for details

Lateral File Pedestal Credenza -	22	72	21	225	24	FLT2272-21L66	\$2,979		
Flush Legs	22	72	21	225	24	FLV2272-21L66		\$3,869	\$4,255
	22	60	21	198	20	FLT2260-21L66	\$2,811		
	22	60	21	198	20	FLV2260-21L66		\$3,649	\$4,015



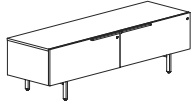
Features:

- pedestal front locking

Options:

- must specify chassis grain direction on double cut veneer, see pages 13-15 for details
- veneer drawer fronts in paint available, specify paint color and add \$337 list; see page 16 for details
- on laminate units, contrasting fronts available, no upcharge; specify color, see page 16 for details
- ledge pulls standard; prism pulls available, specify and see page 9
- oval or rectangular seat cushion available, see page 25 for more details and page 212 for pricing
- oval grommets in back panel can be eliminated upon request, no upcharge
- interior horizontal wire manager with end grommets available, specify and add \$180 list; see page 40 for details
- top grommet available, specify location and add \$128 list each; see page 46 for details

Description	D	W	H	CTN WT	CU FT	① Model	HPL Laminate	Flat Cut Veneer	Double Cut Veneer
Lateral Credenza - Inset Legs	22	72	21	220	24	FLT2272-21S66	\$2,979		
	22	72	21	220	24	FLV2272-21S66		\$3,869	\$4,255



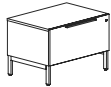
Features:

- pedestal front locking

Options:

- must specify chassis grain direction on double cut veneer, see pages 13-15 for details
- veneer drawer fronts in paint available, specify paint color and add \$337 list; see page 16 for details
- on laminate units, contrasting fronts available, no upcharge; specify color, see page 16 for details
- ledge pulls standard; prism pulls available, specify and see page 9
- oval or rectangular seat cushion available, see page 25 for more details and page 212 for pricing
- oval grommets in back panel can be eliminated upon request, no upcharge
- interior horizontal wire manager with end grommets available, specify and add \$180 list; see page 40 for details
- top grommet available, specify location and add \$128 list each; see page 46 for details

Lateral File Pedestal Credenza - Flush Legs	22	36	21	127	13	FLT2236-21L6	\$2,158		
	22	36	21	127	13	FLV2236-21L6		\$2,802	\$3,083
	22	30	21	104	11	FLT2230-21L6	\$2,096		
	22	30	21	104	11	FLV2230-21L6		\$2,719	\$2,992



Features:

- pedestal front locking

Options:

- must specify chassis grain direction on double cut veneer, see pages 13-15 for details
- veneer drawer fronts in paint available, specify paint color and add \$337 list; see page 16 for details
- on laminate units, contrasting fronts available, no upcharge; specify color, see page 16 for details
- ledge pulls standard; prism pulls available, specify and see page 9
- oval or rectangular seat cushion available, see page 25 for more details and page 212 for pricing
- oval grommets in back panel can be eliminated upon request, no upcharge
- interior horizontal wire manager with end grommets available, specify and add \$180 list; see page 40 for details
- top grommet available, specify location and add \$128 list each; see page 46 for details

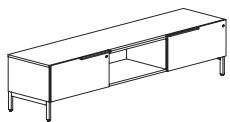
To Order, Specify:

① Laminate Model #	② Laminate Type	③ Laminate Selection	④ Metal Color	⑤ Other Product Options
Laminate (FLT)	HPL	See Laminate Selection	See Metal Finish Color Options	See list of options for each specific unit; Specify and add accordingly.

① Veneer Model #	② Wood Species	③ Wood Finish	④ Metal Color	⑤ Other Product Options	
Veneer (FLV)	Flat Cut CH1 Cherry MA1 Maple WA1 Walnut BO1 Black Oak	See Flat Cut Wood Finish Options	See Metal Finish Color Options	See list of options for each specific unit; Specify and add accordingly.	
	Double Cut DC1 Double Cut	<table border="1"> <thead> <tr> <th>ⓐ Wood Finish</th> <th>ⓑ Chassis Grain Direction</th> </tr> </thead> <tbody> <tr> <td>See Double Cut Wood Finish Options</td> <td>For Double Cut Only: Vertical Horizontal</td> </tr> </tbody> </table>			ⓐ Wood Finish
ⓐ Wood Finish	ⓑ Chassis Grain Direction				
See Double Cut Wood Finish Options	For Double Cut Only: Vertical Horizontal				

FLUX - PRIVATE OFFICE

Description	D	W	H	CTN WT	CU FT	① Model	HPL Laminate	Flat Cut Veneer	Double Cut Veneer
Lateral File and Open Storage	22	96	21	250	32	FLT2296-21L606	\$3,523		
Credenza - Flush Legs	22	96	21	250	32	FLV2296-21L606		\$4,575	\$5,031
	22	90	21	258	30	FLT2290-21L606	\$3,419		
	22	90	21	258	30	FLV2290-21L606		\$4,441	\$4,885



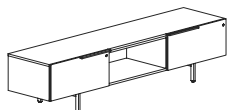
Features:

- pedestal front locking

Options:

- must specify chassis grain direction on double cut veneer, see pages 13-15 for details
- peninsula desk mounting must be specified when ordering secondary credenza; see page 17 for details
- veneer drawer fronts in paint available, specify paint color and add \$337 list; see page 16 for details
- on laminate units, contrasting fronts available, no upcharge; specify color, see page 16 for details
- ledge pulls standard; prism pulls available, specify and see page 9
- oval or rectangular seat cushion available, see page 25 for more details and page 212 for pricing
- oval grommets in back panel can be eliminated upon request, no upcharge
- interior horizontal wire manager with end grommets available, specify and add \$180 list; see page 40 for details
- top grommet available, specify location; add \$128 list each; see page 46 for details
- worksurface power available, specify "to accommodate EC26" on your purchase order; EC26 unit must be ordered separately, see page 46

Lateral File and Open Storage	22	90	21	247	30	FLT2290-21S606	\$3,523		
Credenza - Inset Legs	22	90	21	247	30	FLV2290-21S606		\$4,575	\$5,031



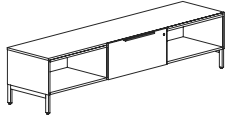
Features:

- pedestal front locking

Options:

- must specify chassis grain direction on double cut veneer, see pages 13-15 for details
- peninsula desk mounting must be specified when ordering secondary credenza; see page 17 for details
- veneer drawer fronts in paint available, specify paint color and add \$337 list; see page 16 for details
- on laminate units, contrasting fronts available, no upcharge; specify color, see page 16 for details
- ledge pulls standard; prism pulls available, specify and see page 9
- oval or rectangular seat cushion available, see page 25 for more details and page 212 for pricing
- oval grommets in back panel can be eliminated upon request, no upcharge
- interior horizontal wire manager with end grommets available, specify and add \$180 list; see page 40 for details
- top grommet available, specify location; add \$128 list each; see page 46 for details
- worksurface power available, specify "to accommodate EC26" on your purchase order; EC26 unit must be ordered separately, see page 46

Description	D	W	H	CTN WT	CU FT	① Model	HPL Laminate	Flat Cut Veneer	Double Cut Veneer
Lateral File and Open Storage Credenza - Flush Legs	22	96	21	232	32	FLT2296-21L060	\$3,300		
	22	96	21	232	32	FLV2296-21L060		\$4,284	\$4,710
	22	90	21	252	30	FLT2290-21L060	\$3,203		
	22	90	21	252	30	FLV2290-21L060		\$4,157	\$4,576



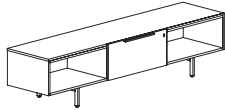
Features:

- pedestal front locking

Options:

- must specify chassis grain direction on double cut veneer, see pages 13-15 for details
- peninsula desk mounting must be specified when ordering secondary credenza; see page 17 for details
- veneer drawer fronts in paint available, specify paint color and add \$337 list; see page 16 for details
- on laminate units, contrasting fronts available, no upcharge; specify color, see page 16 for details
- ledge pulls standard; prism pulls available, specify and see page 9
- oval or rectangular seat cushion available, see page 25 for more details and page 212 for pricing
- oval grommets in back panel can be eliminated upon request, no upcharge
- interior horizontal wire manager with end grommets available, specify and add \$180 list; see page 40 for details
- top grommet available, specify location; add \$128 list each; see page 46 for details
- worksurface power available, specify "to accommodate EC26" on your purchase order; EC26 unit must be ordered separately, see page 46

Lateral File and Open Storage Credenza with Inset Legs	22	90	21	251	30	FLT2290-21S060	\$3,300		
	22	90	21	251	30	FLV2290-21S060		\$4,284	\$4,710



Features:

- pedestal front locking

Options:

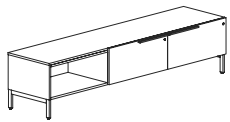
- must specify chassis grain direction on double cut veneer, see pages 13-15 for details
- peninsula desk mounting must be specified when ordering secondary credenza; see page 17 for details
- veneer drawer fronts in paint available, specify paint color and add \$337 list; see page 16 for details
- on laminate units, contrasting fronts available, no upcharge; specify color, see page 16 for details
- ledge pulls standard; prism pulls available, specify and see page 9
- oval or rectangular seat cushion available, see page 25 for more details and page 212 for pricing
- oval grommets in back panel can be eliminated upon request, no upcharge
- interior horizontal wire manager with end grommets available, specify and add \$180 list; see page 40 for details
- top grommet available, specify location; add \$128 list each; see page 46 for details
- worksurface power available, specify "to accommodate EC26" on your purchase order; EC26 unit must be ordered separately, see page 46

To Order, Specify:

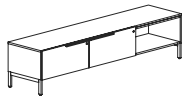
① Laminate Model #	② Laminate Type	③ Laminate Selection	④ Metal Color	⑤ Other Product Options
Laminate (FLT)	HPL	See Laminate Selection	See Metal Finish Color Options	See list of options for each specific unit; Specify and add accordingly.

① Veneer Model #	② Wood Species	③ Wood Finish	④ Metal Color	⑤ Other Product Options	
Veneer (FLV)	Flat Cut CH1 Cherry MA1 Maple WA1 Walnut BO1 Black Oak	See Flat Cut Wood Finish Options	See Metal Finish Color Options	See list of options for each specific unit; Specify and add accordingly.	
	Double Cut DC1 Double Cut	<table border="1"> <thead> <tr> <th>ⓐ Wood Finish</th> <th>ⓑ Chassis Grain Direction</th> </tr> </thead> <tbody> <tr> <td>See Double Cut Wood Finish Options</td> <td>For Double Cut Only: Vertical Horizontal</td> </tr> </tbody> </table>			ⓐ Wood Finish
ⓐ Wood Finish	ⓑ Chassis Grain Direction				
See Double Cut Wood Finish Options	For Double Cut Only: Vertical Horizontal				

Description	D	W	H	CTN WT	CU FT	① Model	HPL Laminate	Flat Cut Veneer	Double Cut Veneer
Lateral File and Open Storage	22	96	21	256	32	FLT2296-21L066	\$3,523		
	22	96	21	256	32	FLV2296-21L066		\$4,575	\$5,031
Credenza - Flush Legs	22	96	21	256	32	FLT2296-21L660	\$3,523		
	22	96	21	256	32	FLV2296-21L660		\$4,575	\$5,031
*066 shown	22	90	21	256	30	FLT2290-21L066	\$3,419		
	22	90	21	256	30	FLV2290-21L066		\$4,441	\$4,885
*660	22	90	21	256	30	FLT2290-21L660	\$3,419		
	22	90	21	256	30	FLV2290-21L660		\$4,441	\$4,885



*066 shown



*660

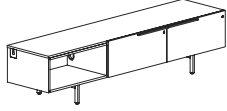
Features:

- pedestal front locking

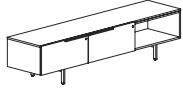
Options:

- must specify chassis grain direction on double cut veneer, see pages 13-15 for details
- peninsula desk mounting must be specified when ordering secondary credenza; see page 17 for details
- veneer drawer fronts in paint available, specify paint color and add \$337 list; see page 16 for details
- on laminate units, contrasting fronts available, no upcharge; specify color, see page 16 for details
- ledge pulls standard; prism pulls available, specify and see page 9
- oval or rectangular seat cushion available, see page 25 for more details and page 212 for pricing
- oval grommets in back panel can be eliminated upon request, no upcharge
- interior horizontal wire manager with end grommets available, specify and add \$180 list; see page 40 for details
- top grommet available, specify location; add \$128 list each; see page 47 for details
- worksurface power available, specify "to accommodate EC26" on your purchase order; EC26 unit must be ordered separately, see page 47

Description	D	W	H	CTN WT	CU FT	① Model	HPL Laminate	Flat Cut Veneer	Double Cut Veneer
Lateral File and Open Storage	22	90	21	251	30	FLT2290-21S066	\$3,523		
Credenza with Inset Legs - Secondary Height	22	90	21	251	30	FLV2290-21S066		\$4,575	\$5,031
	22	90	21	251	30	FLT2290-21S660	\$3,523		
	22	90	21	251	30	FLV2290-21S660		\$4,575	\$5,031



*066 shown



*660

Features:

- pedestal front locking

Options:

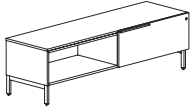
- must specify chassis grain direction on double cut veneer, see pages 13-15 for details
- peninsula desk mounting must be specified when ordering secondary credenza; see page 17 for details
- veneer drawer fronts in paint available, specify paint color and add \$337 list; see page 16 for details
- on laminate units, contrasting fronts available, no upcharge; specify color, see page 16 for details
- ledge pulls standard; prism pulls available, specify and see page 9
- oval or rectangular seat cushion available, see page 25 for more details and page 212 for pricing
- oval grommets in back panel can be eliminated upon request, no upcharge
- interior horizontal wire manager with end grommets available, specify and add \$180 list; see page 40 for details
- top grommet available, specify location; add \$128 list each; see page 47 for details
- worksurface power available, specify "to accommodate EC26" on your purchase order; EC26 unit must be ordered separately, see page 47

To Order, Specify:

① Laminate Model #	② Laminate Type	③ Laminate Selection		④ Metal Color	⑤ Other Product Options
Laminate (FLT)	HPL	See Laminate Selection		See Metal Finish Color Options	See list of options for each specific unit; Specify and add accordingly.

① Veneer Model #	② Wood Species	③ Wood Finish		④ Metal Color	⑤ Other Product Options
Veneer (FLV)	Flat Cut CH1 Cherry MA1 Maple WA1 Walnut BO1 Black Oak	See Flat Cut Wood Finish Options		See Metal Finish Color Options	See list of options for each specific unit; Specify and add accordingly.
	Double Cut DC1 Double Cut	3a Wood Finish See Double Cut Wood Finish Options	3b Chassis Grain Direction For Double Cut Only: Vertical Horizontal		

Description	D	W	H	CTN WT	CU FT	① Model	HPL Laminate	Flat Cut Veneer	Double Cut Veneer
Lateral File and Open Storage Credenza - Flush Legs	22	72	21	210	24	FLT2272-21L06	\$2,749		
	22	72	21	210	24	FLV2272-21L06		\$3,569	\$3,925
	22	72	21	210	24	FLT2272-21L60	\$2,749		
	22	72	21	210	24	FLV2272-21L60		\$3,569	\$3,925
	22	66	21	186	22	FLT2266-21L06	\$2,669		
	22	66	21	186	22	FLV2266-21L06		\$3,462	\$3,809
	22	66	21	177	22	FLT2266-21L60	\$2,669		
	22	66	21	177	22	FLV2266-21L60		\$3,462	\$3,809
	22	60	21	169	20	FLT2260-21L06	\$2,588		
	22	60	21	169	20	FLV2260-21L06		\$3,356	\$3,695
	22	60	21	169	20	FLT2260-21L60	\$2,588		
	22	60	21	169	20	FLV2260-21L60		\$3,356	\$3,695



*06 shown



*60 shown

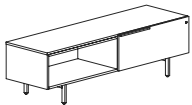
Features:

- pedestal front locking

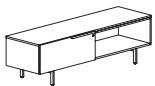
Options:

- must specify chassis grain direction on double cut veneer, see pages 13-15 for details
- peninsula desk mounting must be specified when ordering secondary credenza; see page 17 for details
- veneer drawer fronts in paint available, specify paint color and add \$337 list; see page 16 for details
- on laminate units, contrasting fronts available, no upcharge; specify color, see page 16 for details
- ledge pulls standard; prism pulls available, specify and see page 9
- oval or rectangular seat cushion available, see page 25 for more details and page 212 for pricing
- oval grommets in back panel can be eliminated upon request, no upcharge
- interior horizontal wire manager with end grommets available, specify and add \$180 list; see page 40 for details
- top grommet available, specify location; add \$128 list each; see page 47 for details
- worksurface power available, specify "to accommodate EC26" on your purchase order; EC26 unit must be ordered separately, see page 47

Lateral File and Open Storage Credenza - Inset Legs	22	72	21	205	24	FLT2272-21S06	\$2,749		
	22	72	21	205	24	FLV2272-21S06		\$3,569	\$3,924
	22	72	21	205	24	FLT2272-21S60	\$2,749		
	22	72	21	205	24	FLV2272-21S60		\$3,569	\$3,924
	22	60	21	161	20	FLT2260-21S06	\$2,588		
	22	60	21	161	20	FLV2260-21S06		\$3,356	\$3,695
	22	60	21	161	20	FLT2260-21S60	\$2,588		
	22	60	21	161	20	FLV2260-21S60		\$3,356	\$3,695



*06 shown



*60

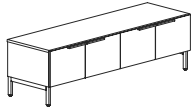
Features:

- pedestal front locking

Options:

- must specify chassis grain direction on double cut veneer, see pages 13-15 for details
- peninsula desk mounting must be specified when ordering secondary credenza; see page 17 for details
- veneer drawer fronts in paint available, specify paint color and add \$337 list; see page 16 for details
- on laminate units, contrasting fronts available, no upcharge; specify color, see page 16 for details
- ledge pulls standard; prism pulls available, specify and see page 9
- oval or rectangular seat cushion available, see page 25 for more details and page 212 for pricing
- oval grommets in back panel can be eliminated upon request, no upcharge
- interior horizontal wire manager with end grommets available, specify and add \$180 list; see page 40 for details
- top grommet available, specify location; add \$128 list each; see page 47 for details
- worksurface power available, specify "to accommodate EC26" on your purchase order; EC26 unit must be ordered separately, see page 47

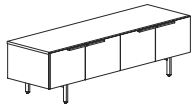
Description	D	W	H	CTN WT	CU FT	① Model	HPL Laminate	Flat Cut Veneer	Double Cut Veneer
Four Door Storage - Flush Legs	22	72	21	189	24	FLT2272-21L77	\$2,323		
	22	72	21	189	24	FLV2272-21L77		\$3,016	\$3,316
	22	60	21	160	20	FLT2260-21L77	\$2,183		
	22	60	21	160	20	FLV2260-21L77		\$2,834	\$3,120



Options:

- must specify chassis grain direction on double cut veneer, see pages 13-15 for details
- locking doors available, specify and add \$284 list
- veneer door fronts in paint available, specify paint color and add \$337 list; see page 16 for details
- on laminate units, contrasting laminate door fronts available, no upcharge; specify laminate color, see page 16 for details
- ledge pulls standard; prism pulls available, specify and see page 9
- oval or rectangular seat cushion available, see page 25 for more details and page 212 for pricing
- oval grommets in back panel can be eliminated upon request, no upcharge
- interior horizontal wire manager with end grommets available, specify and add \$180 list; see page 40 for details
- top grommet available, specify location; add \$128 list each; see page 46 for details
- worksurface power available, specify "to accommodate EC26" on your purchase order; EC26 unit must be ordered separately, see page 46

Description	D	W	H	CTN WT	CU FT	① Model	HPL Laminate	Flat Cut Veneer	Double Cut Veneer
Four Door Storage Credenza - Inset Legs	22	72	21	196	20	FLT2272-21S77	\$2,323		
	22	72	21	196	20	FLV2272-21S77		\$3,016	\$3,316
	22	60	21	152	20	FLT2260-21S77	\$2,183		
	22	60	21	152	20	FLV2260-21S77		\$2,834	\$3,119



Options:

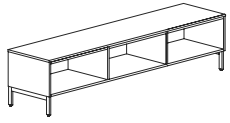
- must specify chassis grain direction on double cut veneer, see pages 13-15 for details
- locking doors available, specify and add \$284 list
- veneer door fronts in paint available, specify paint color and add \$337 list; see page 16 for details
- on laminate units, contrasting laminate door fronts available, no upcharge; specify laminate color, see page 16 for details
- ledge pulls standard; prism pulls available, specify and see page 9
- oval or rectangular seat cushion available, see page 25 for more details and page 212 for pricing
- oval grommets in back panel can be eliminated upon request, no upcharge
- interior horizontal wire manager with end grommets available, specify and add \$180 list; see page 40 for details
- top grommet available, specify location; add \$128 list each; see page 46 for details
- worksurface power available, specify "to accommodate EC26" on your purchase order; EC26 unit must be ordered separately, see page 46

To Order, Specify:

① Laminate Model #	② Laminate Type	③ Laminate Selection	④ Metal Color	⑤ Other Product Options
Laminate (FLT)	HPL	See Laminate Selection	See Metal Finish Color Options	See list of options for each specific unit; Specify and add accordingly.

① Veneer Model #	② Wood Species	③ Wood Finish	④ Metal Color	⑤ Other Product Options	
Veneer (FLV)	Flat Cut CH1 Cherry MA1 Maple WA1 Walnut BO1 Black Oak	See Flat Cut Wood Finish Options	See Metal Finish Color Options	See list of options for each specific unit; Specify and add accordingly.	
	Double Cut DC1 Double Cut	<table border="1"> <thead> <tr> <th>ⓐ Wood Finish</th> <th>ⓑ Chassis Grain Direction</th> </tr> </thead> <tbody> <tr> <td>See Double Cut Wood Finish Options</td> <td>For Double Cut Only: Vertical Horizontal</td> </tr> </tbody> </table>			ⓐ Wood Finish
ⓐ Wood Finish	ⓑ Chassis Grain Direction				
See Double Cut Wood Finish Options	For Double Cut Only: Vertical Horizontal				

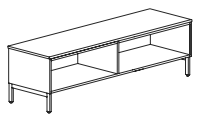
Description	D	W	H	CTN WT	CU FT	① Model	HPL Laminate	Flat Cut Veneer	Double Cut Veneer
Open Compartment Storage	22	90	21	193	30	FLT2290-21L000	\$2,611		
Credenza - Flush Legs	22	90	21	193	30	FLV2290-21L000		\$3,390	\$3,729



Options:

- must specify chassis grain direction on double cut veneer, see pages 13-15 for details
- peninsula desk mounting must be specified when ordering secondary credenza; see page 17 for details
- oval or rectangular seat cushion available, see page 25 for more details and page 212 for pricing
- oval grommets in back panel can be eliminated upon request, no upcharge
- top grommet available, specify location; add \$128 list each; see page 45 for details
- worksurface power available, specify "to accommodate EC26" on your purchase order; EC26 unit must be ordered separately, see page 47

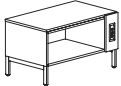

Open Compartment Storage	22	72	21	136	24	FLT2272-21L00	\$2,089		
Credenza - Flush Legs	22	72	21	136	24	FLV2272-21L00		\$2,714	\$2,984
	22	60	21	136	20	FLT2260-21L00	\$1,968		
	22	60	21	136	20	FLV2260-21L00		\$2,553	\$2,808



Options:

- must specify chassis grain direction on double cut veneer, see pages 13-15 for details
- peninsula desk mounting must be specified when ordering secondary credenza; see page 17 for details
- oval or rectangular seat cushion available, see page 25 for more details and page 212 for pricing
- oval grommets in back panel can be eliminated upon request, no upcharge
- top grommet available, specify location; add \$128 list each; see page 45 for details
- worksurface power available, specify "to accommodate EC26" on your purchase order; EC26 unit must be ordered separately, see page 47

FLUX - PRIVATE OFFICE

Description	D	W	H	CTN WT	CU FT	① Model	HPL Laminate	Flat Cut Veneer	Double Cut Veneer
Open Storage with Side Power Access - Flush Legs  *OE shown  *E0	22	36	21	100	13	FLT2236-21LE0	\$2,145		
	22	36	21	100	13	FLV2236-21LE0		\$2,782	\$3,061
	22	36	21	96	13	FLT2236-21LOE	\$2,145		
	22	36	21	96	13	FLV2236-21LOE		\$2,782	\$3,061
	22	30	21	84	11	FLT2230-21LE0	\$2,103		
	22	30	21	84	11	FLV2230-21LE0		\$2,727	\$3,002
	22	30	21	84	11	FLT2230-21LOE	\$2,103		
	22	30	21	84	11	FLV2230-21LOE		\$2,727	\$3,002

Features:

- square edge on top
- electrical power unit - EC26 included, specify color



Options:

- must specify chassis grain direction on double cut veneer, see pages 13-15 for details
- oval or rectangular seat cushion available, see page 25 for more details and page 212 for pricing
- oval grommet in back panel can be eliminated upon request, no upcharge


To Order, Specify:


① Laminate Model #	② Laminate Type	③ Laminate Selection		④ Metal Color	⑤ Other Product Options
Laminate (FLT)	HPL	See Laminate Selection		See Metal Finish Color Options	See list of options for each specific unit; Specify and add accordingly.

① Veneer Model #	② Wood Species	③ Wood Finish		④ Metal Color	⑤ Other Product Options
Veneer (FLV)	Flat Cut CH1 Cherry MA1 Maple WA1 Walnut BO1 Black Oak	See Flat Cut Wood Finish Options		See Metal Finish Color Options	See list of options for each specific unit; Specify and add accordingly.
		ⓐ Wood Finish	ⓑ Chassis Grain Direction		

Description	D	W	H	CTN WT	CU FT	① Model	List Price Per Grade
Oval Cushion  · use with secondary height units 30" - 36" wide · com ydg: 1 ¼	20	29	1 ¾	10	2	FLB2029OVCUSH	COM \$286
							A \$302
							B \$334
							COL/C \$387
							D \$456
							E \$523
							F \$629
							G \$745
							H \$867
							I \$1,057
							J \$1,287
							L1 \$830
							L2 \$966
Rectangular Cushion  · use with secondary height units 30" - 36" wide · com ydg: 1 ¼	20	29	1 ¾	11	2	FLB2029RECUSH	COM \$286
							A \$302
							B \$334
							COL/C \$387
							D \$456
							E \$523
							F \$629
							G \$745
							H \$867
							I \$1,057
							J \$1,287
							L1 \$830
							L2 \$966

FLUX - PRIVATE OFFICE

Description	D	W	H	CTN WT	CU FT	① Model	List Price Per Grade
Round Cushion	15 ¼	15 ¼	1 ¾	5	1	FLB1515RDCUSH	COM \$231
	<ul style="list-style-type: none"> · use with secondary height 18" w mobile pedestals · com ydg: ¾ 						A \$240
							B \$258
							COL/C \$290
							D \$333
							E \$372
							F \$436
							G \$505
							H \$579
							I \$691
							J \$832
							L1 \$555
							L2 \$638

Square Cushion	15 ¼	15 ¼	1 ¾	5	1	FLB1515SQCUSH	COM \$231
	<ul style="list-style-type: none"> · use with secondary height 18" w mobile pedestals · com ydg: ¾ 						A \$240
							B \$258
							COL/C \$290
							D \$333
							E \$372
							F \$436
							G \$505
							H \$579
							I \$691
							J \$832
							L1 \$555
							L2 \$638

FLUX - PRIVATE OFFICE

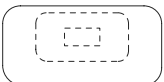
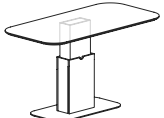
To Order, Specify:

① Model Number	② Fabric Selection	
(FLB)	Vendor Pattern Color	Visit www.jsifurniture.com/finishes-and-materials/textiles for our textiles program. See selection of standard and graded in manufacturers and patterns.

Description	D	W	H	CTN WT	CU FT	① Model	HPL Laminate	Flat Cut Veneer	Double Cut Veneer
Adjustable Height Rectangular Table Desk	36	72	Adj.	340	51	FLT3672AHT	\$6,392		
	36	72	Adj.	340	51	FLV3672AHT		\$6,961	\$7,657
	32	66	Adj.	323	42	FLT3266AHT	\$6,336		
	32	66	Adj.	323	42	FLV3266AHT		\$6,900	\$7,589
	32	60	Adj.	314	39	FLT3260AHT	\$6,312		
	32	60	Adj.	314	39	FLV3260AHT		\$6,871	\$7,557



center mount



offset mount

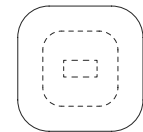
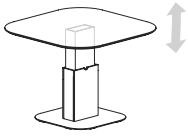
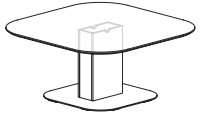
Features:

- eased edge profile all sides
- top may be installed offset for a desk or centered for a meeting table, see page 47 for details
- removable panel provides access to power column and wiring
- powder coat steel base plate with neoprene leveling pads
- 27¾" to 45¾" height adjustment with digital controller, wire guide and 10' power cord
- maximum weight rating 140 lbs. (evenly distributed load)

Options:

- reverse bevel edge available on top perimeter, specify; add \$429 list for laminate or \$168 list for veneer; see page 8 for details
- top grommet available, specify location; add \$128 list each; see page 49 for details

Adjustable Height Square Table Desk	60	60	Adj.	377	70	FLT6060SAHT	\$6,821		
	60	60	Adj.	404	70	FLV6060SAHT		\$7,430	\$8,175
	54	54	Adj.	359	57	FLT5454SAHT	\$6,624		
	54	54	Adj.	381	57	FLV5454SAHT		\$7,221	\$7,944
	48	48	Adj.	77	14	FLT4848SAHT	\$6,555		
	48	48	Adj.	314	46	FLV4848SAHT		\$7,146	\$7,859



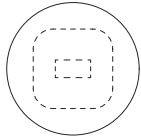
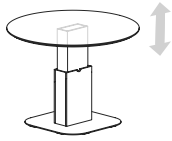
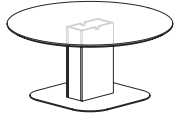
Features:

- eased edge profile all sides
- removable panel provides access to power column and wiring
- powder coat steel base plate with neoprene leveling pads
- 27¾" to 45¾" height adjustment with digital controller, wire guide and 10' power cord
- maximum weight rating 140 lbs. (evenly distributed load)

Options:

- reverse bevel edge available on top perimeter, specify; add \$429 list for laminate or \$168 list for veneer; see page 8 for details
- top grommet available, specify location; add \$128 list each; see page 49 for details

Description	D	W	H	CTN WT	CU FT	1 Model	HPL Laminate	Flat Cut Veneer	Double Cut Veneer
Adjustable Height Round Table Desk	60	60	Adj.	404	70	FLT6060RAHT	\$6,821		
	60	60	Adj.	377	70	FLV6060RAHT		\$7,430	\$8,175
	54	54	Adj.	381	57	FLT5454RAHT	\$6,624		
	54	54	Adj.	359	57	FLV5454RAHT		\$7,221	\$7,944
	48	48	Adj.	314	46	FLT4848RAHT	\$6,555		
	48	48	Adj.	301	46	FLV4848RAHT		\$7,146	\$7,859



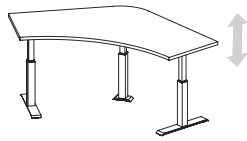
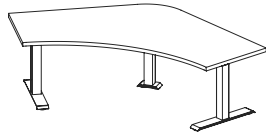
Features:

- eased edge profile all sides
- removable panel provides access to power column and wiring
- powder coat steel base plate with neoprene leveling pads
- 27¾" to 45¾" height adjustment with digital controller, wire guide and 10' power cord
- maximum weight rating 140 lbs. (evenly distributed load)

Options:

- reverse bevel edge available on top perimeter, specify; add \$429 list for laminate or \$168 list for veneer; see page 8 for details
- top grommet available, specify location; add \$128 list each; see page 49 for details

Adjustable Height Table - 120°	30	84	Adj.	233	23	FLT3084-29AH120T	\$3,901		
	30	84	Adj.	233	23	FLV3084-29AH120T		\$4,836	\$5,174
	24	84	Adj.	218	21	FLT2484-29AH120T	\$3,821		
	24	84	Adj.	218	21	FLV2484-29AH120T		\$4,739	\$5,070



Features:

- eased edge profile on approach and user sides
- 22½" to 48½" height adjustment
- maximum weight rating 140 lbs. (evenly distributed load)
- key pad features height display with three memory settings; key pad mounts left or right
- 120" power cord

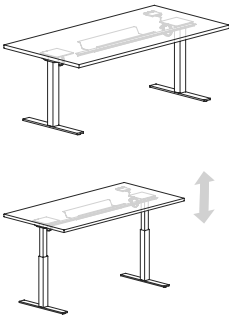
Options:

- specify Matte Black (MBK) or Arctic Silver (ASL) base finish
- top grommet available in center location, specify location; add \$128 list each
- optional EC33 unit must be ordered separately, see page 457
- undermount power available, specify and add \$946 list

To Order, Specify:

1 Laminate Model #	2 Laminate Type	3 Laminate Selection	4 Metal Color	5 Other Product Options
Laminate (FLT)	HPL	See Laminate Selection	See Metal Finish Color Options	See list of options for each specific unit; Specify and add accordingly.

1 Veneer Model #	2 Wood Species	3 Wood Finish	4 Metal Color	5 Other Product Options	
Veneer (FLV)	Flat Cut CH1 Cherry MA1 Maple WA1 Walnut BO1 Black Oak	See Flat Cut Wood Finish Options	See Metal Finish Color Options	See list of options for each specific unit; Specify and add accordingly.	
	Double Cut DC1 Double Cut	<table border="1"> <thead> <tr> <th>3a Wood Finish</th> <th>3b Chassis Grain Direction</th> </tr> </thead> <tbody> <tr> <td>See Double Cut Wood Finish Options</td> <td>For Double Cut Only: Vertical Horizontal</td> </tr> </tbody> </table>			3a Wood Finish
3a Wood Finish	3b Chassis Grain Direction				
See Double Cut Wood Finish Options	For Double Cut Only: Vertical Horizontal				

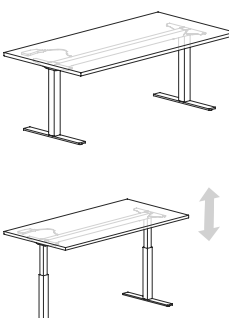
Description	D	W	H	CTN WT	CU FT	① Model	HPL Laminate	Flat Cut Veneer	Double Cut Veneer
Electric Adjustable Height Table Desk 	36	72	Adj.	194	18	FLT3672AHTD-EL	\$2,568		
	36	72	Adj.	194	18	FLV3672AHTD-EL		\$3,200	\$3,383
	30	72	Adj.	175	16	FLT3072AHTD-EL	\$2,478		
	30	72	Adj.	175	16	FLV3072AHTD-EL		\$3,078	\$3,250
	30	66	Adj.	168	15	FLT3066AHTD-EL	\$2,445		
	30	66	Adj.	168	15	FLV3066AHTD-EL		\$3,043	\$3,212
	30	60	Adj.	160	14	FLT3060AHTD-EL	\$2,412		
	30	60	Adj.	160	14	FLV3060AHTD-EL		\$3,006	\$3,173
	24	72	Adj.	151	12	FLT2472AHTD-EL	\$2,390		
	24	72	Adj.	151	12	FLV2472AHTD-EL		\$2,954	\$3,120
	24	66	Adj.	146	11	FLT2466AHTD-EL	\$2,357		
	24	66	Adj.	146	11	FLV2466AHTD-EL		\$2,925	\$3,089
	24	60	Adj.	140	10	FLT2460AHTD-EL	\$2,327		
	24	60	Adj.	140	10	FLV2460AHTD-EL		\$2,897	\$3,058

Features:

- eased edge profile on approach and user sides
- 22½" to 49" height adjustment
- maximum weight rating 140 lbs. (evenly distributed load)
- key pad features height display with three memory settings; key pad mounts left or right
- display will reference position to the nearest ½"
- 120" power cord

Options:

- specify Matte Black (MBK) or Arctic Silver (ASL) base finish
- reverse bevel edge available on desk approach side only, specify; add \$429 list for laminate or \$168 list for veneer; see page 8 for details
- top grommet available, specify location and add \$128 list each; see page 49 for details
- undermount power available, specify and add \$946 list; power infeed sold separately, see page 224

Pneumatic Adjustable Height Table Desk 	36	72	Adj.	194	18	FLT3672AHTD-PN	\$4,406		
	36	72	Adj.	194	18	FLV3672AHTD-PN		\$5,213	\$5,732
	30	72	Adj.	175	16	FLT3072AHTD-PN	\$4,315		
	30	72	Adj.	175	16	FLV3072AHTD-PN		\$4,988	\$5,487
	30	66	Adj.	168	15	FLT3066AHTD-PN	\$4,225		
	30	66	Adj.	168	15	FLV3066AHTD-PN		\$4,842	\$5,327
	30	60	Adj.	160	14	FLT3060AHTD-PN	\$4,127		
	30	60	Adj.	160	14	FLV3060AHTD-PN		\$4,688	\$5,155
	24	72	Adj.	151	12	FLT2472AHTD-PN	\$4,132		
	24	72	Adj.	151	12	FLV2472AHTD-PN		\$4,669	\$5,136
	24	66	Adj.	146	11	FLT2466AHTD-PN	\$4,095		
	24	66	Adj.	146	11	FLV2466AHTD-PN		\$4,588	\$5,047
	24	60	Adj.	140	10	FLT2460AHTD-PN	\$4,040		
	24	60	Adj.	140	10	FLV2460AHTD-PN		\$4,487	\$4,937

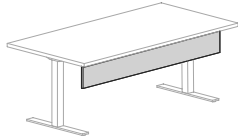
Features:

- eased edge profile on approach and user sides
- 27½" to 44½" height adjustment
- 20 lbs. lift force, maximum weight rating 140 lbs. (evenly distributed load)
- release lever mounts under edge of top

Options:

- specify Matte Black (MBK) or Alloy (ALY) base finish
- reverse bevel edge available on desk approach side only, specify; add \$429 list for laminate or \$168 list for veneer; see page 8 for details
- top grommet available, specify location; add \$128 list each; see page 49 for details

Description	D	W	H	CTN WT	CU FT	① Model	HPL Laminate	Flat Cut Veneer	Double Cut Veneer
Modesty Panels for Adjustable Height Tables	¾	64	9	18	3	FLT0964TDM	\$437		
	¾	64	9	18	3	FLV0964TDM		\$728	\$801
	¾	58	9	16	2	FLT0958TDM	\$426		
	¾	58	9	16	2	FLV0958TDM		\$706	\$775
	¾	52	9	14	2	FLT0952TDM	\$412		
	¾	52	9	14	2	FLV0952TDM		\$682	\$750



Features:

- FLV0964TDM or FLT0964TDM use with 72" wide adjustable height table desk
- FLV0958TDM or FLT0958TDM use with 66" wide adjustable height table desk
- FLV0952TDM or FLT0952TDM use with 60" wide adjustable height table desk

Options:

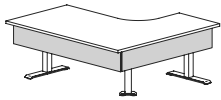
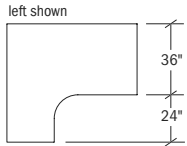
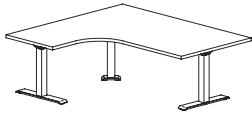
- specify modesty panel bracket finish; Black Sandtex (BSX) or Stardust Silver (STS)

To Order, Specify:

① Laminate Model #	② Laminate Type	③ Laminate Selection		④ Metal Color	⑤ Other Product Options
Laminate (FLT)	HPL	See Laminate Selection		See Metal Finish Color Options	See list of options for each specific unit; Specify and add accordingly.

① Veneer Model #	② Wood Species	③ Wood Finish		④ Metal Color	⑤ Other Product Options
Veneer (FLV)	Flat Cut CH1 Cherry MA1 Maple WA1 Walnut BO1 Black Oak	See Flat Cut Wood Finish Options		See Metal Finish Color Options	See list of options for each specific unit; Specify and add accordingly.
		③a Wood Finish	③b Chassis Grain Direction		
	Double Cut DC1 Double Cut	See Double Cut Wood Finish Options	For Double Cut Only: Vertical Horizontal		

Description	D	W	H	CTN WT	CU FT	① Model	HPL Laminate	Flat Cut Veneer	Double Cut Veneer
Adjustable Height Corner Table - 90° One Piece Top	60	72	Adj.	259	33	FLT3672CT24AHR	\$4,119		
	60	72	Adj.	259	33	FLV3672CT24AHR		\$5,106	\$5,464
	60	72	Adj.	259	33	FLT3672CT24AHL	\$4,119		
	60	72	Adj.	259	33	FLV3672CT24AHL		\$5,106	\$5,464
	60	66	Adj.	240	31	FLT3666CT24AHR	\$4,040		
	60	66	Adj.	240	31	FLV3666CT24AHR		\$5,008	\$5,360
	60	66	Adj.	240	31	FLT3666CT24AHL	\$4,040		
	60	66	Adj.	240	31	FLV3666CT24AHL		\$5,008	\$5,360
	60	60	Adj.	231	28	FLT3660CT24AHR	\$3,962		
	60	60	Adj.	231	28	FLV3660CT24AHR		\$4,912	\$5,256
	60	60	Adj.	231	28	FLT3660CT24AHL	\$3,962		
	60	60	Adj.	231	28	FLV3660CT24AHL		\$4,912	\$5,256



optional modesty panels

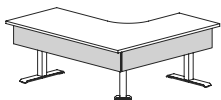
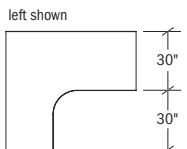
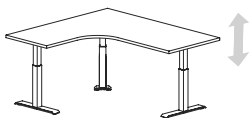
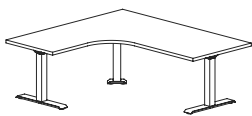
Features:

- eased edge profile on approach and user sides
- 22½" to 49" height adjustment
- maximum weight rating 140 lbs. (evenly distributed load)
- key pad features height display with three memory settings; key pad mounts left or right
- display will reference position to the nearest ½"
- 120" power cord

Options:

- specify Matte Black (MBK) or Arctic Silver (ASL) base finish
- reverse bevel edge available on desk approach side only, specify; add \$429 list for laminate or \$168 list for veneer; see page 8 for details
- top grommet available, specify location and add \$128 list each; see page 49 for details
- modesty panel available (2-sides) moves with worksurface, specify \$889 list for laminate or \$1,430 list for veneer; see page 21 for details
- undermount power available, specify and add \$946 list; power infeed sold separately, see page 224

Adjustable Height Corner Table - 90° One Piece Top	60	72	Adj.	234	33	FLT3072CT30AHR	\$4,119		
	60	72	Adj.	234	33	FLV3072CT30AHR		\$5,106	\$5,464
	60	72	Adj.	234	33	FLT3072CT30AHL	\$4,119		
	60	72	Adj.	234	33	FLV3072CT30AHL		\$5,106	\$5,464
	60	66	Adj.	230	31	FLT3066CT30AHR	\$4,040		
	60	66	Adj.	230	31	FLV3066CT30AHR		\$5,008	\$5,360
	60	66	Adj.	230	31	FLT3066CT30AHL	\$4,040		
	60	66	Adj.	230	31	FLV3066CT30AHL		\$5,008	\$5,360
	60	60	Adj.	222	28	FLT3060CT30AHR	\$3,962		
	60	60	Adj.	222	28	FLV3060CT30AHR		\$4,912	\$5,256
	60	60	Adj.	222	28	FLT3060CT30AHL	\$3,962		
	60	60	Adj.	222	28	FLV3060CT30AHL		\$4,912	\$5,256



optional modesty panels

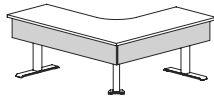
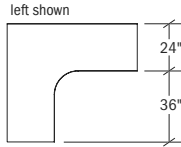
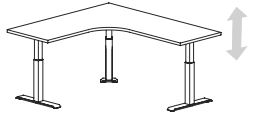
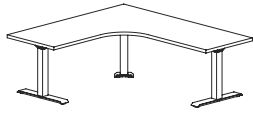
Features:

- eased edge profile on approach and user sides
- 22½" to 49" height adjustment
- maximum weight rating 140 lbs. (evenly distributed load)
- key pad features height display with three memory settings; key pad mounts left or right
- display will reference position to the nearest ½"
- 120" power cord

Options:

- specify Matte Black (MBK) or Arctic Silver (ASL) base finish
- reverse bevel edge available on desk approach side only, specify; add \$429 list for laminate or \$168 list for veneer; see page 8 for details
- top grommet available, specify location and add \$128 list each; see page 49 for details
- modesty panel available (2-sides) moves with worksurface, specify \$889 list for laminate or \$1,430 list for veneer; see page 21 for details
- undermount power available, specify and add \$946 list; power infeed sold separately, see page 224

Description	D	W	H	CTN WT	CU FT	1 Model	HPL Laminate	Flat Cut Veneer	Double Cut Veneer
Adjustable Height Corner Table - 90° One Piece Top	60	72	Adj.	225	33	FLT2472CT36AHR	\$4,119		
	60	72	Adj.	225	33	FLV2472CT36AHR		\$5,106	\$5,464
	60	72	Adj.	225	33	FLT2472CT36AHL	\$4,119		
	60	72	Adj.	225	33	FLV2472CT36AHL		\$5,106	\$5,464
	60	66	Adj.	220	31	FLT2466CT36AHR	\$4,040		
	60	66	Adj.	220	31	FLV2466CT36AHR		\$5,008	\$5,360
	60	66	Adj.	220	31	FLT2466CT36AHL	\$4,040		
	60	66	Adj.	220	31	FLV2466CT36AHL		\$5,008	\$5,360
	60	60	Adj.	214	28	FLT2460CT36AHR	\$3,962		
	60	60	Adj.	214	28	FLV2460CT36AHR		\$4,912	\$5,256
	60	60	Adj.	214	28	FLT2460CT36AHL	\$3,962		
	60	60	Adj.	214	28	FLV2460CT36AHL		\$4,912	\$5,256



optional modesty panels

Features:

- eased edge profile on approach and user sides
- 22½" to 49" height adjustment
- maximum weight rating 140 lbs. (evenly distributed load)
- key pad features height display with three memory settings; key pad mounts left or right
- display will reference position to the nearest ½"
- 120" power cord

Options:

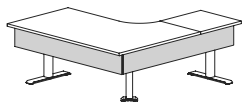
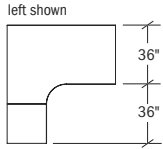
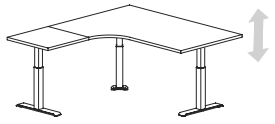
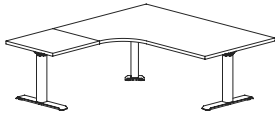
- specify Matte Black (MBK) or Arctic Silver (ASL) base finish
- reverse bevel edge available on desk approach side only, specify; add \$429 list for laminate or \$168 list for veneer; see page 8 for details
- top grommet available, specify location and add \$128 list each; see page 49 for details
- modesty panel available (2-sides) moves with worksurface, specify \$889 list for laminate or \$1,430 list for veneer; see page 21 for details
- undermount power available, specify and add \$946 list; power infeed sold separately, see page 224

To Order, Specify:

1 Laminate Model #	2 Laminate Type	3 Laminate Selection	4 Metal Color	5 Other Product Options
Laminate (FLT)	HPL	See Laminate Selection	See Metal Finish Color Options	See list of options for each specific unit; Specify and add accordingly.

1 Veneer Model #	2 Wood Species	3 Wood Finish	4 Metal Color	5 Other Product Options
Veneer (FLV)	Flat Cut CH1 Cherry MA1 Maple WA1 Walnut BO1 Black Oak	See Flat Cut Wood Finish Options	See Metal Finish Color Options	See list of options for each specific unit; Specify and add accordingly.
		<table border="1"> <thead> <tr> <th>3a Wood Finish</th> <th>3b Chassis Grain Direction</th> </tr> </thead> <tbody> <tr> <td>See Double Cut Wood Finish Options</td> <td>For Double Cut Only: Vertical Horizontal</td> </tr> </tbody> </table>		
3a Wood Finish	3b Chassis Grain Direction			
See Double Cut Wood Finish Options	For Double Cut Only: Vertical Horizontal			

Description	D	W	H	CTN WT	CU FT	① Model	HPL Laminate	Flat Cut Veneer	Double Cut Veneer
Adjustable Height Corner Table - 90° Two Piece Top	72	72	Adj.	255	27	FLT3672CDT36R	\$4,216		
	72	72	Adj.	255	27	FLV3672CDT36R		\$5,227	\$5,594
	72	72	Adj.	255	27	FLT3672CDT36L	\$4,216		
	72	72	Adj.	255	27	FLV3672CDT36L		\$5,227	\$5,594
	72	66	Adj.	247	25	FLT3666CDT36R	\$4,174		
	72	66	Adj.	247	25	FLV3666CDT36R		\$5,176	\$5,538
	72	66	Adj.	247	25	FLT3666CDT36L	\$4,174		
	72	66	Adj.	247	25	FLV3666CDT36L		\$5,176	\$5,538
	72	60	Adj.	237	23	FLT3660CDT36R	\$4,131		
	72	60	Adj.	237	23	FLV3660CDT36R		\$5,122	\$5,480
	72	60	Adj.	237	23	FLT3660CDT36L	\$4,131		
	72	60	Adj.	237	23	FLV3660CDT36L		\$5,122	\$5,480



optional modesty panels

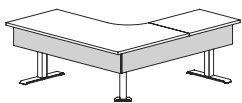
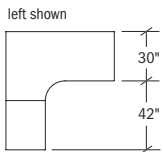
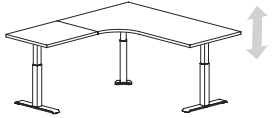
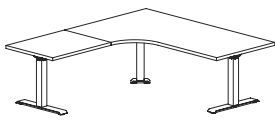
Features:

- eased edge profile on approach and user sides
- 22½" to 49" height adjustment
- maximum weight rating 140 lbs. (evenly distributed load)
- key pad features height display with three memory settings; key pad mounts left or right
- display will reference position to the nearest ½"
- 120" power cord

Options:

- specify Matte Black (MBK) or Arctic Silver (ASL) base finish
- reverse bevel edge available on desk approach side only, specify; add \$429 list for laminate or \$168 list for veneer; see page 8 for details
- top grommet available, specify location and add \$128 list each; see page 49 for details
- modesty panel available (2-sides) moves with worksurface, specify \$889 list for laminate or \$1,430 list for veneer; see page 21 for details
- undermount power available, specify and add \$946 list; power infeed sold separately, see page 224

Adjustable Height Corner Table - 90° Two Piece Top	72	72	Adj.	223	24	FLT3072CDT42R	\$4,216		
	72	72	Adj.	223	24	FLV3072CDT42R		\$5,227	\$5,594
	72	72	Adj.	223	24	FLT3072CDT42L	\$4,216		
	72	72	Adj.	223	24	FLV3072CDT42L		\$5,227	\$5,594
	72	66	Adj.	213	22	FLT3066CDT42R	\$4,174		
	72	66	Adj.	213	22	FLV3066CDT42R		\$5,176	\$5,538
	72	66	Adj.	213	22	FLT3066CDT42L	\$4,174		
	72	66	Adj.	213	22	FLV3066CDT42L		\$5,176	\$5,538
	72	60	Adj.	203	21	FLT3060CDT42R	\$4,131		
	72	60	Adj.	203	21	FLV3060CDT42R		\$5,122	\$5,480
	72	60	Adj.	203	21	FLT3060CDT42L	\$4,131		
	72	60	Adj.	203	21	FLV3060CDT42L		\$5,122	\$5,480



optional modesty panels

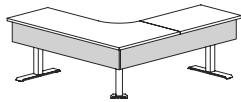
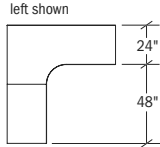
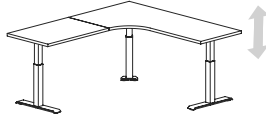
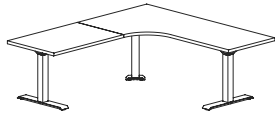
Features:

- eased edge profile on approach and user sides
- 22½" to 49" height adjustment
- maximum weight rating 140 lbs. (evenly distributed load)
- key pad features height display with three memory settings; key pad mounts left or right
- display will reference position to the nearest ½"
- 120" power cord

Options:

- specify Matte Black (MBK) or Arctic Silver (ASL) base finish
- reverse bevel edge available on desk approach side only, specify; add \$429 list for laminate or \$168 list for veneer; see page 8 for details
- top grommet available, specify location and add \$128 list each; see page 49 for details
- modesty panel available (2-sides) moves with worksurface, specify \$889 list for laminate or \$1,430 list for veneer; see page 21 for details
- undermount power available, specify and add \$946 list; power infeed sold separately, see page 224

Description	D	W	H	CTN WT	CU FT	① Model	HPL Laminate	Flat Cut Veneer	Double Cut Veneer
Adjustable Height Corner Table - 90° Two Piece Top	72	72	Adj.	232	21	FLT2472CDT48R	\$4,216		
	72	72	Adj.	232	21	FLV2472CDT48R		\$5,227	\$5,594
	72	72	Adj.	232	21	FLT2472CDT48L	\$4,216		
	72	72	Adj.	232	21	FLV2472CDT48L		\$5,227	\$5,594
	72	66	Adj.	225	20	FLT2466CDT48R	\$4,174		
	72	66	Adj.	225	20	FLV2466CDT48R		\$5,176	\$5,538
	72	66	Adj.	225	20	FLT2466CDT48L	\$4,174		
	72	66	Adj.	225	20	FLV2466CDT48L		\$5,176	\$5,538
	72	60	Adj.	219	18	FLT2460CDT48R	\$4,131		
	72	60	Adj.	219	18	FLV2460CDT48R		\$5,122	\$5,480
	72	60	Adj.	219	18	FLT2460CDT48L	\$4,131		
	72	60	Adj.	219	18	FLV2460CDT48L		\$5,122	\$5,480



optional modesty panels

Features:

- eased edge profile on approach and user sides
- 22½" to 49" height adjustment
- maximum weight rating 140 lbs. (evenly distributed load)
- key pad features height display with three memory settings; key pad mounts left or right
- display will reference position to the nearest ½"
- 120" power cord

Options:

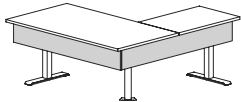
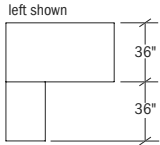
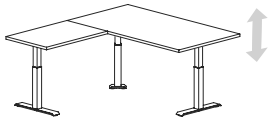
- specify Matte Black (MBK) or Arctic Silver (ASL) base finish
- reverse bevel edge available on desk approach side only, specify; add \$429 list for laminate or \$168 list for veneer; see page 8 for details
- top grommet available, specify location and add \$128 list each; see page 49 for details
- modesty panel available (2-sides) moves with worksurface, specify \$889 list for laminate or \$1,430 list for veneer; see page 21 for details
- undermount power available, specify and add \$946 list; power infeed sold separately, see page 224

To Order, Specify:

① Laminate Model #	② Laminate Type	③ Laminate Selection		④ Metal Color	⑤ Other Product Options
Laminate (FLT)	HPL	See Laminate Selection		See Metal Finish Color Options	See list of options for each specific unit; Specify and add accordingly.

① Veneer Model #	② Wood Species	③ Wood Finish		④ Metal Color	⑤ Other Product Options
Veneer (FLV)	Flat Cut CH1 Cherry MA1 Maple WA1 Walnut BO1 Black Oak	See Flat Cut Wood Finish Options		See Metal Finish Color Options	See list of options for each specific unit; Specify and add accordingly.
		③a Wood Finish	③b Chassis Grain Direction		
	Double Cut DC1 Double Cut	See Double Cut Wood Finish Options	For Double Cut Only: Vertical Horizontal		

Description	D	W	H	CTN WT	CU FT	① Model	HPL Laminate	Flat Cut Veneer	Double Cut Veneer
Adjustable Height Table & Return - 90° Two Piece Top	72	72	Adj.	253	20	FLT3672RTAH36R	\$3,396		
	72	72	Adj.	253	20	FLV3672RTAH36R		\$4,212	\$4,506
	72	72	Adj.	253	20	FLT3672RTAH36L	\$3,396		
	72	72	Adj.	253	20	FLV3672RTAH36L		\$4,212	\$4,506
	72	66	Adj.	248	19	FLT3666RTAH36R	\$3,357		
	72	66	Adj.	248	19	FLV3666RTAH36R		\$4,162	\$4,449
	72	66	Adj.	248	19	FLT3666RTAH36L	\$3,357		
	72	66	Adj.	248	19	FLV3666RTAH36L		\$4,162	\$4,449
	72	60	Adj.	239	17	FLT3660RTAH36R	\$3,318		
	72	60	Adj.	239	17	FLV3660RTAH36R		\$4,113	\$4,401
	72	60	Adj.	239	17	FLT3660RTAH36L	\$3,318		
	72	60	Adj.	239	17	FLV3660RTAH36L		\$4,113	\$4,401



optional modesty panels

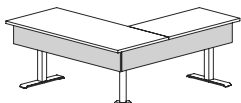
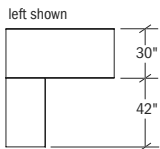
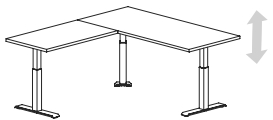
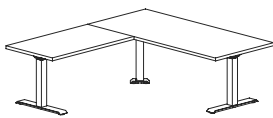
Features:

- eased edge profile on approach and user sides
- 22½" to 49" height adjustment
- maximum weight rating 140 lbs. (evenly distributed load)
- key pad features height display with three memory settings; key pad mounts left or right
- display will reference position to the nearest ½"
- 120" power cord

Options:

- specify Matte Black (MBK) or Arctic Silver (ASL) base finish
- reverse bevel edge available on desk approach side only, specify; add \$429 list for laminate or \$168 list for veneer; see page 8 for details
- top grommet available, specify location and add \$128 list each; see page 49 for details
- modesty panel available (2-sides) moves with worksurface, specify \$889 list for laminate or \$1,430 list for veneer; see page 21 for details
- undermount power available, specify and add \$946 list; power infeed sold separately, see page 224

Adjustable Height Table & Return - 90° Two Piece Top	72	72	Adj.	242	18	FLT3072RTAH42R	\$3,327		
	72	72	Adj.	242	18	FLV3072RTAH42R		\$4,127	\$4,416
	72	72	Adj.	242	18	FLT3072RTAH42L	\$3,327		
	72	72	Adj.	242	18	FLV3072RTAH42L		\$4,127	\$4,416
	72	66	Adj.	233	17	FLT3066RTAH42R	\$3,290		
	72	66	Adj.	233	17	FLV3066RTAH42R		\$4,079	\$4,364
	72	66	Adj.	233	17	FLT3066RTAH42L	\$3,290		
	72	66	Adj.	233	17	FLV3066RTAH42L		\$4,079	\$4,364
	72	60	Adj.	224	16	FLT3060RTAH42R	\$3,250		
	72	60	Adj.	224	16	FLV3060RTAH42R		\$4,031	\$4,312
	72	60	Adj.	224	16	FLT3060RTAH42L	\$3,250		
	72	60	Adj.	224	16	FLV3060RTAH42L		\$4,031	\$4,312



optional modesty panels

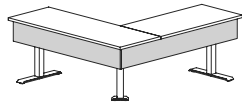
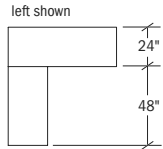
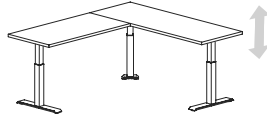
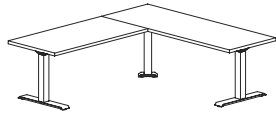
Features:

- eased edge profile on approach and user sides
- 22½" to 49" height adjustment
- maximum weight rating 140 lbs. (evenly distributed load)
- key pad features height display with three memory settings; key pad mounts left or right
- display will reference position to the nearest ½"
- 120" power cord

Options:

- specify Matte Black (MBK) or Arctic Silver (ASL) base finish
- reverse bevel edge available on desk approach side only, specify; add \$429 list for laminate or \$168 list for veneer; see page 8 for details
- top grommet available, specify location and add \$128 list each; see page 49 for details
- modesty panel available (2-sides) moves with worksurface, specify \$889 list for laminate or \$1,430 list for veneer; see page 21 for details
- undermount power available, specify and add \$946 list; power infeed sold separately, see page 224

Description	D	W	H	CTN WT	CU FT	1 Model	HPL Laminate	Flat Cut Veneer	Double Cut Veneer
Adjustable Height Table & Return - 90° Two Piece Top	72	72	Adj.	231	15	FLT2472RTAH48R	\$3,262		
	72	72	Adj.	231	15	FLV2472RTAH48R		\$4,044	\$4,328
	72	72	Adj.	231	15	FLT2472RTAH48L	\$3,262		
	72	72	Adj.	231	15	FLV2472RTAH48L		\$4,044	\$4,328
	72	66	Adj.	225	14	FLT2466RTAH48R	\$3,225		
	72	66	Adj.	225	14	FLV2466RTAH48R		\$3,997	\$4,277
	72	66	Adj.	225	14	FLT2466RTAH48L	\$3,225		
	72	66	Adj.	225	14	FLV2466RTAH48L		\$3,997	\$4,277
	72	60	Adj.	219	13	FLT2460RTAH48R	\$3,185		
	72	60	Adj.	219	13	FLV2460RTAH48R		\$3,948	\$4,224
	72	60	Adj.	219	13	FLT2460RTAH48L	\$3,185		
	72	60	Adj.	219	13	FLV2460RTAH48L		\$3,948	\$4,224



optional modesty panels

Features:

- eased edge profile on approach and user sides
- 22½" to 49" height adjustment
- maximum weight rating 140 lbs. (evenly distributed load)
- key pad features height display with three memory settings; key pad mounts left or right
- display will reference position to the nearest ½"
- 120" power cord

Options:

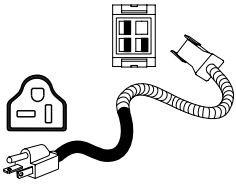
- specify Matte Black (MBK) or Arctic Silver (ASL) base finish
- reverse bevel edge available on desk approach side only, specify; add \$429 list for laminate or \$168 list for veneer; see page 8 for details
- top grommet available, specify location and add \$128 list each; see page 49 for details
- modesty panel available (2-sides) moves with worksurface, specify \$889 list for laminate or \$1,430 list for veneer; see page 21 for details
- undermount power available, specify and add \$946 list; power infeed sold separately, see page 224

To Order, Specify:

1 Laminate Model #	2 Laminate Type	3 Laminate Selection		4 Metal Color	5 Other Product Options
Laminate (FLT)	HPL	See Laminate Selection		See Metal Finish Color Options	See list of options for each specific unit; Specify and add accordingly.

1 Veneer Model #	2 Wood Species	3 Wood Finish		4 Metal Color	5 Other Product Options
Veneer (FLV)	Flat Cut CH1 Cherry MA1 Maple WA1 Walnut BO1 Black Oak	See Flat Cut Wood Finish Options		See Metal Finish Color Options	See list of options for each specific unit; Specify and add accordingly.
		3a Wood Finish	3b Chassis Grain Direction		
	Double Cut DC1 Double Cut	See Double Cut Wood Finish Options	For Double Cut Only: Vertical Horizontal		

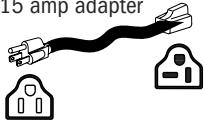
Description	D	W	H	CTN WT	CU FT	Model	List Price
3 Prong Plug - 110 Power Infeed for Link System	-	72	-	1	1	EC-PI-L-72-A	\$271



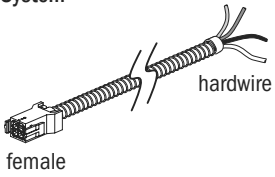
Features:

- 72" plug power infeed
- 20 amps/110 volts max
- 3 prong plug - 15 amp adapter plug
- single circuit use only
- use in conjunction with other link electrical items

plug included:
15 amp adapter

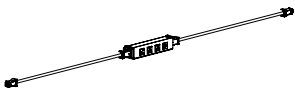

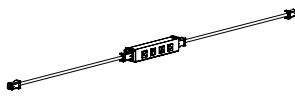

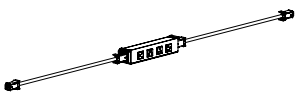
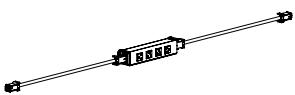


Hardwire Power Infeed for Link System	-	72	-	1	1	EC-PI-L-72-H	\$176
---------------------------------------	---	----	---	---	---	--------------	-------



Features:

- 72" hardwire power infeed
- 20 amps/120 volts max
- single or two circuit
- electrical contractor responsible for connection to building power source
- use in conjunction with other link electrical items

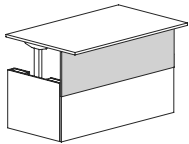
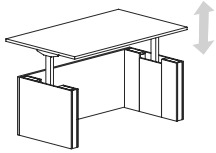
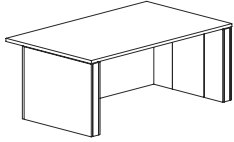
Description	D	W	H	CTN WT	CU FT	① Model	List Price
72" Power Link Kits - Circuit 1  <ul style="list-style-type: none"> · use with 72" tables · 72" plug power infeed · 20 amps/110 volts max · 3 prong plug - 15 amp adapter plug · Circuit 1 						ECAH-72UP-1	\$921
72" Power Link Kits - Circuit 2  <ul style="list-style-type: none"> · use with 72" tables · 72" plug power infeed · 20 amps/110 volts max · 3 prong plug - 15 amp adapter plug · Circuit 2 						ECAH-72UP-2	\$921
66" Power Link Kits - Circuit 1  <ul style="list-style-type: none"> · use with 66" tables · 72" plug power infeed · 20 amps/110 volts max · 3 prong plug - 15 amp adapter plug · Circuit 1 						ECAH-66UP-1	\$904
66" Power Link Kits - Circuit 2  <ul style="list-style-type: none"> · use with 66" tables · 72" plug power infeed · 20 amps/110 volts max · 3 prong plug - 15 amp adapter plug · Circuit 2 						ECAH-66UP-2	\$904
60" Power Link Kits - Circuit 1  <ul style="list-style-type: none"> · use with 60" tables · 72" plug power infeed · 20 amps/110 volts max · 3 prong plug - 15 amp adapter plug · Circuit 1 						ECAH-60UP-1	\$886
60" Power Link Kits - Circuit 2  <ul style="list-style-type: none"> · use with 60" tables · 72" plug power infeed · 20 amps/110 volts max · 3 prong plug - 15 amp adapter plug · Circuit 2 						ECAH-60UP-2	\$886

FLUX - PRIVATE OFFICE

To Order, Specify:

① Model Number	
----------------	--

Description	D	W	H	CTN WT	CU FT	① Model	HPL Laminate	Flat Cut Veneer	Double Cut Veneer
Adjustable Height Freestanding Desk Shell with Flush Modesty Panel	36	72	Adj.	305	51	FLT3672AHFDS	\$5,863		
	36	72	Adj.	305	51	FLV3672AHFDS		\$7,589	\$8,349
	36	66	Adj.	292	47	FLT3666AHFDS	\$5,826		
	36	66	Adj.	292	47	FLV3666AHFDS		\$7,539	\$8,292
	36	60	Adj.	279	43	FLT3660AHFDS	\$5,793		
	36	60	Adj.	279	43	FLV3660AHFDS		\$7,489	\$8,238



optional 20" modesty

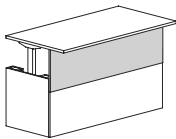
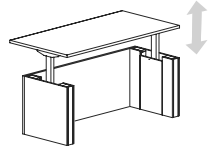
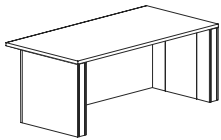
Features:

- eased edge profile on approach and user sides
- 29" to 47" height adjustment with digital controller, wire guide and 10' power cord
- maximum weight rating 140 lbs. (evenly distributed load)

Options:

- must specify chassis grain direction on double cut veneer, see pages 13-15 for details
- reverse bevel edge available on desk approach side only, specify; add \$429 list for laminate or \$168 list for veneer; see page 8 for details
- 20"h modesty panel available, moves with worksurface, specify \$427 list for laminate or \$594 list for veneer; see page 17 for details
- top grommet available, specify location; add \$128 list each; see page 49 for details

Adjustable Height Freestanding Desk Shell with Flush Modesty Panel	30	72	Adj.	283	43	FLT3072AHFDS	\$5,693		
	30	72	Adj.	283	43	FLV3072AHFDS		\$7,362	\$8,100
	30	66	Adj.	271	40	FLT3066AHFDS	\$5,662		
	30	66	Adj.	271	40	FLV3066AHFDS		\$7,317	\$8,049
	30	60	Adj.	259	36	FLT3060AHFDS	\$5,631		
	30	60	Adj.	259	36	FLV3060AHFDS		\$7,274	\$7,999



optional 20" modesty

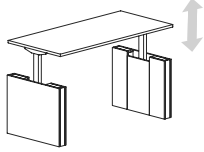
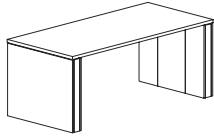
Features:

- eased edge profile on approach and user sides
- 29" to 47" height adjustment with digital controller, wire guide and 10' power cord
- maximum weight rating 140 lbs. (evenly distributed load)

Options:

- must specify chassis grain direction on double cut veneer, see pages 13-15 for details
- reverse bevel edge available on desk approach side only, specify; add \$429 list for laminate or \$168 list for veneer; see page 8 for details
- 20"h modesty panel available, moves with worksurface, specify \$427 list for laminate or \$594 list for veneer; see page 17 for details
- top grommet available, specify location; add \$128 list each; see page 47 for details

Description	D	W	H	CTN WT	CU FT	1 Model	HPL Laminate	Flat Cut Veneer	Double Cut Veneer
Adjustable Height Freestanding Table	33 1/2	72	Adj.	261	48	FLT3472AHFT	\$5,869		
	33 1/2	72	Adj.	261	48	FLV3472AHFT		\$7,604	\$8,362
	33 1/2	66	Adj.	253	44	FLT3466AHFT	\$5,834		
	33 1/2	66	Adj.	253	44	FLV3466AHFT		\$7,550	\$8,307
	33 1/2	60	Adj.	245	40	FLT3460AHFT	\$5,806		
	33 1/2	60	Adj.	245	40	FLV3460AHFT		\$7,501	\$8,252



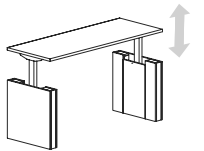
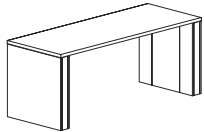
Features:

- eased edge profile on approach and user sides
- 29" to 47" height adjustment with digital controller, wire guide and 10' power cord
- maximum weight rating 140 lbs. (evenly distributed load)

Options:

- must specify chassis grain direction on double cut veneer, see pages 13-15 for details
- reverse bevel edge available on desk approach side only, specify; add \$429 list for laminate or \$168 list for veneer; see page 8 for details
- 13 1/2" h modesty panel available, moves with worksurface, specify \$427 list for laminate or \$594 list for veneer; see page 17 for details
- top grommet available, specify location; add \$128 list each; see page 47 for details

Adjustable Height Freestanding Table	27 1/2	72	Adj.	227	40	FLT2872AHFT	\$5,698		
	27 1/2	72	Adj.	227	40	FLV2872AHFT		\$7,374	\$8,112
	27 1/2	66	Adj.	220	37	FLT2866AHFT	\$5,667		
	27 1/2	66	Adj.	220	37	FLV2866AHFT		\$7,326	\$8,061
	27 1/2	60	Adj.	213	34	FLT2860AHFT	\$5,637		
	27 1/2	60	Adj.	213	34	FLV2860AHFT		\$7,283	\$8,013



Features:

- eased edge profile on approach and user sides
- 29" to 47" height adjustment with digital controller, wire guide and 10' power cord
- maximum weight rating 140 lbs. (evenly distributed load)

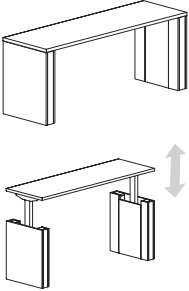
Options:

- must specify chassis grain direction on double cut veneer, see pages 13-15 for details
- reverse bevel edge available on desk approach side only, specify; add \$429 list for laminate or \$168 list for veneer; see page 8 for details
- 13 1/2" h modesty panel available, moves with worksurface, specify \$427 list for laminate or \$594 list for veneer; see page 17 for details
- top grommet available, specify location; add \$128 list each; see page 47 for details

To Order, Specify:

1 Laminate Model #	2 Laminate Type	3 Laminate Selection	4 Metal Color	5 Other Product Options
Laminate (FLT)	HPL	See Laminate Selection	See Metal Finish Color Options	See list of options for each specific unit; Specify and add accordingly.

1 Veneer Model #	2 Wood Species	3 Wood Finish	4 Metal Color	5 Other Product Options
Veneer (FLV)	Flat Cut CH1 Cherry MA1 Maple WA1 Walnut BO1 Black Oak	See Flat Cut Wood Finish Options	See Metal Finish Color Options	See list of options for each specific unit; Specify and add accordingly.
		<table border="1"> <thead> <tr> <th>3a Wood Finish</th> <th>3b Chassis Grain Direction</th> </tr> </thead> <tbody> <tr> <td>See Double Cut Wood Finish Options</td> <td>For Double Cut Only: Vertical Horizontal</td> </tr> </tbody> </table>		
3a Wood Finish	3b Chassis Grain Direction			
See Double Cut Wood Finish Options	For Double Cut Only: Vertical Horizontal			

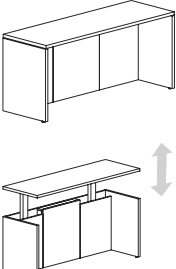
Description	D	W	H	CTN WT	CU FT	① Model	HPL Laminate	Flat Cut Veneer	Double Cut Veneer
Adjustable Height Credenza Shell 	22	72	Adj.	251	32	FLT2272-29FAHC	\$5,693		
	22	72	Adj.	251	32	FLV2272-29FAHC		\$7,362	\$8,100
	22	66	Adj.	243	30	FLT2266-29FAHC	\$5,662		
	22	66	Adj.	243	30	FLV2266-29FAHC		\$7,317	\$8,049
	22	60	Adj.	233	27	FLT2260-29FAHC	\$5,631		
	22	60	Adj.	233	27	FLV2260-29FAHC		\$7,274	\$7,999
	22	54	Adj.	222	25	FLT2254-29FAHC	\$5,603		
	22	54	Adj.	222	25	FLV2254-29FAHC		\$7,231	\$7,953
	22	48	Adj.	205	22	FLT2248-29FAHC	\$5,577		
	22	48	Adj.	205	22	FLV2248-29FAHC		\$7,189	\$7,908

Features:

- use to expand work station
- eased edge profile user side
- 29" to 47" height adjustment with digital controller, wire guide and 10' power cord

Options:

- must specify chassis grain direction on double cut veneer, see pages 13-15 for details
- top grommet available, specify location; add \$128 list each; see page 48 for details

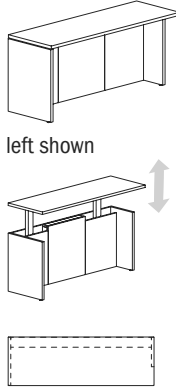
Adjustable Height Credenza Extension 	22	72	Adj.	261	32	FLT2272-29FAHCE	\$4,809		
	22	72	Adj.	261	32	FLV2272-29FAHCE		\$5,995	\$6,593
	22	66	Adj.	249	30	FLT2266-29FAHCE	\$4,778		
	22	66	Adj.	249	30	FLV2266-29FAHCE		\$5,953	\$6,547
	22	60	Adj.	242	27	FLT2260-29FAHCE	\$4,751		
	22	60	Adj.	242	27	FLV2260-29FAHCE		\$5,914	\$6,503
	22	54	Adj.	232	25	FLT2254-29FAHCE	\$4,723		
	22	54	Adj.	232	25	FLV2254-29FAHCE		\$5,872	\$6,459
	22	48	Adj.	226	22	FLT2248-29FAHCE	\$4,696		
	22	48	Adj.	226	22	FLV2248-29FAHCE		\$5,832	\$6,416

Features:

- use to expand work station
- eased edge profile user side
- 29" to 47" height adjustment with digital controller, wire guide and 10' power cord

Options:

- must specify chassis grain direction on double cut veneer, see pages 13-15 for details
- top grommet available, specify location; add \$128 list each; see page 48 for details
- wall access cutouts available, specify and add \$231 list

Description	D	W	H	CTN WT	CU FT	① Model	HPL Laminate	Flat Cut Veneer	Double Cut Veneer
Adjustable Height Return Shell 	22	72	Adj.	220	33	FLT2272-29FAHRR	\$4,809		
	22	72	Adj.	220	33	FLV2272-29FAHRR		\$5,995	\$6,593
	22	72	Adj.	220	33	FLT2272-29FAHRL	\$4,809		
	22	72	Adj.	220	33	FLV2272-29FAHRL		\$5,995	\$6,593
	22	66	Adj.	208	30	FLT2266-29FAHRR	\$4,778		
	22	66	Adj.	208	30	FLV2266-29FAHRR		\$5,953	\$6,547
	22	66	Adj.	208	30	FLT2266-29FAHRL	\$4,778		
	22	66	Adj.	208	30	FLV2266-29FAHRL		\$5,953	\$6,547
	22	60	Adj.	196	27	FLT2260-29FAHRR	\$4,751		
	22	60	Adj.	196	27	FLV2260-29FAHRR		\$5,914	\$6,503
	22	60	Adj.	196	27	FLT2260-29FAHRL	\$4,751		
	22	60	Adj.	196	27	FLV2260-29FAHRL		\$5,914	\$6,503
	22	54	Adj.	184	25	FLT2254-29FAHRR	\$4,723		
	22	54	Adj.	184	25	FLV2254-29FAHRR		\$5,872	\$6,459
	22	54	Adj.	184	25	FLT2254-29FAHRL	\$4,723		
	22	54	Adj.	184	25	FLV2254-29FAHRL		\$5,872	\$6,459
	22	48	Adj.	172	22	FLT2248-29FAHRR	\$4,696		
	22	48	Adj.	172	22	FLV2248-29FAHRR		\$5,832	\$6,416
	22	48	Adj.	172	22	FLT2248-29FAHRL	\$4,696		
	22	48	Adj.	172	22	FLV2248-29FAHRL		\$5,832	\$6,416

Features:

- must be used with desk
- laminate tops wider than 60" are long grain
- 29" to 47" height adjustment with digital controller, wire guide and 10' power cord
- maximum weight rating 100 lbs. (evenly distributed load)

Options:

- must specify chassis grain direction on double cut veneer, see pages 13-15 for details
- top grommet available, specify location; add \$128 list each; see page 48 for details
- wall access cutouts available, specify and add \$231 list

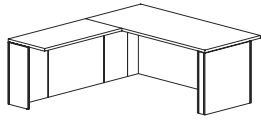
To Order, Specify:

① Laminate Model #	② Laminate Type	③ Laminate Selection		④ Metal Color	⑤ Other Product Options
Laminate (FLT)	HPL	See Laminate Selection		See Metal Finish Color Options	See list of options for each specific unit; Specify and add accordingly.

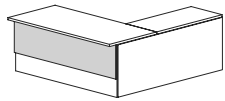
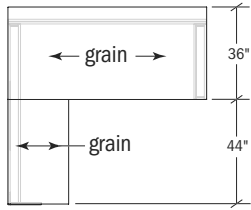
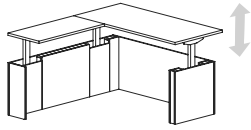
① Veneer Model #	② Wood Species	③ Wood Finish		④ Metal Color	⑤ Other Product Options
Veneer (FLV)	Flat Cut CH1 Cherry MA1 Maple WA1 Walnut BO1 Black Oak	See Flat Cut Wood Finish Options		See Metal Finish Color Options	See list of options for each specific unit; Specify and add accordingly.
		ⓐ Wood Finish	ⓑ Chassis Grain Direction		
	Double Cut DC1 Double Cut	See Double Cut Wood Finish Options	For Double Cut Only: Vertical Horizontal		

FLUX - PRIVATE OFFICE

Description	D	W	H	CTN WT	CU FT	① Model	HPL Laminate	Flat Cut Veneer	Double Cut Veneer
Adjustable Height U-Configuration Desk and Bridge	80	72	Adj.	470	110	FLT3672-U44AHR	\$8,534		
	80	72	Adj.	470	110	FLV3672-U44AHR		\$10,874	\$11,960
	80	72	Adj.	470	110	FLT3672-U44AHL	\$8,534		
	80	72	Adj.	470	110	FLV3672-U44AHL		\$10,874	\$11,960
	80	66	Adj.	433	101	FLT3666-U44AHR	\$8,431		
	80	66	Adj.	433	101	FLV3666-U44AHR		\$10,726	\$11,798
	80	66	Adj.	433	101	FLT3666-U44AHL	\$8,431		
	80	66	Adj.	433	101	FLV3666-U44AHL		\$10,726	\$11,798
	80	60	Adj.	419	92	FLT3660-U44AHR	\$8,331		
	80	60	Adj.	419	92	FLV3660-U44AHR		\$10,581	\$11,641
	80	60	Adj.	419	92	FLT3660-U44AHL	\$8,331		
	80	60	Adj.	419	92	FLV3660-U44AHL		\$10,581	\$11,641



left shown



20"h optional modesty

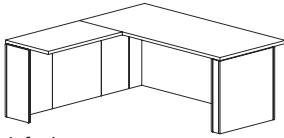
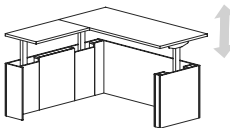
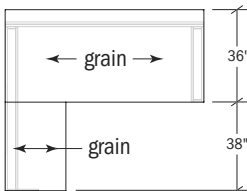
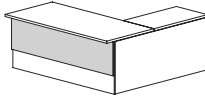
Features:

- must attach to open corner credenza
- eased edge profile on approach and user sides
- 29" to 47" height adjustment with digital controller, wire guide and 10' power cord
- maximum weight rating 210 lbs. (evenly distributed load)

Options:

- must specify chassis grain direction on double cut veneer, see pages 13-15 for details
- reverse bevel edge available on desk approach side only, specify; add \$429 list for laminate or \$168 list for veneer; see page 8 for details
- 20"h modesty panel available, moves with worksurface, specify \$427 list for laminate or \$594 list for veneer; see page 17 for details
- top grommet available, specify location; add \$128 list each; see page 49 for details
- wall access cutouts available, specify and add \$231 list

FLUX - PRIVATE OFFICE

Description	D	W	H	CTN WT	CU FT	① Model	HPL Laminate	Flat Cut Veneer	Double Cut Veneer
Adjustable Height U-Configuration Desk and Bridge  left shown    20" h optional modesty	74	72	Adj.	452	102	FLT3672-U38AHR	\$8,503		
	74	72	Adj.	452	102	FLV3672-U38AHR		\$10,827	\$11,910
	74	72	Adj.	452	102	FLT3672-U38AHL	\$8,503		
	74	72	Adj.	452	102	FLV3672-U38AHL		\$10,827	\$11,910
	74	66	Adj.	415	94	FLT3666-U38AHR	\$8,399		
	74	66	Adj.	415	94	FLV3666-U38AHR		\$10,679	\$11,749
	74	66	Adj.	415	94	FLT3666-U38AHL	\$8,399		
	74	66	Adj.	415	94	FLV3666-U38AHL		\$10,679	\$11,749
	74	60	Adj.	401	86	FLT3660-U38AHR	\$8,297		
	74	60	Adj.	401	86	FLV3660-U38AHR		\$10,535	\$11,588
	74	60	Adj.	401	86	FLT3660-U38AHL	\$8,297		
	74	60	Adj.	401	86	FLV3660-U38AHL		\$10,535	\$11,588

Features:

- must attach to open corner credenza
- eased edge profile on approach and user sides
- 29" to 47" height adjustment with digital controller, wire guide and 10' power cord
- maximum weight rating 210 lbs. (evenly distributed load)

Options:

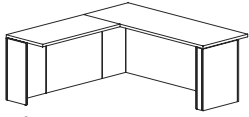
- must specify chassis grain direction on double cut veneer, see pages 13-15 for details
- reverse bevel edge available on desk approach side only, specify; add \$429 list for laminate or \$168 list for veneer; see page 8 for details
- 20" h modesty panel available, moves with worksurface, specify \$427 list for laminate or \$594 list for veneer; see page 17 for details
- top grommet available, specify location; add \$128 list each; see page 49 for details
- wall access cutouts available, specify and add \$231 list

To Order, Specify:

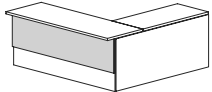
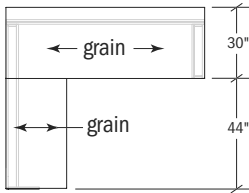
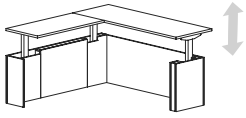
① Laminate Model #	② Laminate Type	③ Laminate Selection	④ Metal Color	⑤ Other Product Options
Laminate (FLT)	HPL	See Laminate Selection	See Metal Finish Color Options	See list of options for each specific unit; Specify and add accordingly.

① Veneer Model #	② Wood Species	③ Wood Finish	④ Metal Color	⑤ Other Product Options
Veneer (FLV)	Flat Cut CH1 Cherry MA1 Maple WA1 Walnut BO1 Black Oak	See Flat Cut Wood Finish Options	See Metal Finish Color Options	See list of options for each specific unit; Specify and add accordingly.
		<table border="1"> <thead> <tr> <th>ⓐ Wood Finish</th> <th>ⓑ Chassis Grain Direction</th> </tr> </thead> <tbody> <tr> <td>See Double Cut Wood Finish Options</td> <td>For Double Cut Only: Vertical Horizontal</td> </tr> </tbody> </table>		
ⓐ Wood Finish	ⓑ Chassis Grain Direction			
See Double Cut Wood Finish Options	For Double Cut Only: Vertical Horizontal			

Description	D	W	H	CTN WT	CU FT	① Model	HPL Laminate	Flat Cut Veneer	Double Cut Veneer
Adjustable Height U-Configuration Desk and Bridge	74	72	Adj.	433	102	FLT3072-U44AHR	\$8,290		
	74	72	Adj.	433	102	FLV3072-U44AHR		\$10,593	\$11,651
	74	72	Adj.	433	102	FLT3072-U44AHL	\$8,290		
	74	72	Adj.	433	102	FLV3072-U44AHL		\$10,593	\$11,651
	74	66	Adj.	396	94	FLT3066-U44AHR	\$8,188		
	74	66	Adj.	396	94	FLV3066-U44AHR		\$10,446	\$11,490
	74	66	Adj.	396	94	FLT3066-U44AHL	\$8,188		
	74	66	Adj.	396	94	FLV3066-U44AHL		\$10,446	\$11,490
	74	60	Adj.	382	86	FLT3060-U44AHR	\$8,088		
	74	60	Adj.	382	86	FLV3060-U44AHR		\$10,299	\$11,330
	74	60	Adj.	382	86	FLT3060-U44AHL	\$8,088		
	74	60	Adj.	382	86	FLV3060-U44AHL		\$10,299	\$11,330



left shown



20" optional modesty

Features:

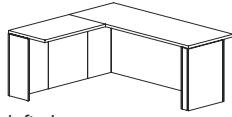
- must attach to open corner credenza
- eased edge profile on approach and user sides
- 29" to 47" height adjustment with digital controller, wire guide and 10' power cord
- maximum weight rating 210 lbs. (evenly distributed load)

Options:

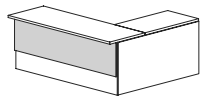
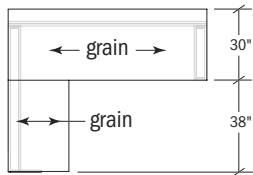
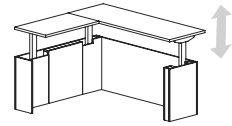
- must specify chassis grain direction on double cut veneer, see pages 13-15 for details
- reverse bevel edge available on desk approach side only, specify; add \$429 list for laminate or \$168 list for veneer; see page 8 for details
- 20" h modesty panel available, moves with worksurface, specify \$427 list for laminate or \$594 list for veneer; see page 17 for details
- top grommet available, specify location; add \$128 list each; see page 49 for details
- wall access cutouts available, specify and add \$231 list

FLUX - PRIVATE OFFICE

Description	D	W	H	CTN WT	CU FT	① Model	HPL Laminate	Flat Cut Veneer	Double Cut Veneer
Adjustable Height U-Configuration Desk and Bridge	68	72	Adj.	415	94	FLT3072-U38AHR	\$8,260		
	68	72	Adj.	415	94	FLV3072-U38AHR		\$10,545	\$11,600
	68	72	Adj.	415	94	FLT3072-U38AHL	\$8,260		
	68	72	Adj.	415	94	FLV3072-U38AHL		\$10,545	\$11,600
	68	66	Adj.	378	87	FLT3066-U38AHR	\$8,157		
	68	66	Adj.	378	87	FLV3066-U38AHR		\$10,400	\$11,438
	68	66	Adj.	378	87	FLT3066-U38AHL	\$8,157		
	68	66	Adj.	378	87	FLV3066-U38AHL		\$10,400	\$11,438
	68	60	Adj.	364	79	FLT3060-U38AHR	\$8,055		
	68	60	Adj.	364	79	FLV3060-U38AHR		\$10,254	\$11,277
	68	60	Adj.	364	79	FLT3060-U38AHL	\$8,055		
	68	60	Adj.	364	79	FLV3060-U38AHL		\$10,254	\$11,277



left shown



20" h optional modesty

Features:

- must attach to open corner credenza
- eased edge profile on approach and user sides
- 29" to 47" height adjustment with digital controller, wire guide and 10' power cord
- maximum weight rating 210 lbs. (evenly distributed load)

Options:

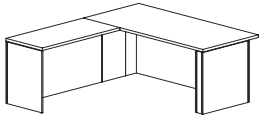
- must specify chassis grain direction on double cut veneer, see pages 13-15 for details
- reverse bevel edge available on desk approach side only, specify; add \$429 list for laminate or \$168 list for veneer; see page 8 for details
- 20" h modesty panel available, moves with worksurface, specify \$427 list for laminate or \$594 list for veneer; see page 17 for details
- top grommet available, specify location; add \$128 list each; see page 49 for details
- wall access cutouts available, specify and add \$231 list

To Order, Specify:

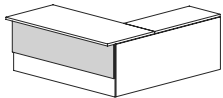
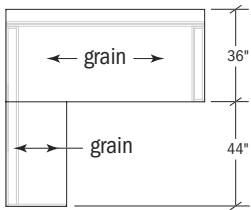
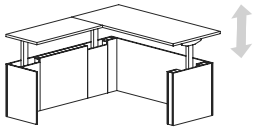
① Laminate Model #	② Laminate Type	③ Laminate Selection	④ Metal Color	⑤ Other Product Options
Laminate (FLT)	HPL	See Laminate Selection	See Metal Finish Color Options	See list of options for each specific unit; Specify and add accordingly.

① Veneer Model #	② Wood Species	③ Wood Finish	④ Metal Color	⑤ Other Product Options
Veneer (FLV)	Flat Cut CH1 Cherry MA1 Maple WA1 Walnut BO1 Black Oak	See Flat Cut Wood Finish Options	See Metal Finish Color Options	See list of options for each specific unit; Specify and add accordingly.
		③a Wood Finish See Double Cut Wood Finish Options		

Description	D	W	H	CTN WT	CU FT	① Model	HPL Laminate	Flat Cut Veneer	Double Cut Veneer
Adjustable Height L-Configuration Desk and Return	80	72	Adj.	481	110	FLT3672-L44AHR	\$8,534		
	80	72	Adj.	481	110	FLV3672-L44AHR		\$10,874	\$11,960
	80	72	Adj.	481	110	FLT3672-L44AHL	\$8,534		
	80	72	Adj.	481	110	FLV3672-L44AHL		\$10,874	\$11,960
	80	66	Adj.	444	101	FLT3666-L44AHR	\$8,431		
	80	66	Adj.	444	101	FLV3666-L44AHR		\$10,726	\$11,798
	80	66	Adj.	444	101	FLT3666-L44AHL	\$8,431		
	80	66	Adj.	444	101	FLV3666-L44AHL		\$10,726	\$11,798
	80	60	Adj.	430	92	FLT3660-L44AHR	\$8,331		
	80	60	Adj.	430	92	FLV3660-L44AHR		\$10,581	\$11,641
	80	60	Adj.	430	92	FLT3660-L44AHL	\$8,331		
	80	60	Adj.	430	92	FLV3660-L44AHL		\$10,581	\$11,641



left shown



20"h optional modesty

Features:

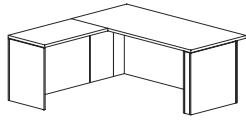
- eased edge profile on approach and user sides
- 29" to 47" height adjustment with digital controller, wire guide and 10' power cord
- maximum weight rating 210 lbs. (evenly distributed load)

Options:

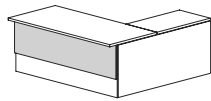
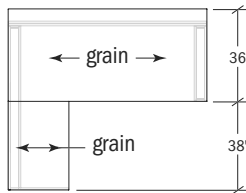
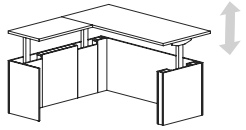
- must specify chassis grain direction on double cut veneer, see pages 13-15 for details
- reverse bevel edge available on desk approach side only, specify; add \$429 list for laminate or \$168 list for veneer; see page 8 for details
- 20"h modesty panel available, moves with worksurface, specify \$427 list for laminate or \$594 list for veneer; see page 17 for details
- top grommet available, specify location; add \$128 list each; see page 49 for details
- wall access cutouts available, specify and add \$231 list

FLUX - PRIVATE OFFICE

Description	D	W	H	CTN WT	CU FT	① Model	HPL Laminate	Flat Cut Veneer	Double Cut Veneer
Adjustable Height L-Configuration Desk and Return	74	72	Adj.	463	102	FLT3672-L38AHR	\$8,503		
	74	72	Adj.	463	102	FLV3672-L38AHR		\$10,827	\$11,910
	74	72	Adj.	463	102	FLT3672-L38AHL	\$8,503		
	74	72	Adj.	463	102	FLV3672-L38AHL		\$10,827	\$11,910
	74	66	Adj.	426	94	FLT3666-L38AHR	\$8,399		
	74	66	Adj.	426	94	FLV3666-L38AHR		\$10,679	\$11,749
	74	66	Adj.	426	94	FLT3666-L38AHL	\$8,399		
	74	66	Adj.	426	94	FLV3666-L38AHL		\$10,679	\$11,749
	74	60	Adj.	412	86	FLT3660-L38AHR	\$8,297		
	74	60	Adj.	412	86	FLV3660-L38AHR		\$10,535	\$11,588
	74	60	Adj.	412	86	FLT3660-L38AHL	\$8,297		
	74	60	Adj.	412	86	FLV3660-L38AHL		\$10,535	\$11,588



left shown



20" h optional modesty

Features:

- eased edge profile on approach and user sides
- 29" to 47" height adjustment with digital controller, wire guide and 10' power cord
- maximum weight rating 210 lbs. (evenly distributed load)

Options:

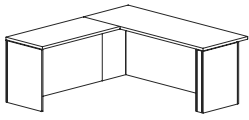
- must specify chassis grain direction on double cut veneer, see pages 13-15 for details
- reverse bevel edge available on desk approach side only, specify; add \$429 list for laminate or \$168 list for veneer; see page 8 for details
- 20" h modesty panel available, moves with worksurface, specify \$427 list for laminate or \$594 list for veneer; see page 17 for details
- top grommet available, specify location; add \$128 list each; see page 49 for details
- wall access cutouts available, specify and add \$231 list

To Order, Specify:

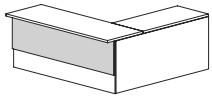
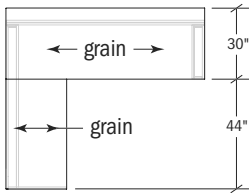
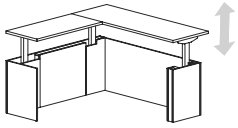
① Laminate Model #	② Laminate Type	③ Laminate Selection		④ Metal Color	⑤ Other Product Options
Laminate (FLT)	HPL	See Laminate Selection		See Metal Finish Color Options	See list of options for each specific unit; Specify and add accordingly.

① Veneer Model #	② Wood Species	③ Wood Finish		④ Metal Color	⑤ Other Product Options
Veneer (FLV)	Flat Cut CH1 Cherry MA1 Maple WA1 Walnut BO1 Black Oak	See Flat Cut Wood Finish Options		See Metal Finish Color Options	See list of options for each specific unit; Specify and add accordingly.
		③a Wood Finish	③b Chassis Grain Direction		
	Double Cut DC1 Double Cut	See Double Cut Wood Finish Options	For Double Cut Only: Vertical Horizontal		

Description	D	W	H	CTN WT	CU FT	① Model	HPL Laminate	Flat Cut Veneer	Double Cut Veneer
Adjustable Height L-Configuration Desk and Return	74	72	Adj.	444	102	FLT3072-L44AHR	\$8,290		
	74	72	Adj.	444	102	FLV3072-L44AHR		\$10,593	\$11,651
	74	72	Adj.	444	102	FLT3072-L44AHL	\$8,290		
	74	72	Adj.	444	102	FLV3072-L44AHL		\$10,593	\$11,651
	74	66	Adj.	407	94	FLT3066-L44AHR	\$8,188		
	74	66	Adj.	407	94	FLV3066-L44AHR		\$10,446	\$11,490
	74	66	Adj.	407	94	FLT3066-L44AHL	\$8,188		
	74	66	Adj.	407	94	FLV3066-L44AHL		\$10,446	\$11,490
	74	60	Adj.	393	86	FLT3060-L44AHR	\$8,088		
	74	60	Adj.	393	86	FLV3060-L44AHR		\$10,299	\$11,330
	74	60	Adj.	393	86	FLT3060-L44AHL	\$8,088		
	74	60	Adj.	393	86	FLV3060-L44AHL		\$10,299	\$11,330



left shown



20"h optional modesty

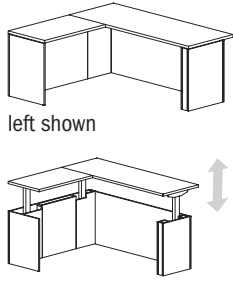
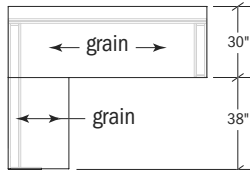
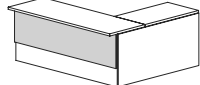
Features:

- eased edge profile on approach and user sides
- 29" to 47" height adjustment with digital controller, wire guide and 10' power cord
- maximum weight rating 210 lbs. (evenly distributed load)

Options:

- must specify chassis grain direction on double cut veneer, see pages 13-15 for details
- reverse bevel edge available on desk approach side only, specify; add \$429 list for laminate or \$168 list for veneer; see page 8 for details
- 20"h modesty panel available, moves with worksurface, specify \$427 list for laminate or \$594 list for veneer; see page 17 for details
- top grommet available, specify location; add \$128 list each; see page 49 for details
- wall access cutouts available, specify and add \$231 list

FLUX - PRIVATE OFFICE

Description	D	W	H	CTN WT	CU FT	① Model	HPL Laminate	Flat Cut Veneer	Double Cut Veneer
Adjustable Height L-Configuration Desk and Return left shown    20"h optional modesty	68	72	Adj.	426	94	FLT3072-L38AHR	\$8,260		
	68	72	Adj.	426	94	FLV3072-L38AHR		\$10,545	\$11,600
	68	72	Adj.	426	94	FLT3072-L38AHL	\$8,260		
	68	72	Adj.	426	94	FLV3072-L38AHL		\$10,545	\$11,600
	68	66	Adj.	389	87	FLT3066-L38AHR	\$8,157		
	68	66	Adj.	389	87	FLV3066-L38AHR		\$10,400	\$11,438
	68	66	Adj.	389	87	FLT3066-L38AHL	\$8,157		
	68	66	Adj.	389	87	FLV3066-L38AHL		\$10,400	\$11,438
	68	60	Adj.	375	79	FLT3060-L38AHR	\$8,055		
	68	60	Adj.	375	79	FLV3060-L38AHR		\$10,254	\$11,277
	68	60	Adj.	375	79	FLT3060-L38AHL	\$8,055		
	68	60	Adj.	375	79	FLV3060-L38AHL		\$10,254	\$11,277

Features:

- eased edge profile on approach and user sides
- 29" to 47" height adjustment with digital controller, wire guide and 10' power cord
- maximum weight rating 210 lbs. (evenly distributed load)

Options:

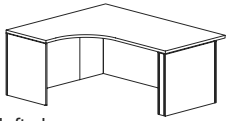
- must specify chassis grain direction on double cut veneer, see pages 13-15 for details
- reverse bevel edge available on desk approach side only, specify; add \$429 list for laminate or \$168 list for veneer; see page 8 for details
- 20"h modesty panel available, moves with worksurface, specify \$427 list for laminate or \$594 list for veneer; see page 17 for details
- top grommet available, specify location; add \$128 list each; see page 49 for details
- wall access cutouts available, specify and add \$231 list

To Order, Specify:

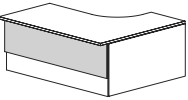
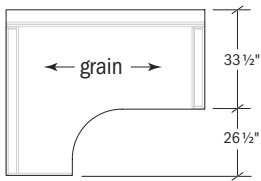
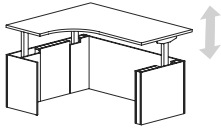
① Laminate Model #	② Laminate Type	③ Laminate Selection		④ Metal Color	⑤ Other Product Options
Laminate (FLT)	HPL	See Laminate Selection		See Metal Finish Color Options	See list of options for each specific unit; Specify and add accordingly.

① Veneer Model #	② Wood Species	③ Wood Finish		④ Metal Color	⑤ Other Product Options
Veneer (FLV)	Flat Cut CH1 Cherry MA1 Maple WA1 Walnut BO1 Black Oak	See Flat Cut Wood Finish Options		See Metal Finish Color Options	See list of options for each specific unit; Specify and add accordingly.
		③a Wood Finish	③b Chassis Grain Direction		
	Double Cut DC1 Double Cut	See Double Cut Wood Finish Options	For Double Cut Only: Vertical Horizontal		

Description	D	W	H	CTN WT	CU FT	① Model	HPL Laminate	Flat Cut Veneer	Double Cut Veneer
Adjustable Height L-Configuration Desk and Return with One Piece Top	60	72	Adj.	449	83	FLT3672-C24AHR	\$8,480		
	60	72	Adj.	449	83	FLV3672-C24AHR		\$10,796	\$11,877
	60	72	Adj.	449	83	FLT3672-C24AHL	\$8,480		
	60	72	Adj.	449	83	FLV3672-C24AHL		\$10,796	\$11,877
	60	66	Adj.	412	77	FLT3666-C24AHR	\$8,377		
	60	66	Adj.	412	77	FLV3666-C24AHR		\$10,649	\$11,714
	60	66	Adj.	412	77	FLT3666-C24AHL	\$8,377		
	60	66	Adj.	412	77	FLV3666-C24AHL		\$10,649	\$11,714
	60	60	Adj.	398	70	FLT3660-C24AHR	\$8,278		
	60	60	Adj.	398	70	FLV3660-C24AHR		\$10,503	\$11,555
	60	60	Adj.	398	70	FLT3660-C24AHL	\$8,278		
	60	60	Adj.	398	70	FLV3660-C24AHL		\$10,503	\$11,555



left shown



20"h optional modesty

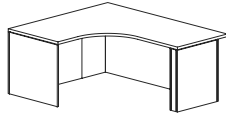
Features:

- eased edge profile on approach and user sides
- 29" to 47" height adjustment with digital controller, wire guide and 10' power cord
- maximum weight rating 210 lbs. (evenly distributed load)

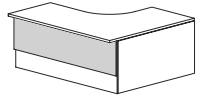
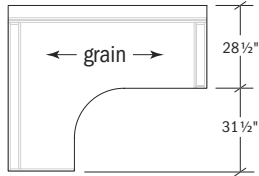
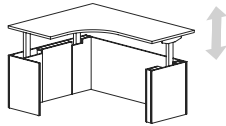
Options:

- must specify chassis grain direction on double cut veneer, see pages 13-15 for details
- reverse bevel edge available on desk approach side only, specify; add \$429 list for laminate or \$168 list for veneer; see page 8 for details
- 20"h modesty panel available, moves with worksurface, specify \$427 list for laminate or \$594 list for veneer; see page 17 for details
- top grommet available, specify location; add \$128 list each; see page 49 for details
- wall access cutouts available, specify and add \$231 list

Description	D	W	H	CTN WT	CU FT	① Model	HPL Laminate	Flat Cut Veneer	Double Cut Veneer
Adjustable Height L-Configuration Desk and Return with One Piece Top	60	72	Adj.	412	83	FLT3072-C30AHR	\$8,268		
	60	72	Adj.	412	83	FLV3072-C30AHR		\$10,561	\$11,618
	60	72	Adj.	412	83	FLT3072-C30AHL	\$8,268		
	60	72	Adj.	412	83	FLV3072-C30AHL		\$10,561	\$11,618
	60	66	Adj.	375	77	FLT3066-C30AHR	\$8,165		
	60	66	Adj.	375	77	FLV3066-C30AHR		\$10,413	\$11,456
	60	66	Adj.	375	77	FLT3066-C30AHL	\$8,165		
	60	66	Adj.	375	77	FLV3066-C30AHL		\$10,413	\$11,456
	60	60	Adj.	361	70	FLT3060-C30AHR	\$8,066		
	60	60	Adj.	361	70	FLV3060-C30AHR		\$10,269	\$11,297
	60	60	Adj.	361	70	FLT3060-C30AHL	\$8,066		
	60	60	Adj.	361	70	FLV3060-C30AHL		\$10,269	\$11,297



left shown



20" h optional modesty

Features:

- eased edge profile on approach and user sides
- 29" to 47" height adjustment with digital controller, wire guide and 10' power cord
- maximum weight rating 210 lbs. (evenly distributed load)

Options:

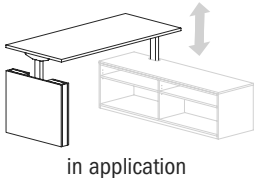
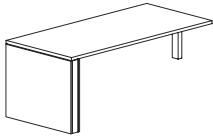
- must specify chassis grain direction on double cut veneer, see pages 13-15 for details
- reverse bevel edge available on desk approach side only, specify; add \$429 list for laminate or \$168 list for veneer; see page 8 for details
- 20" h modesty panel available, moves with worksurface, specify \$427 list for laminate or \$594 list for veneer; see page 17 for details
- top grommet available, specify location; add \$128 list each; see page 49 for details
- wall access cutouts available, specify and add \$231 list

To Order, Specify:

① Laminate Model #	② Laminate Type	③ Laminate Selection	④ Metal Color	⑤ Other Product Options
Laminate (FLT)	HPL	See Laminate Selection	See Metal Finish Color Options	See list of options for each specific unit; Specify and add accordingly.

① Veneer Model #	② Wood Species	③ Wood Finish	④ Metal Color	⑤ Other Product Options
Veneer (FLV)	Flat Cut CH1 Cherry MA1 Maple WA1 Walnut BO1 Black Oak	See Flat Cut Wood Finish Options	See Metal Finish Color Options	See list of options for each specific unit; Specify and add accordingly.
		③a Wood Finish See Double Cut Wood Finish Options		

Description	D	W	H	CTN WT	CU FT	① Model	HPL Laminate	Flat Cut Veneer	Double Cut Veneer
33" Adjustable Height Modular Peninsula Desk	33½	72	Adj.	205	26	FLT3472PAHD	\$4,732		
	33½	72	Adj.	205	26	FLV3472PAHD		\$5,916	\$6,505
	33½	66	Adj.	198	25	FLT3466PAHD	\$4,707		
	33½	66	Adj.	198	25	FLV3466PAHD		\$5,877	\$6,465
	33½	60	Adj.	191	24	FLT3460PAHD	\$4,683		
	33½	60	Adj.	191	24	FLV3460PAHD		\$5,843	\$6,425



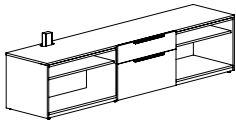
Features:

- must be used with 96", 72" and 36" wide secondary height peninsula mount credenzas
- 29" to 47" height adjustment with digital controller, wire guide and 10' power cord
- maximum weight rating 140 lbs. (evenly distributed load)

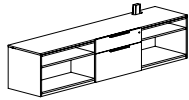
Options:

- must specify support panels grain direction on double cut veneer, see pages 13-15 for details
- reverse bevel edge available on approach and user sides, specify; add \$429 list for laminate or \$168 list for veneer; see page 8 for details
- 13 ½" h modesty panel available, specify; add \$427 list for laminate or \$594 list for veneer; see page 21 for details
- top grommet available, specify location; add \$128 list each; see page 49 for details
- worksurface power available, specify "to accommodate EC26" on your purchase order; EC26 unit must be ordered separately, see page 49

Box/Lateral File Storage Credenza with Peninsula Desk Mount	22	96	21	306	32	FLT2296-21FM60	\$2,920		
	22	96	21	306	32	FLV2296-21FM60		\$3,913	\$4,302
	22	96	21	306	32	FLT2296-21F06M	\$2,920		
	22	96	21	306	32	FLV2296-21F06M		\$3,913	\$4,302



*M60 shown



*O6M

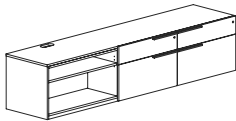
Features:

- must be used with 33" deep adjustable height modular peninsula desk
- desk lift column can only be mounted in sections with an open compartment, see page 39 for details
- open compartments with adjustable shelves

Options:

- must specify chassis grain direction on double cut veneer, see pages 13-15 for details
- veneer drawer fronts in paint available, specify paint color; add \$337 list; see page 16 for details
- on laminate units, contrasting worksurface tops and drawer fronts available, no upcharge; specify laminate color, see page 16 for details
- ledge pulls standard; prism pulls available, specify and see page 9
- oval grommets in back panels can be eliminated upon request, no upcharge
- concealed box drawer(s) available, specify location in unit; add \$234 list for each laminate drawer or \$357 list for each veneer drawer, see page 25 for details
- seat cushion available, see page 25 for more details and page 212 for pricing
- top grommet available, specify location; add \$128 list each; see page 46 for details
- interior wire manager from side to side in upper back, specify and add \$114 list; see page 17 for details

Box/Lateral File Storage Credenza with Peninsula Desk Mount	22	96	21	341	32	FLT2296-21FM66	\$3,131		
	22	96	21	341	32	FLV2296-21FM66		\$4,196	\$4,616
	22	96	21	341	32	FLT2296-21F66M	\$3,131		
	22	96	21	341	32	FLV2296-21F66M		\$4,196	\$4,616



*M66 shown



*66M

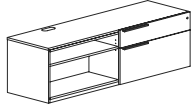
Features:

- must be used with 33" deep adjustable height modular peninsula desk
- desk lift column can only be mounted in sections with an open compartment, see page 39 for details
- open compartment with adjustable shelf

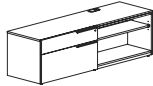
Options:

- must specify chassis grain direction on double cut veneer, see pages 13-15 for details
- veneer drawer fronts in paint available, specify paint color; add \$337 list; see page 16 for details
- on laminate units, contrasting worksurface tops and drawer fronts available, no upcharge; specify laminate color, see page 16 for details
- ledge pulls standard; prism pulls available, specify and see page 9
- oval grommets in back panels can be eliminated upon request, no upcharge
- concealed box drawer(s) available, specify location in unit; add \$234 list for each laminate drawer or \$357 list for each veneer drawer, see page 25 for details
- seat cushion available, see page 25 for more details and page 212 for pricing
- top grommet available, specify location; add \$128 list each; see page 47 for details
- interior wire manager from side to side in upper back, specify and add \$114 list; see page 17 for details

Description	D	W	H	CTN WT	CU FT	① Model	HPL Laminate	Flat Cut Veneer	Double Cut Veneer
Box/Lateral File Storage	22	72	21	267	24	FLT2272-21FM6	\$2,605		
Credenza with Peninsula Desk Mount	22	72	21	267	24	FLV2272-21FM6		\$3,490	\$3,837
	22	72	21	267	24	FLT2272-21F6M	\$2,605		
	22	72	21	267	24	FLV2272-21F6M		\$3,490	\$3,837



*M6 shown



*6M

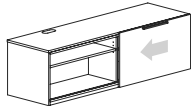
Features:

- must be used with 33" deep adjustable height modular peninsula desk
- desk lift column can only be mounted in sections with an open compartment, see page 39 for details
- open compartment with adjustable shelf

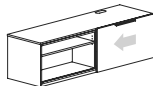
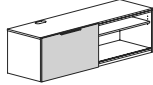
Options:

- must specify chassis grain direction on double cut veneer, see pages 13-15 for details
- veneer drawer fronts in paint available, specify paint color; add \$337 list; see page 16 for details
- on laminate units, contrasting worksurface tops and drawer fronts available, no upcharge; specify laminate color, see page 16 for details
- ledge pulls standard; prism pulls available, specify and see page 9
- oval grommets in back panels can be eliminated upon request, no upcharge
- concealed box drawer(s) available, specify location in unit; add \$234 list for each laminate drawer or \$357 list for each open compartment, see page 25 for details
- seat cushion available, see page 25 for more details and page 212 for pricing
- top grommet available, specify location; add \$128 list each; see page 47 for details
- interior wire manager from side to side in upper back, specify and add \$114 list; see page 17 for details

Sliding Door Credenza with Peninsula Desk Mount	D	W	H	CTN WT	CU FT	① Model	HPL Laminate	Flat Cut Veneer	Double Cut Veneer
	22	72	21	225	24	FLT2272-21FM9	\$2,876		
	22	72	21	225	24	FLV2272-21FM9		\$3,854	\$4,241
	22	72	21	225	24	FLT2272-21F9M	\$2,876		
	22	72	21	225	24	FLV2272-21F9M		\$3,854	\$4,241



*M9 shown



*9M

Features:

- must be used with 33" deep adjustable height modular peninsula desk
- desk lift column can only be mounted in sections with an open compartment, see page 39 for details
- each compartment has one adjustable shelf

Options:

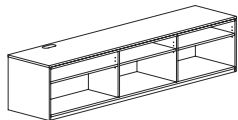
- must specify chassis grain direction on double cut veneer, see pages 13-15 for details
- veneer door fronts in paint available, specify paint color; add \$337 list; see page 16 for details
- on laminate units, contrasting worksurface tops and drawer fronts available, no upcharge; specify laminate color, see page 16 for details
- ledge pulls standard; prism pulls available, specify and see page 9
- oval grommets in back panels can be eliminated upon request, no upcharge
- seat cushion available, see page 25 for more details and page 212 for pricing
- top grommet available, specify location; add \$128 list each; see page 47 for details
- interior wire manager from side to side in upper back, specify and add \$114 list; see page 17 for details

To Order, Specify:

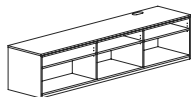
① Laminate Model #	② Laminate Type	③ Laminate Selection	④ Metal Color	⑤ Other Product Options
Laminate (FLT)	HPL	See Laminate Selection	See Metal Finish Color Options	See list of options for each specific unit; Specify and add accordingly.

① Veneer Model #	② Wood Species	③ Wood Finish	④ Metal Color	⑤ Other Product Options	
Veneer (FLV)	Flat Cut CH1 Cherry MA1 Maple WA1 Walnut BO1 Black Oak	See Flat Cut Wood Finish Options	See Metal Finish Color Options	See list of options for each specific unit; Specify and add accordingly.	
	Double Cut DC1 Double Cut	<table border="1"> <thead> <tr> <th>ⓐ Wood Finish</th> <th>ⓑ Chassis Grain Direction</th> </tr> </thead> <tbody> <tr> <td>See Double Cut Wood Finish Options</td> <td>For Double Cut Only: Vertical Horizontal</td> </tr> </tbody> </table>			ⓐ Wood Finish
ⓐ Wood Finish	ⓑ Chassis Grain Direction				
See Double Cut Wood Finish Options	For Double Cut Only: Vertical Horizontal				

Description	D	W	H	CTN WT	CU FT	① Model	HPL Laminate	Flat Cut Veneer	Double Cut Veneer
Open Compartment Storage Credenza with Peninsula Desk Mount	22	96	21	266	32	FLT2296-21FM00	\$2,560		
	22	96	21	266	32	FLV2296-21FM00		\$3,602	\$3,963
	22	96	21	266	32	FLT2296-21F00M	\$2,560		
	22	96	21	266	32	FLV2296-21F00M		\$3,602	\$3,963



*M00 shown



*00M

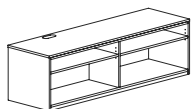
Features:

- must be used with 33" deep adjustable height modular peninsula desk
- square edge on top
- each compartment has one adjustable shelf

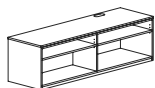
Options:

- must specify chassis grain direction on double cut veneer, see pages 13-15 for details
- oval grommets in back panels can be eliminated upon request, no upcharge
- seat cushion available, see page 25 for more details and page 212 for pricing
- top grommet available, specify location; add \$128 list each; see page 47 for details
- interior wire manager from side to side in upper back, specify and add \$114 list; see page 17 for details

Open Compartment Storage Credenza with Peninsula Desk Mount	22	72	21	204	24	FLT2272-21FM0	\$2,264		
	22	72	21	204	24	FLV2272-21FM0		\$3,190	\$3,509
	22	72	21	204	24	FLT2272-21F0M	\$2,264		
	22	72	21	204	24	FLV2272-21F0M		\$3,190	\$3,509



*M0 shown



*0M

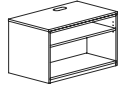
Features:

- must be used with 33" deep adjustable height modular peninsula desk
- square edge on top
- each compartment has one adjustable shelf

Options:

- must specify chassis grain direction on double cut veneer, see pages 13-15 for details
- oval grommets in back panels can be eliminated upon request, no upcharge
- seat cushion available, see page 25 for more details and page 212 for pricing
- top grommet available, specify location; add \$128 list each; see page 47 for details
- interior wire manager from side to side in upper back, specify and add \$114 list; see page 17 for details

Description	D	W	H	CTN WT	CU FT	① Model	HPL Laminate	Flat Cut Veneer	Double Cut Veneer
Open Compartment Storage Pedestal with Peninsula Desk Mount	22	36	21	111	13	FLT2236-21FMR	\$1,728		
	22	36	21	111	13	FLV2236-21FMR		\$2,430	\$2,675
	22	36	21	111	13	FLT2236-21FML	\$1,728		
	22	36	21	111	13	FLV2236-21FML		\$2,430	\$2,675



*MR shown



*ML

Features:

- must be used with 33" deep adjustable height modular peninsula desk
- square edge on top
- open compartment with adjustable shelf

Options:

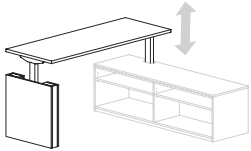
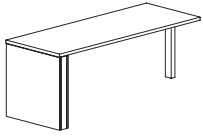
- must specify chassis grain direction on double cut veneer, see pages 13-15 for details
- oval grommets in back panels can be eliminated upon request, no upcharge
- seat cushion available, see page 25 for more details and page 212 for pricing
- interior wire manager from side to side in upper back, specify and add \$114 list; see page 17 for details

To Order, Specify:

① Laminate Model #	② Laminate Type	③ Laminate Selection	④ Metal Color	⑤ Other Product Options
Laminate (FLT)	HPL	See Laminate Selection	See Metal Finish Color Options	See list of options for each specific unit; Specify and add accordingly.

① Veneer Model #	② Wood Species	③ Wood Finish	④ Metal Color	⑤ Other Product Options	
Veneer (FLV)	Flat Cut CH1 Cherry MA1 Maple WA1 Walnut BO1 Black Oak	See Flat Cut Wood Finish Options	See Metal Finish Color Options	See list of options for each specific unit; Specify and add accordingly.	
	Double Cut DC1 Double Cut	<table border="1"> <thead> <tr> <th>③a Wood Finish</th> <th>③b Chassis Grain Direction</th> </tr> </thead> <tbody> <tr> <td>See Double Cut Wood Finish Options</td> <td>For Double Cut Only: Vertical Horizontal</td> </tr> </tbody> </table>			③a Wood Finish
③a Wood Finish	③b Chassis Grain Direction				
See Double Cut Wood Finish Options	For Double Cut Only: Vertical Horizontal				

Description	D	W	H	CTN WT	CU FT	① Model	HPL Laminate	Flat Cut Veneer	Double Cut Veneer
27" Adjustable Height Modular Peninsula Desk	27½	72	Adj.	182	21	FLT2872PAHD	\$4,502		
	27½	72	Adj.	182	21	FLV2872PAHD		\$5,697	\$6,268
	27½	66	Adj.	176	19	FLT2866PAHD	\$4,476		
	27½	66	Adj.	176	19	FLV2866PAHD		\$5,661	\$6,226
	27½	60	Adj.	170	19	FLT2860PAHD	\$4,449		
	27½	60	Adj.	170	19	FLV2860PAHD		\$5,623	\$6,186



in application

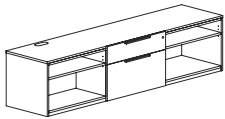
Features:

- must be used with 90", 60" and 30" wide secondary height peninsula mount credenzas
- 29" to 47" height adjustment with digital controller, wire guide and 10' power cord
- maximum weight rating 140 lbs. (evenly distributed load)

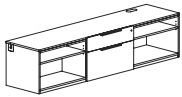
Options:

- must specify support panels grain direction on double cut veneer, see pages 13-15 for details
- reverse bevel edge available on approach and user sides, specify; add \$429 list for laminate or \$168 list for veneer; see page 8 for details
- 13 ½" h modesty panel available, specify; add \$427 list for laminate or \$594 list for veneer; see page 21 for details
- top grommet available, specify location; add \$128 list each; see page 49 for details
- worksurface power available, specify "to accommodate EC26" on your purchase order; EC26 unit must be ordered separately, see page 49

Box/Lateral File Storage Credenza with Peninsula Desk Mount	22	90	21	278	30	FLT2290-21FM60	\$2,834		
	22	90	21	278	30	FLV2290-21FM60		\$3,796	\$4,177
	22	90	21	278	30	FLT2290-21F06M	\$2,834		
	22	90	21	278	30	FLV2290-21F06M		\$3,796	\$4,177



*M60 shown



*06M

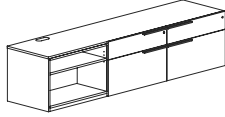
Features:

- must be used with 27" deep adjustable height modular peninsula desk
- desk lift column can only be mounted in sections with an open compartment, see page 39 for details
- open compartment with adjustable shelf

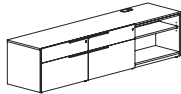
Options:

- must specify chassis grain direction on double cut veneer, see pages 13-15 for details
- veneer drawer fronts in paint available, specify paint color; add \$337 list; see page 16 for details
- on laminate units, contrasting worksurface tops and drawer fronts available, no upcharge; specify laminate color, see page 16 for details
- ledge pulls standard; prism pulls available, specify and see page 9
- oval grommets in back panels can be eliminated upon request, no upcharge
- concealed box drawer(s) available, specify location in unit; add \$234 list for each laminate drawer or \$357 list for each veneer drawer, see page 25 for details
- seat cushion available, see page 25 for more details and page 212 for pricing
- top grommet available, specify location; add \$128 list each; see page 47 for details
- interior wire manager from side to side in upper back, specify and add \$114 list; see page 17 for details

Description	D	W	H	CTN WT	CU FT	① Model	HPL Laminate	Flat Cut Veneer	Double Cut Veneer
Box/Lateral File Storage Credenza with Peninsula Desk Mount	22	90	21	313	30	FLT2290-21FM66	\$2,997		
	22	90	21	313	30	FLV2290-21FM66		\$4,073	\$4,481
	22	90	21	313	30	FLT2290-21F66M	\$2,997		
	22	90	21	313	30	FLV2290-21F66M		\$4,073	\$4,481



*M66 shown



*66M

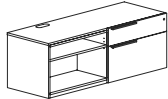
Features:

- must be used with 27" deep adjustable height modular peninsula desk
- desk lift column can only be mounted in sections with an open compartment, see page 39 for details
- open compartment with adjustable shelf

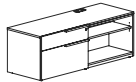
Options:

- must specify chassis grain direction on double cut veneer, see pages 13-15 for details
- veneer drawer fronts in paint available, specify paint color; add \$337 list; see page 16 for details
- on laminate units, contrasting worksurface tops and drawer fronts available, no upcharge; specify laminate color, see page 16 for details
- ledge pulls standard; prism pulls available, specify and see page 9
- oval grommets in back panels can be eliminated upon request, no upcharge
- concealed box drawer(s) available, specify location in unit; add \$234 list for each laminate drawer or \$357 list for each veneer drawer, see page 25 for details
- seat cushion available, see page 25 for more details and page 212 for pricing
- top grommet available, specify location; add \$128 list each; see page 47 for details
- interior wire manager from side to side in upper back, specify and add \$114 list; see page 17 for details

Box/Lateral File Storage Credenza with Peninsula Desk Mount	22	60	21	239	21	FLT2260-21FM6	\$2,456		
	22	60	21	239	21	FLV2260-21FM6		\$3,291	\$3,620
	22	60	21	239	21	FLT2260-21F6M	\$2,456		
	22	60	21	239	21	FLV2260-21F6M		\$3,291	\$3,620



*M6 shown



*6M

Features:

- must be used with 27" deep adjustable height modular peninsula desk
- desk lift column can only be mounted in sections with an open compartment, see page 39 for details
- open compartment with adjustable shelf

Options:

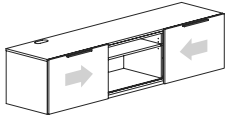
- must specify chassis grain direction on double cut veneer, see pages 13-15 for details
- veneer drawer fronts in paint available, specify paint color; add \$337 list; see page 16 for details
- on laminate units, contrasting worksurface tops and drawer fronts available, no upcharge; specify laminate color, see page 16 for details
- ledge pulls standard; prism pulls available, specify and see page 9
- oval grommets in back panels can be eliminated upon request, no upcharge
- concealed box drawer(s) available, specify location in unit; add \$234 list for each laminate drawer or \$357 list for each veneer drawer, see page 25 for details
- seat cushion available, see page 25 for more details and page 212 for pricing
- top grommet available, specify location; add \$128 list each; see page 47 for details
- interior wire manager from side to side in upper back, specify and add \$114 list; see page 17 for details

To Order, Specify:

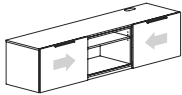
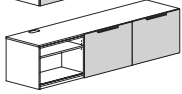
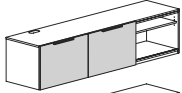
① Laminate Model #	② Laminate Type	③ Laminate Selection	④ Metal Color	⑤ Other Product Options
Laminate (FLT)	HPL	See Laminate Selection	See Metal Finish Color Options	See list of options for each specific unit; Specify and add accordingly.

① Veneer Model #	② Wood Species	③ Wood Finish	④ Metal Color	⑤ Other Product Options	
Veneer (FLV)	Flat Cut CH1 Cherry MA1 Maple WA1 Walnut BO1 Black Oak	See Flat Cut Wood Finish Options	See Metal Finish Color Options	See list of options for each specific unit; Specify and add accordingly.	
	Double Cut DC1 Double Cut	<table border="1"> <thead> <tr> <th>ⓐ Wood Finish</th> <th>ⓑ Chassis Grain Direction</th> </tr> </thead> <tbody> <tr> <td>See Double Cut Wood Finish Options</td> <td>For Double Cut Only: Vertical Horizontal</td> </tr> </tbody> </table>			ⓐ Wood Finish
ⓐ Wood Finish	ⓑ Chassis Grain Direction				
See Double Cut Wood Finish Options	For Double Cut Only: Vertical Horizontal				

Description	D	W	H	CTN WT	CU FT	① Model	HPL Laminate	Flat Cut Veneer	Double Cut Veneer
Sliding Door Credenza with Peninsula Desk Mount	22	90	21	276	31	FLT2290-21FM99	\$2,715		
	22	90	21	276	31	FLV2290-21FM99		\$3,637	\$4,001
	22	90	21	276	31	FLT2290-21F99M	\$2,715		
	22	90	21	276	31	FLV2290-21F99M		\$3,637	\$4,001



*M99 shown



*99M

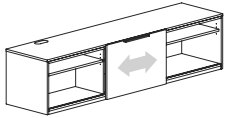
Features:

- must be used with 27" deep adjustable height modular peninsula desk
- desk lift column can only be mounted in sections with an open compartment, see page 39 for details
- each compartment has one adjustable shelf

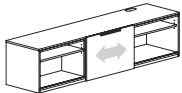
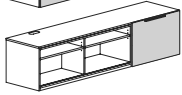
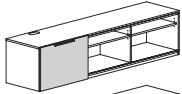
Options:

- must specify chassis grain direction on double cut veneer, see pages 13-15 for details
- veneer door fronts in paint available, specify paint color; add \$337 list; see page 16 for details
- on laminate units, contrasting worksurface tops and drawer fronts available, no upcharge; specify laminate color, see page 16 for details
- ledge pulls standard; prism pulls available, specify and see page 9
- oval grommets in back panels can be eliminated upon request, no upcharge
- seat cushion available, see page 25 for more details and page 212 for pricing
- top grommet available, specify location; add \$128 list each; see page 47 for details
- interior wire manager from side to side in upper back, specify and add \$114 list; see page 17 for details

Sliding Door Credenza with Peninsula Desk Mount	22	90	21	259	31	FLT2290-21FM90	\$2,611		
	22	90	21	259	31	FLV2290-21FM90		\$3,499	\$3,847
	22	90	21	259	31	FLT2290-21F09M	\$2,611		
	22	90	21	259	31	FLV2290-21F09M		\$3,499	\$3,847



*M90 shown



*09M

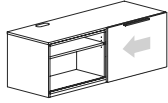
Features:

- must be used with 27" deep adjustable height modular peninsula desk
- desk lift column can only be mounted in sections with an open compartment, see page 39 for details
- each compartment has one adjustable shelf

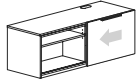
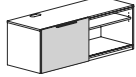
Options:

- must specify chassis grain direction on double cut veneer, see pages 13-15 for details
- veneer door fronts in paint available, specify paint color; add \$337 list; see page 16 for details
- on laminate units, contrasting worksurface tops and drawer fronts available, no upcharge; specify laminate color, see page 16 for details
- ledge pulls standard; prism pulls available, specify and see page 9
- oval grommets in back panels can be eliminated upon request, no upcharge
- seat cushion available, see page 25 for more details and page 212 for pricing
- top grommet available, specify location; add \$128 list each; see page 47 for details
- interior wire manager from side to side in upper back, specify and add \$114 list; see page 17 for details

Description	D	W	H	CTN WT	CU FT	① Model	HPL Laminate	Flat Cut Veneer	Double Cut Veneer
Sliding Door Credenza with Peninsula Desk Mount	22	60	21	185	21	FLT2260-21FM9	\$2,244		
	22	60	21	185	21	FLV2260-21FM9		\$3,008	\$3,309
	22	60	21	185	21	FLT2260-21F9M	\$2,244		
	22	60	21	185	21	FLV2260-21F9M		\$3,008	\$3,309



*M9 shown



*9M

Features:

- must be used with 27" deep adjustable height modular peninsula desk
- desk lift column can only be mounted in sections with an open compartment, see page 39 for details
- each compartment has one adjustable shelf

Options:

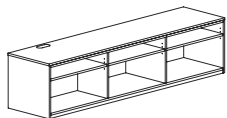
- must specify chassis grain direction on double cut veneer, see pages 13-15 for details
- veneer door fronts in paint available, specify paint color; add \$337 list; see page 16 for details
- on laminate units, contrasting worksurface tops and drawer fronts available, no upcharge; specify laminate color, see page 16 for details
- ledge pulls standard; prism pulls available, specify and see page 9
- oval grommets in back panels can be eliminated upon request, no upcharge
- seat cushion available, see page 25 for more details and page 212 for pricing
- top grommet available, specify location; add \$128 list each; see page 47 for details
- interior wire manager from side to side in upper back, specify and add \$114 list; see page 17 for details

To Order, Specify:

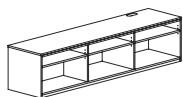
① Laminate Model #	② Laminate Type	③ Laminate Selection	④ Metal Color	⑤ Other Product Options
Laminate (FLT)	HPL	See Laminate Selection	See Metal Finish Color Options	See list of options for each specific unit; Specify and add accordingly.

① Veneer Model #	② Wood Species	③ Wood Finish	④ Metal Color	⑤ Other Product Options	
Veneer (FLV)	Flat Cut CH1 Cherry MA1 Maple WA1 Walnut BO1 Black Oak	See Flat Cut Wood Finish Options	See Metal Finish Color Options	See list of options for each specific unit; Specify and add accordingly.	
	Double Cut DC1 Double Cut	<table border="1"> <thead> <tr> <th>ⓐ Wood Finish</th> <th>ⓑ Chassis Grain Direction</th> </tr> </thead> <tbody> <tr> <td>See Double Cut Wood Finish Options</td> <td>For Double Cut Only: Vertical Horizontal</td> </tr> </tbody> </table>			ⓐ Wood Finish
ⓐ Wood Finish	ⓑ Chassis Grain Direction				
See Double Cut Wood Finish Options	For Double Cut Only: Vertical Horizontal				

Description	D	W	H	CTN WT	CU FT	① Model	HPL Laminate	Flat Cut Veneer	Double Cut Veneer
Open Compartment Storage Credenza with Peninsula Desk Mount	22	90	21	238	30	FLT2290-21FM00	\$2,189		
	22	90	21	238	30	FLV2290-21FM00		\$3,082	\$3,389
	22	90	21	238	30	FLT2290-21F00M	\$2,189		
	22	90	21	238	30	FLV2290-21F00M		\$3,082	\$3,389



*M00 shown



*O0M

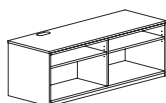
Features:

- must be used with 27" deep adjustable height modular peninsula desk
- square edge on top
- each compartment has one adjustable shelf

Options:

- must specify chassis grain direction on double cut veneer, see pages 13-15 for details
- oval grommets in back panels can be eliminated upon request, no upcharge
- seat cushion available, see page 25 for more details and page 212 for pricing
- top grommet available, specify location; add \$128 list each; see page 47 for details
- interior wire manager from side to side in upper back, specify and add \$114 list; see page 17 for details

Open Compartment Storage Credenza with Peninsula Desk Mount	22	60	21	176	21	FLT2260-21FM0	\$1,884		
	22	60	21	176	21	FLV2260-21FM0		\$2,650	\$2,914
	22	60	21	176	21	FLT2260-21F0M	\$1,884		
	22	60	21	176	21	FLV2260-21F0M		\$2,650	\$2,914



*M0



*O0M

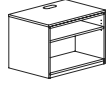
Features:

- must be used with 27" deep adjustable height modular peninsula desk
- square edge on top
- each compartment has one adjustable shelf

Options:

- must specify chassis grain direction on double cut veneer, see pages 13-15 for details
- oval grommets in back panels can be eliminated upon request, no upcharge
- seat cushion available, see page 25 for more details and page 212 for pricing
- top grommet available, specify location; add \$128 list each; see page 47 for details
- interior wire manager from side to side in upper back, specify and add \$114 list; see page 17 for details

Description	D	W	H	CTN WT	CU FT	① Model	HPL Laminate	Flat Cut Veneer	Double Cut Veneer
Open Compartment Storage	22	30	21	83	11	FLT2230-21FMR	\$1,661		
Pedestal with Peninsula Desk	22	30	21	83	11	FLV2230-21FMR		\$2,334	\$2,569
Mount	22	30	21	83	11	FLT2230-21FML	\$1,661		
	22	30	21	83	11	FLV2230-21FML		\$2,334	\$2,569



*MR shown



*ML

Features:

- must be used with 27" deep adjustable height modular peninsula desk
- square edge on top
- open compartment with adjustable shelf

Options:

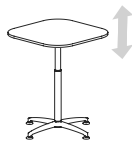
- must specify chassis grain direction on double cut veneer, see pages 13-15 for details
- oval grommets in back panels can be eliminated upon request, no upcharge
- interior wire manager from side to side in upper back, specify and add \$114 list; see page 17 for details

To Order, Specify:

① Laminate Model #	② Laminate Type	③ Laminate Selection	④ Metal Color	⑤ Other Product Options
Laminate (FLT)	HPL	See Laminate Selection	See Metal Finish Color Options	See list of options for each specific unit; Specify and add accordingly.

① Veneer Model #	② Wood Species	③ Wood Finish	④ Metal Color	⑤ Other Product Options	
Veneer (FLV)	Flat Cut CH1 Cherry MA1 Maple WA1 Walnut BO1 Black Oak	See Flat Cut Wood Finish Options	See Metal Finish Color Options	See list of options for each specific unit; Specify and add accordingly.	
	Double Cut DC1 Double Cut	<table border="1"> <thead> <tr> <th>ⓐ Wood Finish</th> <th>ⓑ Chassis Grain Direction</th> </tr> </thead> <tbody> <tr> <td>See Double Cut Wood Finish Options</td> <td>For Double Cut Only: Vertical Horizontal</td> </tr> </tbody> </table>			ⓐ Wood Finish
ⓐ Wood Finish	ⓑ Chassis Grain Direction				
See Double Cut Wood Finish Options	For Double Cut Only: Vertical Horizontal				

Description	D	W	H	CTN WT	CU FT	① Model	HPL Laminate	Flat Cut Veneer	Double Cut Veneer
Square Pneumatic Adjustable Height Table	30	30	Adj.	42	19	FLT3030SAT4B	\$1,983		
	30	30	Adj.	42	19	FLV3030SAT4B		\$2,447	\$2,692
	24	24	Adj.	34	13	FLT2424SAT4B	\$1,943		
	24	24	Adj.	34	13	FLV2424SAT4B		\$2,397	\$2,638



Features:

- ¾" top with flat edge
- 4-star cast aluminum base
- 26" to 38" height adjustment, casters increase heights by 2"
- release lever mounts under edge of top
- 15 lbs. lift force, maximum weight rating 75 lbs. (evenly distributed load)

Options:

- casters available, four locking, specify and add \$98 list

Round Pneumatic Adjustable Height Table	36	36	Adj.	46	27	FLT3636RAT4B	\$2,021		
	36	36	Adj.	46	27	FLV3636RAT4B		\$2,497	\$2,747
	30	30	Adj.	39	19	FLT3030RAT4B	\$1,983		
	30	30	Adj.	39	19	FLV3030RAT4B		\$2,447	\$2,692



Features:

- ¾" top with flat edge
- 4-star cast aluminum base
- 26" to 38" height adjustment, casters increase heights by 2"
- release lever mounts under edge of top
- 15 lbs. lift force, maximum weight rating 75 lbs. (evenly distributed load)

Options:

- casters available, four locking, specify and add \$98 list

FLUX - PRIVATE OFFICE

Description	D	W	H	CTN WT	CU FT	1 Model	HPL Laminate	Flat Cut Veneer	Double Cut Veneer
Oval Pneumatic Adjustable	26	36	Adj.	42	20	FLT26360AT4B	\$2,062		
Height Table	26	36	Adj.	42	20	FLV26360AT4B		\$2,548	\$2,803



Features:



- ¾" top with flat edge
- 4-star cast aluminum base
- 26" to 38" height adjustment, casters increase heights by 2"
- release lever mounts under edge of top
- 15 lbs. lift force, maximum weight rating 75 lbs. (evenly distributed load)

Options:

- casters available, four locking, specify and add \$98 list

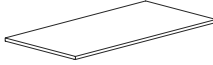


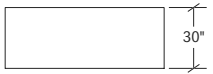
To Order, Specify:

1 Laminate Model #	2 Laminate Type	3 Laminate Selection		4 Metal Color	5 Other Product Options
Laminate (FLT)	HPL	See Laminate Selection		See Metal Finish Color Options	See list of options for each specific unit; Specify and add accordingly.
1 Veneer Model #	2 Wood Species	3 Wood Finish		4 Metal Color	5 Other Product Options
Veneer (FLV)	Flat Cut CH1 Cherry MA1 Maple WA1 Walnut BO1 Black Oak	See Flat Cut Wood Finish Options		See Metal Finish Color Options	See list of options for each specific unit; Specify and add accordingly.
	Double Cut DC1 Double Cut	3a Wood Finish	3b Chassis Grain Direction		
		See Double Cut Wood Finish Options	For Double Cut Only: Vertical Horizontal		

Description	D	W	H	CTN WT	CU FT	① Model	HPL Laminate	Flat Cut Veneer	Double Cut Veneer
Modular Bow Front Desk Top  	36	84	1 3/16	103	7	FLT3684BMCT	\$1,530		
	36	84	1 3/16	103	7	FLV3684BMCT		\$2,366	\$2,604
	36	78	1 3/16	96	6	FLT3678BMCT	\$1,475		
	36	78	1 3/16	96	6	FLV3678BMCT		\$2,273	\$2,500
	36	72	1 3/16	89	6	FLT3672BMCT	\$1,419		
	36	72	1 3/16	89	6	FLV3672BMCT		\$2,182	\$2,400
	36	66	1 3/16	82	5	FLT3666BMCT	\$1,401		
	36	66	1 3/16	82	5	FLV3666BMCT		\$2,150	\$2,366
	36	60	1 3/16	75	5	FLT3660BMCT	\$1,378		
	36	60	1 3/16	75	5	FLV3660BMCT		\$2,117	\$2,330

Features:

- eased edge profile on approach and user sides

Description	D	W	H	CTN WT	CU FT	① Model	HPL Laminate	Flat Cut Veneer	Double Cut Veneer
Modular Rectangular Desk Top	36	84	1 3/16	101	7	FLT3684MCT	\$1,131		
	36	84	1 3/16	101	7	FLV3684MCT		\$1,788	\$1,970
	36	78	1 3/16	94	6	FLT3678MCT	\$1,051		
	36	78	1 3/16	94	6	FLV3678MCT		\$1,663	\$1,828
	36	72	1 3/16	87	6	FLT3672MCT	\$970		
	36	72	1 3/16	87	6	FLV3672MCT		\$1,535	\$1,690
	36	66	1 3/16	80	5	FLT3666MCT	\$891		
	36	66	1 3/16	80	5	FLV3666MCT		\$1,407	\$1,548
	36	60	1 3/16	73	5	FLT3660MCT	\$810		
	36	60	1 3/16	73	5	FLV3660MCT		\$1,281	\$1,409
	30	84	1 3/16	85	6	FLT3084MCT	\$945		
	30	84	1 3/16	85	6	FLV3084MCT		\$1,492	\$1,640
	30	78	1 3/16	79	5	FLT3078MCT	\$877		
	30	78	1 3/16	79	5	FLV3078MCT		\$1,384	\$1,525
	30	72	1 3/16	73	5	FLT3072MCT	\$810		
	30	72	1 3/16	73	5	FLV3072MCT		\$1,281	\$1,409
	30	66	1 3/16	68	5	FLT3066MCT	\$742		
	30	66	1 3/16	68	5	FLV3066MCT		\$1,174	\$1,292
	30	60	1 3/16	62	4	FLT3060MCT	\$675		
	30	60	1 3/16	62	4	FLV3060MCT		\$1,068	\$1,175

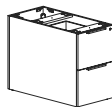
· eased edge profile on approach and user sides

FLUX - PRIVATE OFFICE

To Order, Specify:

① Laminate Model #	② Laminate Type	③ Laminate Selection	④ Metal Color	⑤ Other Product Options
Laminate (FLT)	HPL	See Laminate Selection	See Metal Finish Color Options	See list of options for each specific unit; Specify and add accordingly.

① Veneer Model #	② Wood Species	③ Wood Finish	④ Metal Color	⑤ Other Product Options	
Veneer (FLV)	Flat Cut CH1 Cherry MA1 Maple WA1 Walnut BO1 Black Oak	See Flat Cut Wood Finish Options	See Metal Finish Color Options	See list of options for each specific unit; Specify and add accordingly.	
	Double Cut DC1 Double Cut	<table border="1"> <thead> <tr> <th>ⓐ Wood Finish</th> <th>ⓑ Chassis Grain Direction</th> </tr> </thead> <tbody> <tr> <td>See Double Cut Wood Finish Options</td> <td>For Double Cut Only: Vertical Horizontal</td> </tr> </tbody> </table>			ⓐ Wood Finish
ⓐ Wood Finish	ⓑ Chassis Grain Direction				
See Double Cut Wood Finish Options	For Double Cut Only: Vertical Horizontal				

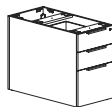
Description	D	W	H	CTN WT	CU FT	① Model	HPL Laminate	Flat Cut Veneer	Double Cut Veneer
	36	18	28	110	14	FLT3618-29FM2	\$1,187		
	36	18	28	110	14	FLV3618-29FM2		\$1,784	\$1,961
	36	15%	28	100	12	FLT3616-29FM2	\$1,169		
	36	15%	28	100	12	FLV3616-29FM2		\$1,757	\$1,933
	30	18	28	97	12	FLT3018-29FM2	\$1,154		
	30	18	28	97	12	FLV3018-29FM2		\$1,733	\$1,906
	30	15%	28	90	10	FLT3016-29FM2	\$1,135		
	30	15%	28	90	10	FLV3016-29FM2		\$1,706	\$1,877

Features:

- use with other modular components, requires a modular top, see page 39
- pedestal front locking

Options:

- must specify chassis grain direction on double cut veneer, see pages 13-15 for details
- veneer drawer fronts in paint available, specify paint color and add \$337 list; see page 16 for details
- on laminate units, contrasting fronts available, no upcharge; specify color, see page 16 for details
- ledge pulls standard; prism pulls available, specify and see page 9

Description	D	W	H	CTN WT	CU FT	① Model	HPL Laminate	Flat Cut Veneer	Double Cut Veneer
	36	18	28	114	14	FLT3618-29FM1	\$1,193		
	36	18	28	114	14	FLV3618-29FM1		\$1,793	\$1,972
	36	15%	28	104	12	FLT3616-29FM1	\$1,176		
	36	15%	28	104	12	FLV3616-29FM1		\$1,766	\$1,942
	30	18	28	102	12	FLT3018-29FM1	\$1,159		
	30	18	28	102	12	FLV3018-29FM1		\$1,740	\$1,915
	30	15%	28	95	10	FLT3016-29FM1	\$1,141		
	30	15%	28	95	10	FLV3016-29FM1		\$1,714	\$1,886

Features:

- use with other modular components, requires a modular top, see page 39
- pedestal front locking

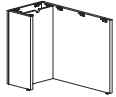
Options:

- must specify chassis grain direction on double cut veneer, see pages 13-15 for details
- veneer drawer fronts in paint available, specify paint color and add \$337 list; see page 16 for details
- on laminate units, contrasting fronts available, no upcharge; specify color, see page 16 for details
- ledge pulls standard; prism pulls available, specify and see page 9

Description	D	W	H	CTN WT	CU FT	① Model	HPL Laminate	Flat Cut Veneer	Double Cut Veneer
Modular Desk End Panel	36	18	28	74	14	FLT3618WEAR	\$871		
	36	18	28	74	14	FLV3618WEAR		\$1,306	\$1,438
	36	18	28	74	14	FLT3618WEAL	\$871		
	36	18	28	74	14	FLV3618WEAL		\$1,306	\$1,438
	36	15 3/8	28	71	12	FLT3616WEAR	\$857		
	36	15 3/8	28	71	12	FLV3616WEAR		\$1,290	\$1,417
	36	15 3/8	28	71	12	FLT3616WEAL	\$857		
	36	15 3/8	28	71	12	FLV3616WEAL		\$1,290	\$1,417



left shown



right

Features:

- use with other modular components, requires a modular top, see page 39

Options:

- must specify chassis grain direction on double cut veneer, see pages 13-15 for details

Modular Desk End Panel	30	18	28	68	12	FLT3018WEAR	\$854		
	30	18	28	68	12	FLV3018WEAR		\$1,283	\$1,411
	30	18	28	68	12	FLT3018WEAL	\$854		
	30	18	28	68	12	FLV3018WEAL		\$1,283	\$1,411
	30	15 3/8	28	65	10	FLT3016WEAR	\$841		
	30	15 3/8	28	65	10	FLV3016WEAR		\$1,261	\$1,390
	30	15 3/8	28	65	10	FLT3016WEAL	\$841		
	30	15 3/8	28	65	10	FLV3016WEAL		\$1,261	\$1,390



left shown



right

Features:

- use with other modular components, requires a modular top, see page 39

Options:

- must specify chassis grain direction on double cut veneer, see pages 13-15 for details

To Order, Specify:

① Laminate Model #	② Laminate Type	③ Laminate Selection	④ Metal Color	⑤ Other Product Options
Laminate (FLT)	HPL	See Laminate Selection	See Metal Finish Color Options	See list of options for each specific unit; Specify and add accordingly.

① Veneer Model #	② Wood Species	③ Wood Finish	④ Metal Color	⑤ Other Product Options	
Veneer (FLV)	Flat Cut CH1 Cherry MA1 Maple WA1 Walnut BO1 Black Oak	See Flat Cut Wood Finish Options	See Metal Finish Color Options	See list of options for each specific unit; Specify and add accordingly.	
	Double Cut DC1 Double Cut	<table border="1"> <thead> <tr> <th>ⓐ Wood Finish</th> <th>ⓑ Chassis Grain Direction</th> </tr> </thead> <tbody> <tr> <td>See Double Cut Wood Finish Options</td> <td>For Double Cut Only: Vertical Horizontal</td> </tr> </tbody> </table>			ⓐ Wood Finish
ⓐ Wood Finish	ⓑ Chassis Grain Direction				
See Double Cut Wood Finish Options	For Double Cut Only: Vertical Horizontal				

Description	D	W	H	CTN WT	CU FT	① Model	HPL Laminate	Flat Cut Veneer	Double Cut Veneer
	7/8	48	28	34	3	FLT2848MDA	\$405		
	7/8	48	28	34	3	FLV2848MDA		\$605	\$666
	7/8	42	28	31	3	FLT2842MDA	\$351		
	7/8	42	28	31	3	FLV2842MDA		\$524	\$578
	7/8	36	28	27	2	FLT2836MDA	\$325		
	7/8	36	28	27	2	FLV2836MDA		\$486	\$536
	7/8	40 3/4	28	30	3	FLT2841MDA	\$346		
	7/8	40 3/4	28	30	3	FLV2841MDA		\$516	\$567
	7/8	34 3/4	28	27	2	FLT2835MDA	\$316		
	7/8	34 3/4	28	27	2	FLV2835MDA		\$472	\$520
	7/8	27 3/4	28	23	2	FLT2829MDA	\$315		
	7/8	27 3/4	28	23	2	FLV2829MDA		\$461	\$505

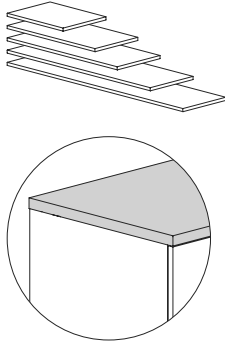
Features:

- use with other modular components, requires a modular top, see page 39

Options:

- must specify chassis grain direction on double cut veneer, see pages 13-15 for details

Description	D	W	H	CTN WT	CU FT	① Model	HPL Laminate	Flat Cut Veneer	Double Cut Veneer
Modular Credenza Top for Primary Height	22	108	1 3/16	80	5	FLT22108MCT	\$891		
	22	108	1 3/16	80	5	FLV22108MCT		\$1,407	\$1,548
	22	102	1 3/16	76	5	FLT22102MCT	\$841		
	22	102	1 3/16	76	5	FLV22102MCT		\$1,329	\$1,463
	22	96	1 3/16	72	5	FLT2296MCT	\$793		
	22	96	1 3/16	72	5	FLV2296MCT		\$1,251	\$1,375
	22	90	1 3/16	68	5	FLT2290MCT	\$742		
	22	90	1 3/16	68	5	FLV2290MCT		\$1,174	\$1,292
	22	84	1 3/16	64	4	FLT2284MCT	\$692		
	22	84	1 3/16	64	4	FLV2284MCT		\$1,095	\$1,205
	22	78	1 3/16	59	4	FLT2278MCT	\$645		
	22	78	1 3/16	59	4	FLV2278MCT		\$1,018	\$1,120
	22	72	1 3/16	55	4	FLT2272MCT	\$595		
	22	72	1 3/16	55	4	FLV2272MCT		\$937	\$1,034
	22	66	1 3/16	51	4	FLT2266MCT	\$545		
	22	66	1 3/16	51	4	FLV2266MCT		\$861	\$948
	22	60	1 3/16	47	3	FLT2260MCT	\$496		
	22	60	1 3/16	47	3	FLV2260MCT		\$783	\$861
	22	54	1 3/16	43	3	FLT2254MCT	\$448		
	22	54	1 3/16	43	3	FLV2254MCT		\$707	\$777
	22	48	1 3/16	39	3	FLT2248MCT	\$398		
	22	48	1 3/16	39	3	FLV2248MCT		\$627	\$689
	22	42	1 3/16	35	2	FLT2242MCT	\$349		
	22	42	1 3/16	35	2	FLV2242MCT		\$550	\$605
	22	36	1 3/16	30	2	FLT2236MCT	\$299		
	22	36	1 3/16	30	2	FLV2236MCT		\$471	\$519
	22	30	1 3/16	26	2	FLT2230MCT	\$249		
	22	30	1 3/16	26	2	FLV2230MCT		\$393	\$432
	22	18	1 3/16	15	1	FLT2218MCT	\$223		
	22	18	1 3/16	15	1	FLV2218MCT		\$323	\$356



Features:

- use with primary height modular components
- eased edge profile user side

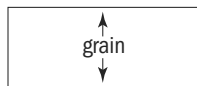
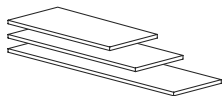
To Order, Specify:

① Laminate Model #	② Laminate Type	③ Laminate Selection		④ Metal Color	⑤ Other Product Options
Laminate (FLT)	HPL	See Laminate Selection		See Metal Finish Color Options	See list of options for each specific unit; Specify and add accordingly.

① Veneer Model #	② Wood Species	③ Wood Finish		④ Metal Color	⑤ Other Product Options
Veneer (FLV)	Flat Cut CH1 Cherry MA1 Maple WA1 Walnut BO1 Black Oak	See Flat Cut Wood Finish Options		See Metal Finish Color Options	See list of options for each specific unit; Specify and add accordingly.
		ⓐ Wood Finish	ⓑ Chassis Grain Direction		
	Double Cut DC1 Double Cut	See Double Cut Wood Finish Options	For Double Cut Only: Vertical Horizontal		

FLUX - PRIVATE OFFICE

Description	D	W	H	CTN WT	CU FT	① Model	HPL Laminate	Flat Cut Veneer	Double Cut Veneer
Modular Return Top for Primary Height (short grain)	22	60	1 3/16	47	3	FLT6022MRT	\$517		
	22	60	1 3/16	47	3	FLV6022MRT		\$803	\$883
	22	54	1 3/16	43	3	FLT5422MRT	\$469		
	22	54	1 3/16	43	3	FLV5422MRT		\$727	\$797
	22	48	1 3/16	39	3	FLT4822MRT	\$420		
	22	48	1 3/16	39	3	FLV4822MRT		\$648	\$711
	22	42	1 3/16	32	4	FLT4222MRT	\$376		
	22	42	1 3/16	32	4	FLV4222MRT		\$579	\$638
	22	36	1 3/16	29	4	FLT3622MRT	\$339		
	22	36	1 3/16	29	4	FLV3622MRT		\$524	\$574



Features:

- use with primary height modular components
- eased edge profile user side
- grain patterns runs short
- mounting brackets included

Modular File/File Credenza Pedestal	22	18	28	87	9	FLT2218-29FM2	\$1,117		
	22	18	28	87	9	FLV2218-29FM2		\$1,675	\$1,845
	22	15 5/8	28	80	8	FLT2216-29FM2	\$1,104		
	22	15 5/8	28	80	8	FLV2216-29FM2		\$1,658	\$1,823



Features:

- use with other modular components, requires a modular top, see page 39
- pedestal front locking

Options:

- must specify chassis grain direction on double cut veneer, see pages 13-15 for details
- veneer drawer fronts in paint available, specify paint color and add \$337 list; see page 16 for details
- on laminate units, contrasting fronts available, no upcharge; specify color, see page 16 for details
- ledge pulls standard; prism pulls available, specify and see page 9

Modular Box/Box/File Credenza Pedestal	22	18	28	89	9	FLT2218-29FM1	\$1,122		
	22	18	28	89	9	FLV2218-29FM1		\$1,685	\$1,854
	22	15 5/8	28	82	8	FLT2216-29FM1	\$1,109		
	22	15 5/8	28	82	8	FLV2216-29FM1		\$1,665	\$1,830



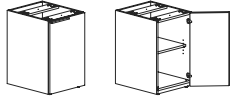
Features:

- use with other modular components, requires a modular top, see page 39
- pedestal front locking

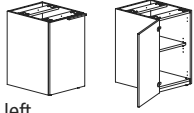
Options:

- must specify chassis grain direction on double cut veneer, see pages 13-15 for details
- veneer drawer fronts in paint available, specify paint color and add \$337 list; see page 16 for details
- on laminate units, contrasting fronts available, no upcharge; specify color, see page 16 for details
- ledge pulls standard; prism pulls available, specify and see page 9

Description	D	W	H	CTN WT	CU FT	① Model	HPL Laminate	Flat Cut Veneer	Double Cut Veneer
Modular Hinge Door	22	18	28	74	9	FLT2218-29FM7R	\$690		
Storage Pedestal	22	18	28	74	9	FLV2218-29FM7R		\$1,038	\$1,141
	22	18	28	74	9	FLT2218-29FM7L	\$690		
	22	18	28	74	9	FLV2218-29FM7L		\$1,038	\$1,141
	22	15 3/8	28	68	8	FLT2216-29FM7R	\$679		
	22	15 3/8	28	68	8	FLV2216-29FM7R		\$1,018	\$1,120
	22	15 3/8	28	68	8	FLT2216-29FM7L	\$679		
	22	15 3/8	28	68	8	FLV2216-29FM7L		\$1,018	\$1,120



right shown



left

Features:

- use with other modular components, requires a modular top, see page 39
- hinged door compartment has one adjustable shelf

Options:

- must specify chassis grain direction on double cut veneer, see pages 13-15 for details
- locking doors available, specify and add \$142 list
- veneer door fronts in paint available, specify paint color and add \$337 list; see page 16 for details
- on laminate units, contrasting fronts available, no upcharge; specify color, see page 16 for details
- ledge pulls standard; prism pulls available, specify and see page 9
- pull out trash can available, specify, add \$456 list; see page 38 for details

Modular Open Compartment	22	18	28	66	13	FLT2218-29FM0	\$629		
	22	18	28	66	13	FLV2218-29FM0		\$945	\$1,040



Features:

- use with other modular components, requires a modular top, see page 39
- compartment has one adjustable shelf

Options:

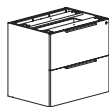
- must specify chassis grain direction on double cut veneer, see pages 13-15 for details

To Order, Specify:

① Laminate Model #	② Laminate Type	③ Laminate Selection	④ Metal Color	⑤ Other Product Options
Laminate (FLT)	HPL	See Laminate Selection	See Metal Finish Color Options	See list of options for each specific unit; Specify and add accordingly.

① Veneer Model #	② Wood Species	③ Wood Finish	④ Metal Color	⑤ Other Product Options	
Veneer (FLV)	Flat Cut CH1 Cherry MA1 Maple WA1 Walnut BO1 Black Oak	See Flat Cut Wood Finish Options	See Metal Finish Color Options	See list of options for each specific unit; Specify and add accordingly.	
	Double Cut DC1 Double Cut	<table border="1"> <thead> <tr> <th>ⓐ Wood Finish</th> <th>ⓑ Chassis Grain Direction</th> </tr> </thead> <tbody> <tr> <td>See Double Cut Wood Finish Options</td> <td>For Double Cut Only: Vertical Horizontal</td> </tr> </tbody> </table>			ⓐ Wood Finish
ⓐ Wood Finish	ⓑ Chassis Grain Direction				
See Double Cut Wood Finish Options	For Double Cut Only: Vertical Horizontal				

Description	D	W	H	CTN WT	CU FT	① Model	HPL Laminate	Flat Cut Veneer	Double Cut Veneer
Modular Lateral Credenza Pedestal	22	36	28	141	16	FLT2236-29FM4	\$1,358		
	22	36	28	141	16	FLV2236-29FM4		\$2,036	\$2,240
	22	30	28	128	14	FLT2230-29FM4	\$1,323		
	22	30	28	128	14	FLV2230-29FM4		\$1,985	\$2,186



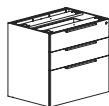
Features:

- use with other modular components, requires a modular top, see page 39
- pedestal front locking

Options:

- must specify chassis grain direction on double cut veneer, see pages 13-15 for details
- veneer drawer fronts in paint available, specify paint color and add \$337 list; see page 16 for details
- on laminate units, contrasting fronts available, no upcharge; specify color, see page 16 for details
- ledge pulls standard; prism pulls available, specify and see page 9

Modular Lateral Credenza Pedestal	22	36	28	141	16	FLT2236-29FM3	\$1,364		
	22	36	28	141	16	FLV2236-29FM3		\$2,047	\$2,252
	22	30	28	129	14	FLT2230-29FM3	\$1,329		
	22	30	28	129	14	FLV2230-29FM3		\$1,996	\$2,197



Features:

- use with other modular components, requires a modular top, see page 39
- pedestal front locking

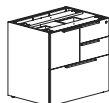
Options:

- must specify chassis grain direction on double cut veneer, see pages 13-15 for details
- veneer drawer fronts in paint available, specify paint color and add \$337 list; see page 16 for details
- on laminate units, contrasting fronts available, no upcharge; specify color, see page 16 for details
- ledge pulls standard; prism pulls available, specify and see page 9

Modular Credenza Multi-File Pedestal	22	30	28	138	14	FLT2230-29FMRM	\$1,438		
	22	30	28	138	14	FLV2230-29FMRM		\$2,160	\$2,376
	22	30	28	138	14	FLT2230-29FMLM	\$1,438		
	22	30	28	138	14	FLV2230-29FMLM		\$2,160	\$2,376



right shown



left

Features:

- use with other modular components, requires a modular top, see page 39
- pedestal front locking

Options:

- must specify chassis grain direction on double cut veneer, see pages 13-15 for details
- veneer drawer fronts in paint available, specify paint color and add \$337 list; see page 16 for details
- on laminate units, contrasting fronts available, no upcharge; specify color, see page 16 for details
- ledge pulls standard; prism pulls available, specify and see page 9

Modular Hinge Door Credenza Pedestal	22	36	28	122	16	FLT2236-29FM7	\$1,151		
	22	36	28	122	16	FLV2236-29FM7		\$1,728	\$1,898
	22	30	28	108	14	FLT2230-29FM7	\$1,104		
	22	30	28	108	14	FLV2230-29FM7		\$1,659	\$1,824



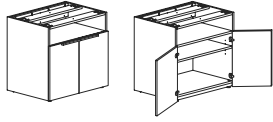
Features:

- use with other modular components, requires a modular top, see page 39
- hinged door compartment has one adjustable shelf

Options:

- must specify chassis grain direction on double cut veneer, see pages 13-15 for details
- locking doors available, specify and add \$142 list
- veneer door fronts in paint available, specify paint color and add \$337 list; see page 16 for details
- on laminate units, contrasting laminate door fronts available, no upcharge; specify laminate color, see page 16 for details
- ledge pulls standard; prism pulls available, specify and see page 9

Description	D	W	H	CTN WT	CU FT	① Model	HPL Laminate	Flat Cut Veneer	Double Cut Veneer
Modular Hinge Door with Open Shelf Credenza Pedestal	22	36	28	132	16	FLT2236-29FM8	\$1,168		
	22	36	28	132	16	FLV2236-29FM8		\$1,753	\$1,930
	22	30	28	116	14	FLT2230-29FM8	\$1,123		
	22	30	28	116	14	FLV2230-29FM8		\$1,688	\$1,856



Features:

- use with other modular components, requires a modular top, see page 39
- hinged door compartment has one adjustable shelf

Options:

- must specify chassis grain direction on double cut veneer, see pages 13-15 for details
- locking doors available, specify and add \$142 list
- veneer door fronts in paint available, specify paint color and add \$337 list; see page 16 for details
- on laminate units, contrasting laminate door fronts available, no upcharge; specify laminate color, see page 16 for details
- ledge pulls standard; prism pulls available, specify and see page 9

Modular Open Compartment	D	W	H	CTN WT	CU FT	Model	HPL Laminate	Flat Cut Veneer	Double Cut Veneer
	22	36	28	101	16	FLT2236-29FM0	\$1,019		
	22	36	28	101	16	FLV2236-29FM0		\$1,530	\$1,684
	22	30	28	91	14	FLT2230-29FM0	\$995		
	22	30	28	91	14	FLV2230-29FM0		\$1,493	\$1,642



Features:

- use with other modular components, requires a modular top, see page 39
- compartment has one adjustable shelf

Options:

- must specify chassis grain direction on double cut veneer, see pages 13-15 for details

To Order, Specify:

① Laminate Model #	② Laminate Type	③ Laminate Selection	④ Metal Color	⑤ Other Product Options
Laminate (FLT)	HPL	See Laminate Selection	See Metal Finish Color Options	See list of options for each specific unit; Specify and add accordingly.

① Veneer Model #	② Wood Species	③ Wood Finish	④ Metal Color	⑤ Other Product Options	
Veneer (FLV)	Flat Cut CH1 Cherry MA1 Maple WA1 Walnut BO1 Black Oak	See Flat Cut Wood Finish Options	See Metal Finish Color Options	See list of options for each specific unit; Specify and add accordingly.	
	Double Cut DC1 Double Cut	<table border="1"> <thead> <tr> <th>ⓐ Wood Finish</th> <th>ⓑ Chassis Grain Direction</th> </tr> </thead> <tbody> <tr> <td>See Double Cut Wood Finish Options</td> <td>For Double Cut Only: Vertical Horizontal</td> </tr> </tbody> </table>			ⓐ Wood Finish
ⓐ Wood Finish	ⓑ Chassis Grain Direction				
See Double Cut Wood Finish Options	For Double Cut Only: Vertical Horizontal				

Description	D	W	H	CTN WT	CU FT	① Model	HPL Laminate	Flat Cut Veneer	Double Cut Veneer
Modular Box/File Pedestal - Primary Height	22	18	28	85	9	FLT2218-29LM5	\$1,755		
	22	18	28	85	9	FLV2218-29LM5		\$2,278	\$2,506



Features:

- must be connected to another unit with a common top, this unit is not freestanding
- pedestal front locking

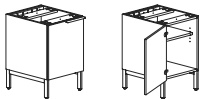
Options:

- must specify chassis grain direction on double cut veneer, see pages 13-15 for details
- veneer drawer fronts in paint available, specify paint color and add \$337 list; see page 16 for details
- on laminate units, contrasting fronts available, no upcharge; specify color, see page 16 for details
- ledge pulls standard; prism pulls available, specify and see page 9

Modular Single Door Storage Pedestal - Primary Height	22	18	28	72	9	FLT2218-29LM7R	\$1,575		
	22	18	28	72	9	FLV2218-29LM7R		\$2,043	\$2,247
	22	18	28	72	9	FLT2218-29LM7L	\$1,575		
	22	18	28	72	9	FLV2218-29LM7L		\$2,043	\$2,247



right shown



left

Features:

- must be connected to another unit with a common top, this unit is not freestanding

Options:

- must specify chassis grain direction on double cut veneer, see pages 13-15 for details
- locking door available, specify and add \$142 list
- veneer door fronts in paint available, specify paint color and add \$337 list; see page 16 for details
- on laminate units, contrasting laminate door fronts available, no upcharge; specify laminate color, see page 16 for details
- ledge pulls standard; prism pulls available, specify and see page 9

Modular Open Compartment - Primary Height	22	18	28	66	13	FLT2218-29LM0	\$1,513		
	22	18	28	66	13	FLV2218-29LM0		\$1,950	\$2,145



Features:

- use with other modular components, requires a modular top, see page 39
- open compartment with adjustable shelf

Options:

- must specify chassis grain direction on double cut veneer, see pages 13-15 for details

Modular Box/Lateral File - Primary Height	22	36	28	129	16	FLT2236-29LM6	\$2,043		
	22	36	28	129	16	FLV2236-29LM6		\$2,651	\$2,917
	22	30	28	125	14	FLT2230-29LM6	\$1,983		
	22	30	28	125	14	FLV2230-29LM6		\$2,573	\$2,832



Features:

- must be connected to another unit with a common top, this unit is not freestanding
- pedestal front locking

Options:

- must specify chassis grain direction on double cut veneer, see pages 13-15 for details
- veneer drawer fronts in paint available, specify paint color and add \$337 list; see page 16 for details
- on laminate units, contrasting fronts available, no upcharge; specify color, see page 16 for details
- ledge pulls standard; prism pulls available, specify and see page 9

Modular Hidden Drawer Pedestal - Primary Height	22	36	28	131	16	FLT2236-29LMB	\$2,280		
	22	36	28	131	16	FLV2236-29LMB		\$2,958	\$3,256
	22	30	28	121	14	FLT2230-29LMB	\$2,221		
	22	30	28	121	14	FLV2230-29LMB		\$2,881	\$3,171




Features:

- must be connected to another unit with a common top, this unit is not freestanding
- pedestal front locking
- concealed box drawer

Options:

- must specify chassis grain direction on double cut veneer, see pages 13-15 for details
- veneer drawer fronts in paint available, specify paint color and add \$337 list; see page 16 for details
- on laminate units, contrasting fronts available, no upcharge; specify color, see page 16 for details
- ledge pulls standard; prism pulls available, specify and see page 9


Description	D	W	H	CTN WT	CU FT	① Model	HPL Laminate	Flat Cut Veneer	Double Cut Veneer
	22	36	28	114	16	FLT2236-29LM7	\$1,774		
	22	36	28	114	16	FLV2236-29LM7		\$2,303	\$2,531
	22	30	28	103	14	FLT2230-29LM7	\$1,732		
	22	30	28	103	14	FLV2230-29LM7		\$2,244	\$2,470

Features:

- use with other modular components, requires a modular top, see page 39
- hinged door compartment has one adjustable shelf

Options:

- must specify chassis grain direction on double cut veneer, see pages 13-15 for details
- locking doors available, specify and add \$142 list
- veneer door fronts in paint available, specify paint color and add \$337 list; see page 16 for details
- on laminate units, contrasting laminate door fronts available, no upcharge; specify laminate color, see page 16 for details
- ledge pulls standard; prism pulls available, specify and see page 9


	22	36	28	109	16	FLT2236-29LM8	\$1,796		
	22	36	28	109	16	FLV2236-29LM8		\$2,331	\$2,565
	22	30	28	99	14	FLT2230-29LM8	\$1,752		
	22	30	28	99	14	FLV2230-29LM8		\$2,274	\$2,501

Features:

- must be connected to another unit with a common top, this unit is not freestanding
- hinged door compartment has one adjustable shelf

Options:

- must specify chassis grain direction on double cut veneer, see pages 13-15 for details
- locking doors available, specify and add \$142 list
- veneer door fronts in paint available, specify paint color and add \$337 list; see page 16 for details
- on laminate units, contrasting laminate door fronts available, no upcharge; specify laminate color, see page 16 for details
- ledge pulls standard; prism pulls available, specify and see page 9

	22	36	28	99	16	FLT2236-29LM0	\$1,631		
	22	36	28	99	16	FLV2236-29LM0		\$2,117	\$2,330
	22	30	28	91	14	FLT2230-29LM0	\$1,592		
	22	30	28	91	14	FLV2230-29LM0		\$2,067	\$2,274

Features:

- use with other modular components, requires a modular top, see page 39
- open compartment with adjustable shelf

Options:

- must specify chassis grain direction on double cut veneer, see pages 13-15 for details

To Order, Specify:

① Laminate Model #	② Laminate Type	③ Laminate Selection	④ Metal Color	⑤ Other Product Options
Laminate (FLT)	HPL	See Laminate Selection	See Metal Finish Color Options	See list of options for each specific unit; Specify and add accordingly.

① Veneer Model #	② Wood Species	③ Wood Finish	④ Metal Color	⑤ Other Product Options
Veneer (FLV)	Flat Cut CH1 Cherry MA1 Maple WA1 Walnut BO1 Black Oak	See Flat Cut Wood Finish Options	See Metal Finish Color Options	See list of options for each specific unit; Specify and add accordingly.
	Double Cut DC1 Double Cut	③a Wood Finish See Double Cut Wood Finish Options		

Description	D	W	H	CTN WT	CU FT	① Model	HPL Laminate	Flat Cut Veneer	Double Cut Veneer
Modular Credenza Wing End Support for Primary Height Units	22	18	28	43	9	FLT2218WEAR	\$595		
	22	18	28	43	9	FLV2218WEAR		\$891	\$979
	22	18	28	43	9	FLT2218WEAL	\$595		
	22	18	28	43	9	FLV2218WEAL		\$891	\$979
	22	15 $\frac{5}{8}$	28	40	8	FLT2216WEAR	\$585		
	22	15 $\frac{5}{8}$	28	40	8	FLV2216WEAR		\$879	\$967
	22	15 $\frac{5}{8}$	28	40	8	FLT2216WEAL	\$585		
	22	15 $\frac{5}{8}$	28	40	8	FLV2216WEAL		\$879	\$967



right shown



left

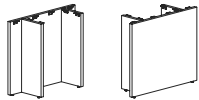
Features:

- use with other modular components, requires a modular top, see page 39

Options:

- must specify chassis grain direction on double cut veneer, see pages 13-15 for details

Description	D	W	H	CTN WT	CU FT	① Model	HPL Laminate	Flat Cut Veneer	Double Cut Veneer
Modular Desk T-Support for Secondary Height Units	33 $\frac{1}{4}$	11 $\frac{3}{16}$	28	48	9	FLT3428-MDTS	\$775		
	33 $\frac{1}{4}$	11 $\frac{3}{16}$	28	48	9	FLV3428-MDTS		\$1,007	\$1,105
	27 $\frac{1}{4}$	11 $\frac{3}{16}$	28	41	7	FLT2828-MDTS	\$672		
	27 $\frac{1}{4}$	11 $\frac{3}{16}$	28	41	7	FLV2828-MDTS		\$873	\$959
	21 $\frac{3}{4}$	11 $\frac{3}{16}$	28	31	6	FLT2228-MDTS	\$646		
	21 $\frac{3}{4}$	11 $\frac{3}{16}$	28	31	6	FLV2228-MDTS		\$838	\$924



Features:

- use with other modular components, requires a modular top, see page 39

Options:

- must specify chassis grain direction on double cut veneer, see pages 13-15 for details

Description	D	W	H	CTN WT	CU FT	① Model	HPL Laminate	Flat Cut Veneer	Double Cut Veneer
Modular Desk T-Support for Secondary Height Units	33 $\frac{1}{4}$	11 $\frac{3}{16}$	6 $\frac{3}{16}$	19	3	FLT3407-MDTS	\$561		
	33 $\frac{1}{4}$	11 $\frac{3}{16}$	6 $\frac{3}{16}$	19	3	FLV3407-MDTS		\$727	\$800
	27 $\frac{1}{4}$	11 $\frac{3}{16}$	6 $\frac{3}{16}$	16	2	FLT2807-MDTS	\$538		
	27 $\frac{1}{4}$	11 $\frac{3}{16}$	6 $\frac{3}{16}$	16	2	FLV2807-MDTS		\$701	\$770
	21 $\frac{3}{4}$	11 $\frac{3}{16}$	6 $\frac{3}{16}$	12	2	FLT2207-MDTS	\$519		
	21 $\frac{3}{4}$	11 $\frac{3}{16}$	6 $\frac{3}{16}$	12	2	FLV2207-MDTS		\$674	\$741

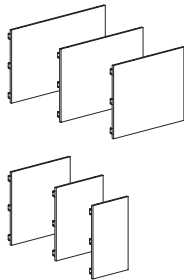


Features:

- use with other modular components, requires a modular top, see page 39

Options:

- must specify chassis grain direction on double cut veneer, see pages 13-15 for details

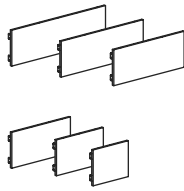
Description	D	W	H	CTN WT	CU FT	① Model	HPL Laminate	Flat Cut Veneer	Double Cut Veneer
Modular Credenza Full Modesty Panel for Primary Height Modular Units 	¾	47 7/8	28	35	3	FLT2848MCFA	\$405		
	¾	47 7/8	28	35	3	FLV2848MCFA		\$605	\$666
	¾	41 7/8	28	32	3	FLT2842MCFA	\$351		
	¾	41 7/8	28	32	3	FLV2842MCFA		\$524	\$578
	¾	35 7/8	28	28	2	FLT2836MCFA	\$325		
	¾	35 7/8	28	28	2	FLV2836MCFA		\$486	\$536
	¾	29 7/8	28	24	2	FLT2830MCFA	\$300		
	¾	29 7/8	28	24	2	FLV2830MCFA		\$449	\$494
	¾	23 7/8	28	20	2	FLT2824MCFA	\$293		
	¾	23 7/8	28	20	2	FLV2824MCFA		\$436	\$481
	¾	17 7/8	28	18	2	FLT2818MCFA	\$290		
	¾	17 7/8	28	18	2	FLV2818MCFA		\$432	\$475

Features:

- use with other modular components, requires a modular top, see page 39

Options:

- must specify chassis grain direction on double cut veneer, see pages 13-15 for details

Description	D	W	H	CTN WT	CU FT	① Model	HPL Laminate	Flat Cut Veneer	Double Cut Veneer
Modular Credenza Partial Modesty Panel for Primary Height Modular Units 	¾	47 7/8	12	21	2	FLT2848MCPA	\$405		
	¾	47 7/8	12	21	2	FLV2848MCPA		\$605	\$666
	¾	41 7/8	12	19	2	FLT2842MCPA	\$351		
	¾	41 7/8	12	19	2	FLV2842MCPA		\$524	\$578
	¾	35 7/8	12	17	1	FLT2836MCPA	\$325		
	¾	35 7/8	12	17	1	FLV2836MCPA		\$486	\$536
	¾	29 7/8	12	15	1	FLT2830MCPA	\$300		
	¾	29 7/8	12	15	1	FLV2830MCPA		\$449	\$494
	¾	23 7/8	12	13	1	FLT2824MCPA	\$293		
	¾	23 7/8	12	13	1	FLV2824MCPA		\$436	\$481
	¾	17 7/8	12	11	1	FLT2818MCPA	\$290		
	¾	17 7/8	12	11	1	FLV2818MCPA		\$432	\$475

Features:

- use with other modular components, requires a modular top, see page 39

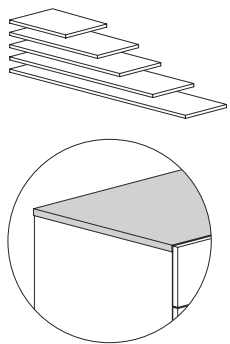
Options:

- must specify chassis grain direction on double cut veneer, see pages 13-15 for details

To Order, Specify:

① Laminate Model #	② Laminate Type	③ Laminate Selection	④ Metal Color	⑤ Other Product Options
Laminate (FLT)	HPL	See Laminate Selection	See Metal Finish Color Options	See list of options for each specific unit; Specify and add accordingly.

① Veneer Model #	② Wood Species	③ Wood Finish	④ Metal Color	⑤ Other Product Options
Veneer (FLV)	Flat Cut CH1 Cherry MA1 Maple WA1 Walnut BO1 Black Oak	See Flat Cut Wood Finish Options	See Metal Finish Color Options	See list of options for each specific unit; Specify and add accordingly.
	Double Cut DC1 Double Cut	ⓐ Wood Finish See Double Cut Wood Finish Options		

Description	D	W	H	CTN WT	CU FT	① Model	HPL Laminate	Flat Cut Veneer	Double Cut Veneer
Modular Credenza Top for Secondary Height	21 1/8	108	3/4	57	5	FLT21108MCT	\$648		
	21 1/8	108	3/4	57	5	FLV21108MCT		\$837	\$921
	21 1/8	102	3/4	54	4	FLT21102MCT	\$610		
	21 1/8	102	3/4	54	4	FLV21102MCT		\$792	\$871
	21 1/8	96	3/4	51	4	FLT2196MCT	\$577		
	21 1/8	96	3/4	51	4	FLV2196MCT		\$743	\$817
	21 1/8	90	3/4	48	4	FLT2190MCT	\$541		
	21 1/8	90	3/4	48	4	FLV2190MCT		\$697	\$768
	21 1/8	84	3/4	45	4	FLT2184MCT	\$505		
	21 1/8	84	3/4	45	4	FLV2184MCT		\$651	\$718
	21 1/8	78	3/4	43	3	FLT2178MCT	\$469		
	21 1/8	78	3/4	43	3	FLV2178MCT		\$605	\$666
	21 1/8	72	3/4	40	3	FLT2172MCT	\$432		
	21 1/8	72	3/4	40	3	FLV2172MCT		\$558	\$615
	21 1/8	66	3/4	37	3	FLT2166MCT	\$398		
	21 1/8	66	3/4	37	3	FLV2166MCT		\$514	\$563
	21 1/8	60	3/4	34	3	FLT2160MCT	\$360		
	21 1/8	60	3/4	34	3	FLV2160MCT		\$466	\$514
	21 1/8	54	3/4	31	3	FLT2154MCT	\$325		
	21 1/8	54	3/4	31	3	FLV2154MCT		\$421	\$463
	21 1/8	48	3/4	28	2	FLT2148MCT	\$290		
	21 1/8	48	3/4	28	2	FLV2148MCT		\$375	\$412
	21 1/8	42	3/4	25	2	FLT2142MCT	\$254		
	21 1/8	42	3/4	25	2	FLV2142MCT		\$327	\$360
	21 1/8	36	3/4	23	2	FLT2136MCT	\$217		
	21 1/8	36	3/4	23	2	FLV2136MCT		\$281	\$310
	21 1/8	30	3/4	20	2	FLT2130MCT	\$211		
	21 1/8	30	3/4	20	2	FLV2130MCT		\$272	\$298
	21 1/8	18	3/4	14	1	FLT2118MCT	\$203		
	21 1/8	18	3/4	14	1	FLV2118MCT		\$261	\$286

Features:

- use with secondary height modular components; designed to fit behind drawer fronts and door fronts
- eased edge profile user side

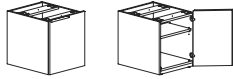
Description	D	W	H	CTN WT	CU FT	① Model	HPL Laminate	Flat Cut Veneer	Double Cut Veneer
Modular Box/File Pedestal - Secondary Height	22	18	21	69	7	FLT2218-21FM5	\$825		
	22	18	21	69	7	FLV2218-21FM5		\$1,152	\$1,265



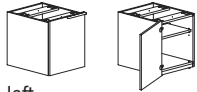
Options:

- must specify chassis grain direction on double cut veneer, see pages 13-15 for details
- veneer drawer fronts in paint available, specify paint color and add \$337 list; see page 16 for details
- on laminate units, contrasting fronts available, no upcharge; specify color, see page 16 for details
- ledge pulls standard; prism pulls available, specify and see page 9

Modular Single Door Storage Pedestal - Secondary Height	22	18	21	59	7	FLT2218-21FM7R	\$633		
	22	18	21	59	7	FLV2218-21FM7R		\$883	\$971
	22	18	21	59	7	FLT2218-21FM7L	\$633		
	22	18	21	59	7	FLV2218-21FM7L		\$883	\$971



right shown



left

Features:

- use with other modular components, requires a modular top, see page 39
- hinged door compartment has one adjustable shelf

Options:

- must specify chassis grain direction on double cut veneer, see pages 13-15 for details
- locking door available, specify and add \$142 list
- veneer door fronts in paint available, specify paint color and add \$337 list; see page 16 for details
- on laminate units, contrasting laminate door fronts available, no upcharge; specify laminate color, see page 16 for details
- ledge pulls standard; prism pulls available, specify and see page 9

Modular Open Compartment	22	18	21	54	10	FLT2218-21FM0	\$565		
	22	18	21	54	10	FLV2218-21FM0		\$789	\$866



Features:

- use with other modular components, requires a modular top, see page 39
- open compartment with adjustable shelf

Options:

- must specify chassis grain direction on double cut veneer, see pages 13-15 for details

To Order, Specify:

① Laminate Model #	② Laminate Type	③ Laminate Selection	④ Metal Color	⑤ Other Product Options
Laminate (FLT)	HPL	See Laminate Selection	See Metal Finish Color Options	See list of options for each specific unit; Specify and add accordingly.

① Veneer Model #	② Wood Species	③ Wood Finish	④ Metal Color	⑤ Other Product Options	
Veneer (FLV)	Flat Cut CH1 Cherry MA1 Maple WA1 Walnut BO1 Black Oak	See Flat Cut Wood Finish Options	See Metal Finish Color Options	See list of options for each specific unit; Specify and add accordingly.	
	Double Cut DC1 Double Cut	<table border="1"> <thead> <tr> <th>ⓐ Wood Finish</th> <th>ⓑ Chassis Grain Direction</th> </tr> </thead> <tbody> <tr> <td>See Double Cut Wood Finish Options</td> <td>For Double Cut Only: Vertical Horizontal</td> </tr> </tbody> </table>			ⓐ Wood Finish
ⓐ Wood Finish	ⓑ Chassis Grain Direction				
See Double Cut Wood Finish Options	For Double Cut Only: Vertical Horizontal				

Description	D	W	H	CTN WT	CU FT	① Model	HPL Laminate	Flat Cut Veneer	Double Cut Veneer
Modular Box/Lateral File - Secondary Height	22	36	21	131	13	FLT2236-21FM6	\$1,068		
	22	36	21	131	13	FLV2236-21FM6		\$1,489	\$1,637
	22	30	21	116	11	FLT2230-21FM6	\$1,041		
	22	30	21	116	11	FLV2230-21FM6		\$1,452	\$1,598



Features:

- use with other modular components, requires a modular top, see page 39
- must specify chassis grain direction on double cut veneer, see pages 13-15 for details
- pedestal front locking

Options:

- ledge pulls standard; prism pulls available, specify and see page 9
- veneer drawer fronts in paint available, specify paint color and add \$337 list; see page 16 for details
- on laminate units, contrasting fronts available, no upcharge; specify color, see page 16 for details

Modular Hidden Drawer Pedestal - Secondary Height	22	36	21	134	13	FLT2236-21FMB	\$1,295		
	22	36	21	134	13	FLV2236-21FMB		\$1,806	\$1,985
	22	30	21	118	11	FLT2230-21FMB	\$1,261		
	22	30	21	118	11	FLV2230-21FMB		\$1,760	\$1,938



Features:

- use with other modular components, requires a modular top, see page 39
- pedestal front locking

Options:

- must specify chassis grain direction on double cut veneer, see pages 13-15 for details
- veneer drawer fronts in paint available, specify paint color and add \$337 list; see page 16 for details
- on laminate units, contrasting fronts available, no upcharge; specify color, see page 16 for details
- ledge pulls standard; prism pulls available, specify and see page 9

Modular Two Door Pedestal - Secondary Height	22	36	21	116	13	FLT2236-21FM7	\$1,084		
	22	36	21	116	13	FLV2236-21FM7		\$1,513	\$1,665
	22	30	21	105	11	FLT2230-21FM7	\$1,063		
	22	30	21	105	11	FLV2230-21FM7		\$1,483	\$1,630



Features:

- use with other modular components, requires a modular top, see page 39
- hinged door compartment has one adjustable shelf

Options:

- must specify chassis grain direction on double cut veneer, see pages 13-15 for details
- locking doors available, specify and add \$142 list
- veneer door fronts in paint available, specify paint color and add \$337 list; see page 16 for details
- on laminate units, contrasting fronts available, no upcharge; specify color, see page 16 for details
- ledge pulls standard; prism pulls available, specify and see page 9

Modular Storage Pedestal with Open Center Shelf - Secondary Height	22	36	21	116	13	FLT2236-21FM8	\$1,111		
	22	36	21	116	13	FLV2236-21FM8		\$1,549	\$1,703
	22	30	21	105	11	FLT2230-21FM8	\$1,084		
	22	30	21	105	11	FLV2230-21FM8		\$1,512	\$1,664




Features:

- use with other modular components, requires a modular top, see page 39

Options:

- must specify chassis grain direction on double cut veneer, see pages 13-15 for details
- locking doors available, specify and add \$142 list
- veneer door fronts in paint available, specify paint color and add \$337 list; see page 16 for details
- on laminate units, contrasting laminate door fronts available, no upcharge; specify laminate color, see page 16 for details
- ledge pulls standard; prism pulls available, specify and see page 9



Description	D	W	H	CTN WT	CU FT	① Model	HPL Laminate	Flat Cut Veneer	Double Cut Veneer
	22	36	21	99	13	FLT2236-21FM0	\$980		
	22	36	21	99	13	FLV2236-21FM0		\$1,369	\$1,506
	22	30	21	90	11	FLT2230-21FM0	\$958		
	22	30	21	90	11	FLV2230-21FM0		\$1,337	\$1,471

Features:

- use with other modular components, requires a modular top, see page 39
- open compartment with adjustable shelf

Options:

- must specify chassis grain direction on double cut veneer, see pages 13-15 for details


Description	D	W	H	CTN WT	CU FT	① Model	HPL Laminate	Flat Cut Veneer	Double Cut Veneer
 <p>*OE shown</p>  <p>*EO</p>	22	36	21	106	13	FLT2236-21FME0	\$1,379		
	22	36	21	106	13	FLV2236-21FME0		\$1,926	\$2,117
	22	36	21	106	13	FLT2236-21FM0E	\$1,379		
	22	36	21	106	13	FLV2236-21FM0E		\$1,926	\$2,117
	22	30	21	94	11	FLT2230-21FME0	\$1,346		
	22	30	21	94	11	FLV2230-21FME0		\$1,879	\$2,067
	22	30	21	94	11	FLT2230-21FM0E	\$1,346		
22	30	21	94	11	FLV2230-21FM0E		\$1,879	\$2,067	

Features:

- square edge on top
- electrical power unit - EC26 included, specify color
- open compartment with adjustable shelf
- shelf 12 1/2"d

Options:

- must specify chassis grain direction on double cut veneer, see pages 13-15 for details
- oval grommet in back panel can be eliminated upon request, no upcharge

Description	D	W	H	CTN WT	CU FT	① Model	List Price
	2	67	3/4	5	1	GP0267SB	\$112
	2	61	3/4	5	1	GP0261SB	\$100
	2	55	3/4	4	1	GP0255SB	\$94
	2	49	3/4	4	1	GP0249SB	\$85
	2	43	3/4	3	1	GP0243SB	\$80

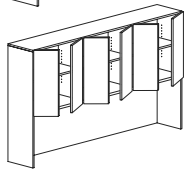
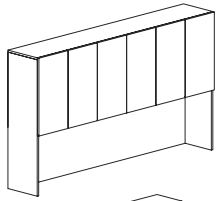
- required when worksurfaces unsupported span is greater than 48"
- black metal
- includes screws for attachment to worksurfaces 1" thick and greater

To Order, Specify:

① Laminate Model #	② Laminate Type	③ Laminate Selection	④ Metal Color	⑤ Other Product Options
Laminate (FLT)	HPL	See Laminate Selection	See Metal Finish Color Options	See list of options for each specific unit; Specify and add accordingly.

① Veneer Model #	② Wood Species	③ Wood Finish	④ Metal Color	⑤ Other Product Options
Veneer (FLV)	Flat Cut CH1 Cherry MA1 Maple WA1 Walnut BO1 Black Oak	See Flat Cut Wood Finish Options	See Metal Finish Color Options	See list of options for each specific unit; Specify and add accordingly.
	Double Cut DC1 Double Cut	3a Wood Finish See Double Cut Wood Finish Options 3b Chassis Grain Direction For Double Cut Only: Vertical Horizontal		

Description	D	W	H	CTN WT	CU FT	① Model	Laminate	Flat Cut Veneer	Double Cut Veneer
Double Height Overhead Cabinet with Six Doors	15 $\frac{7}{8}$ "	95 $\frac{7}{8}$ "	52	323	55	FLT1696-52S0	\$2,805		
	15 $\frac{7}{8}$ "	95 $\frac{7}{8}$ "	52	323	55	FLV1696-52S0		\$4,749	\$5,226
	15 $\frac{7}{8}$ "	89 $\frac{7}{8}$ "	52	306	52	FLT1690-52S0	\$2,635		
	15 $\frac{7}{8}$ "	89 $\frac{7}{8}$ "	52	306	52	FLV1690-52S0		\$4,462	\$4,908
	15 $\frac{7}{8}$ "	83 $\frac{7}{8}$ "	52	289	48	FLT1684-52S0	\$2,460		
	15 $\frac{7}{8}$ "	83 $\frac{7}{8}$ "	52	289	48	FLV1684-52S0		\$4,167	\$4,584

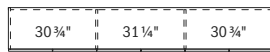


Features:

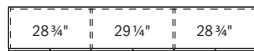
- use with primary height units, fastening hardware included
- backside of unit intended to go against wall, cabinet should be secured to wall as a safety precaution
- laminate grain direction runs horizontal on back panel of overhead cabinets
- ¼" overhang at the bottom of the door allows access
- 22¾" vertical clearance between worksurface and bottom of door, excluding task light
- two ⅝" dia. holes in upper corners of back panel for task light wiring access
- exterior back panel unfinished
- adjustable shelves

Options:

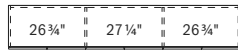
- must specify chassis grain direction on double cut veneer, see pages 13-15 for details
- veneer door fronts in paint available, specify paint color and add \$337 list; see page 16 for details
- on laminate units, contrasting laminate door fronts available, no upcharge; specify laminate color, see page 16 for details
- white glass doors with aluminum trim available, specify and add \$4,488 list for 96"w, \$4,299 list for 90"w, \$4,137 list for 84"w; see page 33 for details
- markerboard laminate doors available, specify and add \$1,144 list; see page 33 for details
- locking doors available, specify and add \$426 list (not available on glass doors)
- tackboard or markerboard available, see pages 292-295
- tasklights available, see page 455



96" wide



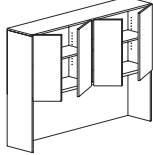
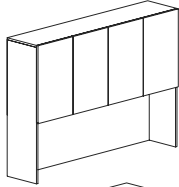
90" wide



84" wide

FLUX - PRIVATE OFFICE

Description	D	W	H	CTN WT	CU FT	① Model	Laminate	Flat Cut Veneer	Double Cut Veneer
Double Height Overhead Cabinet with Four Doors	15 7/8	77 7/8	52	264	45	FLT1678-52SO	\$2,294		
	15 7/8	77 7/8	52	264	45	FLV1678-52SO		\$3,758	\$4,134
	15 7/8	71 7/8	52	247	42	FLT1672-52SO	\$2,161		
	15 7/8	71 7/8	52	247	42	FLV1672-52SO		\$3,540	\$3,893
	15 7/8	65 7/8	52	235	38	FLT1666-52SO	\$2,042		
	15 7/8	65 7/8	52	235	38	FLV1666-52SO		\$3,345	\$3,679
	15 7/8	59 7/8	52	218	35	FLT1660-52SO	\$1,953		
	15 7/8	59 7/8	52	218	35	FLV1660-52SO		\$3,198	\$3,518



78" wide



72" wide



66" wide



60" wide

Features:

- use with primary height units, fastening hardware included
- backside of unit intended to go against wall, cabinet should be secured to wall as a safety precaution
- laminate grain direction runs horizontal on back panel of overhead cabinets
- 1/4" overhang at the bottom of the door allows access
- 22 3/4" vertical clearance between worksurface and bottom of door, excluding task light
- two 5/8" dia. holes in upper corners of back panel for task light wiring access
- exterior back panel unfinished
- adjustable shelves

Options:

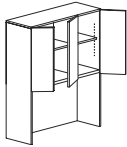
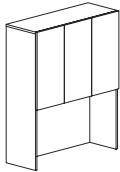
- must specify chassis grain direction on double cut veneer, see pages 13-15 for details
- veneer door fronts in paint available, specify paint color and add \$337 list; see page 16 for details
- on laminate units, contrasting laminate door fronts available, no upcharge; specify laminate color, see page 16 for details
- white glass doors with aluminum trim available, specify and add \$3,437 list for 78"w, \$3,247 list for 72"w, \$3,058 list for 66"w, \$2,869 list for 60"w; see page 33 for details
- markerboard laminate doors available, specify and add \$763 list; see page 33 for details
- locking doors available, specify and add \$284 list (not available on glass doors)
- tackboard or markerboard available, see pages 292-295
- tasklights available, see page 455

To Order, Specify:

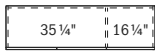
① Laminate Model #	② Laminate Selection		③ Metal Color	④ Other Product Options
Laminate (FLT)	See Laminate Selection		See Metal Finish Color Options	See list of options for each specific unit; Specify and add accordingly.

① Veneer Model #	② Wood Species	③ Wood Finish		④ Metal Color	⑤ Other Product Options
Veneer (FLV)	Flat Cut CH1 Cherry MA1 Maple WA1 Walnut BO1 Black Oak	See Flat Cut Wood Finish Options		See Metal Finish Color Options	See list of options for each specific unit; Specify and add accordingly.
		3a Wood Finish	3b Chassis Grain Direction		
	Double Cut DC1 Double Cut	See Double Cut Wood Finish Options	For Double Cut Only: Vertical Horizontal		

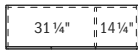
Description	D	W	H	CTN WT	CU FT	① Model	Laminate	Flat Cut Veneer	Double Cut Veneer
Double Height Overhead Cabinet with Three Doors	15 $\frac{7}{8}$ "	53 $\frac{7}{8}$ "	52"	200	32	FLT1654-52SOR	\$1,910		
	15 $\frac{7}{8}$ "	53 $\frac{7}{8}$ "	52"	200	32	FLV1654-52SOR		\$3,077	\$3,384
	15 $\frac{7}{8}$ "	53 $\frac{7}{8}$ "	52"	200	32	FLT1654-52SOL	\$1,910		
	15 $\frac{7}{8}$ "	53 $\frac{7}{8}$ "	52"	200	32	FLV1654-52SOL		\$3,077	\$3,384
	15 $\frac{7}{8}$ "	47 $\frac{7}{8}$ "	52"	183	28	FLT1648-52SOR	\$1,845		
	15 $\frac{7}{8}$ "	47 $\frac{7}{8}$ "	52"	183	28	FLV1648-52SOR		\$2,972	\$3,268
	15 $\frac{7}{8}$ "	47 $\frac{7}{8}$ "	52"	183	28	FLT1648-52SOL	\$1,845		
	15 $\frac{7}{8}$ "	47 $\frac{7}{8}$ "	52"	183	28	FLV1648-52SOL		\$2,972	\$3,268
	15 $\frac{7}{8}$ "	41 $\frac{7}{8}$ "	52"	165	25	FLT1642-52SOR	\$1,785		
	15 $\frac{7}{8}$ "	41 $\frac{7}{8}$ "	52"	165	25	FLV1642-52SOR		\$2,875	\$3,163
	15 $\frac{7}{8}$ "	41 $\frac{7}{8}$ "	52"	165	25	FLT1642-52SOL	\$1,785		
	15 $\frac{7}{8}$ "	41 $\frac{7}{8}$ "	52"	165	25	FLV1642-52SOL		\$2,875	\$3,163



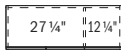
right shown



54" wide



48" wide



42" wide

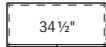
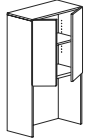
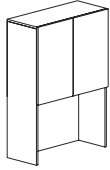
Features:

- use with primary height units, fastening hardware included
- backside of unit intended to go against wall, cabinet should be secured to wall as a safety precaution
- laminate grain direction runs horizontal on back panel of overhead cabinets
- 1/4" overhang at the bottom of the door allows access
- 22 3/4" vertical clearance between worksurface and bottom of door, excluding task light
- two 5/8" dia. holes in upper corners of back panel for task light wiring access
- exterior back panel unfinished
- adjustable shelves

Options:

- must specify chassis grain direction on double cut veneer, see pages 13-15 for details
- veneer door fronts in paint available, specify paint color and add \$337 list; see page 16 for details
- on laminate units, contrasting laminate door fronts available, no upcharge; specify laminate color, see page 16 for details
- white glass doors with aluminum trim available, specify and add \$2,436 list for 54"w, \$2,246 list for 48"w, \$2,058 list for 42"w; see page 33 for details
- markerboard laminate doors available, specify and add \$574 list; see page 33 for details
- locking doors available, specify and add \$284 list (not available on glass doors)
- tackboard or markerboard available, see pages 292-295
- tasklights available, see page 455

Description	D	W	H	CTN WT	CU FT	① Model	Laminate	Flat Cut Veneer	Double Cut Veneer
Double Height Overhead Cabinet with Two Doors	15 7/8	35 7/8	52	137	22	FLT1636-52SO	\$1,694		
	15 7/8	35 7/8	52	137	22	FLV1636-52SO		\$2,726	\$3,000
	15 7/8	29 7/8	52	120	18	FLT1630-52SO	\$1,622		
	15 7/8	29 7/8	52	120	18	FLV1630-52SO		\$2,612	\$2,874



36" wide



30" wide

Features:

- use with primary height units, fastening hardware included
- backside of unit intended to go against wall, cabinet should be secured to wall as a safety precaution
- laminate grain direction runs horizontal on back panel of overhead cabinets
- 1/4" overhang at the bottom of the door allows access
- 22 3/4" vertical clearance between worksurface and bottom of door, excluding task light
- two 5/8" dia. holes in upper corners of back panel for task light wiring access
- exterior back panel unfinished
- adjustable shelf

Options:

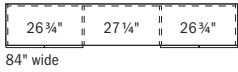
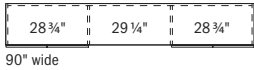
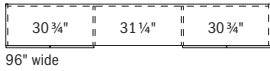
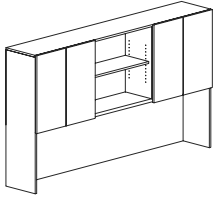
- must specify chassis grain direction on double cut veneer, see pages 13-15 for details
- veneer door fronts in paint available, specify paint color and add \$337 list; see page 16 for details
- on laminate units, contrasting laminate door fronts available, no upcharge; specify laminate color, see page 16 for details
- white glass doors with aluminum trim available, specify and add \$1,626 list for 36"w, \$1,437 list for 30"w; see page 33 for details
- markerboard laminate doors available, specify and add \$385 list; see page 33 for details
- locking doors available, specify and add \$142 list (not available on glass doors)
- tackboard or markerboard available, see pages 292-295
- task lights available, see page 455

To Order, Specify:

① Laminate Model #	② Laminate Selection	③ Metal Color	④ Other Product Options
Laminate (FLT)	See Laminate Selection	See Metal Finish Color Options	See list of options for each specific unit; Specify and add accordingly.

① Veneer Model #	② Wood Species	③ Wood Finish	④ Metal Color	⑤ Other Product Options
Veneer (FLV)	Flat Cut CH1 Cherry MA1 Maple WA1 Walnut BO1 Black Oak	See Flat Cut Wood Finish Options	See Metal Finish Color Options	See list of options for each specific unit; Specify and add accordingly.
		<table border="1"> <thead> <tr> <th>③a Wood Finish</th> <th>③b Chassis Grain Direction</th> </tr> </thead> <tbody> <tr> <td>See Double Cut Wood Finish Options</td> <td>For Double Cut Only: Vertical Horizontal</td> </tr> </tbody> </table>		
③a Wood Finish	③b Chassis Grain Direction			
See Double Cut Wood Finish Options	For Double Cut Only: Vertical Horizontal			

Description	D	W	H	CTN WT	CU FT	① Model	Laminate	Flat Cut Veneer	Double Cut Veneer
Double Height Overhead Cabinet with Four Doors and Open Center	15 7/8"	95 7/8"	52"	303	55	FLT1696-52SMO	\$2,665		
	15 7/8"	95 7/8"	52"	303	55	FLV1696-52SMO		\$4,514	\$4,965
	15 7/8"	89 7/8"	52"	287	52	FLT1690-52SMO	\$2,503		
	15 7/8"	89 7/8"	52"	287	52	FLV1690-52SMO		\$4,240	\$4,663
	15 7/8"	83 7/8"	52"	271	48	FLT1684-52SMO	\$2,341		
	15 7/8"	83 7/8"	52"	271	48	FLV1684-52SMO		\$3,960	\$4,357



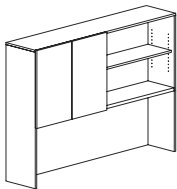
Features:

- use with primary height units, fastening hardware included
- backside of unit intended to go against wall, cabinet should be secured to wall as a safety precaution
- laminate grain direction runs horizontal on back panel of overhead cabinets
- 1/4" overhang at the bottom of the door allows access
- 22 3/4" vertical clearance between worksurface and bottom of door, excluding task light
- two 5/8" dia. holes in upper corners of back panel for task light wiring access
- exterior back panel unfinished
- adjustable shelves

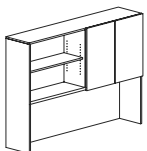
Options:

- must specify chassis grain direction on double cut veneer, see pages 13-15 for details
- veneer door fronts in paint available, specify paint color and add \$337 list; see page 16 for details
- on laminate units, contrasting laminate door fronts available, no upcharge; specify laminate color, see page 16 for details
- white glass doors with aluminum trim available, specify and add \$2,995 list for 96"w, \$2,869 list for 90"w, \$2,743 list for 84"w; see page 33 for details
- markerboard laminate doors available, specify and add \$763 list; see page 33 for details
- locking doors available, specify and add \$284 list (not available on glass doors)
- tackboard or markerboard available, see pages 292-295
- tasklights available, see page 455

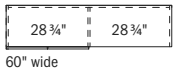
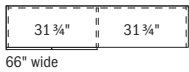
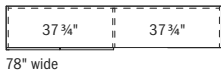
Double Height Overhead Cabinet with Two Doors and Open Compartment	15 7/8"	77 7/8"	52"	239	45	FLT1678-52SMOR	\$2,180		
	15 7/8"	77 7/8"	52"	239	45	FLV1678-52SMOR		\$3,571	\$3,926
	15 7/8"	77 7/8"	52"	239	45	FLT1678-52SMOL	\$2,180		
	15 7/8"	77 7/8"	52"	239	45	FLV1678-52SMOL		\$3,571	\$3,926
	15 7/8"	71 7/8"	52"	224	42	FLT1672-52SMOR	\$2,055		
	15 7/8"	71 7/8"	52"	224	42	FLV1672-52SMOR		\$3,366	\$3,701
	15 7/8"	71 7/8"	52"	224	42	FLT1672-52SMOL	\$2,055		
	15 7/8"	71 7/8"	52"	224	42	FLV1672-52SMOL		\$3,366	\$3,701
	15 7/8"	65 7/8"	52"	215	38	FLT1666-52SMOR	\$1,940		
	15 7/8"	65 7/8"	52"	215	38	FLV1666-52SMOR		\$3,179	\$3,498
	15 7/8"	65 7/8"	52"	215	38	FLT1666-52SMOL	\$1,940		
	15 7/8"	65 7/8"	52"	215	38	FLV1666-52SMOL		\$3,179	\$3,498
	15 7/8"	59 7/8"	52"	199	35	FLT1660-52SMOR	\$1,855		
	15 7/8"	59 7/8"	52"	199	35	FLV1660-52SMOR		\$3,039	\$3,343
	15 7/8"	59 7/8"	52"	199	35	FLT1660-52SMOL	\$1,855		
	15 7/8"	59 7/8"	52"	199	35	FLV1660-52SMOL		\$3,039	\$3,343



left shown



right



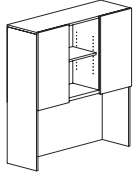
Features:

- use with primary height units, fastening hardware included
- backside of unit intended to go against wall, cabinet should be secured to wall as a safety precaution
- laminate grain direction runs horizontal on back panel of overhead cabinets
- 1/4" overhang at the bottom of the door allows access
- 22 3/4" vertical clearance between worksurface and bottom of door, excluding task light
- two 5/8" dia. holes in upper corners of back panel for task light wiring access
- exterior back panel unfinished
- adjustable shelves

Options:

- must specify chassis grain direction on double cut veneer, see pages 13-15 for details
- veneer door fronts in paint available, specify paint color and add \$337 list; see page 16 for details
- on laminate units, contrasting laminate door fronts available, no upcharge; specify laminate color, see page 16 for details
- white glass doors with aluminum trim available, specify and add \$1,720 list for 78"w, \$1,626 list for 72"w, \$1,531 list for 66"w, \$1,437 list for 60"w; see page 33 for details
- markerboard laminate doors available, specify and add \$385 list; see page 33 for details
- locking doors available, specify and add \$142 list (not available on glass doors)
- tackboard or markerboard available, see pages 292-295
- tasklights available, see page 455

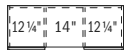
Description	D	W	H	CTN WT	CU FT	① Model	Laminate	Flat Cut Veneer	Double Cut Veneer
Double Height Overhead Cabinet with Two Doors and Open Center	15 7/8	53 7/8	52	197	32	FLT1654-52SMO	\$1,815		
	15 7/8	53 7/8	52	197	32	FLV1654-52SMO		\$2,925	\$3,216
	15 7/8	47 7/8	52	181	28	FLT1648-52SMO	\$1,751		
	15 7/8	47 7/8	52	181	28	FLV1648-52SMO		\$2,823	\$3,107
	15 7/8	41 7/8	52	165	25	FLT1642-52SMO	\$1,698		
	15 7/8	41 7/8	52	165	25	FLV1642-52SMO		\$2,733	\$3,007



54" wide



48" wide



42" wide

Features:

- use with primary height units, fastening hardware included
- backside of unit intended to go against wall, cabinet should be secured to wall as a safety precaution
- laminate grain direction runs horizontal on back panel of overhead cabinets
- 1/4" overhang at the bottom of the door allows access
- 22 3/4" vertical clearance between worksurface and bottom of door, excluding task light
- two 5/8" dia. holes in upper corners of back panel for task light wiring access
- exterior back panel unfinished
- adjustable shelves

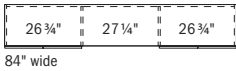
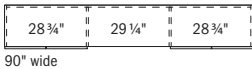
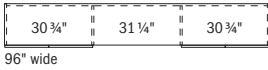
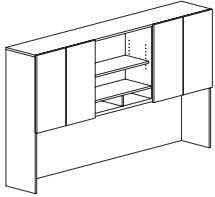
Options:

- must specify chassis grain direction on double cut veneer, see pages 13-15 for details
- veneer door fronts in paint available, specify paint color and add \$337 list; see page 16 for details
- on laminate units, contrasting laminate door fronts available, no upcharge; specify laminate color, see page 16 for details
- white glass doors with aluminum trim available, specify and add \$1,626 list for 54"w, \$1,499 list for 48"w, \$1,372 list for 42"w; see page 33 for details
- markerboard laminate doors available, specify and add \$385 list; see page 33 for details
- locking doors available, specify and add \$284 list (not available on glass doors)
- tackboard or markerboard available, see pages 292-295
- tasklights available, see page 455

To Order, Specify:

① Laminate Model #	② Laminate Selection		③ Metal Color	④ Other Product Options	
Laminate (FLT)	See Laminate Selection		See Metal Finish Color Options	See list of options for each specific unit; Specify and add accordingly.	
① Veneer Model #	② Wood Species	③ Wood Finish		④ Metal Color	⑤ Other Product Options
Veneer (FLV)	Flat Cut CH1 Cherry MA1 Maple WA1 Walnut BO1 Black Oak	See Flat Cut Wood Finish Options		See Metal Finish Color Options	See list of options for each specific unit; Specify and add accordingly.
		3a Wood Finish	3b Chassis Grain Direction		
	Double Cut DC1 Double Cut	See Double Cut Wood Finish Options	For Double Cut Only: Vertical Horizontal		

Description	D	W	H	CTN WT	CU FT	① Model	Laminate	Flat Cut Veneer	Double Cut Veneer
Double Height Storage Overhead Cabinet with Four Doors, Open Center and Cubbies	15 7/8"	95 7/8"	52"	313	55	FLT1696-52SMOCC	\$2,787		
	15 7/8"	95 7/8"	52"	313	55	FLV1696-52SMOCC		\$4,691	\$5,159
	15 7/8"	89 7/8"	52"	297	52	FLT1690-52SMOCC	\$2,627		
	15 7/8"	89 7/8"	52"	297	52	FLV1690-52SMOCC		\$4,415	\$4,858
	15 7/8"	83 7/8"	52"	280	48	FLT1684-52SMOCC	\$2,460		
	15 7/8"	83 7/8"	52"	280	48	FLV1684-52SMOCC		\$4,139	\$4,551



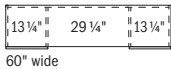
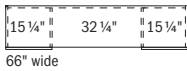
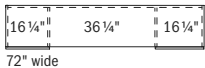
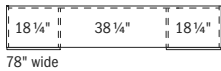
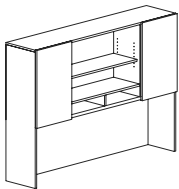
Features:

- use with primary height units, fastening hardware included
- backside of unit intended to go against wall, cabinet should be secured to wall as a safety precaution
- laminate grain direction runs horizontal on back panel of overhead cabinets
- 1/4" overhang at the bottom of the door allows access
- 22 3/4" vertical clearance between worksurface and bottom of door, excluding task light
- two 5/8" dia. holes in upper corners of back panel for task light wiring access
- exterior back panel unfinished
- adjustable shelves

Options:

- must specify chassis grain direction on double cut veneer, see pages 13-15 for details
- veneer door fronts in paint available, specify paint color and add \$337 list; see page 16 for details
- on laminate units, contrasting laminate door fronts available, no upcharge; specify laminate color, see page 16 for details
- white glass doors with aluminum trim available, specify and add \$2,995 list for 96"w, \$2,869 list for 90"w, \$2,743 list for 84"w; see page 33 for details
- markerboard laminate doors available, specify and add \$763 list; see page 33 for details
- locking doors available, specify and add \$284 list (not available on glass doors)
- tackboard or markerboard available, see pages 292-295
- tasklights available, see page 455

Double Height Storage Overhead Cabinet with Two Doors, Open Center and Cubbies	15 7/8"	77 7/8"	52"	260	45	FLT1678-52SMOCC	\$2,304		
	15 7/8"	77 7/8"	52"	260	45	FLV1678-52SMOCC		\$3,747	\$4,122
	15 7/8"	71 7/8"	52"	245	42	FLT1672-52SMOCC	\$2,178		
	15 7/8"	71 7/8"	52"	245	42	FLV1672-52SMOCC		\$3,541	\$3,894
	15 7/8"	65 7/8"	52"	233	38	FLT1666-52SMOCC	\$2,064		
	15 7/8"	65 7/8"	52"	233	38	FLV1666-52SMOCC		\$3,354	\$3,692
	15 7/8"	59 7/8"	52"	221	35	FLT1660-52SMOCC	\$1,979		
	15 7/8"	59 7/8"	52"	221	35	FLV1660-52SMOCC		\$3,216	\$3,538



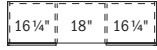
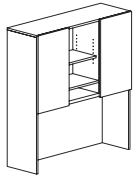
Features:

- use with primary height units, fastening hardware included
- backside of unit intended to go against wall, cabinet should be secured to wall as a safety precaution
- laminate grain direction runs horizontal on back panel of overhead cabinets
- 1/4" overhang at the bottom of the door allows access
- 22 3/4" vertical clearance between worksurface and bottom of door, excluding task light
- two 5/8" dia. holes in upper corners of back panel for task light wiring access
- exterior back panel unfinished
- adjustable shelves

Options:

- must specify chassis grain direction on double cut veneer, see pages 13-15 for details
- veneer door fronts in paint available, specify paint color and add \$337 list; see page 16 for details
- on laminate units, contrasting laminate door fronts available, no upcharge; specify laminate color, see page 16 for details
- white glass doors with aluminum trim available, specify and add \$1,720 list for 78"w, \$1,626 list for 72"w, \$1,531 list for 66"w, \$1,437 list for 60"w; see page 33 for details
- markerboard laminate doors available, specify and add \$385 list; see page 33 for details
- locking doors available, specify and add \$284 list (not available on glass doors)
- tackboard or markerboard available, see pages 292-295
- tasklights available, see page 455

Description	D	W	H	CTN WT	CU FT	① Model	Laminate	Flat Cut Veneer	Double Cut Veneer
Double Height Overhead Cabinet with Two Doors, Open Center and Cubby	15 7/8	53 7/8	52	202	32	FLT1654-52SMOCC	\$1,938		
	15 7/8	53 7/8	52	202	32	FLV1654-52SMOCC		\$3,099	\$3,412
	15 7/8	47 7/8	52	186	28	FLT1648-52SMOCC	\$1,874		
	15 7/8	47 7/8	52	186	28	FLV1648-52SMOCC		\$3,002	\$3,302
	15 7/8	41 7/8	52	169	25	FLT1642-52SMOCC	\$1,820		
	15 7/8	41 7/8	52	169	25	FLV1642-52SMOCC		\$2,910	\$3,202



54" wide



48" wide



42" wide

Features:

- use with primary height units, fastening hardware included
- backside of unit intended to go against wall, cabinet should be secured to wall as a safety precaution
- laminate grain direction runs horizontal on back panel of overhead cabinets
- 1/4" overhang at the bottom of the door allows access
- 22 3/4" vertical clearance between worksurface and bottom of door, excluding task light
- two 5/8" dia. holes in upper corners of back panel for task light wiring access
- exterior back panel unfinished
- adjustable shelves

Options:

- must specify chassis grain direction on double cut veneer, see pages 13-15 for details
- veneer door fronts in paint available, specify paint color and add \$337 list; see page 16 for details
- on laminate units, contrasting laminate door fronts available, no upcharge; specify laminate color, see page 16 for details
- white glass doors with aluminum trim available, specify and add \$1,626 list for 54"w, \$1,499 list for 48"w, \$1,372 list for 42"w; see page 33 for details
- markerboard laminate doors available, specify and add \$385 list; see page 33 for details
- locking doors available, specify and add \$284 list (not available on glass doors)
- tackboard or markerboard available, see pages 292-295
- tasklights available, see page 455

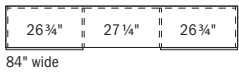
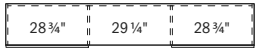
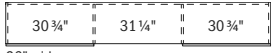
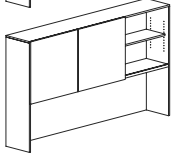
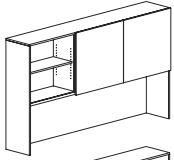
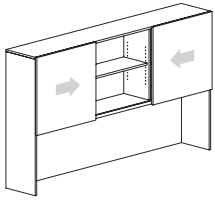
FLUX - PRIVATE OFFICE

To Order, Specify:

① Laminate Model #	② Laminate Selection		③ Metal Color	④ Other Product Options
Laminate (FLT)	See Laminate Selection		See Metal Finish Color Options	See list of options for each specific unit; Specify and add accordingly.

① Veneer Model #	② Wood Species	③ Wood Finish		④ Metal Color	⑤ Other Product Options
Veneer (FLV)	Flat Cut CH1 Cherry MA1 Maple WA1 Walnut BO1 Black Oak	See Flat Cut Wood Finish Options		See Metal Finish Color Options	See list of options for each specific unit; Specify and add accordingly.
		3a Wood Finish	3b Chassis Grain Direction		
	Double Cut DC1 Double Cut	See Double Cut Wood Finish Options	For Double Cut Only: Vertical Horizontal		

Description	D	W	H	CTN WT	CU FT	① Model	Laminate	Flat Cut Veneer	Double Cut Veneer
Double Height Storage Overhead Cabinet with Sliding Doors	15 15/16	95 7/8	52	311	55	FLT1696-52SD	\$3,151		
	15 15/16	95 7/8	52	311	55	FLV1696-52SD		\$5,163	\$5,680
	15 15/16	89 13/16	52	295	52	FLT1690-52SD	\$2,920		
	15 15/16	89 13/16	52	295	52	FLV1690-52SD		\$4,785	\$5,264
	15 15/16	83 7/8	52	279	49	FLT1684-52SD	\$2,688		
	15 15/16	83 7/8	52	279	49	FLV1684-52SD		\$4,404	\$4,845



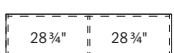
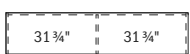
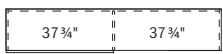
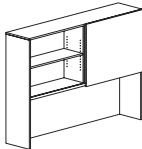
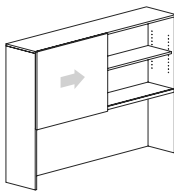
Features:

- use with primary height units, fastening hardware included
- backside of unit intended to go against wall, cabinet should be secured to wall as a safety precaution
- laminate grain direction runs horizontal on back panel of overhead cabinets
- 22 3/4" vertical clearance between worksurface and bottom of door, excluding task light
- two 5/8" dia. holes in upper corners of back panel for task light wiring access
- exterior back panel unfinished
- locking not available
- adjustable shelves

Options:

- must specify chassis grain direction on double cut veneer, see pages 13-15 for details
- veneer door fronts in paint available, specify paint color and add \$337 list; see page 16 for details
- on laminate units, contrasting laminate door fronts available, no upcharge; specify laminate color, see page 16 for details
- white glass doors with aluminum trim available, specify and add \$2,626 list for 96"w, \$2,498 list for 90"w, \$2,372 list for 84"w; see page 33 for details
- markerboard laminate doors available, specify and add \$569 list; see page 33 for details
- tackboard or markerboard available, see pages 292-295
- tasklights available, see page 455

Double Height Storage Overhead Cabinet with Sliding Door	15 15/16	77 7/8	52	245	45	FLT1678-52SD	\$2,591		
	15 15/16	77 7/8	52	245	45	FLV1678-52SD		\$4,107	\$4,518
	15 15/16	71 7/8	52	224	42	FLT1672-52SD	\$2,444		
	15 15/16	71 7/8	52	224	42	FLV1672-52SD		\$3,876	\$4,263
	15 15/16	65 7/8	52	214	39	FLT1666-52SD	\$2,312		
	15 15/16	65 7/8	52	214	39	FLV1666-52SD		\$3,666	\$4,033
	15 15/16	59 7/8	52	193	35	FLT1660-52SD	\$2,212		
	15 15/16	59 7/8	52	193	35	FLV1660-52SD		\$3,510	\$3,861



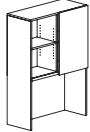
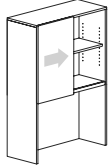
Features:

- use with primary height units, fastening hardware included
- backside of unit intended to go against wall, cabinet should be secured to wall as a safety precaution
- laminate grain direction runs horizontal on back panel of overhead cabinets
- 22 3/4" vertical clearance between worksurface and bottom of door, excluding task light
- two 5/8" dia. holes in upper corners of back panel for task light wiring access
- exterior back panel unfinished
- locking not available
- adjustable shelves

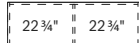
Options:

- must specify chassis grain direction on double cut veneer, see pages 13-15 for details
- veneer door fronts in paint available, specify paint color and add \$337 list; see page 16 for details
- on laminate units, contrasting laminate door fronts available, no upcharge; specify laminate color, see page 16 for details
- white glass doors with aluminum trim available, specify and add \$1,535 list for 78"w, \$1,441 list for 72"w, \$1,346 list for 66"w, \$1,251 list for 60"w; see page 33 for details
- markerboard laminate doors available, specify and add \$286 list; see page 33 for details
- tackboard or markerboard available, see pages 292-295
- tasklights available, see page 455

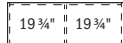
Description	D	W	H	CTN WT	CU FT	① Model	Laminate	Flat Cut Veneer	Double Cut Veneer
Double Height Storage Overhead Cabinet with Sliding Door	15 15/16	53 7/8	52	183	32	FLT1654-52SD	\$2,165		
	15 15/16	53 7/8	52	183	32	FLV1654-52SD		\$3,378	\$3,716
	15 15/16	47 7/8	52	167	28	FLT1648-52SD	\$2,094		
	15 15/16	47 7/8	52	167	28	FLV1648-52SD		\$3,266	\$3,592
	15 15/16	41 7/8	52	152	25	FLT1642-52SD	\$2,030		
	15 15/16	41 7/8	52	152	25	FLV1642-52SD		\$3,165	\$3,482



54" wide



48" wide



42" wide

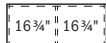
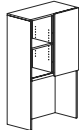
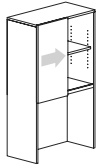
Features:

- use with primary height units, fastening hardware included
- backside of unit intended to go against wall, cabinet should be secured to wall as a safety precaution
- laminate grain direction runs horizontal on back panel of overhead cabinets
- 22 3/4" vertical clearance between worksurface and bottom of door, excluding task light
- two 5/8" dia. holes in upper corners of back panel for task light wiring access
- exterior back panel unfinished
- locking not available
- adjustable shelves

Options:

- must specify chassis grain direction on double cut veneer, see pages 13-15 for details
- veneer door fronts in paint available, specify paint color and add \$337 list; see page 16 for details
- on laminate units, contrasting laminate door fronts available, no upcharge; specify laminate color, see page 16 for details
- white glass doors with aluminum trim available, specify and add \$1,156 list for 54"w, \$1,062 list for 48"w, \$968 list for 42"w; see page 33 for details
- markerboard laminate doors available, specify and add \$286 list; see page 33 for details
- tackboard or markerboard available, see pages 292-295
- tasklights available, see page 455

Double Height Storage Overhead Cabinet with Sliding Door	15 15/16	35 7/8	52	136	22	FLT1636-52SD	\$1,925		
	15 15/16	35 7/8	52	136	22	FLV1636-52SD		\$3,004	\$3,304
	15 15/16	29 7/8	52	121	18	FLT1630-52SD	\$1,848		
	15 15/16	29 7/8	52	121	18	FLV1630-52SD		\$2,882	\$3,172



36" wide



30" wide

Features:

- use with primary height units, fastening hardware included
- backside of unit intended to go against wall, cabinet should be secured to wall as a safety precaution
- laminate grain direction runs horizontal on back panel of overhead cabinets
- 22 3/4" vertical clearance between worksurface and bottom of door, excluding task light
- two 5/8" dia. holes in upper corners of back panel for task light wiring access
- exterior back panel unfinished
- locking not available
- adjustable shelves

Options:

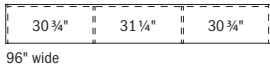
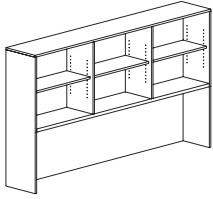
- must specify chassis grain direction on double cut veneer, see pages 13-15 for details
- veneer door fronts in paint available, specify paint color and add \$337 list; see page 16 for details
- on laminate units, contrasting laminate door fronts available, no upcharge; specify laminate color, see page 16 for details
- white glass doors with aluminum trim available, specify and add \$872 list for 36"w, \$778 list for 30"w; see page 33 for details
- markerboard laminate doors available, specify and add \$286 list; see page 33 for details
- tackboard or markerboard available, see pages 292-295
- tasklights available, see page 455

To Order, Specify:

① Laminate Model #	② Laminate Selection	③ Metal Color	④ Other Product Options
Laminate (FLT)	See Laminate Selection	See Metal Finish Color Options	See list of options for each specific unit; Specify and add accordingly.

① Veneer Model #	② Wood Species	③ Wood Finish	④ Metal Color	⑤ Other Product Options
Veneer (FLV)	Flat Cut CH1 Cherry MA1 Maple WA1 Walnut BO1 Black Oak	See Flat Cut Wood Finish Options	See Metal Finish Color Options	See list of options for each specific unit; Specify and add accordingly.
		<table border="1"> <thead> <tr> <th>③a Wood Finish</th> <th>③b Chassis Grain Direction</th> </tr> </thead> <tbody> <tr> <td>See Double Cut Wood Finish Options</td> <td>For Double Cut Only: Vertical Horizontal</td> </tr> </tbody> </table>		
③a Wood Finish	③b Chassis Grain Direction			
See Double Cut Wood Finish Options	For Double Cut Only: Vertical Horizontal			

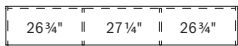
Description	D	W	H	CTN WT	CU FT	① Model	Laminate	Flat Cut Veneer	Double Cut Veneer
Double Height Open Storage Overhead Cabinet	15	95 $\frac{7}{8}$ "	52	257	52	FLT1596-5200	\$2,440		
	15	95 $\frac{7}{8}$ "	52	257	52	FLV1596-5200		\$4,134	\$4,547
	15	89 $\frac{13}{16}$ "	52	244	49	FLT1590-5200	\$2,292		
	15	89 $\frac{13}{16}$ "	52	244	49	FLV1590-5200		\$3,883	\$4,272
	15	83 $\frac{7}{8}$ "	52	231	46	FLT1584-5200	\$2,144		
	15	83 $\frac{7}{8}$ "	52	231	46	FLV1584-5200		\$3,627	\$3,989



96" wide



90" wide



84" wide

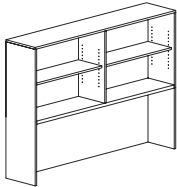
Features:

- use with primary height units, fastening hardware included
- laminate grain direction runs horizontal on back panel of overhead cabinets
- backside of unit intended to go against wall, cabinet should be secured to wall as a safety precaution
- 23" vertical clearance between worksurface and bottom of cabinet, excluding task light
- two $\frac{5}{8}$ " dia. holes in upper corners of back panel for task light wiring access
- exterior back panel unfinished
- adjustable shelves

Options:

- must specify chassis grain direction on double cut veneer, see pages 13-15 for details
- tackboard or markerboard available, see pages 292-295
- tasklights available, see page 455

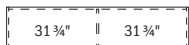
Double Height Open Storage Overhead Cabinet	15	77 $\frac{7}{8}$ "	52	210	43	FLT1578-5200	\$1,998		
	15	77 $\frac{7}{8}$ "	52	210	43	FLV1578-5200		\$3,270	\$3,597
	15	71 $\frac{7}{8}$ "	52	197	40	FLT1572-5200	\$1,882		
	15	71 $\frac{7}{8}$ "	52	197	40	FLV1572-5200		\$3,082	\$3,389
	15	65 $\frac{7}{8}$ "	52	189	37	FLT1566-5200	\$1,779		
	15	65 $\frac{7}{8}$ "	52	189	37	FLV1566-5200		\$2,910	\$3,202
	15	59 $\frac{7}{8}$ "	52	175	33	FLT1560-5200	\$1,700		
	15	59 $\frac{7}{8}$ "	52	175	33	FLV1560-5200		\$2,784	\$3,063



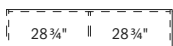
78" wide



72" wide



66" wide



60" wide

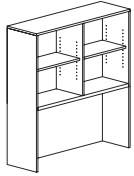
Features:

- use with primary height units, fastening hardware included
- laminate grain direction runs horizontal on back panel of overhead cabinets
- backside of unit intended to go against wall, cabinet should be secured to wall as a safety precaution
- 23" vertical clearance between worksurface and bottom of cabinet, excluding task light
- two $\frac{5}{8}$ " dia. holes in upper corners of back panel for task light wiring access
- exterior back panel unfinished
- adjustable shelves

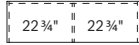
Options:

- must specify chassis grain direction on double cut veneer, see pages 13-15 for details
- tackboard or markerboard available, see pages 292-295
- tasklights available, see page 455

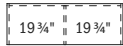
Description	D	W	H	CTN WT	CU FT	① Model	Laminate	Flat Cut Veneer	Double Cut Veneer
Double Height Open Storage Overhead Cabinet	15	53 7/8"	52	162	30	FLT1554-5200	\$1,663		
	15	53 7/8"	52	162	30	FLV1554-5200		\$2,678	\$2,945
	15	47 7/8"	52	148	27	FLT1548-5200	\$1,604		
	15	47 7/8"	52	148	27	FLV1548-5200		\$2,585	\$2,844
	15	41 7/8"	52	134	24	FLT1542-5200	\$1,555		
	15	41 7/8"	52	134	24	FLV1542-5200		\$2,501	\$2,754



54" wide



48" wide



42" wide

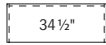
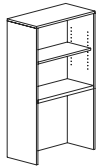
Features:

- use with primary height units, fastening hardware included
- laminate grain direction runs horizontal on back panel of overhead cabinets
- backside of unit intended to go against wall, cabinet should be secured to wall as a safety precaution
- 23" vertical clearance between worksurface and bottom of cabinet, excluding task light
- two 5/8" dia. holes in upper corners of back panel for task light wiring access
- exterior back panel unfinished
- adjustable shelves

Options:

- must specify chassis grain direction on double cut veneer, see pages 13-15 for details
- tackboard or markerboard available, see pages 292-295
- tasklights available, see page 455

Double Height Open Storage Overhead Cabinet	15	35 7/8"	52	110	21	FLT1536-5200	\$1,474		
	15	35 7/8"	52	110	21	FLV1536-5200		\$2,372	\$2,610
	15	29 7/8"	52	97	17	FLT1530-5200	\$1,412		
	15	29 7/8"	52	97	17	FLV1530-5200		\$2,273	\$2,500



36" wide



30" wide

Features:

- use with primary height units, fastening hardware included
- laminate grain direction runs horizontal on back panel of overhead cabinets
- backside of unit intended to go against wall, cabinet should be secured to wall as a safety precaution
- 23" vertical clearance between worksurface and bottom of cabinet, excluding task light
- two 5/8" dia. holes in upper corners of back panel for task light wiring access
- exterior back panel unfinished
- adjustable shelves

Options:

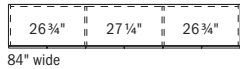
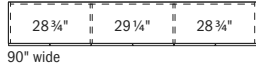
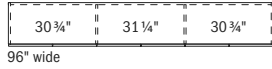
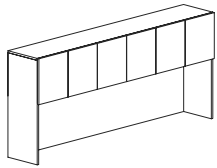
- must specify chassis grain direction on double cut veneer, see pages 13-15 for details
- tackboard or markerboard available, see pages 292-295
- tasklights available, see page 455

To Order, Specify:

① Laminate Model #	② Laminate Selection	③ Metal Color	④ Other Product Options
Laminate (FLT)	See Laminate Selection	See Metal Finish Color Options	See list of options for each specific unit; Specify and add accordingly.

① Veneer Model #	② Wood Species	③ Wood Finish	④ Metal Color	⑤ Other Product Options
Veneer (FLV)	Flat Cut CH1 Cherry MA1 Maple WA1 Walnut BO1 Black Oak	See Flat Cut Wood Finish Options	See Metal Finish Color Options	See list of options for each specific unit; Specify and add accordingly.
		<table border="1"> <thead> <tr> <th>③a Wood Finish</th> <th>③b Chassis Grain Direction</th> </tr> </thead> <tbody> <tr> <td>See Double Cut Wood Finish Options</td> <td>For Double Cut Only: Vertical Horizontal</td> </tr> </tbody> </table>		
③a Wood Finish	③b Chassis Grain Direction			
See Double Cut Wood Finish Options	For Double Cut Only: Vertical Horizontal			

Description	D	W	H	CTN WT	CU FT	① Model	Laminate	Flat Cut Veneer	Double Cut Veneer
Storage Overhead Cabinet with Six Doors	15 $\frac{7}{8}$ "	95 $\frac{7}{8}$ "	40"	232	43	FLT1696-40SO	\$2,243		
	15 $\frac{7}{8}$ "	95 $\frac{7}{8}$ "	40"	232	43	FLV1696-40SO		\$3,801	\$4,180
	15 $\frac{7}{8}$ "	89 $\frac{7}{8}$ "	40"	220	40	FLT1690-40SO	\$2,108		
	15 $\frac{7}{8}$ "	89 $\frac{7}{8}$ "	40"	220	40	FLV1690-40SO		\$3,571	\$3,926
	15 $\frac{7}{8}$ "	83 $\frac{7}{8}$ "	40"	208	38	FLT1684-40SO	\$1,971		
	15 $\frac{7}{8}$ "	83 $\frac{7}{8}$ "	40"	208	38	FLV1684-40SO		\$3,334	\$3,667



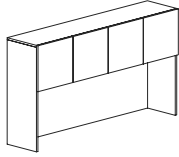
Features:

- use with primary height units, fastening hardware included
- laminate grain direction runs horizontal on back panel of overhead cabinets
- 1/4" overhang at the bottom of the door allows access
- 22 3/4" vertical clearance between worksurface and bottom of door, excluding task light
- two 5/8" dia. holes in upper corners of back panel for task light wiring access
- exterior back panel unfinished

Options:

- must specify chassis grain direction on double cut veneer, see pages 13-15 for details
- veneer door fronts in paint available, specify paint color and add \$337 list; see page 16 for details
- on laminate units, contrasting laminate door fronts available, no upcharge; specify laminate color, see page 16 for details
- white glass doors with aluminum trim available, specify and add \$3,348 list; see page 33 for details
- markerboard laminate doors available, specify and add \$1,144 list; see page 33 for details
- locking doors available, specify and add \$426 list (not available on glass doors)
- tackboard or markerboard available, see pages 292-295
- tasklights available, see page 455

Description	D	W	H	CTN WT	CU FT	① Model	Laminate	Flat Cut Veneer	Double Cut Veneer
Storage Overhead Cabinet with Four Doors	15 7/8	77 7/8	40	192	35	FLT1678-40SO	\$1,834		
	15 7/8	77 7/8	40	192	35	FLV1678-40SO		\$3,007	\$3,308
	15 7/8	71 7/8	40	178	33	FLT1672-40SO	\$1,732		
	15 7/8	71 7/8	40	178	33	FLV1672-40SO		\$2,832	\$3,116
	15 7/8	65 7/8	40	172	30	FLT1666-40SO	\$1,633		
	15 7/8	65 7/8	40	172	30	FLV1666-40SO		\$2,677	\$2,943
	15 7/8	59 7/8	40	160	27	FLT1660-40SO	\$1,562		
	15 7/8	59 7/8	40	160	27	FLV1660-40SO		\$2,560	\$2,815



78" wide



72" wide



66" wide



60" wide

Features:

- use with primary height units, fastening hardware included
- laminate grain direction runs horizontal on back panel of overhead cabinets
- 1/4" overhang at the bottom of the door allows access
- 22 3/4" vertical clearance between worksurface and bottom of door, excluding task light
- two 5/8" dia. holes in upper corners of back panel for task light wiring access
- exterior back panel unfinished

Options:

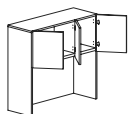
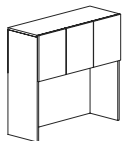
- must specify chassis grain direction on double cut veneer, see pages 13-15 for details
- veneer door fronts in paint available, specify paint color and add \$337 list; see page 16 for details
- on laminate units, contrasting laminate door fronts available, no upcharge; specify laminate color, see page 16 for details
- white glass doors with aluminum trim available, specify and add \$2,433 list for 78"w, \$2,321 list for 72"w, \$2,234 list for 66"w or 60"w; see page 33 for details
- markerboard laminate doors available, specify and add \$763 list; see page 33 for details
- locking doors available, specify and add \$284 list (not available on glass doors)
- tackboard or markerboard available, see pages 292-295
- tasklights available, see page 455

To Order, Specify:

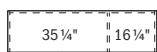
① Laminate Model #	② Laminate Selection	③ Metal Color	④ Other Product Options
Laminate (FLT)	See Laminate Selection	See Metal Finish Color Options	See list of options for each specific unit; Specify and add accordingly.

① Veneer Model #	② Wood Species	③ Wood Finish	④ Metal Color	⑤ Other Product Options
Veneer (FLV)	Flat Cut CH1 Cherry MA1 Maple WA1 Walnut BO1 Black Oak	See Flat Cut Wood Finish Options	See Metal Finish Color Options	See list of options for each specific unit; Specify and add accordingly.
		<table border="1"> <thead> <tr> <th>③a Wood Finish</th> <th>③b Chassis Grain Direction</th> </tr> </thead> <tbody> <tr> <td>See Double Cut Wood Finish Options</td> <td>For Double Cut Only: Vertical Horizontal</td> </tr> </tbody> </table>		
③a Wood Finish	③b Chassis Grain Direction			
See Double Cut Wood Finish Options	For Double Cut Only: Vertical Horizontal			
Double Cut DC1 Double Cut				

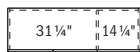
Description	D	W	H	CTN WT	CU FT	① Model	Laminate	Flat Cut Veneer	Double Cut Veneer
Storage Overhead Cabinet with Three Doors	15 7/8	53 7/8	40	147	25	FLT1654-40SOR	\$1,528		
	15 7/8	53 7/8	40	147	25	FLV1654-40SOR		\$2,459	\$2,706
	15 7/8	53 7/8	40	147	25	FLT1654-40SOL	\$1,528		
	15 7/8	53 7/8	40	147	25	FLV1654-40SOL		\$2,459	\$2,706
	15 7/8	47 7/8	40	134	22	FLT1648-40SOR	\$1,476		
	15 7/8	47 7/8	40	134	22	FLV1648-40SOR		\$2,376	\$2,614
	15 7/8	47 7/8	40	134	22	FLT1648-40SOL	\$1,476		
	15 7/8	47 7/8	40	134	22	FLV1648-40SOL		\$2,376	\$2,614
	15 7/8	41 7/8	40	122	20	FLT1642-40SOR	\$1,430		
	15 7/8	41 7/8	40	122	20	FLV1642-40SOR		\$2,303	\$2,531
	15 7/8	41 7/8	40	122	20	FLT1642-40SOL	\$1,430		
	15 7/8	41 7/8	40	122	20	FLV1642-40SOL		\$2,303	\$2,531



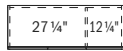
right shown



54" wide



48" wide



42" wide

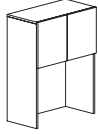
Features:

- use with primary height units, fastening hardware included
- laminate grain direction runs horizontal on back panel of overhead cabinets
- 1/4" overhang at the bottom of the door allows access
- 22 3/4" vertical clearance between worksurface and bottom of door, excluding task light
- two 5/8" dia. holes in upper corners of back panel for task light wiring access
- exterior back panel unfinished

Options:

- must specify chassis grain direction on double cut veneer, see pages 13-15 for details
- veneer door fronts in paint available, specify paint color and add \$337 list; see page 16 for details
- on laminate units, contrasting laminate door fronts available, no upcharge; specify laminate color, see page 16 for details
- white glass doors with aluminum trim available, specify and add \$1,742 list for 54"w, \$1,675 list for 48"w or 42"w; see page 33 for details
- markerboard laminate doors available, specify and add \$574 list; see page 33 for details
- locking doors available, specify and add \$284 list (not available on glass doors)
- tackboard or markerboard available, see pages 292-295
- tasklights available, see page 455

Description	D	W	H	CTN WT	CU FT	① Model	Laminate	Flat Cut Veneer	Double Cut Veneer
Storage Overhead Cabinet with Two Doors	15 7/8	35 7/8	40	102	17	FLT1636-40SO	\$1,357		
	15 7/8	35 7/8	40	102	17	FLV1636-40SO		\$2,181	\$2,399
	15 7/8	29 7/8	40	90	14	FLT1630-40SO	\$1,299		
	15 7/8	29 7/8	40	90	14	FLV1630-40SO		\$2,089	\$2,301



36" wide



30" wide

Features:

- use with primary height units, fastening hardware included
- laminate grain direction runs horizontal on back panel of overhead cabinets
- 1/4" overhang at the bottom of the door allows access
- 22 3/4" vertical clearance between worksurface and bottom of door, excluding task light
- two 5/8" dia. holes in upper corners of back panel for task light wiring access
- exterior back panel unfinished

Options:

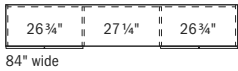
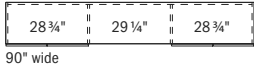
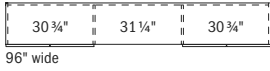
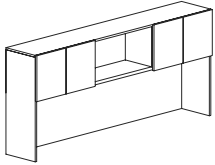
- must specify chassis grain direction on double cut veneer, see pages 13-15 for details
- veneer door fronts in paint available, specify paint color and add \$337 list; see page 16 for details
- on laminate units, contrasting laminate door fronts available, no upcharge; specify laminate color, see page 16 for details
- white glass doors with aluminum trim available, specify and add \$1,163 list for 36"w, \$1,119 list for 30"w; see page 33 for details
- markerboard laminate doors available, specify and add \$385 list; see page 33 for details
- locking doors available, specify and add \$142 list (not available on glass doors)
- tackboard or markerboard available, see pages 292-295
- tasklights available, see page 455

To Order, Specify:

① Laminate Model #	② Laminate Selection		③ Metal Color	④ Other Product Options
Laminate (FLT)	See Laminate Selection		See Metal Finish Color Options	See list of options for each specific unit; Specify and add accordingly.

① Veneer Model #	② Wood Species	③ Wood Finish		④ Metal Color	⑤ Other Product Options
Veneer (FLV)	Flat Cut CH1 Cherry MA1 Maple WA1 Walnut BO1 Black Oak	See Flat Cut Wood Finish Options		See Metal Finish Color Options	See list of options for each specific unit; Specify and add accordingly.
		3a Wood Finish	3b Chassis Grain Direction		
	Double Cut DC1 Double Cut	See Double Cut Wood Finish Options	For Double Cut Only: Vertical Horizontal		

Description	D	W	H	CTN WT	CU FT	① Model	Laminate	Flat Cut Veneer	Double Cut Veneer
Storage Overhead Cabinet with Four Doors and Open Center	15 7/8"	95 7/8"	40"	221	43	FLT1696-40SMO	\$2,130		
	15 7/8"	95 7/8"	40"	221	43	FLV1696-40SMO		\$3,606	\$3,966
	15 7/8"	89 7/8"	40"	209	40	FLT1690-40SMO	\$1,972		
	15 7/8"	89 7/8"	40"	209	40	FLV1690-40SMO		\$3,337	\$3,670
	15 7/8"	83 7/8"	40"	198	38	FLT1684-40SMO	\$1,812		
	15 7/8"	83 7/8"	40"	198	38	FLV1684-40SMO		\$3,065	\$3,372



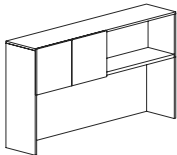
Features:

- use with primary height units, fastening hardware included
- laminate grain direction runs horizontal on back panel of overhead cabinets
- 1/4" overhang at the bottom of the door allows access
- 22 3/4" vertical clearance between worksurface and bottom of door, excluding task light
- two 5/8" dia. holes in upper corners of back panel for task light wiring access
- exterior back panel unfinished

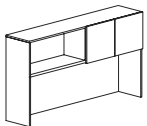
Options:

- must specify chassis grain direction on double cut veneer, see pages 13-15 for details
- veneer door fronts in paint available, specify paint color and add \$337 list; see page 16 for details
- on laminate units, contrasting laminate door fronts available, no upcharge; specify laminate color, see page 16 for details
- white glass doors with aluminum trim available, specify and add \$2,234 list; see page 33 for details
- markerboard laminate doors available, specify and add \$763 list; see page 33 for details
- locking doors available, specify and add \$284 list (not available on glass doors)
- tackboard or markerboard available, see pages 292-295
- tasklights available, see page 455

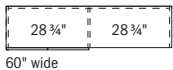
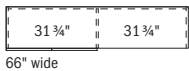
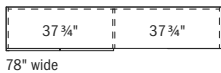
Storage Overhead Cabinet with Two Doors and open compartment	15 7/8"	77 7/8"	40"	180	35	FLT1678-40SMOR	\$1,744		
	15 7/8"	77 7/8"	40"	180	35	FLV1678-40SMOR		\$2,857	\$3,140
	15 7/8"	77 7/8"	40"	180	35	FLT1678-40SMOL	\$1,744		
	15 7/8"	77 7/8"	40"	180	35	FLV1678-40SMOL		\$2,857	\$3,140
	15 7/8"	71 7/8"	40"	169	33	FLT1672-40SMOR	\$1,643		
	15 7/8"	71 7/8"	40"	169	33	FLV1672-40SMOR		\$2,691	\$2,961
	15 7/8"	71 7/8"	40"	169	33	FLT1672-40SMOL	\$1,643		
	15 7/8"	71 7/8"	40"	169	33	FLV1672-40SMOL		\$2,691	\$2,961
	15 7/8"	65 7/8"	40"	163	30	FLT1666-40SMOR	\$1,555		
	15 7/8"	65 7/8"	40"	163	30	FLV1666-40SMOR		\$2,544	\$2,799
	15 7/8"	65 7/8"	40"	163	30	FLT1666-40SMOL	\$1,555		
	15 7/8"	65 7/8"	40"	163	30	FLV1666-40SMOL		\$2,544	\$2,799
	15 7/8"	59 7/8"	40"	152	27	FLT1660-40SMOR	\$1,485		
	15 7/8"	59 7/8"	40"	152	27	FLV1660-40SMOR		\$2,431	\$2,676
	15 7/8"	59 7/8"	40"	152	27	FLT1660-40SMOL	\$1,485		
	15 7/8"	59 7/8"	40"	152	27	FLV1660-40SMOL		\$2,431	\$2,676



left shown



right



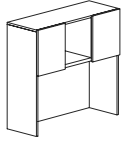
Features:

- use with primary height units, fastening hardware included
- laminate grain direction runs horizontal on back panel of overhead cabinets
- 1/4" overhang at the bottom of the door allows access
- 22 3/4" vertical clearance between worksurface and bottom of door, excluding task light
- two 5/8" dia. holes in upper corners of back panel for task light wiring access
- exterior back panel unfinished

Options:

- must specify chassis grain direction on double cut veneer, see pages 13-15 for details
- veneer door fronts in paint available, specify paint color and add \$337 list; see page 16 for details
- on laminate units, contrasting laminate door fronts available, no upcharge; specify laminate color, see page 16 for details
- white glass doors with aluminum trim available, specify and add \$1,218 list for 78"w, \$1,163 list for 72"w, \$1,119 list for 66"w or 60"w; see page 33 for details
- markerboard laminate doors available, specify and add \$385 list; see page 33 for details
- locking doors available, specify and add \$142 list (not available on glass doors)
- tackboard or markerboard available, see pages 292-295
- tasklights available, see page 455

Description	D	W	H	CTN WT	CU FT	1 Model	Laminate	Flat Cut Veneer	Double Cut Veneer
Storage Overhead Cabinet with Two Doors with Open Center	15 7/8	53 7/8	40	145	25	FLT1654-40SMO	\$1,452		
	15 7/8	53 7/8	40	145	25	FLV1654-40SMO		\$2,341	\$2,573
	15 7/8	47 7/8	40	133	22	FLT1648-40SMO	\$1,405		
	15 7/8	47 7/8	40	133	22	FLV1648-40SMO		\$2,260	\$2,487
	15 7/8	41 7/8	40	121	20	FLT1642-40SMO	\$1,359		
	15 7/8	41 7/8	40	121	20	FLV1642-40SMO		\$2,187	\$2,405



54" wide



48" wide



42" wide

Features:

- use with primary height units, fastening hardware included
- laminate grain direction runs horizontal on back panel of overhead cabinets
- 1/4" overhang at the bottom of the door allows access
- 22 3/4" vertical clearance between worksurface and bottom of door, excluding task light
- two 5/8" dia. holes in upper corners of back panel for task light wiring access
- exterior back panel unfinished

Options:

- must specify chassis grain direction on double cut veneer, see pages 13-15 for details
- veneer door fronts in paint available, specify paint color and add \$337 list; see page 16 for details
- on laminate units, contrasting laminate door fronts available, no upcharge; specify laminate color, see page 16 for details
- white glass doors with aluminum trim available, specify and add \$1,163 list for 54"w, \$1,119 list for 48"w or 42"w; see page 33 for details
- markerboard laminate doors available, specify and add \$385 list; see page 33 for details
- locking doors available, specify and add \$284 list (not available on glass doors)
- tackboard or markerboard available, see pages 292-295
- tasklights available, see page 455

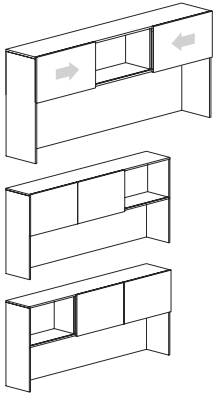
FLUX - PRIVATE OFFICE

To Order, Specify:

1 Laminate Model #	2 Laminate Selection		3 Metal Color	4 Other Product Options
Laminate (FLT)	See Laminate Selection		See Metal Finish Color Options	See list of options for each specific unit; Specify and add accordingly.

1 Veneer Model #	2 Wood Species	3 Wood Finish		4 Metal Color	5 Other Product Options
Veneer (FLV)	Flat Cut CH1 Cherry MA1 Maple WA1 Walnut BO1 Black Oak	See Flat Cut Wood Finish Options		See Metal Finish Color Options	See list of options for each specific unit; Specify and add accordingly.
		3a Wood Finish	3b Chassis Grain Direction		
	Double Cut DC1 Double Cut	See Double Cut Wood Finish Options	For Double Cut Only: Vertical Horizontal		

Description	D	W	H	CTN WT	CU FT	① Model	Laminate	Flat Cut Veneer	Double Cut Veneer
Storage Overhead Cabinet with Sliding Doors	15 15/16	95 7/8	40	232	43	FLT1696-40SD	\$2,522		
	15 15/16	95 7/8	40	232	43	FLV1696-40SD		\$4,133	\$4,546
	15 15/16	89 7/8	40	220	41	FLT1690-40SD	\$2,335		
	15 15/16	89 7/8	40	220	41	FLV1690-40SD		\$3,829	\$4,210
	15 15/16	83 7/8	40	209	38	FLT1684-40SD	\$2,151		
	15 15/16	83 7/8	40	209	38	FLV1684-40SD		\$3,523	\$3,876

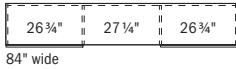
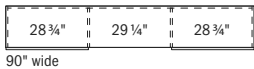
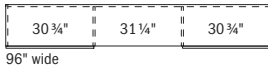


Features:

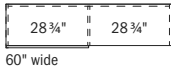
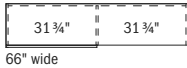
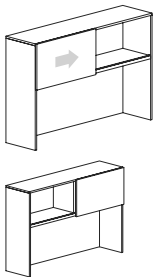
- use with primary height units, fastening hardware included
- laminate grain direction runs horizontal on back panel of overhead cabinets
- 22 3/4" vertical clearance between worksurface and bottom of door, excluding task light
- two 5/8" dia. holes in upper corners of back panel for task light wiring access
- exterior back panel unfinished
- locking not available

Options:

- must specify chassis grain direction on double cut veneer, see pages 13-15 for details
- veneer door fronts in paint available, specify paint color and add \$337 list; see page 16 for details
- on laminate units, contrasting laminate door fronts available, no upcharge; specify laminate color, see page 16 for details
- white glass doors with aluminum trim available, specify and add \$1,787 list for 96"w, \$1,714 list for 90"w, \$1,639 list for 84"w; see page 33 for details
- markerboard laminate doors available, specify and add \$569 list; see page 33 for details
- tackboard or markerboard available, see pages 292-295
- tasklights available, see page 455



Storage Overhead Cabinet with Sliding Door	15 15/16	77 7/8	40	187	35	FLT1678-40SD	\$2,073		
	15 15/16	77 7/8	40	187	35	FLV1678-40SD		\$3,286	\$3,617
	15 15/16	71 7/8	40	175	33	FLT1672-40SD	\$1,955		
	15 15/16	71 7/8	40	175	33	FLV1672-40SD		\$3,099	\$3,412
	15 15/16	65 7/8	40	164	30	FLT1666-40SD	\$1,851		
	15 15/16	65 7/8	40	164	30	FLV1666-40SD		\$2,935	\$3,227
	15 15/16	59 7/8	40	153	27	FLT1660-40SD	\$1,772		
	15 15/16	59 7/8	40	153	27	FLV1660-40SD		\$2,807	\$3,088



Features:

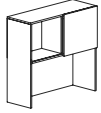
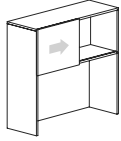
- use with primary height units, fastening hardware included
- laminate grain direction runs horizontal on back panel of overhead cabinets
- 22 3/4" vertical clearance between worksurface and bottom of door, excluding task light
- two 5/8" dia. holes in upper corners of back panel for task light wiring access
- exterior back panel unfinished
- locking not available

Options:

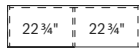
- must specify chassis grain direction on double cut veneer, see pages 13-15 for details
- veneer door fronts in paint available, specify paint color and add \$337 list; see page 16 for details
- on laminate units, contrasting laminate door fronts available, no upcharge; specify laminate color, see page 16 for details
- white glass doors with aluminum trim available, specify and add \$1,029 list for 78"w, \$971 list for 72"w, \$916 list for 66"w \$858 list for 60"w; see page 33 for details
- markerboard laminate doors available, specify and add \$286 list; see page 33 for details
- tackboard or markerboard available, see pages 292-295
- tasklights available, see page 455

FLUX - PRIVATE OFFICE

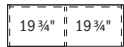
Description	D	W	H	CTN WT	CU FT	① Model	Laminate	Flat Cut Veneer	Double Cut Veneer
Storage Overhead Cabinet with Sliding Door	15 15/16	53 7/8	40	141	25	FLT1654-40SD	\$1,733		
	15 15/16	53 7/8	40	141	25	FLV1654-40SD		\$2,702	\$2,973
	15 15/16	47 7/8	40	130	22	FLT1648-40SD	\$1,674		
	15 15/16	47 7/8	40	130	22	FLV1648-40SD		\$2,613	\$2,875
	15 15/16	41 7/8	40	119	20	FLT1642-40SD	\$1,623		
	15 15/16	41 7/8	40	119	20	FLV1642-40SD		\$2,532	\$2,787



54" wide



48" wide



42" wide

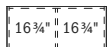
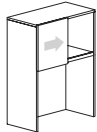
Features:

- use with primary height units, fastening hardware included
- laminate grain direction runs horizontal on back panel of overhead cabinets
- 22 3/4" vertical clearance between worksurface and bottom of door, excluding task light
- two 5/8" dia. holes in upper corners of back panel for task light wiring access
- exterior back panel unfinished
- locking not available

Options:

- must specify chassis grain direction on double cut veneer, see pages 13-15 for details
- veneer door fronts in paint available, specify paint color and add \$337 list; see page 16 for details
- on laminate units, contrasting laminate door fronts available, no upcharge; specify laminate color, see page 16 for details
- white glass doors with aluminum trim available, specify and add \$803 list for 54"w, \$778 list for 48"w, \$748 list for 42"w; see page 33 for details
- markerboard laminate doors available, specify and add \$286 list; see page 33 for details
- tackboard or markerboard available, see pages 292-295
- tasklights available, see page 455

Storage Overhead Cabinet with Sliding Door	15 15/16	35 7/8	40	107	17	FLT1636-40SD	\$1,541		
	15 15/16	35 7/8	40	107	17	FLV1636-40SD		\$2,404	\$2,645
	15 15/16	29 7/8	40	96	14	FLT1630-40SD	\$1,479		
	15 15/16	29 7/8	40	96	14	FLV1630-40SD		\$2,307	\$2,538



36" wide



30" wide

Features:

- use with primary height units, fastening hardware included
- laminate grain direction runs horizontal on back panel of overhead cabinets
- 22 3/4" vertical clearance between worksurface and bottom of door, excluding task light
- two 5/8" dia. holes in upper corners of back panel for task light wiring access
- exterior back panel unfinished
- locking not available

Options:

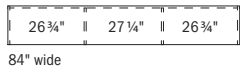
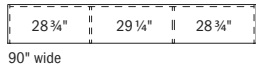
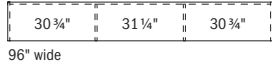
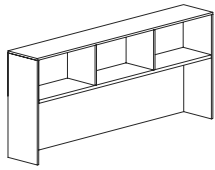
- must specify chassis grain direction on double cut veneer, see pages 13-15 for details
- veneer door fronts in paint available, specify paint color and add \$337 list; see page 16 for details
- on laminate units, contrasting laminate door fronts available, no upcharge; specify laminate color, see page 16 for details
- white glass doors with aluminum trim available, specify and add \$636 list for 36"w, \$607 list for 30"w; see page 33 for details
- markerboard laminate doors available, specify and add \$286 list; see page 33 for details
- tackboard or markerboard available, see pages 292-295
- tasklights available, see page 455

To Order, Specify:

① Laminate Model #	② Laminate Selection	③ Metal Color	④ Other Product Options
Laminate (FLT)	See Laminate Selection	See Metal Finish Color Options	See list of options for each specific unit; Specify and add accordingly.

① Veneer Model #	② Wood Species	③ Wood Finish	④ Metal Color	⑤ Other Product Options
Veneer (FLV)	Flat Cut CH1 Cherry MA1 Maple WA1 Walnut BO1 Black Oak	See Flat Cut Wood Finish Options	See Metal Finish Color Options	See list of options for each specific unit; Specify and add accordingly.
		③a Wood Finish See Double Cut Wood Finish Options		

Description	D	W	H	CTN WT	CU FT	① Model	Laminate	Flat Cut Veneer	Double Cut Veneer
Open Storage Overhead Cabinet	15	95 $\frac{7}{8}$ "	40	199	41	FLT1596-4000	\$1,953		
	15	95 $\frac{7}{8}$ "	40	199	41	FLV1596-4000		\$3,308	\$3,639
	15	89 $\frac{7}{8}$ "	40	189	38	FLT1590-4000	\$1,834		
	15	89 $\frac{7}{8}$ "	40	189	38	FLV1590-4000		\$3,107	\$3,417
	15	83 $\frac{7}{8}$ "	40	179	36	FLT1584-4000	\$1,715		
	15	83 $\frac{7}{8}$ "	40	179	36	FLV1584-4000		\$2,902	\$3,194



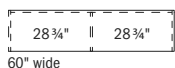
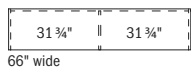
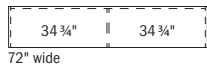
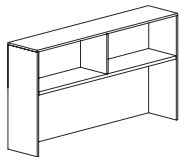
Features:

- use with primary height units, fastening hardware included
- laminate grain direction runs horizontal on back panel of overhead cabinets
- 23" vertical clearance between worksurface and bottom of cabinet, excluding task light
- two $\frac{5}{8}$ " dia. holes in upper corners of back panel for task light wiring access
- exterior back panel unfinished

Options:

- must specify chassis grain direction on double cut veneer, see pages 13-15 for details
- tackboard or markerboard available, see pages 292-295
- tasklights available, see page 455

Open Storage Overhead Cabinet	15	77 $\frac{7}{8}$ "	40	164	34	FLT1578-4000	\$1,598		
	15	77 $\frac{7}{8}$ "	40	164	34	FLV1578-4000		\$2,615	\$2,878
	15	71 $\frac{7}{8}$ "	40	154	31	FLT1572-4000	\$1,508		
	15	71 $\frac{7}{8}$ "	40	154	31	FLV1572-4000		\$2,466	\$2,714
	15	65 $\frac{7}{8}$ "	40	150	29	FLT1566-4000	\$1,423		
	15	65 $\frac{7}{8}$ "	40	150	29	FLV1566-4000		\$2,329	\$2,563
	15	59 $\frac{7}{8}$ "	40	139	26	FLT1560-4000	\$1,363		
	15	59 $\frac{7}{8}$ "	40	139	26	FLV1560-4000		\$2,227	\$2,450



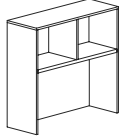
Features:

- use with primary height units, fastening hardware included
- laminate grain direction runs horizontal on back panel of overhead cabinets
- 23" vertical clearance between worksurface and bottom of cabinet, excluding task light
- two $\frac{5}{8}$ " dia. holes in upper corners of back panel for task light wiring access
- exterior back panel unfinished

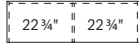
Options:

- must specify chassis grain direction on double cut veneer, see pages 13-15 for details
- tackboard or markerboard available, see pages 292-295
- tasklights available, see page 455

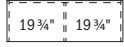
Description	D	W	H	CTN WT	CU FT	1 Model	Laminate	Flat Cut Veneer	Double Cut Veneer
Open Storage Overhead Cabinet	15	53 7/8"	40	129	24	FLT1554-4000	\$1,330		
	15	53 7/8"	40	129	24	FLV1554-4000		\$2,143	\$2,356
	15	47 7/8"	40	118	21	FLT1548-4000	\$1,287		
	15	47 7/8"	40	118	21	FLV1548-4000		\$2,069	\$2,276
	15	41 7/8"	40	108	19	FLT1542-4000	\$1,245		
	15	41 7/8"	40	108	19	FLV1542-4000		\$2,002	\$2,202



54" wide



48" wide



42" wide

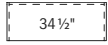
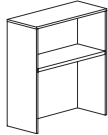
Features:

- use with primary height units, fastening hardware included
- laminate grain direction runs horizontal on back panel of overhead cabinets
- 23" vertical clearance between worksurface and bottom of cabinet, excluding task light
- two 5/8" dia. holes in upper corners of back panel for task light wiring access
- exterior back panel unfinished

Options:

- must specify chassis grain direction on double cut veneer, see pages 13-15 for details
- tackboard or markerboard available, see pages 292-295
- tasklights available, see page 455

Open Storage Overhead Cabinet	15	35 7/8"	40	90	16	FLT1536-4000	\$1,181		
	15	35 7/8"	40	90	16	FLV1536-4000		\$1,897	\$2,087
	15	29 7/8"	40	80	14	FLT1530-4000	\$1,131		
	15	29 7/8"	40	80	14	FLV1530-4000		\$1,820	\$2,002



36" wide



30" wide

Features:

- use with primary height units, fastening hardware included
- laminate grain direction runs horizontal on back panel of overhead cabinets
- 23" vertical clearance between worksurface and bottom of cabinet, excluding task light
- two 5/8" dia. holes in upper corners of back panel for task light wiring access
- exterior back panel unfinished

Options:

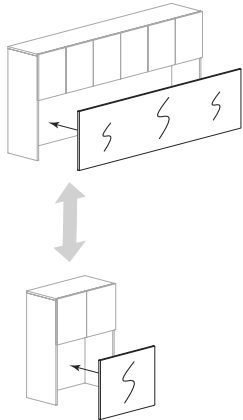
- must specify chassis grain direction on double cut veneer, see pages 13-15 for details
- tackboard or markerboard available, see pages 292-295
- tasklights available, see page 455

To Order, Specify:

1 Laminate Model #	2 Laminate Selection	3 Metal Color	4 Other Product Options
Laminate (FLT)	See Laminate Selection	See Metal Finish Color Options	See list of options for each specific unit; Specify and add accordingly.

1 Veneer Model #	2 Wood Species	3 Wood Finish	4 Metal Color	5 Other Product Options
Veneer (FLV)	Flat Cut CH1 Cherry MA1 Maple WA1 Walnut BO1 Black Oak	See Flat Cut Wood Finish Options	See Metal Finish Color Options	See list of options for each specific unit; Specify and add accordingly.
		<table border="1"> <thead> <tr> <th>3a Wood Finish</th> <th>3b Chassis Grain Direction</th> </tr> </thead> <tbody> <tr> <td>See Double Cut Wood Finish Options</td> <td>For Double Cut Only: Vertical Horizontal</td> </tr> </tbody> </table>		
3a Wood Finish	3b Chassis Grain Direction			
See Double Cut Wood Finish Options	For Double Cut Only: Vertical Horizontal			

Description	D	W	H	CTN WT	CU FT	① Model	List Price
Overhead Cabinet Markerboard Panel	¹³ / ₁₆	94 ¼	22	57	5	FLB9523CMB	\$1,311
	¹³ / ₁₆	88 ¼	22	53	4	FLB8923CMB	\$1,229
	¹³ / ₁₆	82 ¼	22	69	6	FLB8323CMB	\$1,146
	¹³ / ₁₆	76 ¼	22	46	4	FLB7723CMB	\$1,062
	¹³ / ₁₆	70 ¼	22	42	4	FLB7123CMB	\$979
	¹³ / ₁₆	64 ¼	22	54	4	FLB6523CMB	\$895
	¹³ / ₁₆	58 ¼	22	35	3	FLB5923CMB	\$813
	¹³ / ₁₆	52 ¼	22	32	3	FLB5323CMB	\$729
	¹³ / ₁₆	46 ¼	22	28	3	FLB4723CMB	\$647
	¹³ / ₁₆	40 ¼	22	25	2	FLB4123CMB	\$562
	¹³ / ₁₆	34 ¼	22	21	2	FLB3523CMB	\$479
	¹³ / ₁₆	28 ¼	22	18	2	FLB2923CMB	\$397

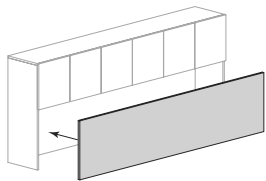


Features:

- use with 40”h and 52”h overhead cabinets
- standard markerboard laminate with aluminum pvc edge
- attaches to cabinet interior, mounting hardware included

FLUX - PRIVATE OFFICE

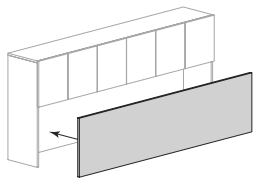
Description	D	W	H	CTN WT	CU FT	① Model	List Price Per Grade
96”w Tackboard for Overhead Cabinet	¹³ / ₁₆	94 ¼	22	25	4	FLB9522TK	COM \$745
							A \$783
							B \$855
							C \$982
							D \$1,148
							E \$1,311
							F \$1,568
							G \$1,844
							H \$2,136
							I \$2,593
							J \$3,142



Features:

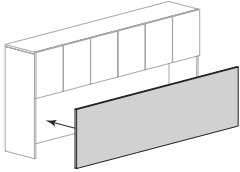
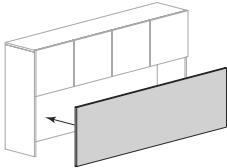
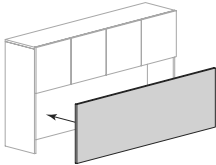
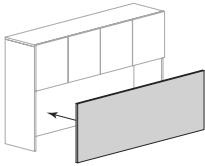
- for use with 96” wide storage overhead cabinet
- use with 40”h and 52”h overhead cabinets
- attaches to cabinet interior, mounting hardware included
- com ydg: 3

90”w Tackboard for Overhead Cabinet	¹³ / ₁₆	88 ¼	22	23	4	FLB8922TK	COM \$713
							A \$748
							B \$814
							C \$931
							D \$1,083
							E \$1,234
							F \$1,471
							G \$1,721
							H \$1,990
							I \$2,407
							J \$2,910



Features:

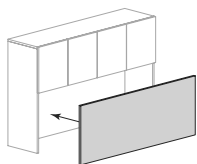
- for use with 90”w storage overhead cabinet
- use with 40”h and 52”h overhead cabinets
- attaches to cabinet interior, mounting hardware included
- com ydg: 2 ¾

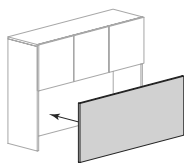
Description	D	W	H	CTN WT	CU FT	① Model	List Price Per Grade
84" w Tackboard for Overhead Cabinet 	13/16	82 1/4	22	22	4	FLB8322TK	COM \$681 A \$712 B \$773 C \$881 D \$1,018 E \$1,154 F \$1,368 G \$1,597 H \$1,841 I \$2,222 J \$2,679
Features: <ul style="list-style-type: none"> · for use with 84" w storage overhead cabinet · use with 40" h and 52" h overhead cabinets · attaches to cabinet interior, mounting hardware included · com ydg: 2 1/2 							
78" w Tackboard for Overhead Cabinet 	13/16	76 1/4	22	20	4	FLB7722TK	COM \$648 A \$680 B \$740 C \$847 D \$986 E \$1,121 F \$1,336 G \$1,564 H \$1,808 I \$2,189 J \$2,646
Features: <ul style="list-style-type: none"> · for use with 78" w storage overhead cabinet · use with 40" h and 52" h overhead cabinets · attaches to cabinet interior, mounting hardware included · com ydg: 2 1/2 							
72" w Tackboard for Overhead Cabinet 	13/16	70 1/4	22	19	3	FLB7122TK	COM \$617 A \$646 B \$699 C \$796 D \$920 E \$1,042 F \$1,235 G \$1,441 H \$1,661 I \$2,002 J \$2,415
Features: <ul style="list-style-type: none"> · for use with 72" w storage overhead cabinet · use with 40" h and 52" h overhead cabinets · attaches to cabinet interior, mounting hardware included · com ydg: 2 1/4 							
66" w Tackboard for Overhead Cabinet 	13/16	64 1/4	22	17	3	FLB6522TK	COM \$584 A \$608 B \$658 C \$743 D \$852 E \$964 F \$1,132 G \$1,318 H \$1,512 I \$1,817 J \$2,182
Features: <ul style="list-style-type: none"> · for use with 66" w storage overhead cabinet · use with 40" h and 52" h overhead cabinets · attaches to cabinet interior, mounting hardware included · com ydg: 2 							

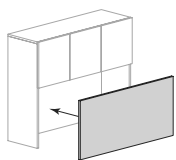
FLUX - PRIVATE OFFICE

To Order, Specify:

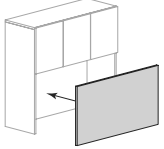
① Model Number	② Fabric Selection
(FLB)	Vendor Pattern Color Visit www.jsifurniture.com/finishes-and-materials/textiles for our textiles program. See selection of standard and graded in manufacturers and patterns.

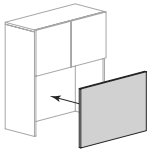
Description	D	W	H	CTN WT	CU FT	① Model	List Price Per Grade	
60" w Tackboard for Overhead Cabinet 	13 1/6	58 1/4	22	15	3	FLB5922TK	COM \$552	
							A \$577	
Features: <ul style="list-style-type: none"> · for use with 60" w storage overhead cabinet · use with 40" h and 52" h overhead cabinets · attaches to cabinet interior, mounting hardware included · com ydg: 2 	<td>B \$625</td>							B \$625
	<td>C \$711</td>							C \$711
	<td>D \$819</td>							D \$819
	<td>E \$929</td>							E \$929
	<td>F \$1,101</td>							F \$1,101
	<td>G \$1,285</td>							G \$1,285
	<td>H \$1,479</td>							H \$1,479
	<td>I \$1,784</td>							I \$1,784
	<td>J \$2,149</td>							J \$2,149

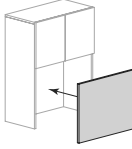
54" w Tackboard for Overhead Cabinet 	13 1/6	52 1/4	22	14	3	FLB5322TK	COM \$520	
							A \$542	
Features: <ul style="list-style-type: none"> · for use with 54" w storage overhead cabinet · use with 40" h and 52" h overhead cabinets · attaches to cabinet interior, mounting hardware included · com ydg: 1 3/4 	<td>B \$584</td>							B \$584
	<td>C \$659</td>							C \$659
	<td>D \$755</td>							D \$755
	<td>E \$851</td>							E \$851
	<td>F \$1,000</td>							F \$1,000
	<td>G \$1,161</td>							G \$1,161
	<td>H \$1,331</td>							H \$1,331
	<td>I \$1,598</td>							I \$1,598
	<td>J \$1,918</td>							J \$1,918

48" w Tackboard for Overhead Cabinet 	13 1/6	46 1/4	22	12	2	FLB4722TK	COM \$486	
							A \$506	
Features: <ul style="list-style-type: none"> · for use with 48" w storage overhead cabinet · use with 40" h and 52" h overhead cabinets · attaches to cabinet interior, mounting hardware included · com ydg: 1 1/2 	<td>B \$542</td>							B \$542
	<td>C \$606</td>							C \$606
	<td>D \$688</td>							D \$688
	<td>E \$772</td>							E \$772
	<td>F \$899</td>							F \$899
	<td>G \$1,037</td>							G \$1,037
	<td>H \$1,183</td>							H \$1,183
	<td>I \$1,412</td>							I \$1,412
	<td>J \$1,686</td>							J \$1,686

FLUX - PRIVATE OFFICE

Description	D	W	H	CTN WT	CU FT	① Model	List Price Per Grade	
42" w Tackboard for Overhead Cabinet 	13/16	40 1/4	22	11	2	FLB4122TK	COM \$456	
	Features:							A \$474
	· for use with 42" w storage overhead cabinet							B \$511
	· use with 40" h and 52" h overhead cabinets							C \$576
	· attaches to cabinet interior, mounting hardware included							D \$658
	· com ydg: 1 1/2							E \$740
								F \$868
								G \$1,003
								H \$1,152
								I \$1,380
								J \$1,655

36" w Tackboard for Overhead Cabinet 	13/16	34 1/4	22	9	2	FLB3522TK	COM \$423	
	Features:							A \$437
	· for use with 36" w storage overhead cabinet							B \$469
	· use with 40" h and 52" h overhead cabinets							C \$522
	· attaches to cabinet interior, mounting hardware included							D \$593
	· com ydg: 1 1/4							E \$661
								F \$767
								G \$882
								H \$1,002
								I \$1,193
								J \$1,422

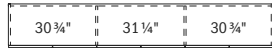
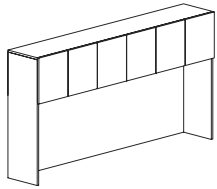
30" w Tackboard Overhead Cabinet 	13/16	28 1/4	22	8	2	FLB2922TK	COM \$390	
	Features:							A \$402
	· for use with 30" w storage overhead cabinet							B \$427
	· use with 40" h and 52" h overhead cabinets							C \$470
	· attaches to cabinet interior, mounting hardware included							D \$524
	· com ydg: 1							E \$580
								F \$666
								G \$757
								H \$854
								I \$1,007
								J \$1,188

To Order, Specify:

① Model Number	② Fabric Selection	
(FLB)	Vendor Pattern Color	Visit www.jsifurniture.com/finishes-and-materials/textiles for our textiles program. See selection of standard and graded in manufacturers and patterns.

FLUX - PRIVATE OFFICE

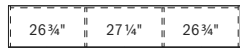
Description	D	W	H	CTN WT	CU FT	① Model	Laminate	Flat Cut Veneer	Double Cut Veneer
Storage Overhead Cabinet with Four Doors	15 $\frac{7}{8}$ "	95 $\frac{7}{8}$ "	48"	254	51	FLT1696-48SO	\$2,322		
	15 $\frac{7}{8}$ "	95 $\frac{7}{8}$ "	48"	254	51	FLV1696-48SO		\$3,933	\$4,327
	15 $\frac{7}{8}$ "	89 $\frac{7}{8}$ "	48"	241	48	FLT1690-48SO	\$2,182		
	15 $\frac{7}{8}$ "	89 $\frac{7}{8}$ "	48"	241	48	FLV1690-48SO		\$3,696	\$4,065
	15 $\frac{7}{8}$ "	83 $\frac{7}{8}$ "	48"	228	45	FLT1684-48SO	\$2,039		
	15 $\frac{7}{8}$ "	83 $\frac{7}{8}$ "	48"	228	45	FLV1684-48SO		\$3,452	\$3,795



96" wide



90" wide



84" wide

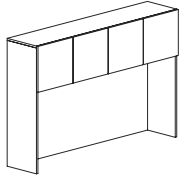
Features:

- use with secondary height units, fastening hardware included
- laminate grain direction runs horizontal on back panel of overhead cabinets
- 1/4" overhang at the bottom of the door allows access
- 30 3/4" vertical clearance between worksurface and bottom of door, excluding task light
- two 5/8" dia. holes in upper corners of back panel for task light wiring access
- exterior back panel unfinished

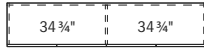
Options:

- must specify chassis grain direction on double cut veneer, see pages 13-15 for details
- veneer door fronts in paint available, specify paint color and add \$337 list; see page 16 for details
- on laminate units, contrasting laminate door fronts available, no upcharge; specify laminate color, see page 16 for details
- white glass doors with aluminum trim available, specify and add \$3,348 list; see page 33 for details
- markerboard laminate doors available, specify and add \$1,144 list; see page 33 for details
- locking doors available, specify and add \$426 list (not available on glass doors)
- tackboard or markerboard available, see pages 306-309
- tasklights available, see page 455

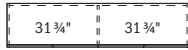
Description	D	W	H	CTN WT	CU FT	① Model	Laminate	Flat Cut Veneer	Double Cut Veneer
Storage Overhead Cabinet with Four Doors	15 7/8	77 7/8	48	220	42	FLT1678-48S0	\$1,898		
	15 7/8	77 7/8	48	220	42	FLV1678-48S0		\$3,112	\$3,423
	15 7/8	71 7/8	48	197	39	FLT1672-48S0	\$1,789		
	15 7/8	71 7/8	48	197	39	FLV1672-48S0		\$2,933	\$3,225
	15 7/8	65 7/8	48	189	36	FLT1666-48S0	\$1,692		
	15 7/8	65 7/8	48	189	36	FLV1666-48S0		\$2,768	\$3,048
	15 7/8	59 7/8	48	175	33	FLT1660-48S0	\$1,619		
	15 7/8	59 7/8	48	175	33	FLV1660-48S0		\$2,647	\$2,911



78" wide



72" wide



66" wide



60" wide

Features:

- use with secondary height units, fastening hardware included
- laminate grain direction runs horizontal on back panel of overhead cabinets
- 1/4" overhang at the bottom of the door allows access
- 30 3/4" vertical clearance between worksurface and bottom of door, excluding task light
- two 5/8" dia. holes in upper corners of back panel for task light wiring access
- exterior back panel unfinished

Options:

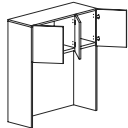
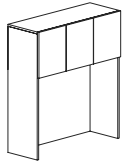
- must specify chassis grain direction on double cut veneer, see pages 13-15 for details
- veneer door fronts in paint available, specify paint color and add \$337 list; see page 16 for details
- on laminate units, contrasting laminate door fronts available, no upcharge; specify laminate color, see page 16 for details
- white glass doors with aluminum trim available, specify and add \$2,433 list for 78"w, \$2,321 list for 72"w, \$2,234 list for 66"w or 60"w; see page 33 for details
- markerboard laminate doors available, specify and add \$763 list; see page 33 for details
- locking doors available, specify and add \$284 list (not available on glass doors)
- tackboard or markerboard available, see pages 306-309
- tasklights available, see page 455

To Order, Specify:

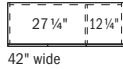
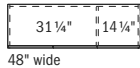
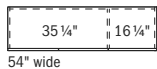
① Laminate Model #	② Laminate Selection	③ Metal Color	④ Other Product Options
Laminate (FLT)	See Laminate Selection	See Metal Finish Color Options	See list of options for each specific unit; Specify and add accordingly.

① Veneer Model #	② Wood Species	③ Wood Finish	④ Metal Color	⑤ Other Product Options
Veneer (FLV)	Flat Cut CH1 Cherry MA1 Maple WA1 Walnut BO1 Black Oak	See Flat Cut Wood Finish Options	See Metal Finish Color Options	See list of options for each specific unit; Specify and add accordingly.
		<table border="1"> <thead> <tr> <th>③a Wood Finish</th> <th>③b Chassis Grain Direction</th> </tr> </thead> <tbody> <tr> <td>See Double Cut Wood Finish Options</td> <td>For Double Cut Only: Vertical Horizontal</td> </tr> </tbody> </table>		
③a Wood Finish	③b Chassis Grain Direction			
See Double Cut Wood Finish Options	For Double Cut Only: Vertical Horizontal			

Description	D	W	H	CTN WT	CU FT	① Model	Laminate	Flat Cut Veneer	Double Cut Veneer
Storage Overhead Cabinet with Three Doors	15 7/8	53 7/8	48	162	29	FLT1654-48SOR	\$1,581		
	15 7/8	53 7/8	48	162	29	FLV1654-48SOR		\$2,548	\$2,803
	15 7/8	53 7/8	48	162	29	FLT1654-48SOL	\$1,581		
	15 7/8	53 7/8	48	162	29	FLV1654-48SOL		\$2,548	\$2,803
	15 7/8	47 7/8	48	148	26	FLT1648-48SOR	\$1,528		
	15 7/8	47 7/8	48	148	26	FLV1648-48SOR		\$2,459	\$2,706
	15 7/8	47 7/8	48	148	26	FLT1648-48SOL	\$1,528		
	15 7/8	47 7/8	48	148	26	FLV1648-48SOL		\$2,459	\$2,706
	15 7/8	41 7/8	48	134	23	FLT1642-48SOR	\$1,479		
	15 7/8	41 7/8	48	134	23	FLV1642-48SOR		\$2,384	\$2,621
	15 7/8	41 7/8	48	134	23	FLT1642-48SOL	\$1,479		
	15 7/8	41 7/8	48	134	23	FLV1642-48SOL		\$2,384	\$2,621



right shown



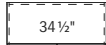
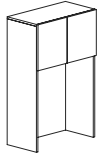
Features:

- use with secondary height units, fastening hardware included
- laminate grain direction runs horizontal on back panel of overhead cabinets
- 1/4" overhang at the bottom of the door allows access
- 30 3/4" vertical clearance between worksurface and bottom of door, excluding task light
- two 5/8" dia. holes in upper corners of back panel for task light wiring access
- exterior back panel unfinished

Options:

- must specify chassis grain direction on double cut veneer, see pages 13-15 for details
- veneer door fronts in paint available, specify paint color and add \$337 list; see page 16 for details
- on laminate units, contrasting laminate door fronts available, no upcharge; specify laminate color, see page 16 for details
- white glass doors with aluminum trim available, specify and add \$1,742 list for 54"w, \$1,675 list for 48"w or 42"w; see page 33 for details
- markerboard laminate doors available, specify and add \$574 list; see page 33 for details
- locking doors available, specify and add \$284 list (not available on glass doors)
- tackboard or markerboard available, see pages 306-309
- tasklights available, see page 455

Description	D	W	H	CTN WT	CU FT	① Model	Laminate	Flat Cut Veneer	Double Cut Veneer
Storage Overhead Cabinet with Two Doors	15 7/8	35 7/8	48	113	20	FLT1636-48SO	\$1,404		
	15 7/8	35 7/8	48	113	20	FLV1636-48SO		\$2,259	\$2,486
	15 7/8	29 7/8	48	100	17	FLT1630-48SO	\$1,344		
	15 7/8	29 7/8	48	100	17	FLV1630-48SO		\$2,164	\$2,378



36" wide



30" wide

Features:

- use with secondary height units, fastening hardware included
- laminate grain direction runs horizontal on back panel of overhead cabinets
- 1/4" overhang at the bottom of the door allows access
- 30 3/4" vertical clearance between worksurface and bottom of door, excluding task light
- two 5/8" dia. holes in upper corners of back panel for task light wiring access
- exterior back panel unfinished

Options:

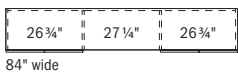
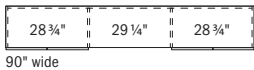
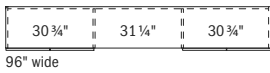
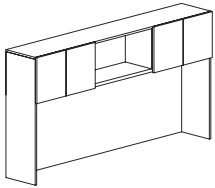
- must specify chassis grain direction on double cut veneer, see pages 13-15 for details
- veneer door fronts in paint available, specify paint color and add \$337 list; see page 16 for details
- on laminate units, contrasting laminate door fronts available, no upcharge; specify laminate color, see page 16 for details
- white glass doors with aluminum trim available, specify and add \$1,163 list for 36"w, \$1,119 list for 30"w; see page 33 for details
- markerboard laminate doors available, specify and add \$385 list; see page 33 for details
- locking doors available, specify and add \$142 list (not available on glass doors)
- tackboard or markerboard available, see pages 306-309
- tasklights available, see page 455

To Order, Specify:

① Laminate Model #	② Laminate Selection		③ Metal Color	④ Other Product Options
Laminate (FLT)	See Laminate Selection		See Metal Finish Color Options	See list of options for each specific unit; Specify and add accordingly.

① Veneer Model #	② Wood Species	③ Wood Finish		④ Metal Color	⑤ Other Product Options
Veneer (FLV)	Flat Cut CH1 Cherry MA1 Maple WA1 Walnut BO1 Black Oak	See Flat Cut Wood Finish Options		See Metal Finish Color Options	See list of options for each specific unit; Specify and add accordingly.
		3a Wood Finish	3b Chassis Grain Direction		
	Double Cut DC1 Double Cut	See Double Cut Wood Finish Options	For Double Cut Only: Vertical Horizontal		

Description	D	W	H	CTN WT	CU FT	① Model	Laminate	Flat Cut Veneer	Double Cut Veneer
Storage Overhead Cabinet with Four Doors with Open Center	15 7/8"	95 7/8"	48"	242	51	FLT1696-48SMO	\$2,208		
	15 7/8"	95 7/8"	48"	242	51	FLV1696-48SMO		\$3,741	\$4,114
	15 7/8"	89 7/8"	48"	230	48	FLT1690-48SMO	\$2,044		
	15 7/8"	89 7/8"	48"	230	48	FLV1690-48SMO		\$3,461	\$3,808
	15 7/8"	83 7/8"	48"	217	45	FLT1684-48SMO	\$1,881		
	15 7/8"	83 7/8"	48"	217	45	FLV1684-48SMO		\$3,182	\$3,501



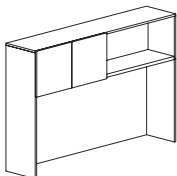
Features:

- use with secondary height units, fastening hardware included
- laminate grain direction runs horizontal on back panel of overhead cabinets
- 1/4" overhang at the bottom of the door allows access
- 30 3/4" vertical clearance between worksurface and bottom of door, excluding task light
- two 5/8" dia. holes in upper corners of back panel for task light wiring access
- exterior back panel unfinished

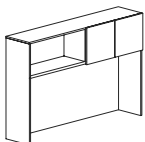
Options:

- must specify chassis grain direction on double cut veneer, see pages 13-15 for details
- veneer door fronts in paint available, specify paint color and add \$337 list; see page 16 for details
- on laminate units, contrasting laminate door fronts available, no upcharge; specify laminate color, see page 16 for details
- white glass doors with aluminum trim available, specify and add \$2,234 list; see page 33 for details
- markerboard laminate doors available, specify and add \$763 list; see page 33 for details
- locking doors available, specify and add \$284 list (not available on glass doors)
- tackboard or markerboard available, see pages 306-309
- tasklights available, see page 455

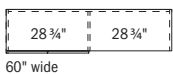
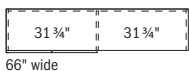
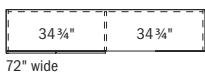
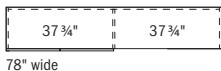
Storage Overhead Cabinet with Two Doors with Open Compartment	15 7/8"	77 7/8"	48"	196	42	FLT1678-48SMOR	\$1,809		
	15 7/8"	77 7/8"	48"	196	42	FLV1678-48SMOR		\$2,961	\$3,257
	15 7/8"	77 7/8"	48"	196	42	FLT1678-48SMOL	\$1,809		
	15 7/8"	77 7/8"	48"	196	42	FLV1678-48SMOL		\$2,961	\$3,257
	15 7/8"	71 7/8"	48"	184	39	FLT1672-48SMOR	\$1,703		
	15 7/8"	71 7/8"	48"	184	39	FLV1672-48SMOR		\$2,791	\$3,069
	15 7/8"	71 7/8"	48"	184	39	FLT1672-48SMOL	\$1,703		
	15 7/8"	71 7/8"	48"	184	39	FLV1672-48SMOL		\$2,791	\$3,069
	15 7/8"	65 7/8"	48"	177	36	FLT1666-48SMOR	\$1,612		
	15 7/8"	65 7/8"	48"	177	36	FLV1666-48SMOR		\$2,638	\$2,902
	15 7/8"	65 7/8"	48"	177	36	FLT1666-48SMOL	\$1,612		
	15 7/8"	65 7/8"	48"	177	36	FLV1666-48SMOL		\$2,638	\$2,902
	15 7/8"	59 7/8"	48"	164	33	FLT1660-48SMOR	\$1,540		
	15 7/8"	59 7/8"	48"	164	33	FLV1660-48SMOR		\$2,520	\$2,771
	15 7/8"	59 7/8"	48"	164	33	FLT1660-48SMOL	\$1,540		
	15 7/8"	59 7/8"	48"	164	33	FLV1660-48SMOL		\$2,520	\$2,771



left shown



right



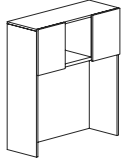
Features:

- use with secondary height units, fastening hardware included
- laminate grain direction runs horizontal on back panel of overhead cabinets
- 1/4" overhang at the bottom of the door allows access
- 30 3/4" vertical clearance between worksurface and bottom of door, excluding task light
- two 5/8" dia. holes in upper corners of back panel for task light wiring access
- exterior back panel unfinished

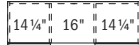
Options:

- must specify chassis grain direction on double cut veneer, see pages 13-15 for details
- veneer door fronts in paint available, specify paint color and add \$337 list; see page 16 for details
- on laminate units, contrasting laminate door fronts available, no upcharge; specify laminate color, see page 16 for details
- white glass doors with aluminum trim available, specify and add \$1,218 list for 78"w, \$1,163 list for 72"w, \$1,119 list for 66"w or 60"w; see page 33 for details
- markerboard laminate doors available, specify and add \$385 list; see page 33 for details
- locking doors available, specify and add \$142 list (not available on glass doors)
- tackboard or markerboard available, see pages 306-309
- tasklights available, see page 455

Description	D	W	H	CTN WT	CU FT	1 Model	Laminate	Flat Cut Veneer	Double Cut Veneer
Storage Overhead Cabinet with Two Doors with Open Center	15 7/8	53 7/8	48	159	29	FLT1654-48SMO	\$1,819		
	15 7/8	53 7/8	48	159	29	FLV1654-48SMO		\$2,755	\$3,027
	15 7/8	47 7/8	48	146	26	FLT1648-48SMO	\$1,758		
	15 7/8	47 7/8	48	146	26	FLV1648-48SMO		\$2,663	\$2,931
	15 7/8	41 7/8	48	133	23	FLT1642-48SMO	\$1,703		
	15 7/8	41 7/8	48	133	23	FLV1642-48SMO		\$2,580	\$2,838



54" wide



48" wide



42" wide

Features:

- use with secondary height units, fastening hardware included
- laminate grain direction runs horizontal on back panel of overhead cabinets
- 1/4" overhang at the bottom of the door allows access
- 30 3/4" vertical clearance between worksurface and bottom of door, excluding task light
- two 5/8" dia. holes in upper corners of back panel for task light wiring access
- exterior back panel unfinished

Options:

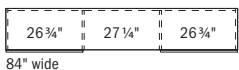
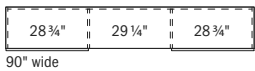
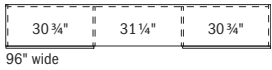
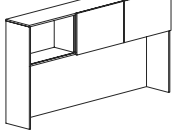
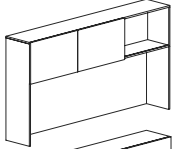
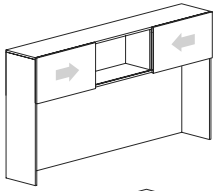
- must specify chassis grain direction on double cut veneer, see pages 13-15 for details
- veneer door fronts in paint available, specify paint color and add \$337 list; see page 16 for details
- on laminate units, contrasting laminate door fronts available, no upcharge; specify laminate color, see page 16 for details
- white glass doors with aluminum trim available, specify and add \$1,163 list for 54"w, \$1,119 list for 48"w or 42"w; see page 33 for details
- markerboard laminate doors available, specify and add \$385 list; see page 33 for details
- locking doors available, specify and add \$142 list (not available on glass doors)
- tackboard or markerboard available, see pages 306-309
- tasklights available, see page 455

To Order, Specify:

1 Laminate Model #	2 Laminate Selection	3 Metal Color	4 Other Product Options
Laminate (FLT)	See Laminate Selection	See Metal Finish Color Options	See list of options for each specific unit; Specify and add accordingly.

1 Veneer Model #	2 Wood Species	3 Wood Finish	4 Metal Color	5 Other Product Options
Veneer (FLV)	Flat Cut CH1 Cherry MA1 Maple WA1 Walnut BO1 Black Oak	See Flat Cut Wood Finish Options	See Metal Finish Color Options	See list of options for each specific unit; Specify and add accordingly.
		<table border="1"> <thead> <tr> <th>3a Wood Finish</th> <th>3b Chassis Grain Direction</th> </tr> </thead> <tbody> <tr> <td>See Double Cut Wood Finish Options</td> <td>For Double Cut Only: Vertical Horizontal</td> </tr> </tbody> </table>		
3a Wood Finish	3b Chassis Grain Direction			
See Double Cut Wood Finish Options	For Double Cut Only: Vertical Horizontal			

Description	D	W	H	CTN WT	CU FT	① Model	Laminate	Flat Cut Veneer	Double Cut Veneer
Storage Overhead Cabinet with Sliding Door	15 15/16	95 7/8	48	251	51	FLT1696-48SD	\$2,602		
	15 15/16	95 7/8	48	251	51	FLV1696-48SD		\$4,264	\$4,692
	15 15/16	89 7/8	48	239	48	FLT1690-48SD	\$2,413		
	15 15/16	89 7/8	48	239	48	FLV1690-48SD		\$3,954	\$4,350
	15 15/16	83 7/8	48	226	45	FLT1684-48SD	\$2,221		
	15 15/16	83 7/8	48	226	45	FLV1684-48SD		\$3,639	\$4,003



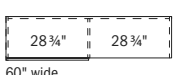
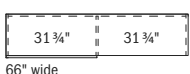
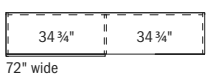
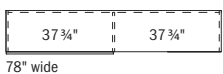
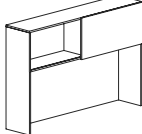
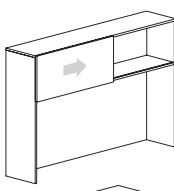
Features:

- use with secondary height units, fastening hardware included
- laminate grain direction runs horizontal on back panel of overhead cabinets
- 30 3/4" vertical clearance between worksurface and bottom of door, excluding task light
- two 5/8" dia. holes in upper corners of back panel for task light wiring access
- exterior back panel unfinished
- locking not available

Options:

- must specify chassis grain direction on double cut veneer, see pages 13-15 for details
- veneer door fronts in paint available, specify paint color and add \$337 list; see page 16 for details
- on laminate units, contrasting laminate door fronts available, no upcharge; specify laminate color, see page 16 for details
- white glass doors with aluminum trim available, specify and add \$1,787 list for 96"w, \$1,714 list for 90"w, \$1,639 list for 84"w; see page 33 for details
- markerboard laminate doors available, specify and add \$569 list; see page 33 for details
- tackboard or markerboard available, see pages 306-309
- tasklights available, see page 455

Storage Overhead Cabinet with Sliding Door	15 15/16	77 7/8	48	203	42	FLT1678-48SD	\$2,138		
	15 15/16	77 7/8	48	203	42	FLV1678-48SD		\$3,391	\$3,730
	15 15/16	71 7/8	48	190	39	FLT1672-48SD	\$2,016		
	15 15/16	71 7/8	48	190	39	FLV1672-48SD		\$3,201	\$3,520
	15 15/16	65 7/8	48	178	36	FLT1666-48SD	\$1,909		
	15 15/16	65 7/8	48	178	36	FLV1666-48SD		\$3,027	\$3,331
	15 15/16	59 7/8	48	166	33	FLT1660-48SD	\$1,825		
	15 15/16	59 7/8	48	166	33	FLV1660-48SD		\$2,896	\$3,186



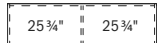
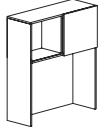
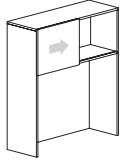
Features:

- use with secondary height units, fastening hardware included
- laminate grain direction runs horizontal on back panel of overhead cabinets
- 30 3/4" vertical clearance between worksurface and bottom of door, excluding task light
- two 5/8" dia. holes in upper corners of back panel for task light wiring access
- exterior back panel unfinished
- locking not available

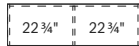
Options:

- must specify chassis grain direction on double cut veneer, see pages 13-15 for details
- veneer door fronts in paint available, specify paint color and add \$337 list; see page 16 for details
- on laminate units, contrasting laminate door fronts available, no upcharge; specify laminate color, see page 16 for details
- white glass doors with aluminum trim available, specify and add \$1,029 list for 78"w, \$971 list for 72"w, \$916 list for 66"w \$837 list for 60"w; see page 33 for details
- markerboard laminate doors available, specify and add \$286 list; see page 33 for details
- tackboard or markerboard available, see pages 306-309
- tasklights available, see page 455

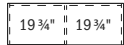
Description	D	W	H	CTN WT	CU FT	① Model	Laminate	Flat Cut Veneer	Double Cut Veneer
Storage Overhead Cabinet with Sliding Door	15 15/16	53 7/8	48	153	30	FLT1654-48SD	\$1,785		
	15 15/16	53 7/8	48	153	30	FLV1654-48SD		\$2,790	\$3,067
	15 15/16	47 7/8	48	141	26	FLT1648-48SD	\$1,728		
	15 15/16	47 7/8	48	141	26	FLV1648-48SD		\$2,696	\$2,967
	15 15/16	41 7/8	48	128	23	FLT1642-48SD	\$1,673		
	15 15/16	41 7/8	48	128	23	FLV1642-48SD		\$2,614	\$2,876



54" wide



48" wide



42" wide

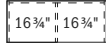
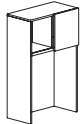
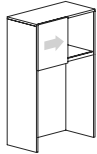
Features:

- use with secondary height units, fastening hardware included
- laminate grain direction runs horizontal on back panel of overhead cabinets
- 30 3/4" vertical clearance between worksurface and bottom of door, excluding task light
- two 5/8" dia. holes in upper corners of back panel for task light wiring access
- exterior back panel unfinished
- locking not available

Options:

- must specify chassis grain direction on double cut veneer, see pages 13-15 for details
- veneer door fronts in paint available, specify paint color and add \$337 list; see page 16 for details
- on laminate units, contrasting laminate door fronts available, no upcharge; specify laminate color, see page 16 for details
- white glass doors with aluminum trim available, specify and add \$803 list for 54"w, \$778 list for 48"w, \$748 list for 42"w; see page 33 for details
- markerboard laminate doors available, specify and add \$286 list; see page 33 for details
- tackboard or markerboard available, see pages 306-309
- tasklights available, see page 455

Storage Overhead Cabinet with Sliding Door	15 15/16	35 7/8	48	116	20	FLT1636-48SD	\$1,589		
	15 15/16	35 7/8	48	116	20	FLV1636-48SD		\$2,480	\$2,727
	15 15/16	29 7/8	48	104	17	FLT1630-48SD	\$1,525		
	15 15/16	29 7/8	48	104	17	FLV1630-48SD		\$2,378	\$2,616



36" wide



30" wide

Features:

- use with secondary height units, fastening hardware included
- laminate grain direction runs horizontal on back panel of overhead cabinets
- 30 3/4" vertical clearance between worksurface and bottom of door, excluding task light
- two 5/8" dia. holes in upper corners of back panel for task light wiring access
- exterior back panel unfinished
- locking not available

Options:

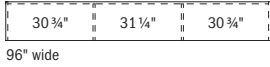
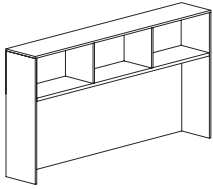
- must specify chassis grain direction on double cut veneer, see pages 13-15 for details
- veneer door fronts in paint available, specify paint color and add \$337 list; see page 16 for details
- on laminate units, contrasting laminate door fronts available, no upcharge; specify laminate color, see page 16 for details
- white glass doors with aluminum trim available, specify and add \$636 list for 36"w, \$607 list for 30"w; see page 33 for details
- markerboard laminate doors available, specify and add \$286 list; see page 33 for details
- tackboard or markerboard available, see pages 306-309
- tasklights available, see page 455

To Order, Specify:

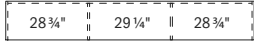
① Laminate Model #	② Laminate Selection	③ Metal Color	④ Other Product Options
Laminate (FLT)	See Laminate Selection	See Metal Finish Color Options	See list of options for each specific unit; Specify and add accordingly.

① Veneer Model #	② Wood Species	③ Wood Finish	④ Metal Color	⑤ Other Product Options
Veneer (FLV)	Flat Cut CH1 Cherry MA1 Maple WA1 Walnut BO1 Black Oak	See Flat Cut Wood Finish Options	See Metal Finish Color Options	See list of options for each specific unit; Specify and add accordingly.
		<table border="1"> <thead> <tr> <th>③a Wood Finish</th> <th>③b Chassis Grain Direction</th> </tr> </thead> <tbody> <tr> <td>See Double Cut Wood Finish Options</td> <td>For Double Cut Only: Vertical Horizontal</td> </tr> </tbody> </table>		
③a Wood Finish	③b Chassis Grain Direction			
See Double Cut Wood Finish Options	For Double Cut Only: Vertical Horizontal			

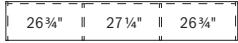
Description	D	W	H	CTN WT	CU FT	① Model	Laminate	Flat Cut Veneer	Double Cut Veneer
Open Storage Overhead Cabinet	15	95 $\frac{7}{8}$ "	48	218	49	FLT1596-4800	\$2,033		
	15	95 $\frac{7}{8}$ "	48	218	49	FLV1596-4800		\$3,440	\$3,785
	15	89 $\frac{7}{8}$ "	48	207	46	FLT1590-4800	\$1,910		
	15	89 $\frac{7}{8}$ "	48	207	46	FLV1590-4800		\$3,230	\$3,554
	15	83 $\frac{7}{8}$ "	48	196	43	FLT1584-4800	\$1,784		
	15	83 $\frac{7}{8}$ "	48	196	43	FLV1584-4800		\$3,018	\$3,320



96" wide



90" wide



84" wide

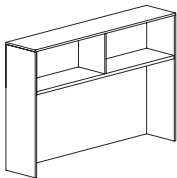
Features:

- use with secondary height units, fastening hardware included
- laminate grain direction runs horizontal on back panel of overhead cabinets
- 31" vertical clearance between worksurface and bottom of cabinet, excluding task light
- two $\frac{5}{8}$ " dia. holes in upper corners of back panel for task light wiring access
- exterior back panel unfinished

Options:

- must specify chassis grain direction on double cut veneer, see pages 13-15 for details
- tackboard or markerboard available, see pages 306-309
- tasklights available, see page 455

Description	D	W	H	CTN WT	CU FT	① Model	Laminate	Flat Cut Veneer	Double Cut Veneer
Open Storage Overhead Cabinet	15	77 $\frac{7}{8}$ "	48	180	40	FLT1578-4800	\$1,663		
	15	77 $\frac{7}{8}$ "	48	180	40	FLV1578-4800		\$2,720	\$2,993
	15	71 $\frac{7}{8}$ "	48	169	37	FLT1572-4800	\$1,566		
	15	71 $\frac{7}{8}$ "	48	169	37	FLV1572-4800		\$2,565	\$2,822
	15	65 $\frac{7}{8}$ "	48	163	34	FLT1566-4800	\$1,480		
	15	65 $\frac{7}{8}$ "	48	163	34	FLV1566-4800		\$2,424	\$2,667
	15	59 $\frac{7}{8}$ "	48	152	31	FLT1560-4800	\$1,415		
	15	59 $\frac{7}{8}$ "	48	152	31	FLV1560-4800		\$2,316	\$2,548



78" wide



72" wide



66" wide



60" wide

Features:

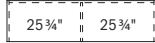
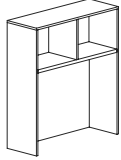
- use with secondary height units, fastening hardware included
- laminate grain direction runs horizontal on back panel of overhead cabinets
- 31" vertical clearance between worksurface and bottom of cabinet, excluding task light
- two $\frac{5}{8}$ " dia. holes in upper corners of back panel for task light wiring access
- exterior back panel unfinished

Options:

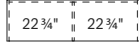
- must specify chassis grain direction on double cut veneer, see pages 13-15 for details
- tackboard or markerboard available, see pages 306-309
- tasklights available, see page 455

FLUX - PRIVATE OFFICE

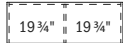
Description	D	W	H	CTN WT	CU FT	① Model	Laminate	Flat Cut Veneer	Double Cut Veneer
Open Storage Overhead Cabinet	15	53 7/8	48	140	28	FLT1554-4800	\$1,383		
	15	53 7/8	48	140	28	FLV1554-4800		\$2,229	\$2,451
	15	47 7/8	48	129	25	FLT1548-4800	\$1,338		
	15	47 7/8	48	129	25	FLV1548-4800		\$2,153	\$2,370
	15	41 7/8	48	117	22	FLT1542-4800	\$1,295		
	15	41 7/8	48	117	22	FLV1542-4800		\$2,084	\$2,292



54" wide



48" wide



42" wide

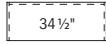
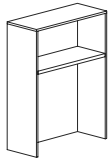
Features:

- use with secondary height units, fastening hardware included
- laminate grain direction runs horizontal on back panel of overhead cabinets
- 31" vertical clearance between worksurface and bottom of cabinet, excluding task light
- two 5/8" dia. holes in upper corners of back panel for task light wiring access
- exterior back panel unfinished

Options:

- must specify chassis grain direction on double cut veneer, see pages 13-15 for details
- tackboard or markerboard available, see pages 306-309
- tasklights available, see page 455

Open Storage Overhead Cabinet	15	35 7/8	48	99	19	FLT1536-4800	\$1,227		
	15	35 7/8	48	99	19	FLV1536-4800		\$1,976	\$2,172
	15	29 7/8	48	88	16	FLT1530-4800	\$1,177		
	15	29 7/8	48	88	16	FLV1530-4800		\$1,892	\$2,082



36" wide



30" wide

Features:

- use with secondary height units, fastening hardware included
- laminate grain direction runs horizontal on back panel of overhead cabinets
- 31" vertical clearance between worksurface and bottom of cabinet, excluding task light
- two 5/8" dia. holes in upper corners of back panel for task light wiring access
- exterior back panel unfinished

Options:

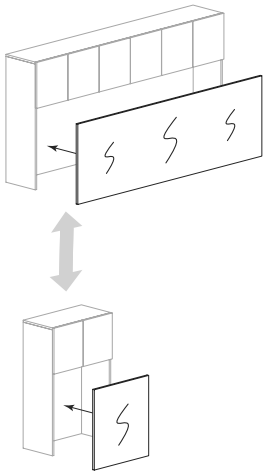
- must specify chassis grain direction on double cut veneer, see pages 13-15 for details
- tackboard or markerboard available, see pages 306-309
- tasklights available, see page 455

To Order, Specify:

① Laminate Model #	② Laminate Selection	③ Metal Color	④ Other Product Options
Laminate (FLT)	See Laminate Selection	See Metal Finish Color Options	See list of options for each specific unit; Specify and add accordingly.

① Veneer Model #	② Wood Species	③ Wood Finish	④ Metal Color	⑤ Other Product Options
Veneer (FLV)	Flat Cut CH1 Cherry MA1 Maple WA1 Walnut BO1 Black Oak	See Flat Cut Wood Finish Options	See Metal Finish Color Options	See list of options for each specific unit; Specify and add accordingly.
		<table border="1"> <thead> <tr> <th>③a Wood Finish</th> <th>③b Chassis Grain Direction</th> </tr> </thead> <tbody> <tr> <td>See Double Cut Wood Finish Options</td> <td>For Double Cut Only: Vertical Horizontal</td> </tr> </tbody> </table>		
③a Wood Finish	③b Chassis Grain Direction			
See Double Cut Wood Finish Options	For Double Cut Only: Vertical Horizontal			

Description	D	W	H	CTN WT	CU FT	① Model	List Price
Overhead Cabinet Markerboard Panel	13/16	94 1/4	30	76	6	FLB9531CMB	\$1,787
	13/16	88 1/4	30	71	6	FLB8931CMB	\$1,674
	13/16	82 1/4	30	67	5	FLB8331CMB	\$1,561
	13/16	76 1/4	30	62	5	FLB7731CMB	\$1,447
	13/16	70 1/4	30	57	5	FLB7131CMB	\$1,336
	13/16	64 1/4	30	52	4	FLB6531CMB	\$1,220
	13/16	58 1/4	30	47	4	FLB5931CMB	\$1,106
	13/16	52 1/4	30	43	4	FLB5331CMB	\$995
	13/16	46 1/4	30	38	3	FLB4731CMB	\$881
	13/16	40 1/4	30	33	3	FLB4131CMB	\$767
	13/16	34 1/4	30	28	3	FLB3531CMB	\$651
	13/16	28 1/4	30	24	2	FLB2931CMB	\$540

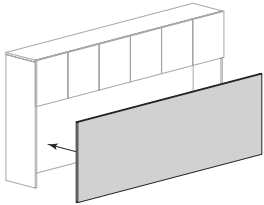


Features:

- use with 48”h overhead cabinets
- standard markerboard laminate with aluminum pvc edge
- attaches to cabinet interior, mounting hardware included

FLUX - PRIVATE OFFICE

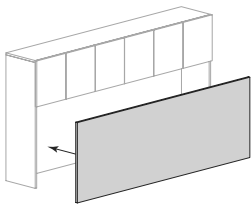
Description	D	W	H	CTN WT	CU FT	① Model	List Price Per Grade
96”w Tackboard for Overhead Cabinet	13/16	94 1/4	30	33	6	FLB9530TK	COM \$929
							A \$968
							B \$1,040
							C \$1,168
							D \$1,334
							E \$1,496
							F \$1,753
							G \$2,027
							H \$2,321
							I \$2,779
							J \$3,328



Features:

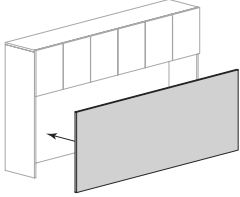
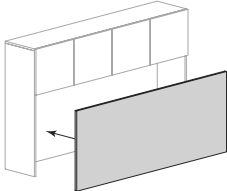
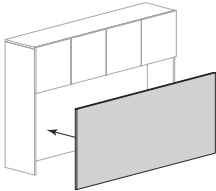
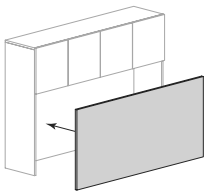
- for use with 96” wide storage overhead cabinet
- use with 48”h overhead cabinets
- attaches to cabinet interior, mounting hardware included
- com ydg: 3

96”w Tackboard for Overhead Cabinet	13/16	88 1/4	30	31	5	FLB8930TK	COM \$886
							A \$921
							B \$988
							C \$1,105
							D \$1,256
							E \$1,407
							F \$1,642
							G \$1,893
							H \$2,161
							I \$2,580
							J \$3,085



Features:

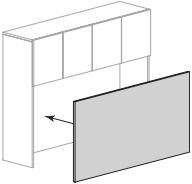
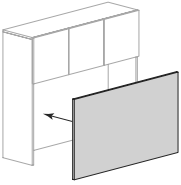
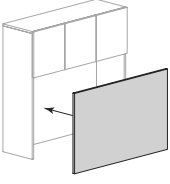
- for use with 90”w storage overhead cabinet
- use with 48”h overhead cabinets
- attaches to cabinet interior, mounting hardware included
- com ydg: 2 3/4

Description	D	W	H	CTN WT	CU FT	① Model	List Price Per Grade
84" w Tackboard for Overhead Cabinet 	13 1/16	82 1/4	30	29	5	FLB8330TK	COM \$843 A \$873 B \$933 C \$1,041 D \$1,178 E \$1,316 F \$1,528 G \$1,757 H \$2,001 I \$2,384 J \$2,840
Features: <ul style="list-style-type: none"> · for use with 84" w storage overhead cabinet · use with 48" h overhead cabinets · attaches to cabinet interior, mounting hardware included · com ydg: 2 1/2 							
78" w Tackboard for Overhead Cabinet 	13 1/16	76 1/4	30	27	5	FLB7730TK	COM \$797 A \$830 B \$888 C \$997 D \$1,134 E \$1,270 F \$1,484 G \$1,713 H \$1,957 I \$2,337 J \$2,797
Features: <ul style="list-style-type: none"> · for use with 78" w storage overhead cabinet · use with 48" h overhead cabinets · attaches to cabinet interior, mounting hardware included · com ydg: 2 1/2 							
72" w Tackboard for Overhead Cabinet 	13 1/16	70 1/4	30	25	4	FLB7130TK	COM \$754 A \$783 B \$837 C \$933 D \$1,057 E \$1,181 F \$1,372 G \$1,579 H \$1,797 I \$2,141 J \$2,552
Features: <ul style="list-style-type: none"> · for use with 72" w storage overhead cabinet · use with 48" h overhead cabinets · attaches to cabinet interior, mounting hardware included · com ydg: 2 1/4 							
66" w Tackboard for Overhead Cabinet 	13 1/16	64 1/4	30	23	4	FLB6530TK	COM \$710 A \$734 B \$783 C \$869 D \$978 E \$1,088 F \$1,258 G \$1,442 H \$1,636 I \$1,942 J \$2,309
Features: <ul style="list-style-type: none"> · for use with 66" w storage overhead cabinet · use with 48" h overhead cabinets · attaches to cabinet interior, mounting hardware included · com ydg: 2 							

FLUX - PRIVATE OFFICE

To Order, Specify:

① Model Number	② Fabric Selection
(FLB)	Vendor Pattern Color Visit www.jsifurniture.com/finishes-and-materials/textiles for our textiles program. See selection of standard and graded in manufacturers and patterns.

Description	D	W	H	CTN WT	CU FT	① Model	List Price Per Grade
60" w Tackboard for Overhead Cabinet 	13/16	58 1/4	30	21	4	FLB5930TK	COM \$667 A \$690 B \$740 C \$825 D \$934 E \$1,044 F \$1,216 G \$1,401 H \$1,593 I \$1,898 J \$2,264
54" w Tackboard for Overhead Cabinet 	13/16	52 1/4	30	19	3	FLB5330TK	COM \$621 A \$645 B \$686 C \$760 D \$857 E \$955 F \$1,103 G \$1,261 H \$1,434 I \$1,700 J \$2,020
48" w Tackboard for Overhead Cabinet 	13/16	46 1/4	30	17	3	FLB4730TK	COM \$578 A \$597 B \$631 C \$696 D \$779 E \$861 F \$991 G \$1,125 H \$1,273 I \$1,503 J \$1,777

Features:

- for use with 60" w storage overhead cabinet
- use with 48" h overhead cabinets
- attaches to cabinet interior, mounting hardware included
- com ydg: 2

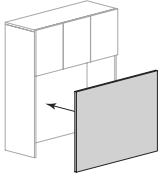
Features:

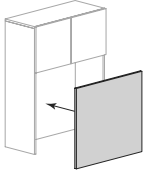
- for use with 54" w storage overhead cabinet
- use with 48" h overhead cabinets
- attaches to cabinet interior, mounting hardware included
- com ydg: 1 3/4

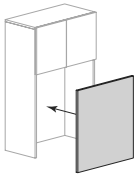
Features:

- for use with 48" w storage overhead cabinet
- use with 48" h overhead cabinets
- attaches to cabinet interior, mounting hardware included
- com ydg: 1 1/2

FLUX - PRIVATE OFFICE

Description	D	W	H	CTN WT	CU FT	① Model	List Price Per Grade	
42" w Tackboard for Overhead Cabinet 	13/16	40 1/4	30	15	3	FLB4130TK	COM \$535	
	Features:							A \$554
	<ul style="list-style-type: none"> · for use with 42" w storage overhead cabinet · use with 48" h overhead cabinets · attaches to cabinet interior, mounting hardware included · com ydg: 1 1/2 							B \$589
								C \$653
								D \$736
								E \$817
								F \$947
								G \$1,083
								H \$1,229
								I \$1,457
								J \$1,734

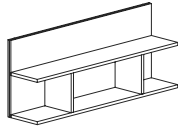
36" w Tackboard for Overhead Cabinet 	13/16	34 1/4	30	12	2	FLB3530TK	COM \$489	
	Features:							A \$505
	<ul style="list-style-type: none"> · for use with 36" w storage overhead cabinet · use with 48" h overhead cabinets · attaches to cabinet interior, mounting hardware included · com ydg: 1 1/4 							B \$536
								C \$589
								D \$659
								E \$727
								F \$834
								G \$948
								H \$1,070
								I \$1,259
								J \$1,489

30" w Tackboard for Overhead Cabinet 	13/16	28 1/4	30	10	2	FLB2930TK	COM \$444	
	Features:							A \$459
	<ul style="list-style-type: none"> · for use with 30" w storage overhead cabinet · use with 48" h overhead cabinets · attaches to cabinet interior, mounting hardware included · com ydg: 1 							B \$481
								C \$524
								D \$580
								E \$634
								F \$720
								G \$812
								H \$909
								I \$1,062
								J \$1,245

To Order, Specify:

① Model Number	② Fabric Selection	
(FLB)	Vendor Pattern Color	Visit www.jsifurniture.com/finishes-and-materials/textiles for our textiles program. See selection of standard and graded in manufacturers and patterns.

FLUX - PRIVATE OFFICE

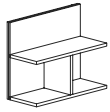
Description	D	W	H	CTN WT	CU FT	① Model	Laminate	Flat Cut Veneer	Double Cut Veneer
Double Height Wall Mount Overhead Shelf 	15	96	29	174	30	FLT1596-29WMS	\$1,508		
	15	96	29	174	30	FLV1596-29WMS		\$2,316	\$2,548
	15	90	29	164	29	FLT1590-29WMS	\$1,435		
	15	90	29	164	29	FLV1590-29WMS		\$2,205	\$2,428
	15	84	29	154	27	FLT1584-29WMS	\$1,378		
	15	84	29	154	27	FLV1584-29WMS		\$2,117	\$2,330
	15	78	29	144	25	FLT1578-29WMS	\$1,323		
	15	78	29	144	25	FLV1578-29WMS		\$2,034	\$2,237
	15	72	29	135	23	FLT1572-29WMS	\$1,084		
	15	72	29	135	23	FLV1572-29WMS		\$1,667	\$1,831
	15	66	29	125	21	FLT1566-29WMS	\$1,041		
	15	66	29	125	21	FLV1566-29WMS		\$1,599	\$1,758
	15	60	29	115	19	FLT1560-29WMS	\$999		
	15	60	29	115	19	FLV1560-29WMS		\$1,535	\$1,690
	15	54	29	105	18	FLT1554-29WMS	\$960		
	15	54	29	105	18	FLV1554-29WMS		\$1,475	\$1,623
	15	48	29	95	16	FLT1548-29WMS	\$923		
	15	48	29	95	16	FLV1548-29WMS		\$1,415	\$1,557
	15	42	29	85	14	FLT1542-29WMS	\$885		
	15	42	29	85	14	FLV1542-29WMS		\$1,361	\$1,495

Features:

- supported by wall cleat - hardware provided by installer
- laminate grain direction runs horizontal on back panel of shelf

Options:

- must specify chassis grain direction on double cut veneer, see pages 13-15 for details

Description	D	W	H	CTN WT	CU FT	① Model	Laminate	Flat Cut Veneer	Double Cut Veneer
 Double Height Wall Mount Overhead Shelf	15	36	29	70	12	FLT1536-29WMS	\$790		
	15	36	29	70	12	FLV1536-29WMS		\$1,213	\$1,334
	15	30	29	60	10	FLT1530-29WMS	\$758		
	15	30	29	60	10	FLV1530-29WMS		\$1,165	\$1,282

Features:

- supported by wall cleat - hardware provided by installer
- laminate grain direction runs horizontal on back panel of shelf

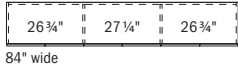
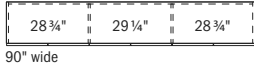
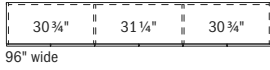
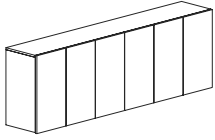
Options:

- must specify chassis grain direction on double cut veneer, see pages 13-15 for details

To Order, Specify:

① Laminate Model #		② Laminate Selection		③ Metal Color	④ Other Product Options
Laminate (FLT)		See Laminate Selection		See Metal Finish Color Options	See list of options for each specific unit; Specify and add accordingly.
① Veneer Model #	② Wood Species	③ Wood Finish		④ Metal Color	⑤ Other Product Options
Veneer (FLV)	Flat Cut CH1 Cherry MA1 Maple WA1 Walnut BO1 Black Oak	See Flat Cut Wood Finish Options		See Metal Finish Color Options	See list of options for each specific unit; Specify and add accordingly.
	Double Cut DC1 Double Cut	③a Wood Finish See Double Cut Wood Finish Options	③b Chassis Grain Direction For Double Cut Only: Vertical Horizontal		

Description	D	W	H	CTN WT	CU FT	① Model	Laminate	Flat Cut Veneer	Double Cut Veneer
Wall Mount Double Height Overhead with Six Doors	15 7/8	96	29 1/4	284	32	FLT1696-29WSO	\$2,392		
	15 7/8	96	29 1/4	284	32	FLV1696-29WSO		\$4,496	\$4,947
	15 7/8	90	29 1/4	269	30	FLT1690-29WSO	\$2,264		
	15 7/8	90	29 1/4	269	30	FLV1690-29WSO		\$4,217	\$4,640
	15 7/8	84	29 1/4	253	28	FLT1684-29WSO	\$2,144		
	15 7/8	84	29 1/4	253	28	FLV1684-29WSO		\$3,934	\$4,328



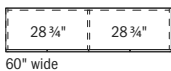
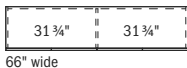
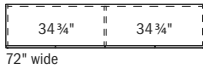
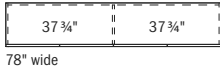
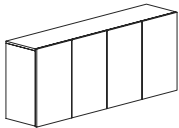
Features:

- supported by wall cleat - hardware provided by installer
- secure wall attachment required; pilot holes provided in back panel
- laminate grain direction runs horizontal on back panel of overhead cabinets
- 1/4" overhang at the bottom of the door allows access
- adjustable shelves

Options:

- must specify chassis grain direction on double cut veneer, see pages 13-15 for details
- veneer door fronts in paint available, specify paint color and add \$337 list; see page 16 for details
- on laminate units, contrasting laminate door fronts available, no upcharge; specify laminate color, see page 16 for details
- white glass doors with aluminum trim available, specify and add \$4,488 list for 96"w, \$4,299 list for 90"w, \$4,137 list for 84"w; see page 33 for details
- markerboard laminate doors available, specify and add \$1,144 list; see page 33 for details
- locking doors available, specify and add \$426 list (not available on glass doors)

Wall Mount Double Height Overhead with Four Doors	15 7/8	78	29 1/4	230	26	FLT1678-29WSO	\$2,098		
	15 7/8	78	29 1/4	230	26	FLV1678-29WSO		\$3,656	\$4,022
	15 7/8	72	29 1/4	215	24	FLT1672-29WSO	\$1,985		
	15 7/8	72	29 1/4	215	24	FLV1672-29WSO		\$3,375	\$3,712
	15 7/8	66	29 1/4	199	22	FLT1666-29WSO	\$1,879		
	15 7/8	66	29 1/4	199	22	FLV1666-29WSO		\$3,226	\$3,550
	15 7/8	60	29 1/4	190	21	FLT1660-29WSO	\$1,793		
	15 7/8	60	29 1/4	190	21	FLV1660-29WSO		\$3,069	\$3,377

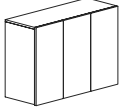
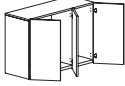


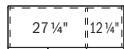
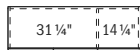
Features:

- supported by wall cleat - hardware provided by installer
- secure wall attachment required; pilot holes provided in back panel
- laminate grain direction runs horizontal on back panel of overhead cabinets
- 1/4" overhang at the bottom of the door allows access
- adjustable shelves

Options:

- must specify chassis grain direction on double cut veneer, see pages 13-15 for details
- veneer door fronts in paint available, specify paint color and add \$337 list; see page 16 for details
- on laminate units, contrasting laminate door fronts available, no upcharge; specify laminate color, see page 16 for details
- white glass doors with aluminum trim available, specify and add \$3,437 list for 78"w, \$3,247 list for 72"w, \$3,058 list for 66"w, \$2,869 list for 60"w; see page 33 for details
- markerboard laminate doors available, specify and add \$763 list; see page 33 for details
- locking doors available, specify and add \$284 list (not available on glass doors)

Description	D	W	H	CTN WT	CU FT	① Model	Laminate	Flat Cut Veneer	Double Cut Veneer
Wall Mount Double Height Overhead with Three Doors   right shown	15 7/8	54	29 1/4	173	19	FLT1654-29WSOR	\$1,685		
	15 7/8	54	29 1/4	173	19	FLV1654-29WSOR		\$2,767	\$3,046
	15 7/8	54	29 1/4	173	19	FLT1654-29WSOL	\$1,685		
	15 7/8	54	29 1/4	173	19	FLV1654-29WSOL		\$2,767	\$3,046
	15 7/8	48	29 1/4	157	17	FLT1648-29WSOR	\$1,445		
	15 7/8	48	29 1/4	157	17	FLV1648-29WSOR		\$2,424	\$2,667
	15 7/8	48	29 1/4	157	17	FLT1648-29WSOL	\$1,445		
	15 7/8	48	29 1/4	157	17	FLV1648-29WSOL		\$2,424	\$2,667
	15 7/8	42	29 1/4	141	15	FLT1642-29WSOR	\$1,372		
	15 7/8	42	29 1/4	141	15	FLV1642-29WSOR		\$2,224	\$2,447
	15 7/8	42	29 1/4	141	15	FLT1642-29WSOL	\$1,372		
	15 7/8	42	29 1/4	141	15	FLV1642-29WSOL		\$2,224	\$2,447



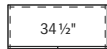
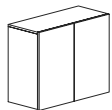
Features:

- supported by wall cleat - hardware provided by installer
- secure wall attachment required; pilot holes provided in back panel
- laminate grain direction runs horizontal on back panel of overhead cabinets
- 1/4" overhang at the bottom of the door allows access
- adjustable shelves

Options:

- must specify chassis grain direction on double cut veneer, see pages 13-15 for details
- veneer door fronts in paint available, specify paint color and add \$337 list; see page 16 for details
- on laminate units, contrasting laminate door fronts available, no upcharge; specify laminate color, see page 16 for details
- white glass doors with aluminum trim available, specify and add \$2,436 list for 54"w, \$2,246 list for 48"w, \$2,058 list for 42"w; see page 33 for details
- markerboard laminate doors available, specify and add \$574 list; see page 33 for details
- locking doors available, specify and add \$284 list (not available on glass doors)

Wall Mount Double Height Overhead with Two Doors 	15 7/8	36	29 1/4	114	13	FLT1636-29WSO	\$1,194		
	15 7/8	36	29 1/4	114	13	FLV1636-29WSO		\$2,085	\$2,294
	15 7/8	30	29 1/4	99	11	FLT1630-29WSO	\$1,137		
	15 7/8	30	29 1/4	99	11	FLV1630-29WSO		\$1,986	\$2,187



Features:

- supported by wall cleat - hardware provided by installer
- secure wall attachment required; pilot holes provided in back panel
- laminate grain direction runs horizontal on back panel of overhead cabinets
- 1/4" overhang at the bottom of the door allows access
- adjustable shelves

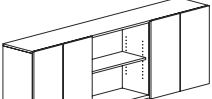
Options:

- must specify chassis grain direction on double cut veneer, see pages 13-15 for details
- veneer door fronts in paint available, specify paint color and add \$337 list; see page 16 for details
- on laminate units, contrasting laminate door fronts available, no upcharge; specify laminate color, see page 16 for details
- white glass doors with aluminum trim available, specify and add \$1,626 list for 36"w, \$1,437 list for 30"w; see page 33 for details
- markerboard laminate doors available, specify and add \$385 list; see page 33 for details
- locking doors available, specify and add \$142 list (not available on glass doors)

To Order, Specify:

① Laminate Model #	② Laminate Selection	③ Metal Color	④ Other Product Options
Laminate (FLT)	See Laminate Selection	See Metal Finish Color Options	See list of options for each specific unit; Specify and add accordingly.

① Veneer Model #	② Wood Species	③ Wood Finish	④ Metal Color	⑤ Other Product Options
Veneer (FLV)	Flat Cut CH1 Cherry MA1 Maple WA1 Walnut BO1 Black Oak	See Flat Cut Wood Finish Options	See Metal Finish Color Options	See list of options for each specific unit; Specify and add accordingly.
		<table border="1"> <thead> <tr> <th>③a Wood Finish</th> <th>③b Chassis Grain Direction</th> </tr> </thead> <tbody> <tr> <td>See Double Cut Wood Finish Options</td> <td>For Double Cut Only: Vertical Horizontal</td> </tr> </tbody> </table>		
③a Wood Finish	③b Chassis Grain Direction			
See Double Cut Wood Finish Options	For Double Cut Only: Vertical Horizontal			

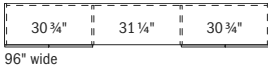
Description	D	W	H	CTN WT	CU FT	① Model	Laminate	Flat Cut Veneer	Double Cut Veneer
Wall Mount Double Height Overhead with Four Doors and Open Center 	15 7/8	96	29 1/4	264	32	FLT1696-29WSMO	\$2,371		
	15 7/8	96	29 1/4	264	32	FLV1696-29WSMO		\$3,882	\$4,269
	15 7/8	90	29 1/4	250	30	FLT1690-29WSMO	\$2,231		
	15 7/8	90	29 1/4	250	30	FLV1690-29WSMO		\$3,649	\$4,015
	15 7/8	84	29 1/4	236	28	FLT1684-29WSMO	\$2,085		
	15 7/8	84	29 1/4	236	28	FLV1684-29WSMO		\$3,416	\$3,758

Features:

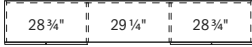
- supported by wall cleat - hardware provided by installer
- secure wall attachment required; pilot holes provided in back panel
- laminate grain direction runs horizontal on back panel of overhead cabinets
- 1/4" overhang at the bottom of the door allows access
- adjustable shelves

Options:

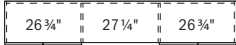
- must specify chassis grain direction on double cut veneer, see pages 13-15 for details
- veneer door fronts in paint available, specify paint color and add \$337 list; see page 16 for details
- on laminate units, contrasting laminate door fronts available, no upcharge; specify laminate color, see page 16 for details
- white glass doors with aluminum trim available, specify and add \$2,995 list for 96"w, \$2,869 list for 90"w, \$2,743 list for 84"w; see page 33 for details
- markerboard laminate doors available, specify and add \$763 list; see page 33 for details
- locking doors available, specify and add \$284 list (not available on glass doors)



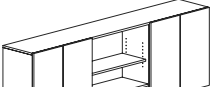
96" wide



90" wide



84" wide

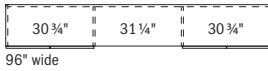
Wall Mount Double Height Overhead Cabinet with Four Doors, Open Center and Cubbies 	15 7/8	96	29 1/4	275	32	FLT1696-29WSMOCC	\$2,495		
	15 7/8	96	29 1/4	275	32	FLV1696-29WSMOCC		\$4,059	\$4,465
	15 7/8	90	29 1/4	260	30	FLT1690-29WSMOCC	\$2,353		
	15 7/8	90	29 1/4	260	30	FLV1690-29WSMOCC		\$3,829	\$4,210
	15 7/8	84	29 1/4	245	28	FLT1684-29WSMOCC	\$2,208		
	15 7/8	84	29 1/4	245	28	FLV1684-29WSMOCC		\$3,593	\$3,954

Features:

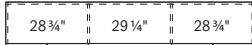
- supported by wall cleat - hardware provided by installer
- secure wall attachment required; pilot holes provided in back panel
- laminate grain direction runs horizontal on back panel of overhead cabinets
- 1/4" overhang at the bottom of the door allows access
- adjustable shelves

Options:

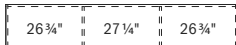
- must specify chassis grain direction on double cut veneer, see pages 13-15 for details
- veneer door fronts in paint available, specify paint color and add \$337 list; see page 16 for details
- on laminate units, contrasting laminate door fronts available, no upcharge; specify laminate color, see page 16 for details
- white glass doors with aluminum trim available, specify and add \$2,995 list for 96"w, \$2,869 list for 90"w, \$2,743 list for 84"w; see page 33 for details
- markerboard laminate doors available, specify and add \$763 list; see page 33 for details
- locking doors available, specify and add \$284 list (not available on glass doors)



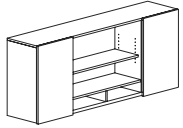
96" wide



90" wide



84" wide

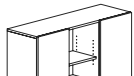
Description	D	W	H	CTN WT	CU FT	① Model	Laminate	Flat Cut Veneer	Double Cut Veneer
Wall Mount Double Height Overhead Cabinet with Two Doors, Open Center and Cubbies 	15 7/8	78	29 1/4	226	26	FLT1678-29WSMOCC	\$2,071		
	15 7/8	78	29 1/4	226	26	FLV1678-29WSMOCC		\$3,265	\$3,591
	15 7/8	72	29 1/4	211	24	FLT1672-29WSMOCC	\$1,959		
	15 7/8	72	29 1/4	211	24	FLV1672-29WSMOCC		\$3,090	\$3,399
	15 7/8	66	29 1/4	197	22	FLT1666-29WSMOCC	\$1,862		
	15 7/8	66	29 1/4	197	22	FLV1666-29WSMOCC		\$2,935	\$3,227
	15 7/8	60	29 1/4	187	21	FLT1660-29WSMOCC	\$1,788		
	15 7/8	60	29 1/4	187	21	FLV1660-29WSMOCC		\$2,820	\$3,099

Features:

- supported by wall cleat - hardware provided by installer
- secure wall attachment required; pilot holes provided in back panel
- laminate grain direction runs horizontal on back panel of overhead cabinets
- 1/4" overhang at the bottom of the door allows access
- adjustable shelves

Options:

- must specify chassis grain direction on double cut veneer, see pages 13-15 for details
- veneer door fronts in paint available, specify paint color and add \$337 list; see page 16 for details
- on laminate units, contrasting laminate door fronts available, no upcharge; specify laminate color, see page 16 for details
- white glass doors with aluminum trim available, specify and add \$1,720 list for 78"w, \$1,626 list for 72"w, \$1,531 list for 66"w, \$1,437 list for 60"w; see page 33 for details
- markerboard laminate doors available, specify and add \$385 list; see page 33 for details
- locking doors available, specify and add \$284 list (not available on glass doors)

Wall Mount Double Height Overhead Cabinet with 2 Doors, Open Center and Cubbies 	15 7/8	54	29 1/4	174	19	FLT1654-29WSMOCC	\$1,751		
	15 7/8	54	29 1/4	174	19	FLV1654-29WSMOCC		\$2,718	\$2,989
	15 7/8	48	29 1/4	159	17	FLT1648-29WSMOCC	\$1,699		
	15 7/8	48	29 1/4	159	17	FLV1648-29WSMOCC		\$2,636	\$2,899
	15 7/8	42	29 1/4	143	15	FLT1642-29WSMOCC	\$1,648		
	15 7/8	42	29 1/4	143	15	FLV1642-29WSMOCC		\$2,560	\$2,815

Features:

- supported by wall cleat - hardware provided by installer
- secure wall attachment required; pilot holes provided in back panel
- laminate grain direction runs horizontal on back panel of overhead cabinets
- 1/4" overhang at the bottom of the door allows access
- adjustable shelves

Options:

- must specify chassis grain direction on double cut veneer, see pages 13-15 for details
- veneer door fronts in paint available, specify paint color and add \$337 list; see page 16 for details
- on laminate units, contrasting laminate door fronts available, no upcharge; specify laminate color, see page 16 for details
- white glass doors with aluminum trim available, specify and add \$1,626 list for 54"w, \$1,499 list for 48"w, \$1,372 list for 42"w; see page 33 for details
- markerboard laminate doors available, specify and add \$385 list; see page 33 for details
- locking doors available, specify and add \$284 list (not available on glass doors)



54" wide



48" wide



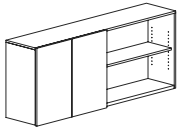
42" wide

To Order, Specify:

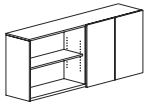
① Laminate Model #	② Laminate Selection	③ Metal Color	④ Other Product Options
Laminate (FLT)	See Laminate Selection	See Metal Finish Color Options	See list of options for each specific unit; Specify and add accordingly.

① Veneer Model #	② Wood Species	③ Wood Finish	④ Metal Color	⑤ Other Product Options
Veneer (FLV)	Flat Cut CH1 Cherry MA1 Maple WA1 Walnut BO1 Black Oak	See Flat Cut Wood Finish Options	See Metal Finish Color Options	See list of options for each specific unit; Specify and add accordingly.
		<table border="1"> <thead> <tr> <th>③a Wood Finish</th> <th>③b Chassis Grain Direction</th> </tr> </thead> <tbody> <tr> <td>See Double Cut Wood Finish Options</td> <td>For Double Cut Only: Vertical Horizontal</td> </tr> </tbody> </table>		
③a Wood Finish	③b Chassis Grain Direction			
See Double Cut Wood Finish Options	For Double Cut Only: Vertical Horizontal			

Description	D	W	H	CTN WT	CU FT	① Model	Laminate	Flat Cut Veneer	Double Cut Veneer
Wall Mount Double Height Overhead with Two Doors and Open Compartment	15 7/8	78	29 1/4	206	26	FLT1678-29WSMOR	\$1,948		
	15 7/8	78	29 1/4	206	26	FLV1678-29WSMOR		\$3,087	\$3,395
	15 7/8	78	29 1/4	206	26	FLT1678-29WSMOL	\$1,948		
	15 7/8	78	29 1/4	206	26	FLV1678-29WSMOL		\$3,087	\$3,395
	15 7/8	72	29 1/4	192	24	FLT1672-29WSMOR	\$1,836		
	15 7/8	72	29 1/4	192	24	FLV1672-29WSMOR		\$2,911	\$3,203
	15 7/8	72	29 1/4	192	24	FLT1672-29WSMOL	\$1,836		
	15 7/8	72	29 1/4	192	24	FLV1672-29WSMOL		\$2,911	\$3,203
	15 7/8	66	29 1/4	179	22	FLT1666-29WSMOR	\$1,740		
	15 7/8	66	29 1/4	179	22	FLV1666-29WSMOR		\$2,758	\$3,033
	15 7/8	66	29 1/4	179	22	FLT1666-29WSMOL	\$1,740		
	15 7/8	66	29 1/4	179	22	FLV1666-29WSMOL		\$2,758	\$3,033
	15 7/8	60	29 1/4	170	21	FLT1660-29WSMOR	\$1,667		
	15 7/8	60	29 1/4	170	21	FLV1660-29WSMOR		\$2,641	\$2,905
	15 7/8	60	29 1/4	170	21	FLT1660-29WSMOL	\$1,667		
	15 7/8	60	29 1/4	170	21	FLV1660-29WSMOL		\$2,641	\$2,905



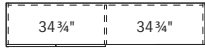
left shown



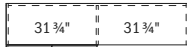
right



78" wide



72" wide



66" wide



60" wide

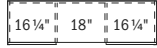
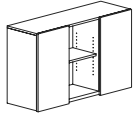
Features:

- supported by wall cleat - hardware provided by installer
- secure wall attachment required; pilot holes provided in back panel
- laminate grain direction runs horizontal on back panel of overhead cabinets
- 1/4" overhang at the bottom of the door allows access
- adjustable shelves

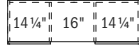
Options:

- must specify chassis grain direction on double cut veneer, see pages 13-15 for details
- veneer door fronts in paint available, specify paint color and add \$337 list; see page 16 for details
- on laminate units, contrasting laminate door fronts available, no upcharge; specify laminate color, see page 16 for details
- white glass doors with aluminum trim available, specify and add \$1,720 list for 78"w, \$1,626 list for 72"w, \$1,531 list for 66"w, \$1,437 list for 60"w; see page 33 for details
- markerboard laminate doors available, specify and add \$385 list; see page 33 for details
- locking doors available, specify and add \$142 list (not available on glass doors)

Description	D	W	H	CTN WT	CU FT	1 Model	Laminate	Flat Cut Veneer	Double Cut Veneer
Wall Mount Double Height Overhead with Two Doors and Open Center	15 7/8	54	29 1/4	169	19	FLT1654-29WSMO	\$1,628		
	15 7/8	54	29 1/4	169	19	FLV1654-29WSMO		\$2,540	\$2,795
	15 7/8	48	29 1/4	154	17	FLT1648-29WSMO	\$1,576		
	15 7/8	48	29 1/4	154	17	FLV1648-29WSMO		\$2,457	\$2,704
	15 7/8	42	29 1/4	139	15	FLT1642-29WSMO	\$1,525		
	15 7/8	42	29 1/4	139	15	FLV1642-29WSMO		\$2,383	\$2,619



54" wide



48" wide



42" wide

Features:

- supported by wall cleat - hardware provided by installer
- secure wall attachment required; pilot holes provided in back panel
- laminate grain direction runs horizontal on back panel of overhead cabinets
- 1/4" overhang at the bottom of the door allows access
- adjustable shelves

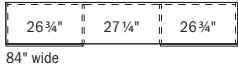
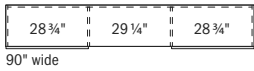
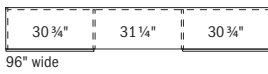
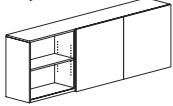
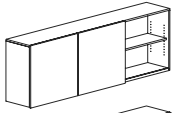
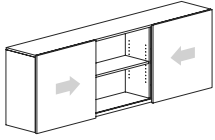
Options:

- must specify chassis grain direction on double cut veneer, see pages 13-15 for details
- veneer door fronts in paint available, specify paint color and add \$337 list; see page 16 for details
- on laminate units, contrasting laminate door fronts available, no upcharge; specify laminate color, see page 16 for details
- white glass doors with aluminum trim available, specify and add \$2,436 list for 54" w, \$2,246 list for 48" w, \$2,058 list for 42" w; see page 33 for details
- markerboard laminate doors available, specify and add \$385 list; see page 33 for details
- locking doors available, specify and add \$284 list (not available on glass doors)

To Order, Specify:

1 Laminate Model #		2 Laminate Selection		3 Metal Color	4 Other Product Options
Laminate (FLT)		See Laminate Selection		See Metal Finish Color Options	See list of options for each specific unit; Specify and add accordingly.
1 Veneer Model #	2 Wood Species	3 Wood Finish		4 Metal Color	5 Other Product Options
Veneer (FLV)	Flat Cut CH1 Cherry MA1 Maple WA1 Walnut BO1 Black Oak	See Flat Cut Wood Finish Options		See Metal Finish Color Options	See list of options for each specific unit; Specify and add accordingly.
	Double Cut DC1 Double Cut	3a Wood Finish See Double Cut Wood Finish Options	3b Chassis Grain Direction For Double Cut Only: Vertical Horizontal		

Description	D	W	H	CTN WT	CU FT	① Model	Laminate	Flat Cut Veneer	Double Cut Veneer
Wall Mount Double Height	15 15/16	96	29 1/4	276	32	FLT1696-29WSD	\$2,723		
Overhead Cabinet Sliding Door	15 15/16	96	29 1/4	276	32	FLV1696-29WSD		\$4,461	\$4,906
	15 15/16	90	29 1/4	261	30	FLT1690-29WSD	\$2,562		
	15 15/16	90	29 1/4	261	30	FLV1690-29WSD		\$4,195	\$4,615
	15 15/16	84	29 1/4	246	28	FLT1684-29WSD	\$2,395		
	15 15/16	84	29 1/4	246	28	FLV1684-29WSD		\$3,924	\$4,319



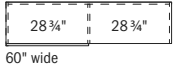
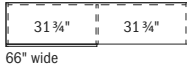
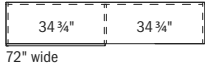
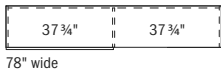
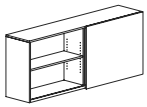
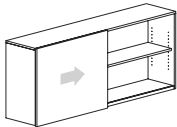
Features:

- supported by wall cleat - hardware provided by installer
- secure wall attachment required; pilot holes provided in back panel
- laminate grain direction runs horizontal on back panel of overhead cabinets
- locking not available
- adjustable shelves

Options:

- must specify chassis grain direction on double cut veneer, see pages 13-15 for details
- veneer door fronts in paint available, specify paint color and add \$337 list; see page 16 for details
- on laminate units, contrasting laminate door fronts available, no upcharge; specify laminate color, see page 16 for details
- white glass doors with aluminum trim available, specify and add \$2,626 list for 96"w, \$2,498 list for 90"w, \$2,372 list for 84"w; see page 33 for details
- markerboard laminate doors available, specify and add \$569 list; see page 33 for details

Wall Mount Double Height	15 15/16	78	29 1/4	214	26	FLT1678-29WSD	\$2,238		
Overhead Cabinet Sliding Door	15 15/16	78	29 1/4	214	26	FLV1678-29WSD		\$3,546	\$3,902
	15 15/16	72	29 1/4	200	25	FLT1672-29WSD	\$2,110		
	15 15/16	72	29 1/4	200	25	FLV1672-29WSD		\$3,346	\$3,681
	15 15/16	66	29 1/4	185	23	FLT1666-29WSD	\$1,998		
	15 15/16	66	29 1/4	185	23	FLV1666-29WSD		\$3,168	\$3,483
	15 15/16	60	29 1/4	178	21	FLT1660-29WSD	\$1,915		
	15 15/16	60	29 1/4	178	21	FLV1660-29WSD		\$3,033	\$3,338



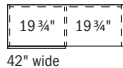
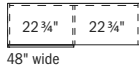
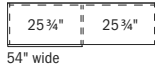
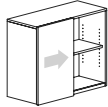
Features:

- supported by wall cleat - hardware provided by installer
- secure wall attachment required; pilot holes provided in back panel
- laminate grain direction runs horizontal on back panel of overhead cabinets
- locking not available
- adjustable shelves

Options:

- must specify chassis grain direction on double cut veneer, see pages 13-15 for details
- veneer door fronts in paint available, specify paint color and add \$337 list; see page 16 for details
- on laminate units, contrasting laminate door fronts available, no upcharge; specify laminate color, see page 16 for details
- white glass doors with aluminum trim available, specify and add \$1,535 list for 78"w, \$1,441 list for 72"w, \$1,346 list for 66"w, \$1,216 list for 60"w; see page 33 for details
- markerboard laminate doors available, specify and add \$286 list; see page 33 for details

Description	D	W	H	CTN WT	CU FT	1 Model	Laminate	Flat Cut Veneer	Double Cut Veneer
Wall Mount Double Height Overhead Cabinet Sliding Door	15 15/16	54	29 1/4	157	19	FLT1654-29WSD	\$1,870		
	15 15/16	54	29 1/4	157	19	FLV1654-29WSD		\$2,919	\$3,211
	15 15/16	48	29 1/4	143	17	FLT1648-29WSD	\$1,809		
	15 15/16	48	29 1/4	143	17	FLV1648-29WSD		\$2,825	\$3,108
	15 15/16	42	29 1/4	129	15	FLT1642-29WSD	\$1,751		
	15 15/16	42	29 1/4	129	15	FLV1642-29WSD		\$2,735	\$3,009



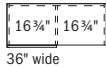
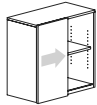
Features:

- supported by wall cleat - hardware provided by installer
- secure wall attachment required; pilot holes provided in back panel
- laminated grain direction runs horizontal on back panel of overhead cabinets
- locking not available
- adjustable shelves

Options:

- must specify chassis grain direction on double cut veneer, see pages 13-15 for details
- veneer door fronts in paint available, specify paint color and add \$337 list; see page 16 for details
- on laminate units, contrasting laminate door fronts available, no upcharge; specify laminate color, see page 16 for details
- white glass doors with aluminum trim available, specify and add \$1,156 list for 54"w, \$1,062 list for 48"w, \$968 list for 42"w; see page 33 for details
- markerboard laminate doors available, specify and add \$286 list; see page 33 for details

Wall Mount Double Height Overhead Cabinet Sliding Door	15 15/16	36	29 1/4	115	13	FLT1636-29WSD	\$1,665		
	15 15/16	36	29 1/4	115	13	FLV1636-29WSD		\$2,598	\$2,858
	15 15/16	30	29 1/4	101	11	FLT1630-29WSD	\$1,598		
	15 15/16	30	29 1/4	101	11	FLV1630-29WSD		\$2,494	\$2,743



Features:

- supported by wall cleat - hardware provided by installer
- secure wall attachment required; pilot holes provided in back panel
- laminated grain direction runs horizontal on back panel of overhead cabinets
- locking not available
- adjustable shelves

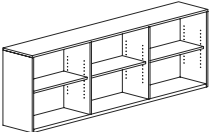
Options:

- must specify chassis grain direction on double cut veneer, see pages 13-15 for details
- veneer door fronts in paint available, specify paint color and add \$337 list; see page 16 for details
- on laminate units, contrasting laminate door fronts available, no upcharge; specify laminate color, see page 16 for details
- white glass doors with aluminum trim available, specify and add \$636 list for 36"w, \$607 list for 30"w; see page 33 for details
- markerboard laminate doors available, specify and add \$286 list; see page 33 for details

To Order, Specify:

1 Laminate Model #	2 Laminate Selection	3 Metal Color	4 Other Product Options
Laminate (FLT)	See Laminate Selection	See Metal Finish Color Options	See list of options for each specific unit; Specify and add accordingly.

1 Veneer Model #	2 Wood Species	3 Wood Finish	4 Metal Color	5 Other Product Options
Veneer (FLV)	Flat Cut CH1 Cherry MA1 Maple WA1 Walnut BO1 Black Oak	See Flat Cut Wood Finish Options	See Metal Finish Color Options	See list of options for each specific unit; Specify and add accordingly.
		<table border="1"> <thead> <tr> <th>3a Wood Finish</th> <th>3b Chassis Grain Direction</th> </tr> </thead> <tbody> <tr> <td>See Double Cut Wood Finish Options</td> <td>For Double Cut Only: Vertical Horizontal</td> </tr> </tbody> </table>		
3a Wood Finish	3b Chassis Grain Direction			
See Double Cut Wood Finish Options	For Double Cut Only: Vertical Horizontal			

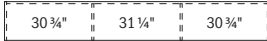
Description	D	W	H	CTN WT	CU FT	① Model	Laminate	Flat Cut Veneer	Double Cut Veneer
Wall Mount Double Height Open Overhead 	15	96	29	222	30	FLT1596-29W00	\$2,081		
	15	96	29	222	30	FLV1596-29W00		\$3,914	\$4,304
	15	90	29	210	29	FLT1590-29W00	\$1,972		
	15	90	29	210	29	FLV1590-29W00		\$3,669	\$4,036
	15	84	29	198	27	FLT1584-29W00	\$1,867		
	15	84	29	198	27	FLV1584-29W00		\$3,424	\$3,768

Features:

- supported by wall cleat - hardware provided by installer
- secure wall attachment required; pilot holes provided in back panel
- laminate grain direction runs horizontal on back panel of overhead cabinets
- adjustable shelves

Options:

- must specify chassis grain direction on double cut veneer, see pages 13-15 for details



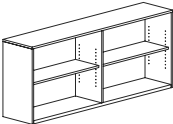
96" wide



90" wide



84" wide

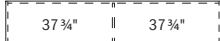
Wall Mount Double Height Open Overhead 	15	78	29	179	25	FLT1578-29W00	\$1,825		
	15	78	29	179	25	FLV1578-29W00		\$3,181	\$3,500
	15	72	29	167	23	FLT1572-29W00	\$1,730		
	15	72	29	167	23	FLV1572-29W00		\$2,936	\$3,229
	15	66	29	155	21	FLT1566-29W00	\$1,634		
	15	66	29	155	21	FLV1566-29W00		\$2,808	\$3,090
	15	60	29	148	19	FLT1560-29W00	\$1,560		
	15	60	29	148	19	FLV1560-29W00		\$2,673	\$2,939

Features:

- supported by wall cleat - hardware provided by installer
- secure wall attachment required; pilot holes provided in back panel
- laminate grain direction runs horizontal on back panel of overhead cabinets
- adjustable shelves

Options:

- must specify chassis grain direction on double cut veneer, see pages 13-15 for details



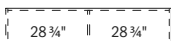
78" wide



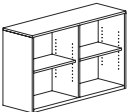
72" wide



66" wide



60" wide

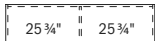
Wall Mount Double Height Open Overhead 	15	54	29	136	18	FLT1554-29W00	\$1,468		
	15	54	29	136	18	FLV1554-29W00		\$2,409	\$2,650
	15	48	29	124	16	FLT1548-29W00	\$1,258		
	15	48	29	124	16	FLV1548-29W00		\$2,110	\$2,321
	15	42	29	112	14	FLT1542-29W00	\$1,195		
	15	42	29	112	14	FLV1542-29W00		\$1,935	\$2,129

Features:

- supported by wall cleat - hardware provided by installer
- secure wall attachment required; pilot holes provided in back panel
- laminate grain direction runs horizontal on back panel of overhead cabinets
- adjustable shelves

Options:

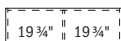
- must specify chassis grain direction on double cut veneer, see pages 13-15 for details



54" wide

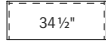
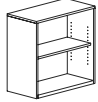


48" wide



42" wide

Description	D	W	H	CTN WT	CU FT	① Model	Laminate	Flat Cut Veneer	Double Cut Veneer
Wall Mount Double Height Open Overhead	15	36	29	89	12	FLT1536-29W00	\$1,040		
	15	36	29	89	12	FLV1536-29W00		\$1,816	\$1,998
	15	30	29	77	10	FLT1530-29W00	\$991		
	15	30	29	77	10	FLV1530-29W00		\$1,731	\$1,902



36" wide



30" wide

Features:

- supported by wall cleat - hardware provided by installer
- secure wall attachment required; pilot holes provided in back panel
- laminate grain direction runs horizontal on back panel of overhead cabinets
- adjustable shelf

Options:

- must specify chassis grain direction on double cut veneer, see pages 13-15 for details

Overhead Wall Mount Shelf	D	W	H	CTN WT	CU FT	① Model	Laminate	Flat Cut Veneer	Double Cut Veneer
	15	96	17	92	19	FLT1596-17WMS	\$1,078		
15	96	17	92	19	FLV1596-17WMS		\$1,657	\$1,821	
15	90	17	86	18	FLT1590-17WMS	\$1,029			
15	90	17	86	18	FLV1590-17WMS		\$1,578	\$1,736	
15	84	17	81	17	FLT1584-17WMS	\$987			
15	84	17	81	17	FLV1584-17WMS		\$1,514	\$1,667	
15	78	17	75	15	FLT1578-17WMS	\$947			
15	78	17	75	15	FLV1578-17WMS		\$1,453	\$1,599	
15	72	17	69	14	FLT1572-17WMS	\$777			
15	72	17	69	14	FLV1572-17WMS		\$1,189	\$1,308	
15	66	17	64	13	FLT1566-17WMS	\$745			
15	66	17	64	13	FLV1566-17WMS		\$1,144	\$1,257	
15	60	17	58	12	FLT1560-17WMS	\$716			
15	60	17	58	12	FLV1560-17WMS		\$1,099	\$1,209	
15	54	17	52	11	FLT1554-17WMS	\$687			
15	54	17	52	11	FLV1554-17WMS		\$1,054	\$1,161	
15	48	17	47	10	FLT1548-17WMS	\$661			
15	48	17	47	10	FLV1548-17WMS		\$1,011	\$1,113	
15	42	17	41	9	FLT1542-17WMS	\$633			
15	42	17	41	9	FLV1542-17WMS		\$971	\$1,069	
15	36	17	36	8	FLT1536-17WMS	\$608			
15	36	17	36	8	FLV1536-17WMS		\$933	\$1,029	
15	30	17	31	6	FLT1530-17WMS	\$584			
15	30	17	31	6	FLV1530-17WMS		\$895	\$987	



Features:

- supported by wall cleat - hardware provided by installer
- laminate grain direction runs horizontal on back panel of shelf

Options:

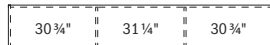
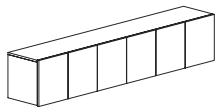
- must specify chassis grain direction on double cut veneer, see pages 13-15 for details

To Order, Specify:

① Laminate Model #	② Laminate Selection	③ Metal Color	④ Other Product Options
Laminate (FLT)	See Laminate Selection	See Metal Finish Color Options	See list of options for each specific unit; Specify and add accordingly.

① Veneer Model #	② Wood Species	③ Wood Finish	④ Metal Color	⑤ Other Product Options
Veneer (FLV)	Flat Cut CH1 Cherry MA1 Maple WA1 Walnut BO1 Black Oak	See Flat Cut Wood Finish Options	See Metal Finish Color Options	See list of options for each specific unit; Specify and add accordingly.
		<table border="1"> <thead> <tr> <th>③a Wood Finish</th> <th>③b Chassis Grain Direction</th> </tr> </thead> <tbody> <tr> <td>See Double Cut Wood Finish Options</td> <td>For Double Cut Only: Vertical Horizontal</td> </tr> </tbody> </table>		
③a Wood Finish	③b Chassis Grain Direction			
See Double Cut Wood Finish Options	For Double Cut Only: Vertical Horizontal			

Description	D	W	H	CTN WT	CU FT	① Model	Laminate	Flat Cut Veneer	Double Cut Veneer
Wall Mount Overhead Cabinet with Six Doors	15 7/8	96	17 1/4	184	20	FLT1696-17WSO	\$1,931		
	15 7/8	96	17 1/4	184	20	FLV1696-17WSO		\$3,268	\$3,595
	15 7/8	90	17 1/4	173	19	FLT1690-17WSO	\$1,813		
	15 7/8	90	17 1/4	173	19	FLV1690-17WSO		\$3,070	\$3,379
	15 7/8	84	17 1/4	163	18	FLT1684-17WSO	\$1,695		
	15 7/8	84	17 1/4	163	18	FLV1684-17WSO		\$2,869	\$3,156



96" wide



90" wide



84" wide

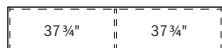
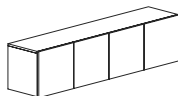
Features:

- supported by wall cleat - hardware provided by installer
- secure wall attachment required; pilot holes provided in back panel
- laminate grain direction runs horizontal on back panel of overhead cabinets
- 1/4" overhang at the bottom of the door allows access

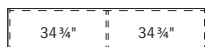
Options:

- must specify chassis grain direction on double cut veneer, see pages 13-15 for details
- veneer door fronts in paint available, specify paint color and add \$337 list; see page 16 for details
- on laminate units, contrasting laminate door fronts available, no upcharge; specify laminate color, see page 16 for details
- white glass doors with aluminum trim available, specify and add \$3,348 list; see page 33 for details
- markerboard laminate doors available, specify and add \$1,144 list; see page 33 for details
- locking doors available, specify and add \$426 list (not available on glass doors)

Wall Mount Overhead Cabinet with Four Doors	15 7/8	78	17 1/4	149	16	FLT1678-17WSO	\$1,580		
	15 7/8	78	17 1/4	149	16	FLV1678-17WSO		\$2,585	\$2,844
	15 7/8	72	17 1/4	139	15	FLT1672-17WSO	\$1,489		
	15 7/8	72	17 1/4	139	15	FLV1672-17WSO		\$2,436	\$2,681
	15 7/8	66	17 1/4	129	14	FLT1666-17WSO	\$1,407		
	15 7/8	66	17 1/4	129	14	FLV1666-17WSO		\$2,304	\$2,532
	15 7/8	60	17 1/4	124	13	FLT1660-17WSO	\$1,344		
	15 7/8	60	17 1/4	124	13	FLV1660-17WSO		\$2,201	\$2,423



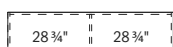
78" wide



72" wide



66" wide



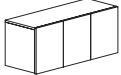
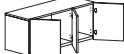
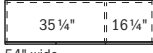
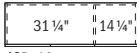
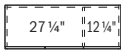
60" wide

Features:

- supported by wall cleat - hardware provided by installer
- secure wall attachment required; pilot holes provided in back panel
- laminate grain direction runs horizontal on back panel of overhead cabinets
- 1/4" overhang at the bottom of the door allows access

Options:

- must specify chassis grain direction on double cut veneer, see pages 13-15 for details
- veneer door fronts in paint available, specify paint color and add \$337 list; see page 16 for details
- on laminate units, contrasting laminate door fronts available, no upcharge; specify laminate color, see page 16 for details
- white glass doors with aluminum trim available, specify and add \$2,433 list for 78"w, \$2,321 list for 72"w, \$2,234 list for 66"w or 60"w; see page 33 for details
- markerboard laminate doors available, specify and add \$763 list; see page 33 for details
- locking doors available, specify and add \$284 list (not available on glass doors)

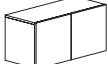
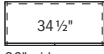

Description	D	W	H	CTN WT	CU FT	① Model	Laminate	Flat Cut Veneer	Double Cut Veneer
Wall Mount Overhead Cabinet with Three Doors   right shown  54" wide  48" wide  42" wide	15 7/8	54	17 1/4	115	12	FLT1654-17WSOR	\$1,316		
	15 7/8	54	17 1/4	115	12	FLV1654-17WSOR		\$2,117	\$2,330
	15 7/8	54	17 1/4	115	12	FLT1654-17WSOL	\$1,316		
	15 7/8	54	17 1/4	115	12	FLV1654-17WSOL		\$2,117	\$2,330
	15 7/8	48	17 1/4	103	10	FLT1648-17WSOR	\$1,270		
	15 7/8	48	17 1/4	103	10	FLV1648-17WSOR		\$2,044	\$2,248
	15 7/8	48	17 1/4	103	10	FLT1648-17WSOL	\$1,270		
	15 7/8	48	17 1/4	103	10	FLV1648-17WSOL		\$2,044	\$2,248
	15 7/8	42	17 1/4	93	9	FLT1642-17WSOR	\$1,229		
	15 7/8	42	17 1/4	93	9	FLV1642-17WSOR		\$1,980	\$2,178
	15 7/8	42	17 1/4	93	9	FLT1642-17WSOL	\$1,229		
	15 7/8	42	17 1/4	93	9	FLV1642-17WSOL		\$1,980	\$2,178

Features:

- supported by wall cleat - hardware provided by installer
- secure wall attachment required; pilot holes provided in back panel
- laminate grain direction runs horizontal on back panel of overhead cabinets
- 1/4" overhang at the bottom of the door allows access

Options:

- must specify chassis grain direction on double cut veneer, see pages 13-15 for details
- veneer door fronts in paint available, specify paint color and add \$337 list; see page 16 for details
- on laminate units, contrasting laminate door fronts available, no upcharge; specify laminate color, see page 16 for details
- white glass doors with aluminum trim available, specify and add \$1,742 list for 54"w, \$1,675 list for 48"w or 42"w; see page 33 for details
- markerboard laminate doors available, specify and add \$574 list; see page 33 for details
- locking doors available, specify and add \$284 list (not available on glass doors)

Wall Mount Overhead Cabinet with Two Doors   36" wide  30" wide	15 7/8	36	17 1/4	75	8	FLT1636-17WSO	\$1,166		
	15 7/8	36	17 1/4	75	8	FLV1636-17WSO		\$1,877	\$2,065
	15 7/8	30	17 1/4	65	7	FLT1630-17WSO	\$1,119		
	15 7/8	30	17 1/4	65	7	FLV1630-17WSO		\$1,799	\$1,981

Features:

- supported by wall cleat - hardware provided by installer
- secure wall attachment required; pilot holes provided in back panel
- laminate grain direction runs horizontal on back panel of overhead cabinets
- 1/4" overhang at the bottom of the door allows access

Options:

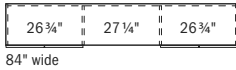
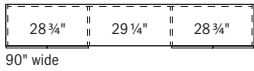
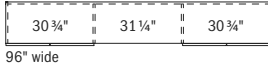
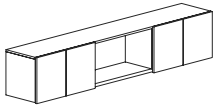
- must specify chassis grain direction on double cut veneer, see pages 13-15 for details
- veneer door fronts in paint available, specify paint color and add \$337 list; see page 16 for details
- on laminate units, contrasting laminate door fronts available, no upcharge; specify laminate color, see page 16 for details
- white glass doors with aluminum trim available, specify and add \$1,163 list for 36"w, \$1,119 list for 30"w; see page 33 for details
- markerboard laminate doors available, specify and add \$385 list; see page 33 for details
- locking doors available, specify and add \$142 list (not available on glass doors)

To Order, Specify:

① Laminate Model #	② Laminate Selection	③ Metal Color	④ Other Product Options
Laminate (FLT)	See Laminate Selection	See Metal Finish Color Options	See list of options for each specific unit; Specify and add accordingly.

① Veneer Model #	② Wood Species	③ Wood Finish	④ Metal Color	⑤ Other Product Options
Veneer (FLV)	Flat Cut CH1 Cherry MA1 Maple WA1 Walnut BO1 Black Oak	See Flat Cut Wood Finish Options	See Metal Finish Color Options	See list of options for each specific unit; Specify and add accordingly.
		<table border="1"> <thead> <tr> <th>③a Wood Finish</th> <th>③b Chassis Grain Direction</th> </tr> </thead> <tbody> <tr> <td>See Double Cut Wood Finish Options</td> <td>For Double Cut Only: Vertical Horizontal</td> </tr> </tbody> </table>		
③a Wood Finish	③b Chassis Grain Direction			
See Double Cut Wood Finish Options	For Double Cut Only: Vertical Horizontal			

Description	D	W	H	CTN WT	CU FT	① Model	Laminate	Flat Cut Veneer	Double Cut Veneer
Wall Mount Overhead Cabinet with Four Doors and Open Center	15 7/8	96	17 1/4	172	20	FLT1696-17WSMO	\$1,872		
	15 7/8	96	17 1/4	172	20	FLV1696-17WSMO		\$3,171	\$3,489
	15 7/8	90	17 1/4	162	19	FLT1690-17WSMO	\$1,760		
	15 7/8	90	17 1/4	162	19	FLV1690-17WSMO		\$2,979	\$3,277
	15 7/8	84	17 1/4	153	18	FLT1684-17WSMO	\$1,643		
	15 7/8	84	17 1/4	153	18	FLV1684-17WSMO		\$2,784	\$3,063



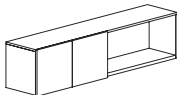
Features:

- supported by wall cleat - hardware provided by installer
- secure wall attachment required; pilot holes provided in back panel
- laminate grain direction runs horizontal on back panel of overhead cabinets
- 1/4" overhang at the bottom of the door allows access

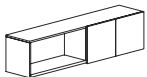
Options:

- must specify chassis grain direction on double cut veneer, see pages 13-15 for details
- veneer door fronts in paint available, specify paint color and add \$337 list; see page 16 for details
- on laminate units, contrasting laminate door fronts available, no upcharge; specify laminate color, see page 16 for details
- white glass doors with aluminum trim available, specify and add \$2,234 list; see page 33 for details
- markerboard laminate doors available, specify and add \$763 list; see page 33 for details
- locking doors available, specify and add \$284 list (not available on glass doors)

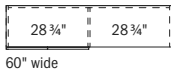
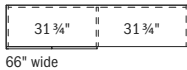
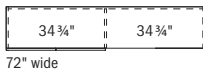
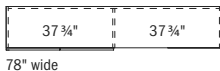
Wall Mount Overhead Cabinet with Two Doors and Open Compartment	15 7/8	78	17 1/4	135	16	FLT1678-17WSMOR	\$1,534		
	15 7/8	78	17 1/4	135	16	FLV1678-17WSMOR		\$2,509	\$2,761
	15 7/8	78	17 1/4	135	16	FLT1678-17WSMOL	\$1,534		
	15 7/8	78	17 1/4	135	16	FLV1678-17WSMOL		\$2,509	\$2,761
	15 7/8	72	17 1/4	126	15	FLT1672-17WSMOR	\$1,445		
	15 7/8	72	17 1/4	126	15	FLV1672-17WSMOR		\$2,365	\$2,603
	15 7/8	72	17 1/4	126	15	FLT1672-17WSMOL	\$1,445		
	15 7/8	72	17 1/4	126	15	FLV1672-17WSMOL		\$2,365	\$2,603
	15 7/8	66	17 1/4	117	14	FLT1666-17WSMOR	\$1,365		
	15 7/8	66	17 1/4	117	14	FLV1666-17WSMOR		\$2,234	\$2,457
	15 7/8	66	17 1/4	117	14	FLT1666-17WSMOL	\$1,365		
	15 7/8	66	17 1/4	117	14	FLV1666-17WSMOL		\$2,234	\$2,457
	15 7/8	60	17 1/4	113	13	FLT1660-17WSMOR	\$1,305		
	15 7/8	60	17 1/4	113	13	FLV1660-17WSMOR		\$2,136	\$2,351
	15 7/8	60	17 1/4	113	13	FLT1660-17WSMOL	\$1,305		
	15 7/8	60	17 1/4	113	13	FLV1660-17WSMOL		\$2,136	\$2,351



left shown



right



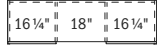
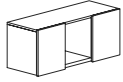
Features:

- supported by wall cleat - hardware provided by installer
- secure wall attachment required; pilot holes provided in back panel
- laminate grain direction runs horizontal on back panel of overhead cabinets
- 1/4" overhang at the bottom of the door allows access

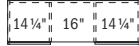
Options:

- must specify chassis grain direction on double cut veneer, see pages 13-15 for details
- veneer door fronts in paint available, specify paint color and add \$337 list; see page 16 for details
- on laminate units, contrasting laminate door fronts available, no upcharge; specify laminate color, see page 16 for details
- white glass doors with aluminum trim available, specify and add \$1,218 list for 78"w, \$1,163 list for 72"w, \$1,119 list for 66"w or 60"w; see page 33 for details
- markerboard laminate doors available, specify and add \$385 list; see page 33 for details
- locking doors available, specify and add \$142 list (not available on glass doors)

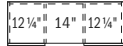
Description	D	W	H	CTN WT	CU FT	① Model	Laminate	Flat Cut Veneer	Double Cut Veneer
Wall Mount Overhead Cabinet with Two Doors and Open Center	15 7/8	54	17 1/4	111	12	FLT1654-17WSMO	\$1,278		
	15 7/8	54	17 1/4	111	12	FLV1654-17WSMO		\$2,056	\$2,261
	15 7/8	48	17 1/4	102	10	FLT1648-17WSMO	\$1,233		
	15 7/8	48	17 1/4	102	10	FLV1648-17WSMO		\$1,985	\$2,186
	15 7/8	42	17 1/4	92	9	FLT1642-17WSMO	\$1,194		
	15 7/8	42	17 1/4	92	9	FLV1642-17WSMO		\$1,920	\$2,113



54" wide



48" wide



42" wide

Features:

- supported by wall cleat - hardware provided by installer
- secure wall attachment required; pilot holes provided in back panel
- laminate grain direction runs horizontal on back panel of overhead cabinets
- 1/4" overhang at the bottom of the door allows access

Options:

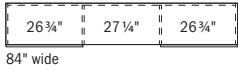
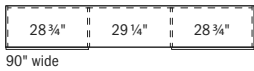
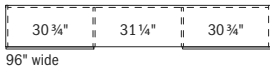
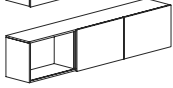
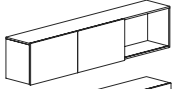
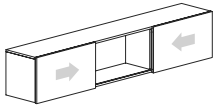
- must specify chassis grain direction on double cut veneer, see pages 13-15 for details
- veneer door fronts in paint available, specify paint color and add \$337 list; see page 16 for details
- on laminate units, contrasting laminate door fronts available, no upcharge; specify laminate color, see page 16 for details
- white glass doors with aluminum trim available, specify and add \$1,164 list for 54"w, \$1,119 list for 48"w or 42"w; see page 33 for details
- markerboard laminate doors available, specify and add \$385 list; see page 33 for details
- locking doors available, specify and add \$284 list (not available on glass doors)

To Order, Specify:

① Laminate Model #	② Laminate Selection		③ Metal Color	④ Other Product Options
Laminate (FLT)	See Laminate Selection		See Metal Finish Color Options	See list of options for each specific unit; Specify and add accordingly.

① Veneer Model #	② Wood Species	③ Wood Finish		④ Metal Color	⑤ Other Product Options
Veneer (FLV)	Flat Cut CH1 Cherry MA1 Maple WA1 Walnut BO1 Black Oak	See Flat Cut Wood Finish Options		See Metal Finish Color Options	See list of options for each specific unit; Specify and add accordingly.
		3a Wood Finish	3b Chassis Grain Direction		
	Double Cut DC1 Double Cut	See Double Cut Wood Finish Options	For Double Cut Only: Vertical Horizontal		

Description	D	W	H	CTN WT	CU FT	① Model	Laminate	Flat Cut Veneer	Double Cut Veneer
Wall Mount Overhead Cabinet with Sliding Doors	15 15/16	96	17 1/4	177	20	FLT1696-17WSD	\$2,179		
	15 15/16	96	17 1/4	177	20	FLV1696-17WSD		\$3,567	\$3,923
	15 15/16	90	17 1/4	167	19	FLT1690-17WSD	\$2,050		
	15 15/16	90	17 1/4	167	19	FLV1690-17WSD		\$3,354	\$3,692
	15 15/16	84	17 1/4	158	18	FLT1684-17WSD	\$1,918		
	15 15/16	84	17 1/4	158	18	FLV1684-17WSD		\$3,139	\$3,455



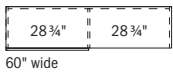
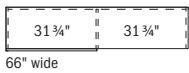
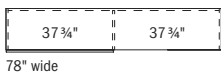
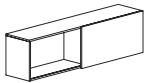
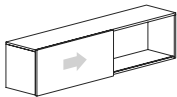
Features:

- supported by wall cleat - hardware provided by installer
- secure wall attachment required; pilot holes provided in back panel
- laminate grain direction runs horizontal on back panel of overhead cabinets
- locking not available

Options:

- must specify chassis grain direction on double cut veneer, see pages 13-15 for details
- veneer door fronts in paint available, specify paint color and add \$337 list; see page 16 for details
- on laminate units, contrasting laminate door fronts available, no upcharge; specify laminate color, see page 16 for details
- white glass doors with aluminum trim available, specify and add \$1,787 list for 96"w, \$1,714 list for 90"w, \$1,639 list for 84"w; see page 33 for details
- markerboard laminate doors available, specify and add \$569 list; see page 33 for details

Wall Mount Overhead Cabinet with Sliding Door	15 15/16	78	17 1/4	138	16	FLT1678-17WSD	\$1,789		
	15 15/16	78	17 1/4	138	16	FLV1678-17WSD		\$2,837	\$3,122
	15 15/16	72	17 1/4	129	15	FLT1672-17WSD	\$1,690		
	15 15/16	72	17 1/4	129	15	FLV1672-17WSD		\$2,678	\$2,945
	15 15/16	66	17 1/4	120	14	FLT1666-17WSD	\$1,599		
	15 15/16	66	17 1/4	120	14	FLV1666-17WSD		\$2,534	\$2,790
	15 15/16	60	17 1/4	111	13	FLT1660-17WSD	\$1,531		
	15 15/16	60	17 1/4	111	13	FLV1660-17WSD		\$2,428	\$2,672



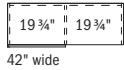
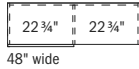
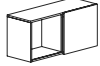
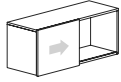
Features:

- supported by wall cleat - hardware provided by installer
- secure wall attachment required; pilot holes provided in back panel
- laminate grain direction runs horizontal on back panel of overhead cabinets
- locking not available

Options:

- must specify chassis grain direction on double cut veneer, see pages 13-15 for details
- veneer door fronts in paint available, specify paint color and add \$337 list; see page 16 for details
- on laminate units, contrasting laminate door fronts available, no upcharge; specify laminate color, see page 16 for details
- white glass doors with aluminum trim available, specify and add \$1,029 list for 78"w, \$971 list for 72"w, \$916 list for 66"w \$858 list for 60"w; see page 33 for details
- markerboard laminate doors available, specify and add \$286 list; see page 33 for details

Description	D	W	H	CTN WT	CU FT	① Model	Laminate	Flat Cut Veneer	Double Cut Veneer
Wall Mount Overhead Cabinet with Sliding Door	15 15/16	54	17 1/4	102	12	FLT1654-17WSD	\$1,496		
	15 15/16	54	17 1/4	102	12	FLV1654-17WSD		\$2,334	\$2,569
	15 15/16	48	17 1/4	92	10	FLT1648-17WSD	\$1,448		
	15 15/16	48	17 1/4	92	10	FLV1648-17WSD		\$2,260	\$2,487
	15 15/16	42	17 1/4	83	9	FLT1642-17WSD	\$1,404		
	15 15/16	42	17 1/4	83	9	FLV1642-17WSD		\$2,188	\$2,406



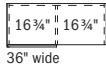
Features:

- supported by wall cleat - hardware provided by installer
- secure wall attachment required; pilot holes provided in back panel
- laminate grain direction runs horizontal on back panel of overhead cabinets
- locking not available

Options:

- must specify chassis grain direction on double cut veneer, see pages 13-15 for details
- veneer door fronts in paint available, specify paint color and add \$337 list; see page 16 for details
- on laminate units, contrasting laminate door fronts available, no upcharge; specify laminate color, see page 16 for details
- white glass doors with aluminum trim available, specify and add \$803 list for 54" w, \$778 list for 48" w, \$748 list for 42" w; see page 33 for details
- markerboard laminate doors available, specify and add \$286 list; see page 33 for details

Wall Mount Overhead Cabinet with Sliding Door	15 15/16	36	17 1/4	74	8	FLT1636-17WSD	\$1,331		
	15 15/16	36	17 1/4	74	8	FLV1636-17WSD		\$2,078	\$2,288
	15 15/16	30	17 1/4	65	7	FLT1630-17WSD	\$1,281		
	15 15/16	30	17 1/4	65	7	FLV1630-17WSD		\$1,995	\$2,195



Features:

- supported by wall cleat - hardware provided by installer
- secure wall attachment required; pilot holes provided in back panel
- laminate grain direction runs horizontal on back panel of overhead cabinets
- locking not available

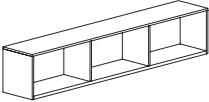
Options:

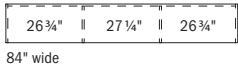
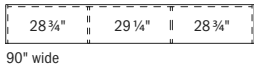
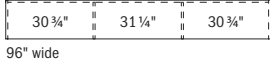
- must specify chassis grain direction on double cut veneer, see pages 13-15 for details
- veneer door fronts in paint available, specify paint color and add \$337 list; see page 16 for details
- on laminate units, contrasting laminate door fronts available, no upcharge; specify laminate color, see page 16 for details
- white glass doors with aluminum trim available, specify and add \$636 list for 36" w, \$607 list for 30" w; see page 33 for details
- markerboard laminate doors available, specify and add \$286 list; see page 33 for details

To Order, Specify:

① Laminate Model #	② Laminate Selection	③ Metal Color	④ Other Product Options
Laminate (FLT)	See Laminate Selection	See Metal Finish Color Options	See list of options for each specific unit; Specify and add accordingly.

① Veneer Model #	② Wood Species	③ Wood Finish	④ Metal Color	⑤ Other Product Options
Veneer (FLV)	Flat Cut CH1 Cherry MA1 Maple WA1 Walnut BO1 Black Oak	See Flat Cut Wood Finish Options	See Metal Finish Color Options	See list of options for each specific unit; Specify and add accordingly.
		<table border="1"> <thead> <tr> <th>③a Wood Finish</th> <th>③b Chassis Grain Direction</th> </tr> </thead> <tbody> <tr> <td>See Double Cut Wood Finish Options</td> <td>For Double Cut Only: Vertical Horizontal</td> </tr> </tbody> </table>		
③a Wood Finish	③b Chassis Grain Direction			
See Double Cut Wood Finish Options	For Double Cut Only: Vertical Horizontal			

Description	D	W	H	CTN WT	CU FT	① Model	Laminate	Flat Cut Veneer	Double Cut Veneer
Wall Mount Open Overhead 	15	96	17	145	19	FLT1596-17W00	\$1,679		
	15	96	17	145	19	FLV1596-17W00		\$2,844	\$3,130
	15	90	17	137	18	FLT1590-17W00	\$1,579		
	15	90	17	137	18	FLV1590-17W00		\$2,673	\$2,939
	15	84	17	130	17	FLT1584-17W00	\$1,475		
	15	84	17	130	17	FLV1584-17W00		\$2,497	\$2,747

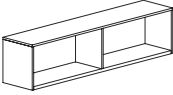


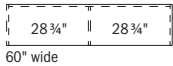
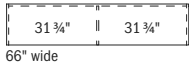
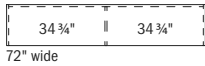
Features:

- supported by wall cleat - hardware provided by installer
- secure wall attachment required; pilot holes provided in back panel
- laminate grain direction runs horizontal on back panel of overhead cabinets

Options:

- must specify chassis grain direction on double cut veneer, see pages 13-15 for details

Wall Mount Open Overhead 	15	78	17	117	15	FLT1578-17W00	\$1,374		
	15	78	17	117	15	FLV1578-17W00		\$2,251	\$2,477
	15	72	17	109	14	FLT1572-17W00	\$1,296		
	15	72	17	109	14	FLV1572-17W00		\$2,122	\$2,332
	15	66	17	101	13	FLT1566-17W00	\$1,225		
	15	66	17	101	13	FLV1566-17W00		\$2,003	\$2,203
	15	60	17	98	12	FLT1560-17W00	\$1,173		
	15	60	17	98	12	FLV1560-17W00		\$1,917	\$2,108



Features:

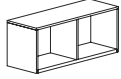
- supported by wall cleat - hardware provided by installer
- secure wall attachment required; pilot holes provided in back panel
- laminate grain direction runs horizontal on back panel of overhead cabinets

Options:

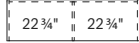
- must specify chassis grain direction on double cut veneer, see pages 13-15 for details

FLUX - PRIVATE OFFICE

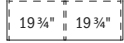
Description	D	W	H	CTN WT	CU FT	① Model	Laminate	Flat Cut Veneer	Double Cut Veneer
Wall Mount Open Overhead	15	54	17	90	11	FLT1554-17W00	\$1,146		
	15	54	17	90	11	FLV1554-17W00		\$1,845	\$2,030
	15	48	17	82	10	FLT1548-17W00	\$1,106		
	15	48	17	82	10	FLV1548-17W00		\$1,782	\$1,959
	15	42	17	74	9	FLT1542-17W00	\$1,072		
	15	42	17	74	9	FLV1542-17W00		\$1,724	\$1,896



54" wide



48" wide



42" wide

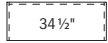
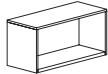
Features:

- supported by wall cleat - hardware provided by installer
- secure wall attachment required; pilot holes provided in back panel
- laminate grain direction runs horizontal on back panel of overhead cabinets

Options:

- must specify chassis grain direction on double cut veneer, see pages 13-15 for details

Wall Mount Open Overhead	15	36	17	57	8	FLT1536-17W00	\$1,015		
	15	36	17	57	8	FLV1536-17W00		\$1,633	\$1,798
	15	30	17	49	6	FLT1530-17W00	\$974		
	15	30	17	49	6	FLV1530-17W00		\$1,566	\$1,724



36" wide



30" wide

Features:

- supported by wall cleat - hardware provided by installer
- secure wall attachment required; pilot holes provided in back panel
- laminate grain direction runs horizontal on back panel of overhead cabinets

Options:

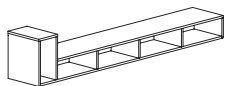
- must specify chassis grain direction on double cut veneer, see pages 13-15 for details

To Order, Specify:

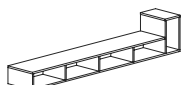
① Laminate Model #	② Laminate Selection	③ Metal Color	④ Other Product Options
Laminate (FLT)	See Laminate Selection	See Metal Finish Color Options	See list of options for each specific unit; Specify and add accordingly.

① Veneer Model #	② Wood Species	③ Wood Finish	④ Metal Color	⑤ Other Product Options
Veneer (FLV)	Flat Cut CH1 Cherry MA1 Maple WA1 Walnut BO1 Black Oak	See Flat Cut Wood Finish Options	See Metal Finish Color Options	See list of options for each specific unit; Specify and add accordingly.
		<table border="1"> <thead> <tr> <th>③a Wood Finish</th> <th>③b Chassis Grain Direction</th> </tr> </thead> <tbody> <tr> <td>See Double Cut Wood Finish Options</td> <td>For Double Cut Only: Vertical Horizontal</td> </tr> </tbody> </table>		
③a Wood Finish	③b Chassis Grain Direction			
See Double Cut Wood Finish Options	For Double Cut Only: Vertical Horizontal			

Description	D	W	H	CTN WT	CU FT	① Model	Laminate	Flat Cut Veneer	Double Cut Veneer
Wall Mount Cubby with Open Vertical Storage Compartment	15	96	17	100	19	FLT1596WCUOR	\$1,978		
	15	96	17	100	19	FLV1596WCUOR		\$3,045	\$3,347
	15	96	17	100	19	FLT1596WCUOL	\$1,978		
	15	96	17	100	19	FLV1596WCUOL		\$3,045	\$3,347
	15	90	17	96	18	FLT1590WCUOR	\$1,861		
	15	90	17	96	18	FLV1590WCUOR		\$2,767	\$3,046
	15	90	17	96	18	FLT1590WCUOL	\$1,861		
	15	90	17	96	18	FLV1590WCUOL		\$2,767	\$3,046
	15	84	17	91	17	FLT1584WCUOR	\$1,828		
	15	84	17	91	17	FLV1584WCUOR		\$2,570	\$2,827
	15	84	17	91	17	FLT1584WCUOL	\$1,828		
	15	84	17	91	17	FLV1584WCUOL		\$2,570	\$2,827



left shown



right

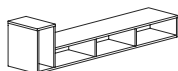
Features:

- supported by wall cleat - hardware provided by installer
- laminate grain direction runs horizontal on back panel of cubbies

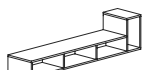
Options:

- must specify chassis grain direction on double cut veneer, see pages 13-15 for details

Wall Mount Cubby with Open Vertical Storage Compartment	15	78	17	85	15	FLT1578WCUOR	\$1,626		
	15	78	17	85	15	FLV1578WCUOR		\$2,487	\$2,735
	15	78	17	85	15	FLT1578WCUOL	\$1,626		
	15	78	17	85	15	FLV1578WCUOL		\$2,487	\$2,735
	15	72	17	80	14	FLT1572WCUOR	\$1,526		
	15	72	17	80	14	FLV1572WCUOR		\$2,327	\$2,562
	15	72	17	80	14	FLT1572WCUOL	\$1,526		
	15	72	17	80	14	FLV1572WCUOL		\$2,327	\$2,562
	15	66	17	75	13	FLT1566WCUOR	\$1,427		
	15	66	17	75	13	FLV1566WCUOR		\$2,168	\$2,386
	15	66	17	75	13	FLT1566WCUOL	\$1,427		
	15	66	17	75	13	FLV1566WCUOL		\$2,168	\$2,386
	15	60	17	70	12	FLT1560WCUOR	\$1,338		
	15	60	17	70	12	FLV1560WCUOR		\$2,026	\$2,231
	15	60	17	70	12	FLT1560WCUOL	\$1,338		
15	60	17	70	12	FLV1560WCUOL		\$2,026	\$2,231	



left shown



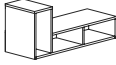
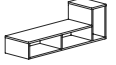
right

Features:

- supported by wall cleat - hardware provided by installer
- laminate grain direction runs horizontal on back panel of cubbies

Options:

- must specify chassis grain direction on double cut veneer, see pages 13-15 for details

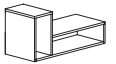

Description	D	W	H	CTN WT	CU FT	① Model	Laminate	Flat Cut Veneer	Double Cut Veneer
Wall Mount Cubby with Open Vertical Storage Compartment  left shown  right	15	54	17	64	11	FLT1554WCUOR	\$1,256		
	15	54	17	64	11	FLV1554WCUOR		\$1,899	\$2,089
	15	54	17	64	11	FLT1554WCUOL	\$1,256		
	15	54	17	64	11	FLV1554WCUOL		\$1,899	\$2,089
	15	48	17	59	10	FLT1548WCUOR	\$1,184		
	15	48	17	59	10	FLV1548WCUOR		\$1,785	\$1,962
	15	48	17	59	10	FLT1548WCUOL	\$1,184		
	15	48	17	59	10	FLV1548WCUOL		\$1,785	\$1,962
	15	42	17	54	9	FLT1542WCUOR	\$1,111		
	15	42	17	54	9	FLV1542WCUOR		\$1,670	\$1,837
	15	42	17	54	9	FLT1542WCUOL	\$1,111		
	15	42	17	54	9	FLV1542WCUOL		\$1,670	\$1,837

Features:

- supported by wall cleat - hardware provided by installer
- laminate grain direction runs horizontal on back panel of cubbies

Options:

- must specify chassis grain direction on double cut veneer, see pages 13-15 for details

Wall Mount Cubby with Open Vertical Storage Compartment  left shown  right	15	36	17	49	8	FLT1536WCUOR	\$1,045		
	15	36	17	49	8	FLV1536WCUOR		\$1,565	\$1,722
	15	36	17	49	8	FLT1536WCUOL	\$1,045		
	15	36	17	49	8	FLV1536WCUOL		\$1,565	\$1,722
	15	30	17	44	6	FLT1530WCUOR	\$988		
	15	30	17	44	6	FLV1530WCUOR		\$1,474	\$1,622
	15	30	17	44	6	FLT1530WCUOL	\$988		
	15	30	17	44	6	FLV1530WCUOL		\$1,474	\$1,622

Features:

- supported by wall cleat - hardware provided by installer
- laminate grain direction runs horizontal on back panel of cubbies

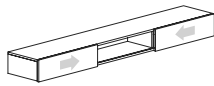

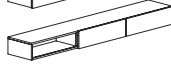
Options:

- must specify chassis grain direction on double cut veneer, see pages 13-15 for details

To Order, Specify:

① Laminate Model #	② Laminate Selection	③ Metal Color	④ Other Product Options
Laminate (FLT)	See Laminate Selection	See Metal Finish Color Options	See list of options for each specific unit; Specify and add accordingly.

① Veneer Model #	② Wood Species	③ Wood Finish	④ Metal Color	⑤ Other Product Options
Veneer (FLV)	Flat Cut CH1 Cherry MA1 Maple WA1 Walnut BO1 Black Oak	See Flat Cut Wood Finish Options	See Metal Finish Color Options	See list of options for each specific unit; Specify and add accordingly.
		<table border="1"> <thead> <tr> <th>③a Wood Finish</th> <th>③b Chassis Grain Direction</th> </tr> </thead> <tbody> <tr> <td>See Double Cut Wood Finish Options</td> <td>For Double Cut Only: Vertical Horizontal</td> </tr> </tbody> </table>		
③a Wood Finish	③b Chassis Grain Direction			
See Double Cut Wood Finish Options	For Double Cut Only: Vertical Horizontal			

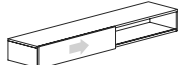
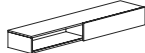
Description	D	W	H	CTN WT	CU FT	① Model	Laminate	Flat Cut Veneer	Double Cut Veneer
Wall Mount Cubby with Sliding Doors   	15 15/16	96	8 1/4	111	11	FLT1696WSDCU	\$2,003		
	15 15/16	96	8 1/4	111	11	FLV1696WSDCU		\$3,283	\$3,613
	15 15/16	90	8 1/4	100	11	FLT1690WSDCU	\$1,886		
	15 15/16	90	8 1/4	100	11	FLV1690WSDCU		\$3,088	\$3,396
	15 15/16	84	8 1/4	89	10	FLT1684WSDCU	\$1,765		
	15 15/16	84	8 1/4	89	10	FLV1684WSDCU		\$2,890	\$3,179

Features:

- supported by wall cleat - hardware provided by installer
- laminate grain direction runs horizontal on back panel of cubbies
- locking not available

Options:

- must specify chassis grain direction on double cut veneer, see pages 13-15 for details
- veneer door fronts in paint available, specify paint color and add \$337 list; see page 16 for details
- on laminate units, contrasting laminate door fronts available, no upcharge; specify laminate color, see page 16 for details
- white glass doors with aluminum trim available, specify and add \$1,639 list for 96" w, \$1,568 list for 90" w, \$1,538 list for 84" w; see page 33 for details
- markerboard laminate doors available, specify and add \$569 list; see page 33 for details

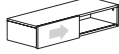

Wall Mount Cubby with Sliding Door  	15 15/16	78	8 1/4	79	9	FLT1678WSDCU	\$1,648		
	15 15/16	78	8 1/4	79	9	FLV1678WSDCU		\$2,611	\$2,872
	15 15/16	72	8 1/4	74	9	FLT1672WSDCU	\$1,554		
	15 15/16	72	8 1/4	74	9	FLV1672WSDCU		\$2,464	\$2,712
	15 15/16	66	8 1/4	69	8	FLT1666WSDCU	\$1,473		
	15 15/16	66	8 1/4	69	8	FLV1666WSDCU		\$2,331	\$2,565
	15 15/16	60	8 1/4	63	7	FLT1660WSDCU	\$1,410		
	15 15/16	60	8 1/4	63	7	FLV1660WSDCU		\$2,234	\$2,457

Features:

- supported by wall cleat - hardware provided by installer
- laminate grain direction runs horizontal on back panel of cubbies
- locking not available

Options:

- must specify chassis grain direction on double cut veneer, see pages 13-15 for details
- veneer door fronts in paint available, specify paint color and add \$337 list; see page 16 for details
- on laminate units, contrasting laminate door fronts available, no upcharge; specify laminate color, see page 16 for details
- white glass doors with aluminum trim available, specify and add \$822 list for 78" w, \$786 list for 72" w, \$772 list for 66" w or 60" w; see page 33 for details
- markerboard laminate doors available, specify and add \$286 list; see page 33 for details

Description	D	W	H	CTN WT	CU FT	① Model	Laminate	Flat Cut Veneer	Double Cut Veneer
Wall Mount Cubby with Sliding Door  	15 15/16	54	8 1/4	58	7	FLT1654WSDCU	\$1,378		
	15 15/16	54	8 1/4	58	7	FLV1654WSDCU		\$2,149	\$2,365
	15 15/16	48	8 1/4	53	6	FLT1648WSDCU	\$1,334		
	15 15/16	48	8 1/4	53	6	FLV1648WSDCU		\$2,078	\$2,288
	15 15/16	42	8 1/4	48	5	FLT1642WSDCU	\$1,291		
	15 15/16	42	8 1/4	48	5	FLV1642WSDCU		\$2,014	\$2,216
	15 15/16	36	8 1/4	43	5	FLT1636WSDCU	\$1,226		
	15 15/16	36	8 1/4	43	5	FLV1636WSDCU		\$1,912	\$2,105
	15 15/16	30	8 1/4	38	4	FLT1630WSDCU	\$1,177		
	15 15/16	30	8 1/4	38	4	FLV1630WSDCU		\$1,834	\$2,019

Features:

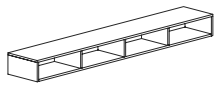
- supported by wall cleat - hardware provided by installer
- laminate grain direction runs horizontal on back panel of cubbies
- locking not available

Options:

- must specify chassis grain direction on double cut veneer, see pages 13-15 for details
- veneer door fronts in paint available, specify paint color and add \$337 list; see page 16 for details
- on laminate units, contrasting laminate door fronts available, no upcharge; specify laminate color, see page 16 for details
- white glass doors with aluminum trim available, specify and add \$772 list; see page 33 for details
- markerboard laminate doors available, specify and add \$286 list; see page 33 for details

To Order, Specify:

① Laminate Model #		② Laminate Selection		③ Metal Color	④ Other Product Options
Laminate (FLT)		See Laminate Selection		See Metal Finish Color Options	See list of options for each specific unit; Specify and add accordingly.
① Veneer Model #	② Wood Species	③ Wood Finish		④ Metal Color	⑤ Other Product Options
Veneer (FLV)	Flat Cut CH1 Cherry MA1 Maple WA1 Walnut BO1 Black Oak	See Flat Cut Wood Finish Options		See Metal Finish Color Options	See list of options for each specific unit; Specify and add accordingly.
	Double Cut DC1 Double Cut	3a Wood Finish See Double Cut Wood Finish Options	3b Chassis Grain Direction For Double Cut Only: Vertical Horizontal		

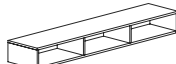
Description	D	W	H	CTN WT	CU FT	① Model	Laminate	Flat Cut Veneer	Double Cut Veneer
15"d Wall Mount Cubby 	15	96	8	90	11	FLT1596WCU	\$1,692		
	15	96	8	90	11	FLV1596WCU		\$2,603	\$2,863
	15	90	8	86	10	FLT1590WCU	\$1,591		
	15	90	8	86	10	FLV1590WCU		\$2,367	\$2,605
	15	84	8	81	9	FLT1584WCU	\$1,564		
	15	84	8	81	9	FLV1584WCU		\$2,198	\$2,418

Features:

- supported by wall cleat - hardware provided by installer
- laminate grain direction runs horizontal on back panel of cubbies

Options:

- must specify chassis grain direction on double cut veneer, see pages 13-15 for details

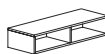
Description	D	W	H	CTN WT	CU FT	① Model	Laminate	Flat Cut Veneer	Double Cut Veneer
15"d Wall Mount Cubby 	15	78	8	75	9	FLT1578WCU	\$1,390		
	15	78	8	75	9	FLV1578WCU		\$2,126	\$2,337
	15	72	8	70	8	FLT1572WCU	\$1,305		
	15	72	8	70	8	FLV1572WCU		\$1,991	\$2,189
	15	66	8	65	8	FLT1566WCU	\$1,219		
	15	66	8	65	8	FLV1566WCU		\$1,854	\$2,040
	15	60	8	60	7	FLT1560WCU	\$1,145		
	15	60	8	60	7	FLV1560WCU		\$1,734	\$1,907

Features:

- supported by wall cleat - hardware provided by installer
- laminate grain direction runs horizontal on back panel of cubbies

Options:

- must specify chassis grain direction on double cut veneer, see pages 13-15 for details

Description	D	W	H	CTN WT	CU FT	① Model	Laminate	Flat Cut Veneer	Double Cut Veneer
15"d Wall Mount Cubby 	15	54	8	54	6	FLT1554WCU	\$1,074		
	15	54	8	54	6	FLV1554WCU		\$1,624	\$1,786
	15	48	8	49	6	FLT1548WCU	\$1,011		
	15	48	8	49	6	FLV1548WCU		\$1,526	\$1,678
	15	42	8	44	5	FLT1542WCU	\$949		
	15	42	8	44	5	FLV1542WCU		\$1,429	\$1,569
	15	36	8	39	4	FLT1536WCU	\$895		
	15	36	8	39	4	FLV1536WCU		\$1,339	\$1,473
	15	30	8	34	4	FLT1530WCU	\$845		
	15	30	8	34	4	FLV1530WCU		\$1,259	\$1,384

Features:

- supported by wall cleat - hardware provided by installer
- laminate grain direction runs horizontal on back panel of cubbies

Options:

- must specify chassis grain direction on double cut veneer, see pages 13-15 for details

Description	D	W	H	CTN WT	CU FT	① Model	Laminate	Flat Cut Veneer	Double Cut Veneer
	9	96	8	68	7	FLT0996WCU	\$1,510		
	9	96	8	68	7	FLV0996WCU		\$2,323	\$2,559
	9	90	8	64	7	FLT0990WCU	\$1,422		
	9	90	8	64	7	FLV0990WCU		\$2,114	\$2,326
	9	84	8	60	6	FLT0984WCU	\$1,397		
	9	84	8	60	6	FLV0984WCU		\$1,961	\$2,159

Features:

- supported by wall cleat - hardware provided by installer
- laminate grain direction runs horizontal on back panel of cubbies

Options:

- must specify chassis grain direction on double cut veneer, see pages 13-15 for details

Description	D	W	H	CTN WT	CU FT	① Model	Laminate	Flat Cut Veneer	Double Cut Veneer
	9	78	8	55	6	FLT0978WCU	\$1,241		
	9	78	8	55	6	FLV0978WCU		\$1,897	\$2,087
	9	72	8	51	5	FLT0972WCU	\$1,166		
	9	72	8	51	5	FLV0972WCU		\$1,778	\$1,955
	9	66	8	49	5	FLT0966WCU	\$1,090		
	9	66	8	49	5	FLV0966WCU		\$1,657	\$1,821
	9	60	8	43	5	FLT0960WCU	\$1,021		
	9	60	8	43	5	FLV0960WCU		\$1,548	\$1,702

Features:

- supported by wall cleat - hardware provided by installer
- laminate grain direction runs horizontal on back panel of cubbies

Options:

- must specify chassis grain direction on double cut veneer, see pages 13-15 for details

Description	D	W	H	CTN WT	CU FT	① Model	Laminate	Flat Cut Veneer	Double Cut Veneer
	9	54	8	39	4	FLT0954WCU	\$959		
	9	54	8	39	4	FLV0954WCU		\$1,451	\$1,597
	9	48	8	35	4	FLT0948WCU	\$906		
	9	48	8	35	4	FLV0948WCU		\$1,364	\$1,499
	9	42	8	31	3	FLT0942WCU	\$848		
	9	42	8	31	3	FLV0942WCU		\$1,275	\$1,403
	9	36	8	27	3	FLT0936WCU	\$800		
	9	36	8	27	3	FLV0936WCU		\$1,195	\$1,316
	9	30	8	23	3	FLT0930WCU	\$755		
	9	30	8	23	3	FLV0930WCU		\$1,124	\$1,237

Features:

- supported by wall cleat - hardware provided by installer
- laminate grain direction runs horizontal on back panel of cubbies


Options:

- must specify chassis grain direction on double cut veneer, see pages 13-15 for details

To Order, Specify:

① Laminate Model #	② Laminate Selection	③ Metal Color	④ Other Product Options
Laminate (FLT)	See Laminate Selection	See Metal Finish Color Options	See list of options for each specific unit; Specify and add accordingly.

① Veneer Model #	② Wood Species	③ Wood Finish	④ Metal Color	⑤ Other Product Options
Veneer (FLV)	Flat Cut CH1 Cherry MA1 Maple WA1 Walnut BO1 Black Oak	See Flat Cut Wood Finish Options	See Metal Finish Color Options	See list of options for each specific unit; Specify and add accordingly.
		③a Wood Finish See Double Cut Wood Finish Options		

Description	D	W	H	CTN WT	CU FT	① Model	Laminate	Flat Cut Veneer	Double Cut Veneer
Wall Mount Panel 	1 1/16	48	40 13/16	53	5	FLT4841WMP	\$1,103		
	1 1/16	48	40 13/16	53	5	FLV4841WMP		\$1,736	\$1,910
	1 1/16	42	40 13/16	48	4	FLT4241WMP	\$1,082		
	1 1/16	42	40 13/16	48	4	FLV4241WMP		\$1,701	\$1,871
	1 1/16	39	40 13/16	45	4	FLT3941WMP	\$1,055		
	1 1/16	39	40 13/16	45	4	FLV3941WMP		\$1,664	\$1,829
	1 1/16	36	40 13/16	42	4	FLT3641WMP	\$1,032		
	1 1/16	36	40 13/16	42	4	FLV3641WMP		\$1,626	\$1,787
	1 1/16	33	40 13/16	38	4	FLT3341WMP	\$1,005		
	1 1/16	33	40 13/16	38	4	FLV3341WMP		\$1,589	\$1,746
	1 1/16	30	40 13/16	36	3	FLT3041WMP	\$980		
	1 1/16	30	40 13/16	36	3	FLV3041WMP		\$1,554	\$1,709
	1 1/16	24	40 13/16	29	3	FLT2441WMP	\$961		
	1 1/16	24	40 13/16	29	3	FLV2441WMP		\$1,521	\$1,673
	1 1/16	18	40 13/16	23	2	FLT1841WMP	\$941		
	1 1/16	18	40 13/16	23	2	FLV1841WMP		\$1,489	\$1,637


Features:

- pair with primary height units to achieve 69" overall height
- supported by wall cleat - hardware provided by installer
- grain direction runs vertical on flat cut veneer, horizontal on laminate
- spacing of attachment cleats allows wire management

Options:

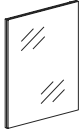
- must specify grain direction on double cut veneer, see pages 13-15 for details

FLUX - PRIVATE OFFICE

Description	D	W	H	CTN WT	CU FT	① Model	List Price
Wall Mount Markerboard 	1 1/16	48	40 13/16	53	5	FLB4841WMMB	\$1,300
	1 1/16	42	40 13/16	48	4	FLB4241WMMB	\$1,276
	1 1/16	39	40 13/16	45	4	FLB3941WMMB	\$1,247
	1 1/16	36	40 13/16	42	4	FLB3641WMMB	\$1,216
	1 1/16	33	40 13/16	38	4	FLB3341WMMB	\$1,185
	1 1/16	30	40 13/16	36	3	FLB3041WMMB	\$1,156
	1 1/16	24	40 13/16	29	3	FLB2441WMMB	\$1,132
	1 1/16	18	40 13/16	23	2	FLB1841WMMB	\$1,111

Features:

- pair with primary height units to achieve 69" overall height
- supported by wall cleat - hardware provided by installer
- standard markerboard laminate with aluminum pvc edge
- spacing of attachment cleats allows wire management



Description	D	W	H	CTN WT	CU FT	① Model	List Price
 Wall Mount Glass Markerboard	1 1/16	48	40 13/16	75	4	FLB4841WMMBG	\$3,367
	1 1/16	42	40 13/16	65	4	FLB4241WMMBG	\$2,876
	1 1/16	39	40 13/16	61	4	FLB3941WMMBG	\$2,735
	1 1/16	36	40 13/16	56	3	FLB3641WMMBG	\$2,596
	1 1/16	33	40 13/16	51	3	FLB3341WMMBG	\$2,454
	1 1/16	30	40 13/16	47	3	FLB3041WMMBG	\$2,312
	1 1/16	24	40 13/16	38	2	FLB2441WMMBG	\$2,032
	1 1/16	18	40 13/16	28	2	FLB1841WMMBG	\$1,751

Features:




- pair with primary height units to achieve 69" overall height
- supported by wall cleat - hardware provided by installer
- white back painted glass with an aluminum profile frame
- spacing of attachment cleats allows wire management

To Order, Specify:

① Laminate Model # Laminate (FLT)		② Laminate Selection See Laminate Selection		③ Metal Color See Metal Finish Color Options	④ Other Product Options See list of options for each specific unit; Specify and add accordingly.
① Veneer Model # Veneer (FLV)	② Wood Species Flat Cut CH1 Cherry MA1 Maple WA1 Walnut BO1 Black Oak	③ Wood Finish See Flat Cut Wood Finish Options		④ Metal Color See Metal Finish Color Options	⑤ Other Product Options See list of options for each specific unit; Specify and add accordingly.
	Double Cut DC1 Double Cut	③a Wood Finish See Double Cut Wood Finish Options	③b Chassis Grain Direction For Double Cut Only: Vertical Horizontal		

Description	D	W	H	CTN WT	CU FT	① Model	List Price Per Grade
48"w Wall Mount Tack Panel 	1 9/16	48	40 3/4	34	5	FLB4841WT	COM \$926 A \$946 B \$980 C \$1,044 D \$1,127 E \$1,212 F \$1,339 G \$1,475 H \$1,622 I \$1,851 J \$2,125
Features: · pair with primary height units to achieve 69" overall height · supported by wall cleat - hardware provided by installer · com ydg: 1 1/2							
42"w Wall Mount Tack Panel 	1 9/16	42	40 3/4	32	4	FLB4241WT	COM \$867 A \$886 B \$923 C \$987 D \$1,069 E \$1,152 F \$1,281 G \$1,415 H \$1,562 I \$1,793 J \$2,066
Features: · pair with primary height units to achieve 69" overall height · supported by wall cleat - hardware provided by installer · com ydg: 1 1/2							
39"w Wall Mount Tack Panel 	1 9/16	39	40 3/4	31	4	FLB3941WT	COM \$837 A \$852 B \$883 C \$935 D \$1,005 E \$1,074 F \$1,181 G \$1,296 H \$1,416 I \$1,607 J \$1,836
Features: · pair with primary height units to achieve 69" overall height · supported by wall cleat - hardware provided by installer · com ydg: 1 1/4							
36"w Wall Mount Tack Panel 	1 9/16	36	40 3/4	30	4	FLB3641WT	COM \$806 A \$822 B \$852 C \$907 D \$975 E \$1,043 F \$1,151 G \$1,264 H \$1,385 I \$1,578 J \$1,807
Features: · pair with primary height units to achieve 69" overall height · supported by wall cleat - hardware provided by installer · com ydg: 1 1/4							


FLUX - PRIVATE OFFICE

Description	D	W	H	CTN WT	CU FT	① Model	List Price Per Grade
33"w Wall Mount Tack Panel	1 1/16	33	40 3/4	29	4	FLB3341WT	COM \$777 A \$793 B \$822 C \$876 D \$946 E \$1,012 F \$1,120 G \$1,235 H \$1,359 I \$1,547 J \$1,777
	Features: <ul style="list-style-type: none"> · pair with primary height units to achieve 69" overall height · supported by wall cleat - hardware provided by installer · com ydg: 1 1/4 						
30"w Wall Mount Tack Panel	1 1/16	30	40 3/4	28	3	FLB3041WT	COM \$747 A \$759 B \$783 C \$825 D \$882 E \$935 F \$1,021 G \$1,113 H \$1,212 I \$1,364 J \$1,546
	Features: <ul style="list-style-type: none"> · pair with primary height units to achieve 69" overall height · supported by wall cleat - hardware provided by installer · com ydg: 1 						
24"w Wall Mount Tack Panel	1 1/16	24	40 3/4	23	3	FLB2441WT	COM \$687 A \$702 B \$724 C \$768 D \$822 E \$877 F \$964 G \$1,054 H \$1,152 I \$1,303 J \$1,487
	Features: <ul style="list-style-type: none"> · pair with primary height units to achieve 69" overall height · supported by wall cleat - hardware provided by installer · com ydg: 1 						
18"w Wall Mount Tack Panel	1 1/16	18	40 3/4	18	2	FLB1841WT	COM \$627 A \$641 B \$665 C \$708 D \$761 E \$816 F \$904 G \$995 H \$1,091 I \$1,245 J \$1,427
	Features: <ul style="list-style-type: none"> · pair with primary height units to achieve 69" overall height · supported by wall cleat - hardware provided by installer · com ydg: 1 						

FLUX - PRIVATE OFFICE

To Order, Specify:

① Model Number	② Fabric Selection	
(FLB)	Vendor Pattern Color	Visit www.jsifurniture.com/finishes-and-materials/textiles for our textiles program. See selection of standard and graded in manufacturers and patterns.


Description	D	W	H	CTN WT	CU FT	① Model	Laminate	Flat Cut Veneer	Double Cut Veneer
Wall Mount Panel 	1 1/16	48	23 1/2	33	3	FLT4824WMP	\$914		
	1 1/16	48	23 1/2	33	3	FLV4824WMP		\$1,438	\$1,582
	1 1/16	42	23 1/2	30	3	FLT4224WMP	\$897		
	1 1/16	42	23 1/2	30	3	FLV4224WMP		\$1,411	\$1,553
	1 1/16	39	23 1/2	28	3	FLT3924WMP	\$874		
	1 1/16	39	23 1/2	28	3	FLV3924WMP		\$1,378	\$1,515
	1 1/16	36	23 1/2	26	3	FLT3624WMP	\$854		
	1 1/16	36	23 1/2	26	3	FLV3624WMP		\$1,347	\$1,483
	1 1/16	33	23 1/2	24	2	FLT3324WMP	\$834		
	1 1/16	33	23 1/2	24	2	FLV3324WMP		\$1,319	\$1,450
	1 1/16	30	23 1/2	22	2	FLT3024WMP	\$813		
	1 1/16	30	23 1/2	22	2	FLV3024WMP		\$1,288	\$1,415
	1 1/16	24	23 1/2	18	2	FLT2424WMP	\$797		
	1 1/16	24	23 1/2	18	2	FLV2424WMP		\$1,260	\$1,385
	1 1/16	18	23 1/2	14	2	FLT1824WMP	\$781		
1 1/16	18	23 1/2	14	2	FLV1824WMP		\$1,234	\$1,359	

Features:

- pair with primary height units and overhead cabinets or shelves to achieve 69" overall height
- supported by wall cleat - hardware provided by installer
- grain direction runs vertical on flat cut veneer, horizontal on laminate
- spacing of attachment cleats allows wire management


Options:

- must specify grain direction on double cut veneer, see pages 13-15 for details

Description	D	W	H	CTN WT	CU FT	① Model	List Price
Wall Mount Markerboard 	1 1/16	48	23 1/2	36	3	FLB4824WMMB	\$1,078
	1 1/16	42	23 1/2	30	3	FLB4224WMMB	\$1,057
	1 1/16	39	23 1/2	28	3	FLB3924WMMB	\$1,033
	1 1/16	36	23 1/2	26	3	FLB3624WMMB	\$1,007
	1 1/16	33	23 1/2	24	2	FLB3324WMMB	\$981
	1 1/16	30	23 1/2	21	2	FLB3024WMMB	\$959
	1 1/16	24	23 1/2	18	2	FLB2424WMMB	\$937
	1 1/16	18	23 1/2	14	2	FLB1824WMMB	\$921

Features:

- pair with primary height units and overhead cabinets or shelves to achieve 69" overall height
- supported by wall cleat - hardware provided by installer
- standard markerboard laminate with aluminum pvc edge
- spacing of attachment cleats allows wire management

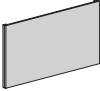

Description	D	W	H	CTN WT	CU FT	① Model	List Price
 Wall Mount Glass Markerboard	1 1/16	48	23 1/2	43	3	FLB4824WMMBG	\$2,203
	1 1/16	42	23 1/2	38	2	FLB4224WMMBG	\$2,042
	1 1/16	39	23 1/2	35	2	FLB3924WMMBG	\$1,960
	1 1/16	36	23 1/2	33	2	FLB3624WMMBG	\$1,882
	1 1/16	33	23 1/2	30	2	FLB3324WMMBG	\$1,802
	1 1/16	30	23 1/2	27	2	FLB3024WMMBG	\$1,720
	1 1/16	24	23 1/2	22	2	FLB2424WMMBG	\$1,557
	1 1/16	18	23 1/2	17	1	FLB1824WMMBG	\$1,397

Features:

- pair with primary height units and overhead cabinets or shelves to achieve 69" overall height
- supported by wall cleat - hardware provided by installer
- white back painted glass with an aluminum profile frame
- spacing of attachment cleats allows wire management

To Order, Specify:

① Laminate Model #		② Laminate Selection		③ Metal Color	④ Other Product Options
Laminate (FLT)		See Laminate Selection		See Metal Finish Color Options	See list of options for each specific unit; Specify and add accordingly.
① Veneer Model #	② Wood Species	③ Wood Finish		④ Metal Color	⑤ Other Product Options
Veneer (FLV)	Flat Cut CH1 Cherry MA1 Maple WA1 Walnut BO1 Black Oak	See Flat Cut Wood Finish Options		See Metal Finish Color Options	See list of options for each specific unit; Specify and add accordingly.
		③a Wood Finish	③b Chassis Grain Direction		
	Double Cut DC1 Double Cut	See Double Cut Wood Finish Options	For Double Cut Only: Vertical Horizontal		

Description	D	W	H	CTN WT	CU FT	① Model	List Price Per Grade
48"w Wall Mount Tack Panel 	1 9/16	48	23 1/2	20	3	FLB4824WT	COM \$724
	Features: <ul style="list-style-type: none"> · pair with primary height units and overhead cabinets or shelves to achieve 69" overall height · supported by wall cleat - hardware provided by installer · com ydg: 1 1/2 						A \$743 B \$779 C \$844 D \$926 E \$1,008 F \$1,137 G \$1,273 H \$1,419 I \$1,649 J \$1,923
42"w Wall Mount Tack Panel 	1 9/16	42	23 1/2	18	3	FLB4224WT	COM \$688
	Features: <ul style="list-style-type: none"> · pair with primary height units and overhead cabinets or shelves to achieve 69" overall height · supported by wall cleat - hardware provided by installer · com ydg: 1 1/2 						A \$709 B \$743 C \$807 D \$891 E \$972 F \$1,102 G \$1,237 H \$1,383 I \$1,614 J \$1,888
39"w Wall Mount Tack Panel 	1 9/16	39	23 1/2	18	3	FLB3924WT	COM \$671
	Features: <ul style="list-style-type: none"> · pair with primary height units and overhead cabinets or shelves to achieve 69" overall height · supported by wall cleat - hardware provided by installer · com ydg: 1 1/4 						A \$687 B \$718 C \$772 D \$841 E \$909 F \$1,015 G \$1,130 H \$1,252 I \$1,442 J \$1,671
36"w Wall Mount Tack Panel 	1 9/16	36	23 1/2	17	2	FLB3624WT	COM \$654
	Features: <ul style="list-style-type: none"> · pair with primary height units and overhead cabinets or shelves to achieve 69" overall height · supported by wall cleat - hardware provided by installer · com ydg: 1 1/4 						A \$670 B \$702 C \$754 D \$823 E \$892 F \$998 G \$1,113 H \$1,235 I \$1,424 J \$1,655


FLUX - PRIVATE OFFICE

Description	D	W	H	CTN WT	CU FT	① Model	List Price Per Grade
33"w Wall Mount Tack Panel	1 9/16	33	23 1/2	17	2	FLB3324WT	COM \$638
 <p>Features:</p> <ul style="list-style-type: none"> · pair with primary height units and overhead cabinets or shelves to achieve 69" overall height · supported by wall cleat - hardware provided by installer · com ydg: 1 1/4 	A						\$653
	B						\$683
	C						\$737
	D						\$806
	E						\$874
	F						\$980
	G						\$1,096
	H						\$1,218
	I						\$1,409
	J						\$1,636
30"w Wall Mount Tack Panel	1 9/16	30	23 1/2	16	2	FLB3024WT	COM \$619
 <p>Features:</p> <ul style="list-style-type: none"> · pair with primary height units and overhead cabinets or shelves to achieve 69" overall height · supported by wall cleat - hardware provided by installer · com ydg: 1 	A						\$631
	B						\$655
	C						\$699
	D						\$754
	E						\$810
	F						\$894
	G						\$987
	H						\$1,083
	I						\$1,236
	J						\$1,417
24"w Wall Mount Tack Panel	1 9/16	24	23 1/2	14	2	FLB2424WT	COM \$585
 <p>Features:</p> <ul style="list-style-type: none"> · pair with primary height units and overhead cabinets or shelves to achieve 69" overall height · supported by wall cleat - hardware provided by installer · com ydg: 1 	A						\$598
	B						\$621
	C						\$666
	D						\$720
	E						\$775
	F						\$860
	G						\$952
	H						\$1,048
	I						\$1,202
	J						\$1,383
18"w Wall Mount Tack Panel	1 9/16	18	23 1/2	11	2	FLB1824WT	COM \$552
 <p>Features:</p> <ul style="list-style-type: none"> · pair with primary height units and overhead cabinets or shelves to achieve 69" overall height · supported by wall cleat - hardware provided by installer · com ydg: 1 	A						\$563
	B						\$588
	C						\$630
	D						\$686
	E						\$741
	F						\$825
	G						\$919
	H						\$1,015
	I						\$1,168
	J						\$1,349

FLUX - PRIVATE OFFICE

To Order, Specify:

① Model Number	② Fabric Selection	
(FLB)	Vendor Pattern Color	Visit www.jsifurniture.com/finishes-and-materials/textiles for our textiles program. See selection of standard and graded in manufacturers and patterns.


Description	D	W	H	CTN WT	CU FT	① Model	Laminate	Flat Cut Veneer	Double Cut Veneer
Wall Mount Panel 	1 1/16	48	31 1/2	42	4	FLT4832WMP	\$977		
	1 1/16	48	31 1/2	42	4	FLV4832WMP		\$1,537	\$1,691
	1 1/16	42	31 1/2	38	4	FLT4232WMP	\$958		
	1 1/16	42	31 1/2	38	4	FLV4232WMP		\$1,506	\$1,658
	1 1/16	39	31 1/2	36	3	FLT3932WMP	\$934		
	1 1/16	39	31 1/2	36	3	FLV3932WMP		\$1,473	\$1,621
	1 1/16	36	31 1/2	33	3	FLT3632WMP	\$913		
	1 1/16	36	31 1/2	33	3	FLV3632WMP		\$1,440	\$1,584
	1 1/16	33	31 1/2	31	3	FLT3332WMP	\$891		
	1 1/16	33	31 1/2	31	3	FLV3332WMP		\$1,407	\$1,548
	1 1/16	30	31 1/2	28	3	FLT3032WMP	\$868		
	1 1/16	30	31 1/2	28	3	FLV3032WMP		\$1,374	\$1,513
	1 1/16	24	31 1/2	23	2	FLT2432WMP	\$851		
	1 1/16	24	31 1/2	23	2	FLV2432WMP		\$1,347	\$1,483
	1 1/16	18	31 1/2	18	2	FLT1832WMP	\$835		
1 1/16	18	31 1/2	18	2	FLV1832WMP		\$1,319	\$1,450	

Features:

- pair with secondary height units and overhead cabinets or shelves to achieve 69" overall height
- supported by wall cleat - hardware provided by installer
- grain direction runs vertical on flat cut veneer, horizontal on laminate
- spacing of attachment cleats allows wire management


Options:

- must specify grain direction on double cut veneer, see pages 13-15 for details

								List Price
Wall Mount Markerboard 	1 1/16	48	31 1/2	42	4	FLB4832WMMB		\$1,113
	1 1/16	42	31 1/2	38	4	FLB4232WMMB		\$1,090
	1 1/16	39	31 1/2	36	3	FLB3932WMMB		\$1,064
	1 1/16	36	31 1/2	33	3	FLB3632WMMB		\$1,039
	1 1/16	33	31 1/2	31	3	FLB3332WMMB		\$1,012
	1 1/16	30	31 1/2	28	3	FLB3032WMMB		\$990
	1 1/16	24	31 1/2	23	2	FLB2432WMMB		\$969
	1 1/16	18	31 1/2	18	2	FLB1832WMMB		\$949

Features:

- pair with secondary height units and overhead cabinets or shelves to achieve 69" overall height
- supported by wall cleat - hardware provided by installer
- standard markerboard laminate with aluminum pvc edge
- spacing of attachment cleats allows wire management

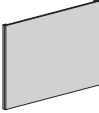
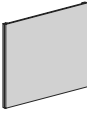
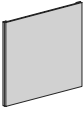
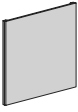
Description	D	W	H	CTN WT	CU FT	① Model	List Price
 Wall Mount Glass Markerboard	1 1/16	48	31 1/2	58	3	FLB4832WMMBG	\$2,808
	1 1/16	42	31 1/2	51	3	FLB4232WMMBG	\$2,429
	1 1/16	39	31 1/2	47	3	FLB3932WMMBG	\$2,320
	1 1/16	36	31 1/2	43	3	FLB3632WMMBG	\$2,210
	1 1/16	33	31 1/2	40	3	FLB3332WMMBG	\$2,104
	1 1/16	30	31 1/2	36	2	FLB3032WMMBG	\$1,995
	1 1/16	24	31 1/2	29	2	FLB2432WMMBG	\$1,779
	1 1/16	18	31 1/2	22	2	FLB1832WMMBG	\$1,561

Features:




- pair with secondary height units and overhead cabinets or shelves to achieve 69" overall height
- supported by wall cleat - hardware provided by installer
- white back painted glass with an aluminum profile frame
- spacing of attachment cleats allows wire management

To Order, Specify:

① Laminate Model # Laminate (FLT)		② Laminate Selection See Laminate Selection		③ Metal Color See Metal Finish Color Options	④ Other Product Options See list of options for each specific unit; Specify and add accordingly.
① Veneer Model # Veneer (FLV)	② Wood Species Flat Cut CH1 Cherry MA1 Maple WA1 Walnut BO1 Black Oak	③ Wood Finish See Flat Cut Wood Finish Options		④ Metal Color See Metal Finish Color Options	⑤ Other Product Options See list of options for each specific unit; Specify and add accordingly.
	Double Cut DC1 Double Cut	③a Wood Finish See Double Cut Wood Finish Options	③b Chassis Grain Direction For Double Cut Only: Vertical Horizontal		

Description	D	W	H	CTN WT	CU FT	① Model	List Price Per Grade
48"w Wall Mount Tack Panel 	1 9/16	48	31 1/2	27	4	FLB4832WT	COM \$816 A \$837 B \$872 C \$935 D \$1,019 E \$1,102 F \$1,229 G \$1,366 H \$1,513 I \$1,742 J \$2,016
Features: · pair with secondary height units and overhead cabinets or shelves to achieve 69" overall height · supported by wall cleat - hardware provided by installer · com ydg: 1 1/2							
42"w Wall Mount Tack Panel 	1 9/16	42	31 1/2	25	3	FLB4232WT	COM \$772 A \$792 B \$825 C \$891 D \$972 E \$1,055 F \$1,184 G \$1,321 H \$1,468 I \$1,696 J \$1,971
Features: · pair with secondary height units and overhead cabinets or shelves to achieve 69" overall height · supported by wall cleat - hardware provided by installer · com ydg: 1 1/2							
39"w Wall Mount Tack Panel 	1 9/16	39	31 1/2	24	3	FLB3932WT	COM \$748 A \$763 B \$794 C \$847 D \$917 E \$986 F \$1,091 G \$1,208 H \$1,328 I \$1,517 J \$1,746
Features: · pair with secondary height units and overhead cabinets or shelves to achieve 69" overall height · supported by wall cleat - hardware provided by installer · com ydg: 1 1/4							
36"w Wall Mount Tack Panel 	1 9/16	36	31 1/2	23	3	FLB3632WT	COM \$726 A \$741 B \$772 C \$824 D \$894 E \$964 F \$1,069 G \$1,184 H \$1,305 I \$1,495 J \$1,725
Features: · pair with secondary height units and overhead cabinets or shelves to achieve 69" overall height · supported by wall cleat - hardware provided by installer · com ydg: 1 1/4							


FLUX - PRIVATE OFFICE

Description	D	W	H	CTN WT	CU FT	① Model	List Price Per Grade
33"w Wall Mount Tack Panel	1 9/16	33	31 1/2	22	3	FLB3332WT	COM \$703 A \$718 B \$748 C \$801 D \$871 E \$937 F \$1,044 G \$1,161 H \$1,283 I \$1,473 J \$1,701
	Features: <ul style="list-style-type: none"> · pair with secondary height units and overhead cabinets or shelves to achieve 69" overall height · supported by wall cleat - hardware provided by installer · com ydg: 1 1/4 						
30"w Wall Mount Tack Panel	1 9/16	30	31 1/2	21	3	FLB3032WT	COM \$679 A \$690 B \$716 C \$758 D \$813 E \$868 F \$955 G \$1,044 H \$1,142 I \$1,296 J \$1,478
	Features: <ul style="list-style-type: none"> · pair with secondary height units and overhead cabinets or shelves to achieve 69" overall height · supported by wall cleat - hardware provided by installer · com ydg: 1 						
24"w Wall Mount Tack Panel	1 9/16	24	31 1/2	18	2	FLB2432WT	COM \$631 A \$646 B \$669 C \$712 D \$768 E \$822 F \$908 G \$999 H \$1,096 I \$1,250 J \$1,432
	Features: <ul style="list-style-type: none"> · pair with secondary height units and overhead cabinets or shelves to achieve 69" overall height · supported by wall cleat - hardware provided by installer · com ydg: 1 						
18"w Wall Mount Tack Panel	1 9/16	18	31 1/2	14	2	FLB1832WT	COM \$587 A \$599 B \$623 C \$667 D \$721 E \$777 F \$861 G \$955 H \$1,050 I \$1,204 J \$1,384
	Features: <ul style="list-style-type: none"> · pair with secondary height units and overhead cabinets or shelves to achieve 69" overall height · supported by wall cleat - hardware provided by installer · com ydg: 1 						

FLUX - PRIVATE OFFICE

To Order, Specify:

① Model Number	② Fabric Selection
(FLB)	Vendor Pattern Color Visit www.jsifurniture.com/finishes-and-materials/textiles for our textiles program. See selection of standard and graded in manufacturers and patterns.


Description	D	W	H	CTN WT	CU FT	① Model	Laminate	Flat Cut Veneer	Double Cut Veneer
Wall Mount Panel 	1 1/16	48	48 13/16	63	6	FLT4849WMP	\$1,202		
	1 1/16	48	48 13/16	63	6	FLV4849WMP		\$1,891	\$2,087
	1 1/16	42	48 13/16	56	5	FLT4249WMP	\$1,178		
	1 1/16	42	48 13/16	56	5	FLV4249WMP		\$1,854	\$2,040
	1 1/16	39	48 13/16	53	5	FLT3949WMP	\$1,151		
	1 1/16	39	48 13/16	53	5	FLV3949WMP		\$1,813	\$1,995
	1 1/16	36	48 13/16	49	4	FLT3649WMP	\$1,122		
	1 1/16	36	48 13/16	49	4	FLV3649WMP		\$1,773	\$1,949
	1 1/16	33	48 13/16	45	4	FLT3349WMP	\$1,095		
	1 1/16	33	48 13/16	45	4	FLV3349WMP		\$1,733	\$1,906
	1 1/16	30	48 13/16	42	4	FLT3049WMP	\$1,069		
	1 1/16	30	48 13/16	42	4	FLV3049WMP		\$1,693	\$1,861
	1 1/16	24	48 13/16	35	3	FLT2449WMP	\$1,047		
	1 1/16	24	48 13/16	35	3	FLV2449WMP		\$1,659	\$1,824
	1 1/16	18	48 13/16	27	3	FLT1849WMP	\$1,029		
1 1/16	18	48 13/16	27	3	FLV1849WMP		\$1,623	\$1,785	

Features:

- pair with secondary height units to achieve 69" overall height
- supported by wall cleat - hardware provided by installer
- grain direction runs vertical on flat cut veneer, horizontal on laminate
- spacing of attachment cleats allows wire management

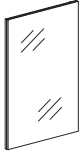
Options:

- must specify grain direction on double cut veneer, see pages 13-15 for details

Description	D	W	H	CTN WT	CU FT	① Model	List Price
Wall Mount Markerboard 	1 1/16	48	48 13/16	63	6	FLB4849WMMB	\$1,417
	1 1/16	42	48 13/16	56	5	FLB4249WMMB	\$1,390
	1 1/16	39	48 13/16	53	5	FLB3949WMMB	\$1,359
	1 1/16	36	48 13/16	49	4	FLB3649WMMB	\$1,324
	1 1/16	33	48 13/16	45	4	FLB3349WMMB	\$1,292
	1 1/16	30	48 13/16	42	4	FLB3049WMMB	\$1,259
	1 1/16	24	48 13/16	35	3	FLB2449WMMB	\$1,235
	1 1/16	18	48 13/16	27	3	FLB1849WMMB	\$1,212

Features:

- pair with secondary height units to achieve 69" overall height
- supported by wall cleat - hardware provided by installer
- standard markerboard laminate with aluminum pvc edge
- spacing of attachment cleats allows wire management

Description	D	W	H	CTN WT	CU FT	① Model	List Price
 Wall Mount Glass Markerboard	1 1/16	48	48 13/16	89	5	FLB4849WMMBG	\$3,844
	1 1/16	42	48 13/16	78	4	FLB4249WMMBG	\$3,477
	1 1/16	39	48 13/16	73	4	FLB3949WMMBG	\$3,293
	1 1/16	36	48 13/16	67	4	FLB3649WMMBG	\$3,112
	1 1/16	33	48 13/16	61	4	FLB3349WMMBG	\$2,930
	1 1/16	30	48 13/16	56	3	FLB3049WMMBG	\$2,744
	1 1/16	24	48 13/16	45	3	FLB2449WMMBG	\$2,376
	1 1/16	18	48 13/16	34	2	FLB1849WMMBG	\$1,917

Features:





- pair with secondary height units to achieve 69" overall height
- supported by wall cleat - hardware provided by installer
- white back painted glass with an aluminum profile frame
- spacing of attachment cleats allows wire management

FLUX - PRIVATE OFFICE



To Order, Specify:

① Laminate Model #	② Laminate Selection		③ Metal Color	④ Other Product Options
Laminate (FLT)	See Laminate Selection		See Metal Finish Color Options	See list of options for each specific unit; Specify and add accordingly.

① Veneer Model #	② Wood Species	③ Wood Finish		④ Metal Color	⑤ Other Product Options
Veneer (FLV)	Flat Cut CH1 Cherry MA1 Maple WA1 Walnut BO1 Black Oak	See Flat Cut Wood Finish Options		See Metal Finish Color Options	See list of options for each specific unit; Specify and add accordingly.
		③a Wood Finish	③b Chassis Grain Direction		
	Double Cut DC1 Double Cut	See Double Cut Wood Finish Options	For Double Cut Only: Vertical Horizontal		

Description	D	W	H	CTN WT	CU FT	① Model	List Price Per Grade
48" w Wall Mount Tack Panel 	1 9/16	48	48 3/4	41	6	FLB4849WT	COM \$1,020 A \$1,040 B \$1,075 C \$1,140 D \$1,222 E \$1,303 F \$1,433 G \$1,568 H \$1,715 I \$1,945 J \$2,220
Features: <ul style="list-style-type: none"> · pair with secondary height units to achieve 69" overall height · supported by wall cleat - hardware provided by installer · com ydg: 1 1/2 							
42" w Wall Mount Tack Panel 	1 9/16	42	48 3/4	38	5	FLB4249WT	COM \$948 A \$968 B \$1,002 C \$1,068 D \$1,151 E \$1,233 F \$1,362 G \$1,496 H \$1,643 I \$1,872 J \$2,147
Features: <ul style="list-style-type: none"> · pair with secondary height units to achieve 69" overall height · supported by wall cleat - hardware provided by installer · com ydg: 1 1/2 							
39" w Wall Mount Tack Panel 	1 9/16	39	48 3/4	37	5	FLB3949WT	COM \$913 A \$928 B \$959 C \$1,011 D \$1,082 E \$1,151 F \$1,256 G \$1,371 H \$1,493 I \$1,684 J \$1,912
Features: <ul style="list-style-type: none"> · pair with secondary height units to achieve 69" overall height · supported by wall cleat - hardware provided by installer · com ydg: 1 1/4 							
36" w Wall Mount Tack Panel 	1 9/16	36	48 3/4	36	4	FLB3649WT	COM \$877 A \$893 B \$924 C \$977 D \$1,045 E \$1,114 F \$1,220 G \$1,337 H \$1,456 I \$1,648 J \$1,877
Features: <ul style="list-style-type: none"> · pair with secondary height units to achieve 69" overall height · supported by wall cleat - hardware provided by installer · com ydg: 1 1/4 							


FLUX - PRIVATE OFFICE

Description	D	W	H	CTN WT	CU FT	① Model	List Price Per Grade																
33" w Wall Mount Tack Panel	1 9/16	33	48 3/4	34	4	FLB3349WT	COM \$841																
 <p>Features:</p> <ul style="list-style-type: none"> · pair with secondary height units to achieve 69" overall height · supported by wall cleat - hardware provided by installer · com ydg: 1 1/4 	A	\$856	B	\$886	C	\$940	D	\$1,009	E	\$1,078	F	\$1,184	G	\$1,299	H	\$1,421	I	\$1,611	J	\$1,841			
	30" w Wall Mount Tack Panel	1 9/16	30	48 3/4	33	4	FLB3049WT	COM \$804															
	 <p>Features:</p> <ul style="list-style-type: none"> · pair with secondary height units to achieve 69" overall height · supported by wall cleat - hardware provided by installer · com ydg: 1 	A	\$817	B	\$843	C	\$885	D	\$940	E	\$996	F	\$1,081	G	\$1,173	H	\$1,268	I	\$1,422	J	\$1,604		
		24" w Wall Mount Tack Panel	1 9/16	24	48 3/4	28	3	FLB2449WT	COM \$733														
		 <p>Features:</p> <ul style="list-style-type: none"> · pair with secondary height units to achieve 69" overall height · supported by wall cleat - hardware provided by installer · com ydg: 1 	A	\$747	B	\$771	C	\$813	D	\$868	E	\$924	F	\$1,008	G	\$1,101	H	\$1,196	I	\$1,349	J	\$1,533	
			18" w Wall Mount Tack Panel	1 9/16	18	48 3/4	22	3	FLB1849WT	COM \$664													
			 <p>Features:</p> <ul style="list-style-type: none"> · pair with secondary height units to achieve 69" overall height · supported by wall cleat - hardware provided by installer · com ydg: 1 	A	\$675	B	\$699	C	\$742	D	\$797	E	\$852	F	\$936	G	\$1,031	H	\$1,125	I	\$1,281	J	\$1,461

FLUX - PRIVATE OFFICE

To Order, Specify:

① Model Number	② Fabric Selection
(FLB)	<p>Vendor Pattern Color</p> <p>Visit www.jsifurniture.com/finishes-and-materials/textiles for our textiles program. See selection of standard and graded in manufacturers and patterns.</p>


Description	D	W	H	CTN WT	CU FT	① Model	Laminate	Flat Cut Veneer	Double Cut Veneer
 Workwall Panel with Mini Shelf	8 1/2	48	23 1/2	50	13	FLT4824WPMS	\$1,109		
	8 1/2	48	23 1/2	50	13	FLV4824WPMS		\$1,736	\$1,910
	8 1/2	42	23 1/2	36	8	FLT4224WPMS	\$945		
	8 1/2	42	23 1/2	36	8	FLV4224WPMS		\$1,484	\$1,631
	8 1/2	39	23 1/2	34	7	FLT3924WPMS	\$921		
	8 1/2	39	23 1/2	34	7	FLV3924WPMS		\$1,451	\$1,597
	8 1/2	36	23 1/2	31	7	FLT3624WPMS	\$898		
	8 1/2	36	23 1/2	31	7	FLV3624WPMS		\$1,417	\$1,560
	8 1/2	33	23 1/2	28	6	FLT3324WPMS	\$877		
	8 1/2	33	23 1/2	28	6	FLV3324WPMS		\$1,384	\$1,525
	8 1/2	30	23 1/2	26	6	FLT3024WPMS	\$855		
	8 1/2	30	23 1/2	26	6	FLV3024WPMS		\$1,357	\$1,490
	8 1/2	24	23 1/2	29	7	FLT2424WPMS	\$950		
	8 1/2	24	23 1/2	29	7	FLV2424WPMS		\$1,510	\$1,663

Features:

- pair with primary height units and overhead cabinets or shelves to achieve 69" overall height
- supported by wall cleat - hardware provided by installer
- grain direction runs vertical on flat cut veneer, horizontal on laminate
- spacing of attachment cleats allows wire management

Options:

- must specify grain direction on double cut veneer, see pages 13-15 for details
- tackboard or markerboard available for above the shelf, see pages 360-361


 Workwall Panel with File Shelf	8 1/2	48	23 1/2	38	13	FLT4824WPFF	\$1,188		
	8 1/2	48	23 1/2	38	13	FLV4824WPFF		\$1,741	\$1,916
	8 1/2	42	23 1/2	36	8	FLT4224WPFF	\$1,162		
	8 1/2	42	23 1/2	36	8	FLV4224WPFF		\$1,701	\$1,871
	8 1/2	39	23 1/2	34	7	FLT3924WPFF	\$1,140		
	8 1/2	39	23 1/2	34	7	FLV3924WPFF		\$1,669	\$1,836
	8 1/2	36	23 1/2	31	7	FLT3624WPFF	\$1,117		
	8 1/2	36	23 1/2	31	7	FLV3624WPFF		\$1,634	\$1,799
	8 1/2	33	23 1/2	28	6	FLT3324WPFF	\$1,095		
	8 1/2	33	23 1/2	28	6	FLV3324WPFF		\$1,604	\$1,766
	8 1/2	30	23 1/2	26	6	FLT3024WPFF	\$1,074		
	8 1/2	30	23 1/2	26	6	FLV3024WPFF		\$1,572	\$1,732

Features:

- pair with primary height units and overhead cabinets or shelves to achieve 69" overall height
- supported by wall cleat - hardware provided by installer
- grain direction runs vertical on flat cut veneer, horizontal on laminate
- file brackets for letter hanging file folders
- spacing of attachment cleats allows wire management

Options:

- must specify grain direction on double cut veneer, see pages 13-15 for details
- tackboard or markerboard available for above the shelf, see pages 360-361


 Workwall Panel with File Shelf	8 1/2	24	23 1/2	26	7	FLT2424WPF	\$1,052		
	8 1/2	24	23 1/2	26	7	FLV2424WPF		\$1,543	\$1,696

Features:

- pair with primary height units and overhead cabinets or shelves to achieve 69" overall height
- supported by wall cleat - hardware provided by installer
- grain direction runs vertical on flat cut veneer, horizontal on laminate
- file brackets for letter hanging file folders
- spacing of attachment cleats allows wire management

Options:

- must specify grain direction on double cut veneer, see pages 13-15 for details
- tackboard or markerboard available for above the shelf, see pages 360-361


Description	D	W	H	CTN WT	CU FT	① Model	Laminate	Flat Cut Veneer	Double Cut Veneer
 Workwall Panel with Accessory File Shelf	8 1/2	48	23 1/2	45	13	FLT4824WPCDF	\$1,188		
	8 1/2	48	23 1/2	45	13	FLV4824WPCDF		\$1,741	\$1,916
	8 1/2	42	23 1/2	37	8	FLT4224WPCDF	\$1,162		
	8 1/2	42	23 1/2	37	8	FLV4224WPCDF		\$1,701	\$1,871
	8 1/2	39	23 1/2	35	7	FLT3924WPCDF	\$1,140		
	8 1/2	39	23 1/2	35	7	FLV3924WPCDF		\$1,669	\$1,836
	8 1/2	36	23 1/2	33	7	FLT3624WPCDF	\$1,117		
	8 1/2	36	23 1/2	33	7	FLV3624WPCDF		\$1,634	\$1,799
	8 1/2	33	23 1/2	30	6	FLT3324WPCDF	\$1,095		
	8 1/2	33	23 1/2	30	6	FLV3324WPCDF		\$1,604	\$1,766
	8 1/2	30	23 1/2	27	6	FLT3024WPCDF	\$1,074		
	8 1/2	30	23 1/2	27	6	FLV3024WPCDF		\$1,572	\$1,732

Features:

- pair with primary height units and overhead cabinets or shelves to achieve 69" overall height
- supported by wall cleat - hardware provided by installer
- grain direction runs vertical on flat cut veneer, horizontal on laminate
- file brackets for letter hanging file folders
- includes plastic tool accessories; pencil cup and paper clip dish
- spacing of attachment cleats allows wire management

Options:

- must specify grain direction on double cut veneer, see pages 13-15 for details
- tackboard or markerboard available for above the shelf, see pages 360-361

Description	D	W	H	CTN WT	CU FT	① Model	Laminate	Flat Cut Veneer	Double Cut Veneer
 Workwall Panel with Accessory File Shelf	8 1/2	48	23 1/2	48	13	FLT4824WPFCD	\$1,188		
	8 1/2	48	23 1/2	48	13	FLV4824WPFCD		\$1,741	\$1,916
	8 1/2	42	23 1/2	38	8	FLT4224WPFCD	\$1,162		
	8 1/2	42	23 1/2	38	8	FLV4224WPFCD		\$1,701	\$1,871
	8 1/2	39	23 1/2	36	7	FLT3924WPFCD	\$1,140		
	8 1/2	39	23 1/2	36	7	FLV3924WPFCD		\$1,669	\$1,836
	8 1/2	36	23 1/2	34	7	FLT3624WPFCD	\$1,117		
	8 1/2	36	23 1/2	34	7	FLV3624WPFCD		\$1,634	\$1,799
	8 1/2	33	23 1/2	30	6	FLT3324WPFCD	\$1,095		
	8 1/2	33	23 1/2	30	6	FLV3324WPFCD		\$1,604	\$1,766
	8 1/2	30	23 1/2	28	6	FLT3024WPFCD	\$1,074		
	8 1/2	30	23 1/2	28	6	FLV3024WPFCD		\$1,572	\$1,732

Features:

- pair with primary height units and overhead cabinets or shelves to achieve 69" overall height
- supported by wall cleat - hardware provided by installer
- grain direction runs vertical on flat cut veneer, horizontal on laminate
- file brackets for letter hanging file folders
- includes plastic tool accessories; pencil cup and paper clip dish
- spacing of attachment cleats allows wire management


Options:

- must specify grain direction on double cut veneer, see pages 13-15 for details
- tackboard or markerboard available for above the shelf, see pages 360-361

To Order, Specify:

① Laminate Model #	② Laminate Selection	③ Metal Color	④ Other Product Options
Laminate (FLT)	See Laminate Selection	See Metal Finish Color Options	See list of options for each specific unit; Specify and add accordingly.

① Veneer Model #	② Wood Species	③ Wood Finish - Finishes with an asterisk (*) have a coordinating laminate available	④ Metal Color	⑤ Other Product Options	
Veneer (FLV)	Flat Cut CH1 Cherry MA1 Maple WA1 Walnut B01 Black Oak	See Flat Cut Wood Finish Options	See Metal Finish Color Options	See list of options for each specific unit; Specify and add accordingly.	
	Double Cut DC1 Double Cut	<table border="1"> <thead> <tr> <th>③a Wood Finish</th> <th>③b Chassis Grain Direction</th> </tr> </thead> <tbody> <tr> <td>See Double Cut Wood Finish Options</td> <td>For Double Cut Only: Vertical Horizontal</td> </tr> </tbody> </table>			③a Wood Finish
③a Wood Finish	③b Chassis Grain Direction				
See Double Cut Wood Finish Options	For Double Cut Only: Vertical Horizontal				

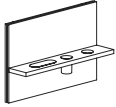
Description	D	W	H	CTN WT	CU FT	① Model	Laminate	Flat Cut Veneer	Double Cut Veneer
Workwall Panel with Accessory Shelf 	8 ½	48	23 ½	47	13	FLT4824WPCDT	\$1,188		
	8 ½	48	23 ½	47	13	FLV4824WPCDT		\$1,741	\$1,916
	8 ½	42	23 ½	38	8	FLT4224WPCDT	\$1,162		
	8 ½	42	23 ½	38	8	FLV4224WPCDT		\$1,701	\$1,871
	8 ½	39	23 ½	36	7	FLT3924WPCDT	\$1,140		
	8 ½	39	23 ½	36	7	FLV3924WPCDT		\$1,669	\$1,836
	8 ½	36	23 ½	34	7	FLT3624WPCDT	\$1,117		
	8 ½	36	23 ½	34	7	FLV3624WPCDT		\$1,634	\$1,799
	8 ½	33	23 ½	30	6	FLT3324WPCDT	\$1,095		
	8 ½	33	23 ½	30	6	FLV3324WPCDT		\$1,604	\$1,766
	8 ½	30	23 ½	28	6	FLT3024WPCDT	\$1,074		
	8 ½	30	23 ½	28	6	FLV3024WPCDT		\$1,572	\$1,732
	8 ½	24	23 ½	27	7	FLT2424WPCDT	\$1,055		
	8 ½	24	23 ½	27	7	FLV2424WPCDT		\$1,543	\$1,696

Features:

- pair with primary height units and overhead cabinets or shelves to achieve 69" overall height
- supported by wall cleat - hardware provided by installer
- grain direction runs vertical on flat cut veneer, horizontal on laminate
- file brackets for letter hanging file folders
- includes plastic tool accessories; pencil cup, paper clip dish and utility tray

Options:

- spacing of attachment cleats allows wire management
- must specify grain direction on double cut veneer, see pages 13-15 for details

Description	D	W	H	CTN WT	CU FT	① Model	Laminate	Flat Cut Veneer	Double Cut Veneer
Workwall Panel with Accessory Shelf 	8 1/2	48	23 1/2	50	13	FLT4824WPTCD	\$1,188		
	8 1/2	48	23 1/2	50	13	FLV4824WPTCD		\$1,741	\$1,916
	8 1/2	42	23 1/2	38	8	FLT4224WPTCD	\$1,162		
	8 1/2	42	23 1/2	38	8	FLV4224WPTCD		\$1,701	\$1,871
	8 1/2	39	23 1/2	36	7	FLT3924WPTCD	\$1,140		
	8 1/2	39	23 1/2	36	7	FLV3924WPTCD		\$1,669	\$1,836
	8 1/2	36	23 1/2	34	7	FLT3624WPTCD	\$1,117		
	8 1/2	36	23 1/2	34	7	FLV3624WPTCD		\$1,634	\$1,799
	8 1/2	33	23 1/2	30	6	FLT3324WPTCD	\$1,095		
	8 1/2	33	23 1/2	30	6	FLV3324WPTCD		\$1,604	\$1,766
	8 1/2	30	23 1/2	28	6	FLT3024WPTCD	\$1,074		
	8 1/2	30	23 1/2	28	6	FLV3024WPTCD		\$1,572	\$1,732
	8 1/2	24	23 1/2	27	7	FLT2424WPTCD	\$1,055		
	8 1/2	24	23 1/2	27	7	FLV2424WPTCD		\$1,543	\$1,696

Features:

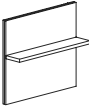
- pair with primary height units and overhead cabinets or shelves to achieve 69" overall height
- supported by wall cleat - hardware provided by installer
- grain direction runs vertical on flat cut veneer, horizontal on laminate
- includes black plastic tool accessories; pencil cup, paper clip dish and utility tray
- spacing of attachment cleats allows wire management

Options:

- must specify grain direction on double cut veneer, see pages 13-15 for details
- tackboard or markerboard available for above the shelf, see pages 360-361

To Order, Specify:

① Laminate Model #		② Laminate Selection		③ Metal Color	④ Other Product Options
Laminate (FLT)		See Laminate Selection		See Metal Finish Color Options	See list of options for each specific unit; Specify and add accordingly.
① Veneer Model #	② Wood Species	③ Wood Finish		④ Metal Color	⑤ Other Product Options
Veneer (FLV)	Flat Cut CH1 Cherry MA1 Maple WA1 Walnut BO1 Black Oak	See Flat Cut Wood Finish Options		See Metal Finish Color Options	See list of options for each specific unit; Specify and add accordingly.
		3a Wood Finish	3b Chassis Grain Direction		
	Double Cut DC1 Double Cut	See Double Cut Wood Finish Options	For Double Cut Only: Vertical Horizontal		

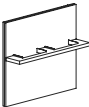
Description	D	W	H	CTN WT	CU FT	① Model	Laminate	Flat Cut Veneer	Double Cut Veneer
 Workwall Panel with Mini Shelf	8 1/2	48	31 1/2	58	17	FLT4832WPMS	\$1,102		
	8 1/2	48	31 1/2	58	17	FLV4832WPMS		\$1,733	\$1,907
	8 1/2	42	31 1/2	44	10	FLT4232WPMS	\$1,075		
	8 1/2	42	31 1/2	44	10	FLV4232WPMS		\$1,692	\$1,860
	8 1/2	39	31 1/2	41	9	FLT3932WPMS	\$1,048		
	8 1/2	39	31 1/2	41	9	FLV3932WPMS		\$1,654	\$1,818
	8 1/2	36	31 1/2	38	9	FLT3632WPMS	\$1,024		
	8 1/2	36	31 1/2	38	9	FLV3632WPMS		\$1,618	\$1,779
	8 1/2	33	31 1/2	35	8	FLT3332WPMS	\$999		
	8 1/2	33	31 1/2	35	8	FLV3332WPMS		\$1,580	\$1,738
	8 1/2	30	31 1/2	32	7	FLT3032WPMS	\$974		
	8 1/2	30	31 1/2	32	7	FLV3032WPMS		\$1,545	\$1,699
	8 1/2	24	31 1/2	34	9	FLT2432WPMS	\$936		
	8 1/2	24	31 1/2	34	9	FLV2432WPMS		\$1,510	\$1,663

Features:

- pair with secondary height units and overhead cabinets or shelves to achieve 69" overall height
- supported by wall cleat - hardware provided by installer
- grain direction runs vertical on flat cut veneer, horizontal on laminate
- spacing of attachment cleats allows wire management

Options:

- must specify grain direction on double cut veneer, see pages 13-15 for details
- tackboard or markerboard available for above the shelf, see pages 360-361

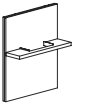
 Workwall Panel with File Shelf	8 1/2	48	31 1/2	51	17	FLT4832WPFF	\$1,322		
	8 1/2	48	31 1/2	51	17	FLV4832WPFF		\$1,949	\$2,144
	8 1/2	42	31 1/2	44	10	FLT4232WPFF	\$1,295		
	8 1/2	42	31 1/2	44	10	FLV4232WPFF		\$1,910	\$2,103
	8 1/2	39	31 1/2	41	9	FLT3932WPFF	\$1,266		
	8 1/2	39	31 1/2	41	9	FLV3932WPFF		\$1,871	\$2,059
	8 1/2	36	31 1/2	38	9	FLT3632WPFF	\$1,241		
	8 1/2	36	31 1/2	38	9	FLV3632WPFF		\$1,833	\$2,017
	8 1/2	33	31 1/2	35	8	FLT3332WPFF	\$1,217		
	8 1/2	33	31 1/2	35	8	FLV3332WPFF		\$1,797	\$1,978
	8 1/2	30	31 1/2	32	7	FLT3032WPFF	\$1,193		
	8 1/2	30	31 1/2	32	7	FLV3032WPFF		\$1,761	\$1,939

Features:

- pair with secondary height units and overhead cabinets or shelves to achieve 69" overall height
- supported by wall cleat - hardware provided by installer
- grain direction runs vertical on flat cut veneer, horizontal on laminate
- file brackets for letter hanging file folders

Options:

- must specify grain direction on double cut veneer, see pages 13-15 for details
- tackboard or markerboard available for above the shelf, see pages 360-361

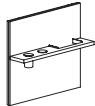
 Workwall Panel with File Shelf	8 1/2	24	31 1/2	31	9	FLT2432WPF	\$1,168		
	8 1/2	24	31 1/2	31	9	FLV2432WPF		\$1,915	\$2,106

Features:

- pair with secondary height units and overhead cabinets or shelves to achieve 69" overall height
- supported by wall cleat - hardware provided by installer
- grain direction runs vertical on flat cut veneer, horizontal on laminate
- file brackets for letter hanging file folders

Options:

- must specify grain direction on double cut veneer, see pages 13-15 for details
- tackboard or markerboard available for above the shelf, see pages 360-361

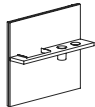
Description	D	W	H	CTN WT	CU FT	① Model	Laminate	Flat Cut Veneer	Double Cut Veneer
Workwall Panel with Accessory File Shelf 	8 1/2	48	31 1/2	55	17	FLT4832WPCDF	\$1,322		
	8 1/2	48	31 1/2	55	17	FLV4832WPCDF		\$1,949	\$2,144
	8 1/2	42	31 1/2	46	10	FLT4232WPCDF	\$1,295		
	8 1/2	42	31 1/2	46	10	FLV4232WPCDF		\$1,910	\$2,103
	8 1/2	39	31 1/2	43	9	FLT3932WPCDF	\$1,266		
	8 1/2	39	31 1/2	43	9	FLV3932WPCDF		\$1,871	\$2,059
	8 1/2	36	31 1/2	40	9	FLT3632WPCDF	\$1,241		
	8 1/2	36	31 1/2	40	9	FLV3632WPCDF		\$1,833	\$2,017
	8 1/2	33	31 1/2	36	8	FLT3332WPCDF	\$1,217		
	8 1/2	33	31 1/2	36	8	FLV3332WPCDF		\$1,797	\$1,978
	8 1/2	30	31 1/2	33	7	FLT3032WPCDF	\$1,193		
	8 1/2	30	31 1/2	33	7	FLV3032WPCDF		\$1,761	\$1,939

Features:

- pair with secondary height units and overhead cabinets or shelves to achieve 69" overall height
- supported by wall cleat - hardware provided by installer
- grain direction runs vertical on flat cut veneer, horizontal on laminate
- file brackets for letter hanging file folders
- includes plastic tool accessories; pencil cup and paper clip dish
- spacing of attachment cleats allows wire management

Options:

- must specify grain direction on double cut veneer, see pages 13-15 for details
- tackboard or markerboard available for above the shelf, see pages 360-361

Description	D	W	H	CTN WT	CU FT	① Model	Laminate	Flat Cut Veneer	Double Cut Veneer
Workwall Panel with Accessory File Shelf 	8 1/2	48	31 1/2	58	17	FLT4832WPFC	\$1,322		
	8 1/2	48	31 1/2	58	17	FLV4832WPFC		\$1,949	\$2,144
	8 1/2	42	31 1/2	46	10	FLT4232WPFC	\$1,295		
	8 1/2	42	31 1/2	46	10	FLV4232WPFC		\$1,910	\$2,103
	8 1/2	39	31 1/2	43	9	FLT3932WPFC	\$1,266		
	8 1/2	39	31 1/2	43	9	FLV3932WPFC		\$1,871	\$2,059
	8 1/2	36	31 1/2	40	9	FLT3632WPFC	\$1,241		
	8 1/2	36	31 1/2	40	9	FLV3632WPFC		\$1,833	\$2,017
	8 1/2	33	31 1/2	36	8	FLT3332WPFC	\$1,217		
	8 1/2	33	31 1/2	36	8	FLV3332WPFC		\$1,797	\$1,978
	8 1/2	33	31 1/2	33	7	FLT3032WPFC	\$1,193		
	8 1/2	33	31 1/2	33	7	FLV3032WPFC		\$1,761	\$1,939

Features:

- pair with secondary height units and overhead cabinets or shelves to achieve 69" overall height
- supported by wall cleat - hardware provided by installer
- grain direction runs vertical on flat cut veneer, horizontal on laminate
- file brackets for letter hanging file folders
- includes plastic tool accessories; pencil cup and paper clip dish
- spacing of attachment cleats allows wire management

Options:

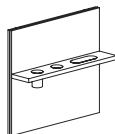
- must specify grain direction on double cut veneer, see pages 13-15 for details

To Order, Specify:

① Laminate Model #	② Laminate Selection	③ Metal Color	④ Other Product Options
Laminate (FLT)	See Laminate Selection	See Metal Finish Color Options	See list of options for each specific unit; Specify and add accordingly.

① Veneer Model #	② Wood Species	③ Wood Finish	④ Metal Color	⑤ Other Product Options
Veneer (FLV)	Flat Cut CH1 Cherry MA1 Maple WA1 Walnut BO1 Black Oak	See Flat Cut Wood Finish Options	See Metal Finish Color Options	See list of options for each specific unit; Specify and add accordingly.
		<table border="1"> <thead> <tr> <th>③a Wood Finish</th> <th>③b Chassis Grain Direction</th> </tr> </thead> <tbody> <tr> <td>See Double Cut Wood Finish Options</td> <td>For Double Cut Only: Vertical Horizontal</td> </tr> </tbody> </table>		
③a Wood Finish	③b Chassis Grain Direction			
See Double Cut Wood Finish Options	For Double Cut Only: Vertical Horizontal			

Description	D	W	H	CTN WT	CU FT	① Model	Laminate	Flat Cut Veneer	Double Cut Veneer
Workwall Panel with Accessory Shelf	8 ½	48	31 ½	56	17	FLT4832WPCDT	\$1,322		
	8 ½	48	31 ½	56	17	FLV4832WPCDT		\$1,949	\$2,144
	8 ½	42	31 ½	47	10	FLT4232WPCDT	\$1,295		
	8 ½	42	31 ½	47	10	FLV4232WPCDT		\$1,910	\$2,103
	8 ½	39	31 ½	44	9	FLT3932WPCDT	\$1,266		
	8 ½	39	31 ½	44	9	FLV3932WPCDT		\$1,871	\$2,059
	8 ½	36	31 ½	41	9	FLT3632WPCDT	\$1,241		
	8 ½	36	31 ½	41	9	FLV3632WPCDT		\$1,833	\$2,017
	8 ½	33	31 ½	37	8	FLT3332WPCDT	\$1,217		
	8 ½	33	31 ½	37	8	FLV3332WPCDT		\$1,797	\$1,978
	8 ½	30	31 ½	34	7	FLT3032WPCDT	\$1,193		
	8 ½	30	31 ½	34	7	FLV3032WPCDT		\$1,761	\$1,939
	8 ½	24	31 ½	31	9	FLT2432WPCDT	\$1,168		
	8 ½	24	31 ½	31	9	FLV2432WPCDT		\$1,915	\$2,106

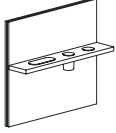


Features:

- pair with secondary height units and overhead cabinets or shelves to achieve 69" overall height
- supported by wall cleat - hardware provided by installer
- grain direction runs vertical on flat cut veneer, horizontal on laminate
- includes plastic tool accessories; pencil cup, paper clip dish and utility tray
- spacing of attachment cleats allows wire management

Options:

- must specify grain direction on double cut veneer, see pages 13-15 for details
- tackboard or markerboard available for above the shelf, see pages 360-361

Description	D	W	H	CTN WT	CU FT	① Model	Laminate	Flat Cut Veneer	Double Cut Veneer
 Workwall Panel with Accessory Shelf	8 1/2	48	31 1/2	59	17	FLT4832WPTCD	\$1,322		
	8 1/2	48	31 1/2	59	17	FLV4832WPTCD		\$1,949	\$2,144
	8 1/2	42	31 1/2	47	10	FLT4232WPTCD	\$1,295		
	8 1/2	42	31 1/2	47	10	FLV4232WPTCD		\$1,910	\$2,103
	8 1/2	39	31 1/2	44	9	FLT3932WPTCD	\$1,266		
	8 1/2	39	31 1/2	44	9	FLV3932WPTCD		\$1,871	\$2,059
	8 1/2	36	31 1/2	41	9	FLT3632WPTCD	\$1,241		
	8 1/2	36	31 1/2	41	9	FLV3632WPTCD		\$1,833	\$2,017
	8 1/2	33	31 1/2	37	8	FLT3332WPTCD	\$1,217		
	8 1/2	33	31 1/2	37	8	FLV3332WPTCD		\$1,797	\$1,978
	8 1/2	30	31 1/2	34	7	FLT3032WPTCD	\$1,193		
	8 1/2	30	31 1/2	34	7	FLV3032WPTCD		\$1,761	\$1,939
	8 1/2	24	31 1/2	34	9	FLT2432WPTCD	\$1,168		
	8 1/2	24	31 1/2	34	9	FLV2432WPTCD		\$1,915	\$2,106

Features:

- pair with secondary height units and overhead cabinets or shelves to achieve 69" overall height
- supported by wall cleat - hardware provided by installer
- grain direction runs vertical on flat cut veneer, horizontal on laminate
- includes black plastic tool accessories; pencil cup, paper clip dish and utility tray
- spacing of attachment cleats allows wire management

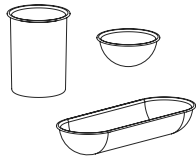
Options:

- must specify grain direction on double cut veneer, see pages 13-15 for details
- tackboard or markerboard available for above the shelf, see pages 360-361

Description	D	W	H	CTN WT	CU FT	① Model	List Price
Work Tool Set	3	2	6	2	1	FLBWTOOLS	\$68

Features:

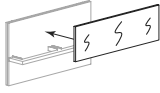
- work tool accessory set - utility cup, dish, and tray
- black plastic



To Order, Specify:

① Laminate Model #		② Laminate Selection		③ Metal Color	④ Other Product Options
Laminate (FLT)		See Laminate Selection		See Metal Finish Color Options	See list of options for each specific unit; Specify and add accordingly.
① Veneer Model #	② Wood Species	③ Wood Finish		④ Metal Color	⑤ Other Product Options
Veneer (FLV)	Flat Cut CH1 Cherry MA1 Maple WA1 Walnut BO1 Black Oak	See Flat Cut Wood Finish Options		See Metal Finish Color Options	See list of options for each specific unit; Specify and add accordingly.
		③a Wood Finish	③b Chassis Grain Direction		
	Double Cut DC1 Double Cut	See Double Cut Wood Finish Options	For Double Cut Only: Vertical Horizontal		

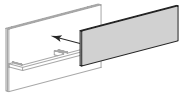
Description	D	W	H	CTN WT	CU FT	① Model	List Price
Workwall Panels	¾	48	12 ½			FLB4813MBA	\$341
Markerboard Add	1 ⅙	42	12 ⅙	15	2	FLB4213MBA	\$312
	1 ⅙	39	12 ⅙	14	2	FLB3913MBA	\$283
	1 ⅙	36	12 ⅙	13	1	FLB3613MBA	\$259
	1 ⅙	33	12 ⅙	12	1	FLB3313MBA	\$235
	1 ⅙	30	12 ⅙	11	1	FLB3013MBA	\$214
	¾	24	12 ½			FLB2413MBA	\$194



Features:

- mounts with magnets above the shelf - template included
- standard markerboard laminate with aluminum pvc edge

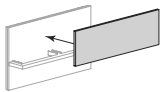
Description	D	W	H	CTN WT	CU FT	① Model	List Price Per Grade
48" w Insert Tackboard	¾	48	12 ½	5	2	FLB4813WTK	COM \$369
							A \$391
							B \$431
							C \$503
							D \$598
							E \$689
							F \$835
							G \$990
							H \$1,155
							I \$1,412
							J \$1,721



Features:

- attaches to cabinet interior, mounting hardware included
- com ydg: 1 ¾

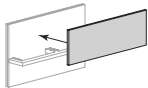
42" w Insert Tackboard	1 ⅙	42	12 ⅙	4	2	FLB4213WTK	COM \$368
							A \$389
							B \$424
							C \$488
							D \$571
							E \$653
							F \$782
							G \$919
							H \$1,064
							I \$1,295
							J \$1,567



Features:

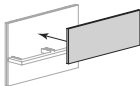
- attaches to cabinet interior, mounting hardware included
- com ydg: 1 ½

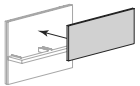
39" w Insert Tackboard	1 ⅙	39	12 ⅙	4	2	FLB3913WTK	COM \$358
							A \$375
							B \$405
							C \$459
							D \$527
							E \$596
							F \$703
							G \$816
							H \$937
							I \$1,129
							J \$1,360

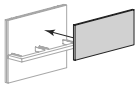


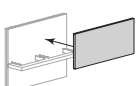
Features:

- attaches to cabinet interior, mounting hardware included
- com ydg: 1 ¼

Description	D	W	H	CTN WT	CU FT	① Model	List Price Per Grade
36" w Insert Tackboard	1 9/16	36	12 11/16	4	2	FLB3613WTK	COM \$349
 <p>Features:</p> <ul style="list-style-type: none"> attaches to cabinet interior, mounting hardware included com ydg: 1 1/4 							A \$364
							B \$396
							C \$449
							D \$519
							E \$587
							F \$691
							G \$807
							H \$929
							I \$1,120
							J \$1,348

33" w Insert Tackboard	1 9/16	33	12 11/16	3	2	FLB3313WTK	COM \$340
 <p>Features:</p> <ul style="list-style-type: none"> attaches to cabinet interior, mounting hardware included com ydg: 1 1/4 							A \$356
							B \$387
							C \$439
							D \$509
							E \$578
							F \$683
							G \$799
							H \$921
							I \$1,111
							J \$1,340

30" w Insert Tackboard	1 9/16	30	12 11/16	3	2	FLB3013WTK	COM \$333
 <p>Features:</p> <ul style="list-style-type: none"> attaches to cabinet interior, mounting hardware included com ydg: 1 							A \$345
							B \$366
							C \$410
							D \$466
							E \$521
							F \$606
							G \$697
							H \$795
							I \$948
							J \$1,130

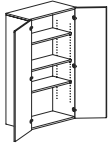
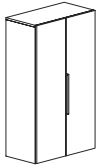
24" w Insert Tackboard	3/4	24	12 1/2	2	2	FLB2413WTK	COM \$310
 <p>Features:</p> <ul style="list-style-type: none"> attaches to cabinet interior, mounting hardware included com ydg: 1 							A \$323
							B \$346
							C \$388
							D \$441
							E \$494
							F \$577
							G \$666
							H \$758
							I \$907
							J \$1,083

To Order, Specify:

① Model Number	② Fabric Selection
(FLB)	Vendor Pattern Color

FLUX - PRIVATE OFFICE

Description	D	W	H	CTN WT	CU FT	① Model	Laminate	Flat Cut Veneer	Double Cut Veneer
52" h Two Door Storage Tower	15 ⁷ / ₈	35 ⁷ / ₈	52	183	22	FLT1636-52STD	\$1,939		
	15 ⁷ / ₈	35 ⁷ / ₈	52	183	22	FLV1636-52STD		\$2,981	\$3,278
	15 ⁷ / ₈	29 ⁷ / ₈	52	169	19	FLT1630-52STD	\$1,604		
	15 ⁷ / ₈	29 ⁷ / ₈	52	169	19	FLV1630-52STD		\$2,466	\$2,714



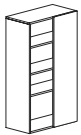
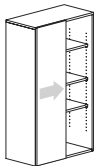
Features:

- use with primary height units, fastening hardware included
- laminate grain direction runs vertical on back panel of storage towers
- four adjustable shelves

Options:

- must specify chassis grain direction on double cut veneer, see pages 13-15 for details
- veneer door fronts in paint available, specify paint color and add \$337 list; see page 16 for details
- on laminate units, contrasting laminate door fronts available, no upcharge; specify laminate color, see page 16 for details
- white glass doors with aluminum trim available, specify and add \$2,548 list for 36" w, \$2,212 list for 30" w; see page 33 for details
- markerboard laminate doors available, specify and add \$442 list; see page 33 for details
- ledge pull standard on the right hinge door, prism pull available, specify and see page 9
- locking doors available, specify and add \$142 list (not available on glass doors)

52" h Sliding Door Storage Tower	15 ¹⁵ / ₁₆	35 ⁷ / ₈	52	182	22	FLT1636-52STSD	\$2,171		
	15 ¹⁵ / ₁₆	35 ⁷ / ₈	52	182	22	FLV1636-52STSD		\$3,338	\$3,671
	15 ¹⁵ / ₁₆	29 ⁷ / ₈	52	167	18	FLT1630-52STSD	\$1,797		
	15 ¹⁵ / ₁₆	29 ⁷ / ₈	52	167	18	FLV1630-52STSD		\$2,761	\$3,039



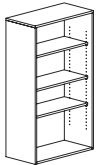
Features:

- use with primary height units, fastening hardware included
- laminate grain direction runs vertical on back panel of storage towers
- four adjustable shelves
- locking not available

Options:

- must specify chassis grain direction on double cut veneer, see pages 13-15 for details
- veneer door fronts in paint available, specify paint color and add \$337 list; see page 16 for details
- on laminate units, contrasting laminate door fronts available, no upcharge; specify laminate color, see page 16 for details
- white glass doors with aluminum trim available, specify and add \$1,318 list for 36" w, \$1,148 list for 30" w; see page 33 for details
- markerboard laminate doors available, specify and add \$286 list; see page 33 for details

52" h Open Storage Tower	15	35 ⁷ / ₈	52	136	21	FLT1536-52STO	\$1,320		
	15	35 ⁷ / ₈	52	136	21	FLV1536-52STO		\$2,026	\$2,231
	15	29 ⁷ / ₈	52	123	18	FLT1530-52STO	\$1,202		
	15	29 ⁷ / ₈	52	123	18	FLV1530-52STO		\$1,849	\$2,034



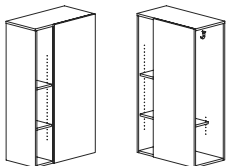
Features:

- use with primary height units, fastening hardware included
- laminate grain direction runs vertical on back panel of storage towers
- four adjustable shelves

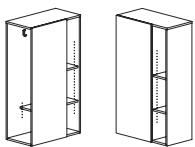
Options:

- must specify chassis grain direction on double cut veneer, see pages 13-15 for details

52" h Side Wardrobe with Open Shelf	15 ¹⁵ / ₁₆	35 ⁷ / ₈	52	138	22	FLT1636-52STSWR	\$1,497		
	15 ¹⁵ / ₁₆	35 ⁷ / ₈	52	138	22	FLV1636-52STSWR		\$2,304	\$2,532
	15 ¹⁵ / ₁₆	35 ⁷ / ₈	52	137	22	FLT1636-52STSWL	\$1,497		
	15 ¹⁵ / ₁₆	35 ⁷ / ₈	52	137	22	FLV1636-52STSWL		\$2,304	\$2,532
	15 ¹⁵ / ₁₆	29 ⁷ / ₈	52	130	18	FLT1630-52STSWR	\$1,434		
	15 ¹⁵ / ₁₆	29 ⁷ / ₈	52	130	18	FLV1630-52STSWR		\$2,203	\$2,426
	15 ¹⁵ / ₁₆	29 ⁷ / ₈	52	129	18	FLT1630-52STSWL	\$1,434		
	15 ¹⁵ / ₁₆	29 ⁷ / ₈	52	129	18	FLV1630-52STSWL		\$2,203	\$2,426



right shown



left

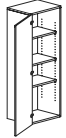
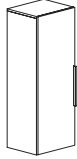
Features:

- use with primary height units, fastening hardware included
- side entry wardrobe with two coat hooks
- 8¹/₄" w open compartment with three adjustable shelves

Options:

- must specify chassis grain direction on double cut veneer, see pages 13-15 for details

Description	D	W	H	CTN WT	CU FT	① Model	Laminate	Flat Cut Veneer	Double Cut Veneer
52" h Storage Tower	15 7/8	17 7/8	52	126	12	FLT1618-52STDR	\$1,264		
	15 7/8	17 7/8	52	126	12	FLV1618-52STDR		\$1,943	\$2,139
	15 7/8	17 7/8	52	126	12	FLT1618-52STD	\$1,264		
	15 7/8	17 7/8	52	126	12	FLV1618-52STD		\$1,943	\$2,139



left shown

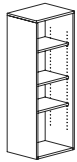
Features:

- use with primary height units, fastening hardware included
- laminate grain direction runs vertical on back panel of storage towers
- four adjustable shelves

Options:

- must specify chassis grain direction on double cut veneer, see pages 13-15 for details
- veneer door fronts in paint available, specify paint color and add \$337 list; see page 16 for details
- on laminate units, contrasting laminate door fronts available, no upcharge; specify laminate color, see page 16 for details
- white glass doors with aluminum trim available, specify and add \$1,276 list; see page 33 for details
- markerboard laminate doors available, specify and add \$286 list; see page 33 for details
- ledge pulls standard; prism pulls available, specify and see page 9
- locking door available, specify and add \$142 list (not available on glass door)

52" h Open Storage Tower	15	17 7/8	52	108	11	FLT1518-52STO	\$1,202		
	15	17 7/8	52	108	11	FLV1518-52STO		\$1,849	\$2,034



Features:

- use with primary height units, fastening hardware included
- laminate grain direction runs vertical on back panel of storage towers
- three adjustable shelves

Options:

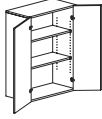
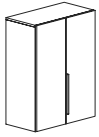
- must specify chassis grain direction on double cut veneer, see pages 13-15 for details

To Order, Specify:

① Laminate Model #	② Laminate Selection	③ Metal Color	④ Other Product Options
Laminate (FLT)	See Laminate Selection	See Metal Finish Color Options	See list of options for each specific unit; Specify and add accordingly.

① Veneer Model #	② Wood Species	③ Wood Finish	④ Metal Color	⑤ Other Product Options
Veneer (FLV)	Flat Cut CH1 Cherry MA1 Maple WA1 Walnut BO1 Black Oak	See Flat Cut Wood Finish Options	See Metal Finish Color Options	See list of options for each specific unit; Specify and add accordingly.
		<table border="1"> <thead> <tr> <th>③a Wood Finish</th> <th>③b Chassis Grain Direction</th> </tr> </thead> <tbody> <tr> <td>See Double Cut Wood Finish Options</td> <td>For Double Cut Only: Vertical Horizontal</td> </tr> </tbody> </table>		
③a Wood Finish	③b Chassis Grain Direction			
See Double Cut Wood Finish Options	For Double Cut Only: Vertical Horizontal			

Description	D	W	H	CTN WT	CU FT	① Model	Laminate	Flat Cut Veneer	Double Cut Veneer
40" h Two Door Storage Tower	15 $\frac{1}{8}$ "	35 $\frac{7}{8}$ "	40	130	17	FLT1636-40STD	\$1,565		
	15 $\frac{1}{8}$ "	35 $\frac{7}{8}$ "	40	130	17	FLV1636-40STD		\$2,406	\$2,647
	15 $\frac{1}{8}$ "	29 $\frac{7}{8}$ "	40	115	14	FLT1630-40STD	\$1,296		
	15 $\frac{1}{8}$ "	29 $\frac{7}{8}$ "	40	115	14	FLV1630-40STD		\$1,992	\$2,190



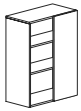
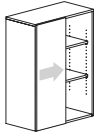
Features:

- use with primary height units, fastening hardware included
- laminate grain direction runs vertical on back panel of storage towers
- two adjustable shelves

Options:

- must specify chassis grain direction on double cut veneer, see pages 13-15 for details
- veneer door fronts in paint available, specify paint color and add \$337 list; see page 16 for details
- on laminate units, contrasting laminate door fronts available, no upcharge; specify laminate color, see page 16 for details
- white glass doors with aluminum trim available, specify and add \$2,034 list for 36" w, \$1,775 list for 30" w; see page 33 for details
- markerboard laminate doors available, specify and add \$442 list; see page 33 for details
- ledge pull standard on the right hinge door, prism pull available, specify and see page 9
- locking doors available, specify and add \$142 list (not available on glass doors)

40" h Sliding Door Storage Tower	15 $\frac{1}{8}$ "	35 $\frac{7}{8}$ "	40	129	17	FLT1636-40STSD	\$1,752		
	15 $\frac{1}{8}$ "	35 $\frac{7}{8}$ "	40	129	17	FLV1636-40STSD		\$2,694	\$2,965
	15 $\frac{1}{8}$ "	29 $\frac{7}{8}$ "	40	115	14	FLT1630-40STSD	\$1,451		
	15 $\frac{1}{8}$ "	29 $\frac{7}{8}$ "	40	115	14	FLV1630-40STSD		\$2,231	\$2,453



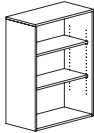
Features:

- use with primary height units, fastening hardware included
- laminate grain direction runs vertical on back panel of storage towers
- two adjustable shelves
- locking not available

Options:

- must specify chassis grain direction on double cut veneer, see pages 13-15 for details
- veneer door fronts in paint available, specify paint color and add \$337 list; see page 16 for details
- on laminate units, contrasting laminate door fronts available, no upcharge; specify laminate color, see page 16 for details
- white glass doors with aluminum trim available, specify and add \$1,081 list for 36" w, \$966 list for 30" w; see page 33 for details
- markerboard laminate doors available, specify and add \$286 list; see page 33 for details

40" h Open Storage Tower	15	35 $\frac{7}{8}$ "	40	103	16	FLT1536-40STO	\$1,064		
	15	35 $\frac{7}{8}$ "	40	103	16	FLV1536-40STO		\$1,636	\$1,802
	15	29 $\frac{7}{8}$ "	40	95	14	FLT1530-40STO	\$971		
	15	29 $\frac{7}{8}$ "	40	95	14	FLV1530-40STO		\$1,493	\$1,642



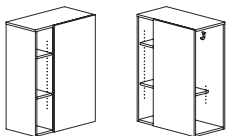
Features:

- use with primary height units, fastening hardware included
- laminate grain direction runs vertical on back panel of storage towers
- two adjustable shelves

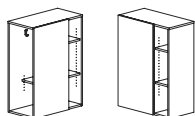
Options:

- must specify chassis grain direction on double cut veneer, see pages 13-15 for details

40" h Side Wardrobe with Open Shelf	15 $\frac{1}{8}$ "	35 $\frac{7}{8}$ "	40	115	17	FLT1636-40STSWR	\$1,440		
	15 $\frac{1}{8}$ "	35 $\frac{7}{8}$ "	40	115	17	FLV1636-40STSWR		\$2,212	\$2,434
	15 $\frac{1}{8}$ "	35 $\frac{7}{8}$ "	40	115	17	FLT1636-40STSWL	\$1,440		
	15 $\frac{1}{8}$ "	35 $\frac{7}{8}$ "	40	115	17	FLV1636-40STSWL		\$2,212	\$2,434
	15 $\frac{1}{8}$ "	29 $\frac{7}{8}$ "	40	109	14	FLT1630-40STSWR	\$1,378		
	15 $\frac{1}{8}$ "	29 $\frac{7}{8}$ "	40	109	14	FLV1630-40STSWR		\$2,116	\$2,329
	15 $\frac{1}{8}$ "	29 $\frac{7}{8}$ "	40	109	14	FLT1630-40STSWL	\$1,378		
	15 $\frac{1}{8}$ "	29 $\frac{7}{8}$ "	40	109	14	FLV1630-40STSWL		\$2,116	\$2,329



right shown



left

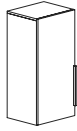
Features:

- use with primary height units, fastening hardware included
- side entry wardrobe with two coat hooks
- 8 $\frac{1}{4}$ " w open compartment with two adjustable shelves

Options:

- must specify chassis grain direction on double cut veneer, see pages 13-15 for details

Description	D	W	H	CTN WT	CU FT	① Model	Laminate	Flat Cut Veneer	Double Cut Veneer
40" h Storage Tower	15 $\frac{7}{8}$	17 $\frac{7}{8}$	40	91	9	FLT1618-40STDR	\$1,021		
	15 $\frac{7}{8}$	17 $\frac{7}{8}$	40	91	9	FLV1618-40STDR		\$1,569	\$1,730
	15 $\frac{7}{8}$	17 $\frac{7}{8}$	40	91	10	FLT1618-40STDL	\$1,021		
	15 $\frac{7}{8}$	17 $\frac{7}{8}$	40	91	10	FLV1618-40STDL		\$1,569	\$1,730



left shown

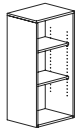
Features:

- use with primary height units, fastening hardware included
- laminate grain direction runs vertical on back panel of storage towers
- two adjustable shelves

Options:

- must specify chassis grain direction on double cut veneer, see pages 13-15 for details
- veneer door fronts in paint available, specify paint color and add \$337 list; see page 16 for details
- on laminate units, contrasting laminate door fronts available, no upcharge; specify laminate color, see page 16 for details
- white glass doors with aluminum trim available, specify and add \$1,019 list; see page 33 for details
- markerboard laminate doors available, specify and add \$286 list; see page 33 for details
- ledge pulls standard; prism pulls available, specify and see page 9
- locking door available, specify and add \$142 list (not available on glass door)

40" h Open Storage Tower	15	17 $\frac{7}{8}$	40	83	9	FLT1518-40STO	\$971		
	15	17 $\frac{7}{8}$	40	83	9	FLV1518-40STO		\$1,493	\$1,642



Features:

- use with primary height units, fastening hardware included
- laminate grain direction runs vertical on back panel of storage towers
- two adjustable shelves

Options:

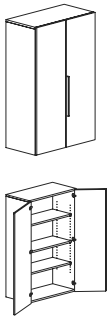
- must specify chassis grain direction on double cut veneer, see pages 13-15 for details

To Order, Specify:

① Laminate Model #	② Laminate Selection	③ Metal Color	④ Other Product Options
Laminate (FLT)	See Laminate Selection	See Metal Finish Color Options	See list of options for each specific unit; Specify and add accordingly.

① Veneer Model #	② Wood Species	③ Wood Finish	④ Metal Color	⑤ Other Product Options
Veneer (FLV)	Flat Cut CH1 Cherry MA1 Maple WA1 Walnut BO1 Black Oak	See Flat Cut Wood Finish Options	See Metal Finish Color Options	See list of options for each specific unit; Specify and add accordingly.
		<table border="1"> <thead> <tr> <th>③a Wood Finish</th> <th>③b Chassis Grain Direction</th> </tr> </thead> <tbody> <tr> <td>See Double Cut Wood Finish Options</td> <td>For Double Cut Only: Vertical Horizontal</td> </tr> </tbody> </table>		
③a Wood Finish	③b Chassis Grain Direction			
See Double Cut Wood Finish Options	For Double Cut Only: Vertical Horizontal			

Description	D	W	H	CTN WT	CU FT	① Model	Laminate	Flat Cut Veneer	Double Cut Veneer
48" h Two Door Storage Tower	15 ⁷ / ₈	35 ⁷ / ₈	48	151	20	FLT1636-48STD	\$1,848		
	15 ⁷ / ₈	35 ⁷ / ₈	48	151	20	FLV1636-48STD		\$2,838	\$3,124
	15 ⁷ / ₈	29 ⁷ / ₈	48	137	17	FLT1630-48STD	\$1,528		
	15 ⁷ / ₈	29 ⁷ / ₈	48	137	17	FLV1630-48STD		\$2,350	\$2,582



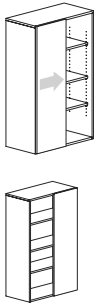
Features:

- use with secondary height units, fastening hardware included
- laminate grain direction runs vertical on back panel of storage towers
- three adjustable shelves

Options:

- must specify chassis grain direction on double cut veneer, see pages 13-15 for details
- veneer door fronts in paint available, specify paint color and add \$337 list; see page 16 for details
- on laminate units, contrasting laminate door fronts available, no upcharge; specify laminate color, see page 16 for details
- white glass doors with aluminum trim available, specify and add \$2,395 list for 36" w, \$2,086 list for 30" w; see page 33 for details
- markerboard laminate doors available, specify and add \$442 list; see page 33 for details
- ledge pull standard on the right hinge door, prism pull available, specify and see page 9
- locking doors available, specify and add \$142 list (not available on glass doors)

48" h Sliding Door Storage Tower	15 ¹⁵ / ₁₆	35 ⁷ / ₈	48	150	20	FLT1636-48STSD	\$2,068		
	15 ¹⁵ / ₁₆	35 ⁷ / ₈	48	150	20	FLV1636-48STSD		\$3,180	\$3,499
	15 ¹⁵ / ₁₆	29 ⁷ / ₈	48	136	17	FLT1630-48STSD	\$1,711		
	15 ¹⁵ / ₁₆	29 ⁷ / ₈	48	136	17	FLV1630-48STSD		\$2,632	\$2,894



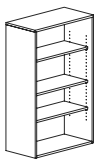
Features:

- use with secondary height units, fastening hardware included
- laminate grain direction runs vertical on back panel of storage towers
- three adjustable shelves
- locking not available

Options:

- must specify chassis grain direction on double cut veneer, see pages 13-15 for details
- veneer door fronts in paint available, specify paint color and add \$337 list; see page 16 for details
- on laminate units, contrasting laminate door fronts available, no upcharge; specify laminate color, see page 16 for details
- white glass doors with aluminum trim available, specify and add \$1,239 list for 36" w, \$1,084 list for 30" w; see page 33 for details
- markerboard laminate doors available, specify and add \$286 list; see page 33 for details

48" h Open Storage Tower	15	35 ⁷ / ₈	48	114	19	FLT1536-48STO	\$1,256		
	15	35 ⁷ / ₈	48	114	19	FLV1536-48STO		\$1,931	\$2,125
	15	29 ⁷ / ₈	48	104	16	FLT1530-48STO	\$1,146		
	15	29 ⁷ / ₈	48	104	16	FLV1530-48STO		\$1,760	\$1,938



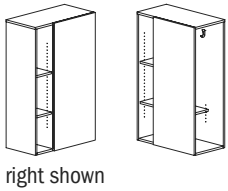
Features:

- use with secondary height units, fastening hardware included
- laminate grain direction runs vertical on back panel of storage towers
- three adjustable shelves

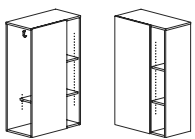
Options:

- must specify chassis grain direction on double cut veneer, see pages 13-15 for details

48" h Side Wardrobe with Open Shelf	15 ¹³ / ₁₆	35 ⁷ / ₈	48	121	20	FLT1636-48STSWR	\$1,470		
	15 ¹³ / ₁₆	35 ⁷ / ₈	48	121	20	FLV1636-48STSWR		\$2,258	\$2,482
	15 ¹³ / ₁₆	35 ⁷ / ₈	48	121	20	FLT1636-48STSWL	\$1,470		
	15 ¹³ / ₁₆	35 ⁷ / ₈	48	121	20	FLV1636-48STSWL		\$2,258	\$2,482
	15 ¹³ / ₁₆	29 ⁷ / ₈	48	114	17	FLT1630-48STSWR	\$1,406		
	15 ¹³ / ₁₆	29 ⁷ / ₈	48	114	17	FLV1630-48STSWR		\$2,160	\$2,376
	15 ¹³ / ₁₆	29 ⁷ / ₈	48	114	17	FLT1630-48STSWL	\$1,406		
	15 ¹³ / ₁₆	29 ⁷ / ₈	48	114	17	FLV1630-48STSWL		\$2,160	\$2,376



right shown



left

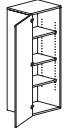
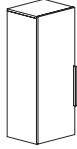
Features:

- use with secondary height units, fastening hardware included
- side entry wardrobe with two coat hooks
- 8³/₄" w open compartment with three adjustable shelves

Options:

- must specify chassis grain direction on double cut veneer, see pages 13-15 for details

Description	D	W	H	CTN WT	CU FT	① Model	Laminate	Flat Cut Veneer	Double Cut Veneer
48" h Storage Tower	15 7/8	17 7/8	48	105	11	FLT1618-48STDR	\$1,205		
	15 7/8	17 7/8	48	105	11	FLV1618-48STDR		\$1,852	\$2,039
	15 7/8	17 7/8	48	105	11	FLT1618-48STD L	\$1,205		
	15 7/8	17 7/8	48	105	11	FLV1618-48STD L		\$1,852	\$2,039



left shown

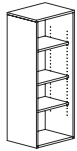
Features:

- use with secondary height units, fastening hardware included
- laminate grain direction runs vertical on back panel of storage towers
- three adjustable shelves

Options:

- must specify chassis grain direction on double cut veneer, see pages 13-15 for details
- veneer door fronts in paint available, specify paint color and add \$337 list; see page 16 for details
- on laminate units, contrasting laminate door fronts available, no upcharge; specify laminate color, see page 16 for details
- white glass doors with aluminum trim available, specify and add \$1,198 list; see page 33 for details
- markerboard laminate doors available, specify and add \$286 list; see page 33 for details
- ledge pulls standard; prism pulls available, specify and see page 9
- locking door available, specify and add \$142 list (not available on glass door)

48" h Open Storage Tower	15	17 7/8	48	92	10	FLT1518-48STO	\$1,146		
	15	17 7/8	48	92	10	FLV1518-48STO		\$1,760	\$1,938



Features:

- use with secondary height units, fastening hardware included
- laminate grain direction runs vertical on back panel of storage towers
- three adjustable shelves

Options:

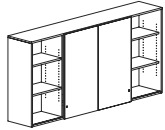
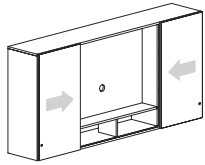
- must specify chassis grain direction on double cut veneer, see pages 13-15 for details

To Order, Specify:

① Laminate Model #	② Laminate Selection	③ Metal Color	④ Other Product Options
Laminate (FLT)	See Laminate Selection	See Metal Finish Color Options	See list of options for each specific unit; Specify and add accordingly.

① Veneer Model #	② Wood Species	③ Wood Finish	④ Metal Color	⑤ Other Product Options
Veneer (FLV)	Flat Cut CH1 Cherry MA1 Maple WA1 Walnut BO1 Black Oak	See Flat Cut Wood Finish Options	See Metal Finish Color Options	See list of options for each specific unit; Specify and add accordingly.
		<table border="1"> <thead> <tr> <th>3a Wood Finish</th> <th>3b Chassis Grain Direction</th> </tr> </thead> <tbody> <tr> <td>See Double Cut Wood Finish Options</td> <td>For Double Cut Only: Vertical Horizontal</td> </tr> </tbody> </table>		
3a Wood Finish	3b Chassis Grain Direction			
See Double Cut Wood Finish Options	For Double Cut Only: Vertical Horizontal			

Description	D	W	H	CTN WT	CU FT	① Model	Laminate	Flat Cut Veneer	Double Cut Veneer
Monitor Cabinet with Dual Shelf Storage	15 15/16	95 7/8	40	255	43	FLT1696-40STVS	\$3,629		
	15 15/16	95 7/8	40	255	43	FLV1696-40STVS		\$5,944	\$6,541
	15 15/16	89 7/8	40	243	41	FLT1690-40STVS	\$3,523		
	15 15/16	89 7/8	40	243	41	FLV1690-40STVS		\$5,774	\$6,349
	15 15/16	83 7/8	40	231	38	FLT1684-40STVS	\$3,420		
	15 15/16	83 7/8	40	231	38	FLV1684-40STVS		\$5,604	\$6,165

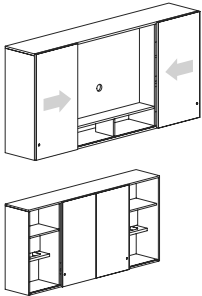


Features:

- use with primary height credenzas
- two adjustable shelves in storage section
- flat screen monitor may be mounted in media section
- divided shelf with oval grommet in back panel
- lock is standard on storage section only
- extreme back panel allows for monitor bracket mounting and wire pass through
- 95 7/8" w cabinet = 48" w media section; monitor not to exceed 45" w x 29" h
- 89 7/8" w cabinet = 45" w media section; monitor not to exceed 42" w x 29" h
- 83 7/8" w cabinet = 42" w media section; monitor not to exceed 39" w x 29" h

Options:

- must specify chassis grain direction on double cut veneer, see pages 13-15 for details
- veneer door fronts in paint available, specify paint color and add \$337 list; see page 16 for details
- on laminate units, contrasting laminate door fronts available, no upcharge; specify laminate color, see page 16 for details
- white glass doors with aluminum trim available, specify and add \$2,674 list for 96" w, \$2,544 list for 90" w, \$2,415 list for 84" w; see page 33 for details
- markerboard laminate doors available, specify and add \$569 list; see page 33 for details

Description	① Model	List Price Per Tackboard Fabric Grade										
		COM	A	B	C	D	E	F	G	H	I	J
Monitor Cabinet with Dual Work-in-Process Storage 	FLT1696-40PTVP Laminate	\$3,983	\$4,008	\$4,057	\$4,143	\$4,253	\$4,362	\$4,533	\$4,717	\$4,910	\$5,217	\$5,581
	Flat Cut	\$6,147	\$6,172	\$6,220	\$6,305	\$6,416	\$6,526	\$6,696	\$6,880	\$7,073	\$7,382	\$7,744
	FLV1696-40PTVP Double Cut	\$6,700	\$6,729	\$6,774	\$6,862	\$6,972	\$7,081	\$7,252	\$7,435	\$7,629	\$7,936	\$8,301
	D - 15 1/16 W - 95 7/8 H - 40 CTN WT - 265 CU FT - 43											
		COM	A	B	C	D	E	F	G	H	I	J
	FLT1690-40PTVP Laminate	\$3,877	\$3,903	\$3,950	\$4,036	\$4,146	\$4,256	\$4,426	\$4,611	\$4,805	\$5,111	\$5,475
	Flat Cut	\$5,975	\$6,002	\$6,049	\$6,133	\$6,246	\$6,357	\$6,526	\$6,709	\$6,905	\$7,209	\$7,574
	FLV1690-40PTVP Double Cut	\$6,513	\$6,541	\$6,587	\$6,674	\$6,784	\$6,894	\$7,064	\$7,248	\$7,441	\$7,747	\$8,113
	D - 15 1/16 W - 89 7/8 H - 40 CTN WT - 252 CU FT - 41											
		COM	A	B	C	D	E	F	G	H	I	J
	FLT1684-40PTVP Laminate	\$3,772	\$3,800	\$3,846	\$3,933	\$4,042	\$4,153	\$4,324	\$4,507	\$4,701	\$5,009	\$5,373
	Flat Cut	\$5,812	\$5,838	\$5,885	\$5,972	\$6,082	\$6,191	\$6,363	\$6,545	\$6,739	\$7,046	\$7,410
	FLV1684-40PTVP Double Cut	\$6,336	\$6,361	\$6,409	\$6,494	\$6,605	\$6,715	\$6,884	\$7,068	\$7,261	\$7,569	\$7,933
	D - 15 1/16 W - 83 7/8 H - 40 CTN WT - 239 CU FT - 38											

Features:

- use with primary height credenzas
- sliding doors
- locking is standard on sliding doors in closed storage position
- work sections contain lower letter size file opening shelf, tackboard, and fixed upper shelf
- flat screen monitor may be mounted in center section
- divided shelf with oval grommet in back panel
- extreme back panel allows for monitor bracket mounting and wire pass through
- 95 7/8" w cabinet = 48" w media section; monitor not to exceed 45" w x 29" h
- 89 7/8" w cabinet = 45" w media section; monitor not to exceed 42" w x 29" h
- 83 7/8" w cabinet = 42" w media section; monitor not to exceed 39" w x 29" h

Options:

- must specify chassis grain direction on double cut veneer, see pages 13-15 for details
- veneer door fronts in paint available, specify paint color and add \$337 list; see page 16 for details
- on laminate units, contrasting door fronts available, no upcharge; specify color, see page 16 for details
- white glass doors with aluminum trim available, specify and add \$2,674 list for 96" w, \$2,544 list for 90" w, \$2,415 list for 84" w; see page 33 for details
- markerboard laminate doors available, specify and add \$569 list; see page 33 for details
- tackboard included in work-in-process section
- com ydg: 95 7/8" w cabinet = 3; 89 7/8" w cabinet = 3; 83 7/8" w cabinet = 3

To Order, Specify:

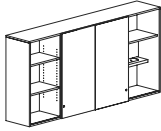
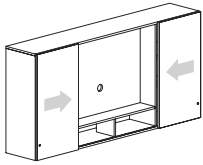
① Model Number	② Fabric Selection	
	Vendor Pattern Color	Visit www.jsifurniture.com/finishes-and-materials/textiles for our textiles program. See selection of standard and graded in manufacturers and patterns.

To Order, Specify:

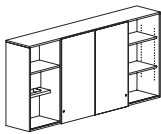
① Laminate Model #	② Laminate Selection	③ Metal Color	④ Other Product Options
Laminate (FLT)	See Laminate Selection	See Metal Finish Color Options	See list of options for each specific unit; Specify and add accordingly.

① Veneer Model #	② Wood Species	③ Wood Finish	④ Metal Color	⑤ Other Product Options
Veneer (FLV)	Flat Cut CH1 Cherry MA1 Maple WA1 Walnut BO1 Black Oak	See Flat Cut Wood Finish Options	See Metal Finish Color Options	See list of options for each specific unit; Specify and add accordingly.
	Double Cut DC1 Double Cut	ⓐ Wood Finish See Double Cut Wood Finish Options		

Description	Model	List Price Per Tackboard Fabric Grade												
		COM	A	B	C	D	E	F	G	H	I	J		
Center Monitor Cabinet with Side Storage and Side Work-in-Process Storage	FLT1696-40STVP	Laminate	\$3,684	\$3,698	\$3,720	\$3,764	\$3,819	\$3,875	\$3,959	\$4,050	\$4,147	\$4,299	\$4,483	
	FLV1696-40STVP	Flat Cut	\$5,848	\$5,860	\$5,884	\$5,927	\$5,982	\$6,038	\$6,122	\$6,214	\$6,311	\$6,466	\$6,647	
		Double Cut	\$6,403	\$6,416	\$6,439	\$6,483	\$6,539	\$6,594	\$6,677	\$6,770	\$6,867	\$7,020	\$7,202	
	FLT1696-40PTVS	Laminate	\$3,684	\$3,698	\$3,720	\$3,764	\$3,819	\$3,875	\$3,959	\$4,050	\$4,147	\$4,299	\$4,483	
	FLV1696-40PTVS	Flat Cut	\$5,848	\$5,860	\$5,884	\$5,927	\$5,982	\$6,038	\$6,122	\$6,214	\$6,311	\$6,466	\$6,647	
		Double Cut	\$6,403	\$6,416	\$6,439	\$6,483	\$6,539	\$6,594	\$6,677	\$6,770	\$6,867	\$7,020	\$7,202	
	D - 15 1/8" W - 95 7/8" H - 40" CTN WT - 260 CU FT - 43													
				COM	A	B	C	D	E	F	G	H	I	J
	*STVP shown	FLT1690-40STVP	Laminate	\$3,583	\$3,594	\$3,619	\$3,661	\$3,717	\$3,771	\$3,856	\$3,949	\$4,044	\$4,199	\$4,380
		FLV1690-40STVP	Flat Cut	\$5,681	\$5,693	\$5,717	\$5,759	\$5,816	\$5,870	\$5,957	\$6,048	\$6,146	\$6,298	\$6,481
Double Cut			\$6,220	\$6,232	\$6,256	\$6,299	\$6,355	\$6,410	\$6,494	\$6,585	\$6,685	\$6,836	\$7,019	
FLT1690-40PTVS		Laminate	\$3,583	\$3,594	\$3,619	\$3,661	\$3,717	\$3,771	\$3,856	\$3,949	\$4,044	\$4,199	\$4,380	
FLV1690-40PTVS		Flat Cut	\$5,681	\$5,693	\$5,717	\$5,759	\$5,816	\$5,870	\$5,957	\$6,048	\$6,146	\$6,298	\$6,481	
		Double Cut	\$6,220	\$6,232	\$6,256	\$6,299	\$6,355	\$6,410	\$6,494	\$6,585	\$6,685	\$6,836	\$7,019	
D - 15 1/8" W - 89 7/8" H - 40" CTN WT - 247 CU FT - 41														



*STVP shown



*PTVS

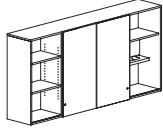
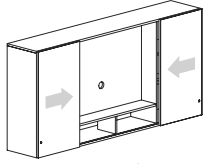
Features:

- use with primary height credenzas
- sliding doors
- locking is standard on sliding doors in closed storage position
- one side, shelf section - two adjustable shelves
- flat screen monitor may be mounted in center section
- divided shelf with oval grommet in back panel
- extreme back panel allows for monitor bracket mounting and wire pass through
- 95 7/8" w cabinet = 48" w media section; monitor not to exceed 45" w x 29" h
- 89 7/8" w cabinet = 45" w media section; monitor not to exceed 42" w x 29" h

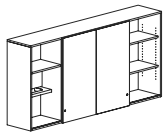
Options:

- must specify chassis grain direction on double cut veneer, see pages 13-15 for details
- veneer door fronts in paint available, specify paint color and add \$337 list; see page 16 for details
- on laminate units, contrasting door fronts available, no upcharge; specify color, see page 16 for details
- white glass doors with aluminum trim available, specify and add \$2,674 list for 96" w, \$2,544 list for 90" w; see page 33 for details
- markerboard laminate doors available, specify and add \$569 list; see page 33 for details
- tackboard included in work-in-process section
- com ydg: 95 7/8" w cabinet = 3; 89 7/8" w cabinet = 3

Description	① Model	List Price Per Tackboard Fabric Grade											
		COM	A	B	C	D	E	F	G	H	I	J	
Center Monitor Cabinet with Side Storage and Side Work-in-Process Storage	FLT1684-40STVP	Laminate	\$3,481	\$3,496	\$3,519	\$3,563	\$3,618	\$3,671	\$3,758	\$3,849	\$3,947	\$4,099	\$4,282
	FLV1684-40STVP	Flat Cut	\$5,521	\$5,533	\$5,558	\$5,601	\$5,655	\$5,712	\$5,796	\$5,888	\$5,984	\$6,138	\$6,320
		Double Cut	\$6,044	\$6,056	\$6,081	\$6,123	\$6,179	\$6,234	\$6,319	\$6,411	\$6,508	\$6,661	\$6,843
	FLT1684-40PTVS	Laminate	\$3,481	\$3,496	\$3,519	\$3,563	\$3,618	\$3,671	\$3,758	\$3,849	\$3,947	\$4,099	\$4,282
	FLV1684-40PTVS	Flat Cut	\$5,521	\$5,533	\$5,558	\$5,601	\$5,655	\$5,712	\$5,796	\$5,888	\$5,984	\$6,138	\$6,320
		Double Cut	\$6,044	\$6,056	\$6,081	\$6,123	\$6,179	\$6,234	\$6,319	\$6,411	\$6,508	\$6,661	\$6,843
D - 15 1/16 W - 83 7/8 H - 40 CTN WT - 234 CU FT - 38													



*STVP shown



*PTVS

Features:

- use with primary height credenzas
- sliding doors
- locking is standard on sliding doors in closed storage position
- one side, shelf section - two adjustable shelves
- flat screen monitor may be mounted in center section
- divided shelf with oval grommet in back panel
- extreme back panel allows for monitor bracket mounting and wire pass through
- 42" w media section; monitor not to exceed 39" w x 29" h

Options:

- must specify chassis grain direction on double cut veneer, see pages 13-15 for details
- veneer door fronts in paint available, specify paint color and add \$337 list; see page 16 for details
- on laminate units, contrasting door fronts available, no upcharge; specify color, see page 16 for details
- white glass doors with aluminum trim available, specify and add \$2,415 list; see page 33 for details
- markerboard laminate doors available, specify and add \$569 list; see page 33 for details
- tackboard included in work-in-process section
- com ydg: 1

To Order, Specify:

① Model Number	② Fabric Selection	
	Vendor Pattern Color	Visit www.jsifurniture.com/finishes-and-materials/textiles for our textiles program. See selection of standard and graded in manufacturers and patterns.

To Order, Specify:

① Laminate Model #	② Laminate Selection	③ Metal Color	④ Other Product Options
Laminate (FLT)	See Laminate Selection	See Metal Finish Color Options	See list of options for each specific unit; Specify and add accordingly.

① Veneer Model #	② Wood Species	③ Wood Finish	④ Metal Color	⑤ Other Product Options	
Veneer (FLV)	Flat Cut CH1 Cherry MA1 Maple WA1 Walnut BO1 Black Oak	See Flat Cut Wood Finish Options	See Metal Finish Color Options	See list of options for each specific unit; Specify and add accordingly.	
	Double Cut DC1 Double Cut	<table border="1"> <thead> <tr> <th>3a Wood Finish</th> <th>3b Chassis Grain Direction</th> </tr> </thead> <tbody> <tr> <td>See Double Cut Wood Finish Options</td> <td>For Double Cut Only: Vertical Horizontal</td> </tr> </tbody> </table>			3a Wood Finish
3a Wood Finish	3b Chassis Grain Direction				
See Double Cut Wood Finish Options	For Double Cut Only: Vertical Horizontal				

Description	Model	List Price Per Tackboard Fabric Grade											
		COM	A	B	C	D	E	F	G	H	I	J	
Monitor Cabinet with Work-in-Process Storage *PTV shown *TVP	FLT1696-40PTV Laminate	\$3,703	\$3,722	\$3,759	\$3,824	\$3,905	\$3,988	\$4,115	\$4,253	\$4,400	\$4,629	\$4,902	
	FLV1696-40PTV	Flat Cut	\$5,834	\$5,854	\$5,889	\$5,952	\$6,037	\$6,119	\$6,247	\$6,382	\$6,531	\$6,759	\$7,033
		Double Cut	\$6,380	\$6,401	\$6,435	\$6,499	\$6,582	\$6,665	\$6,794	\$6,929	\$7,075	\$7,307	\$7,579
	FLT1696-40TVP Laminate	\$3,703	\$3,722	\$3,759	\$3,824	\$3,905	\$3,988	\$4,115	\$4,253	\$4,400	\$4,629	\$4,902	
	FLV1696-40TVP	Flat Cut	\$5,834	\$5,854	\$5,889	\$5,952	\$6,037	\$6,119	\$6,247	\$6,382	\$6,531	\$6,759	\$7,033
		Double Cut	\$6,380	\$6,401	\$6,435	\$6,499	\$6,582	\$6,665	\$6,794	\$6,929	\$7,075	\$7,307	\$7,579
	D - 15 1/4" W - 95 7/8" H - 40" CTN WT - 257 CU FT - 43												
	FLT1690-40PTV Laminate	\$3,597	\$3,618	\$3,652	\$3,717	\$3,800	\$3,882	\$4,010	\$4,146	\$4,292	\$4,523	\$4,796	
	FLV1690-40PTV	Flat Cut	\$5,667	\$5,685	\$5,722	\$5,787	\$5,868	\$5,950	\$6,079	\$6,215	\$6,363	\$6,591	\$6,866
		Double Cut	\$6,196	\$6,216	\$6,252	\$6,316	\$6,400	\$6,482	\$6,610	\$6,747	\$6,893	\$7,123	\$7,395
FLT1690-40TVP Laminate	\$3,597	\$3,618	\$3,652	\$3,717	\$3,800	\$3,882	\$4,010	\$4,146	\$4,292	\$4,523	\$4,796		
FLV1690-40TVP	Flat Cut	\$5,667	\$5,685	\$5,722	\$5,787	\$5,868	\$5,950	\$6,079	\$6,215	\$6,363	\$6,591	\$6,866	
	Double Cut	\$6,196	\$6,216	\$6,252	\$6,316	\$6,400	\$6,482	\$6,610	\$6,747	\$6,893	\$7,123	\$7,395	
D - 15 1/4" W - 89 7/8" H - 40" CTN WT - 243 CU FT - 41													
FLT1684-40PTV Laminate	\$3,496	\$3,514	\$3,551	\$3,615	\$3,698	\$3,780	\$3,907	\$4,043	\$4,191	\$4,420	\$4,695		
FLV1684-40PTV	Flat Cut	\$5,503	\$5,525	\$5,559	\$5,623	\$5,707	\$5,789	\$5,917	\$6,053	\$6,199	\$6,429	\$6,702	
	Double Cut	\$6,018	\$6,039	\$6,075	\$6,138	\$6,222	\$6,303	\$6,431	\$6,567	\$6,715	\$6,945	\$7,216	
FLT1684-40TVP Laminate	\$3,496	\$3,514	\$3,551	\$3,615	\$3,698	\$3,780	\$3,907	\$4,043	\$4,191	\$4,420	\$4,695		
FLV1684-40TVP	Flat Cut	\$5,503	\$5,525	\$5,559	\$5,623	\$5,707	\$5,789	\$5,917	\$6,053	\$6,199	\$6,429	\$6,702	
	Double Cut	\$6,018	\$6,039	\$6,075	\$6,138	\$6,222	\$6,303	\$6,431	\$6,567	\$6,715	\$6,945	\$7,216	
D - 15 1/4" W - 83 7/8" H - 40" CTN WT - 231 CU FT - 38													
FLT1678-40PTV Laminate	\$3,394	\$3,410	\$3,440	\$3,495	\$3,564	\$3,632	\$3,738	\$3,852	\$3,975	\$4,165	\$4,395		
FLV1678-40PTV	Flat Cut	\$5,344	\$5,360	\$5,389	\$5,444	\$5,513	\$5,581	\$5,686	\$5,801	\$5,925	\$6,116	\$6,344	
	Double Cut	\$5,846	\$5,860	\$5,891	\$5,943	\$6,013	\$6,082	\$6,188	\$6,303	\$6,425	\$6,616	\$6,844	
FLT1678-40TVP Laminate	\$3,394	\$3,410	\$3,440	\$3,495	\$3,564	\$3,632	\$3,738	\$3,852	\$3,975	\$4,165	\$4,395		
FLV1678-40TVP	Flat Cut	\$5,344	\$5,360	\$5,389	\$5,444	\$5,513	\$5,581	\$5,686	\$5,801	\$5,925	\$6,116	\$6,344	
	Double Cut	\$5,846	\$5,860	\$5,891	\$5,943	\$6,013	\$6,082	\$6,188	\$6,303	\$6,425	\$6,616	\$6,844	
D - 15 1/4" W - 77 7/8" H - 40" CTN WT - 218 CU FT - 35													

Features:

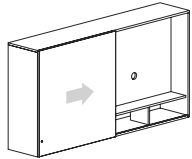
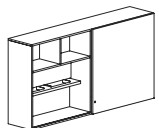
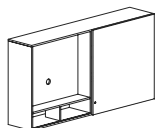
- use with primary height credenzas
- sliding door
- locking is standard on sliding doors in closed storage position
- work section - dual hanging letter size file pocket shelf with tackable surface above; upper fixed shelf
- flat screen monitor may be mounted in media section
- divided shelf with oval grommet in back panel
- extreme back panel allows for monitor bracket mounting and wire pass through
- 95 7/8" w cabinet = 48" w media section; monitor not to exceed 45" w x 29" h
- 89 7/8" w cabinet = 45" w media section; monitor not to exceed 42" w x 29" h
- 83 7/8" w cabinet = 42" w media section; monitor not to exceed 39" w x 29" h
- 77 7/8" w cabinet = 39" w media section; monitor not to exceed 36" w x 29" h

Options:

- must specify chassis grain direction on double cut veneer, see pages 13-15 for details
- veneer door fronts in paint available, specify paint color and add \$337 list; see page 16 for details
- on laminate units, contrasting door fronts available, no upcharge; specify color, see page 16 for details
- white glass doors with aluminum trim available, specify and add \$2,603 list for 96" w, \$2,241 list for 90" w, \$2,112 list for 84" w, \$1,983 list for 78" w; see page 33 for details
- markerboard laminate doors available, specify and add \$495 list; see page 33 for details
- tackboard included in work-in-process section
- com ydg: 95 7/8" w cabinet = 1 1/2; 89 7/8" w cabinet = 1 1/2; 83 7/8" w cabinet = 1 1/2; 77 7/8" w cabinet = 1 1/4

To Order, Specify:

1 Model Number	2 Fabric Selection
Vendor Pattern Color	Visit www.jsifurniture.com/finishes-and-materials/textiles for our textiles program. See selection of standard and graded in manufacturers and patterns.

Description	Model	List Price Per Tackboard Fabric Grade												
		COM	A	B	C	D	E	F	G	H	I	J		
Monitor Cabinet with Work-in-Process Storage   *PTV shown  *TVP	FLT1672-40PTV	Laminate	\$3,355	\$3,372	\$3,401	\$3,457	\$3,525	\$3,593	\$3,700	\$3,815	\$3,938	\$4,129	\$4,357	
	FLV1672-40PTV	Flat Cut	\$5,287	\$5,302	\$5,334	\$5,386	\$5,456	\$5,525	\$5,630	\$5,746	\$5,867	\$6,056	\$6,286	
		Double Cut	\$5,781	\$5,797	\$5,828	\$5,882	\$5,950	\$6,018	\$6,125	\$6,240	\$6,363	\$6,552	\$6,782	
	FLT1672-40TVP	Laminate	\$3,355	\$3,372	\$3,401	\$3,457	\$3,525	\$3,593	\$3,700	\$3,815	\$3,938	\$4,129	\$4,357	
		Flat Cut	\$5,287	\$5,302	\$5,334	\$5,386	\$5,456	\$5,525	\$5,630	\$5,746	\$5,867	\$6,056	\$6,286	
	FLV1672-40TVP	Double Cut	\$5,781	\$5,797	\$5,828	\$5,882	\$5,950	\$6,018	\$6,125	\$6,240	\$6,363	\$6,552	\$6,782	
		D - 15 1/16 W - 71 7/8 H - 40 CTN WT - 205 CU FT - 33												
	*PTV shown *TVP	FLT1666-40PTV	Laminate	\$3,316	\$3,333	\$3,365	\$3,417	\$3,488	\$3,554	\$3,660	\$3,775	\$3,898	\$4,088	\$4,318
			Flat Cut	\$5,228	\$5,242	\$5,273	\$5,328	\$5,397	\$5,465	\$5,570	\$5,685	\$5,809	\$5,998	\$6,228
		FLV1666-40PTV	Double Cut	\$5,717	\$5,734	\$5,761	\$5,817	\$5,887	\$5,955	\$6,059	\$6,175	\$6,298	\$6,489	\$6,717
			Laminate	\$3,316	\$3,333	\$3,365	\$3,417	\$3,488	\$3,554	\$3,660	\$3,775	\$3,898	\$4,088	\$4,318
		FLT1666-40TVP	Flat Cut	\$5,228	\$5,242	\$5,273	\$5,328	\$5,397	\$5,465	\$5,570	\$5,685	\$5,809	\$5,998	\$6,228
Double Cut			\$5,717	\$5,734	\$5,761	\$5,817	\$5,887	\$5,955	\$6,059	\$6,175	\$6,298	\$6,489	\$6,717	
D - 15 1/16 W - 65 7/8 H - 40 CTN WT - 191 CU FT - 30														
FLT1660-40PTV		Laminate	\$3,278	\$3,292	\$3,315	\$3,358	\$3,414	\$3,468	\$3,554	\$3,645	\$3,743	\$3,895	\$4,078	
		Flat Cut	\$5,171	\$5,184	\$5,209	\$5,251	\$5,306	\$5,361	\$5,446	\$5,538	\$5,635	\$5,789	\$5,971	
FLV1660-40PTV		Double Cut	\$5,657	\$5,671	\$5,693	\$5,737	\$5,792	\$5,848	\$5,932	\$6,023	\$6,121	\$6,275	\$6,456	
		Laminate	\$3,278	\$3,292	\$3,315	\$3,358	\$3,414	\$3,468	\$3,554	\$3,645	\$3,743	\$3,895	\$4,078	
FLT1660-40TVP		Flat Cut	\$5,171	\$5,184	\$5,209	\$5,251	\$5,306	\$5,361	\$5,446	\$5,538	\$5,635	\$5,789	\$5,971	
	Double Cut	\$5,657	\$5,671	\$5,693	\$5,737	\$5,792	\$5,848	\$5,932	\$6,023	\$6,121	\$6,275	\$6,456		
D - 15 1/16 W - 59 7/8 H - 40 CTN WT - 180 CU FT - 27														

Features:

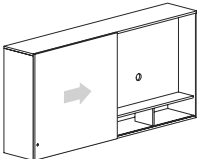
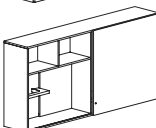
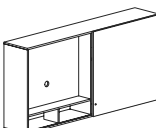
- use with primary height credenzas
- sliding door
- locking is standard on sliding doors in closed storage position
- work section - lower file shelf with full height tackboard; fixed upper shelf
- flat screen monitor may be mounted in media section
- divided shelf with oval grommet in back panel
- extreme back panel allows for monitor bracket mounting and wire pass through
- 71 7/8" w cabinet = 36" w media section; monitor not to exceed 33" w x 29" h
- 65 7/8" w cabinet = 33" w media section; monitor not to exceed 30" w x 29" h
- 59 7/8" w cabinet = 30" w media section; monitor not to exceed 27" w x 29" h

Options:

- must specify chassis grain direction on double cut veneer, see pages 13-15 for details
- veneer door fronts in paint available, specify paint color and add \$337 list; see page 16 for details
- on laminate units, contrasting door fronts available, no upcharge; specify color, see page 16 for details
- white glass doors with aluminum trim available, specify and add \$1,854 list for 72" w, \$1,725 list for 66" w, \$1,597 list for 60" w; see page 33 for details
- markerboard laminate doors available, specify and add \$495 list; see page 33 for details
- tackboard included in work-in-process section
- com ydg: 71 7/8" w cabinet = 1 1/4; 65 7/8" w cabinet = 1 1/4; 59 7/8" w cabinet = 1

To Order, Specify:

1 Laminate Model # Laminate (FLT)		2 Laminate Selection See Laminate Selection		3 Metal Color See Metal Finish Color Options		4 Other Product Options See list of options for each specific unit; Specify and add accordingly.			
1 Veneer Model # Veneer (FLV)		2 Wood Species Flat Cut CH1 Cherry MA1 Maple WA1 Walnut BO1 Black Oak		3 Wood Finish See Flat Cut Wood Finish Options		4 Metal Color See Metal Finish Color Options		5 Other Product Options See list of options for each specific unit; Specify and add accordingly.	
		Double Cut DC1 Double Cut		3a Wood Finish See Double Cut Wood Finish Options		3b Chassis Grain Direction For Double Cut Only: Vertical Horizontal			

Description	Model	List Price Per Tackboard Fabric Grade											
		COM	A	B	C	D	E	F	G	H	I	J	
Monitor Cabinet with Side Work-in-Process Storage   *PTTV shown  *TVPT	FLT1696-40PTTV Laminate	\$3,716	\$3,728	\$3,752	\$3,794	\$3,850	\$3,905	\$3,990	\$4,081	\$4,178	\$4,332	\$4,515	
	Flat Cut	\$5,847	\$5,859	\$5,883	\$5,926	\$5,980	\$6,037	\$6,121	\$6,213	\$6,309	\$6,464	\$6,645	
	FLV1696-40PTTV Double Cut	\$6,391	\$6,407	\$6,429	\$6,472	\$6,529	\$6,582	\$6,668	\$6,759	\$6,857	\$7,009	\$7,192	
	FLT1696-40TVPT Laminate	\$3,716	\$3,728	\$3,752	\$3,794	\$3,850	\$3,905	\$3,990	\$4,081	\$4,178	\$4,332	\$4,515	
	Flat Cut	\$5,847	\$5,859	\$5,883	\$5,926	\$5,980	\$6,037	\$6,121	\$6,213	\$6,309	\$6,464	\$6,645	
	FLV1696-40TVPT Double Cut	\$6,391	\$6,407	\$6,429	\$6,472	\$6,529	\$6,582	\$6,668	\$6,759	\$6,857	\$7,009	\$7,192	
	D - 15 1/8" W - 95 7/8" H - 40" CTN WT - 252 CU FT - 43												
	FLT1690-40PTTV Laminate	\$3,607	\$3,622	\$3,644	\$3,687	\$3,743	\$3,796	\$3,883	\$3,975	\$4,072	\$4,225	\$4,406	
	Flat Cut	\$5,677	\$5,688	\$5,714	\$5,756	\$5,812	\$5,867	\$5,951	\$6,044	\$6,140	\$6,295	\$6,476	
	FLV1690-40PTTV Double Cut	\$6,208	\$6,222	\$6,243	\$6,288	\$6,343	\$6,399	\$6,483	\$6,575	\$6,671	\$6,824	\$7,006	
FLT1690-40TVPT Laminate	\$3,607	\$3,622	\$3,644	\$3,687	\$3,743	\$3,796	\$3,883	\$3,975	\$4,072	\$4,225	\$4,406		
Flat Cut	\$5,677	\$5,688	\$5,714	\$5,756	\$5,812	\$5,867	\$5,951	\$6,044	\$6,140	\$6,295	\$6,476		
FLV1690-40TVPT Double Cut	\$6,208	\$6,222	\$6,243	\$6,288	\$6,343	\$6,399	\$6,483	\$6,575	\$6,671	\$6,824	\$7,006		
D - 15 1/8" W - 89 7/8" H - 40" CTN WT - 238 CU FT - 41													
FLT1684-40PTTV Laminate	\$3,504	\$3,518	\$3,541	\$3,585	\$3,639	\$3,696	\$3,780	\$3,873	\$3,967	\$4,122	\$4,302		
Flat Cut	\$5,513	\$5,527	\$5,550	\$5,594	\$5,647	\$5,705	\$5,789	\$5,879	\$5,976	\$6,129	\$6,312		
FLV1684-40PTTV Double Cut	\$6,029	\$6,041	\$6,064	\$6,108	\$6,163	\$6,219	\$6,303	\$6,394	\$6,492	\$6,645	\$6,826		
FLT1684-40TVPT Laminate	\$3,504	\$3,518	\$3,541	\$3,585	\$3,639	\$3,696	\$3,780	\$3,873	\$3,967	\$4,122	\$4,302		
Flat Cut	\$5,513	\$5,527	\$5,550	\$5,594	\$5,647	\$5,705	\$5,789	\$5,879	\$5,976	\$6,129	\$6,312		
FLV1684-40TVPT Double Cut	\$6,029	\$6,041	\$6,064	\$6,108	\$6,163	\$6,219	\$6,303	\$6,394	\$6,492	\$6,645	\$6,826		
D - 15 1/8" W - 83 7/8" H - 40" CTN WT - 226 CU FT - 38													

Features:

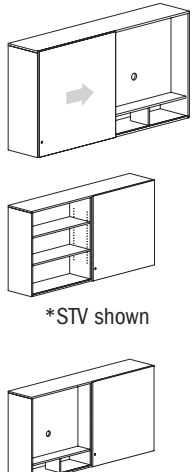
- use with primary height credenzas
- sliding door
- locking is standard on sliding doors in closed storage position
- work section - one hanging letter size file pocket shelf with full height tackable surface; upper fixed shelf
- flat screen monitor may be mounted in media section
- divided shelf with oval grommet in back panel
- extreme back panel allows for monitor bracket mounting and wire pass through
- 95 7/8" w cabinet = 48" w media section; monitor not to exceed 45" w x 29" h
- 89 7/8" w cabinet = 45" w media section; monitor not to exceed 42" w x 29" h
- 83 7/8" w cabinet = 42" w media section; monitor not to exceed 39" w x 29" h

Options:

- must specify chassis grain direction on double cut veneer, see pages 13-15 for details
- veneer door fronts in paint available, specify paint color and add \$337 list; see page 16 for details
- on laminate units, contrasting door fronts available, no upcharge; specify color, see page 16 for details
- white glass doors with aluminum trim available, specify and add \$2,603 list for 96" w, \$2,241 list for 90" w, \$2,112 list for 84" w; see page 33 for details
- markerboard laminate doors available, specify and add \$495 list; see page 33 for details
- tackboard included in work-in-process section
- com ydg: 95 7/8" w cabinet = 1; 89 7/8" w cabinet = 1; 83 7/8" w cabinet = 1

To Order, Specify:

1 Model Number	2 Fabric Selection
Vendor Pattern Color	Visit www.jsifurniture.com/finishes-and-materials/textiles for our textiles program. See selection of standard and graded in manufacturers and patterns.

Description	D	W	H	CTN WT	CU FT	① Model	Laminate	Flat Cut Veneer	Double Cut Veneer
 <p>*STV shown</p> <p>*TVS</p>	15 15/16	77 7/8	40	207	35	FLT1678-40STV	\$3,258		
	15 15/16	77 7/8	40	207	35	FLV1678-40STV		\$5,339	\$5,871
	15 15/16	77 7/8	40	207	35	FLT1678-40TVS	\$3,258		
	15 15/16	77 7/8	40	207	35	FLV1678-40TVS		\$5,339	\$5,871
	15 15/16	71 7/8	40	209	33	FLT1672-40STV	\$3,225		
	15 15/16	71 7/8	40	209	33	FLV1672-40STV		\$5,284	\$5,812
	15 15/16	71 7/8	40	209	33	FLT1672-40TVS	\$3,225		
	15 15/16	71 7/8	40	209	33	FLV1672-40TVS		\$5,284	\$5,812
	15 15/16	65 7/8	40	195	30	FLT1666-40STV	\$3,193		
	15 15/16	65 7/8	40	195	30	FLV1666-40STV		\$5,231	\$5,754
	15 15/16	65 7/8	40	195	30	FLT1666-40TVS	\$3,193		
	15 15/16	65 7/8	40	195	30	FLV1666-40TVS		\$5,231	\$5,754
	15 15/16	59 7/8	40	184	27	FLT1660-40STV	\$3,161		
	15 15/16	59 7/8	40	184	27	FLV1660-40STV		\$5,179	\$5,695
	15 15/16	59 7/8	40	184	27	FLT1660-40TVS	\$3,161		
	15 15/16	59 7/8	40	184	27	FLV1660-40TVS		\$5,179	\$5,695

Features:

- use with primary height credenzas
- two adjustable shelves in storage section
- flat screen monitor may be mounted in media section
- divided shelf with oval grommet in back panel
- lock is standard on storage section only
- extreme back panel allows for monitor bracket mounting and wire pass through
- 77 7/8" w cabinet = 39" w media section; monitor not to exceed 36" w x 29" h
- 71 7/8" w cabinet = 36" w media section; monitor not to exceed 33" w x 29" h
- 65 7/8" w cabinet = 33" w media section; monitor not to exceed 30" w x 29" h
- 59 7/8" w cabinet = 30" w media section; monitor not to exceed 27" w x 29" h

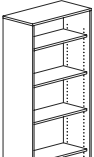
Options:

- must specify chassis grain direction on double cut veneer, see pages 13-15 for details
- veneer door fronts in paint available, specify paint color and add \$337 list; see page 16 for details
- on laminate units, contrasting laminate door fronts available, no upcharge; specify laminate color, see page 16 for details
- white glass doors with aluminum trim available, specify and add \$1,983 list for 78" w, \$1,854 list for 72" w, \$1,725 list for 66" w, \$1,597 list for 60" w; see page 33 for details
- markerboard laminate doors available, specify and add \$495 list; see page 33 for details

To Order, Specify:

① Laminate Model #	② Laminate Selection		③ Metal Color	④ Other Product Options
Laminate (FLT)	See Laminate Selection		See Metal Finish Color Options	See list of options for each specific unit; Specify and add accordingly.

① Veneer Model #	② Wood Species	③ Wood Finish		④ Metal Color	⑤ Other Product Options
Veneer (FLV)	Flat Cut CH1 Cherry MA1 Maple WA1 Walnut BO1 Black Oak	See Flat Cut Wood Finish Options		See Metal Finish Color Options	See list of options for each specific unit; Specify and add accordingly.
		③a Wood Finish	③b Chassis Grain Direction		
	Double Cut DC1 Double Cut	See Double Cut Wood Finish Options	For Double Cut Only: Vertical Horizontal		

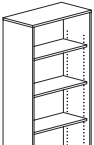
Description	D	W	H	CTN WT	CU FT	① Model	Laminate	Flat Cut Veneer	Double Cut Veneer
	15	36	81	181	32	FLT1536-81FBC	\$1,557		
	15	36	81	181	32	FLV1536-81FBC		\$2,743	\$3,016
	15	30	81	169	27	FLT1530-81FBC	\$1,441		
	15	30	81	169	27	FLV1530-81FBC		\$2,575	\$2,834
	15	24	81	156	22	FLT1524-81FBC	\$1,329		
	15	24	81	156	22	FLV1524-81FBC		\$2,428	\$2,672

Features:

- square edge on top
- five adjustable shelves

Options:

- must specify chassis grain direction on double cut veneer, see pages 13-15 for details

Description	D	W	H	CTN WT	CU FT	① Model	Laminate	Flat Cut Veneer	Double Cut Veneer
	15	36	69	155	27	FLT1536-69FBC	\$1,483		
	15	36	69	155	27	FLV1536-69FBC		\$2,311	\$2,542
	15	30	69	142	23	FLT1530-69FBC	\$1,369		
	15	30	69	142	23	FLV1530-69FBC		\$2,231	\$2,453
	15	24	69	130	19	FLT1524-69FBC	\$1,260		
	15	24	69	130	19	FLV1524-69FBC		\$2,147	\$2,362

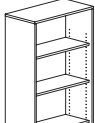
Features:

- square edge on top
- four adjustable shelves

Options:

- must specify chassis grain direction on double cut veneer, see pages 13-15 for details

FLUX - PRIVATE OFFICE

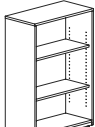
Description	D	W	H	CTN WT	CU FT	① Model	Laminate	Flat Cut Veneer	Double Cut Veneer
Bookcase 	15	36	55 3/8	115	22	FLT1536-55FBC	\$1,336		
	15	36	55 3/8	115	22	FLV1536-55FBC		\$2,081	\$2,290
	15	30	55 3/8	108	19	FLT1530-55FBC	\$1,233		
	15	30	55 3/8	108	19	FLV1530-55FBC		\$2,006	\$2,208
	15	24	55 3/8	101	15	FLT1524-55FBC	\$1,135		
	15	24	55 3/8	101	15	FLV1524-55FBC		\$1,933	\$2,127

Features:

- square edge on top
- three adjustable shelves

Options:

- must specify chassis grain direction on double cut veneer, see pages 13-15 for details

Bookcase 	15	36	41 1/16	81	17	FLT1536-42FBC	\$1,096		
	15	36	41 1/16	81	17	FLV1536-42FBC		\$1,710	\$1,882
	15	30	41 1/16	76	14	FLT1530-42FBC	\$1,008		
	15	30	41 1/16	76	14	FLV1530-42FBC		\$1,651	\$1,816
	15	24	41 1/16	71	12	FLT1524-42FBC	\$937		
	15	24	41 1/16	71	12	FLV1524-42FBC		\$1,589	\$1,746

Features:

- square edge on top
- two adjustable shelves

Options:

- must specify chassis grain direction on double cut veneer, see pages 13-15 for details

To Order, Specify:

① Laminate Model #		② Laminate Selection		③ Metal Color	④ Other Product Options
Laminate (FLT)		See Laminate Selection		See Metal Finish Color Options	See list of options for each specific unit; Specify and add accordingly.
① Veneer Model #	② Wood Species	③ Wood Finish		④ Metal Color	⑤ Other Product Options
Veneer (FLV)	Flat Cut CH1 Cherry MA1 Maple WA1 Walnut BO1 Black Oak	See Flat Cut Wood Finish Options		See Metal Finish Color Options	See list of options for each specific unit; Specify and add accordingly.
	Double Cut DC1 Double Cut	③a Wood Finish See Double Cut Wood Finish Options	③b Chassis Grain Direction For Double Cut Only: Vertical Horizontal		

FLUX - PRIVATE OFFICE

Description	D	W	H	CTN WT	CU FT	① Model	Laminate	Flat Cut Veneer	Double Cut Veneer
Four Drawer Lateral File with Open Compartment	22	36	69	322	38	FLT2236-69F4LF0	\$3,163		
	22	36	69	322	38	FLV2236-69F4LF0		\$4,267	\$4,695
	22	30	69	305	32	FLT2230-69F4LF0	\$3,028		
	22	30	69	305	32	FLV2230-69F4LF0		\$4,052	\$4,461



Features:

- square edge on top
- four drawers with open upper storage
- anti-tip interlock mechanism
- pedestal front locking

Options:

- must specify chassis grain direction on double cut veneer, see pages 13-15 for details
- veneer drawer fronts in paint available, specify paint color and add \$337 list; see page 16 for details
- on laminate units, contrasting drawer fronts available, no upcharge; specify color, see page 16 for details
- ledge pulls standard; prism pulls available, specify and see page 9

Four Drawer Lateral File with Hinge Door Storage Compartment	22	36	69	338	38	FLT2236-69F4LFD	\$3,347		
	22	36	69	338	38	FLV2236-69F4LFD		\$4,536	\$4,989
	22	30	69	321	32	FLT2230-69F4LFD	\$3,201		
	22	30	69	321	32	FLV2230-69F4LFD		\$4,322	\$4,754

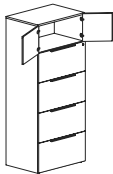


Features:

- square edge on top
- four drawers with hinged door upper compartment
- anti-tip interlock mechanism
- pedestal front locking

Options:

- must specify chassis grain direction on double cut veneer, see pages 13-15 for details
- veneer door and drawer fronts in paint available, specify paint color and add \$337 list; see page 16 for details
- on laminate units, contrasting door and drawer fronts available, no upcharge; specify color, see page 16 for details
- locking door available, specify and add \$142 list
- ledge pulls standard; prism pulls available, specify and see page 9



Description	D	W	H	CTN WT	CU FT	① Model	Laminate	Flat Cut Veneer	Double Cut Veneer
Four Drawer Lateral File	22	36	55 3/8	287	31	FLT2236-55F4LF	\$2,510		
	22	36	55 3/8	287	31	FLV2236-55F4LF		\$3,387	\$3,725
	22	30	55 3/8	270	26	FLT2230-55F4LF	\$2,406		
	22	30	55 3/8	270	26	FLV2230-55F4LF		\$3,217	\$3,540



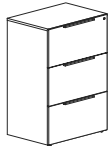
Features:

- four drawers
- anti-tip interlock mechanism
- pedestal front locking

Options:

- must specify chassis grain direction on double cut veneer, see pages 13-15 for details
- veneer drawer fronts in paint available, specify paint color and add \$337 list; see page 16 for details
- on laminate units, contrasting drawer fronts available, no upcharge; specify color, see page 16 for details
- ledge pulls standard; prism pulls available, specify and see page 9

Description	D	W	H	CTN WT	CU FT	① Model	Laminate	Flat Cut Veneer	Double Cut Veneer
Three Drawer Lateral File	22	36	41 1/16	232	26	FLT2236-41F3LF	\$2,419		
	22	36	41 1/16	232	26	FLV2236-41F3LF		\$2,916	\$3,207
	22	30	41 1/16	218	20	FLT2230-41F3LF	\$2,276		
	22	30	41 1/16	218	20	FLV2230-41F3LF		\$2,747	\$3,022



Features:

- three drawers
- anti-tip interlock mechanism
- pedestal front locking

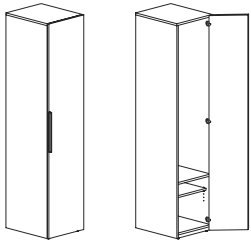
Options:

- must specify chassis grain direction on double cut veneer, see pages 13-15 for details
- veneer drawer fronts in paint available, specify paint color and add \$337 list; see page 16 for details
- on laminate units, contrasting drawer fronts available, no upcharge; specify color, see page 16 for details
- ledge pulls standard; prism pulls available, specify and see page 9

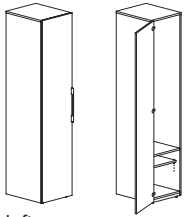
To Order, Specify:

① Laminate Model #		② Laminate Selection		③ Metal Color	④ Other Product Options
Laminate (FLT)		See Laminate Selection		See Metal Finish Color Options	See list of options for each specific unit; Specify and add accordingly.
① Veneer Model #	② Wood Species	③ Wood Finish		④ Metal Color	⑤ Other Product Options
Veneer (FLV)	Flat Cut CH1 Cherry MA1 Maple WA1 Walnut BO1 Black Oak	See Flat Cut Wood Finish Options		See Metal Finish Color Options	See list of options for each specific unit; Specify and add accordingly.
		③a Wood Finish	③b Chassis Grain Direction		
	Double Cut DC1 Double Cut	See Double Cut Wood Finish Options	For Double Cut Only: Vertical Horizontal		

Description	D	W	H	CTN WT	CU FT	① Model	Laminate	Flat Cut Veneer	Double Cut Veneer
81" h Wardrobe	22	18	81	168	24	FLT2218-81FDWR	\$1,834		
	22	18	81	168	24	FLV2218-81FDWR		\$3,256	\$3,583
	22	18	81	168	24	FLT2218-81FDWL	\$1,834		
	22	18	81	168	24	FLV2218-81FDWL		\$3,256	\$3,583



right shown



left

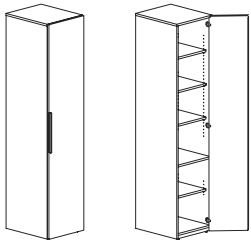
Features:

- lower adjustable shelf
- installed coat hooks

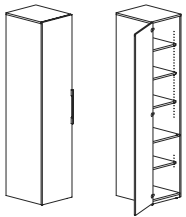
Options:

- must specify chassis grain direction on double cut veneer, see pages 13-15 for details
- veneer door front in paint available, specify paint color and add \$337 list; see page 16 for details
- on laminate units, contrasting doors fronts available, no upcharge; specify color, see page 16 for details
- locking door available, specify and add \$142 list
- ledge pulls standard, mounted vertical; prism pulls available, specify and see page 9
- vanity mirror available, specify and add \$141 list

81" h Storage Cabinet	22	18	81	188	24	FLT2218-81FDR	\$1,826		
	22	18	81	188	24	FLV2218-81FDR		\$3,247	\$3,573
	22	18	81	188	24	FLT2218-81FDL	\$1,826		
	22	18	81	188	24	FLV2218-81FDL		\$3,247	\$3,573



right shown



left

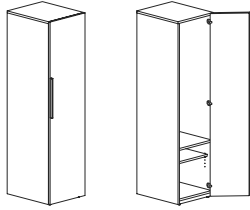
Features:

- five adjustable shelves

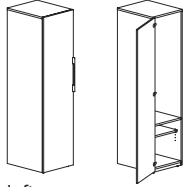
Options:

- must specify chassis grain direction on double cut veneer, see pages 13-15 for details
- veneer door front in paint available, specify paint color and add \$337 list; see page 16 for details
- on laminate units, contrasting doors fronts available, no upcharge; specify color, see page 16 for details
- locking door available, specify and add \$142 list
- ledge pulls standard, mounted vertical; prism pulls available, specify and see page 9
- vanity mirror available, specify and add \$141 list

Description	D	W	H	CTN WT	CU FT	① Model	Laminate	Flat Cut Veneer	Double Cut Veneer
69" h Wardrobe	22	18	69	149	20	FLT2218-69FDWR	\$1,643		
	22	18	69	149	20	FLV2218-69FDWR		\$2,981	\$3,278
	22	18	69	149	20	FLT2218-69FDWL	\$1,643		
	22	18	69	149	20	FLV2218-69FDWL		\$2,981	\$3,278



right shown



left

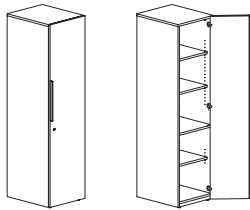
Features:

- lower adjustable shelf
- installed coat hooks

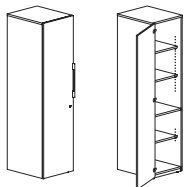
Options:

- must specify chassis grain direction on double cut veneer, see pages 13-15 for details
- veneer door front in paint available, specify paint color and add \$337 list; see page 16 for details
- on laminate units, contrasting doors fronts available, no upcharge; specify color, see page 16 for details
- locking door available, specify and add \$142 list
- ledge pulls standard, mounted vertical; prism pulls available, specify and see page 9
- vanity mirror available, specify and add \$141 list

69" h Storage Cabinet	22	18	69	168	20	FLT2218-69FDR	\$1,633		
	22	18	69	168	20	FLV2218-69FDR		\$2,973	\$3,270
	22	18	69	168	20	FLT2218-69FDL	\$1,633		
	22	18	69	168	20	FLV2218-69FDL		\$2,973	\$3,270



right shown



left

Features:

- four adjustable shelves

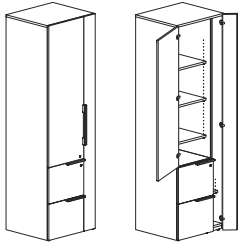
Options:

- must specify chassis grain direction on double cut veneer, see pages 13-15 for details
- veneer door front in paint available, specify paint color and add \$337 list; see page 16 for details
- on laminate units, contrasting doors fronts available, no upcharge; specify color, see page 16 for details
- locking door available, specify and add \$142 list
- ledge pulls standard, mounted vertical; prism pulls available, specify and see page 9
- vanity mirror available, specify and add \$141 list

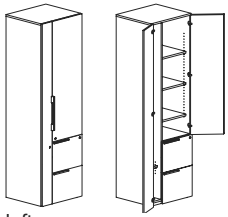
To Order, Specify:

① Laminate Model #		② Laminate Selection		③ Metal Color	④ Other Product Options			
Laminate (FLT)		See Laminate Selection		See Metal Finish Color Options	See list of options for each specific unit; Specify and add accordingly.			
① Veneer Model #	② Wood Species	③ Wood Finish		④ Metal Color	⑤ Other Product Options			
Veneer (FLV)	Flat Cut CH1 Cherry MA1 Maple WA1 Walnut BO1 Black Oak	See Flat Cut Wood Finish Options		See Metal Finish Color Options	See list of options for each specific unit; Specify and add accordingly.			
	Double Cut DC1 Double Cut	<table border="1"> <tr> <th>Ⓐ Wood Finish</th> <th>Ⓑ Chassis Grain Direction</th> </tr> <tr> <td>See Double Cut Wood Finish Options</td> <td>For Double Cut Only: Vertical Horizontal</td> </tr> </table>	Ⓐ Wood Finish	Ⓑ Chassis Grain Direction	See Double Cut Wood Finish Options	For Double Cut Only: Vertical Horizontal		
Ⓐ Wood Finish	Ⓑ Chassis Grain Direction							
See Double Cut Wood Finish Options	For Double Cut Only: Vertical Horizontal							

Description	D	W	H	CTN WT	CU FT	① Model	Laminate	Flat Cut Veneer	Double Cut Veneer
81" h File/File, Storage Cabinet with Side Wardrobe	22	24	81	274	30	FLT2224-81F2DWR	\$3,195		
	22	24	81	274	30	FLV2224-81F2DWR		\$5,046	\$5,550
	22	24	81	274	30	FLT2224-81F2DWL	\$3,195		
	22	24	81	274	30	FLV2224-81F2DWL		\$5,046	\$5,550



right shown



left

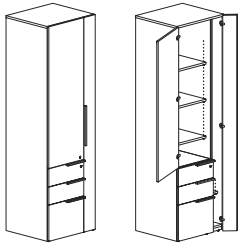
Features:

- aligns with primary height units
- pedestal front locking
- upper compartment has three adjustable shelves
- installed coat hook in wardrobe compartment

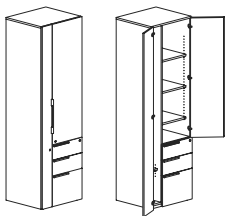
Options:

- must specify chassis grain direction on double cut veneer, see pages 13-15 for details
- veneer door and drawer front in paint available, specify paint color and add \$337; see page 16 for details
- on laminate units, contrasting door and drawer fronts available, no upcharge; specify color, see page 16 for details
- locking doors available, specify and add \$284 list
- ledge pulls standard; prism pulls available, specify and see page 9
- vanity mirror available, specify and add \$141 list

81" h Box/Box/File, Storage Cabinet with Side Wardrobe	22	24	81	276	30	FLT2224-81F1DWR	\$3,203		
	22	24	81	276	30	FLV2224-81F1DWR		\$5,053	\$5,559
	22	24	81	276	30	FLT2224-81F1DWL	\$3,203		
	22	24	81	276	30	FLV2224-81F1DWL		\$5,053	\$5,559



right shown



left

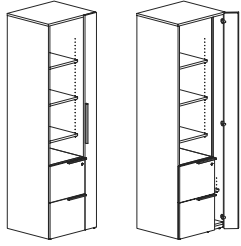
Features:

- aligns with primary height units
- pedestal front locking
- upper compartment has three adjustable shelves
- installed coat hook in wardrobe compartment

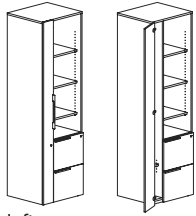
Options:

- must specify chassis grain direction on double cut veneer, see pages 13-15 for details
- veneer door and drawer front in paint available, specify paint color and add \$337; see page 16 for details
- on laminate units, contrasting door and drawer fronts available, no upcharge; specify color, see page 16 for details
- locking doors available, specify and add \$284 list
- ledge pulls standard; prism pulls available, specify and see page 9
- vanity mirror available, specify and add \$141 list

Description	D	W	H	CTN WT	CU FT	① Model	Laminate	Flat Cut Veneer	Double Cut Veneer
81" h File/File, Open Storage Cabinet with Side Wardrobe	22	24	81	253	30	FLT2224-81F20WR	\$3,087		
	22	24	81	253	30	FLV2224-81F20WR		\$4,888	\$5,377
	22	24	81	253	30	FLT2224-81F20WL	\$3,087		
	22	24	81	253	30	FLV2224-81F20WL		\$4,888	\$5,377



right shown



left

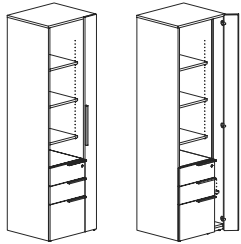
Features:

- aligns with primary height units
- pedestal front locking
- upper compartment has three adjustable shelves
- installed coat hook in wardrobe compartment

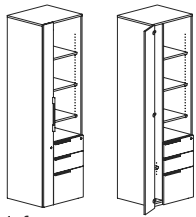
Options:

- must specify chassis grain direction on double cut veneer, see pages 13-15 for details
- veneer door and drawer front in paint available, specify paint color and add \$337; see page 16 for details
- on laminate units, contrasting door and drawer fronts available, no upcharge; specify color, see page 16 for details
- locking side door available, specify and add \$142 list
- ledge pulls standard; prism pulls available, specify and see page 9

81" h Box/Box/File, Open Storage Cabinet with Side Wardrobe	22	24	81	254	30	FLT2224-81F10WR	\$3,093		
	22	24	81	254	30	FLV2224-81F10WR		\$4,897	\$5,386
	22	24	81	254	30	FLT2224-81F10WL	\$3,093		
	22	24	81	254	30	FLV2224-81F10WL		\$4,897	\$5,386



right shown



left

Features:

- aligns with primary height units
- pedestal front locking
- upper compartment has three adjustable shelves
- installed coat hook in wardrobe compartment

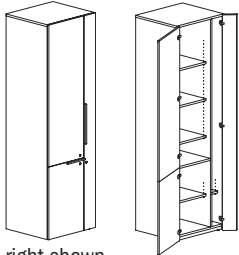
Options:

- must specify chassis grain direction on double cut veneer, see pages 13-15 for details
- veneer door and drawer front in paint available, specify paint color and add \$337; see page 16 for details
- on laminate units, contrasting door and drawer fronts available, no upcharge; specify color, see page 16 for details
- locking side door available, specify and add \$142 list
- ledge pulls standard; prism pulls available, specify and see page 9

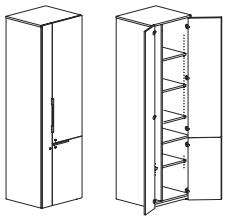
To Order, Specify:

① Laminate Model #		② Laminate Selection		③ Metal Color	④ Other Product Options
Laminate (FLT)		See Laminate Selection		See Metal Finish Color Options	See list of options for each specific unit; Specify and add accordingly.
① Veneer Model #	② Wood Species	③ Wood Finish		④ Metal Color	⑤ Other Product Options
Veneer (FLV)	Flat Cut CH1 Cherry MA1 Maple WA1 Walnut BO1 Black Oak	See Flat Cut Wood Finish Options		See Metal Finish Color Options	See list of options for each specific unit; Specify and add accordingly.
	Double Cut DC1 Double Cut	<table border="1"> <tr> <th>Ⓐ Wood Finish</th> <th>Ⓑ Chassis Grain Direction</th> </tr> <tr> <td>See Double Cut Wood Finish Options</td> <td>For Double Cut Only: Vertical Horizontal</td> </tr> </table>	Ⓐ Wood Finish		
Ⓐ Wood Finish	Ⓑ Chassis Grain Direction				
See Double Cut Wood Finish Options	For Double Cut Only: Vertical Horizontal				

Description	D	W	H	CTN WT	CU FT	① Model	Laminate	Flat Cut Veneer	Double Cut Veneer
81" h Lower and Upper Hinge Door Storage Cabinet with Side Wardrobe	22	24	81	254	30	FLT2224-81F7DWR	\$2,488		
	22	24	81	254	30	FLV2224-81F7DWR		\$4,266	\$4,693
	22	24	81	254	30	FLT2224-81F7DWL	\$2,488		
	22	24	81	254	30	FLV2224-81F7DWL		\$4,266	\$4,693



right shown



left

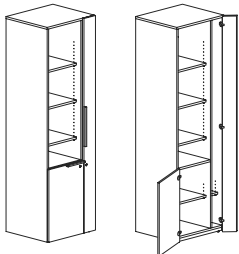
Features:

- aligns with primary height units
- upper compartment has three adjustable shelves, lower compartment has one adjustable shelf
- installed coat hook in wardrobe compartment

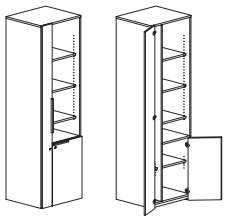
Options:

- must specify chassis grain direction on double cut veneer, see pages 13-15 for details
- veneer door fronts in paint available, specify paint color and add \$337 list; see page 16 for detail
- on laminate units, contrasting doors fronts available, no upcharge; specify color, see page 16 for details
- locking doors available, specify and add \$426 list
- ledge pulls standard; prism pulls available, specify and see page 9
- pull out trash can available, specify and add \$456 list; see page 38 for details

81" h Lower Hinge Door, Open Storage Cabinet with Side Wardrobe	22	24	81	232	30	FLT2224-81F70WR	\$2,378		
	22	24	81	232	30	FLV2224-81F70WR		\$4,110	\$4,522
	22	24	81	232	30	FLT2224-81F70WL	\$2,378		
	22	24	81	232	30	FLV2224-81F70WL		\$4,110	\$4,522



right shown



left

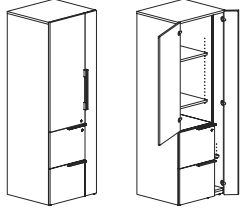
Features:

- aligns with primary height units
- upper compartment has three adjustable shelves, lower compartment has one adjustable shelf
- installed coat hook in wardrobe compartment

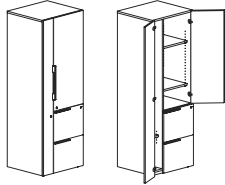
Options:

- must specify chassis grain direction on double cut veneer, see pages 13-15 for details
- veneer door fronts in paint available, specify paint color and add \$337 list; see page 16 for detail
- on laminate units, contrasting doors fronts available, no upcharge; specify color, see page 16 for details
- locking doors available, specify and add \$284 list
- ledge pulls standard; prism pulls available, specify and see page 9
- pull out trash can available, specify and add \$456 list; see page 38 for details

Description	D	W	H	CTN WT	CU FT	① Model	Laminate	Flat Cut Veneer	Double Cut Veneer
69" h File/File, Storage Cabinet with Side Wardrobe	22	24	69	239	26	FLT2224-69F2DWR	\$3,004		
	22	24	69	239	26	FLV2224-69F2DWR		\$4,771	\$5,247
	22	24	69	239	26	FLT2224-69F2DWL	\$3,004		
	22	24	69	239	26	FLV2224-69F2DWL		\$4,771	\$5,247



right shown



left

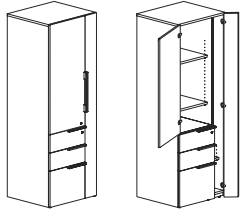
Features

- aligns with primary height units
- pedestal front locking
- upper compartment has two adjustable shelves
- installed coat hook in wardrobe compartment

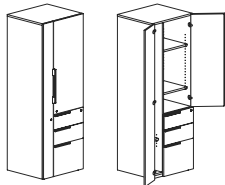
Options:

- must specify chassis grain direction on double cut veneer, see pages 13-15 for details
- veneer door and drawer front in paint available, specify paint color and add \$337; see page 16 for details
- on laminate units, contrasting door and drawer fronts available, no upcharge; specify color, see page 16 for details
- locking doors available, specify and add \$284 list
- ledge pulls standard, mounted vertical; prism pulls available, specify and see page 9

69" h Box/Box/File, Storage Cabinet with Side Wardrobe	22	24	69	241	26	FLT2224-69F1DWR	\$3,010		
	22	24	69	241	26	FLV2224-69F1DWR		\$4,777	\$5,255
	22	24	69	241	26	FLT2224-69F1DWL	\$3,010		
	22	24	69	241	26	FLV2224-69F1DWL		\$4,777	\$5,255



right shown



left

Features:

- aligns with primary height units
- pedestal front locking
- upper compartment has two adjustable shelves
- installed coat hook in wardrobe compartment

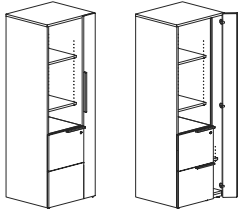
Options:

- must specify chassis grain direction on double cut veneer, see pages 13-15 for details
- veneer door and drawer front in paint available, specify paint color and add \$337; see page 16 for details
- on laminate units, contrasting door and drawer fronts available, no upcharge; specify color, see page 16 for details
- locking doors available, specify and add \$284 list
- ledge pulls standard, mounted vertical; prism pulls available, specify and see page 9

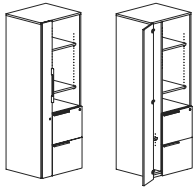
To Order, Specify:

① Laminate Model #		② Laminate Selection		③ Metal Color	④ Other Product Options
Laminate (FLT)		See Laminate Selection		See Metal Finish Color Options	See list of options for each specific unit; Specify and add accordingly.
① Veneer Model #	② Wood Species	③ Wood Finish		④ Metal Color	⑤ Other Product Options
Veneer (FLV)	Flat Cut CH1 Cherry MA1 Maple WA1 Walnut BO1 Black Oak	See Flat Cut Wood Finish Options		See Metal Finish Color Options	See list of options for each specific unit; Specify and add accordingly.
	Double Cut DC1 Double Cut	③a Wood Finish	③b Chassis Grain Direction		
		See Double Cut Wood Finish Options	For Double Cut Only: Vertical Horizontal		

Description	D	W	H	CTN WT	CU FT	① Model	Laminate	Flat Cut Veneer	Double Cut Veneer
69" h File/File, Open Storage Cabinet with Side Wardrobe	22	24	69	222	26	FLT2224-69F20WR	\$2,916		
	22	24	69	222	26	FLV2224-69F20WR		\$4,647	\$5,111
	22	24	69	222	26	FLT2224-69F20WL	\$2,916		
	22	24	69	222	26	FLV2224-69F20WL		\$4,647	\$5,111



right shown



left

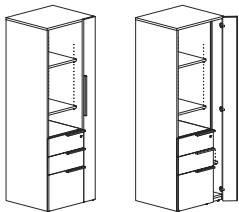
Features:

- aligns with primary height units
- pedestal front locking
- upper compartment has two adjustable shelves
- installed coat hook in wardrobe compartment

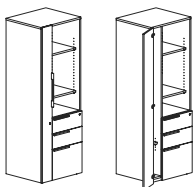
Options:

- must specify chassis grain direction on double cut veneer, see pages 13-15 for details
- veneer door and drawer front in paint available, specify paint color and add \$337; see page 16 for details
- on laminate units, contrasting door and drawer fronts available, no upcharge; specify color, see page 16 for details
- locking side door available, specify and add \$142 list
- ledge pulls standard, mounted vertical; prism pulls available, specify and see page 9

69" h Box/Box/File, Open Storage Cabinet with Side Wardrobe	22	24	69	224	26	FLT2224-69F10WR	\$2,925		
	22	24	69	224	26	FLV2224-69F10WR		\$4,654	\$5,118
	22	24	69	224	26	FLT2224-69F10WL	\$2,925		
	22	24	69	224	26	FLV2224-69F10WL		\$4,654	\$5,118



right shown



left

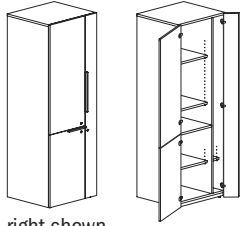
Features:

- aligns with primary height units
- pedestal front locking
- upper compartment has two adjustable shelves
- installed coat hook in wardrobe compartment

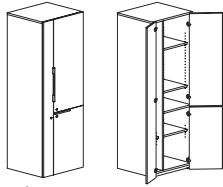
Options:

- must specify chassis grain direction on double cut veneer, see pages 13-15 for details
- veneer door and drawer front in paint available, specify paint color and add \$337; see page 16 for details
- on laminate units, contrasting door and drawer fronts available, no upcharge; specify color, see page 16 for details
- locking side door available, specify and add \$142 list
- ledge pulls standard, mounted vertical; prism pulls available, specify and see page 9

Description	D	W	H	CTN WT	CU FT	① Model	Laminate	Flat Cut Veneer	Double Cut Veneer
69" h Lower and Upper Hinge Door Storage Cabinet with Side Wardrobe	22	24	69	218	26	FLT2224-69F7DWR	\$2,295		
	22	24	69	218	26	FLV2224-69F7DWR		\$3,992	\$4,393
	22	24	69	218	26	FLT2224-69F7DWL	\$2,295		
	22	24	69	218	26	FLV2224-69F7DWL		\$3,992	\$4,393



right shown



left

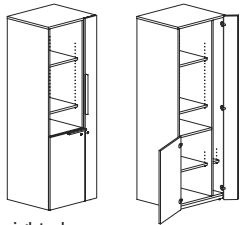
Features:

- aligns with primary height units
- upper compartment has two adjustable shelves, lower compartment has one adjustable shelf
- installed coat hook in wardrobe compartment

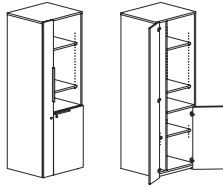
Options:

- must specify chassis grain direction on double cut veneer, see pages 13-15 for details
- veneer door fronts in paint available, specify paint color and add \$337 list; see page 16 for detail
- on laminate units, contrasting doors fronts available, no upcharge; specify color, see page 16 for details
- locking doors available, specify and add \$426 list
- ledge pulls standard, mounted vertical; prism pulls available, specify and see page 9
- pull out trash can available, specify and add \$456 list; see page 38 for details
- vanity mirror available, specify and add \$141 list

69" h Lower Hinge Door, Open Storage Cabinet with Side Wardrobe	22	24	69	201	26	FLT2224-69F70WR	\$2,208		
	22	24	69	201	26	FLV2224-69F70WR		\$3,867	\$4,253
	22	24	69	201	26	FLT2224-69F70WL	\$2,208		
	22	24	69	201	26	FLV2224-69F70WL		\$3,867	\$4,253



right shown



left

Features:

- aligns with primary height units
- upper compartment has two adjustable shelves, lower compartment has one adjustable shelf
- installed coat hook in wardrobe compartment

Options:

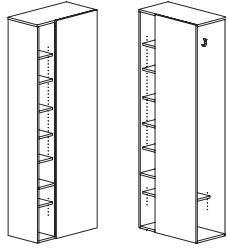
- must specify chassis grain direction on double cut veneer, see pages 13-15 for details
- veneer door fronts in paint available, specify paint color and add \$337 list; see page 16 for detail
- on laminate units, contrasting doors fronts available, no upcharge; specify color, see page 16 for details
- locking doors available, specify and add \$284 list
- ledge pulls standard, mounted vertical; prism pulls available, specify and see page 9
- pull out trash can available, specify and add \$456 list; see page 38 for details

To Order, Specify:

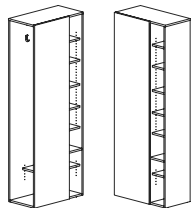
① Laminate Model #		② Laminate Selection		③ Metal Color		④ Other Product Options			
Laminate (FLT)		See Laminate Selection		See Metal Finish Color Options		See list of options for each specific unit; Specify and add accordingly.			
① Veneer Model #		② Wood Species		③ Wood Finish		④ Metal Color		⑤ Other Product Options	
Veneer (FLV)		Flat Cut CH1 Cherry MA1 Maple WA1 Walnut BO1 Black Oak		See Flat Cut Wood Finish Options		See Metal Finish Color Options		See list of options for each specific unit; Specify and add accordingly.	
		Double Cut DC1 Double Cut		See Double Cut Wood Finish Options		③a Wood Finish ③b Chassis Grain Direction For Double Cut Only: Vertical Horizontal			

FLUX - PRIVATE OFFICE

Description	D	W	H	CTN WT	CU FT	① Model	Laminate	Flat Cut Veneer	Double Cut Veneer
81" h Side Access Wardrobe with Open Shelves	15 $\frac{7}{8}$ "	36	81	211	32	FLT1636-81FSWR	\$2,390		
	15 $\frac{7}{8}$ "	36	81	211	32	FLV1636-81FSWR		\$3,819	\$4,203
	15 $\frac{7}{8}$ "	36	81	211	32	FLT1636-81FSWL	\$2,390		
	15 $\frac{7}{8}$ "	36	81	211	32	FLV1636-81FSWL		\$3,819	\$4,203
	15 $\frac{7}{8}$ "	30	81	185	27	FLT1630-81FSWR	\$2,203		
	15 $\frac{7}{8}$ "	30	81	185	27	FLV1630-81FSWR		\$3,524	\$3,877
	15 $\frac{7}{8}$ "	30	81	185	27	FLT1630-81FSWL	\$2,203		
	15 $\frac{7}{8}$ "	30	81	185	27	FLV1630-81FSWL		\$3,524	\$3,877



right shown



left

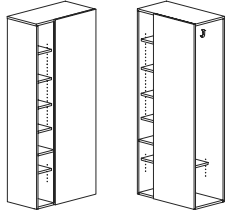
Features:

- attaching hardware included
- side entry wardrobe with two installed coat hooks and one lower adjustable shelf
- 8 1/4" w open compartment with five adjustable shelves

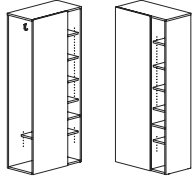
Options:

- must specify chassis grain direction on double cut veneer, see pages 13-15 for details

Description	D	W	H	CTN WT	CU FT	① Model	Laminate	Flat Cut Veneer	Double Cut Veneer
69" h Side Access Wardrobe with Open Shelves	15 7/8	36	69	184	27	FLT1636-69FSWR	\$2,199		
	15 7/8	36	69	184	27	FLV1636-69FSWR		\$3,544	\$3,899
	15 7/8	36	69	184	27	FLT1636-69FSWL	\$2,199		
	15 7/8	36	69	184	27	FLV1636-69FSWL		\$3,544	\$3,899
	15 7/8	30	69	160	23	FLT1630-69FSWR	\$2,026		
	15 7/8	30	69	160	23	FLV1630-69FSWR		\$3,265	\$3,591
	15 7/8	30	69	160	23	FLT1630-69FSWL	\$2,026		
	15 7/8	30	69	160	23	FLV1630-69FSWL		\$3,265	\$3,591



right shown



left

Features:

- attaching hardware included
- side entry wardrobe with two installed coat hooks and one lower adjustable shelf
- 8 1/4" w open compartment with four adjustable shelves

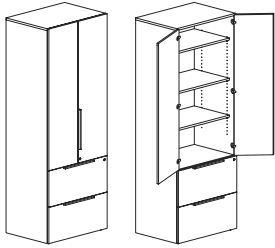
Options:

- must specify chassis grain direction on double cut veneer, see pages 13-15 for details

To Order, Specify:

① Laminate Model #		② Laminate Selection		③ Metal Color	④ Other Product Options
Laminate (FLT)		See Laminate Selection		See Metal Finish Color Options	See list of options for each specific unit; Specify and add accordingly.
① Veneer Model #	② Wood Species	③ Wood Finish		④ Metal Color	⑤ Other Product Options
Veneer (FLV)	Flat Cut CH1 Cherry MA1 Maple WA1 Walnut BO1 Black Oak	See Flat Cut Wood Finish Options		See Metal Finish Color Options	See list of options for each specific unit; Specify and add accordingly.
	Double Cut DC1 Double Cut	③a Wood Finish See Double Cut Wood Finish Options	③b Chassis Grain Direction For Double Cut Only: Vertical Horizontal		

Description	D	W	H	CTN WT	CU FT	① Model	Laminate	Flat Cut Veneer	Double Cut Veneer
81" h File/File Lateral, Storage Cabinet	22	36	81	326	44	FLT2236-81F4D	\$3,392		
	22	36	81	326	44	FLV2236-81F4D		\$5,361	\$5,898
	22	30	81	281	37	FLT2230-81F4D	\$3,212		
	22	30	81	281	37	FLV2230-81F4D		\$5,124	\$5,639



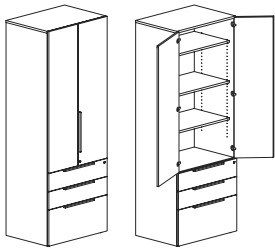
Features:

- aligns with primary height units
- pedestal front locking
- upper compartment has three adjustable shelves

Options:

- must specify chassis grain direction on double cut veneer, see pages 13-15 for details
- veneer door and drawer front in paint available, specify paint color and add \$337; see page 16 for details
- on laminate units, contrasting door and drawer fronts available, no upcharge; specify color, see page 16 for details
- locking upper doors available, specify and add \$142 list
- ledge pulls standard; prism pulls available, specify and see page 9

81" h Box/Box File Lateral, Storage Cabinet	22	36	81	326	44	FLT2236-81F3D	\$3,405		
	22	36	81	326	44	FLV2236-81F3D		\$5,374	\$5,910
	22	30	81	281	37	FLT2230-81F3D	\$3,222		
	22	30	81	281	37	FLV2230-81F3D		\$5,137	\$5,649



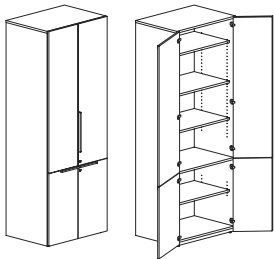
Features:

- aligns with primary height units
- pedestal front locking
- upper compartment has three adjustable shelves

Options:

- must specify chassis grain direction on double cut veneer, see pages 13-15 for details
- veneer door and drawer front in paint available, specify paint color and add \$337; see page 16 for details
- on laminate units, contrasting door and drawer fronts available, no upcharge; specify color, see page 16 for details
- locking upper doors available, specify and add \$142 list
- ledge pulls standard; prism pulls available, specify and see page 9

81" h Lower and Upper Hinge Door Storage Cabinet	22	36	81	310	44	FLT2236-81F7D	\$2,726		
	22	36	81	310	44	FLV2236-81F7D		\$4,658	\$5,123
	22	30	81	270	37	FLT2230-81F7D	\$2,560		
	22	30	81	270	37	FLV2230-81F7D		\$4,444	\$4,888



Features:

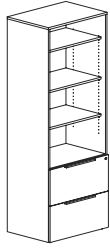
- aligns with primary height units
- upper compartment has three adjustable shelves, lower compartment has one adjustable shelf

Options:

- must specify chassis grain direction on double cut veneer, see pages 13-15 for details
- veneer door fronts in paint available, specify paint color and add \$337 list; see page 16 for details
- on laminate units, contrasting doors fronts available, no upcharge; specify color, see page 16 for details
- locking doors available, specify and add \$284 list
- ledge pulls standard, mounted vertical; prism pulls available, specify and see page 9

FLUX - PRIVATE OFFICE

Description	D	W	H	CTN WT	CU FT	① Model	Laminate	Flat Cut Veneer	Double Cut Veneer
81" h File/File Lateral, Open Storage Cabinet	22	36	81	282	44	FLT2236-81F40	\$3,194		
	22	36	81	282	44	FLV2236-81F40		\$5,099	\$5,608
	22	30	81	255	37	FLT2230-81F40	\$3,026		
	22	30	81	255	37	FLV2230-81F40		\$4,881	\$5,368



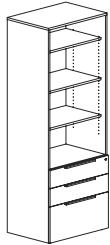
Features:

- aligns with primary height units
- pedestal front locking
- upper compartment has three adjustable shelves

Options:

- must specify chassis grain direction on double cut veneer, see pages 13-15 for details
- veneer drawer fronts in paint available, specify paint color and add \$337 list; see page 16 for details
- on laminate units, contrasting drawer fronts available, no upcharge; specify color, see page 16 for details
- ledge pulls standard; prism pulls available, specify and see page 9

81" h Box/Box/File Lateral, Open Storage Cabinet	22	36	81	282	44	FLT2236-81F30	\$3,205		
	22	36	81	282	44	FLV2236-81F30		\$5,112	\$5,623
	22	30	81	255	37	FLT2230-81F30	\$3,040		
	22	30	81	255	37	FLV2230-81F30		\$4,891	\$5,379



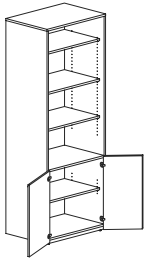
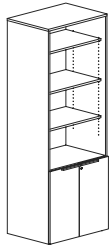
Features:

- aligns with primary height units
- pedestal front locking
- upper compartment has three adjustable shelves

Options:

- must specify chassis grain direction on double cut veneer, see pages 13-15 for details
- veneer drawer fronts in paint available, specify paint color and add \$337 list; see page 16 for details
- on laminate units, contrasting drawer fronts available, no upcharge; specify color, see page 16 for details
- ledge pulls standard; prism pulls available, specify and see page 9

81" h Lower Hinge Doors, Open Storage Cabinet	22	36	81	261	44	FLT2236-81F70	\$2,527		
	22	36	81	261	44	FLV2236-81F70		\$4,398	\$4,837
	22	30	81	233	37	FLT2230-81F70	\$2,373		
	22	30	81	233	37	FLV2230-81F70		\$4,199	\$4,619



Features:

- aligns with primary height units
- upper compartment has three adjustable shelves, lower compartment has one adjustable shelf

Options:

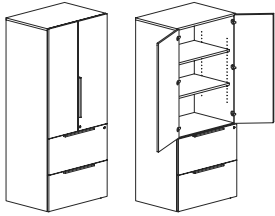
- must specify chassis grain direction on double cut veneer, see pages 13-15 for details
- veneer door fronts in paint available, specify paint color and add \$337 list; see page 16 for details
- on laminate units, contrasting doors fronts available, no upcharge; specify color, see page 16 for details
- locking lower doors available specify and add \$142 list
- ledge pulls standard; prism pulls available, specify and see page 9

To Order, Specify:

① Laminate Model #	② Laminate Selection		③ Metal Color	④ Other Product Options
Laminate (FLT)	See Laminate Selection		See Metal Finish Color Options	See list of options for each specific unit; Specify and add accordingly.

① Veneer Model #	② Wood Species	③ Wood Finish		④ Metal Color	⑤ Other Product Options
Veneer (FLV)	Flat Cut CH1 Cherry MA1 Maple WA1 Walnut BO1 Black Oak	See Flat Cut Wood Finish Options		See Metal Finish Color Options	See list of options for each specific unit; Specify and add accordingly.
		③a Wood Finish See Double Cut Wood Finish Options	③b Chassis Grain Direction For Double Cut Only: Vertical Horizontal		

Description	D	W	H	CTN WT	CU FT	① Model	Laminate	Flat Cut Veneer	Double Cut Veneer
69" h File/File Lateral, Storage Cabinet	22	36	69	305	38	FLT2236-69F4D	\$3,095		
	22	36	69	305	38	FLV2236-69F4D		\$4,937	\$5,429
	22	30	69	262	32	FLT2230-69F4D	\$2,943		
	22	30	69	262	32	FLV2230-69F4D		\$4,739	\$5,213



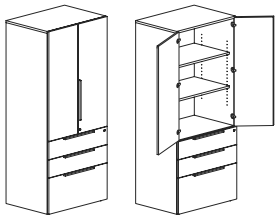
Features:

- aligns with primary height units
- upper compartment has two adjustable shelves

Options:

- must specify chassis grain direction on double cut veneer, see pages 13-15 for details
- veneer door and drawer front in paint available, specify paint color and add \$337; see page 16 for details
- on laminate units, contrasting door and drawer fronts available, no upcharge; specify color, see page 16 for details
- locking upper doors available, specify and add \$142 list
- ledge pulls standard; prism pulls available, specify and see page 9

69" h Box/Box/File Lateral, Storage Cabinet	22	36	69	303	38	FLT2236-69F3D	\$3,108		
	22	36	69	303	38	FLV2236-69F3D		\$4,950	\$5,445
	22	30	69	265	32	FLT2230-69F3D	\$2,955		
	22	30	69	265	32	FLV2230-69F3D		\$4,750	\$5,227



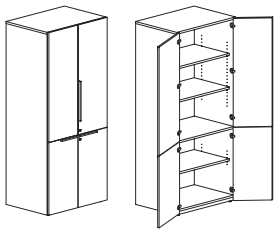
Features:

- aligns with primary height units
- pedestal front locking
- upper compartment has two adjustable shelves

Options:

- must specify chassis grain direction on double cut veneer, see pages 13-15 for details
- veneer door and drawer front in paint available, specify paint color and add \$337; see page 16 for details
- on laminate units, contrasting door and drawer fronts available, no upcharge; specify color, see page 16 for details
- locking upper doors available, specify and add \$142 list
- ledge pulls standard; prism pulls available, specify and see page 9

69" h Lower and Upper Hinge Door Storage Cabinet	22	36	69	267	38	FLT2236-69F7D	\$2,429		
	22	36	69	267	38	FLV2236-69F7D		\$4,234	\$4,658
	22	30	69	232	32	FLT2230-69F7D	\$2,290		
	22	30	69	232	32	FLV2230-69F7D		\$4,058	\$4,464



Features:

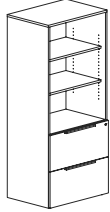
- aligns with primary height units
- upper compartment has two adjustable shelves, lower compartment has one adjustable shelf

Options:

- must specify chassis grain direction on double cut veneer, see pages 13-15 for details
- veneer door fronts in paint available, specify paint color and add \$337 list; see page 16 for details
- on laminate units, contrasting doors fronts available, no upcharge; specify color, see page 16 for details
- locking doors available, specify and add \$284 list
- ledge pulls standard; prism pulls available, specify and see page 9

FLUX - PRIVATE OFFICE

Description	D	W	H	CTN WT	CU FT	① Model	Laminate	Flat Cut Veneer	Double Cut Veneer
69" h File/File Lateral, Open Storage Cabinet	22	36	69	262	37	FLT2236-69F40	\$2,933		
	22	36	69	262	37	FLV2236-69F40		\$4,726	\$5,199
	22	30	69	225	32	FLT2230-69F40	\$2,790		
	22	30	69	225	32	FLV2230-69F40		\$4,726	\$5,199



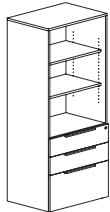
Features:

- aligns with primary height units
- pedestal front locking
- upper compartment has two adjustable shelves

Options:

- must specify chassis grain direction on double cut veneer, see pages 13-15 for details
- veneer drawer fronts in paint available, specify paint color and add \$337 list; see page 16 for details
- on laminate units, contrasting drawer fronts available, no upcharge; specify color, see page 16 for details
- ledge pulls standard; prism pulls available, specify and see page 9

69" h Box/Box/File Lateral, Open Storage Cabinet	22	36	69	261	37	FLT2236-69F30	\$2,943		
	22	36	69	261	37	FLV2236-69F30		\$4,736	\$5,212
	22	30	69	228	32	FLT2230-69F30	\$2,801		
	22	30	69	228	32	FLV2230-69F30		\$4,550	\$5,009



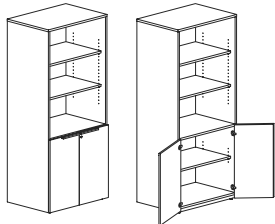
Features:

- aligns with primary height units
- pedestal front locking
- upper compartment has two adjustable shelves

Options:

- must specify chassis grain direction on double cut veneer, see pages 13-15 for details
- veneer drawer fronts in paint available, specify paint color and add \$337 list; see page 16 for details
- on laminate units, contrasting drawer fronts available, no upcharge; specify color, see page 16 for details
- ledge pulls standard; prism pulls available, specify and see page 9

69" h Lower Hinge Doors, Open Storage Cabinet	22	36	69	266	38	FLT2236-69F70	\$2,264		
	22	36	69	266	38	FLV2236-69F70		\$4,023	\$4,424
	22	30	69	204	32	FLT2230-69F70	\$2,135		
	22	30	69	204	32	FLV2230-69F70		\$3,857	\$4,246



Features:

- aligns with primary height units
- upper compartment has two adjustable shelves, lower compartment has one adjustable shelf

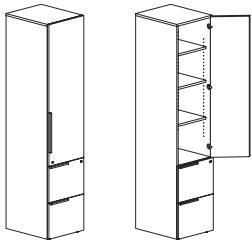
Options:

- must specify chassis grain direction on double cut veneer, see pages 13-15 for details
- veneer door fronts in paint available, specify paint color and add \$337 list; see page 16 for details
- on laminate units, contrasting doors fronts available, no upcharge; specify color, see page 16 for details
- locking lower doors available specify and add \$142 list
- ledge pulls standard; prism pulls available, specify and see page 9

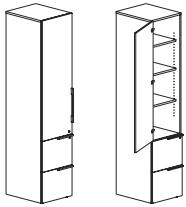
To Order, Specify:

① Laminate Model #		② Laminate Selection		③ Metal Color	④ Other Product Options
Laminate (FLT)		See Laminate Selection		See Metal Finish Color Options	See list of options for each specific unit; Specify and add accordingly.
① Veneer Model #	② Wood Species	③ Wood Finish		④ Metal Color	⑤ Other Product Options
Veneer (FLV)	Flat Cut CH1 Cherry MA1 Maple WA1 Walnut BO1 Black Oak	See Flat Cut Wood Finish Options		See Metal Finish Color Options	See list of options for each specific unit; Specify and add accordingly.
		③a Wood Finish	③b Chassis Grain Direction		
	Double Cut DC1 Double Cut	See Double Cut Wood Finish Options	For Double Cut Only: Vertical Horizontal		

Description	D	W	H	CTN WT	CU FT	① Model	Laminate	Flat Cut Veneer	Double Cut Veneer
81" h File/File, Storage Cabinet	22	18	81	209	24	FLT2218-81F2DR	\$2,530		
	22	18	81	209	24	FLV2218-81F2DR		\$3,973	\$4,370
	22	18	81	209	24	FLT2218-81F2DL	\$2,530		
	22	18	81	209	24	FLV2218-81F2DL		\$3,973	\$4,370



right shown



left

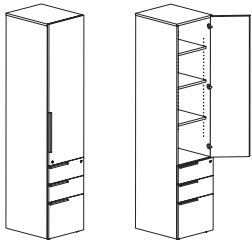
Features:

- aligns with primary height units
- pedestal front locking
- upper compartment has three adjustable shelves

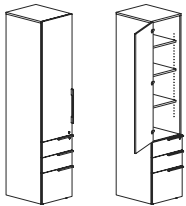
Options:

- must specify chassis grain direction on double cut veneer, see pages 13-15 for details
- veneer door and drawer front in paint available, specify paint color and add \$337; see page 16 for details
- on laminate units, contrasting door and drawer fronts available, no upcharge; specify color, see page 16 for details
- locking upper door available, specify and add \$142 list
- ledge pulls standard; prism pulls available, specify and see page 9
- vanity mirror available, specify and add \$141 list

81" h Box/Box/File, Storage Cabinet	22	18	81	210	24	FLT2218-81F1DR	\$2,539		
	22	18	81	210	24	FLV2218-81F1DR		\$3,982	\$4,379
	22	18	81	210	24	FLT2218-81F1DL	\$2,539		
	22	18	81	210	24	FLV2218-81F1DL		\$3,982	\$4,379



right shown



left

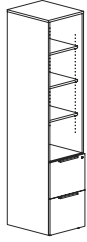
Features:

- aligns with primary height units
- pedestal front locking
- upper compartment has three adjustable shelves

Options:

- must specify chassis grain direction on double cut veneer, see pages 13-15 for details
- veneer door and drawer front in paint available, specify paint color and add \$337; see page 16 for details
- on laminate units, contrasting door and drawer fronts available, no upcharge; specify color, see page 16 for details
- locking upper door available, specify and add \$142 list
- ledge pulls standard; prism pulls available, specify and see page 9
- vanity mirror available, specify and add \$141 list

Description	D	W	H	CTN WT	CU FT	① Model	Laminate	Flat Cut Veneer	Double Cut Veneer
81" h File/File, Open Storage Cabinet	22	18	81	187	24	FLT2218-81F20	\$2,423		
	22	18	81	187	24	FLV2218-81F20		\$3,816	\$4,198



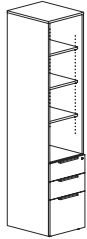
Features:

- aligns with primary height units
- pedestal front locking
- upper compartment has three adjustable shelves

Options:

- must specify chassis grain direction on double cut veneer, see pages 13-15 for details
- veneer drawer fronts in paint available, specify paint color and add \$337 list; see page 16 for details
- on laminate units, contrasting drawer fronts available, no upcharge; specify color, see page 16 for details
- ledge pulls standard; prism pulls available, specify and see page 9

81" h Box/Box/File, Open Storage Cabinet	22	18	81	187	24	FLT2218-81F10	\$2,430		
	22	18	81	187	24	FLV2218-81F10		\$3,825	\$4,207



Features:

- aligns with primary height units
- pedestal front locking
- upper compartment has three adjustable shelves

Options:

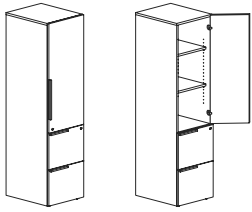
- must specify chassis grain direction on double cut veneer, see pages 13-15 for details
- veneer drawer fronts in paint available, specify paint color and add \$337 list; see page 16 for details
- on laminate units, contrasting drawer fronts available, no upcharge; specify color, see page 16 for details
- ledge pulls standard; prism pulls available, specify and see page 9

FLUX - PRIVATE OFFICE

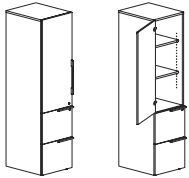
To Order, Specify:

① Laminate Model #		② Laminate Selection		③ Metal Color	④ Other Product Options
Laminate (FLT)		See Laminate Selection		See Metal Finish Color Options	See list of options for each specific unit; Specify and add accordingly.
① Veneer Model #	② Wood Species	③ Wood Finish		④ Metal Color	⑤ Other Product Options
Veneer (FLV)	Flat Cut CH1 Cherry MA1 Maple WA1 Walnut BO1 Black Oak	See Flat Cut Wood Finish Options		See Metal Finish Color Options	See list of options for each specific unit; Specify and add accordingly.
	Double Cut DC1 Double Cut	3a Wood Finish See Double Cut Wood Finish Options	3b Chassis Grain Direction For Double Cut Only: Vertical Horizontal		

Description	D	W	H	CTN WT	CU FT	① Model	Laminate	Flat Cut Veneer	Double Cut Veneer
69" h File/File, Storage Cabinet	22	18	69	192	20	FLT2218-69F2DR	\$2,337		
	22	18	69	192	20	FLV2218-69F2DR		\$3,699	\$4,069
	22	18	69	192	20	FLT2218-69F2DL	\$2,337		
	22	18	69	192	20	FLV2218-69F2DL		\$3,699	\$4,069



right shown



left

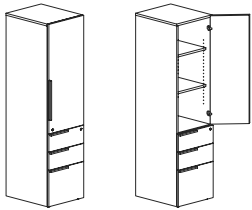
Features:

- aligns with primary height units
- pedestal front locking
- upper compartment has two adjustable shelves

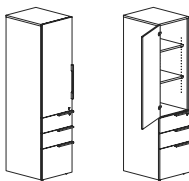
Options:

- must specify chassis grain direction on double cut veneer, see pages 13-15 for details
- veneer door and drawer front in paint available, specify paint color and add \$337; see page 16 for details
- on laminate units, contrasting door and drawer fronts available, no upcharge; specify color, see page 16 for details
- locking upper door available, specify and add \$142 list
- ledge pulls standard; prism pulls available, specify and see page 9
- vanity mirror available, specify and add \$141 list

69" h Box/Box/File, Storage Cabinet	22	18	69	192	20	FLT2218-69F1DR	\$2,347		
	22	18	69	192	20	FLV2218-69F1DR		\$3,706	\$4,077
	22	18	69	192	20	FLT2218-69F1DL	\$2,347		
	22	18	69	192	20	FLV2218-69F1DL		\$3,706	\$4,077



right shown



left

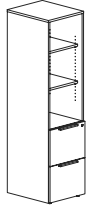
Features:

- aligns with primary height units
- pedestal front locking
- upper compartment has two adjustable shelves

Options:

- must specify chassis grain direction on double cut veneer, see pages 13-15 for details
- veneer door and drawer front in paint available, specify paint color and add \$337; see page 16 for details
- on laminate units, contrasting door and drawer fronts available, no upcharge; specify color, see page 16 for details
- locking upper door available, specify and add \$142 list
- ledge pulls standard; prism pulls available, specify and see page 9
- vanity mirror available, specify and add \$141 list

Description	D	W	H	CTN WT	CU FT	① Model	Laminate	Flat Cut Veneer	Double Cut Veneer
69" h File/File, Open Storage Cabinet	22	18	69	166	20	FLT2218-69F20	\$2,252		
	22	18	69	166	20	FLV2218-69F20		\$3,574	\$3,932



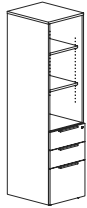
Features:

- aligns with primary height units
- pedestal front locking
- upper compartment has two adjustable shelves

Options:

- must specify chassis grain direction on double cut veneer, see pages 13-15 for details
- veneer drawer fronts in paint available, specify paint color and add \$337 list; see page 16 for details
- on laminate units, contrasting drawer fronts available, no upcharge; specify color, see page 16 for details
- ledge pulls standard; prism pulls available, specify and see page 9

69" h Box/Box/File, Open Storage Cabinet	22	18	69	166	20	FLT2218-69F10	\$2,260		
	22	18	69	166	20	FLV2218-69F10		\$3,583	\$3,941



Features:

- aligns with primary height units
- pedestal front locking
- upper compartment has two adjustable shelves

Options:

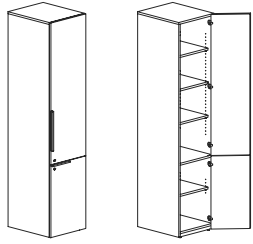
- must specify chassis grain direction on double cut veneer, see pages 13-15 for details
- veneer drawer fronts in paint available, specify paint color and add \$337 list; see page 16 for details
- on laminate units, contrasting drawer fronts available, no upcharge; specify color, see page 16 for details
- ledge pulls standard; prism pulls available, specify and see page 9

FLUX - PRIVATE OFFICE

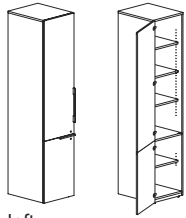
To Order, Specify:

① Laminate Model #		② Laminate Selection		③ Metal Color	④ Other Product Options
Laminate (FLT)		See Laminate Selection		See Metal Finish Color Options	See list of options for each specific unit; Specify and add accordingly.
① Veneer Model #	② Wood Species	③ Wood Finish		④ Metal Color	⑤ Other Product Options
Veneer (FLV)	Flat Cut CH1 Cherry MA1 Maple WA1 Walnut BO1 Black Oak	See Flat Cut Wood Finish Options		See Metal Finish Color Options	See list of options for each specific unit; Specify and add accordingly.
		3a Wood Finish	3b Chassis Grain Direction		
	Double Cut DC1 Double Cut	See Double Cut Wood Finish Options	For Double Cut Only: Vertical Horizontal		

Description	D	W	H	CTN WT	CU FT	① Model	Laminate	Flat Cut Veneer	Double Cut Veneer
81" h Lower and Upper Hinge Storage Cabinet	22	18	81	188	24	FLT2218-81F7DR	\$1,910		
	22	18	81	188	24	FLV2218-81F7DR		\$3,319	\$3,652
	22	18	81	188	24	FLT2218-81F7DL	\$1,910		
	22	18	81	188	24	FLV2218-81F7DL		\$3,319	\$3,652



right shown



left

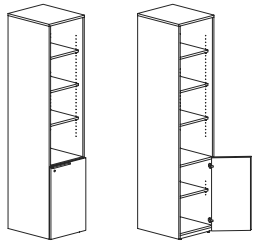
Features:

- aligns with primary height units
- upper compartment has three adjustable shelves, lower compartment has one adjustable shelf

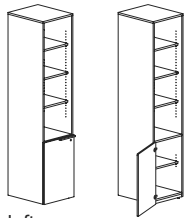
Options:

- must specify chassis grain direction on double cut veneer, see pages 13-15 for details
- veneer door front in paint available, specify paint color and add \$337 list; see page 16 for details
- on laminate units, contrasting doors fronts available, no upcharge; specify color, see page 16 for details
- locking doors available, specify and add \$284 list
- ledge pulls standard, mounted vertical; prism pulls available, specify and see page 9
- pull out trash can available, specify and add \$456 list; see page 38 for details
- vanity mirror available, specify and add \$141 list

81" h Lower Hinge Door, Open Storage Cabinet	22	18	81	166	24	FLT2218-81F70R	\$1,803		
	22	18	81	166	24	FLV2218-81F70R		\$3,162	\$3,479
	22	18	81	166	24	FLT2218-81F70L	\$1,803		
	22	18	81	166	24	FLV2218-81F70L		\$3,162	\$3,479



right shown



left

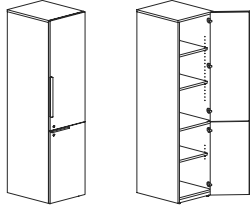
Features:

- aligns with primary height units
- upper compartment has three adjustable shelves, lower compartment has one adjustable shelf

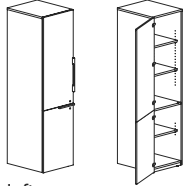
Options:

- must specify chassis grain direction on double cut veneer, see pages 13-15 for details
- veneer door front in paint available, specify paint color and add \$337 list; see page 16 for details
- on laminate units, contrasting doors fronts available, no upcharge; specify color, see page 16 for details
- locking lower door available, specify and add \$142 list
- ledge pulls standard; prism pulls available, specify and see page 9
- pull out trash can available, specify and add \$456 list; see page 38 for details

Description	D	W	H	CTN WT	CU FT	① Model	Laminate	Flat Cut Veneer	Double Cut Veneer
69" h Lower and Upper Hinge Door Storage Cabinet	22	18	69	163	20	FLT2218-69F7DR	\$1,719		
	22	18	69	163	20	FLV2218-69F7DR		\$3,046	\$3,349
	22	18	69	163	20	FLT2218-69F7DL	\$1,719		
	22	18	69	163	20	FLV2218-69F7DL		\$3,046	\$3,349



right shown



left

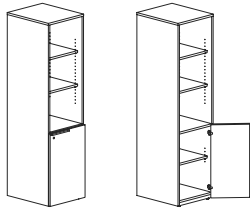
Features:

- aligns with primary height units
- upper compartment has two adjustable shelves, lower compartment has one adjustable shelf

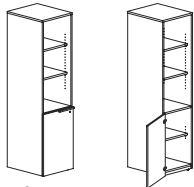
Options:

- must specify chassis grain direction on double cut veneer, see pages 13-15 for details
- veneer door front in paint available, specify paint color and add \$337 list; see page 16 for details
- on laminate units, contrasting doors fronts available, no upcharge; specify color, see page 16 for details
- locking doors available, specify and add \$284 list
- ledge pulls standard, mounted vertical; prism pulls available, specify and see page 9
- pull out trash can available, specify and add \$456 list; see page 38 for details
- vanity mirror available, specify and add \$141 list

69" h Lower Hinge Door, Open Storage Cabinet	22	18	69	145	20	FLT2218-69F70R	\$1,630		
	22	18	69	145	20	FLV2218-69F70R		\$2,920	\$3,212
	22	18	69	145	20	FLT2218-69F70L	\$1,630		
	22	18	69	145	20	FLV2218-69F70L		\$2,920	\$3,212



right shown



left

Features:

- aligns with primary height units
- upper compartment has two adjustable shelves

Options:

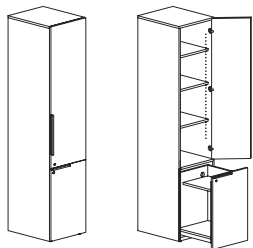
- must specify chassis grain direction on double cut veneer, see pages 13-15 for details
- veneer door front in paint available, specify paint color and add \$337 list; see page 16 for details
- on laminate units, contrasting doors fronts available, no upcharge; specify color, see page 16 for details
- locking lower door available, specify and add \$142 list
- ledge pulls standard; prism pulls available, specify and see page 9
- pull out trash can available, specify and add \$456 list; see page 38 for details

To Order, Specify:

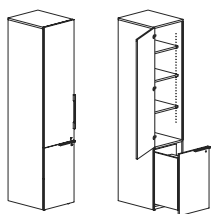
① Laminate Model #		② Laminate Selection		③ Metal Color	④ Other Product Options
Laminate (FLT)		See Laminate Selection		See Metal Finish Color Options	See list of options for each specific unit; Specify and add accordingly.
① Veneer Model #	② Wood Species	③ Wood Finish		④ Metal Color	⑤ Other Product Options
Veneer (FLV)	Flat Cut CH1 Cherry MA1 Maple WA1 Walnut BO1 Black Oak	See Flat Cut Wood Finish Options		See Metal Finish Color Options	See list of options for each specific unit; Specify and add accordingly.
	Double Cut DC1 Double Cut	3a Wood Finish See Double Cut Wood Finish Options	3b Chassis Grain Direction For Double Cut Only: Vertical Horizontal		

FLUX - PRIVATE OFFICE

Description	D	W	H	CTN WT	CU FT	① Model	Laminate	Flat Cut Veneer	Double Cut Veneer
81" h Pantry Drawer, Storage Cabinet	22	18	81	227	24	FLT2218-81FADR	\$2,674		
	22	18	81	227	24	FLV2218-81FADR		\$4,115	\$4,527
	22	18	81	227	24	FLT2218-81FADL	\$2,674		
	22	18	81	227	24	FLV2218-81FADL		\$4,115	\$4,527



right shown



left

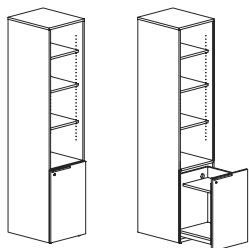
Features:

- aligns with primary height units
- concealed caster under drawer for added support
- upper compartment has three adjustable shelves
- oval back panel grommet standard with installed power unit
- pantry drawer front locking

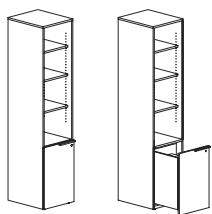
Options:

- must specify chassis grain direction on double cut veneer, see pages 13-15 for details
- veneer door and drawer front in paint available, specify paint color and add \$337; see page 16 for details
- on laminate units, contrasting door and drawer fronts available, no upcharge; specify color, see page 16 for details
- locking door available, specify and add \$142 list
- ledge pulls standard; prism pulls available, specify and see page 9
- power unit (2 simplex and 2 USB charging ports) available, specify and add \$914 list; see page 38 for details
- vanity mirror available, specify and add \$141 list

81" h Pantry Drawer, Open Storage Cabinet	22	18	81	196	24	FLT2218-81FA0R	\$2,565		
	22	18	81	196	24	FLV2218-81FA0R		\$3,924	\$4,319
	22	18	81	196	24	FLT2218-81FA0L	\$2,565		
	22	18	81	196	24	FLV2218-81FA0L		\$3,924	\$4,319



right shown



left

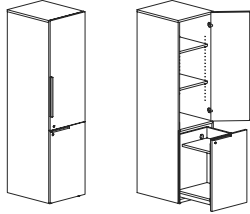
Features:

- aligns with primary height units
- concealed caster under drawer for added support
- upper compartment has three adjustable shelves
- oval back panel grommet standard with installed power unit
- pantry drawer front locking

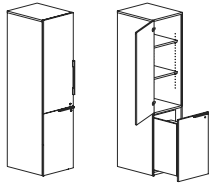
Options:

- must specify chassis grain direction on double cut veneer, see pages 13-15 for details
- veneer drawer fronts in paint available, specify paint color and add \$337 list; see page 16 for details
- on laminate units, contrasting door front available, no upcharge; specify color, see page 16 for details
- ledge pulls standard; prism pulls available, specify and see page 9
- power unit (2 simplex and 2 USB charging ports) available, specify and add \$914 list; see page 38 for details

Description	D	W	H	CTN WT	CU FT	① Model	Laminate	Flat Cut Veneer	Double Cut Veneer
69" h Pantry Drawer, Storage Cabinet	22	18	69	192	20	FLT2218-69FADR	\$2,481		
	22	18	69	192	20	FLV2218-69FADR		\$3,841	\$4,225
	22	18	69	192	20	FLT2218-69FADL	\$2,481		
	22	18	69	192	20	FLV2218-69FADL		\$3,841	\$4,225



right shown



left

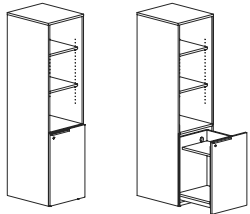
Features:

- aligns with primary height units
- concealed caster under drawer for added support
- upper compartment has two adjustable shelves
- oval back panel grommet standard with installed power unit
- pantry drawer front locking

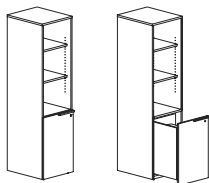
Options:

- must specify chassis grain direction on double cut veneer, see pages 13-15 for details
- veneer door and drawer front in paint available, specify paint color and add \$337; see page 16 for details
- on laminate units, contrasting door and drawer fronts available, no upcharge; specify color, see page 16 for details
- locking door available, specify and add \$142 list
- ledge pulls standard, mounted vertical; prism pulls available, specify and see page 9
- power unit (2 simplex and 2 USB charging ports) available, specify and add \$914 list; see page 38 for details
- vanity mirror available, specify and add \$141 list

69" h Pantry Drawer, Open Storage Cabinet	22	18	69	173	20	FLT2218-69FAOR	\$2,393		
	22	18	69	173	20	FLV2218-69FAOR		\$3,717	\$4,089
	22	18	69	173	20	FLT2218-69FAOL	\$2,393		
	22	18	69	173	20	FLV2218-69FAOL		\$3,717	\$4,089



right shown



left

Features:

- aligns with primary height units
- concealed caster under drawer for added support
- upper compartment has two adjustable shelves
- oval back panel grommet standard with installed power unit
- pantry drawer front locking

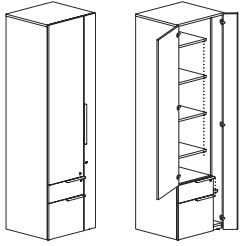
Options:

- must specify chassis grain direction on double cut veneer, see pages 13-15 for details
- veneer drawer fronts in paint available, specify paint color and add \$337 list; see page 16 for details
- on laminate units, contrasting door front available, no upcharge; specify color, see page 16 for details
- ledge pulls standard; prism pulls available, specify and see page 9
- power unit (2 simplex and 2 USB charging ports) available, specify and add \$914 list; see page 38 for details

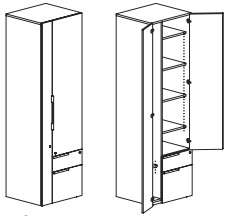
To Order, Specify:

① Laminate Model #		② Laminate Selection		③ Metal Color	④ Other Product Options			
Laminate (FLT)		See Laminate Selection		See Metal Finish Color Options	See list of options for each specific unit; Specify and add accordingly.			
① Veneer Model #	② Wood Species	③ Wood Finish		④ Metal Color	⑤ Other Product Options			
Veneer (FLV)	Flat Cut CH1 Cherry MA1 Maple WA1 Walnut BO1 Black Oak	See Flat Cut Wood Finish Options		See Metal Finish Color Options	See list of options for each specific unit; Specify and add accordingly.			
	Double Cut DC1 Double Cut	<table border="1"> <tr> <th>Ⓐ Wood Finish</th> <th>Ⓑ Chassis Grain Direction</th> </tr> <tr> <td>See Double Cut Wood Finish Options</td> <td>For Double Cut Only: Vertical Horizontal</td> </tr> </table>	Ⓐ Wood Finish	Ⓑ Chassis Grain Direction	See Double Cut Wood Finish Options	For Double Cut Only: Vertical Horizontal		
Ⓐ Wood Finish	Ⓑ Chassis Grain Direction							
See Double Cut Wood Finish Options	For Double Cut Only: Vertical Horizontal							

Description	D	W	H	CTN WT	CU FT	① Model	Laminate	Flat Cut Veneer	Double Cut Veneer
81" h Box/File, Storage Cabinet with Side Wardrobe	22	24	81	275	30	FLT2224-81F5DWR	\$3,102		
	22	24	81	275	30	FLV2224-81F5DWR		\$4,954	\$5,450
	22	24	81	275	30	FLT2224-81F5DWL	\$3,102		
	22	24	81	275	30	FLV2224-81F5DWL		\$4,954	\$5,450



right shown



left

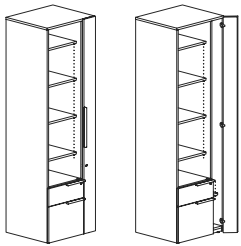
Features:

- aligns with secondary height units
- pedestal front locking
- upper compartment has four adjustable shelves
- installed coat hook in wardrobe compartment

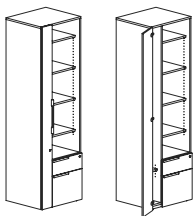
Options:

- must specify chassis grain direction on double cut veneer, see pages 13-15 for details
- veneer door and drawer front in paint available, specify paint color and add \$337; see page 16 for details
- on laminate units, contrasting door and drawer fronts available, no upcharge; specify color, see page 16 for details
- locking doors available, specify and add \$284 list
- ledge pulls standard; prism pulls available, specify and see page 9

81" h Box/File, Open Storage Cabinet with Side Wardrobe	22	24	81	250	30	FLT2224-81F50WR	\$2,997		
	22	24	81	250	30	FLV2224-81F50WR		\$4,797	\$5,277
	22	24	81	250	30	FLT2224-81F50WL	\$2,997		
	22	24	81	250	30	FLV2224-81F50WL		\$4,797	\$5,277



right shown



left

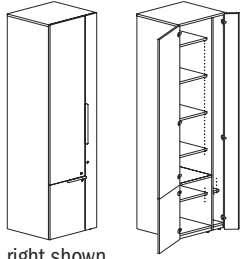
Features:

- aligns with secondary height units
- pedestal front locking
- upper compartment has four adjustable shelves
- installed coat hook in wardrobe compartment

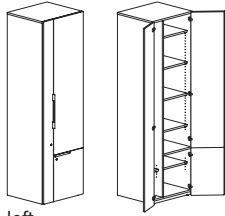
Options:

- must specify chassis grain direction on double cut veneer, see pages 13-15 for details
- veneer door and drawer front in paint available, specify paint color and add \$337; see page 16 for details
- on laminate units, contrasting door and drawer fronts available, no upcharge; specify color, see page 16 for details
- locking door available, specify and add \$142 list
- ledge pulls standard; prism pulls available, specify and see page 9

Description	D	W	H	CTN WT	CU FT	1 Model	Laminate	Flat Cut Veneer	Double Cut Veneer
81" h Lower and Upper Hinge Door Storage Cabinet with Side Wardrobe	22	24	81	260	30	FLT2224-81F8DWR	\$2,488		
	22	24	81	260	30	FLV2224-81F8DWR		\$4,266	\$4,693
	22	24	81	260	30	FLT2224-81F8DWL	\$2,488		
	22	24	81	260	30	FLV2224-81F8DWL		\$4,266	\$4,693



right shown



left

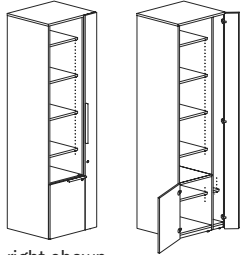
Features:

- aligns with secondary height units
- upper compartment has three adjustable shelves, lower compartment has one adjustable shelf
- installed coat hook in wardrobe compartment

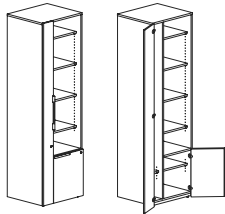
Options:

- must specify chassis grain direction on double cut veneer, see pages 13-15 for details
- veneer door fronts in paint available, specify paint color and add \$337 list; see page 16 for detail
- on laminate units, contrasting doors fronts available, no upcharge; specify color, see page 16 for details
- locking doors available, specify and add \$426 list
- ledge pulls standard; prism pulls available, specify and see page 9
- vanity mirror available, specify and add \$141 list

81" h Lower Hinge Door, Open Storage Cabinet with Side Wardrobe	22	24	81	236	30	FLT2224-81F8OWR	\$2,378		
	22	24	81	236	30	FLV2224-81F8OWR		\$4,110	\$4,522
	22	24	81	236	30	FLT2224-81F8OWL	\$2,378		
	22	24	81	236	30	FLV2224-81F8OWL		\$4,110	\$4,522



right shown



left

Features:

- aligns with secondary height units
- upper compartment has four adjustable shelves
- installed coat hook in wardrobe compartment

Options:

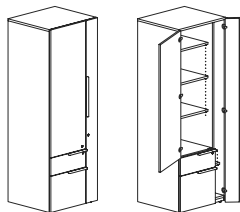
- must specify chassis grain direction on double cut veneer, see pages 13-15 for details
- veneer door fronts in paint available, specify paint color and add \$337 list; see page 16 for detail
- on laminate units, contrasting doors fronts available, no upcharge; specify color, see page 16 for details
- locking doors available, specify and add \$284 list
- ledge pulls standard; prism pulls available, specify and see page 9

To Order, Specify:

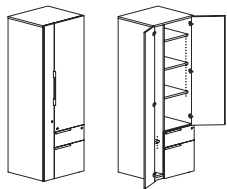
1 Laminate Model #	2 Laminate Type	3 Laminate Selection	4 Metal Color	5 Other Product Options
Laminate (FLT)	HPL	See Laminate Selection	See Metal Finish Color Options	See list of options for each specific unit; Specify and add accordingly.

1 Veneer Model #	2 Wood Species	3 Wood Finish - Finishes with an asterisk (*) have a coordinating laminate available	4 Metal Color	5 Other Product Options	
Veneer (FLV)	Flat Cut CH1 Cherry MA1 Maple WA1 Walnut BO1 Black Oak	See Flat Cut Wood Finish Options	See Metal Finish Color Options	See list of options for each specific unit; Specify and add accordingly.	
	Double Cut DC1 Double Cut	<table border="1"> <thead> <tr> <th>3a Wood Finish</th> <th>3b Chassis Grain Direction</th> </tr> </thead> <tbody> <tr> <td>See Double Cut Wood Finish Options</td> <td>For Double Cut Only: Vertical Horizontal</td> </tr> </tbody> </table>			3a Wood Finish
3a Wood Finish	3b Chassis Grain Direction				
See Double Cut Wood Finish Options	For Double Cut Only: Vertical Horizontal				

Description	D	W	H	CTN WT	CU FT	① Model	Laminate	Flat Cut Veneer	Double Cut Veneer
69" h Box/File, Storage Cabinet with Side Wardrobe	22	24	69	233	26	FLT2224-69F5DWR	\$2,910		
	22	24	69	233	26	FLV2224-69F5DWR		\$4,680	\$5,147
	22	24	69	233	26	FLT2224-69F5DWL	\$2,910		
	22	24	69	233	26	FLV2224-69F5DWL		\$4,680	\$5,147



right shown



left

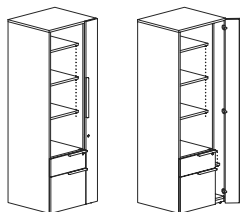
Features:

- aligns with secondary height units
- pedestal front locking
- upper compartment has three adjustable shelves
- installed coat hook in wardrobe compartment

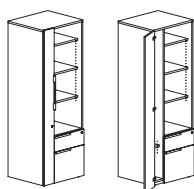
Options:

- must specify chassis grain direction on double cut veneer, see pages 13-15 for details
- veneer door and drawer front in paint available, specify paint color and add \$337; see page 16 for details
- on laminate units, contrasting door and drawer fronts available, no upcharge; specify color, see page 16 for details
- locking doors available, specify and add \$284 list
- ledge pulls standard; prism pulls available, specify and see page 9
- vanity mirror available, specify and add \$141 list

69" h Box/File, Open Storage Cabinet with Side Wardrobe	22	24	69	214	26	FLT2224-69F50WR	\$2,825		
	22	24	69	214	26	FLV2224-69F50WR		\$4,555	\$5,012
	22	24	69	214	26	FLT2224-69F50WL	\$2,825		
	22	24	69	214	26	FLV2224-69F50WL		\$4,555	\$5,012



right shown



left

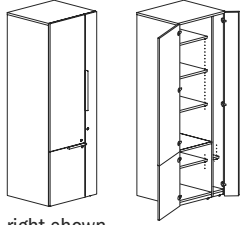
Features:

- aligns with secondary height units
- pedestal front locking
- upper compartment has three adjustable shelves
- installed coat hook in wardrobe compartment

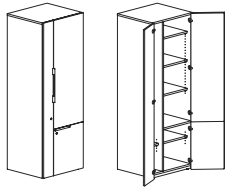
Options:

- must specify chassis grain direction on double cut veneer, see pages 13-15 for details
- veneer door and drawer front in paint available, specify paint color and add \$337; see page 16 for details
- on laminate units, contrasting door and drawer fronts available, no upcharge; specify color, see page 16 for details
- locking side door available, specify and add \$142 list
- ledge pulls standard; prism pulls available, specify and see page 9

Description	D	W	H	CTN WT	CU FT	① Model	Laminate	Flat Cut Veneer	Double Cut Veneer
69" Lower and Upper Hinge	22	24	69	219	26	FLT2224-69F8DWR	\$2,295		
Door Storage Cabinet with Side Wardrobe	22	24	69	219	26	FLV2224-69F8DWR		\$3,992	\$4,393
	22	24	69	219	26	FLT2224-69F8DWL	\$2,295		
	22	24	69	219	26	FLV2224-69F8DWL		\$3,992	\$4,393



right shown



left

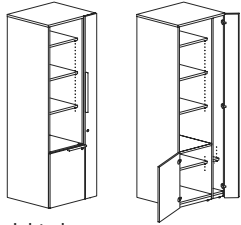
Features:

- aligns with secondary height units
- upper compartment has three adjustable shelves, lower compartment has one adjustable shelf
- installed coat hook in wardrobe compartment

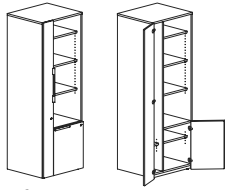
Options:

- must specify chassis grain direction on double cut veneer, see pages 13-15 for details
- veneer door fronts in paint available, specify paint color and add \$337 list; see page 16 for detail
- on laminate units, contrasting door and drawer fronts available, no upcharge; specify color, see page 16 for details
- locking doors available, specify and add \$426 list
- ledge pulls standard; prism pulls available, specify and see page 9
- vanity mirror available, specify and add \$141 list

69" Lower Hinge Door, Open Storage Cabinet with Side Wardrobe	22	24	69	199	26	FLT2224-69F8OWR	\$2,208		
	22	24	69	199	26	FLV2224-69F8OWR		\$3,867	\$4,253
	22	24	69	199	26	FLT2224-69F8OWL	\$2,208		
	22	24	69	199	26	FLV2224-69F8OWL		\$3,867	\$4,253



right shown



left

Features:

- aligns with secondary height units
- upper compartment has three adjustable shelves, lower compartment has one adjustable shelf
- installed coat hook in wardrobe compartment

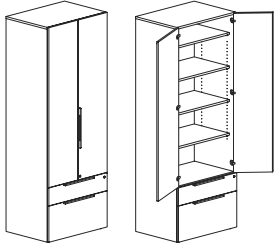
Options:

- must specify chassis grain direction on double cut veneer, see pages 13-15 for details
- veneer door fronts in paint available, specify paint color and add \$337 list; see page 16 for detail
- on laminate units, contrasting doors fronts available, no upcharge; specify color, see page 16 for details
- locking doors available, specify and add \$284 list
- ledge pulls standard; prism pulls available, specify and see page 9

To Order, Specify:

① Laminate Model #		② Laminate Selection		③ Metal Color	④ Other Product Options
Laminate (FLT)		See Laminate Selection		See Metal Finish Color Options	See list of options for each specific unit; Specify and add accordingly.
① Veneer Model #	② Wood Species	③ Wood Finish		④ Metal Color	⑤ Other Product Options
Veneer (FLV)	Flat Cut CH1 Cherry MA1 Maple WA1 Walnut BO1 Black Oak	See Flat Cut Wood Finish Options		See Metal Finish Color Options	See list of options for each specific unit; Specify and add accordingly.
		3a Wood Finish See Double Cut Wood Finish Options	3b Chassis Grain Direction For Double Cut Only: Vertical Horizontal		

Description	D	W	H	CTN WT	CU FT	① Model	Laminate	Flat Cut Veneer	Double Cut Veneer
81" h Box/ File Lateral, Storage Cabinet	22	36	81	342	44	FLT2236-81F6D	\$3,289		
	22	36	81	342	44	FLV2236-81F6D		\$5,258	\$5,784
	22	30	81	296	37	FLT2230-81F6D	\$3,108		
	22	30	81	296	37	FLV2230-81F6D		\$5,022	\$5,522



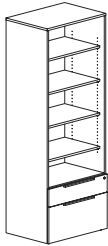
Features:

- aligns with secondary height units
- pedestal front locking
- upper compartment has four adjustable shelves

Options:

- must specify chassis grain direction on double cut veneer, see pages 13-15 for details
- veneer door and drawer front in paint available, specify paint color and add \$337; see page 16 for details
- on laminate units, contrasting door and drawer fronts available, no upcharge; specify color, see page 16 for details
- locking door available, specify and add \$142 list
- ledge pulls standard; prism pulls available, specify and see page 9

81" h Box/ File Lateral, Open Storage Cabinet	22	36	81	293	44	FLT2236-81F60	\$3,090		
	22	36	81	293	44	FLV2236-81F60		\$4,995	\$5,497
	22	30	81	255	37	FLT2230-81F60	\$2,925		
	22	30	81	255	37	FLV2230-81F60		\$4,775	\$5,253



Features:

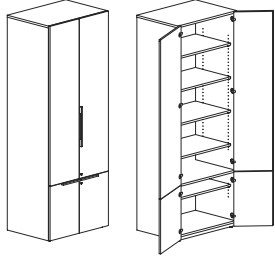
- aligns with secondary height units
- pedestal front locking
- upper compartment has four adjustable shelves

Options:

- must specify chassis grain direction on double cut veneer, see pages 13-15 for details
- veneer drawer fronts in paint available, specify paint color and add \$337 list; see page 16 for details
- on laminate units, contrasting drawer fronts available, no upcharge; specify color, see page 16 for details
- pedestal front locking
- ledge pulls standard; prism pulls available, specify and see page 9

FLUX - PRIVATE OFFICE

Description	D	W	H	CTN WT	CU FT	① Model	Laminate	Flat Cut Veneer	Double Cut Veneer
81" h Lower and Upper Hinge Door Storage Cabinet	22	36	81	324	44	FLT2236-81F8D	\$2,726		
	22	36	81	324	44	FLV2236-81F8D		\$4,658	\$5,123
	22	30	81	281	37	FLT2230-81F8D	\$2,560		
	22	30	81	281	37	FLV2230-81F8D		\$4,444	\$4,888



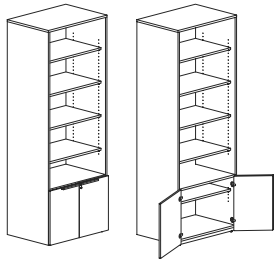
Features:

- aligns with secondary height units
- upper compartment has four adjustable shelves, lower compartment has one adjustable shelf

Options:

- must specify chassis grain direction on double cut veneer, see pages 13-15 for details
- veneer door fronts in paint available, specify paint color and add \$337 list; see page 16 for details
- on laminate units, contrasting doors fronts available, no upcharge; specify color, see page 16 for details
- locking doors available, specify and add \$284 list
- ledge pulls standard, mounted vertical; prism pulls available, specify and see page 9

81" h Lower Hinge Doors, Open Storage Cabinet	22	36	81	275	44	FLT2236-81F80	\$2,527		
	22	36	81	275	44	FLV2236-81F80		\$4,398	\$4,837
	22	30	81	240	37	FLT2230-81F80	\$2,373		
	22	30	81	240	37	FLV2230-81F80		\$4,199	\$4,619



Features:

- aligns with secondary height units
- upper compartment has four adjustable shelves, lower compartment has one adjustable shelf

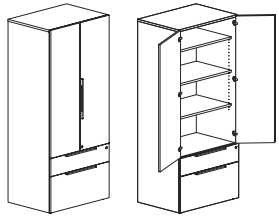
Options:

- must specify chassis grain direction on double cut veneer, see pages 13-15 for details
- veneer door fronts in paint available, specify paint color and add \$337 list; see page 16 for details
- on laminate units, contrasting doors fronts available, no upcharge; specify color, see page 16 for details
- locking doors available, specify and add \$142 list
- ledge pulls standard; prism pulls available, specify and see page 9

To Order, Specify:

① Laminate Model #		② Laminate Selection		③ Metal Color	④ Other Product Options
Laminate (FLT)		See Laminate Selection		See Metal Finish Color Options	See list of options for each specific unit; Specify and add accordingly.
① Veneer Model #	② Wood Species	③ Wood Finish		④ Metal Color	⑤ Other Product Options
Veneer (FLV)	Flat Cut CH1 Cherry MA1 Maple WA1 Walnut BO1 Black Oak	See Flat Cut Wood Finish Options		See Metal Finish Color Options	See list of options for each specific unit; Specify and add accordingly.
		③a Wood Finish	③b Chassis Grain Direction		
	Double Cut DC1 Double Cut	See Double Cut Wood Finish Options	For Double Cut Only: Vertical Horizontal		

Description	D	W	H	CTN WT	CU FT	① Model	Laminate	Flat Cut Veneer	Double Cut Veneer
69" h Box/File Lateral, Storage Cabinet	22	36	69	292	38	FLT2236-69F6D	\$2,993		
	22	36	69	292	38	FLV2236-69F6D		\$4,835	\$5,316
	22	30	69	205	32	FLT2230-69F6D	\$2,840		
	22	30	69	205	32	FLV2230-69F6D		\$4,636	\$5,099



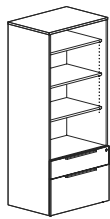
Features:

- aligns with secondary height units
- pedestal front locking
- upper compartment has three adjustable shelves

Options:

- must specify chassis grain direction on double cut veneer, see pages 13-15 for details
- veneer door and drawer front in paint available, specify paint color and add \$337; see page 16 for details
- on laminate units, contrasting door and drawer fronts available, no upcharge; specify color, see page 16 for details
- locking upper doors available, specify and add \$142 list
- ledge pulls standard; prism pulls available, specify and see page 9

69" h Box/File Lateral, Open Storage Cabinet	22	36	69	261	38	FLT2236-69F60	\$2,828		
	22	36	69	261	38	FLV2236-69F60		\$4,621	\$5,084
	22	30	69	235	32	FLT2230-69F60	\$2,685		
	22	36	69	235	32	FLV2230-69F60		\$4,437	\$4,881



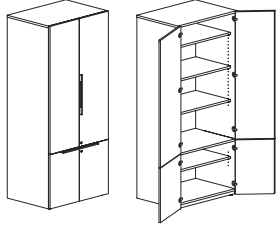
Features:

- aligns with secondary height units
- pedestal front locking
- upper compartment has three adjustable shelves

Options:

- must specify chassis grain direction on double cut veneer, see pages 13-15 for details
- veneer drawer fronts in paint available, specify paint color and add \$337 list; see page 16 for details
- on laminate units, contrasting drawer fronts available, no upcharge; specify color, see page 16 for details
- ledge pulls standard; prism pulls available, specify and see page 9

Description	D	W	H	CTN WT	CU FT	① Model	Laminate	Flat Cut Veneer	Double Cut Veneer
69" h Lower and Upper Hinge Door Storage Cabinet	22	36	69	235	38	FLT2236-69F8D	\$2,429		
	22	36	69	235	38	FLV2236-69F8D		\$4,234	\$4,658
	22	30	69	232	32	FLT2230-69F8D	\$2,290		
	22	30	69	232	32	FLV2230-69F8D		\$4,058	\$4,464



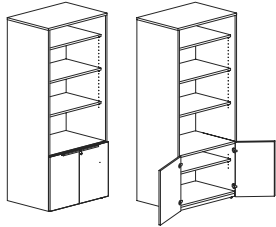
Features:

- aligns with secondary height units
- upper compartment has three adjustable shelves, lower compartment has one adjustable shelf

Options:

- must specify chassis grain direction on double cut veneer, see pages 13-15 for details
- veneer door fronts in paint available, specify paint color and add \$337 list; see page 16 for details
- on laminate units, contrasting doors fronts available, no upcharge; specify color, see page 16 for details
- locking doors available, specify and add \$284 list
- ledge pulls standard; prism pulls available, specify and see page 9

69" h Lower Hinge Doors, Open Storage Cabinet	22	36	69	216	38	FLT2236-69F80	\$2,264		
	22	36	69	216	38	FLV2236-69F80		\$4,023	\$4,424
	22	30	69	199	32	FLT2230-69F80	\$2,135		
	22	30	69	199	32	FLV2230-69F80		\$3,857	\$4,246



Features:

- aligns with secondary height units
- upper compartment has three adjustable shelves, lower compartment has one adjustable shelf

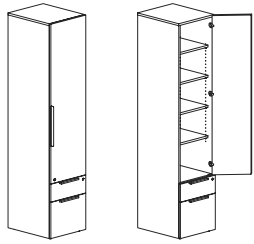
Options:

- must specify chassis grain direction on double cut veneer, see pages 13-15 for details
- veneer door fronts in paint available, specify paint color and add \$337 list; see page 16 for details
- on laminate units, contrasting doors fronts available, no upcharge; specify color, see page 16 for details
- locking lower doors available specify and add \$142 list
- ledge pulls standard; prism pulls available, specify and see page 9

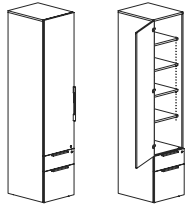
To Order, Specify:

① Laminate Model #		② Laminate Selection		③ Metal Color	④ Other Product Options
Laminate (FLT)		See Laminate Selection		See Metal Finish Color Options	See list of options for each specific unit; Specify and add accordingly.
① Veneer Model #	② Wood Species	③ Wood Finish		④ Metal Color	⑤ Other Product Options
Veneer (FLV)	Flat Cut CH1 Cherry MA1 Maple WA1 Walnut BO1 Black Oak	See Flat Cut Wood Finish Options		See Metal Finish Color Options	See list of options for each specific unit; Specify and add accordingly.
	Double Cut DC1 Double Cut	3a Wood Finish See Double Cut Wood Finish Options	3b Chassis Grain Direction For Double Cut Only: Vertical Horizontal		

Description	D	W	H	CTN WT	CU FT	① Model	Laminate	Flat Cut Veneer	Double Cut Veneer
81" h Box/File, Storage Cabinet	22	18	81	210	24	FLT2218-81F5DR	\$2,440		
	22	18	81	210	24	FLV2218-81F5DR		\$3,883	\$4,272
	22	18	81	210	24	FLT2218-81F5DL	\$2,440		
	22	18	81	210	24	FLV2218-81F5DL		\$3,883	\$4,272



right shown



left

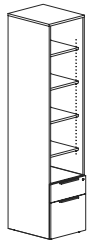
Features:

- aligns with secondary height units
- pedestal front locking
- upper compartment has four adjustable shelves

Options:

- must specify chassis grain direction on double cut veneer, see pages 13-15 for details
- veneer door and drawer front in paint available, specify paint color and add \$337; see page 16 for details
- on laminate units, contrasting door and drawer fronts available, no upcharge; specify color, see page 16 for details
- locking door available, specify and add \$142 list
- ledge pulls standard; prism pulls available, specify and see page 9
- vanity mirror available, specify and add \$141 list

81" h Box/File, Open Storage Cabinet	22	18	81	185	24	FLT2218-81F50	\$2,331		
	22	18	81	185	24	FLV2218-81F50		\$3,725	\$4,099



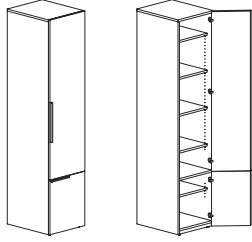
Features:

- aligns with secondary height units
- pedestal front locking
- upper compartment has four adjustable shelves

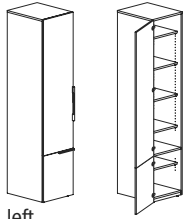
Options:

- must specify chassis grain direction on double cut veneer, see pages 13-15 for details
- veneer drawer fronts in paint available, specify paint color and add \$337 list; see page 16 for details
- on laminate units, contrasting drawer fronts available, no upcharge; specify color, see page 16 for details
- ledge pulls standard; prism pulls available, specify and see page 9

Description	D	W	H	CTN WT	CU FT	① Model	Laminate	Flat Cut Veneer	Double Cut Veneer
81" h Lower and Upper Hinge Door Storage Cabinet	22	18	81	188	24	FLT2218-81F8DR	\$1,910		
	22	18	81	188	24	FLV2218-81F8DR		\$3,319	\$3,652
	22	18	81	188	24	FLT2218-81F8DL	\$1,910		
	22	18	81	188	24	FLV2218-81F8DL		\$3,319	\$3,652



right shown



left

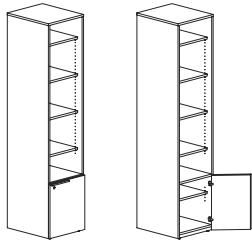
Features:

- aligns with secondary height units
- upper compartment has four adjustable shelves, lower compartment has one adjustable shelf

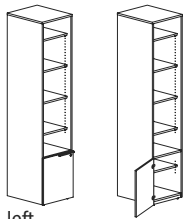
Options:

- must specify chassis grain direction on double cut veneer, see pages 13-15 for details
- veneer door fronts in paint available, specify paint color and add \$337 list; see page 16 for details
- on laminate units, contrasting doors fronts available, no upcharge; specify color, see page 16 for details
- locking doors available, specify and add \$284 list
- ledge pulls standard, mounted vertical; prism pulls available, specify and see page 9
- vanity mirror available, specify and add \$141 list

81" h Lower Hinge Door, Open Storage Cabinet	22	18	81	170	24	FLT2218-81F80R	\$1,803		
	22	18	81	170	24	FLV2218-81F80R		\$3,162	\$3,479
	22	18	81	170	24	FLT2218-81F80L	\$1,803		
	22	18	81	170	24	FLV2218-81F80L		\$3,162	\$3,479



right shown



left

Features:

- aligns with secondary height units
- upper compartment has four adjustable shelves

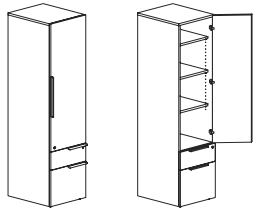
Options:

- must specify chassis grain direction on double cut veneer, see pages 13-15 for details
- veneer door front in paint available, specify paint color and add \$337 list; see page 16 for details
- on laminate units, contrasting doors fronts available, no upcharge; specify color, see page 16 for details
- locking lower door available, specify and add \$142 list
- ledge pulls standard; prism pulls available, specify and see page 9

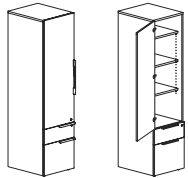
To Order, Specify:

① Laminate Model #		② Laminate Selection		③ Metal Color	④ Other Product Options
Laminate (FLT)		See Laminate Selection		See Metal Finish Color Options	See list of options for each specific unit; Specify and add accordingly.
① Veneer Model #	② Wood Species	③ Wood Finish		④ Metal Color	⑤ Other Product Options
Veneer (FLV)	Flat Cut CH1 Cherry MA1 Maple WA1 Walnut BO1 Black Oak	See Flat Cut Wood Finish Options		See Metal Finish Color Options	See list of options for each specific unit; Specify and add accordingly.
	Double Cut DC1 Double Cut	③a Wood Finish See Double Cut Wood Finish Options	③b Chassis Grain Direction For Double Cut Only: Vertical Horizontal		

Description	D	W	H	CTN WT	CU FT	① Model	Laminate	Flat Cut Veneer	Double Cut Veneer
69" h Box/File, Storage Cabinet	22	18	69	183	20	FLT2218-69F5DR	\$2,247		
	22	18	69	183	20	FLV2218-69F5DR		\$3,607	\$3,968
	22	18	69	183	20	FLT2218-69F5DL	\$2,247		
	22	18	69	183	20	FLV2218-69F5DL		\$3,607	\$3,968



right shown



left

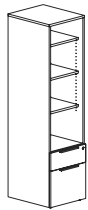
Features:

- aligns with secondary height units
- pedestal front locking
- upper compartment has three adjustable shelves

Options:

- must specify chassis grain direction on double cut veneer, see pages 13-15 for details
- veneer door and drawer front in paint available, specify paint color and add \$337; see page 16 for details
- on laminate units, contrasting door and drawer fronts available, no upcharge; specify color, see page 16 for details
- locking upper door available, specify and add \$142 list
- ledge pulls standard; prism pulls available, specify and see page 9
- vanity mirror available, specify and add \$141 list

69" h Box/File, Open Storage Cabinet	22	18	69	163	20	FLT2218-69F50	\$2,161		
	22	18	69	163	20	FLV2218-69F50		\$3,482	\$3,832



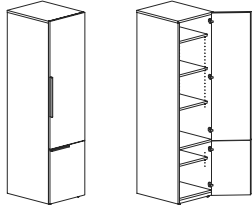
Features:

- aligns with secondary height units
- pedestal front locking
- upper compartment has three adjustable shelves

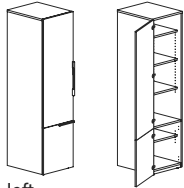
Options:

- must specify chassis grain direction on double cut veneer, see pages 13-15 for details
- veneer drawer fronts in paint available, specify paint color and add \$337 list; see page 16 for details
- on laminate units, contrasting drawer fronts available, no upcharge; specify color, see page 16 for details
- ledge pulls standard; prism pulls available, specify and see page 9

Description	D	W	H	CTN WT	CU FT	① Model	Laminate	Flat Cut Veneer	Double Cut Veneer
69" h Lower and Upper Hinge Door Storage Cabinet	22	18	69	168	20	FLT2218-69F8DR	\$1,719		
	22	18	69	168	20	FLV2218-69F8DR		\$3,046	\$3,349
	22	18	69	168	20	FLT2218-69F8DL	\$1,719		
	22	18	69	168	20	FLV2218-69F8DL		\$3,046	\$3,349



right shown



left

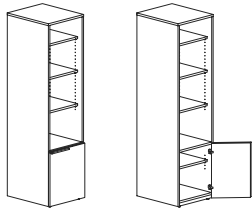
Features:

- aligns with secondary height units
- upper compartment has three adjustable shelves, lower compartment has one adjustable shelf

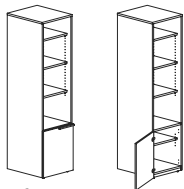
Options:

- must specify chassis grain direction on double cut veneer, see pages 13-15 for details
- veneer door fronts in paint available, specify paint color and add \$337 list; see page 16 for details
- on laminate units, contrasting doors fronts available, no upcharge; specify color, see page 16 for details
- locking doors available, specify and add \$284 list
- ledge pulls standard; prism pulls available, specify and see page 9

69" h Lower Hinge Door, Open Storage Cabinet	22	18	69	148	20	FLT2218-69F8OR	\$1,630		
	22	18	69	148	20	FLV2218-69F8OR		\$2,920	\$3,212
	22	18	69	148	20	FLT2218-69F8OL	\$1,630		
	22	18	69	148	20	FLV2218-69F8OL		\$2,920	\$3,212



right shown



left

Features:

- aligns with secondary height units
- upper compartment has three adjustable shelves

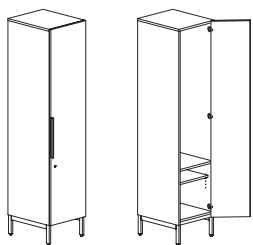
Options:

- must specify chassis grain direction on double cut veneer, see pages 13-15 for details
- veneer door front in paint available, specify paint color and add \$337 list; see page 16 for details
- on laminate units, contrasting doors fronts available, no upcharge; specify color, see page 16 for details
- locking door available, specify and add \$142 list
- ledge pulls standard; prism pulls available, specify and see page 9

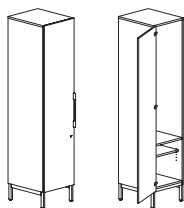
To Order, Specify:

① Laminate Model #		② Laminate Selection		③ Metal Color	④ Other Product Options
Laminate (FLT)		See Laminate Selection		See Metal Finish Color Options	See list of options for each specific unit; Specify and add accordingly.
① Veneer Model #	② Wood Species	③ Wood Finish		④ Metal Color	⑤ Other Product Options
Veneer (FLV)	Flat Cut CH1 Cherry MA1 Maple WA1 Walnut BO1 Black Oak	See Flat Cut Wood Finish Options		See Metal Finish Color Options	See list of options for each specific unit; Specify and add accordingly.
	Double Cut DC1 Double Cut	3a Wood Finish See Double Cut Wood Finish Options	3b Chassis Grain Direction For Double Cut Only: Vertical Horizontal		

Description	D	W	H	CTN WT	CU FT	① Model	Laminate	Flat Cut Veneer	Double Cut Veneer
81" h Wardrobe	22	18	81	161	24	FLT2218-81LDWR	\$2,517		
	22	18	81	161	24	FLV2218-81LDWR		\$3,488	\$3,834
	22	18	81	161	24	FLT2218-81LDWL	\$2,517		
	22	18	81	161	24	FLV2218-81LDWL		\$3,488	\$3,834



right shown



left

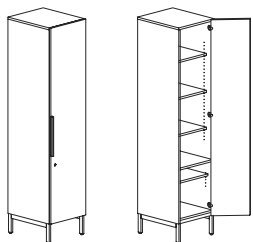
Features:

- lower adjustable shelf
- installed coat hooks

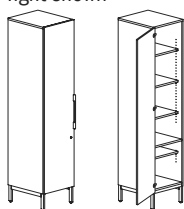
Options:

- must specify chassis grain direction on double cut veneer, see pages 13-15 for details
- veneer door front in paint available, specify paint color and add \$337 list; see page 16 for details
- on laminate units, contrasting doors fronts available, no upcharge; specify color, see page 16 for details
- locking door available, specify and add \$142 list
- ledge pulls standard, mounted vertical; prism pulls available, specify and see page 9
- vanity mirror available, specify and add \$141 list

81" h Storage Cabinet	22	18	81	187	24	FLT2218-81LDR	\$2,507		
	22	18	81	187	24	FLV2218-81LDR		\$3,478	\$3,827
	22	18	81	187	24	FLT2218-81LDL	\$2,507		
	22	18	81	187	24	FLV2218-81LDL		\$3,478	\$3,827



right shown



left

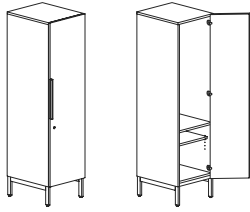
Features:

- five adjustable shelves

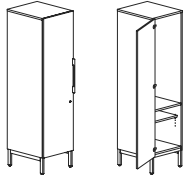
Options:

- must specify chassis grain direction on double cut veneer, see pages 13-15 for details
- veneer door fronts in paint available, specify paint color and add \$337 list; see page 16 for details
- on laminate units, contrasting doors fronts available, no upcharge; specify color, see page 16 for details
- locking door available, specify and add \$142 list
- ledge pulls standard, mounted vertical; prism pulls available, specify and see page 9
- vanity mirror available, specify and add \$141 list

Description	D	W	H	CTN WT	CU FT	① Model	Laminate	Flat Cut Veneer	Double Cut Veneer
69" h Wardrobe	22	18	69	147	20	FLT2218-69LDWR	\$2,323		
	22	18	69	147	20	FLV2218-69LDWR		\$3,211	\$3,532
	22	18	69	147	20	FLT2218-69LDWL	\$2,323		
	22	18	69	147	20	FLV2218-69LDWL		\$3,211	\$3,532



right shown



left

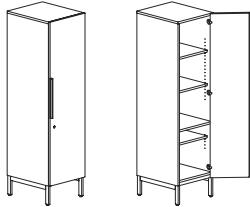
Features:

- lower adjustable shelf
- installed coat hooks

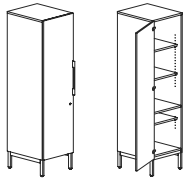
Options:

- must specify chassis grain direction on double cut veneer, see pages 13-15 for details
- veneer door front in paint available, specify paint color and add \$337 list; see page 16 for details
- on laminate units, contrasting doors fronts available, no upcharge; specify color, see page 16 for details
- locking door available, specify and add \$142 list
- ledge pulls standard, mounted vertical; prism pulls available, specify and see page 9
- vanity mirror available, specify and add \$141 list

69" h Storage Cabinet	D	W	H	CTN WT	CU FT	Model	Laminate	Flat Cut Veneer	Double Cut Veneer
	22	18	69	159	20	FLT2218-69LDR	\$2,316		
	22	18	69	159	20	FLV2218-69LDR		\$3,203	\$3,524
	22	18	69	159	20	FLT2218-69LDL	\$2,316		
	22	18	69	159	20	FLV2218-69LDL		\$3,203	\$3,524



right shown



left

Features:

- four adjustable shelves

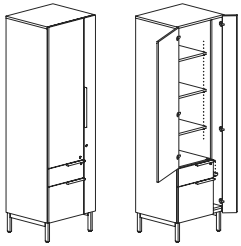
Options:

- must specify chassis grain direction on double cut veneer, see pages 13-15 for details
- veneer door front in paint available, specify paint color and add \$337 list; see page 16 for details
- on laminate units, contrasting doors fronts available, no upcharge; specify color, see page 16 for details
- locking door available, specify and add \$142 list
- ledge pulls standard, mounted vertical; prism pulls available, specify and see page 9
- vanity mirror available, specify and add \$141 list

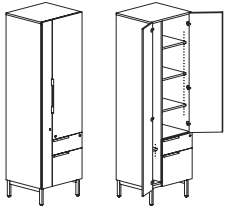
To Order, Specify:

① Laminate Model #		② Laminate Selection		③ Metal Color	④ Other Product Options
Laminate (FLT)		See Laminate Selection		See Metal Finish Color Options	See list of options for each specific unit; Specify and add accordingly.
① Veneer Model #	② Wood Species	③ Wood Finish		④ Metal Color	⑤ Other Product Options
Veneer (FLV)	Flat Cut CH1 Cherry MA1 Maple WA1 Walnut BO1 Black Oak	See Flat Cut Wood Finish Options		See Metal Finish Color Options	See list of options for each specific unit; Specify and add accordingly.
	Double Cut DC1 Double Cut	③a Wood Finish	③b Chassis Grain Direction		
		See Double Cut Wood Finish Options	For Double Cut Only: Vertical Horizontal		

Description	D	W	H	CTN WT	CU FT	① Model	Laminate	Flat Cut Veneer	Double Cut Veneer
81" h Box/File, Storage Cabinet with Side Wardrobe	22	24	81	260	30	FLT2224-81L5DWR	\$3,803		
	22	24	81	260	30	FLV2224-81L5DWR		\$5,205	\$5,725
	22	24	81	260	30	FLT2224-81L5DWL	\$3,803		
	22	24	81	260	30	FLV2224-81L5DWL		\$5,205	\$5,725



right shown



left

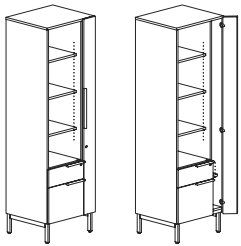
Features:

- aligns with primary height units
- pedestal front locking
- upper compartment has three adjustable shelves
- installed coat hook in wardrobe compartment

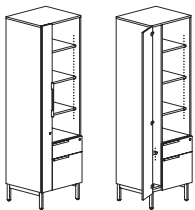
Options:

- must specify chassis grain direction on double cut veneer, see pages 13-15 for details
- veneer door and drawer front in paint available, specify paint color and add \$337; see page 16 for details
- on laminate units, contrasting door and drawer fronts available, no upcharge; specify color, see page 16 for details
- locking doors available, specify and add \$284 list
- ledge pulls standard; prism pulls available, specify and see page 9
- vanity mirror available, specify and add \$141 list

81" h Box/File, Open Storage Cabinet with Side Wardrobe	22	24	81	241	30	FLT2224-81L50WR	\$3,695		
	22	24	81	241	30	FLV2224-81L50WR		\$5,048	\$5,553
	22	24	81	241	30	FLT2224-81L50WL	\$3,695		
	22	24	81	241	30	FLV2224-81L50WL		\$5,048	\$5,553



right shown



left

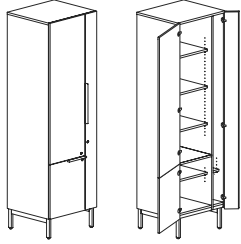
Features:

- aligns with primary height units
- pedestal front locking
- upper compartment has three adjustable shelves
- installed coat hook in wardrobe compartment

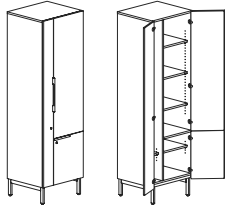
Options:

- must specify chassis grain direction on double cut veneer, see pages 13-15 for details
- veneer door and drawer front in paint available, specify paint color and add \$337; see page 16 for details
- on laminate units, contrasting door and drawer fronts available, no upcharge; specify color, see page 16 for details
- locking door available, specify and add \$142 list
- ledge pulls standard; prism pulls available, specify and see page 9

Description	D	W	H	CTN WT	CU FT	① Model	Laminate	Flat Cut Veneer	Double Cut Veneer
81" Lower and Upper Hinge Door Storage Cabinet with Side Wardrobe	22	24	81	253	30	FLT2224-81L8DWR	\$3,184		
	22	24	81	253	30	FLV2224-81L8DWR		\$4,517	\$4,970
	22	24	81	253	30	FLT2224-81L8DWL	\$3,184		
	22	24	81	253	30	FLV2224-81L8DWL		\$4,517	\$4,970



right shown



left

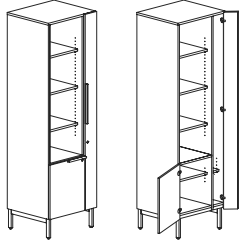
Features:

- aligns with primary height units
- upper compartment has three adjustable shelves, lower compartment has one adjustable shelf
- installed coat hook in wardrobe compartment

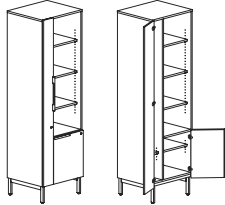
Options:

- must specify chassis grain direction on double cut veneer, see pages 13-15 for details
- veneer door fronts in paint available, specify paint color and add \$337 list; see page 16 for detail
- on laminate units, contrasting doors fronts available, no upcharge; specify color, see page 16 for details
- locking doors available, specify and add \$426 list
- ledge pulls standard; prism pulls available, specify and see page 9
- vanity mirror available, specify and add \$141 list

81" h Lower Hinge Door, Open Storage Cabinet with Side Wardrobe	22	24	81	226	30	FLT2224-81L80WR	\$3,078		
	22	24	81	226	30	FLV2224-81L80WR		\$4,360	\$4,796
	22	24	81	226	30	FLT2224-81L80WL	\$3,078		
	22	24	81	226	30	FLV2224-81L80WL		\$4,360	\$4,796



right shown



left

Features:

- aligns with primary height units
- upper compartment has two adjustable shelves, lower compartment has one adjustable shelf
- installed coat hook in wardrobe compartment

Options:

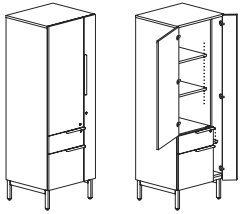
- must specify chassis grain direction on double cut veneer, see pages 13-15 for details
- veneer door fronts in paint available, specify paint color and add \$337 list; see page 16 for detail
- on laminate units, contrasting doors fronts available, no upcharge; specify color, see page 16 for details
- locking doors available, specify and add \$284 list
- ledge pulls standard; prism pulls available, specify and see page 9

To Order, Specify:

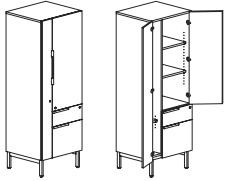
① Laminate Model #	② Laminate Type	③ Laminate Selection	④ Metal Color	⑤ Other Product Options
Laminate (FLT)	HPL	See Laminate Selection	See Metal Finish Color Options	See list of options for each specific unit; Specify and add accordingly.

① Veneer Model #	② Wood Species	③ Wood Finish - Finishes with an asterisk (*) have a coordinating laminate available	④ Metal Color	⑤ Other Product Options
Veneer (FLV)	Flat Cut CH1 Cherry MA1 Maple WA1 Walnut BO1 Black Oak	See Flat Cut Wood Finish Options	See Metal Finish Color Options	See list of options for each specific unit; Specify and add accordingly.
		ⓐ Wood Finish See Double Cut Wood Finish Options		
	Double Cut DC1 Double Cut			

Description	D	W	H	CTN WT	CU FT	① Model	Laminate	Flat Cut Veneer	Double Cut Veneer
69" h Box/File, Storage Cabinet with Side Wardrobe	22	24	69	236	26	FLT2224-69L5DWR	\$3,608		
	22	24	69	236	26	FLV2224-69L5DWR		\$4,929	\$5,423
	22	24	69	236	26	FLT2224-69L5DWL	\$3,608		
	22	24	69	236	26	FLV2224-69L5DWL		\$4,929	\$5,423



right shown



left

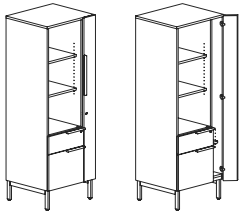
Features:

- aligns with primary height units
- pedestal front locking
- upper compartment has two adjustable shelves
- installed coat hook in wardrobe compartment

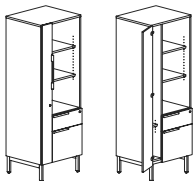
Options:

- must specify chassis grain direction on double cut veneer, see pages 13-15 for details
- veneer door and drawer front in paint available, specify paint color and add \$337; see page 16 for details
- on laminate units, contrasting door and drawer fronts available, no upcharge; specify color, see page 16 for details
- locking doors available, specify and add \$284 list
- ledge pulls standard; prism pulls available, specify and see page 9
- vanity mirror available, specify and add \$141 list

69" h Box/File, Open Storage Cabinet with Side Wardrobe	22	24	69	208	26	FLT2224-69L50WR	\$3,523		
	22	24	69	208	26	FLV2224-69L50WR		\$4,806	\$5,287
	22	24	69	208	26	FLT2224-69L50WL	\$3,523		
	22	24	69	208	26	FLV2224-69L50WL		\$4,806	\$5,287



right shown



left

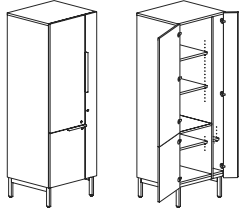
Features:

- aligns with primary height units
- pedestal front locking
- upper compartment has two adjustable shelves
- installed coat hook in wardrobe compartment

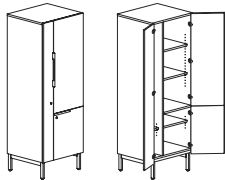
Options:

- must specify chassis grain direction on double cut veneer, see pages 13-15 for details
- veneer door and drawer front in paint available, specify paint color and add \$337; see page 16 for details
- on laminate units, contrasting door and drawer fronts available, no upcharge; specify color, see page 16 for details
- locking door available, specify and add \$142 list
- ledge pulls standard; prism pulls available, specify and see page 9

Description	D	W	H	CTN WT	CU FT	① Model	Laminate	Flat Cut Veneer	Double Cut Veneer
69" h Lower and Upper Hinge Door Storage Cabinet with Side Wardrobe	22	24	69	224	26	FLT2224-69L8DWR	\$2,993		
	22	24	69	224	26	FLV2224-69L8DWR		\$4,243	\$4,665
	22	24	69	224	26	FLT2224-69L8DWL	\$2,993		
	22	24	69	224	26	FLV2224-69L8DWL		\$4,243	\$4,665



right shown



left

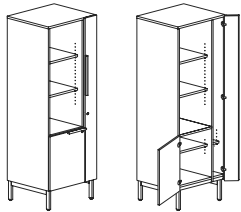
Features:

- aligns with primary height units
- upper compartment has two adjustable shelves, lower compartment has one adjustable shelf
- installed coat hook in wardrobe compartment

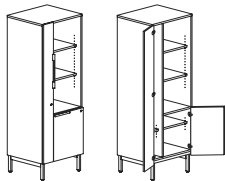
Options:

- must specify chassis grain direction on double cut veneer, see pages 13-15 for details
- veneer door fronts in paint available, specify paint color and add \$337 list; see page 16 for detail
- on laminate units, contrasting doors fronts available, no upcharge; specify color, see page 16 for details
- locking doors available, specify and add \$426 list
- ledge pulls standard; prism pulls available, specify and see page 9
- vanity mirror available, specify and add \$141 list

69" h Lower Hinge Door, Open Storage Cabinet with Side Wardrobe	22	24	69	202	26	FLT2224-69L80WR	\$2,905		
	22	24	69	202	26	FLV2224-69L80WR		\$4,116	\$4,528
	22	24	69	202	26	FLT2224-69L80WL	\$2,905		
	22	24	69	202	26	FLV2224-69L80WL		\$4,116	\$4,528



right shown



left

Features:

- aligns with primary height units
- upper compartment has two adjustable shelves, lower compartment has one adjustable shelf
- installed coat hook in wardrobe compartment

Options:

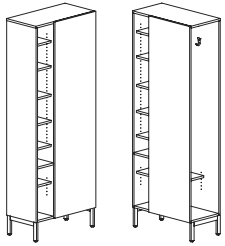
- must specify chassis grain direction on double cut veneer, see pages 13-15 for details
- veneer door fronts in paint available, specify paint color and add \$337 list; see page 16 for detail
- on laminate units, contrasting doors fronts available, no upcharge; specify color, see page 16 for details
- locking doors available, specify and add \$284 list
- ledge pulls standard; prism pulls available, specify and see page 9

To Order, Specify:

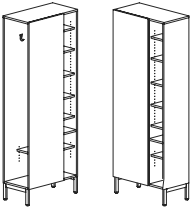
① Laminate Model #		② Laminate Selection		③ Metal Color	④ Other Product Options
Laminate (FLT)		See Laminate Selection		See Metal Finish Color Options	See list of options for each specific unit; Specify and add accordingly.
① Veneer Model #	② Wood Species	③ Wood Finish		④ Metal Color	⑤ Other Product Options
Veneer (FLV)	Flat Cut CH1 Cherry MA1 Maple WA1 Walnut BO1 Black Oak	See Flat Cut Wood Finish Options		See Metal Finish Color Options	See list of options for each specific unit; Specify and add accordingly.
	Double Cut DC1 Double Cut	3a Wood Finish See Double Cut Wood Finish Options	3b Chassis Grain Direction For Double Cut Only: Vertical Horizontal		

FLUX - PRIVATE OFFICE

Description	D	W	H	CTN WT	CU FT	① Model	Laminate	Flat Cut Veneer	Double Cut Veneer
81" h Side Access Wardrobe with Open Shelves	15 $\frac{7}{8}$ "	36	81	203	32	FLT1636-81LSWR	\$2,728		
	15 $\frac{7}{8}$ "	36	81	203	32	FLV1636-81LSWR		\$4,172	\$4,589
	15 $\frac{7}{8}$ "	36	81	203	32	FLT1636-81LSWL	\$2,728		
	15 $\frac{7}{8}$ "	36	81	203	32	FLV1636-81LSWL		\$4,172	\$4,589
	15 $\frac{7}{8}$ "	30	81	178	27	FLT1630-81LSWR	\$2,541		
	15 $\frac{7}{8}$ "	30	81	178	27	FLV1630-81LSWR		\$3,861	\$4,248
	15 $\frac{7}{8}$ "	30	81	178	27	FLT1630-81LSWL	\$2,541		
	15 $\frac{7}{8}$ "	30	81	178	27	FLV1630-81LSWL		\$3,861	\$4,248



right shown



left

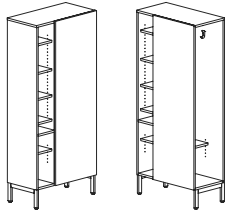
Features:

- side entry wardrobe with two installed coat hooks and one lower adjustable shelf
- 8 $\frac{1}{4}$ " w open compartment with five adjustable shelves

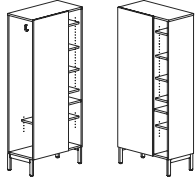
Options:

- must specify chassis grain direction on double cut veneer, see pages 13-15 for details

Description	D	W	H	CTN WT	CU FT	① Model	Laminate	Flat Cut Veneer	Double Cut Veneer
69" h Side Access Wardrobe with Open Shelves	15 7/8	36	69	172	27	FLT1636-69LSWR	\$2,537		
	15 7/8	36	69	172	27	FLV1636-69LSWR		\$3,895	\$4,287
	15 7/8	36	69	172	27	FLT1636-69LSWL	\$2,537		
	15 7/8	36	69	172	27	FLV1636-69LSWL		\$3,895	\$4,287
	15 7/8	30	69	147	23	FLT1630-69LSWR	\$2,365		
	15 7/8	30	69	147	23	FLV1630-69LSWR		\$3,602	\$3,963
	15 7/8	30	69	147	23	FLT1630-69LSWL	\$2,365		
	15 7/8	30	69	147	23	FLV1630-69LSWL		\$3,602	\$3,963



right shown



left

Features:

- side entry wardrobe with two installed coat hooks and one lower adjustable shelf
- 8 1/4" w open compartment with four adjustable shelves

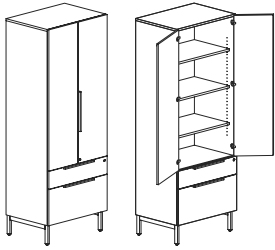
Options:

- must specify chassis grain direction on double cut veneer, see pages 13-15 for details

To Order, Specify:

① Laminate Model #		② Laminate Selection		③ Metal Color	④ Other Product Options
Laminate (FLT)		See Laminate Selection		See Metal Finish Color Options	See list of options for each specific unit; Specify and add accordingly.
① Veneer Model #	② Wood Species	③ Wood Finish		④ Metal Color	⑤ Other Product Options
Veneer (FLV)	Flat Cut CH1 Cherry MA1 Maple WA1 Walnut BO1 Black Oak	See Flat Cut Wood Finish Options		See Metal Finish Color Options	See list of options for each specific unit; Specify and add accordingly.
	Double Cut DC1 Double Cut	3a Wood Finish See Double Cut Wood Finish Options	3b Chassis Grain Direction For Double Cut Only: Vertical Horizontal		

Description	D	W	H	CTN WT	CU FT	① Model	Laminate	Flat Cut Veneer	Double Cut Veneer
81" h Box/File Lateral, Storage Cabinet	22	36	81	305	44	FLT2236-81L6D	\$3,987		
	22	36	81	305	44	FLV2236-81L6D		\$5,509	\$6,059
	22	30	81	284	37	FLT2230-81L6D	\$3,806		
	22	30	81	284	37	FLV2230-81L6D		\$5,272	\$5,799



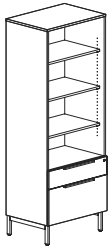
Features:

- aligns with primary height units
- pedestal front locking
- upper compartment has three adjustable shelves

Options:

- must specify chassis grain direction on double cut veneer, see pages 13-15 for details
- veneer door and drawer front in paint available, specify paint color and add \$337; see page 16 for details
- on laminate units, contrasting door and drawer fronts available, no upcharge; specify color, see page 16 for details
- locking door available, specify and add \$142 list
- ledge pulls standard; prism pulls available, specify and see page 9

81" h Box/File Lateral, Open Storage Cabinet	22	36	81	270	44	FLT2236-81L60	\$3,788		
	22	36	81	270	44	FLV2236-81L60		\$5,247	\$5,774
	22	30	81	247	37	FLT2230-81L60	\$3,622		
	22	30	81	247	37	FLV2230-81L60		\$5,027	\$5,530



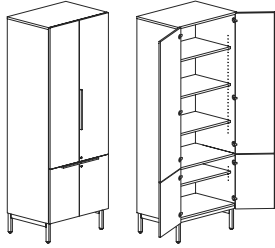
Features:

- aligns with primary height units
- pedestal front locking
- upper compartment has three adjustable shelves

Options:

- must specify chassis grain direction on double cut veneer, see pages 13-15 for details
- veneer drawer fronts in paint available, specify paint color and add \$337 list; see page 16 for details
- on laminate units, contrasting drawer fronts available, no upcharge; specify color, see page 16 for details
- ledge pulls standard; prism pulls available, specify and see page 9

Description	D	W	H	CTN WT	CU FT	① Model	Laminate	Flat Cut Veneer	Double Cut Veneer
81" h Lower and Upper Hinge Door Storage Cabinet	22	36	81	265	44	FLT2236-81L8D	\$3,423		
	22	36	81	265	44	FLV2236-81L8D		\$4,909	\$5,401
	22	30	81	248	37	FLT2230-81L8D	\$3,256		
	22	30	81	248	37	FLV2230-81L8D		\$4,695	\$5,163



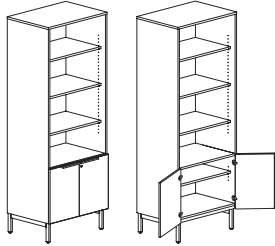
Features:

- aligns with primary height units
- upper compartment has three adjustable shelves, lower compartment has one adjustable shelf

Options:

- must specify chassis grain direction on double cut veneer, see pages 13-15 for details
- veneer door fronts in paint available, specify paint color and add \$337 list; see page 16 for details
- on laminate units, contrasting doors fronts available, no upcharge; specify color, see page 16 for details
- locking doors available, specify and add \$284 list
- ledge pulls standard; prism pulls available, specify and see page 9

81" h Lower Hinge Doors, Open Storage Cabinet	22	36	81	241	44	FLT2236-81L80	\$3,224		
	22	36	81	241	44	FLV2236-81L80		\$4,648	\$5,112
	22	30	81	224	37	FLT2230-81L80	\$3,070		
	22	30	81	224	37	FLV2230-81L80		\$4,448	\$4,896



Features:

- aligns with primary height units
- upper compartment has three adjustable shelves, lower compartment has one adjustable shelf

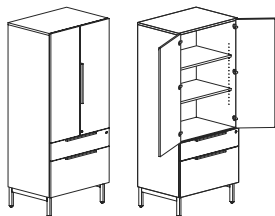
Options:

- must specify chassis grain direction on double cut veneer, see pages 13-15 for details
- veneer door fronts in paint available, specify paint color and add \$337 list; see page 16 for details
- on laminate units, contrasting doors fronts available, no upcharge; specify color, see page 16 for details
- locking door available, specify and add \$142 list
- ledge pulls standard; prism pulls available, specify and see page 9

To Order, Specify:

① Laminate Model #		② Laminate Selection		③ Metal Color	④ Other Product Options
Laminate (FLT)		See Laminate Selection		See Metal Finish Color Options	See list of options for each specific unit; Specify and add accordingly.
① Veneer Model #	② Wood Species	③ Wood Finish		④ Metal Color	⑤ Other Product Options
Veneer (FLV)	Flat Cut CH1 Cherry MA1 Maple WA1 Walnut BO1 Black Oak	See Flat Cut Wood Finish Options		See Metal Finish Color Options	See list of options for each specific unit; Specify and add accordingly.
	Double Cut DC1 Double Cut	③a Wood Finish	③b Chassis Grain Direction		
		See Double Cut Wood Finish Options	For Double Cut Only: Vertical Horizontal		

Description	D	W	H	CTN WT	CU FT	① Model	Laminate	Flat Cut Veneer	Double Cut Veneer
69" h Box/File Lateral, Storage Cabinet	22	36	69	261	38	FLT2236-69L6D	\$3,692		
	22	36	69	261	38	FLV2236-69L6D		\$5,084	\$5,594
	22	30	69	239	32	FLT2230-69L6D	\$3,536		
	22	30	69	239	32	FLV2230-69L6D		\$4,886	\$5,375



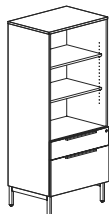
Features:

- aligns with primary height units
- pedestal front locking
- upper compartment has two adjustable shelves

Options:

- must specify chassis grain direction on double cut veneer, see pages 13-15 for details
- veneer door and drawer front in paint available, specify paint color and add \$337; see page 16 for details
- on laminate units, contrasting door and drawer fronts available, no upcharge; specify color, see page 16 for details
- locking door available, specify and add \$142 list
- ledge pulls standard; prism pulls available, specify and see page 9

69" h Box/File Lateral, Open Storage Cabinet	22	36	69	241	38	FLT2236-69L60	\$3,526		
	22	36	69	241	38	FLV2236-69L60		\$4,874	\$5,361
	22	30	69	219	32	FLT2230-69L60	\$3,382		
	22	30	69	219	32	FLV2230-69L60		\$4,686	\$5,156



Features:

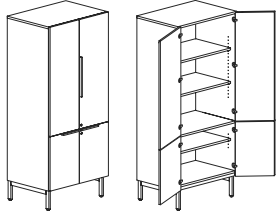
- aligns with primary height units
- pedestal front locking
- upper compartment has two adjustable shelves

Options:

- must specify chassis grain direction on double cut veneer, see pages 13-15 for details
- veneer drawer fronts in paint available, specify paint color and add \$337 list; see page 16 for details
- on laminate units, contrasting drawer fronts available, no upcharge; specify color, see page 16 for details
- ledge pulls standard; prism pulls available, specify and see page 9

FLUX - PRIVATE OFFICE

Description	D	W	H	CTN WT	CU FT	① Model	Laminate	Flat Cut Veneer	Double Cut Veneer
69" h Lower and Upper Hinge Door Storage Cabinet	22	36	69	240	37	FLT2236-69L8D	\$3,128		
	22	36	69	240	37	FLV2236-69L8D		\$4,484	\$4,932
	22	30	69	223	32	FLT2230-69L8D	\$2,986		
	22	30	69	223	32	FLV2230-69L8D		\$4,311	\$4,740



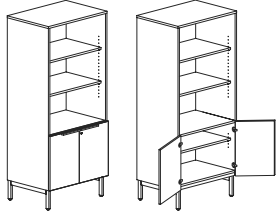
Features:

- aligns with primary height units
- upper compartment has two adjustable shelves, lower compartment has one adjustable shelf

Options:

- must specify chassis grain direction on double cut veneer, see pages 13-15 for details
- veneer door fronts in paint available, specify paint color and add \$337 list; see page 16 for details
- on laminate units, contrasting doors fronts available, no upcharge; specify color, see page 16 for details
- locking doors available, specify and add \$284 list
- ledge pulls standard; prism pulls available, specify and see page 9

69" h Lower Hinge Doors, Open Storage Cabinet	22	36	69	221	38	FLT2236-69L80	\$2,964		
	22	36	69	221	38	FLV2236-69L80		\$4,275	\$4,701
	22	30	69	204	32	FLT2230-69L80	\$2,832		
	22	30	69	204	32	FLV2230-69L80		\$4,110	\$4,522



Features:

- aligns with primary height units
- upper compartment has two adjustable shelves, lower compartment has one adjustable shelf

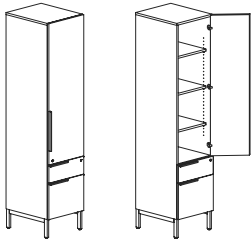
Options:

- must specify chassis grain direction on double cut veneer, see pages 13-15 for details
- veneer door fronts in paint available, specify paint color and add \$337 list; see page 16 for details
- on laminate units, contrasting doors fronts available, no upcharge; specify color, see page 16 for details
- locking door available, specify and add \$142 list
- ledge pulls standard; prism pulls available, specify and see page 9

To Order, Specify:

① Laminate Model #		② Laminate Selection		③ Metal Color	④ Other Product Options
Laminate (FLT)		See Laminate Selection		See Metal Finish Color Options	See list of options for each specific unit; Specify and add accordingly.
① Veneer Model #	② Wood Species	③ Wood Finish		④ Metal Color	⑤ Other Product Options
Veneer (FLV)	Flat Cut CH1 Cherry MA1 Maple WA1 Walnut BO1 Black Oak	See Flat Cut Wood Finish Options		See Metal Finish Color Options	See list of options for each specific unit; Specify and add accordingly.
	Double Cut DC1 Double Cut	③a Wood Finish	③b Chassis Grain Direction		
		See Double Cut Wood Finish Options	For Double Cut Only: Vertical Horizontal		

Description	D	W	H	CTN WT	CU FT	① Model	Laminate	Flat Cut Veneer	Double Cut Veneer
81" h Box/File, Storage Cabinet	22	18	81	209	24	FLT2218-81L5DR	\$3,121		
	22	18	81	209	24	FLV2218-81L5DR		\$4,113	\$4,525
	22	18	81	209	24	FLT2218-81L5DL	\$3,121		
	22	18	81	209	24	FLV2218-81L5DL		\$4,113	\$4,525



right shown



left

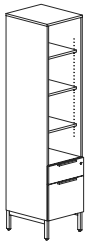
Features:

- aligns with primary height units
- pedestal front locking
- upper compartment has three adjustable shelves

Options:

- must specify chassis grain direction on double cut veneer, see pages 13-15 for details
- veneer door and drawer front in paint available, specify paint color and add \$337; see page 16 for details
- on laminate units, contrasting door and drawer fronts available, no upcharge; specify color, see page 16 for details
- locking door available, specify and add \$142 list
- ledge pulls standard; prism pulls available, specify and see page 9
- vanity mirror available, specify and add \$141 list

81" h Box/File, Open Storage Cabinet	22	18	81	182	24	FLT2218-81L50	\$3,012		
	22	18	81	182	24	FLV2218-81L50		\$3,957	\$4,353



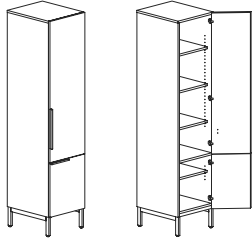
Features:

- aligns with primary height units
- pedestal front locking
- upper compartment has three adjustable shelves

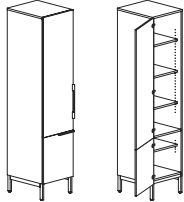
Options:

- must specify chassis grain direction on double cut veneer, see pages 13-15 for details
- veneer drawer fronts in paint available, specify paint color and add \$337 list; see page 16 for details
- on laminate units, contrasting drawer fronts available, no upcharge; specify color, see page 16 for details
- ledge pulls standard; prism pulls available, specify and see page 9

Description	D	W	H	CTN WT	CU FT	① Model	Laminate	Flat Cut Veneer	Double Cut Veneer
81" h Lower and Upper Hinge Door Storage Cabinet	22	18	81	187	24	FLT2218-81L8DR	\$2,590		
	22	18	81	187	24	FLV2218-81L8DR		\$3,550	\$3,904
	22	18	81	187	24	FLT2218-81L8DL	\$2,590		
	22	18	81	187	24	FLV2218-81L8DL		\$3,550	\$3,904



right shown



left

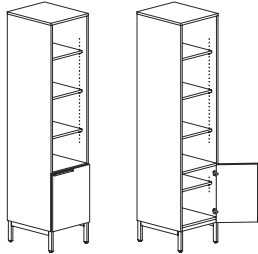
Features:

- aligns with primary height units
- upper compartment has two adjustable shelves, lower compartment has one adjustable shelf

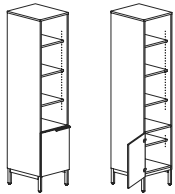
Options:

- must specify chassis grain direction on double cut veneer, see pages 13-15 for details
- veneer door fronts in paint available, specify paint color and add \$337 list; see page 16 for details
- on laminate units, contrasting doors fronts available, no upcharge; specify color, see page 16 for details
- locking doors available, specify and add \$284 list
- ledge pulls standard; prism pulls available, specify and see page 9
- vanity mirror available, specify and add \$141 list

81" h Lower Hinge Door, Open Storage Cabinet	22	18	81	165	24	FLT2218-81L8OR	\$2,482		
	22	18	81	165	24	FLV2218-81L8OR		\$3,392	\$3,731
	22	18	81	165	24	FLT2218-81L8OL	\$2,482		
	22	18	81	165	24	FLV2218-81L8OL		\$3,392	\$3,731



right shown



left

Features:

- aligns with primary height units
- upper compartment has three adjustable shelves, lower compartment has one adjustable shelf

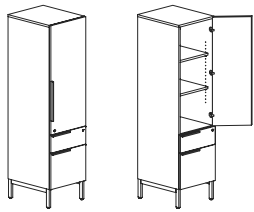
Options:

- must specify chassis grain direction on double cut veneer, see pages 13-15 for details
- veneer door front in paint available, specify paint color and add \$337 list; see page 16 for details
- on laminate units, contrasting doors fronts available, no upcharge; specify color, see page 16 for details
- locking door available, specify and add \$142 list
- ledge pulls standard; prism pulls available, specify and see page 9

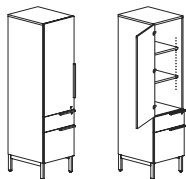
To Order, Specify:

① Laminate Model #		② Laminate Selection		③ Metal Color	④ Other Product Options		
Laminate (FLT)		See Laminate Selection		See Metal Finish Color Options	See list of options for each specific unit; Specify and add accordingly.		
① Veneer Model #	② Wood Species	③ Wood Finish		④ Metal Color	⑤ Other Product Options		
Veneer (FLV)	Flat Cut CH1 Cherry MA1 Maple WA1 Walnut BO1 Black Oak	See Flat Cut Wood Finish Options		See Metal Finish Color Options	See list of options for each specific unit; Specify and add accordingly.		
	Double Cut DC1 Double Cut	<table border="1"> <tr> <th>Ⓐ Wood Finish</th> <th>Ⓑ Chassis Grain Direction</th> </tr> <tr> <td>See Double Cut Wood Finish Options</td> <td>For Double Cut Only: Vertical Horizontal</td> </tr> </table>	Ⓐ Wood Finish	Ⓑ Chassis Grain Direction	See Double Cut Wood Finish Options	For Double Cut Only: Vertical Horizontal	
Ⓐ Wood Finish	Ⓑ Chassis Grain Direction						
See Double Cut Wood Finish Options	For Double Cut Only: Vertical Horizontal						

Description	D	W	H	CTN WT	CU FT	① Model	Laminate	Flat Cut Veneer	Double Cut Veneer
69" h Box/File, Storage Cabinet	22	18	69	181	20	FLT2218-69L5DR	\$2,930		
	22	18	69	181	20	FLV2218-69L5DR		\$3,839	\$4,222
	22	18	69	181	20	FLT2218-69L5DL	\$2,930		
	22	18	69	181	20	FLV2218-69L5DL		\$3,839	\$4,222



right shown



left

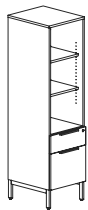
Features:

- aligns with primary height units
- pedestal front locking
- upper compartment has two adjustable shelves

Options:

- must specify chassis grain direction on double cut veneer, see pages 13-15 for details
- veneer door and drawer front in paint available, specify paint color and add \$337; see page 16 for details
- on laminate units, contrasting door and drawer fronts available, no upcharge; specify color, see page 16 for details
- locking door available, specify and add \$142 list
- ledge pulls standard; prism pulls available, specify and see page 9
- vanity mirror available, specify and add \$141 list

69" h Box/File, Open Storage Cabinet	22	18	69	160	20	FLT2218-69L50	\$2,841		
	22	18	69	160	20	FLV2218-69L50		\$3,715	\$4,087



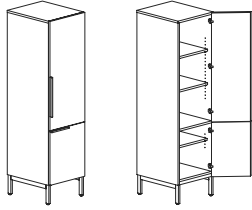
Features:

- aligns with primary height units
- pedestal front locking
- upper compartment has two adjustable shelves

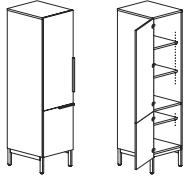
Options:

- must specify chassis grain direction on double cut veneer, see pages 13-15 for details
- veneer drawer fronts in paint available, specify paint color and add \$337 list; see page 16 for details
- on laminate units, contrasting drawer fronts available, no upcharge; specify color, see page 16 for details
- ledge pulls standard; prism pulls available, specify and see page 9

Description	D	W	H	CTN WT	CU FT	① Model	Laminate	Flat Cut Veneer	Double Cut Veneer
69" Lower and Upper Hinge Door Storage Cabinet	22	18	69	161	20	FLT2218-69L8DR	\$2,397		
	22	18	69	161	20	FLV2218-69L8DR		\$3,274	\$3,602
	22	18	69	161	20	FLT2218-69L8DL	\$2,397		
	22	18	69	161	20	FLV2218-69L8DL		\$3,274	\$3,602



right shown



left

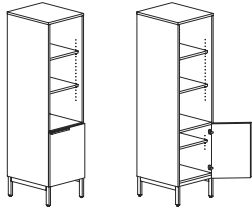
Features:

- aligns with primary height units
- upper compartment has two adjustable shelves, lower compartment has one adjustable shelf

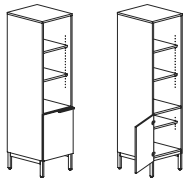
Options:

- must specify chassis grain direction on double cut veneer, see pages 13-15 for details
- veneer door fronts in paint available, specify paint color and add \$337 list; see page 16 for details
- on laminate units, contrasting doors fronts available, no upcharge; specify color, see page 16 for details
- locking doors available, specify and add \$284 list
- ledge pulls standard; prism pulls available, specify and see page 9
- vanity mirror available, specify and add \$141 list

69" h Lower Hinge Door, Open Storage Cabinet	22	18	69	144	20	FLT2218-69L80R	\$2,311		
	22	18	69	144	20	FLV2218-69L80R		\$3,150	\$3,464
	22	18	69	144	20	FLT2218-69L80L	\$2,311		
	22	18	69	144	20	FLV2218-69L80L		\$3,150	\$3,464



right shown



left

Features:

- aligns with primary height units
- upper compartment has two adjustable shelves, lower compartment has one adjustable shelf

Options:

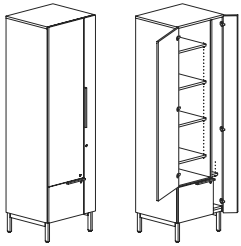
- must specify chassis grain direction on double cut veneer, see pages 13-15 for details
- veneer door front in paint available, specify paint color and add \$337 list; see page 16 for details
- on laminate units, contrasting doors fronts available, no upcharge; specify color, see page 16 for details
- locking door available, specify and add \$142 list
- ledge pulls standard; prism pulls available, specify and see page 9

To Order, Specify:

① Laminate Model #		② Laminate Selection		③ Metal Color	④ Other Product Options
Laminate (FLT)		See Laminate Selection		See Metal Finish Color Options	See list of options for each specific unit; Specify and add accordingly.
① Veneer Model #	② Wood Species	③ Wood Finish		④ Metal Color	⑤ Other Product Options
Veneer (FLV)	Flat Cut CH1 Cherry MA1 Maple WA1 Walnut BO1 Black Oak	See Flat Cut Wood Finish Options		See Metal Finish Color Options	See list of options for each specific unit; Specify and add accordingly.
	Double Cut DC1 Double Cut	ⓐ Wood Finish See Double Cut Wood Finish Options	ⓑ Chassis Grain Direction For Double Cut Only: Vertical Horizontal		

FLUX - PRIVATE OFFICE

Description	D	W	H	CTN WT	CU FT	① Model	Laminate	Flat Cut Veneer	Double Cut Veneer
81" h File Drawer, Storage Cabinet with Side Wardrobe	22	24	81	260	30	FLT2224-81SL5DWR	\$3,702		
	22	24	81	260	30	FLV2224-81SL5DWR		\$5,106	\$5,616
	22	24	81	260	30	FLT2224-81SL5DWL	\$3,702		
	22	24	81	260	30	FLV2224-81SL5DWL		\$5,106	\$5,616



right shown



left

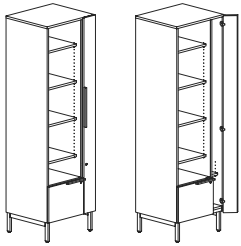
Features:

- aligns with secondary height units
- pedestal front locking
- upper compartment has four adjustable shelves
- installed coat hook in wardrobe compartment

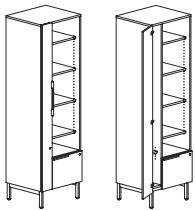
Options:

- must specify chassis grain direction on double cut veneer, see pages 13-15 for details
- veneer door and drawer front in paint available, specify paint color and add \$337; see page 16 for details
- on laminate units, contrasting door and drawer fronts available, no upcharge; specify color, see page 16 for details
- locking doors available, specify and add \$284 list
- ledge pulls standard; prism pulls available, specify and see page 9
- vanity mirror available, specify and add \$141 list

81" h File Drawer, Open Storage Cabinet with Side Wardrobe	22	24	81	230	30	FLT2224-81SL50WR	\$3,594		
	22	24	81	230	30	FLV2224-81SL50WR		\$4,950	\$5,445
	22	24	81	230	30	FLT2224-81SL50WL	\$3,594		
	22	24	81	230	30	FLV2224-81SL50WL		\$4,950	\$5,445



right shown



left

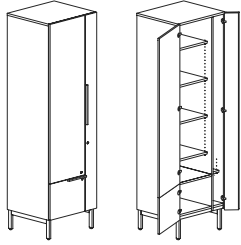
Features:

- aligns with secondary height units
- pedestal front locking
- upper compartment has four adjustable shelves
- installed coat hook in wardrobe compartment

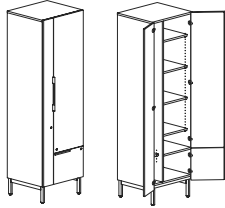
Options:

- must specify chassis grain direction on double cut veneer, see pages 13-15 for details
- veneer door and drawer front in paint available, specify paint color and add \$337; see page 16 for details
- on laminate units, contrasting door and drawer fronts available, no upcharge; specify color, see page 16 for details
- locking door available, specify and add \$142 list
- ledge pulls standard; prism pulls available, specify and see page 9

Description	D	W	H	CTN WT	CU FT	① Model	Laminate	Flat Cut Veneer	Double Cut Veneer
81" h Upper and Lower Hinge Door Storage Cabinet with Side Wardrobe	22	24	81	249	30	FLT2224-81SL8DWR	\$3,184		
	22	24	81	246	30	FLV2224-81SL8DWR		\$4,517	\$4,970
	22	24	81	246	30	FLT2224-81SL8DWL	\$3,184		
	22	24	81	246	30	FLV2224-81SL8DWL		\$4,517	\$4,970



right shown



left

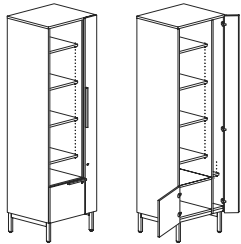
Features:

- aligns with secondary height units
- upper compartment has four adjustable shelves
- installed coat hook in wardrobe compartment

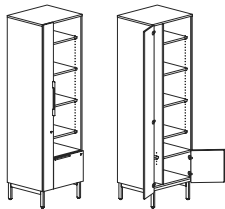
Options:

- must specify chassis grain direction on double cut veneer, see pages 13-15 for details
- veneer door fronts in paint available, specify paint color and add \$337 list; see page 16 for details
- on laminate units, contrasting doors fronts available, no upcharge; specify color, see page 16 for details
- locking doors available, specify and add \$284 list
- ledge pulls standard; prism pulls available, specify and see page 9
- vanity mirror available, specify and add \$141 list

81" h Lower Hinge Door, Open Storage Cabinet with Side Wardrobe	22	24	81	217	30	FLT2224-81SL80WR	\$3,078		
	22	24	81	217	30	FLV2224-81SL80WR		\$4,360	\$4,796
	22	24	81	217	30	FLT2224-81SL80WL	\$3,078		
	22	24	81	217	30	FLV2224-81SL80WL		\$4,360	\$4,796



right shown



left

Features:

- aligns with secondary height units
- upper compartment has four adjustable shelves
- installed coat hook in wardrobe compartment

Options:

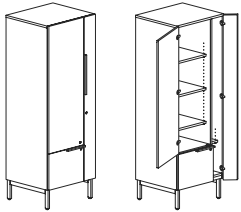
- must specify chassis grain direction on double cut veneer, see pages 13-15 for details
- veneer door fronts in paint available, specify paint color and add \$337 list; see page 16 for detail
- on laminate units, contrasting doors fronts available, no upcharge; specify color, see page 16 for details
- locking doors available, specify and add \$284 list
- ledge pulls standard; prism pulls available, specify and see page 9

To Order, Specify:

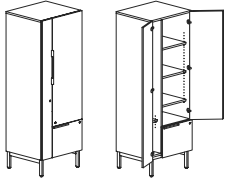
① Laminate Model #	② Laminate Type	③ Laminate Selection	④ Metal Color	⑤ Other Product Options
Laminate (FLT)	HPL	See Laminate Selection	See Metal Finish Color Options	See list of options for each specific unit; Specify and add accordingly.

① Veneer Model #	② Wood Species	③ Wood Finish - Finishes with an asterisk (*) have a coordinating laminate available	④ Metal Color	⑤ Other Product Options
Veneer (FLV)	Flat Cut CH1 Cherry MA1 Maple WA1 Walnut BO1 Black Oak	See Flat Cut Wood Finish Options	See Metal Finish Color Options	See list of options for each specific unit; Specify and add accordingly.
		<table border="1"> <tr> <th>Ⓐ Wood Finish</th> <th>Ⓑ Chassis Grain Direction</th> </tr> <tr> <td>See Double Cut Wood Finish Options</td> <td>For Double Cut Only: Vertical Horizontal</td> </tr> </table>		
Ⓐ Wood Finish	Ⓑ Chassis Grain Direction			
See Double Cut Wood Finish Options	For Double Cut Only: Vertical Horizontal			
	Double Cut DC1 Double Cut			

Description	D	W	H	CTN WT	CU FT	① Model	Laminate	Flat Cut Veneer	Double Cut Veneer
69" h File Drawer, Upper Hinge	22	24	69	229	26	FLT2224-69SL5DWR	\$3,510		
Door Storage Cabinet with Side Wardrobe	22	24	69	229	26	FLV2224-69SL5DWR		\$4,832	\$5,314
	22	24	69	229	26	FLT2224-69SL5DWL	\$3,510		
	22	24	69	229	26	FLV2224-69SL5DWL		\$4,832	\$5,314



right shown



left

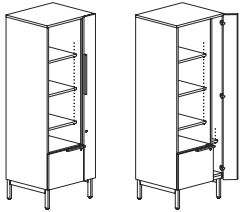
Features:

- aligns with secondary height units
- pedestal front locking
- upper compartment has three adjustable shelves
- installed coat hook in wardrobe compartment

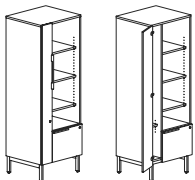
Options:

- must specify chassis grain direction on double cut veneer, see pages 13-15 for details
- veneer door and drawer front in paint available, specify paint color and add \$337; see page 16 for details
- on laminate units, contrasting door and drawer fronts available, no upcharge; specify color, see page 16 for details
- locking doors available, specify and add \$284 list
- ledge pulls standard; prism pulls available, specify and see page 9
- vanity mirror available, specify and add \$141 list

69" h File Drawer, Open Storage Cabinet with Side Wardrobe	22	24	69	204	26	FLT2224-69SL50WR	\$3,423		
	22	24	69	204	26	FLV2224-69SL50WR		\$4,706	\$5,178
	22	24	69	204	26	FLT2224-69SL50WL	\$3,423		
	22	24	69	204	26	FLV2224-69SL50WL		\$4,706	\$5,178



right shown



left

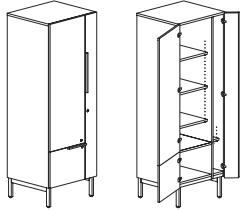
Features:

- aligns with secondary height units
- pedestal front locking
- upper compartment has three adjustable shelves
- installed coat hook in wardrobe compartment

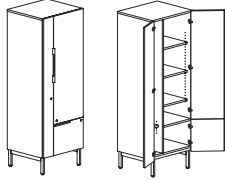
Options:

- must specify chassis grain direction on double cut veneer, see pages 13-15 for details
- veneer door and drawer front in paint available, specify paint color and add \$337; see page 16 for details
- on laminate units, contrasting door and drawer fronts available, no upcharge; specify color, see page 16 for details
- locking door available, specify and add \$142 list
- ledge pulls standard; prism pulls available, specify and see page 9

Description	D	W	H	CTN WT	CU FT	① Model	Laminate	Flat Cut Veneer	Double Cut Veneer
69" h Lower and Upper Hinge Door Storage Cabinet with Side Wardrobe	22	24	69	215	26	FLT2224-69SL8DWR	\$2,993		
	22	24	69	215	26	FLV2224-69SL8DWR		\$4,243	\$4,665
	22	24	69	215	26	FLT2224-69SL8DWL	\$2,993		
	22	24	69	215	26	FLV2224-69SL8DWL		\$4,243	\$4,665



right shown



left

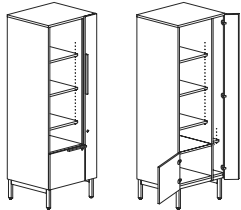
Features:

- aligns with secondary height units
- upper compartment has three adjustable shelves
- installed coat hook in wardrobe compartment

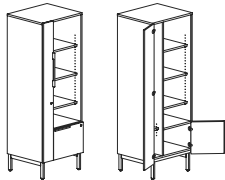
Options:

- must specify chassis grain direction on double cut veneer, see pages 13-15 for details
- veneer door fronts in paint available, specify paint color and add \$337 list; see page 16 for detail
- on laminate units, contrasting doors fronts available, no upcharge; specify color, see page 16 for details
- locking doors available, specify and add \$426 list
- ledge pulls standard; prism pulls available, specify and see page 9
- vanity mirror available, specify and add \$141 list

69" h Lower Hinge Door, Open Storage Cabinet with Side Wardrobe	22	24	69	191	26	FLT2224-69SL80WR	\$2,905		
	22	24	69	191	26	FLV2224-69SL80WR		\$4,116	\$4,528
	22	24	69	191	26	FLT2224-69SL80WL	\$2,905		
	22	24	69	191	26	FLV2224-69SL80WL		\$4,116	\$4,528



right shown



left

Features:

- aligns with secondary height units
- upper compartment has three adjustable shelves
- installed coat hook in wardrobe compartment

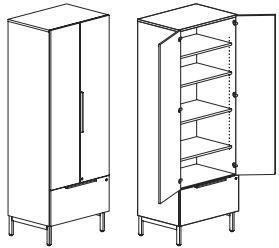
Options:

- must specify chassis grain direction on double cut veneer, see pages 13-15 for details
- veneer door fronts in paint available, specify paint color and add \$337 list; see page 16 for detail
- on laminate units, contrasting doors fronts available, no upcharge; specify color, see page 16 for details
- locking doors available, specify and add \$284 list
- ledge pulls standard; prism pulls available, specify and see page 9

To Order, Specify:

① Laminate Model #		② Laminate Selection		③ Metal Color	④ Other Product Options
Laminate (FLT)		See Laminate Selection		See Metal Finish Color Options	See list of options for each specific unit; Specify and add accordingly.
① Veneer Model #	② Wood Species	③ Wood Finish		④ Metal Color	⑤ Other Product Options
Veneer (FLV)	Flat Cut CH1 Cherry MA1 Maple WA1 Walnut BO1 Black Oak	See Flat Cut Wood Finish Options		See Metal Finish Color Options	See list of options for each specific unit; Specify and add accordingly.
	Double Cut DC1 Double Cut	3a Wood Finish See Double Cut Wood Finish Options	3b Chassis Grain Direction For Double Cut Only: Vertical Horizontal		

Description	D	W	H	CTN WT	CU FT	① Model	Laminate	Flat Cut Veneer	Double Cut Veneer
81" h File Drawer, Storage Cabinet	22	36	81	259	44	FLT2236-81SL6D	\$3,874		
	22	36	81	259	44	FLV2236-81SL6D		\$5,394	\$5,933
	22	30	81	237	37	FLT2230-81SL6D	\$3,692		
	22	30	81	237	37	FLV2230-81SL6D		\$5,157	\$5,673



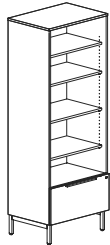
Features:

- aligns with secondary height units
- pedestal front locking
- upper compartment has four adjustable shelves

Options:

- must specify chassis grain direction on double cut veneer, see pages 13-15 for details
- veneer door and drawer front in paint available, specify paint color and add \$337; see page 16 for details
- on laminate units, contrasting door and drawer fronts available, no upcharge; specify color, see page 16 for details
- locking door available, specify and add \$142 list
- ledge pulls standard, mounted vertical; prism pulls available, specify and see page 9

81" h Lateral File Drawer, Open Storage Cabinet	22	36	81	239	44	FLT2236-81SL60	\$3,674		
	22	36	81	239	44	FLV2236-81SL60		\$5,133	\$5,645
	22	30	81	217	37	FLT2230-81SL60	\$3,505		
	22	30	81	217	37	FLV2230-81SL60		\$4,912	\$5,403



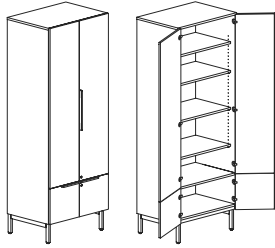
Features:

- aligns with secondary height units
- pedestal front locking
- upper compartment has four adjustable shelves

Options:

- must specify chassis grain direction on double cut veneer, see pages 13-15 for details
- veneer drawer fronts in paint available, specify paint color and add \$337 list; see page 16 for details
- on laminate units, contrasting door front available, no upcharge; specify color, see page 16 for details
- ledge pulls standard; prism pulls available, specify and see page 9

Description	D	W	H	CTN WT	CU FT	① Model	Laminate	Flat Cut Veneer	Double Cut Veneer
81" Lower and Upper Hinge Door Storage Cabinet	22	36	81	240	44	FLT2236-81SL8D	\$3,308		
	22	36	81	240	44	FLV2236-81SL8D		\$4,793	\$5,273
	22	30	81	223	37	FLT2230-81SL8D	\$3,139		
	22	30	81	223	37	FLV2230-81SL8D		\$4,579	\$5,036



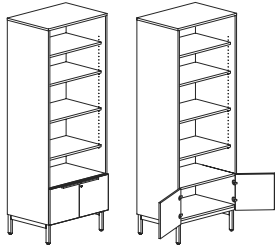
Features:

- aligns with secondary height units
- upper compartment has four adjustable shelves

Options:

- must specify chassis grain direction on double cut veneer, see pages 13-15 for details
- veneer door fronts in paint available, specify paint color and add \$337 list; see page 16 for details
- on laminate units, contrasting doors fronts available, no upcharge; specify color, see page 16 for details
- locking doors available, specify and add \$284 list
- ledge pulls standard; prism pulls available, specify and see page 9

81" Lower Hinge Doors, Open Storage Cabinet	22	36	81	219	44	FLT2236-81SL80	\$3,109		
	22	36	81	219	44	FLV2236-81SL80		\$4,532	\$4,985
	22	30	81	202	37	FLT2230-81SL80	\$2,956		
	22	30	81	202	37	FLV2230-81SL80		\$4,333	\$4,768



Features:

- aligns with secondary height units
- upper compartment has four adjustable shelves

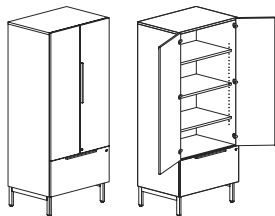
Options:

- must specify chassis grain direction on double cut veneer, see pages 13-15 for details
- veneer door fronts in paint available, specify paint color and add \$337 list; see page 16 for details
- on laminate units, contrasting doors fronts available, no upcharge; specify color, see page 16 for details
- locking door available, specify and add \$142 list
- ledge pulls standard; prism pulls available, specify and see page 9

To Order, Specify:

① Laminate Model #		② Laminate Selection		③ Metal Color	④ Other Product Options		
Laminate (FLT)		See Laminate Selection		See Metal Finish Color Options	See list of options for each specific unit; Specify and add accordingly.		
① Veneer Model #	② Wood Species	③ Wood Finish		④ Metal Color	⑤ Other Product Options		
Veneer (FLV)	Flat Cut CH1 Cherry MA1 Maple WA1 Walnut BO1 Black Oak	See Flat Cut Wood Finish Options		See Metal Finish Color Options	See list of options for each specific unit; Specify and add accordingly.		
	Double Cut DC1 Double Cut	<table border="1"> <thead> <tr> <th>Ⓐ Wood Finish</th> <th>Ⓑ Chassis Grain Direction</th> </tr> </thead> <tbody> <tr> <td>See Double Cut Wood Finish Options</td> <td>For Double Cut Only: Vertical Horizontal</td> </tr> </tbody> </table>	Ⓐ Wood Finish	Ⓑ Chassis Grain Direction	See Double Cut Wood Finish Options	For Double Cut Only: Vertical Horizontal	
Ⓐ Wood Finish	Ⓑ Chassis Grain Direction						
See Double Cut Wood Finish Options	For Double Cut Only: Vertical Horizontal						

Description	D	W	H	CTN WT	CU FT	① Model	Laminate	Flat Cut Veneer	Double Cut Veneer
69" h Lateral File Drawer, Storage Cabinet	22	36	69	259	38	FLT2236-69SL6D	\$3,575		
	22	36	69	259	38	FLV2236-69SL6D		\$4,970	\$5,466
	22	30	69	237	32	FLT2230-69SL6D	\$3,422		
	22	30	69	237	32	FLV2230-69SL6D		\$4,771	\$5,247



Features:

- aligns with secondary height units
- pedestal front locking
- upper compartment has three adjustable shelves

Options:

- must specify chassis grain direction on double cut veneer, see pages 13-15 for details
- veneer door and drawer front in paint available, specify paint color and add \$337; see page 16 for details
- on laminate units, contrasting door and drawer fronts available, no upcharge; specify color, see page 16 for details
- locking door available, specify and add \$142 list
- ledge pulls standard; prism pulls available, specify and see page 9

Description	D	W	H	CTN WT	CU FT	① Model	Laminate	Flat Cut Veneer	Double Cut Veneer
69" h Lateral File Drawer, Open Storage Cabinet	22	36	69	239	38	FLT2236-69SL60	\$3,412		
	22	36	69	239	38	FLV2236-69SL60		\$4,761	\$5,233
	22	30	69	217	32	FLT2230-69SL60	\$3,267		
	22	30	69	217	32	FLV2230-69SL60		\$4,572	\$5,029



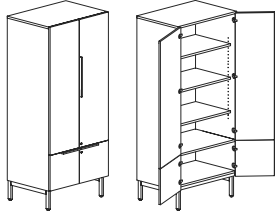
Features:

- aligns with secondary height units
- pedestal front locking
- upper compartment has three adjustable shelves

Options:

- must specify chassis grain direction on double cut veneer, see pages 13-15 for details
- veneer drawer fronts in paint available, specify paint color and add \$337 list; see page 16 for details
- on laminate units, contrasting door front available, no upcharge; specify color, see page 16 for details
- ledge pulls standard; prism pulls available, specify and see page 9

Description	D	W	H	CTN WT	CU FT	① Model	Laminate	Flat Cut Veneer	Double Cut Veneer
69" Lower and Upper Hinge Door Storage Cabinet	22	36	69	240	38	FLT2236-69SL8D	\$3,128		
	22	36	69	240	38	FLV2236-69SL8D		\$4,484	\$4,932
	22	30	69	223	32	FLT2230-69SL8D	\$2,986		
	22	30	69	223	32	FLV2230-69SL8D		\$4,311	\$4,740



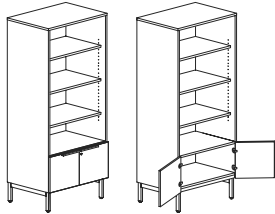
Features:

- aligns with secondary height units
- upper compartment has three adjustable shelves

Options:

- must specify chassis grain direction on double cut veneer, see pages 13-15 for details
- veneer door fronts in paint available, specify paint color and add \$337 list; see page 16 for details
- on laminate units, contrasting doors fronts available, no upcharge; specify color, see page 16 for details
- locking doors available, specify and add \$284 list
- ledge pulls standard; prism pulls available, specify and see page 9

69" Lower Hinge Doors, Open Storage Cabinet	22	36	69	219	38	FLT2236-69SL80	\$2,964		
	22	36	69	219	38	FLV2236-69SL80		\$4,275	\$4,701
	22	30	69	202	32	FLT2230-69SL80	\$2,832		
	22	30	69	202	32	FLV2230-69SL80		\$4,110	\$4,522



Features:

- aligns with secondary height units
- upper compartment has three adjustable shelves

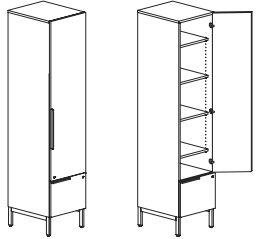
Options:

- must specify chassis grain direction on double cut veneer, see pages 13-15 for details
- veneer door fronts in paint available, specify paint color and add \$337 list; see page 16 for details
- on laminate units, contrasting doors fronts available, no upcharge; specify color, see page 16 for details
- locking door available, specify and add \$142 list
- ledge pulls standard; prism pulls available, specify and see page 9

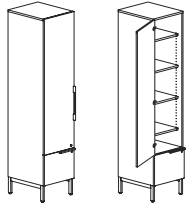
To Order, Specify:

① Laminate Model #		② Laminate Selection		③ Metal Color	④ Other Product Options
Laminate (FLT)		See Laminate Selection		See Metal Finish Color Options	See list of options for each specific unit; Specify and add accordingly.
① Veneer Model #	② Wood Species	③ Wood Finish		④ Metal Color	⑤ Other Product Options
Veneer (FLV)	Flat Cut CH1 Cherry MA1 Maple WA1 Walnut BO1 Black Oak	See Flat Cut Wood Finish Options		See Metal Finish Color Options	See list of options for each specific unit; Specify and add accordingly.
	Double Cut DC1 Double Cut	③a Wood Finish	③b Chassis Grain Direction		
		See Double Cut Wood Finish Options	For Double Cut Only: Vertical Horizontal		

Description	D	W	H	CTN WT	CU FT	① Model	Laminate	Flat Cut Veneer	Double Cut Veneer
81" h File Drawer, Storage Cabinet	22	18	81	201	24	FLT2218-81SL5DR	\$3,020		
	22	18	81	201	24	FLV2218-81SL5DR		\$4,013	\$4,415
	22	18	81	201	24	FLT2218-81SL5DL	\$3,020		
	22	18	81	201	24	FLV2218-81SL5DL		\$4,013	\$4,415



right shown



left

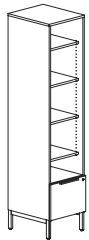
Features:

- aligns with secondary height units
- upper compartment has four adjustable shelves

Options:

- must specify chassis grain direction on double cut veneer, see pages 13-15 for details
- veneer door and drawer front in paint available, specify paint color and add \$337; see page 16 for details
- on laminate units, contrasting door and drawer fronts available, no upcharge; specify color, see page 16 for details
- locking door available, specify and add \$142 list
- ledge pulls standard; prism pulls available, specify and see page 9
- vanity mirror available, specify and add \$141 list

81" h File Drawer, Open Storage Cabinet	22	18	81	176	23	FLT2218-81SL50	\$2,911		
	22	18	81	176	23	FLV2218-81SL50		\$3,856	\$4,740



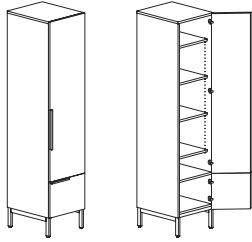
Features:

- aligns with secondary height units
- pedestal front locking
- upper compartment has four adjustable shelves

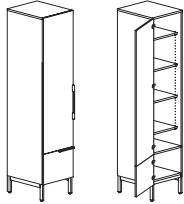
Options:

- must specify chassis grain direction on double cut veneer, see pages 13-15 for details
- veneer drawer fronts in paint available, specify paint color and add \$337 list; see page 16 for details
- on laminate units, contrasting door front available, no upcharge; specify color, see page 16 for details
- ledge pulls standard; prism pulls available, specify and see page 9

Description	D	W	H	CTN WT	CU FT	① Model	Laminate	Flat Cut Veneer	Double Cut Veneer
81" h Lower and Upper Hinge Door Storage Cabinet	22	18	81	187	24	FLT2218-81SL8DR	\$2,590		
	22	18	81	187	24	FLV2218-81SL8DR		\$3,550	\$3,904
	22	18	81	187	24	FLT2218-81SL8DL	\$2,590		
	22	18	81	187	24	FLV2218-81SL8DL		\$3,550	\$3,904



right shown



left

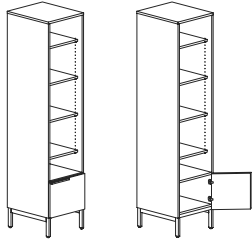
Features:

- aligns with secondary height units
- upper compartment has four adjustable shelves

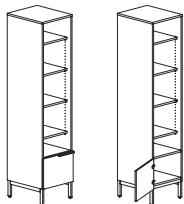
Options:

- must specify chassis grain direction on double cut veneer, see pages 13-15 for details
- veneer door fronts in paint available, specify paint color and add \$337 list; see page 16 for details
- on laminate units, contrasting doors fronts available, no upcharge; specify color, see page 16 for details
- locking doors available, specify and add \$284 list; ledge pulls standard; prism pulls available, specify and see page 9
- vanity mirror available, specify and add \$141 list

81" h Lower Hinge Door, Open Storage Cabinet	22	18	81	163	24	FLT2218-81SL80R	\$2,482		
	22	18	81	163	24	FLV2218-81SL80R		\$3,392	\$3,731
	22	18	81	163	24	FLT2218-81SL80L	\$2,482		
	22	18	81	163	24	FLV2218-81SL80L		\$3,392	\$3,731



right shown



left

Features:

- aligns with secondary height units
- upper compartment has four adjustable shelves

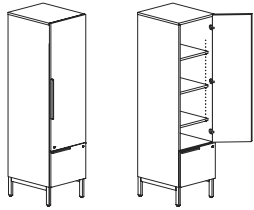
Options:

- must specify chassis grain direction on double cut veneer, see pages 13-15 for details
- veneer door front in paint available, specify paint color and add \$337 list; see page 16 for details
- on laminate units, contrasting doors fronts available, no upcharge; specify color, see page 16 for details
- locking lower door available, specify and add \$142 list
- ledge pulls standard; prism pulls available, specify and see page 9

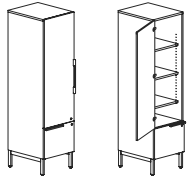
To Order, Specify:

① Laminate Model #		② Laminate Selection		③ Metal Color	④ Other Product Options
Laminate (FLT)		See Laminate Selection		See Metal Finish Color Options	See list of options for each specific unit; Specify and add accordingly.
① Veneer Model #	② Wood Species	③ Wood Finish		④ Metal Color	⑤ Other Product Options
Veneer (FLV)	Flat Cut CH1 Cherry MA1 Maple WA1 Walnut BO1 Black Oak	See Flat Cut Wood Finish Options		See Metal Finish Color Options	See list of options for each specific unit; Specify and add accordingly.
	Double Cut DC1 Double Cut	3a Wood Finish See Double Cut Wood Finish Options	3b Chassis Grain Direction For Double Cut Only: Vertical Horizontal		

Description	D	W	H	CTN WT	CU FT	① Model	Laminate	Flat Cut Veneer	Double Cut Veneer
69" h File Drawer, Storage Cabinet	22	18	69	179	20	FLT2218-69SL5DR	\$3,020		
	22	18	69	179	20	FLV2218-69SL5DR		\$4,013	\$4,415
	22	18	69	179	20	FLT2218-69SL5DL	\$3,020		
	22	18	69	179	20	FLV2218-69SL5DL		\$4,013	\$4,415



right shown



left

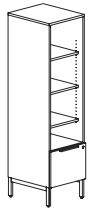
Features:

- aligns with secondary height units
- pedestal front locking
- upper compartment has three adjustable shelves

Options:

- must specify chassis grain direction on double cut veneer, see pages 13-15 for details
- veneer door and drawer front in paint available, specify paint color and add \$337; see page 16 for details
- on laminate units, contrasting door and drawer fronts available, no upcharge; specify color, see page 16 for details
- locking door available, specify and add \$142 list
- ledge pulls standard; prism pulls available, specify and see page 9
- vanity mirror available, specify and add \$141 list

69" h File Drawer, Open Storage Cabinet	22	18	69	154	20	FLT2218-69SL50	\$2,911		
	22	18	69	154	20	FLV2218-69SL50		\$3,856	\$4,244



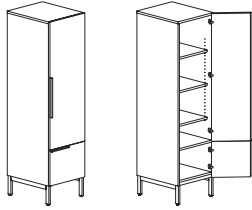
Features:

- aligns with secondary height units
- pedestal front locking
- upper compartment has three adjustable shelves

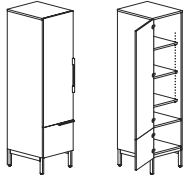
Options:

- must specify chassis grain direction on double cut veneer, see pages 13-15 for details
- veneer drawer fronts in paint available, specify paint color and add \$337 list; see page 16 for details
- on laminate units, contrasting door front available, no upcharge; specify color, see page 16 for details
- ledge pulls standard; prism pulls available, specify and see page 9

Description	D	W	H	CTN WT	CU FT	① Model	Laminate	Flat Cut Veneer	Double Cut Veneer
69" h Lower and Upper Hinge Door Storage Cabinet	22	18	69	166	20	FLT2218-69SL8DR	\$2,590		
	22	18	69	166	20	FLV2218-69SL8DR		\$3,550	\$3,904
	22	18	69	166	20	FLT2218-69SL8DL	\$2,590		
	22	18	69	166	20	FLV2218-69SL8DL		\$3,550	\$3,904



right shown



left

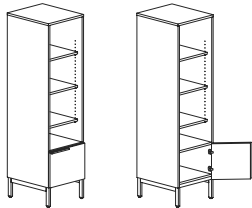
Features:

- aligns with secondary height units
- upper compartment has three adjustable shelves, lower compartment has one adjustable shelf

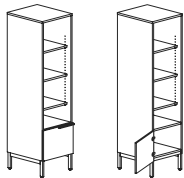
Options:

- must specify chassis grain direction on double cut veneer, see pages 13-15 for details
- veneer door fronts in paint available, specify paint color and add \$337 list; see page 16 for details
- on laminate units, contrasting doors fronts available, no upcharge; specify color, see page 16 for details
- locking doors available, specify and add \$284 list
- ledge pulls standard; prism pulls available, specify and see page 9
- vanity mirror available, specify and add \$141 list

69" h Lower Hinge Door, Open Storage Cabinet	22	18	69	141	20	FLT2218-69SL80R	\$2,482		
	22	18	69	141	20	FLV2218-69SL80R		\$3,392	\$3,731
	22	18	69	141	20	FLT2218-69SL80L	\$2,482		
	22	18	69	141	20	FLV2218-69SL80L		\$3,392	\$3,731



right shown



left

Features:

- aligns with secondary height units
- upper compartment has three adjustable shelves, lower compartment has one adjustable shelf

Options:

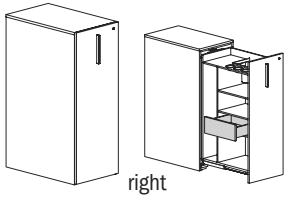
- must specify chassis grain direction on double cut veneer, see pages 13-15 for details
- veneer drawer fronts in paint available, specify paint color and add \$337 list; see page 16 for details
- on laminate units, contrasting door front available, no upcharge; specify color, see page 16 for details
- locking door available, specify and add \$142 list
- ledge pulls standard; prism pulls available, specify and see page 9

To Order, Specify:

① Laminate Model #		② Laminate Selection		③ Metal Color	④ Other Product Options
Laminate (FLT)		See Laminate Selection		See Metal Finish Color Options	See list of options for each specific unit; Specify and add accordingly.
① Veneer Model #	② Wood Species	③ Wood Finish		④ Metal Color	⑤ Other Product Options
Veneer (FLV)	Flat Cut CH1 Cherry MA1 Maple WA1 Walnut BO1 Black Oak	See Flat Cut Wood Finish Options		See Metal Finish Color Options	See list of options for each specific unit; Specify and add accordingly.
	Double Cut DC1 Double Cut	ⓐ Wood Finish See Double Cut Wood Finish Options	ⓑ Chassis Grain Direction For Double Cut Only: Vertical Horizontal		

FLUX - PRIVATE OFFICE

Description	D	W	H	CTN WT	CU FT	① Model	Laminate	Flat Cut Veneer	Double Cut Veneer
48" h Pantry Drawer with Filing and Wardrobe, Single User	30	18	48	254	23	FLT3018-48PTAR	\$2,744		
	30	18	48	254	23	FLV3018-48PTAR		\$3,531	\$3,868
	30	18	48	254	23	FLT3018-48PTAL	\$2,744		
	30	18	48	254	23	FLV3018-48PTAL		\$3,531	\$3,868



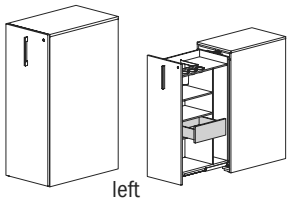
right

Features:

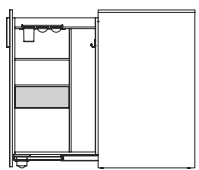
- filing brackets, accessory trays, fixed shelf, box drawer and wardrobe coat hook
- may not be used with Mid Support bracket to support Bench or Table Surfaces
- drawer extends 26"

Options:

- must specify drawer interior color, Designer White or Slate Grey
- must specify chassis grain direction on double cut veneer, see pages 13-15 for details
- veneer door and drawer fronts available in contrasting paint color, specify paint color and add \$337 list; see pages 16 for details
- laminate door and drawer fronts available in contrasting color, no upcharge, specify color; see pages 16 for details
- ledge pulls standard; prism pulls available, specify and see page 9
- locking door available, specify and add \$142 list
- wire pass-thru grommets available, specify and add \$114 list
- markerboard available on drawer back panel, specify and add \$510 list
- power jumper available; specify and add \$45 list. (wire pass-thru grommet option must also be specified.)



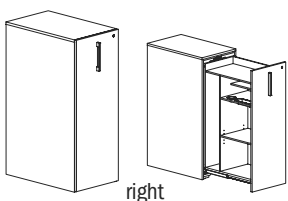
left



side view

FLUX - PRIVATE OFFICE

48" h Pantry Drawer with Paper Sorter and Wardrobe, Single User	30	18	48	234	23	FLT3018-48PTBR	\$2,621		
	30	18	48	234	23	FLV3018-48PTBR		\$3,409	\$3,733
	30	18	48	234	23	FLT3018-48PTBL	\$2,621		
	30	18	48	234	23	FLV3018-48PTBL		\$3,409	\$3,733
	24	18	48	169	18	FLT2418-48PTBR	\$2,551		
	24	18	48	169	18	FLV2418-48PTBR		\$3,316	\$3,599
	24	18	48	169	18	FLT2418-48PTBL	\$2,551		
	24	18	48	169	18	FLV2418-48PTBL		\$3,316	\$3,599



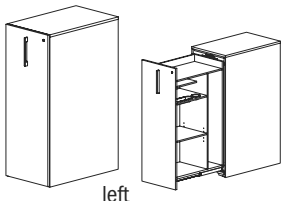
right

Features:

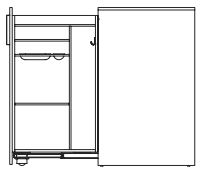
- paper shelves, accessory trays, fixed shelves and wardrobe coat hook
- may not be used with Mid Support bracket to support Bench or Table Surfaces
- drawer extends 26" on 30"d units, 20" on 24"d units

Options:

- must specify drawer interior color, Designer White or Slate Grey
- must specify chassis grain direction on double cut veneer, see pages 13-15 for details
- veneer door and drawer fronts available in contrasting paint color, specify paint color and add \$337 list; see pages 16 for details
- laminate door and drawer fronts available in contrasting color, no upcharge, specify color; see pages 16 for details
- ledge pulls standard; prism pulls available, specify and see page 9
- locking door available, specify and add \$142 list
- wire pass-thru grommets available, specify and add \$114 list
- markerboard available on drawer back panel, specify and add \$510 list
- power jumper available; specify and add \$45 list. (wire pass-thru grommet option must also be specified.)

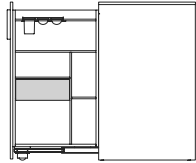
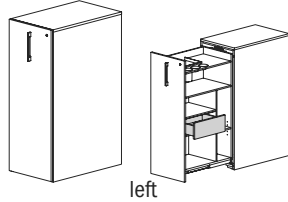
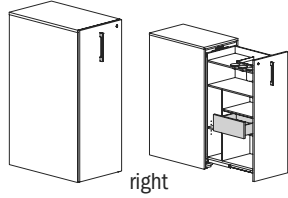


left



side view

Description	D	W	H	CTN WT	CU FT	① Model	Laminate	Flat Cut Veneer	Double Cut Veneer
48" h Pantry Drawer with Filing, Single User	30	18	48	218	23	FLT3018-48PTCR	\$2,657		
	30	18	48	218	23	FLV3018-48PTCR		\$3,458	\$3,786
	30	18	48	218	23	FLT3018-48PTCL	\$2,657		
	30	18	48	218	23	FLV3018-48PTCL		\$3,458	\$3,786
	24	18	48	192	18	FLT2418-48PTCR	\$2,588		
	24	18	48	192	18	FLV2418-48PTCR		\$3,366	\$3,652
	24	18	48	192	18	FLT2418-48PTCL	\$2,588		
	24	18	48	192	18	FLV2418-48PTCL		\$3,366	\$3,652



Features:

- filing brackets, accessory trays, fixed shelves and box drawer
- may not be used with Mid Support bracket to support Bench or Table Surfaces
- drawer extends 26" on 30" d units, 20" on 24" d units

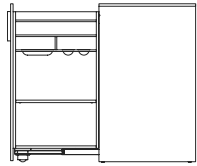
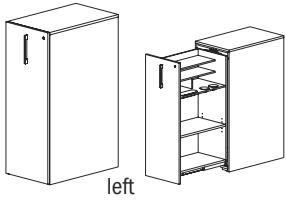
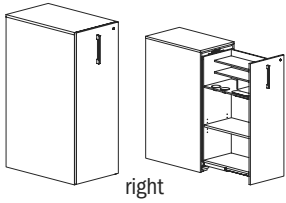
Options:

- must specify drawer interior color, Designer White or Slate Grey
- must specify chassis grain direction on double cut veneer, see pages 13-15 for details
- veneer door and drawer fronts available in contrasting paint color, specify paint color and add \$337 list; see pages 16 for details
- laminate door and drawer fronts available in contrasting color, no upcharge, specify color; see pages 16 for details
- ledge pulls standard; prism pulls available, specify and see page 9
- locking door available, specify and add \$142 list
- wire pass-thru grommets available, specify and add \$114 list
- markerboard available on drawer back panel, specify and add \$510 list
- power jumper available; specify and add \$45 list. (wire pass-thru grommet option must also be specified.)

To Order, Specify:

① Laminate Model #		② Laminate Selection		③ Metal Color	④ Other Product Options
Laminate (FLT)		See Laminate Selection		See Metal Finish Color Options	See list of options for each specific unit; Specify and add accordingly.
① Veneer Model #	② Wood Species	③ Wood Finish		④ Metal Color	⑤ Other Product Options
Veneer (FLV)	Flat Cut CH1 Cherry MA1 Maple WA1 Walnut BO1 Black Oak	See Flat Cut Wood Finish Options		See Metal Finish Color Options	See list of options for each specific unit; Specify and add accordingly.
	Double Cut DC1 Double Cut	3a Wood Finish	3b Chassis Grain Direction		
		See Double Cut Wood Finish Options	For Double Cut Only: Vertical Horizontal		

Description	D	W	H	CTN WT	CU FT	① Model	Laminate	Flat Cut Veneer	Double Cut Veneer
48" h Pantry Drawer with Paper Sorter, Single User	30	18	48	209	23	FLT3018-48PTDR	\$2,596		
	30	18	48	209	23	FLV3018-48PTDR		\$3,377	\$3,699
	30	18	48	209	23	FLT3018-48PTDL	\$2,596		
	30	18	48	209	23	FLV3018-48PTDL		\$3,377	\$3,699
	24	18	48	163	18	FLT2418-48PTDR	\$2,528		
	24	18	48	163	18	FLV2418-48PTDR		\$3,285	\$3,566
	24	18	48	163	18	FLT2418-48PTDL	\$2,528		
	24	18	48	163	18	FLV2418-48PTDL		\$3,285	\$3,566



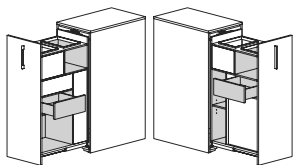
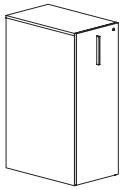
Features:

- paper shelves, accessory trays and fixed shelves
- may not be used with Mid Support bracket to support Bench or Table Surfaces
- drawer extends 26" on 30"d units, 20" on 24"d units

Options:

- must specify drawer interior color, Designer White or Slate Grey
- must specify chassis grain direction on double cut veneer, see pages 13-15 for details
- veneer door and drawer fronts available in contrasting paint color, specify paint color and add \$337 list; see pages 16 for details
- laminate door and drawer fronts available in contrasting color, no upcharge, specify color; see pages 16 for details
- ledge pulls standard; prism pulls available, specify and see page 9
- locking door available, specify and add \$142 list
- wire pass-thru grommets available, specify and add \$114 list
- markerboard available on drawer back panel, specify and add \$510 list
- power jumper available; specify and add \$45 list. (wire pass-thru grommet option must also be specified.)

48" h Pantry Drawer, Dual User	30	18	48	225	23	FLT3018-48PTE	\$2,782		
	30	18	48	225	23	FLV3018-48PTE		\$3,623	\$3,967
	24	18	48	184	18	FLT2418-48PTE	\$2,710		
	24	18	48	184	18	FLV2418-48PTE		\$3,524	\$3,860



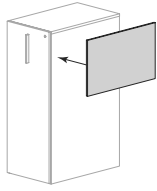
Features:

- filing brackets, fixed shelves and box drawer for each side
- may not be used with Mid Support bracket to support Bench or Table Surfaces
- drawer extends 26" on 30"d units, 20" on 24"d units

Options:

- must specify drawer interior color, Designer White or Slate Grey
- must specify chassis grain direction on double cut veneer, see pages 13-15 for details
- veneer door and drawer fronts available in contrasting paint color, specify paint color and add \$337 list; see pages 16 for details
- laminate door and drawer fronts available in contrasting color, no upcharge, specify color; see pages 16 for details
- ledge pulls standard; prism pulls available, specify and see page 9
- locking door available, specify and add \$142 list
- wire pass-thru grommets available, specify and add \$114 list
- power jumper available; specify and add \$45 list. (wire pass-thru grommet option must also be specified.)

Description	D	W	H	CTN WT	CU FT	① Model	List Price
Tack Panel	½	28 7/8	17 ½	13	2	FLB30-18B1-FTK	\$183
	½	23 1/8	17 ½	12	2	FLB24-18B1-FTK	\$150



Features:

- mounts to sides of 48”h Storage Cabinets
- sizes coordinate with depth of Storage Cabinets

Options:

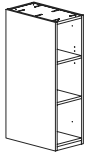
- select color, ash grey or silver grey

To Order, Specify:

① Laminate Model #	② Laminate Type	③ Laminate Selection	④ Metal Color	⑤ Other Product Options
Laminate (FLT)	HPL	See Laminate Selection	See Metal Finish Color Options	See list of options for each specific unit; Specify and add accordingly.

① Veneer Model #	② Wood Species	③ Wood Finish - Finishes with an asterisk (*) have a coordinating laminate available	④ Metal Color	⑤ Other Product Options
Veneer (FLV)	Flat Cut CH1 Cherry MA1 Maple WA1 Walnut BO1 Black Oak	See Flat Cut Wood Finish Options	See Metal Finish Color Options	See list of options for each specific unit; Specify and add accordingly.
	Double Cut DC1 Double Cut	ⓐ Wood Finish See Double Cut Wood Finish Options		

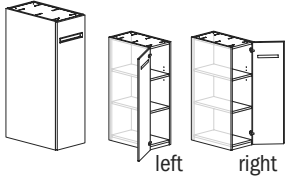
Description	D	W	H	CTN WT	CU FT	① Model	List Price
42" h Locker - Open Shelves	22	12	42	77	11	FLT2212-42FLK-E	\$1,073
	18	12	42	65	9	FLT1812-42FLK-E	\$1,013



Features:

- must be connected to another locker with a common top, this unit is not freestanding; see pages 450-452 for modular tops
- one adjustable shelf and one fixed shelf (lower)
- unfinished back; modular common top & finished back panels available

42" h Locker - Storage Cabinet	22	12	42	98	11	FLT2212-42FLK-EDR	\$1,271
	22	12	42	98	11	FLT2212-42FLK-EDL	\$1,271
	18	12	42	86	9	FLT1812-42FLK-EDR	\$1,204
	18	12	42	86	9	FLT1812-42FLK-EDL	\$1,204



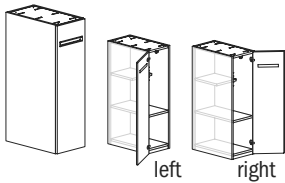
Features:

- must be connected to another locker with a common top, this unit is not freestanding; see pages 450-452 for modular tops
- one adjustable shelf and one fixed shelf (lower)
- unfinished back; modular common top & finished back panels available

Options:

- laminate door fronts available in contrasting color, no upcharge, specify color
- specify pull; see page 10
- locking options available; see page 455 for details and upcharge
- number plate available, order separately; see page 455

42" h Locker - Storage Cabinet with Wardrobe Hooks	22	12	42	96	11	FLT2212-42FLK-BDR	\$1,324
	22	12	42	96	11	FLT2212-42FLK-BDL	\$1,324
	18	12	42	85	9	FLT1812-42FLK-BDR	\$1,258
	18	12	42	85	9	FLT1812-42FLK-BDL	\$1,258



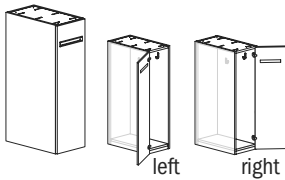
Features:

- must be connected to another locker with a common top, this unit is not freestanding; see pages 450-452 for modular tops
- one full depth fixed shelf, one shallow adjustable shelf and two coat hooks
- unfinished back; modular common top & finished back panels available

Options:

- laminate door fronts available in contrasting color, no upcharge, specify color
- specify pull; see page 10
- locking options available; see page 455 for details and upcharge
- number plate available, order separately; see page 455

42" h Locker - Wardrobe	22	12	42	89	11	FLT2212-42FLK-CDR	\$1,265
	22	12	42	89	11	FLT2212-42FLK-CDL	\$1,265
	18	12	42	79	9	FLT1812-42FLK-CDR	\$1,200
	18	12	42	79	9	FLT1812-42FLK-CDL	\$1,200



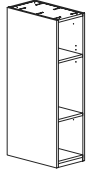
Features:

- must be connected to another locker with a common top, this unit is not freestanding; see pages 450-452 for modular tops
- one wardrobe bar in 22" d units; two coat hooks in 18" d units
- unfinished back; modular common top & finished back panels available

Options:

- laminate door fronts available in contrasting color, no upcharge, specify color
- specify pull; see page 10
- locking options available; see page 455 for details and upcharge
- number plate available, order separately; see page 455

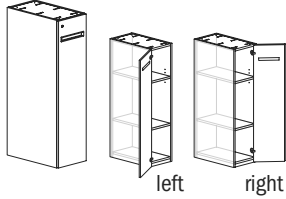
Description	D	W	H	CTN WT	CU FT	① Model	List Price
48" h Locker - Open Shelves	22	12	48	84	13	FLT2212-48FLK-E	\$1,123
	18	12	48	65	11	FLT1812-48FLK-E	\$1,062



Features:

- must be connected to another locker with a common top, this unit is not freestanding; see pages 450-452 for modular tops
- one adjustable shelf and one fixed shelf (lower)
- unfinished back; modular common top & finished back panels available

48" h Locker - Storage Cabinet	D	W	H	CTN WT	CU FT	Model	List Price
	22	12	48	107	13	FLT2212-48FLK-EDR	\$1,330
	22	12	48	107	13	FLT2212-48FLK-EDL	\$1,330
	18	12	48	86	11	FLT1812-48FLK-EDR	\$1,260
	18	12	48	86	11	FLT1812-48FLK-EDL	\$1,260



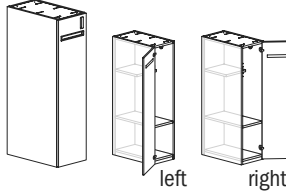
Features:

- must be connected to another locker with a common top, this unit is not freestanding; see pages 450-452 for modular tops
- one adjustable shelf and one fixed shelf (lower)
- unfinished back; modular common top & finished back panels available

Options:

- laminate door fronts available in contrasting color, no upcharge, specify color
- specify pull; see page 10
- locking options available; see page 455 for details and upcharge
- number plate available, order separately; see page 455

48" h Locker - Storage Cabinet with Wardrobe Hooks	D	W	H	CTN WT	CU FT	Model	List Price
	22	12	48	106	13	FLT2212-48FLK-BDR	\$1,382
	22	12	48	106	13	FLT2212-48FLK-BDL	\$1,382
	18	12	48	94	11	FLT1812-48FLK-BDR	\$1,314
	18	12	48	94	11	FLT1812-48FLK-BDL	\$1,314



Features:

- must be connected to another locker with a common top, this unit is not freestanding; see pages 450-452 for modular tops
- one full depth fixed shelf, one shallow adjustable shelf and two coat hooks
- unfinished back; modular common top & finished back panels available

Options:

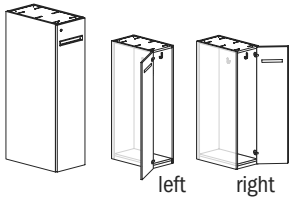
- laminate door fronts available in contrasting color, no upcharge, specify color
- specify pull; see page 10
- locking options available; see page 455 for details and upcharge
- number plate available, order separately; see page 455

To Order, Specify:

① Laminate Model #	② Laminate Type	③ Laminate Selection	④ Metal Color	⑤ Other Product Options
Laminate (FLT)	HPL	See Laminate Selection	See Metal Finish Color Options	See list of options for each specific unit; Specify and add accordingly.

① Veneer Model #	② Wood Species	③ Wood Finish - Finishes with an asterisk (*) have a coordinating laminate available	④ Metal Color	⑤ Other Product Options
Veneer (FLV)	Flat Cut CH1 Cherry MA1 Maple WA1 Walnut BO1 Black Oak	See Flat Cut Wood Finish Options	See Metal Finish Color Options	See list of options for each specific unit; Specify and add accordingly.
		ⓐ Wood Finish See Double Cut Wood Finish Options		
	Double Cut DC1 Double Cut			

Description	D	W	H	CTN WT	CU FT	① Model	List Price
48" h Locker - Wardrobe	22	12	48	99	13	FLT2212-48FLK-CDR	\$1,326
	22	12	48	99	13	FLT2212-48FLK-CDL	\$1,326
	18	12	48	88	11	FLT1812-48FLK-CDR	\$1,258
	18	12	48	88	11	FLT1812-48FLK-CDL	\$1,258



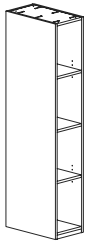
Features:

- must be connected to another locker with a common top, this unit is not freestanding; see pages 450-452 for modular tops
- one wardrobe bar in 22" d units; two coat hooks in 18" d units
- unfinished back; modular common top & finished back panels available

Options:

- laminate door fronts available in contrasting color, no upcharge, specify color
- specify pull; see page 10
- locking options available; see page 455 for details and upcharge
- number plate available, order separately; see page 455

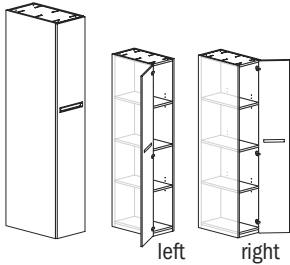
69" h Locker - Open Shelves	22	12	69	116	13	FLT2212-69FLK-F	\$1,257
	18	12	69	98	11	FLT1812-69FLK-F	\$1,188



Features:

- must be connected to another locker with a common top, this unit is not freestanding; see pages 450-452 for modular tops
- two adjustable shelves and one fixed shelf (center)
- unfinished back; modular common top & finished back panels available

69" h Locker - Storage Cabinet	22	12	69	150	18	FLT2212-69FLK-FDR	\$1,490
	22	12	69	150	18	FLT2212-69FLK-FDL	\$1,490
	18	12	69	133	15	FLT1812-69FLK-FDR	\$1,412
	18	12	69	133	15	FLT1812-69FLK-FDL	\$1,412



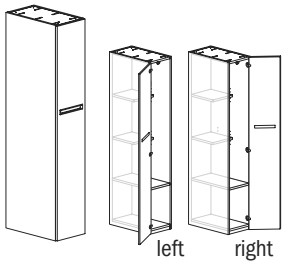
Features:

- must be connected to another locker with a common top, this unit is not freestanding; see pages 450-452 for modular tops
- two adjustable shelves and one fixed shelf (center)
- unfinished back; modular common top & finished back panels available

Options:

- laminate door fronts available in contrasting color, no upcharge, specify color
- specify pull; see page 10
- locking options available; see page 455 for details and upcharge
- number plate available, order separately; see page 455

69" h Locker - Storage Cabinet with Wardrobe Hooks	22	12	69	146	18	FLT2212-69FLK-GDR	\$1,548
	22	12	69	146	18	FLT2212-69FLK-GDL	\$1,548
	18	12	69	130	15	FLT1812-69FLK-GDR	\$1,472
	18	12	69	130	15	FLT1812-69FLK-GDL	\$1,472



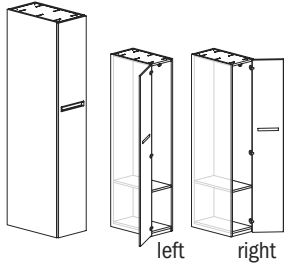
Features:

- must be connected to another locker with a common top, this unit is not freestanding; see pages 450-452 for modular tops
- one full depth fixed shelf, two shallow adjustable shelves and two coat hooks
- unfinished back; modular common top & finished back panels available

Options:

- laminate door fronts available in contrasting color, no upcharge, specify color
- specify pull; see page 452
- locking options available; see page 452 for details and upcharge
- number plate available, order separately; see page 455

Description	D	W	H	CTN WT	CU FT	① Model	List Price
69" h Locker - Wardrobe	22	12	69	141	18	FLT2212-69FLK-HDR	\$1,510
	22	12	69	141	18	FLT2212-69FLK-HDL	\$1,510
	18	12	69	125	15	FLT1812-69FLK-HDR	\$1,433
	18	12	69	125	15	FLT1812-69FLK-HDL	\$1,433



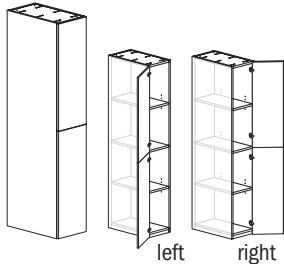
Features:

- must be connected to another locker with a common top, this unit is not freestanding; see pages 450-452 for modular tops
- one full depth fixed shelf and one wardrobe bar in 22" d units; two coat hooks in 18" d units
- unfinished back; modular common top & finished back panels available

Options:

- laminate door fronts available in contrasting color, no upcharge, specify color
- specify pull; see page 10
- locking options available; see page 455 for details and upcharge
- number plate available, order separately; see page 455

69" h Dual Locker - Storage Cabinet	22	12	69	151	18	FLT2212-69FLK-F2DR	\$1,531
	22	12	69	151	18	FLT2212-69FLK-F2DL	\$1,531
	18	12	69	133	15	FLT1812-69FLK-F2DR	\$1,452
	18	12	69	133	15	FLT1812-69FLK-F2DL	\$1,452



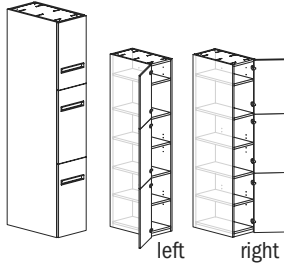
Features:

- must be connected to another locker with a common top, this unit is not freestanding; see pages 450-452 for modular tops
- one adjustable shelf per compartment
- unfinished back; modular common top & finished back panels available

Options:

- laminate door fronts available in contrasting color, no upcharge, specify color
- specify pull; see page 10
- locking options available; see page 455 for details and upcharge
- number plate available, order separately; see page 455

69" h Triple Locker - Storage Cabinet	22	12	69	160	18	FLT2212-69FLK-J3DR	\$1,569
	22	12	69	160	18	FLT2212-69FLK-J3DL	\$1,569
	18	12	69	140	15	FLT1812-69FLK-J3DR	\$1,492
	18	12	69	140	15	FLT1812-69FLK-J3DL	\$1,492



Features:

- must be connected to another locker with a common top, this unit is not freestanding; see pages 450-452 for modular tops
- one adjustable shelf per compartment
- unfinished back; modular common top & finished back panels available

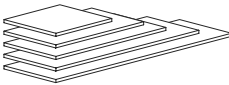
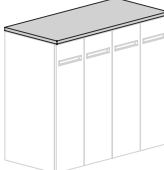
Options:

- laminate door fronts available in contrasting color, no upcharge, specify color
- specify pull; see page 10
- locking options available; see page 455 for details and upcharge
- number plate available, order separately; see page 455

To Order, Specify:

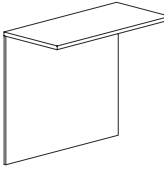
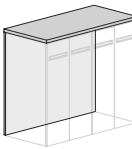
① Laminate Model #	② Laminate Type	③ Laminate Selection	④ Metal Color	⑤ Other Product Options
Laminate (FLT)	HPL	See Laminate Selection	See Metal Finish Color Options	See list of options for each specific unit; Specify and add accordingly.

① Veneer Model #	② Wood Species	③ Wood Finish - Finishes with an asterisk (*) have a coordinating laminate available	④ Metal Color	⑤ Other Product Options	
Veneer (FLV)	Flat Cut CH1 Cherry MA1 Maple WA1 Walnut BO1 Black Oak	See Flat Cut Wood Finish Options	See Metal Finish Color Options	See list of options for each specific unit; Specify and add accordingly.	
	Double Cut DC1 Double Cut	<table border="1"> <thead> <tr> <th>ⓐ Wood Finish</th> <th>ⓑ Chassis Grain Direction</th> </tr> </thead> <tbody> <tr> <td>See Double Cut Wood Finish Options</td> <td>For Double Cut Only: Vertical Horizontal</td> </tr> </tbody> </table>			ⓐ Wood Finish
ⓐ Wood Finish	ⓑ Chassis Grain Direction				
See Double Cut Wood Finish Options	For Double Cut Only: Vertical Horizontal				

Description	D	W	H	CTN WT	CU FT	① Model	List Price
Modular Top - Single Depth Locker   in application	22	96½	1 ⅜	78	5	FLT2296LKMT	\$764
	22	84½	1 ⅜	69	5	FLT2284LKMT	\$670
	22	72½	1 ⅜	60	4	FLT2272LKMT	\$574
	22	60½	1 ⅜	50	4	FLT2260LKMT	\$479
	22	48½	1 ⅜	42	3	FLT2248LKMT	\$385
	22	36½	1 ⅜	33	2	FLT2236LKMT	\$289
	22	24½	1 ⅜	24	2	FLT2224LKMT	\$226
	18	96½	1 ⅜	65	5	FLT1896LKMT	\$750
	18	84½	1 ⅜	56	4	FLT1884LKMT	\$655
	18	72½	1 ⅜	50	4	FLT1872LKMT	\$562
	18	61½	1 ⅜	44	3	FLT1860LKMT	\$469
	18	48½	1 ⅜	35	3	FLT1848LKMT	\$377
	18	36½	1 ⅜	28	2	FLT1836LKMT	\$282
	18	24½	1 ⅜	20	2	FLT1824LKMT	\$221

Features:

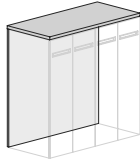
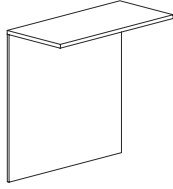
- use with modular Locker Storage Cabinets
- eased edge profile user side

42" h Modular Top & Common Back - Single Depth Locker   in application	22 ¾	60 ½	42	105	44	FLT2360-42LKMTB	\$1,141
	22 ¾	48 ½	42	85	36	FLT2348-42LKMTB	\$914
	22 ¾	36 ½	42	65	28	FLT2336-42LKMTB	\$687
	22 ¾	24 ½	42	45	20	FLT2324-42LKMTB	\$537
	18 ¾	60 ½	42	97	38	FLT1960-42LKMTB	\$1,132
	18 ¾	48 ½	42	85	31	FLT1948-42LKMTB	\$907
	18 ¾	36 ½	42	60	24	FLT1936-42LKMTB	\$681
	18 ¾	24 ½	42	42	17	FLT1924-42LKMTB	\$533

Features:

- use with modular Locker Storage Cabinets to create a finished back
- eased edge profile user side

Description	D	W	H	CTN WT	CU FT	Model	List Price
48" h Modular Top & Common Back - Single Depth Locker	22 3/4	60 1/8	48	113	50	FLT2360-48LKMTB	\$1,236
	22 3/4	48 1/8	48	91	41	FLT2348-48LKMTB	\$991
	22 3/4	36 1/8	48	69	32	FLT2336-48LKMTB	\$745
	22 3/4	24 1/8	48	49	23	FLT2324-48LKMTB	\$582
	18 3/4	60 1/8	48	104	43	FLT1960-48LKMTB	\$1,228
	18 3/4	48 1/8	48	85	35	FLT1948-48LKMTB	\$981
	18 3/4	36 1/8	48	65	27	FLT1936-48LKMTB	\$738
	18 3/4	24 1/8	48	45	19	FLT1924-48LKMTB	\$578

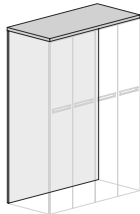
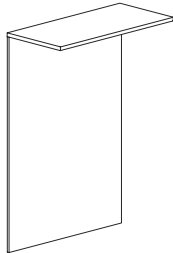


in application

Features:

- use with modular Locker Storage Cabinets to create a finished back
- eased edge profile user side

Description	D	W	H	CTN WT	CU FT	Model	List Price
69" h Modular Top & Common Back - Single Depth Locker	22 3/4	60 1/8	69	140	71	FLT2360-69LKMTB	\$1,566
	22 3/4	48 1/8	69	113	58	FLT2348-69LKMTB	\$1,255
	22 3/4	36 1/8	69	80	45	FLT2336-69LKMTB	\$945
	22 3/4	24 1/8	69	59	31	FLT2324-69LKMTB	\$737
	18 3/4	60 1/8	69	132	60	FLT1960-69LKMTB	\$1,560
	18 3/4	48 1/8	69	107	49	FLT1948-69LKMTB	\$1,248
	18 3/4	36 1/8	69	80	38	FLT1936-69LKMTB	\$936
	18 3/4	24 1/8	69	56	27	FLT1924-69LKMTB	\$733



Features:

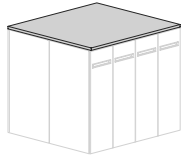
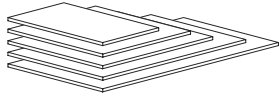
- use with modular Locker Storage Cabinets to create a finished back
- eased edge profile user side

To Order, Specify:

1 Laminate Model #	2 Laminate Type	3 Laminate Selection	4 Metal Color	5 Other Product Options
Laminate (FLT)	HPL	See Laminate Selection	See Metal Finish Color Options	See list of options for each specific unit; Specify and add accordingly.

1 Veneer Model #	2 Wood Species	3 Wood Finish - Finishes with an asterisk (*) have a coordinating laminate available	4 Metal Color	5 Other Product Options
Veneer (FLV)	Flat Cut CH1 Cherry MA1 Maple WA1 Walnut BO1 Black Oak	See Flat Cut Wood Finish Options	See Metal Finish Color Options	See list of options for each specific unit; Specify and add accordingly.
		3a Wood Finish See Double Cut Wood Finish Options		
	Double Cut DC1 Double Cut			

Description	D	W	H	CTN WT	CU FT	① Model	List Price
Modular Top - Back to Back Lockers	44	96½	1 ⅜	150	9	FLT4496LKMT	\$1,515
	44	84½	1 ⅜	133	8	FLT4484LKMT	\$1,328
	44	72½	1 ⅜	114	7	FLT4472LKMT	\$1,141
	44	60½	1 ⅜	96	6	FLT4460LKMT	\$945
	44	48½	1 ⅜	78	5	FLT4448LKMT	\$671
	44	36½	1 ⅜	60	4	FLT4436LKMT	\$576
	44	24½	1 ⅜	42	3	FLT4424LKMT	\$345
	in application	36	96½	1 ⅜	124	8	FLT3696LKMT
36		84½	1 ⅜	109	7	FLT3684LKMT	\$1,092
36		72½	1 ⅜	95	6	FLT3672LKMT	\$936
36		61½	1 ⅜	80	5	FLT3660LKMT	\$782
36		48½	1 ⅜	65	4	FLT3648LKMT	\$631
36		36½	1 ⅜	35	3	FLT3636LKMT	\$486
36		24½	1 ⅜	35	3	FLT3624LKMT	\$296

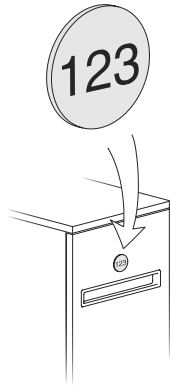


in application

Features:

- use with modular Locker Storage Cabinets to span back-to-back units
- eased edge profile user side

Description	D	W	H	CTN WT	CU FT	1 Model	List Price
Locker Number Plate	1/8	1	1	1	1	FLB-NUMPLT	\$37



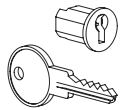
Features:

- helvetica font, 1-3 character

Options:

- select silver with black numerals or black with silver numerals

Lock & Key				1	1	FLB-LOCKCORE-A	\$30
------------	--	--	--	---	---	----------------	------



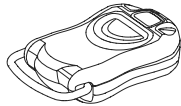
Features:

- key #'s start at 100

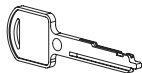
Options:

- select key #'s
- select Silver or Black

Digital lock master key				1	1	FLB-MASTKEY-B	\$98
-------------------------	--	--	--	---	---	---------------	------



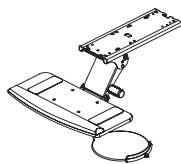
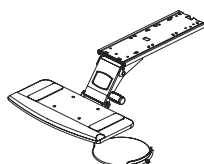
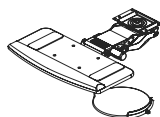
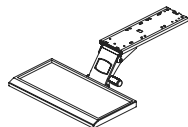

Keyless radial lock master key				1	1	FLB-MASTKEY-C	\$98
--------------------------------	--	--	--	---	---	---------------	------



To Order, Specify:

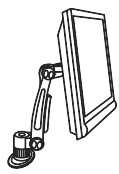
1 Laminate Model #	2 Laminate Type	3 Laminate Selection	4 Metal Color	5 Other Product Options
Laminate (FLT)	HPL	See Laminate Selection	See Metal Finish Color Options	See list of options for each specific unit; Specify and add accordingly.

1 Veneer Model #	2 Wood Species	3 Wood Finish - Finishes with an asterisk (*) have a coordinating laminate available	4 Metal Color	5 Other Product Options
Veneer (FLV)	Flat Cut CH1 Cherry MA1 Maple WA1 Walnut BO1 Black Oak	See Flat Cut Wood Finish Options	See Metal Finish Color Options	See list of options for each specific unit; Specify and add accordingly.
	Double Cut DC1 Double Cut	3a Wood Finish See Double Cut Wood Finish Options		

Description	D	W	H	CTN WT	CU FT	① Model	List Price
Articulating Keyboard Tray  <ul style="list-style-type: none"> · articulating keyboard tray - black color · mouse tray included · 16" glide track · easy one-handed adjustment; vertical range of motion of 5.1" below glide track · tray tilt range +10 degree to -20 degree · unit swivels side-to-side · tray size is 19.4" wide x 9.4" deep · tray includes palm rest · tray is made with recyclable high density polyethylene 	13	24	7	14	2	AK2	\$520
Articulating Keyboard Tray  <ul style="list-style-type: none"> · articulating keyboard tray - black color · mouse tray included · 17" glide track · easy one-handed adjustment; vertical range of motion of 8.9"; (6.5" below the glide track and an additional 2.38" above) · tray tilt range +10 degree to -20 degree · unit swivels side-to-side · tray size is 19.4" wide x 9.4" deep · tray includes palm rest · tray is made with recyclable high density polyethylene 	13	24	7	12	2	AK3	\$550
Articulating Keyboard Tray  <ul style="list-style-type: none"> · articulating keyboard tray - wood finish tray with black mechanism · mouse tray included · use when depth under work surface for mounting is limited; minimum of 9.38" depth recommended · easy one-handed adjustment; vertical range of motion of 5.73 · tray tilt range +10 degree to -20 degree · unit swivels side-to-side · tray size is 21.75" wide x 11" deep · wood tray requires finish selection; see component finishes for the selection 	11	23	3	11	2	AK5	\$535
Articulating Keyboard Tray  <ul style="list-style-type: none"> · trackless articulating keyboard tray - black color · mouse tray included · use when depth under work surface for mounting is limited; minimum of 9.38" depth recommended · easy one-handed adjustment; vertical range of motion of 5.73 · tray tilt range +10 degree to -15 degree · unit swivels side-to-side · tray size is 19.4" wide x 9.4" deep · tray includes palm rest · tray is made with recyclable high density polyethylene 	14	23	7	15	2	AK4	\$580
Keyboard Tray Mouse Pad  <ul style="list-style-type: none"> · adjusts for user comfort · 8" x 8" · for left or right hand operation · compatible with AK4 Keyboard Drawer only 	8	8	1/4	2		MT4	\$195

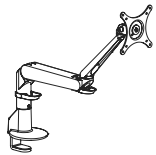
FLUX - ACCESSORIES

Description	D	W	H	CTN WT	CU FT	① Model	List Price
-------------	---	---	---	-----------	----------	---------	------------



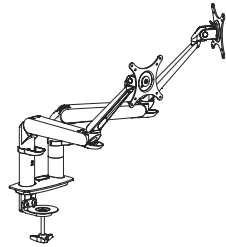
- 360 degree swivel
- adjusts height, tilt and distance of monitor screen to user
- integrated cable management
- grommet and edge clamp mount included
- black finish
- monitor not included
- will fit monitors made to the VESA standard of 75 mm or 100 mm hole spacing in a square configuration

Monitor Arm - Edge Mount				9	1	GP5901MA	\$688
---------------------------------	--	--	--	---	---	-----------------	--------------



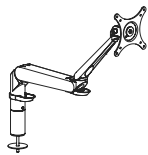
- Features:**
- mounts to edge of worksurface
- Options:**
- silver or black

Dual Monitor Arm - Edge Mount				18	2	GP5902MA	\$1,239
--------------------------------------	--	--	--	----	---	-----------------	----------------



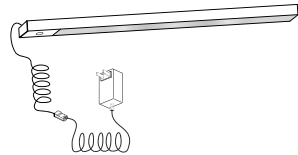
- Features:**
- mounts to edge of worksurface
 - supports two monitors
- Options:**
- silver or black

Monitor Arm				9	1	GP5905MA	\$767
--------------------	--	--	--	---	---	-----------------	--------------



- Features:**
- mounts through hole in worksurface
 - field drilled and field installed
 - supports up to 12 lbs and/or 27" monitor
- Options:**
- silver or black

LED Tasklight	1/2	60	3/4	3	1	TL60LEDF	\$337
	1/2	45	3/4	3	1	TL45LEDF	\$290
	1/2	39	3/4	3	1	TL39LEDF	\$257
	1/2	27	3/4	3	1	TL27LEDF	\$224



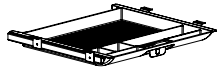
- Features:**
- low profile LED tasklight
 - toggle on and off switch
 - 4000K cool white
 - 13ft cord
 - dimmable
 - includes attaching brackets, adhesive tape and wire manager
 - recommended tasklight length for each cabinet size; see chart on page 33

To Order, Specify:

① Model Number	
-----------------------	--

FLUX-ACCESSORIES

Description	D	W	H	CTN WT	CU FT	① Model	List Price
Wide Pencil Drawer	19 1/4	22	1 7/8	5	1	GP2219CD	\$125



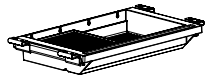
- plastic

Pencil Drawer	19 1/4	16 1/8	2 3/8	4	1	GP1619CD	\$115
---------------	--------	--------	-------	---	---	----------	-------



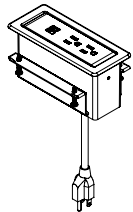
- plastic

Center Nook Drawer	8 1/4	15 1/4	2	2	1	GP1509CD	\$110
--------------------	-------	--------	---	---	---	----------	-------



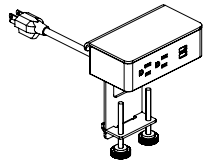
- plastic

Worksurface Power	2 5/8	6 3/8	3	3	1	EC26	\$516
-------------------	-------	-------	---	---	---	------	-------



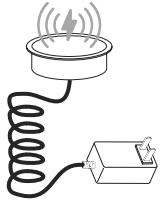
- two power receptacles - 120 volt; 15 amp dual powered USB
- 120" power cord with molded plug
- White (W) or Black (B) finish available, specify when ordering
- UL recognized
- meets UL spill requirements

Edge Mount Power	3 1/2	5 1/2	7 1/2	3	1	EC28	\$414
------------------	-------	-------	-------	---	---	------	-------



- two power receptacles - 120 volt; 15 amp dual powered USB
- 120" power cord with molded plug
- White (W) or Black (B) finish available, specify when ordering
- UL recognized

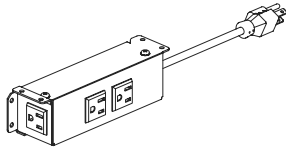
Description	D	W	H	CTN WT	CU FT	① Model	List Price
Wireless Charging Unit	3½	3½	1	3	1	EC33	\$337



Features:

- wireless charging for use with Q enabled devices
- 72" power cord
- black
- UL Listed
- CE / FCC certified

Under Surface Convenience Power Unit	3½	7½	2½	3	1	EC34	\$294
--------------------------------------	----	----	----	---	---	------	-------



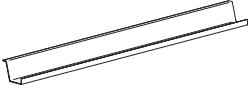
Features:

- three outlets
- 120" power cord
- black
- ETL Listed for US

FLUX - ACCESSORIES

To Order, Specify:

① Model Number	
----------------	--

Description	D	W	H	CTN WT	CU FT	① Model	List Price
Metal Wire Manager 	3 1/16	80	2 13/16	10	6	FLB0480MWM	\$546
	3 1/16	74	2 13/16	9	6	FLB0474MWM	\$535
	3 1/16	68	2 13/16	9	5	FLB0468MWM	\$488
	3 1/16	62	2 13/16	8	4	FLB0462MWM	\$474
	3 1/16	56	2 13/16	7	4	FLB0456MWM	\$449
	3 1/16	50	2 13/16	7	4	FLB0450MWM	\$397
	3 1/16	44	2 13/16	6	4	FLB0444MWM	\$377
	3 1/16	38	2 13/16	5	3	FLB0438MWM	\$369
	3 1/16	32	2 13/16	4	2	FLB0432MWM	\$362

Features:

- to be used with peninsula and runoff desks; see chart on pages 50-51 for appropriate size to be used
- 3 gauge steel mounting plate

FLUX - ACCESSORIES

Flexible Wire Manager - Surface to Surface	1	2	30	4	1	GP230VWM	\$196
---	---	---	----	---	---	----------	-------



- 30" flexible vertical wire manager with one vertical mounting bracket and one magnetic attachment bracket
- black with silver accents

Flexible Wire Manager - Surface to Surface	1	2	40	4	1	GP240VWM	\$252
---	---	---	----	---	---	----------	-------



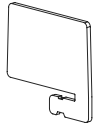
- 40" flexible vertical wire manager with one vertical mounting bracket and one magnetic attachment bracket
- black with silver accents

Flexible Wire Manager - Surface to Floor	1	2	50	12	1	GP250VWM	\$302
---	---	---	----	----	---	----------	-------



- 50" flexible vertical wire manager with one vertical mounting bracket and one counter weight base
- black with silver accents

Description	D	W	H	CTN WT	CU FT	Model	List Price
Portable Slide on Screen	1	24	21 ½	10	2	GPB2422PDP	\$831

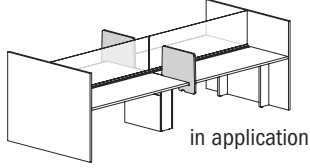


Features:

- works with any surface material
- works in any location, with the exception of where tilt release paddle is located on tilting tables

Options:

- Specify Ash Grey (ASH) or Silver Grey (SIL)



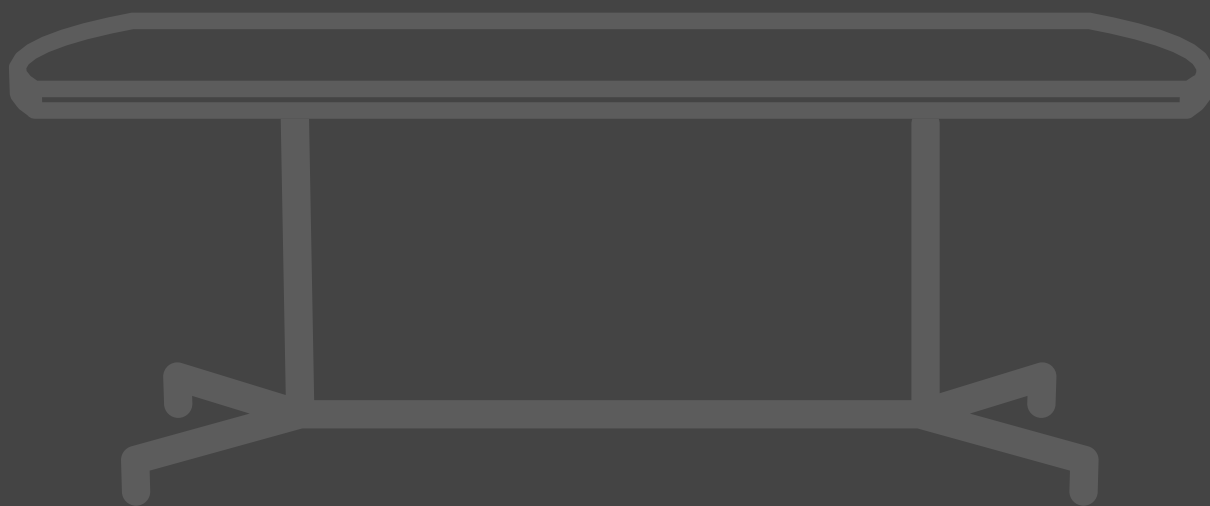
To Order, Specify:

Model Number	
--------------	--

pricelist

effective April 3, 2023

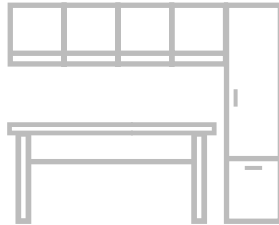
LOK



JSI Price Lists

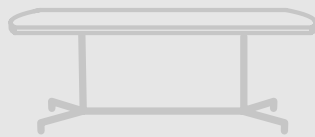
Tables + Casegoods

[Apogee](#)
[Bourne Tables](#)
[Brogan](#)
[Collective Conference](#)
[Finale](#)
[Lincoln](#)
[Native](#)
[Nosh](#)
[Privacy Program](#)
[Prost](#)
[Reef](#)
[Romy](#)
[Strata](#)
[Traditional](#)
[Trail](#)
[Walden](#)
[Wellington](#)
[Accessories](#)



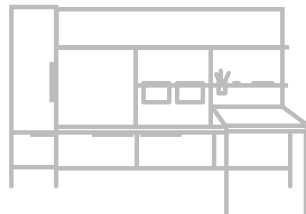
Lok

[Training Tables](#)
[Teamwork Tables](#)
[Conference Tables](#)
[Occasional Tables](#)



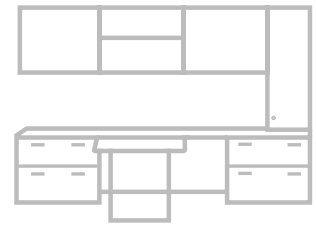
Flux

[Private Office](#)



Vision

[Casegoods](#)
[Tables](#)



Seating

Addison	Madison
Americana	Melrose
Ansen	Millie
Arwyn	Moto
Avalon	Murphy
Avini	Newton
BeSpace	Oxley
Boston	Pillow
Bourne Seating	Poet
Bryn	Protocol
Caav	Proxy
Cabaret	Ramona
Class Act	Ria
Collective Motion	Sosa
Connect	Tara
Encore	Teekan
Esque	Totem
Finn	Trinity
Finn Nu	Tyler
Garvey R5	Wink
Gatsby	Ziva
Harbor	
Hoopz	
Indie	
Jude	
Knox	
Kyla	
Laurel	
Mackey	



Environmental Mission

Our vision and goal is a sustaining supplier, manufacturer and customer for the long term protection and preservation of our environment for future generations.

MISSION

To achieve this vision, we are dedicated to ensuring the health and wellbeing of all of our partners, reducing negative impact on the environment, and maintaining price structure by increasing efficiencies and reducing consumption.

JSI, and it's parent company, is an internal manufacturer and has been an environmentally conscious organization for more than 80 years.

We are proud to use wood as our primary sustainable material resource and all corporate policies and procedures support the efforts to "recover, recycle, reuse, repurpose, reduce, refuse, and re-engineer". In doing this, we are committed to the conservation of the environment and its natural resources as well as encouraging our suppliers and customers to do the same. A goal of a "Sustainable Partnership", supplier, manufacturer and customer, is essential for the long term protection preservation and sustainability of our environment for future generations.

LOCATION

Our manufacturing facilities are located in the center of Southern Indiana. With our diverse product offering and manufacturing capabilities, we provide a single source for all of your project needs allowing you to conserve our fossil fuels and reduce greenhouse gases.

PACKAGING

We place emphasis on the minimal use of disposable packaging while still providing adequate protection to the finished product. Our corrugated packaging is recyclable, reusable, and up to 100% recycled content. We reuse or recycle more than 175 tons of corrugated material annually.

REGULATORY

All of our manufacturing facilities are in compliance with applicable OSHA regulations and meet or exceed all applicable DEM and EPA regulations for air emissions, storm water and hazardous waste disposal.

MANUFACTURING FACILITIES

Our manufacturing facilities are geared toward eco-efficiency and are encouraged to continually improve and conserve. Solid wood not used in the direct manufacturing process is recovered for the operation of our dry kilns, thus reducing greenhouse gases, the use of fossil fuels, and the burden of waste placed on landfills. Composite panels not used in the direct manufacturing process are ground and sold for use as animal bedding and boiler fuel. In addition to other energy savings techniques, our manufacturing facilities use high efficient lighting, make use of power factor capacitors, and encourage all to conserve and reduce energy consumption and water usage. Condensation pumps are used to aid in water conservation as well as extending boiler life.

MANUFACTURING PROCESSES

Our finish processes utilize efficient spray guns and proper spray techniques to reduce wasted material. Excess finish material, solvents, and waste are recycled. Many of the assembly processes use water based glues that contain no hazardous ingredients.

TEXTILES

Many of our fabric options utilize up to 100% recycled content. Our leather alternative program includes selections that contain no toxic materials, plasticizers, heavy metals, or formaldehyde and have a 100% biodegradable back cloth. Some of the available panel fabric used, if discarded is a biological nutrient for the soil. Most of the components (foam, batting, and polycord) used in upholstered products are recyclable. Excess fabrics and leathers not utilized in the upholstery process go to recyclers and local charities for additional use.

WOOD

Wood is the most diverse, most process friendly, and most widely utilized natural resource in mankind's history. No other natural resource can match the environmental advantages of wood, including being renewable, recyclable, natural, carbon negative, and biodegradable. Utilizing the sun's energy, trees grow and remove carbon dioxide from the air while giving off oxygen to benefit the entire planet. Approximately 49% of wood's dry weight is carbon and harvesting mature trees in a sustainable forest, which has slowed in the absorption of carbon dioxide, allows the photosynthetic cycle to continue at full optimization and allow for the carbon to remain sequestered. We are proud to use wood as our primary "sustainable" renewable resource.

WOOD OPTIONS

Many environmentally friendly solid wood and engineered wood options are available for quote, including: Lyptus®, Plyboo®, reclaimed woods, agricultural and post-consumer waste fiber products, etc.

INDOOR AIR QUALITY

Our goal is to reduce the impact our products will have on the indoor air quality. We practice the latest technologies and utilize a third party to assure we meet this goal. GreenGuard, one of the leaders in IAQ certification, continues to certify our product offering with UL2818 - GreenGuard Indoor Air Quality certification.

PARTNERSHIPS

BIFMA
Business and Institutional Furniture Manufacturer Association
 USGBC
United States Green Building Council
 IIDA
International Interior Design Association
 FSC
Forest Stewardship Council - Forestland
 UL GreenGuard
Indiana Department of Natural/Resources - Division of Forestry - Classified Forest, Wildlands Program

Lifetime Warranty

JSI warrants to the original purchaser that each piece of furniture will be free from defects in workmanship, given normal use and care for as long as the original customer owns and uses the product. Normal use is defined as the equivalent of a single shift, 40-hour work week.

JSI will, at its option, repair or replace with comparable product within the terms of the warranty.

Exceptions to Warranty:

12 Years (from date of purchase)

- Wood Seating
- Seating Controls
- Veneer Surfaces
- Laminate Surfaces
- Pneumatic Cylinders

5 Years (from date of purchase)

- Glides · Casters · Task Lights
- Mesh/Knit Material · Foam
- Florette Plastic Frame Chairs
- Electrical Components
- Electric Height Adjustable Bases

This Warranty Does Not Cover:

- Natural variations in color, grain or texture of wood and other covering materials over which JSI has no control.
- Normal wear, color fastness, shrinkage, puddling, wrinkling and stretching of upholsteries including fabric, vinyl, leather and other textiles. This warranty does not cover any defects that may arise in the use of COM or COL upholstery materials. Textile manufacturer's warranty will apply.
- Damages resulting from transportation, improper assembly, installation, handling, accident, user modification attachments, misuse, or neglect of product care.
- Damage resulting from extreme climate conditions.
- Finish damages resulting from normal wear and tear, improper maintenance, water damage, exposure to sunlight, extreme high or low humidity or temperature, or other acts of nature.
- Damage created by loading file drawers with anything other than hanging folders.

JSI makes no expressed or implied warranties to any product and, in particular, makes no warranty of merchantability or fitness for any particular purpose. JSI will not be liable for any consequential or incidental damages under this warranty.

Unique Characteristic of Natural Woods and Veneers

JSI uses high quality wood and veneer harvested from sustainably managed forests. Every tree has unique and defining characteristics, like fingerprints. These characteristics can be defined by differences in color, grain configuration, and textures. These characteristics will be more noticeable if the product has a clear or lighter finish.

Maple and Cherry species have a higher degree of uneven distribution of grain, small color streaks, and pin knots.

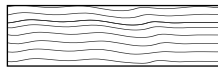
At JSI, we take care of selecting woods and veneers that are used in our products. With this in mind, we hope you appreciate the beauty of each tree's fingerprints. Products will not be replaced due to these natural characteristics.

Veneers can be sliced in a variety of ways to create unique patterns. JSI uses several different patterns, as shown below.

Flat (Plain) Cut as shown in diagram



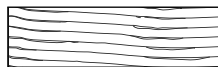
Quarter Sliced as shown in diagram



Double Cut as shown in diagram



Rift Cut as shown in diagram



Double Cut

The Double Cut veneer is a processed product that has at least two cuttings to create the final veneers. These cuts of veneer strands are dyed and layered into a block to create variation of patterns from a very tight grain pattern to an exotic figure grain pattern.

JSI uses select beech, cherry, maple, oak and walnut cut wood products to produce the desired look of our furniture products.

Laminates (Veneer Series)

An alternative HPL (Higher Pressure Laminate) laminate work surface can be specified on most of our casegood product lines. The specification pages will also list the available coordinating finishes.

Laminate Series

JSI laminate series offer a full laminated product with imprinted grain to hide finger prints and provide durability. The worksurface tops are HPL (High Pressure Laminate) or TFL (Thermal Fused Laminate). TFL is used on the product's chassis.

Please reference the featured highlights of each product line to identify the species, grain patterns, finishes for that product series

Finish - Top Coat

To reduce hazardous formaldehyde emissions, we use our proprietary specially designed top coat, DuraTex™. It significantly reduces hazardous formaldehyde emissions and helps improve indoor air quality.

Finish - Color/Stains

A wide range of stains are available to bring out the beautiful characteristics of each wood species. We coordinate finish color between our veneer stains and solid lumber stains; however, not all may be a perfect match. The stains are continually reviewed for accuracy of color, as well as a constant monitoring of the latest color trends in the furniture market.

Finish - Matching

Due to the natural characteristics of wood, environmental effects, and material upgrades, JSI cannot guarantee exact finish matches on existing furniture previously ordered.

If an exact match is required to accompany existing furniture, it must be specified at the time of order placement, so specific internal procedures can be followed to ensure a proper and acceptable finish match. We reserve the right to change our finish formula at any time to improve safety, quality, and appearance. Unless a finish match for existing furniture is requested at the time of ordering, we accept no liability for finish that may not match the existing furniture from prior orders.

Solid lumber may inherently have mineral streaks, pits, and various other natural occurrences. Care is taken in selecting the solid lumber to coordinate with the requested finish on our veneer products. This internal selection process is subject to availability of solid lumber parts.

Finish Sheen

All casegood veneer finishes are standard in 35-sheen, with the exception of Raven, which is only offered in 15 sheen. All other finishes are available in 15 sheen, with a 5% upcharge, per model

Custom/Special Finishes

JSI, upon request, will accommodate special finishes. A written request is required to proceed with custom finish orders. A sample reference is required for first time matches and must be included with the written request.

There is a one time charge of **\$372 list per order** for any non-standard wood finish.

Orders will be entered noting the special finish. A sample match will be provided to the customer. Written approval is needed before the finish process can be started. Delays in approval may have an impact on lead times.

Every effort will be made to create the requested match; however, an acceptable match may not be possible because of natural variations of wood. These natural variations can also cause minor differences in the final finish product.

Samples

Samples of standard wood finishes, paints colors, metal colors, and standard laminate are available upon request. The fastest way for requests to be filled is by using our website. See below for options to request samples.

Website – jsifurniture.com (click the resource tab)
JSI Sales representatives
Phone – 800.457.4511 – Customer Service
Email – customerservice@jaspergroup.us.com

Pricing

Prices found in this document or on our website are list prices in U.S. dollars for standard product delivery to one destination. Prices do not include storage, installation, or taxes. Possession of this price list does not constitute an offer to sell. Orders can only be received from approved authorized JSI dealers.

Prices and product information in this document, as well as our website, are subject to change without notice. Reference website for most up to date product offering and pricing.

Orders

Detailed specification pages are available in the price list at the beginning of each series.

Additional information may be obtained by consulting the Customer Service Department or our website.

Indicate shipping address if different from billing address.

Send Orders To:

US Mail – JSI
225 Clay Street
Jasper, IN 47546
Fax – 812-482-1548
Email – orders@jaspergroup.us.com

JSI reserves the right to make changes in dimensions, styles, or specifications if we believe these changes will improve the safety, quality, or appearance of the product.

Acceptance of orders will be subject to credit approval, barring any acts of governments, or any other causes beyond our control (e.g. strikes, fire, embargo of materials, etc).

Product Modifications

While we offer a wide range of products to accommodate many possible solutions, we also recognize the needs for our products to be modified from our standard offering.

In the series introduction section of each product, we address modification options for that series.

To see if the desired modification is possible, please contact our Customer Service Department for a quote. Note that order quantities and material availability can affect the quote. Additional information may be requested to fully quote modifications.

Order Acknowledgments

All orders will be acknowledged promptly upon entry of a clean order. The acknowledgment will show how the order was entered, ship date and any other information pertinent to the order. It is the purchaser's responsibility to verify all the information on the acknowledgment carefully and notify us immediately, in writing, of any discrepancies.

Every reasonable effort is made to ship as acknowledged; however, the acknowledged ship date is approximate. Company will generally ship within five (5) working days of the acknowledged ship date. If a firm ship date is necessary, customer must inform company at time of order and company will make all reasonable efforts to meet each customer's request. Acknowledged shipping dates are contingent upon the force majeure conditions contained in these terms and conditions.

Quickship

JSI offers select Vision models, with select options, in our Quickship program. These items ship within 10 business days after receipt of a clean, credit approved purchase order. Items should be placed on order separate from standard lead time models.

Product for up to 10 offices or 10 tables can be included on a single Quickship order. Available capacity is filled by orders as they are received. If normal 10 day Quickship is not available because capacity has been filled, you will be immediately notified by JSI customer service. Changes and cancellations to Quickship orders are not allowed under any circumstances, nor are modifications to the predetermined Quickship offering. Limit one order per project.

Delivery

Our freight policy consists of prepaid freight to the 48 contiguous states; all other shipments are prepaid to port of exit ONLY. JSI reserves the right to select the appropriate carrier and shipment routes, most shipments are on freight carriers that are dedicated furniture specialists. Standard deliveries require a DOCK that can accommodate **75 foot trucks**. Ownership and inspection of product is the responsibility of the buyer upon pickup by the freight carrier. Pricing in this book is for standard delivery only. Standard delivery does **not** include non-dock delivery, inside delivery, residential delivery or installation of product. Fees and changes for non-standard deliveries are listed below.

Standard Delivery Time

Between 8AM and 3PM Monday through Friday. Special delivery requests can be subject to additional fees to accommodate requests.

Cancellations and Changes

All orders are considered firm and are not subject to cancellation or change without approval from JSI. All approved changes are subject to additional charges and revised lead times

No Touch Freight

Our freight is considered "no touch". Therefore, customers are to be prepared to unload freight from inside the truck prior to arrival. In the instance that a driver must unload the shipment, driver assists fees will apply (see fees below).

On-Site Deliveries

Shipments to the installation site, and time deliveries are available on full truckloads or slightly less, at no additional charge. Shipments or timed deliveries for smaller shipments may not be available, or if available may require an additional charge.



Detention Fees

- Carriers are given two-hour maximum time allotment to unload for one-stop truckloads.
- Carriers are given one hour maximum time allotment to unload for multi-stop truckloads
- *Detention fees apply after allotted unloading time and will be at buyer's expense.

Fees

Orders of less than \$1,000 net \$90 net per order
 (If order is UPS shippable, the handling fee is waived and customer is invoiced for exact shipping charges.)
 Weekday deliveries outside of standard delivery times \$300
 Weekend deliveries (Saturday or Sunday) \$600
 Liftgate Deliveries. \$500 minimum 7% of net price
 Driver Assist \$90
 Jobsite Non-Dock Delivery \$150 per truck
 Inside Delivery (first floor inside only) - no installation or carton removal. \$250 minimum 7% of net price
 NO RESIDENTIAL DELIVERIES

Warehouse/Storage Fees

Additional storage time with a provided two-week approved notice is calculated at 3% per month of the product amount or per day.

Please be Advised

- Reconsignment fees are the responsibility of the buyer.
- Any charges arising from failure to meet shipment, re-routing while in transit or carrier storage charges are the responsibility of the buyer.
- Contact Customer Service to inquire about skidding of products, special crating of products and product installation. These requests must be approved by JSI and made at the time of order.
- Carriers have the right to refuse delivery to a specified location if it conflicts with their liability policy.

Freight Damage

JSI products are packed in cartons and meet or exceed existing codes for furniture and seating products. All shipments are delivered to the carrier in good condition and our liability ceases thereafter. If delivery arrives short or damaged, contact the carrier immediately to file a claim. In the event of concealed damage, notify the carrier and request immediate inspection. Failure to file a claim within 15 days after receipt of merchandise constitutes acceptance and a waiver of any such claims. Please inspect merchandise immediately upon receipt, otherwise there is no recourse. Keep all cartons and packing material, discarding these materials may negate your claim.

Storage of product in areas of uncontrolled humidity and temperature may cause damage to the product and void the JSI warranty.

Repairs

JSI will not issue credit allowance for any type of repairs without prior written consent.

Sales order, product model numbers, and reason for repair will be expected in order to process the repair request. A digital photo will help to expedite the request. JSI reserves the right to recommend solutions for repair.

Replacement Parts

Obtain information and pricing on replacement parts by contacting Customer Service. Please have the model number available when requesting replacement parts. Additional information may be required to ensure proper replacement parts.

Returns

JSI products are made to order and may not be returned for credit. No merchandise may be returned to JSI without a signed Return Good Authorization (RGA) form issued by our Customer Service Department. RGA's will be considered for the following reasons:

1. Manufacturing defect (validated by JSI representative).
2. JSI order processing error.
3. Shipping error.
4. Mis-marked cartons.
5. Duplicate shipments.

Liability for defective merchandise shall be limited to replacement or repair.

If you have questions as to whether your reason for return qualifies for consideration, please contact Customer Service. At the discretion of JSI, returns on stocked items may be considered with the following stipulations:

1. 60% restocking fee.
2. All return freight charges must be prepaid by dealer.
3. Product was never removed from the original carton.
4. Product must be returned within 30 days of RGA issue date.
5. Credit will not be issued if product returned is damaged.
6. Under no circumstances can we accept COD (Cash on Delivery) returns. Any such shipment will be refused.

Please note most models on Quickship are produced on demand and cannot be returned. Modified, special or custom-built product is not eligible for return.

Fire Retardancy

All JSI upholstered components comply with California Bureau of Home Furnishings and Thermal Insulation-Technical Bulletin 117-2013 issued by State of California Department of Consumer Affairs. This standard requires upholstered furniture to be safer from the hazards associated with smolder ignition in all four (4) categories of materials, as applicable.

Compliance with more stringent codes may require special manufacturing considerations and upcharges.

California Technical Bulletin 133 (CAL 133)

JSI uses a barrier material between the foam cushioning and the upholstery cover in order to comply with CAL 133. The standard upcharge on products specified to comply with CAL 133 is **\$78 list per yard** of textile.

JSI has performed a series of full scale fire tests on samples - representing worst case scenarios of upholstered units - to comply with the requirements of the state of California Technical Bulletin 133 (CAL 133). Products in compliance are labeled in accordance of the standards.

Some product designs and fabric cannot be combined to comply with CAL 133. Because of this, we reserve the right to reject any request for an upholstery cover, including COM, textile may not contain olefin or product style that we feel may compromise the integrity or safety of a product specified to comply with CAL 133.

Contact Customer Service for a quote if you require laboratory certification that a specific product and upholstery combination WILL PASS CAL 133. The quotation will include testing, video, and transportation charges plus the list cost of the sample.

Our standard lead time will apply to products that do not require certification. Allow an additional six weeks over the standard lead time for products that need actual laboratory certification.

The end user, specifier and/or dealer have the responsibility to make sure all products specified will meet the flammability and safety codes of the jurisdiction where the products will be located and used.

Flame Spread

All JSI may be required to comply with the requirements of Flame Spread based on ASTM standards/NFPA Life Safety Codes and general public knowledge are as follows:

Solid Wood - Class C
 Topcoats - Class A
 Carded Fabric - Class A
 Composite Panels - Class C
 Laminate - Class B

Plastics - According to the NFPA, the lack of stability of plastics under high temperature conditions and inherit combustibility have eliminated the use of plastics for applications requiring a flame spread rating.

Also be advised that improvements may be attained in certain instances with the addition of chemicals which may add additional costs, chemical exposure and/or compromise the integrity of the product.

Textile Carded Programs

JSI is proud to partner with Maharam, Momentum, Spradling, Stinson, Ultrafabrics, Camira and Cortina Leather. Please refer to our website for our standard patterns, along with the current grade.

<https://www.jsifurniture.com/finishes-and-materials/textiles>

Textile Grade-In Programs

For the convenience of our specifiers, we offer an extensive graded in program. Please reference our website for the most up to date information on our graded in program.

<https://www.jsifurniture.com/resources/textile-partner-info/overview/>

For additional specifications on the pattern or to order memo samples, please contact the textile suppliers directly:

Arc Com www.arc-com.com
 Camira www.camirafabrics.com
 Designtex www.designtex.com
 Maharam www.maharam.com
 Mayer www.mayerfabrics.com
 Momentum www.themomgroup.com
 Spradling www.spradlingvinyl.com
 Stinson www.cfstinson.com
 Ultrafabrics www.ultrafabricsllc.com
 Cortina Leather www.cortinaleathers.com

Any textile not graded in or pre-approved for COM/COL will require application test approval prior to order entry and shipment of fabric or leather to JSI. For current JSI grades and application status by series visit jsifurniture.com Resources > Graded-In + COM; jsifurniture.com Resources > Graded-In + COM.

Indicate on purchase order if JSI is to order the fabric.

Grades and availability of fabric are subject to change without notice. Changes could include but are not limited to price increase, discontinued patterns, discontinued colors, etc. See jsifurniture.com for up to date information.

Many textiles have repeats and the additional yardage required has been factored in for textiles ordered through the JSI Carded and Grade-In Programs. We reserve the right not to match textiles with a horizontal or vertical repeat greater than 17". Additional charges may apply for textile being applied with special instructions.

Some fabric thickness or stiffness may cause issue with proper upholstering of tackable wall panels or upholstery privacy screens. Please contact customer service with concerns on the fabric thickness for these items.

COM/COL Address

JSI
 Attn: COM/COL Department
 Receiving B
 Dock 71
 201 East Martin St.
 Orleans, IN 47452

Tag: Dealer Name / Purchase Order #

General COM Fabric/COL Hide Policy

Refer to the COM/COL Price Columns for list prices.

All yardage requirements listed in the price list are based upon 54" plain non-directional material. Additional yardage may be required based on fabric repeat and matching.

All square footage requirements for COL are based on an average hide size of 50 square feet.

Contact Customer Service for any of the following conditions:

- + approval of COM/COL to be used (see policy on the next page)
- + fabric repeats greater than 3"
- + fabric less than 54" wide
- + leather hides smaller than 50 square feet
- + special application requirements request

When requesting information from Customer Service on COM/COL please supply the following information:

- + model number and quantity of the product the COM/COL will be applied
- + COM/COL textile supplier's name
- + name of pattern and color of the textile
- + any special application request

Visit jsifurniture.com Resources > Graded-In + COM to see if the textile has already been approved. If there is no record for this particular textile then a Memo Sample will be required.

JSI takes no responsibility when additional materials must be ordered.

COM Fabric Repeat Guide

Roll Width	Plain Fabric	1" - 5" Repeat	6" - 10" Repeat	11" - 15" Repeat	16" - 20" Repeat	21" - 30" Repeat	31" - 40" Repeat	41" - 50" Repeat
54"	0%	10%	15%	20%	25%	30%	40%	50%
53" to 51"	15%	20%	25%	30%	35%	40%	50%	60%
50" to 48"	30%	35%	40%	45%	50%	55%	70%	90%
47" to 36"	60%	65%	70%	75%	80%	85%	100%	120%

The percentage represents the additional fabric yardage that needs to be added to the COM yardage. Contact Customer Service for repeats greater than 50".

All COM/COL must meet applicable codes and regulations, including TB117-2013. By selecting COM/COL, customer certifies that the material meets such codes. JSI assumes no responsibility for the applicable codes and regulation regarding flammability rating and safety rating of any COM/COL.

JSI cannot be held responsible for receipt of defective fabrics, as we apply all COM as first quality goods.

We can take no responsibility for tailoring, wear-ability or application of COM/COL textiles. Any warranty claims for the COM/COL Textile materials will fall to the original vendor of the textile, not JSI.



COM Fabric/COL Hide Process for JSI Seating

General COM Fabric and COL Hide Policy also apply.

JSI will approve or disapprove COM/COL on all products. An approval of a textile from JSI makes no claim that performance, durability or tailoring of COM/COL will result in satisfactory upholstery. Every effort will be made to meet customer's expectation, but fabrics/leathers have unforeseen inherent characteristics that may limit JSI's ability to deliver a well tailored product.

Approval COM Textile/COL Hide Process for Seating

Follow the Steps Below:

1. Send a Memo Sample of the COM/COL (recommended memo be at least 4" x 4")

JSI

Attn: COM/COL Approval Department

201 East Martin Street

Receiving B, Dock 71

Orleans, IN 47452

2. Call our Customer Service Department at 812-482-3204 to request an electronic version of approval form.

Please send sample to:
JSI
Attn: COM/COL Approval Depart.
201 East Martin St.
Receiving B, Dock 71
Orleans, IN 47452

Please forward a copy of this form
to your JSI CSR for record keeping

Guide Order Form for COM and COL

① **Order Information:**

Quote #: _____ **Purchase Order #:** _____

Customer Service: _____

Dealer Name/Project Name: _____

Contact: _____

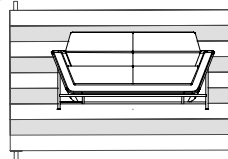
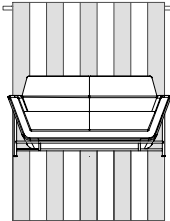
Address: _____

Phone: _____ **Email:** _____

Model Number(s) Receiving COM / COL: _____

② **Select off the bolt application:** *(Check one of the boxes)*

Up the roll (standard on most seating) Railroaded



③ **Additional information:**

④

Attach sample here.

JSI will review and test as needed all requests. You will be notified as soon as results are documented by our review personnel. JSI reserves the right to reject any COM/COL on our products. We will provide COM/COL explanation of any unapproved textile whenever possible.

Custom Options

Wood Laser Engraved Back

Many of our seating models are available with a custom wood laser engraved back. University seals, logos, unique designs, or any type of graphic can be designed into the seating back for a custom creation. Copyright approval may be required. Consult JSI Customer Service for pricing and artwork specifications. Artwork must be submitted as a JPG or PDF file.



Wood Laser Engraved Back General Pricing

* must order plain back when choosing these options

For Artwork 4" x 4" or Less	\$56 list per chair
For Artwork Less than 6" x 6"	\$99 list per chair
For Artwork Larger than 6" x 6"	Call For Pricing

For orders fewer than 50 pieces, add \$153 list per design, per order. This pricing reflects etching (leaving the wood dark). If additional painted colors are added to artwork please call customer service for pricing.

A \$134 list set-up fee applies.

Care and Maintenance

Care and Maintenance

Care of Upholstery Surfaces

Cleanability will vary based on the fabric type. For best results, a professional service is recommended. Dirt and crumbs may be gently brushed or vacuumed off. Spills should be wiped up immediately with a cloth. Vinyl textiles can be cleaned with warm soapy water and then wiped down with a warm damp cloth. For more details on any JSI carded fabric and vinyl, please visit our website at jsifurniture.com or consult the back of the appropriate swatch card for cleaning codes and any specific instructions. For COM materials, consult with the individual textile manufacturer for cleaning codes and any specific instructions pertaining to your particular fabric.

Maintenance of Mechanical Parts

Clean any lint or debris from the moving parts of the base mechanisms. Mechanisms have been designed and tested to not require lubrication under normal conditions; however, lubricant can be used if needed.

Care of Wood Edges and Veneer Surfaces

Clean all surfaces frequently with water dampened soft cloth, moving the cloth with the grain direction. Immediately remove any liquids that come in contact with wood surfaces with a blotting action to absorb liquid. Buff dry. Lift objects to move them, never pull them across the finished surface. For an additional safeguard, use a protective surface pad. This will ensure a lasting finish by protecting your furniture from possible damage caused by pens, cups and sharp objects. Avoid exposure of furniture to extremes of heat and cold, or to wide humidity variances. Avoid exposure of furniture to strong sunlight. Avoid exposure of furniture to harsh solvents such as nail polish remover, acetates, etc., as it will cause finish deterioration. If using a protective glass top, place spacer pads under the glass top to allow the wood to breath.

Care of Metal Finishes

Wash you powder-coated item at least one every six months. Use soft rags only - No abrasives. For stubborn stains and grease marks, use soap and water mixture. Combine 1 gallon of water and 1 cup of the neutral detergent in the bucket. Mix it up by swirling one of the rags around in it. Wipe down the powder coat with a rag that has been dampened with the cleaning solution. Do not scrub, but use gentle, repetitive pressure to remove any built-up grime. Rinse the powder coat off with a rag dampened with clear, clean water. Do not spray it down, but rather wipe it off with the rag. You may need to do this several times to get all the soap off. Wipe the powder coat down with a clean dry rag. This will prevent streaking and spotting.

Care of Frosted Glass

Use a clean, dry lint free cloth to wipe the surface. Follow with warm water and a clean rag; no soap or chemicals. Wipe dry with a clean, dry lint free cloth. Cleaning the frosted side is not recommended, if desired to clean use the above method but do not spray the water on the frosted side, use a clean rag. Please allow 48 hours for the frosted side to dry and not to show cloudiness.

Tempered Glass Information

JSI is aware of occasional occurrences of spontaneous glass breakage in various furniture products. Tempered glass makes it stronger and if it breaks, will cause it to break into many small pieces of "cubes" rather than sharp and potentially dangerous shards.

Glass breakage in furniture may occur for a variety of reasons. Tempered glass is particularly prone to breakage from damage (scratches, nicks, etc.) that may occur during shipping, handling, installation, use or maintenance. Exposure to rapid changes in temperature or concentrated temperature zones may also cause breakage.

Tempered glass may also break due to a specific type of imperfection or "inclusion" that occurs within the glass when manufactured. When this condition exists glass breakage may occur without any obvious cause. This is often referred to as "spontaneous" breakage but is a very isolated occurrence in the glass industry.

Care of Dry Erase Boards

Erase after every use to eliminate ghosting. Clean weekly with a Dry Erase Cleaner. Avoid the use of orange and red Dry Erase Markers. Follow manufacturers cleaning instructions for the eraser. If ghosting or staining remains use a small amount of rubbing alcohol on a clean, soft towel to remove.

Care of Solid Surface

Although liquids cannot penetrate Solid Surface, it is best to wipe up spills as they occur. Generally, a damp microfiber cloth used with a standard household kitchen spray should remove most stains.

For most residues, all you need to clean your Solid Surface countertops is a warm soapy water, ammonia-based household cleaner or a dedicated countertop cleaner. Do avoid window cleaners; however, as they can leave a waxy build-up that dulls the surface. Always clean using a circular motion.

Film will build up on countertops if water is left to dry on the surface. This film will dull the countertop surface, making the finish appear blotchy and uneven. To prevent film build-up, it is very important to wipe the countertop completely dry immediately after spills and cleaning.

Some color of Solid Surface may require more frequent cleaning to maintain a uniform finish. Darker colors tend to require more attention than lighter colors. Over time, even with proper care, your countertop will acquire a sheen. Dark colors may show light scratches more readily.

Specification Tools

JSI products are manufactured to order and provide a multitude of options to address your individual customer needs. As you process your order do not forget to include all the necessary information to allow the order entry process to be completed. Please see the order checklist at the beginning of every series.

JSI Customer Service edits every order for complete information. If details are not included with the purchase order, Customer Service will contact you to answer these questions. If information is not completed in a timely manner it will delay the entry process and could affect your product delivery date. To avoid delay in order entry and potential delay in delivery of your order, please double check the line items to ensure all selections have been completed.

To ensure completion of details on your purchase order, electronic catalogs and specification tools have been developed to aid in the process. These electronic tools include:

20-20 GIZA Studio and 20-20 CAP Studio software offers state-of-the-art design, specification, photo-realistic rendering and three-dimensional visualization capabilities for configurable products in the commercial interior design markets. 20-20 GIZA Studio and 20-20 CAP Studio are available for all JSI Casegood and Seating products, in 2D and 3D graphics and the Specifier Catalog. Updates are made monthly reflecting any changes that occurred. To be sure the most up to date information is provided on orders, users of this software program are responsible to update their catalogs.

CET Designer, by Configura is an all-in-one software solution for space planning and configuration of products. The intuitive workflow guides you through entire process from idea to reality - supporting every step of the sales process

ProjectMatrix, Inc. offers a full software solution for the contract furniture industry. Their software can help you create space plans to specifications for ease of specifying our JSI Casegood and Seating product lines. Updates are made monthly reflecting any changes that occurred. To be sure the most up to date information is provided on orders, users of this software program are responsible to update their catalogs.

GSAdvantage is a Federal Government electronic catalog site offered to assist GSA customers in specifying and pricing JSI product. Listed at this site are all contract items and prices under GSA Contract # GS-28F-0030U.

Our JSI website jsifurniture.com provides many tools to assist in the design and order selection. Included in the site are downloadable images, typicals, product symbols, brochures, contact information, price lists, sales representative locations, warranty and environmental information.

GSA Terms and Conditions



Contract Holder
Contract # GS-28F-0030U

In addition to the standard terms and conditions, the following terms and conditions apply to GSA contract.

Contract Number
GS-28F-0030U

Contract Period
June 24, 2013 - June 24, 2028

Statement of Intended Use
The furniture covered by special item number 33721 Office Furniture shall comply with the requirements defined in purchase description 3QSAB 09-608. All furniture offered under this SIN shall be GSA Chassis Grade 1, 2, 3 or NA, GSA Drawer Grade 1, 2, 3, 4 or NA, Design A B or C, as defined in 3QSAB 09-608.

Description of Special Item Number SIN #33721

Cooperative Purchasing
No

Set Aside
No

FSC/PSC Code
7125

NAICS 337211 Wood Office Furniture Manufacturing 1000 employees

Includes all furniture placed in an office, such as chairs, desks, etc. In addition, ancillary services are included, however services performed shall not be the primary purpose of the work ordered.

Lowest Price Model

SIN #	Model Number	Net Price
33721	VS-LBRKT-20	\$28.03

Maximum Order
\$250,000 net

Geographic Coverage
48 contiguous states and Washington D.C.

Point of Production
Jasper, Dubois County, Indiana
Orleans, Orange County, Indiana

Discount
Discount 61.6%* off list.

*Discount for Walden and Wellington is 61.71% off list.

Discount Quantity
Walden and Wellington only
\$300,000 to \$350,000 Net = 0.5%
\$350,001 to \$400,000 Net = 1%
\$400,001 to \$450,000 Net = 1.5%

Prompt Payment Terms
1% 15 - net 30 days from date of invoice.

Government purchase cards are accepted at or below the micro-purchase threshold

Government purchase cards are accepted above the micro-purchase threshold

Foreign Terms
Not applicable.

Time of Delivery
30-75 days after receipt of order, 90 days maximum.

Expedited Delivery
Contact Customer Service 800-457-4511

Overnight and 2-day Delivery
Not applicable.

Urgent Requirements
Contact Customer Service 800-457-4511

F.O.B. Points
F.O.B. destination, freight prepaid and allowed to 48 contiguous states and Washington D.C. excludes special delivery requirements.

GSA Terms and Conditions

Ordering Address

Jasper Seating Company, Inc. d/b/a JSI
Attn: Participating Dealer
225 Clay Street
Jasper, IN 47546
Fax: 812-482-1548
Phone: 800-457-4511
Email: orders@jaspergroup.us.com

Order Procedures:

Per contract

Payment Address

JSI
225 Clay Street
Jasper, IN 47546

Warranty Provision

Limited Lifetime

Export Package Charges

Quoted on project-by-project basis.

Terms of Government Commercial Credit Card Acceptance

Accepted.

Rental, Maintenance, and Repair

Not applicable.

Terms and Conditions of installation

12% of net purchase order for installation services up to \$250,000.00 of net purchase price.

Terms and conditions of repair parts, etc.

See warranty.

List of service and distribution points

Contact Customer Service 800-457-4511.

List of participating dealers

Contact Customer Service 800-457-4511.

Preventive Maintenance

N/A

Environmental Attributes

GreenGuard Certified and recycled wood waste and fabric remnants

Section 508 Compliance.

N/A

DUNS

00-636-7767

CCR and SAMS Registration

Jasper Seating Company, Inc. is registered
Cage Code #31881
Federal ID #35-0420370
UEI #DDJ2GKQM7M84

Product Modifications

We willingly accept customers' modifications to standard products. See product modification information by series at the start of each series under the "Product Modification" sections. If there is a modification you desire that is not listed in this section, please call Customer Service for a modification quote/price

Acceptance, Modification, Assignment

By placing this order for furniture, material or other products (sometimes collectively referred to as "goods"), customer agrees to these terms and conditions which shall prevail over inconsistent provisions in any other form or document of customer. No change or modification shall be applicable unless set forth in writing and signed by company. Neither this order nor any interest therein shall be assigned by customer except with the prior written consent of company.

Payment

Customer agrees to pay to company the amount indicated on the invoice, 1% 15 days, net 30 days from date of invoice (U.S. funds only), for goods ordered. Interest will be charged after 30 days from the date of invoice at the rate of one and a half percent (1.5%) per month. International sales will require additional payment arrangements. No goods shall be sold on consignment or conditional sales basis. Payment for the goods delivered hereunder shall constitute acceptance thereof.

Attorneys' Fees

Customer shall be responsible for all expenses and cost in connection with the enforcement by company of these terms and conditions and the cost of collection (including the fees of any collection agencies to whom the customer's account may be referred), plus reasonable attorneys' fees (which attorneys' fees shall not be less than 25% of the amount due, unless a lower amount is specified by applicable law).

Remedies

The remedies herein reserved shall be cumulative, and additional to any other or further remedies provided in law or equity. No waiver of a breach of any provision of these terms and conditions shall constitute waiver of any other breach or of such provision.

Insolvency

Company may forthwith cancel this order in the event of the happening of any of the following or any other comparable event: insolvency of the customer, the filing of a voluntary petition in bankruptcy, the filing of any involuntary petition to have customer declared bankrupt provided it is not vacated within thirty (30) days from the date of filing, the appointment of a receiver or trustee for customer provided such appointment is not vacated within thirty (30) days from the date of such appointment, or the execution by customer of an assignment for the benefit of creditors.

GSA Terms and Conditions

Limitation of Liability

The Company shall not under any circumstances be liable to the customer, owner of the goods or any third party for special, indirect, incidental, or consequential damages, including, without limitation, loss of profits or revenues, loss or damage to other property or equipment, cost of capital or of purchased or replacement goods, or expense, delay, or inconvenience cause by or arising from the purchase, sale, use, repair or inability to use the goods or by any performance or non-performance under, or breach of, these terms and conditions. The Company's sole liability for any defective goods shall be its repair or its replacement pursuant to the express warranties set forth above, or if amended, as applicable at the time of manufacture or repair of the goods. Some states do not allow the exclusion or limitation of incidental or consequential damages, so the above limitations or exclusion may not apply to all customers. Any action resulting from any breach on the part of company as to the goods or services delivered here under must be commenced within one year after the cause of action has occurred.

Returns and Allowances

Reasonable touch-up and deluxing is the dealer's responsibility. The Company will not make allowances for trip or delivery charges, but will only make allowance for actual work performed to correct manufacturing defects. Allowances maybe authorized only by a company officer. It is the responsibility of the field sales representative to inspect any defective merchandise and make suggestions and recommendations as to the proper disposition. Field personnel cannot obligate or bind the company by definite agreement, without final authorization by a company officer. Company will not accept automatic charge backs which do not have prior authorization. All defects must be called to the company's attention upon arrival at the customer's "ship to" destination. To initiate any type of claim or request for parts, it is imperative to have the model number or fabric number, which may be located on the tag attached to the frame of the unit. Authorization for return to the company via a return goods authorization. Company will not issue credit allowances for any repairs without company's prior consent. Under no circumstances shall the company accept COD (cash on delivery) returns, and any such shipment will be refused.

Security Agreement

The Company may require and customer shall grant a security interest in goods sold pursuant to any credit the company may extend to the customer.

Governing Law

All disputes between the parties, whether or not arising out of these terms and conditions, will be governed by the laws of the state of Indiana. Customer agrees to submit to the jurisdiction of and agrees all lawsuits relating to any disputes between the customer and the company will be brought only in a state court located in Dubois County, Indiana or the United States District Court for the Southern District of Indiana. The customer hereby waives the right to a trial by jury in any action, proceeding, claim, or counterclaim whether in contract or tort, at law or in equity, arising out of or relating in any way to these terms and conditions and all other disputes between the parties.

Mitigation

If the company repossesses the goods prior to payment by the customer of all amounts due hereunder, the company may sell the goods, as is, where is, free and clear of all rights of the customer at either public or private sales, and apply the net proceeds (after deducting expenses of repossession and sale) to the obligation of customer hereunder. The customer may dispose of the goods in any commercially reasonable place and manner and the customer waives any notice of time, place and manner of sale.

Integration

This order for goods, including these terms and conditions, along with any credit application, invoice, statement, dealer contract, acknowledgment, bill of lading (and any exhibits, addenda or amendments thereto) of which this order may be a part, constitutes the sole and complete agreement between the company and the customer with respect to the purchase of the goods.

Dimensions/Specifications/Finishes

All dimensions are approximate and may vary due to the upholstery technique of each craftsman. If exact dimensions are required, it is necessary for the customer to state such specifications with the order. Detailed specifications sheets are available for each series of goods, and customer should consult the company's customer service department for these specification sheets. Company reserves the right to make changes in dimensions, style, or specifications if company believes these changes will improve the goods' quality or appearance. Company reserves the right to substitute hardwoods due to availability at production. Due to the natural characteristics of wood, environmental effects, and material upgrades, the company cannot guarantee exact finish matches on existing goods previously ordered from company. If an exact march to customer's existing goods is required, it must be specified so that the proper procedures can be followed to ensure an acceptable finish. Company will accept no liability for the finish if this procedure isn't followed. Company reserves the right to make changes in a finish formula if company believes the change will improve the quality or appearance of company's goods.

Company's Performance of Its Obligation

The production and delivery of the goods to the extent delayed or hindered or prevented from the performance by reason of natural disasters, acts of god, strikes, lockouts, labor troubles, inability to procure materials, casualties, failure of power, restrictive governmental laws or regulations, riots, insurrections, acts of terrorism, war or other reason of a like nature not the fault of the company shall excuse for the period of the delay the company's performance and the period for the performance shall be extended for a period equivalent to the period of such delay.

Training - Table of Contents



Training



Teamwork



Conference



Lounge

Lok - Training

Product Information

- Training Overview 3
- Tables Shapes & Sizes 4
- Laminate Specifications 5
- Base Styles - Features 6
- Nesting Details 7
- Modesty Details 8 - 9
- Screen Details 10 - 11
- Electrical Planning - Options 12 - 13
- How To Specify 14 - 15

Pricing Pages

- Training Table Tops 16-62
- Bases 17-63
- Modesty Panels 64-66
- Privacy Screens 67
- Portable Slide On Screens 68-69
- Instructor Stations 70-71
- Podiums 72
- Mobile & Fixed Screens 73
- ECONO Electrical 74-75
- LINK Electrical 76-77
- Wire Management 78
- Accessories 79

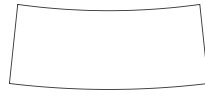
Training - Overview



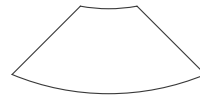
rectangular
pages 22-27



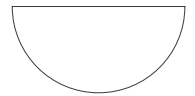
trapezoid
pages 28-29



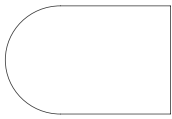
lecture
pages 30-31



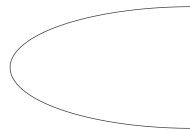
crescent
pages 32-33



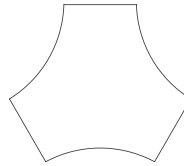
half round
pages 34-35



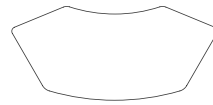
bullet
pages 36



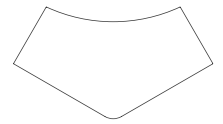
hive
pages 37



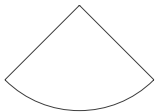
intersect
pages 38



huddle
pages 39



one twenty
pages 40-41



quarter round
pages 42



wedge link
pages 43

Training - Top Shapes

Lok offers 12 training table top shapes. Tables are available in 29" and are always laminate. Compatible bases are: T Base, Cantilever T Base or In Line. Seating capacity below assumes that only one side is used.

LOK - TRAINING



rectangular

- 29"h
- 20" x 36" Seats 1
 - 20" x 48" Seats 1
 - 20" x 60" Seats 2
 - 20" x 66" Seats 2
 - 20" x 72" Seats 3
 - 20" x 84" Seats 3
 - 20" x 96" Seats 4
 - 24" x 36" Seats 1
 - 24" x 48" Seats 1
 - 24" x 60" Seats 2
 - 24" x 66" Seats 2
 - 24" x 72" Seats 3
 - 24" x 84" Seats 3
 - 24" x 96" Seats 4
 - 30" x 36" Seats 1
 - 30" x 48" Seats 1
 - 30" x 60" Seats 2
 - 30" x 72" Seats 3
 - 30" x 84" Seats 3
 - 30" x 96" Seats 4



trapezoid

- 29"h
- 24" x 48" Seats 1
 - 30" x 48" Seats 1



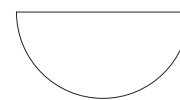
lecture

- 29"h
- 24" x 48" Seats 1
 - 24" x 60" Seats 2
 - 30" x 48" Seats 1
 - 30" x 60" Seats 2



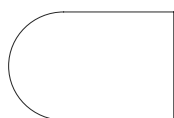
crescent

- 29"h
- 24" x 48" Seats 1
 - 30" x 48" Seats 1



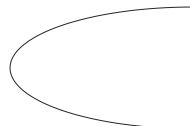
half round

- 29"h
- 24" x 48" Seats 2
 - 30" x 60" Seats 2



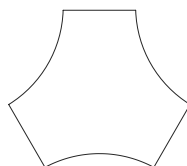
bullet

- 29"h
- 30" x 60" Seats 4
 - 30" x 66" Seats 4
 - 30" x 72" Seats 5
 - 36" x 60" Seats 4
 - 36" x 66" Seats 5
 - 36" x 72" Seats 5
 - 48" x 72" Seats 6



hive

- 29"h
- 30" x 60" Seats 4
 - 30" x 66" Seats 4
 - 30" x 72" Seats 5
 - 36" x 60" Seats 4
 - 36" x 66" Seats 5
 - 36" x 72" Seats 5
 - 48" x 72" Seats 6



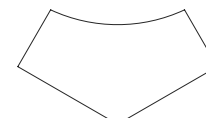
intersect

- 29"h
- 24" x 60" Seats 6
 - 30" x 60" Seats 6



huddle

- 29"h
- 30" x 72" Seats 6
 - 36" x 84" Seats 6



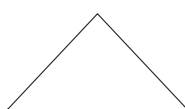
one twenty

- 29"h
- 42" x 73" Seats 4
 - 45" x 84" Seats 4



quarter round

- 29"h
- 24" Seats 1
 - 30" Seats 1



wedge link

- 29"h
- 24" Seats 1
 - 30" Seats 1

Training - Surface Materials

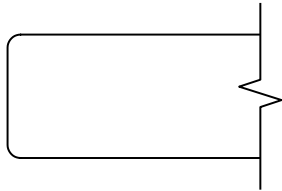
Laminate Tops

Lok training table worksurfaces are offered in both TFL (Thermal Fused Laminate) and HPL (High Pressure Laminate).

The tops are 1 3/8" thick, 3 ply balanced construction.

HPL - Particle board core, HPL face and a phenolic backer sheet complete the balanced construction.

TFL - Particle board core with thermally fused face and matching backer complete the balanced construction.



Eased Edge (R3)

PVC

Standard PVC Edge Colors

JSI supports 24 standard PVC edge colors listed below. These coordinate with our Standard TFL and HPL (T1) Laminates.

When selecting a Standard TFL or HPL 1 Laminate, the coordinating PVC edge color is automatically applied. When selecting a Graded-In Laminate (HPL 2 or HPL 3), you will be prompted to choose one these 24 PVC edge colors to be applied to the edge.

ALB	Alabaster	GRH	Graphite
ALL	Ale Light	MIN	Mineral
BLK	Black	OAT	Oatmeal Cookie
BOL	Bourbon Light	PIN	Pinnacle Walnut
BZW	Brazilwood	PLT	Platinum
BBL	Bridal Blanco	SHD	Shadow
BGL	Brighton Light	SLG	Slate Grey
CLL	Collectors	STU	Studio Teak
DWH	Designer White	UMB	Umber
DOV	Dove Grey	VAL	Valley
FAW	Fawn	VIN	Vintage
FLO	Florence Walnut	WEA	Weathered Ash

Standard Laminates

JSI Standard Laminate program consists of 22 solid and wood grain patterns, and establish our standard TFL and HPL (T1) laminate pricing. Each has a coordinating PVC edge color that is automatically used with the Standard Laminates.

Wood Grain Laminate

ALL	Ale Light	MIN	Mineral
BOL	Bourbon Light	OAT	Oatmeal Cookie
BZW	Brazilwood	PIN	Pinnacle Walnut
BGL	Brighton Light	STU	Studio Teak
CLL	Collectors	UMB	Umber
FAW	Fawn	VAL	Valley
FLO	Florence Walnut	VIN	Vintage
GRH	Graphite	WEA	Weathered Ash

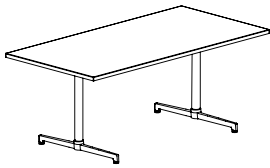
Solid Laminate

ALB	Alabaster
BLK	Black
BBL	Bridal Blanco
DWH	Designer White
SHD	Shadow
SLG	Slate Grey

Training - Base Styles

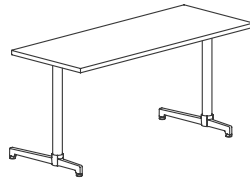
Lok provides a choice selection of bases in both function and aesthetics to serve a variety of needs. The training offering includes: T-base, Cantilever T-Base, and Inline T-Base

LOK - TRAINING



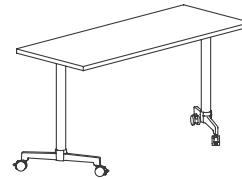
T-Base

- models offered in fixed leg with glide or caster, tilt with caster, or 9 pin adjustable height leg
- compatible with the following top shapes: bullet, crescent, half round, lecture, rectangular, trapezoid, intersect, huddle, hive, one-twenty
- base finish aged bronze, arctic silver, gold, pewter, matte black, soft bronze, soft nickel
- two-tone base aesthetics are achieved when selecting polished aluminum foot



Cantilever T-Base

- models offered in fixed leg with glide or caster, tilt with caster, or 9 pin adjustable height leg
- compatible with the following top shapes: crescent, half round, lecture, rectangular, trapezoid
- base finish aged bronze, arctic silver, gold, pewter, matte black, soft bronze, soft nickel
- two-tone base aesthetics are achieved when selecting polished aluminum foot

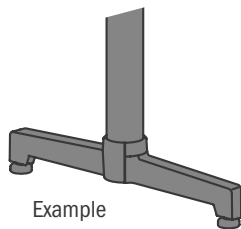


In-Line T-Base

- available in 29" h leg with caster
- compatible with the following top shapes: crescent, half round, lecture, rectangular, trapezoid
- base finish aged bronze, arctic silver, gold, pewter, matte black, soft bronze, soft nickel
- two-tone base aesthetics are achieved when selecting polished aluminum foot

Single Metal Finish

- ABZ** Aged Bronze Feet & Post
- ASL** Arctic Silver Feet & Post
- GLD** Gold Feet & Post
- PEW** Pewter Feet & Post
- MBK** Matte Black Feet & Post
- SBZ** Soft Bronze Feet & Post
- SNK** Soft Nickel Feet & Post

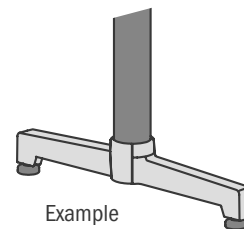


Two - Tone Metal Finish

Two-Tone Aesthetics can be achieved by specifying Polished Aluminum on the foot and a contrasting finish on the post

Polished Aluminum Feet

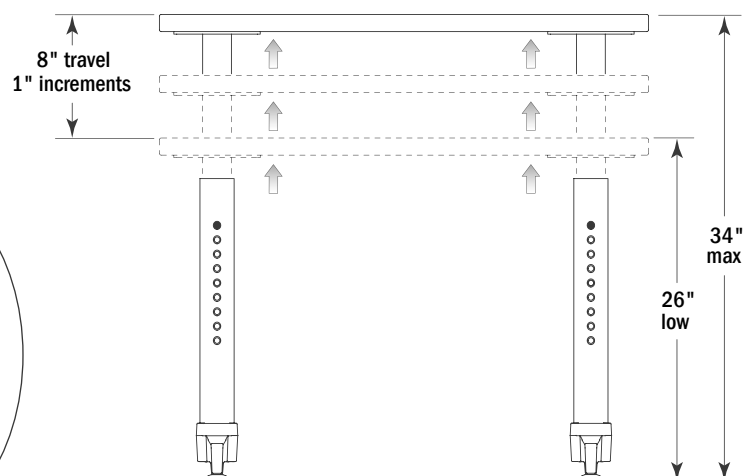
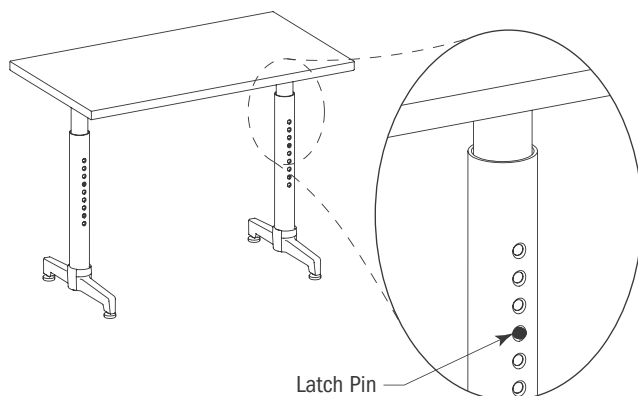
- ABZ** - Aged Bronze Post
- ASL** - Arctic Silver Post
- GLD** - Gold Post
- PEW** - Pewter Post
- MBK** - Matte Black Post
- SBZ** - Soft Bronze Post
- SNK** - Soft Nickel Post



9-Pin Adjustable Height

Pin adjustment located on column offers the ability to adjust tables from 26" to 34" high.

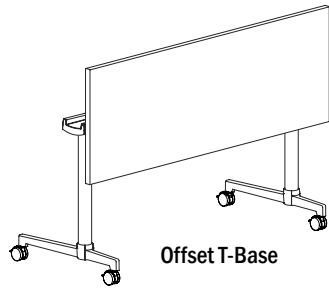
Easy operation by pushing in spring loaded latch pins, slide to desired height position and release pins to lock into place.



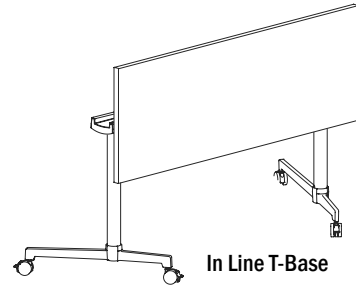
Training - Nesting

Lok In line and Offset Nesting

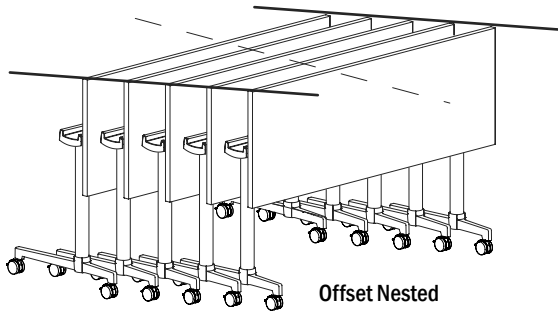
- adapt to ever changing multi-purpose areas, providing reconfigurability
- modularity, flexibility and ease of use by a single individual with single paddle release
- tilt and lock in position for easy nested storage
- offset or in line nesting limit storage space required to move the tables out of the way
- compact tilted tables easily move to another location
- wire management clips are incorporated into the horizontal top cross beam in 48" or wider tables



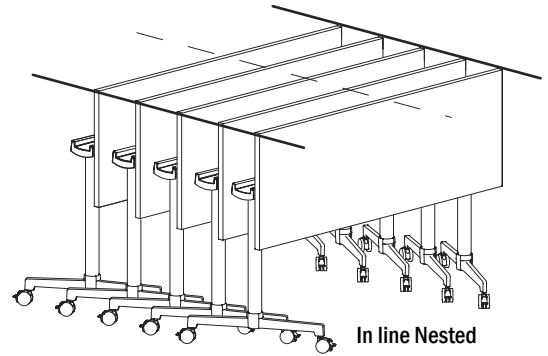
Offset T-Base



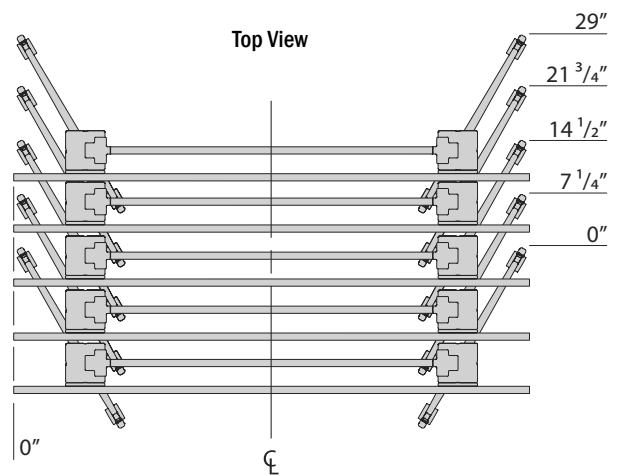
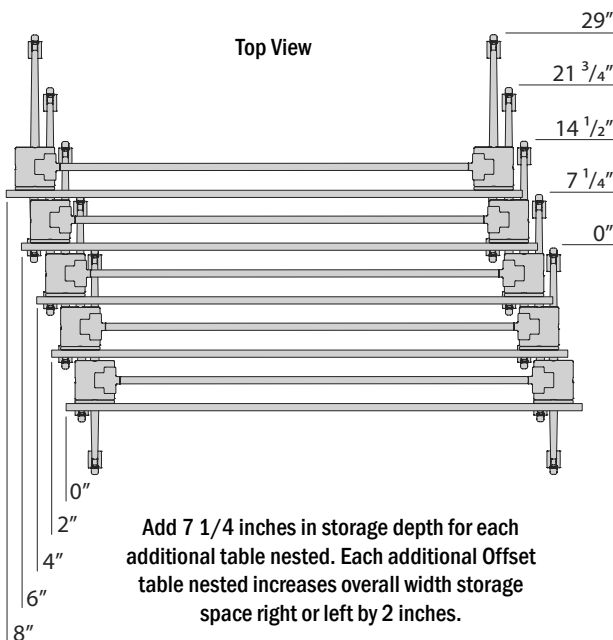
In Line T-Base



Offset Nested



In line Nested

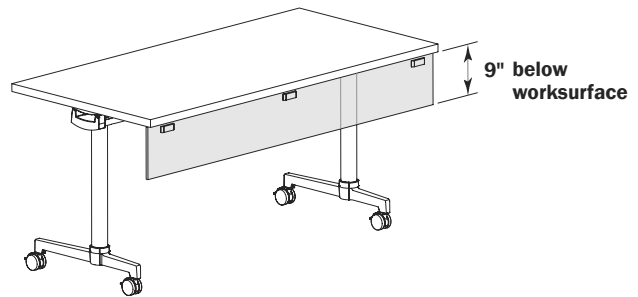
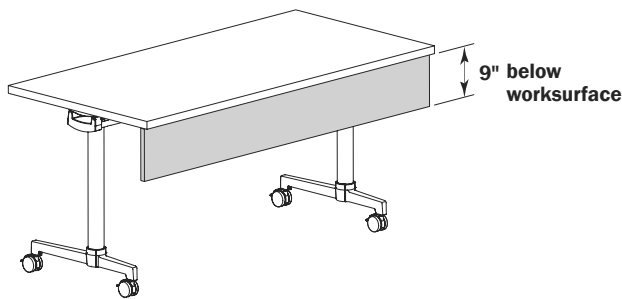


LOK- TRAINING

Training - Modesty Panels

Modesty Panels

Full table width panels provide user 9" of privacy and conceal electrical components and wire channels.



Laminate

- 3/4" thick
- 21 standard TFL or Tier 1 HPL with matching PVC edge
- additional graded in laminates, select from standard PVC edges
- supported with concealed hinge or support brackets
- 5/8" space provided between top edge of modesty panel and bottom surface of top to route electrical wires from top of table to under side

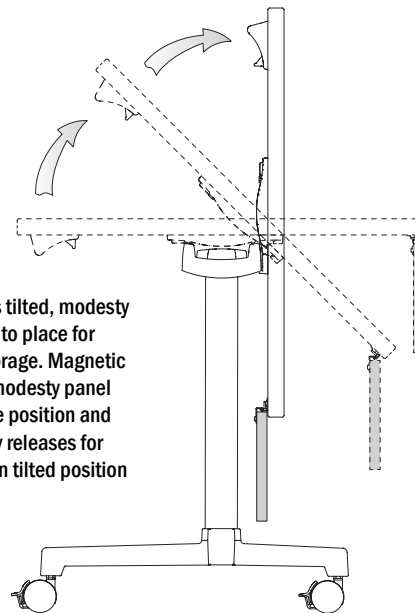
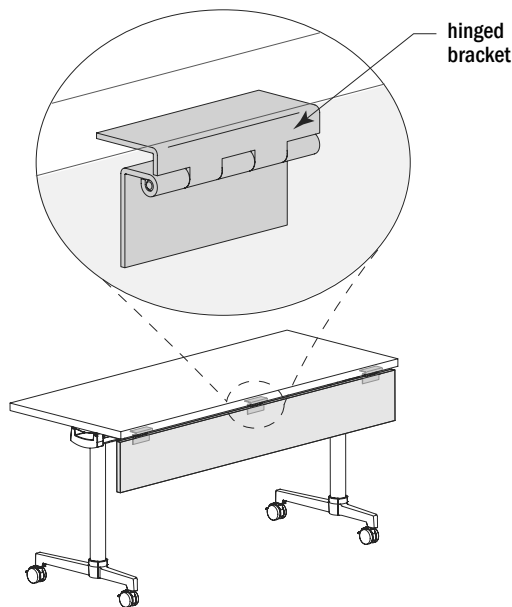
Frosted Acrylic

- 1/4" two sided frosted acrylic
- acrylic panels supported with hinge or bracket with powder-coated cover plate to conceal support hardware
- 5/8" space provided between top edge of modesty panel and bottom surface of top to route electrical wires from top of table to under side
- specify trim cap Aged Bronze, Arctic Silver, Gold, Pewter, Matte Black, Soft Bronze, Soft Nickel

3 Attachment Methods

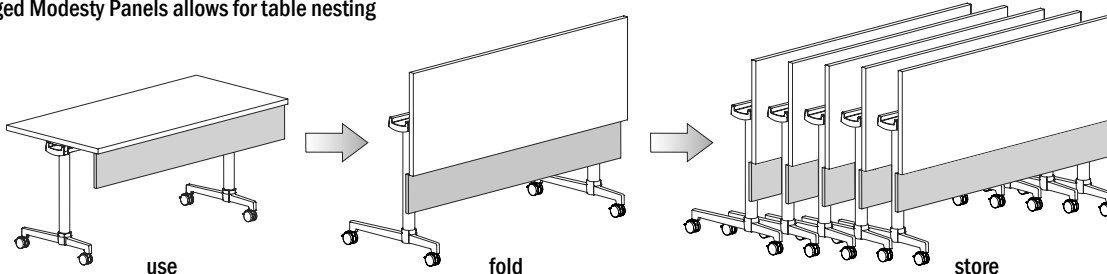
Acrylic and laminate modesty panels can be specified with 3 different attachment methods. Select from Hinged, Removable, or Fixed - see pages 70-72.

1 Hinged Modesty Panels with Tilt Table Option



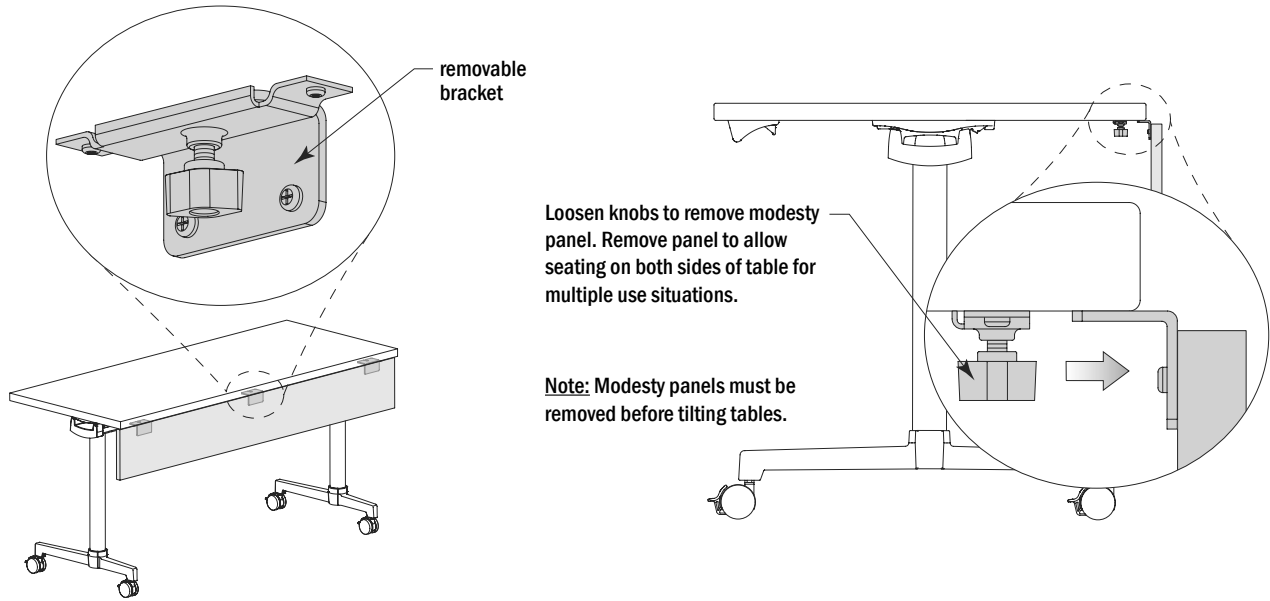
When table is tilted, modesty panel folds into place for organized storage. Magnetic hinge holds modesty panel vertical in use position and automatically releases for self-storage in tilted position

Hinged Modesty Panels allows for table nesting

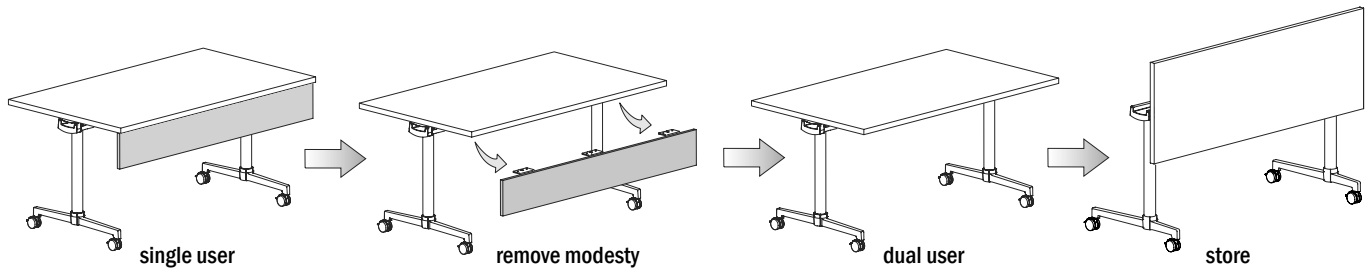


Training - Modesty Panel Attachment Methods

② Removable Modesty Panels with Tilt Table Option

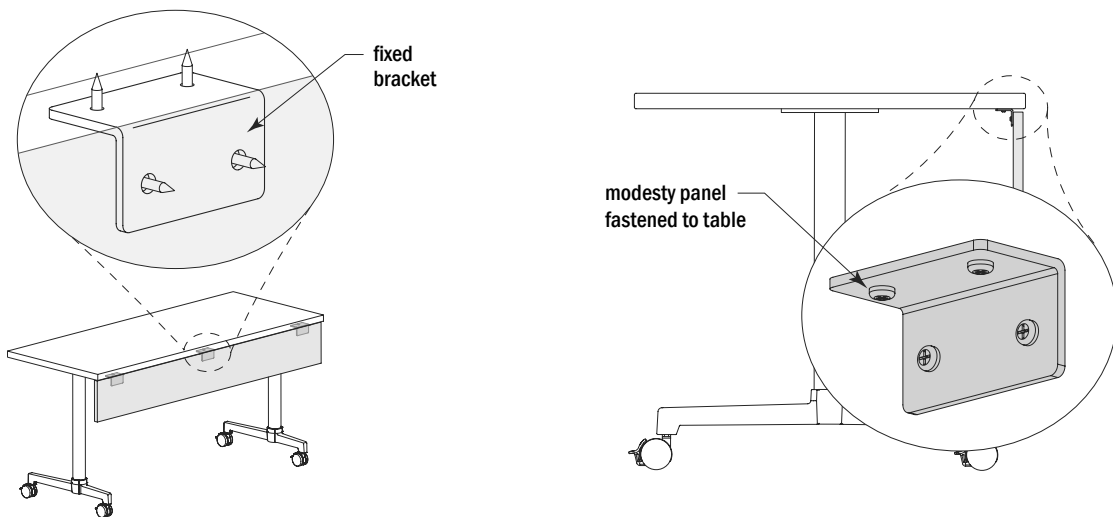


Removable modesty panels allows for single and dual users and storage



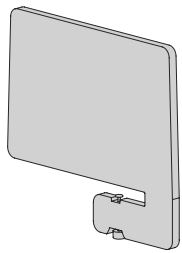
③ Fixed Modesty Panels

Fixed modesty panels are intended to always be attached and should not be specified in conjunction with tilt top tables.

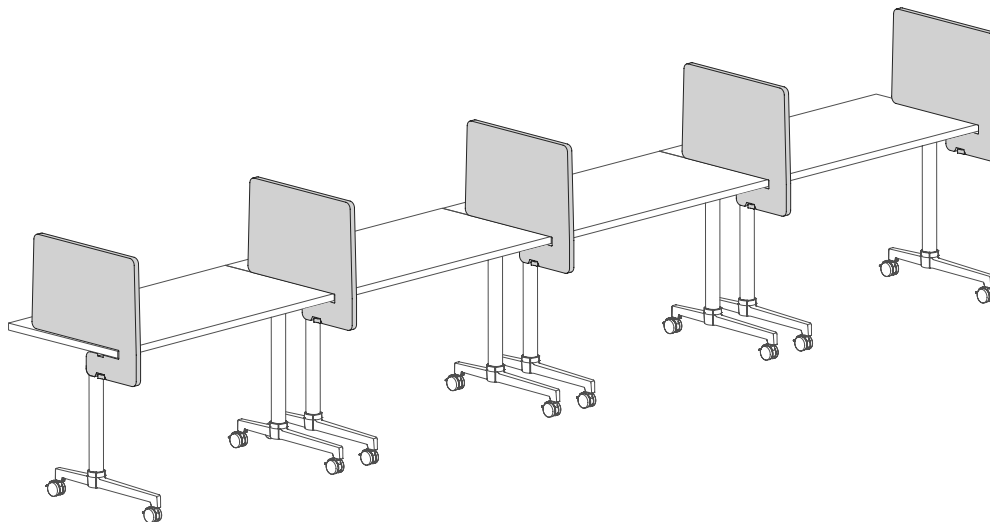
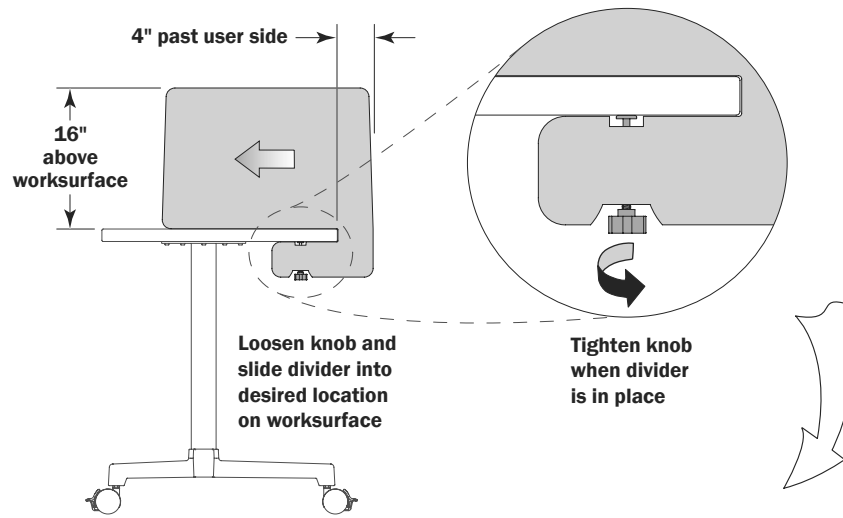


Training - Screens

Portable Slide-On Divider Screen



Portable divider panel divides space between seats and acoustic materials muffles sound in high traffic areas



Acoustic

- screen provides 16" above and 4" user side concealment
- 1" tackable acoustic 100% polyester screens in silver or ash grey
 - acoustic rating: 0.45 - 0.90 NRC
 - fire rating: ASTM-E84 / class A
 - colorfastness to light: AACC 16.3 option 3 color change @ 20AFU = 4.5
 - vacuum to remove dust, remove spills immediately using a clean damp cloth or with soap and water
 - carpet or fabric cleaner can be used for difficult spills - always test on an inconspicuous area first
- easily repositioned by user to divide space or as end of table privacy
- can be secured to any surface 1 1/4" - 1 1/2" thickness and 20" or greater depth
- knob on underside of table temporarily clamps screen in position for easy repositioning

HPL

- particle board core
- HPL laminate surfaces - JSI standards
- matching PVC edge

Markerboard

- plywood core
- white marker HPL surfaces
- white PVC edge

Magnetic Markerboard

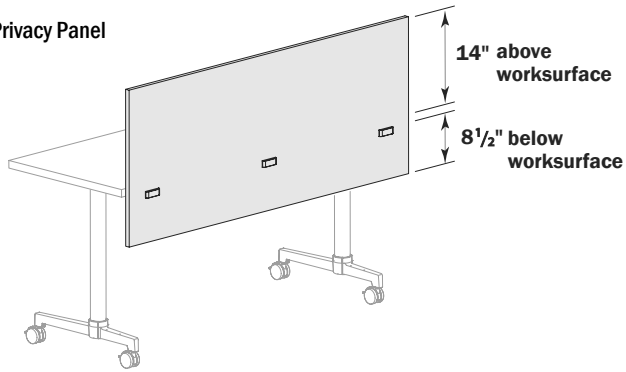
- plywood core
- white magnetic marker HPL surfaces
- white PVC edge

Training - Screens

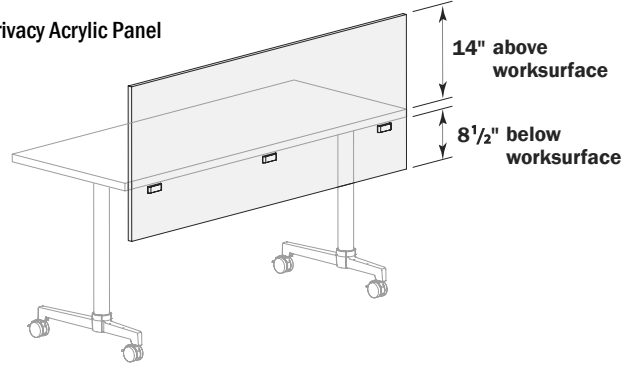
Privacy Panel Screens

Full width panel to provide user privacy concealing electrical components, wire channels and equipment on table top. Screens provide 8 1/2" below and 14" above top concealment

Privacy Panel



Privacy Acrylic Panel



Acoustic

- 1/2" tackable acoustic 100% polyester screens in silver or ash grey
 - acoustic rating: 0.45 - 0.90 NRC
 - fire rating: ASTM-E84 / class A
 - colorfastness to light: AACC 16.3 option 3 color change @ 20AFU = 4.5
 - vacuum to remove dust, remove spills immediately using a clean damp cloth or with soap and water
 - carpet or fabric cleaner can be used for difficult spills - always test on an inconspicuous area first

Acrylic

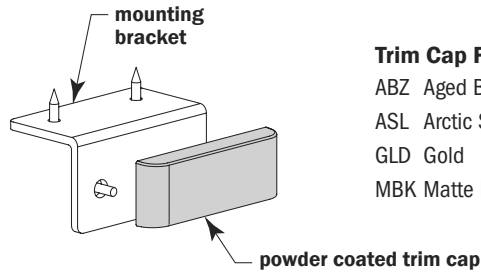
- 1/4" two sided frosted acrylic

Privacy Panel Colors

ASH	Ash Grey
SIL	Silver Grey

Screen Mounting

- screens supported by brackets with powder coated cover plates fastened to underside of top
- mounting brackets can be fastened out for routing cables to underside of top or to install monitor arm
- screens available for approach and end of table applications
- linking kits available for shared privacy screen application between two tables approach or end applications
- screens must be removed before tilting



Trim Cap Finishes

- ABZ Aged Bronze
- ASL Arctic Silver
- GLD Gold
- MBK Matte Black
- PEW Pewter
- SBZ Soft Bronze
- SNK Soft Nickel

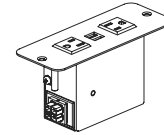
Training - Electrical - LINK System

Overview

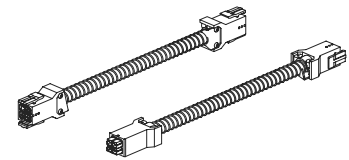
LINK has in-surface 110 power with USB A charging. Non-direction / non-sequential power cables plug together with red, green, white and black terminal connections. Configure with single or dual circuit units to maximize power flexibility. LINK provides three power infeed models; NEMA 15amp or 20amp three prong plug single circuit, quick disconnect or hardwire to support single or dual circuit applications.

- two 110 power and dual USB type A charging
- Metal unit - black or white color selection
- Non-directional / non-sequential power
- Three building power connection infeed models to select from
- Up to eight duplex devices per infeed circuit

Components included when LINK Power selected:



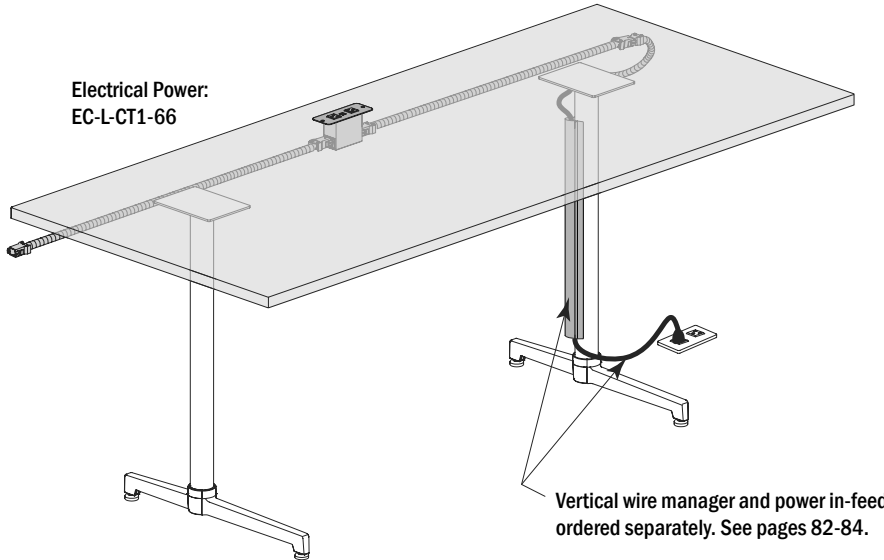
Top Unit x 1



Jumper x 2

- 1 - female to female
- 1 - female to male

Above quantity shows when C (Center) is specified.
When L (Left) / R (Right) are specified, the quantity is double.
Top Unit x 2 and Jumper x 3

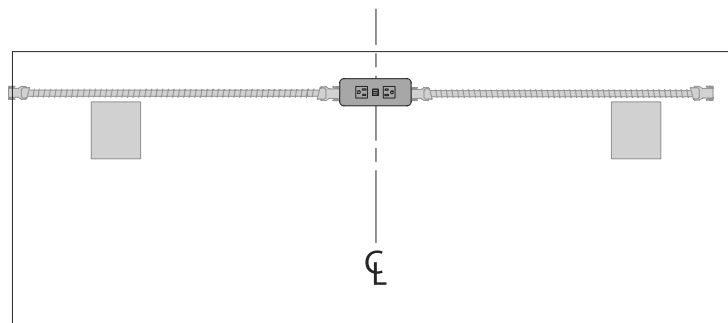


Electrical

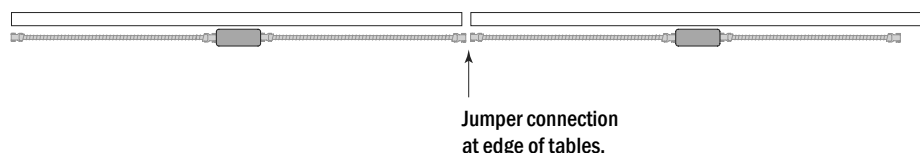
Power Packages are measured and located out from the center of the table. Shown on rectangular tops, these dimensions are the same from center regardless of table shape. Power in-feed is specified separately to support building electrical connection.

LINK Components:

Ganged Tables	Power In-Feed	Power Centers	Jumpers
48" - 96" Tables - CT1			
8	1	8	16
7	1	7	14
6	1	6	12
5	1	5	10
4	1	4	8
3	1	3	6
2	1	2	4
1	1	1	2
66" - 96" Tables - LRT2			
4	1	8	12
3	1	6	9
2	1	4	6
1	1	2	3



L-CT1-C0 - Single Power in Center Location on top cutout locations

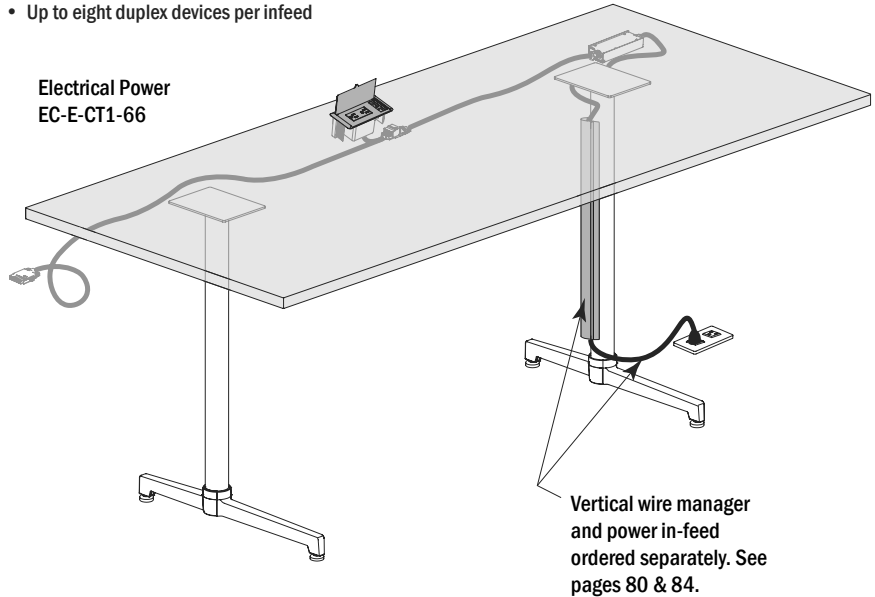


Training - Electrical - ECONO System

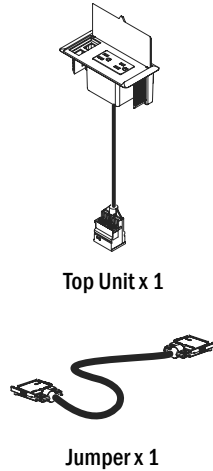
Overview

ECONO electrical system allows up to eight duplex power modules to be daisy-chained together (non-direction / non-sequential) and powered from a single power in-feed. The number of power modules connected is limited to the maximum allowed under UL Standard 962. If too many are connected, the control module disconnects all power to the system and signals red. Power is restored to the system after the extra power module(s) are disconnected, which is indicated by a green light. Econo will not work with GFI or GFCI - Ground Fault Circuit Interrupter Wall or Floor Outlets.

- Two 110 power and two data openings
- Single circuit power with 12 amp total system
- Plastic unit with retractable lid - black or grey color selection
- Over-current protection
- Up to eight duplex devices per infeed



Components included when ECONO Power selected:



Above quantity shows when C (Center) is specified.

When L (Left) / R (Right) are specified, the quantity is double.

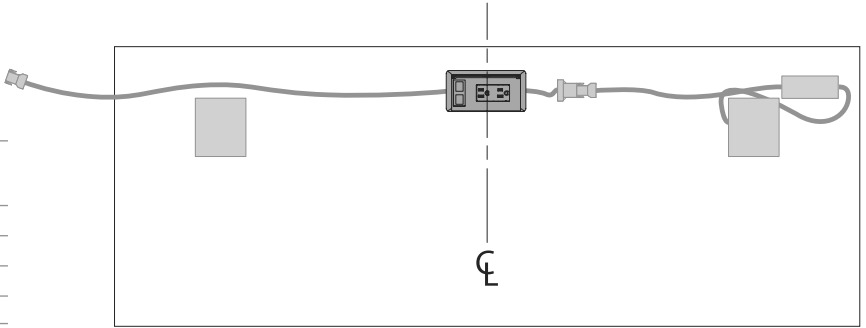
Top Unit x 2 and Jumper x 2

Electrical

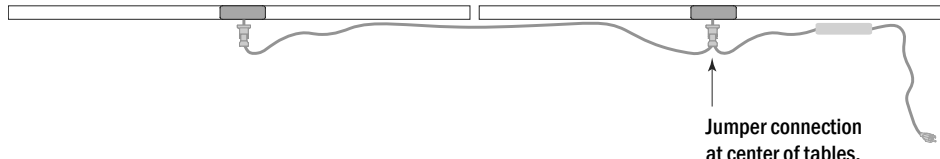
Power is measured and located out from the center of the table. Shown on rectangular tops, these dimensions are the same from center regardless of table shape. Power in-feed is specified separately to support building electrical connection.

ECONO Components:

Ganged Tables	Power In-Feed	Power Centers	Jumpers
48" - 96" Tables - CT1			
8	1	8	8
7	1	7	7
6	1	6	6
5	1	5	5
4	1	4	4
3	1	3	3
2	1	2	2
1	1	1	1
66" - 96" Tables - LRT2			
4	1	8	8
3	1	6	6
2	1	4	4
1	1	2	2



E-CT1-C0 - Single Power in Center Location on top cutout locations



Training - Cantilever Tilt Specifying

Overview

Lok Training was created with the simple a la carte, select of top, base, electrical, and screens. Pages with tops list all the necessary details to determine your budget with page references to guide you to the detail selections, including all the available options, colors and finishes. Build it your way in 5 easy steps!

1. Specify Top

- a. power cut out (optional)
- b. link (optional)

2. Specify Base

3. Specify Modesty Panel

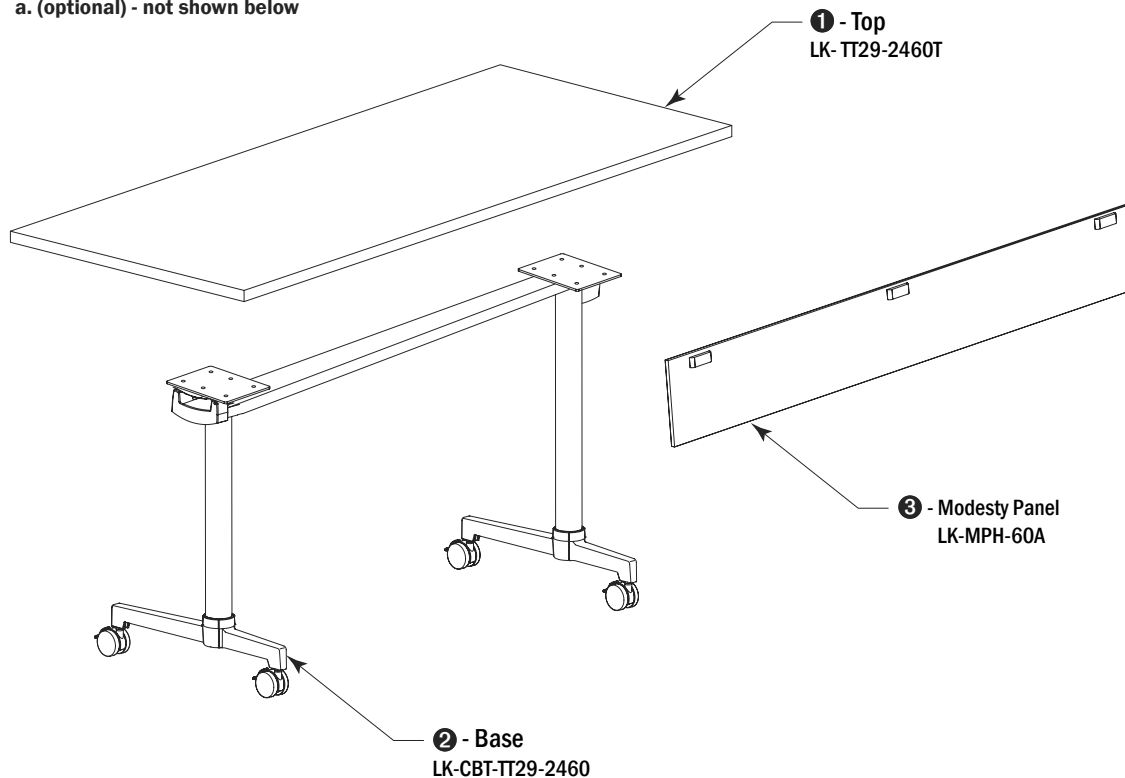
- a. (optional)

4. Specify Electrical

- a. (optional) - not shown below

5. Specify Accessories

- a. (optional) - not shown below



Model Number Breakdown

1 - Top

LK-TT29-2460T

LK	TT	29	2460	T	
Lok Designator	Top Shape - Rectangular	Table Height - 29"	Top Size - 24" x 60"	Top Material - Laminate	

2 - Base

LK-CBT-TT29-2460

LK	CBT	TT	29	2460	
Lok Designator	Base Type - Cantilever T-Base Tilt (with casters option)	29" Table Height	Table Height - 29"	Top Size - 24" x 60"	

3 - Modesty Panel

LK-MPH-60A

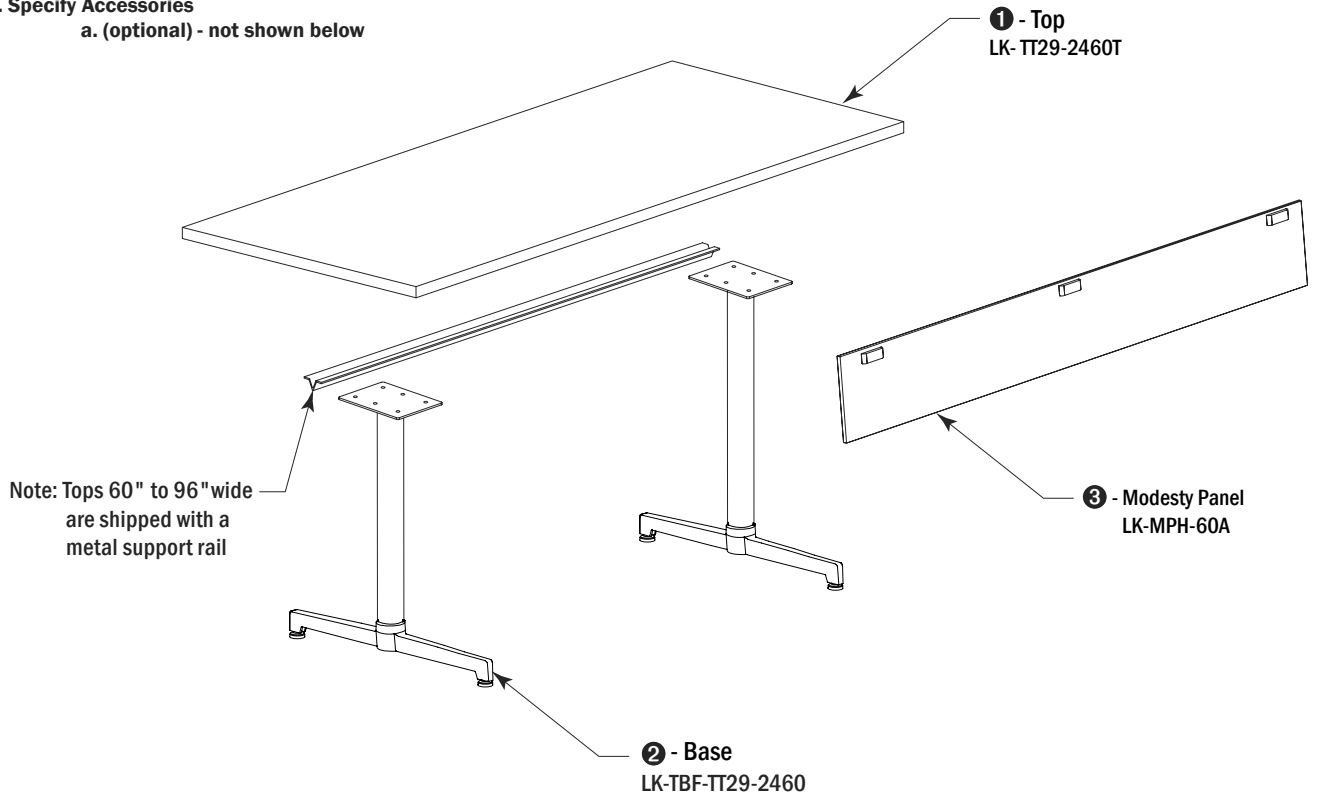
LK	MP	H	60	A	
Lok Designator	Panel Type - Modesty	Function - Hinged	Panel Size - 60"	Panel Material - Frosted Acrylic	

Training - Fixed T Specifying

Overview

Lok Training table offer the many configurations and room layouts to support todays diverse learning environments. When planning a space, select the size and shape tops that best fit the space you are planning. Then select the base type that supports the function the space requires, static setting with T-Base and glides, additional knee space with cantilever T-base, easy reconfiguration by adding casters, compact storage with offset or inline tilt/nest, special height considerations with pin height adjustment.

- 1. Specify Top
 - a. power cut out (optional)
 - b. link (optional)
- 2. Specify Base
- 3. Specify Modesty Panel
 - a. (optional)
- 4. Specify Electrical
 - a. (optional) - not shown below
- 5. Specify Accessories
 - a. (optional) - not shown below



Model Number Breakdown

1 - Top

LK-TT29-2460T					
LK	TT	29	2460	T	
Lok Designator	Top Shape - Rectangular	Table Height - 29"	Top Size - 24" x 60"	Top Material - Laminate	

2 - Base

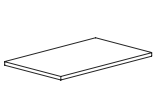
LK-TBF-TT29-2460					
LK	TBF	TT	29	2460	
Lok Designator	Base Type - Fixed T-Base (standard with glides)	29" Table Height	Table Height - 29"	Top Size - 24" x 60"	

3 - Modesty Panel

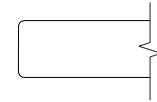
LK-MPH-60A					
LK	MP	H	60	A	
Lok Designator	Panel Type - Modesty	Function - Hinged	Panel Size - 60"	Panel Material - Frosted Acrylic	

Description

Rectangular Training Top



top shape



Eased Edge (R3)

D	W	H	CTN WT	CU FT	Model	TFL	Standard		Graded In	
							HPL 1	HPL 2	HPL 3	HPL 3
20	36	29	22	2	LK-TT29-2036T	\$249	\$335	\$350	\$401	
24	36	29	26	2	LK-TT29-2436T	\$281	\$359	\$378	\$439	
30	36	29	33	3	LK-TT29-3036T	\$293	\$399	\$421	\$499	
20	48	29	29	2	LK-TT29-2048T	\$281	\$387	\$405	\$475	
24	48	29	35	3	LK-TT29-2448T	\$319	\$420	\$443	\$525	
30	48	29	43	3	LK-TT29-3048T	\$335	\$471	\$501	\$601	

LOK - TRAINING LAMINATE

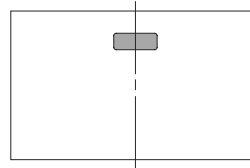
Table Components: (order separately)

- base, modesty panel, electrical, and privacy screens sold and ship separately
- specify power option, see below
- optional set of (2) linking bracket, specify and add an additional \$60 list

Electrical Options/Cutout Locations:

- specify power cutout and indicate if Link or Econo System will be used
- reference drawing below for approximate location

CT1 : Single Power Center Top Cutout Location



(36"- 48" wide)

To Order Specify

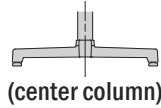
1 Model #	2a Laminate Selection	2b PVC Edge Color	3 Electrical
Model (LK)	See Laminate Selection	See PVC Edge Color Options	N None L-CT1-CO Link System - Center Top Single Power Cutout E-CT1-CO Econo System - Center Top Single Power Cutout

Model Number Breakdown

LK-TT29-2036T					
LK	TT	29	2036	T	
LOK	Rectangular Top Shape	Height	20" x 36"	Laminate	

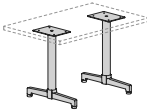
Training Table Bases

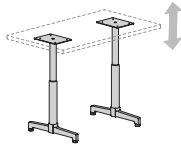
Select base preference below to go with corresponding Top. Note: Base depth and width must match Top depth (D) and width (W).



T-Bases

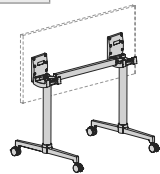
(center column)

Fixed	Width	Model	List Price
 T-Base Fixed	36"	LK-TBF-TT29-2036	+\$486
		LK-TBF-TT29-2436	+\$513
		LK-TBF-TT29-3036	+\$545
	48"	LK-TBF-TT29-2048	+\$486
		LK-TBF-TT29-2448	+\$513
		LK-TBF-TT29-3048	+\$545



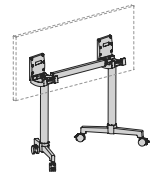
T-Base Adjustable

Width	Model	List Price
36"	LK-TBA-TT29-2036	+\$598
	LK-TBA-TT29-2436	+\$626
	LK-TBA-TT29-3036	+\$656
48"	LK-TBA-TT29-2048	+\$598
	LK-TBA-TT29-2448	+\$626
	LK-TBA-TT29-3048	+\$656



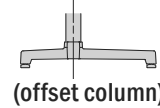
T-Base Tilt

Width	Model	List Price
36"	LK-TBT-TT29-2036	+\$850
	LK-TBT-TT29-2436	+\$877
	LK-TBT-TT29-3036	+\$910
48"	LK-TBT-TT29-2048	+\$973
	LK-TBT-TT29-2448	+\$1,000
	LK-TBT-TT29-3048	+\$1,033



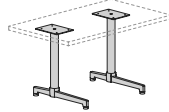
Inline T-Base

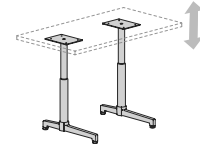
Width	Model	List Price
48"	LK-IBT-TT29-2048	+\$892
	LK-IBT-TT29-2448	+\$892



Cantilever T-Bases

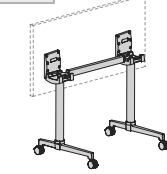
(offset column)

Fixed	Width	Model	List Price
 Cantilever T-Base Fixed	36"	LK-CBF-TT29-2036	+\$501
		LK-CBF-TT29-2436	+\$515
		LK-CBF-TT29-3036	+\$542
	48"	LK-CBF-TT29-2048	+\$501
		LK-CBF-TT29-2448	+\$515
		LK-CBF-TT29-3048	+\$542



Cantilever T-Base Adj.

Width	Model	List Price
36"	LK-CBA-TT29-2036	+\$612
	LK-CBA-TT29-2436	+\$628
	LK-CBA-TT29-3036	+\$653
48"	LK-CBA-TT29-2048	+\$612
	LK-CBA-TT29-2448	+\$628
	LK-CBA-TT29-3048	+\$653



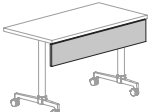
Cantilever T-Base Tilt

Width	Model	List Price
36"	LK-CBT-TT29-2036	+\$879
	LK-CBT-TT29-2436	+\$894
	LK-CBT-TT29-3036	+\$921
48"	LK-CBT-TT29-2048	+\$1,002
	LK-CBT-TT29-2448	+\$1,017
	LK-CBT-TT29-3048	+\$1,043

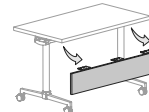
See pages 6-7 for additional information on Lok Bases.

See pages 38-44 on how to order/specify Lok Bases for Rectangular Tops, including caster color options.

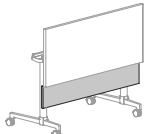
Training Table Modesty Panels

	Material	Model	Standard List	Graded In HPL 2	Graded In HPL 3
 Fixed Modesty	Acrylic	LK-MPF-36A	+\$309	--	--
		LK-MPF-48A	+\$346	--	--
	TFL	LK-MPF-36T	+\$166	--	--
		LK-MPF-48T	+\$174	--	--
	HPL	LK-MPF-36H	+\$242	+\$251	+\$300
		LK-MPF-48H	+\$257	+\$268	+\$334

Note: Fixed modesty panels are intended to always be attached to top and should not be specified in conjunction with Tilt T-Bases.

	Material	Model	Standard List	Graded In HPL 2	Graded In HPL 3
 Removable Modesty	Acrylic	LK-MPR-36A	+\$347	--	--
		LK-MPR-48A	+\$383	--	--
	TFL	LK-MPR-36T	+\$203	--	--
		LK-MPR-48T	+\$211	--	--
	HPL	LK-MPR-36H	+\$279	+\$289	+\$338
		LK-MPR-48H	+\$295	+\$306	+\$372

Note: Removable modesty panels when used with Tilt T-bases must be removed before tilting table.

	Material	Model	Standard List	Graded In HPL 2	Graded In HPL 3
 Hinged Modesty	Acrylic	LK-MPH-36A	+\$330	--	--
		LK-MPH-48A	+\$380	--	--
	TFL	LK-MPH-36T	+\$202	--	--
		LK-MPH-48T	+\$210	--	--
	HPL	LK-MPH-36H	+\$278	+\$287	+\$336
		LK-MPH-48H	+\$294	+\$305	+\$371

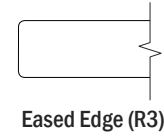
Note: Hinged modesty panels are intended to be used with Tilt T-Bases for tilting and table nesting. Not to be specified with Fixed T-Bases.

See pages 8-9 for additional information on Lok Modesty Panels.

See pages 64-66 on how to order/specify Lok Modesty Panels.

Description

Rectangular Training Top



D	W	H	CTN WT	CU FT	❶ Model	TFL	Standard		Graded In	
							HPL 1	HPL 2	HPL 3	
20	60	29	36	3	LK-TT29-2060T	\$309	\$432	\$456	\$541	
24	60	29	43	3	LK-TT29-2460T	\$358	\$472	\$503	\$604	
30	60	29	54	4	LK-TT29-3060T	\$377	\$537	\$571	\$699	
20	66	29	39	3	LK-TT29-2066T	\$356	\$457	\$483	\$586	
24	66	29	47	4	LK-TT29-2466T	\$428	\$505	\$539	\$656	
30	66	29	60	5	LK-TT29-3066T	\$450	\$583	\$623	\$766	
20	72	29	43	3	LK-TT29-2072T	\$376	\$482	\$512	\$613	
24	72	29	52	4	LK-TT29-2472T	\$447	\$531	\$567	\$689	
30	72	29	65	5	LK-TT29-3072T	\$471	\$611	\$653	\$805	

LOK - TRAINING LAMINATE

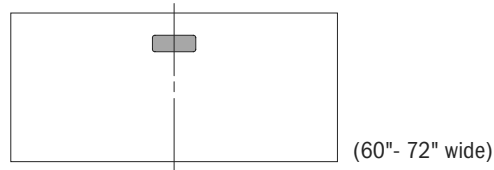
Table Components: (order separately)

- base, modesty panel, electrical, and privacy screens sold and ship separately
- specify power option, see below
- optional set of (2) linking bracket, specify and add an additional \$60 list

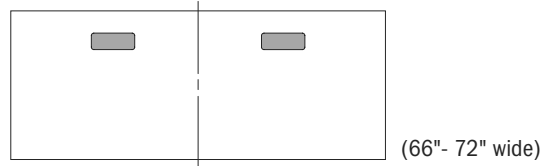
Electrical Options/Cutout Locations:

- specify power cutout and indicate if Link or Econo System will be used
- reference drawing below for approximate location

CT1 : Single Power Center Top Cutout Location



LRT2 : Dual Power Left/Right Top Cutout Location



To Order Specify

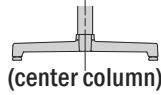
❶ Model #	❷a Laminate Selection	❷b PVC Edge Color	❸ Electrical
Model (LK)	See Laminate Selection	See PVC Edge Color Options	N None L-CT1-CO Link System - Center Top Single Power Cutout E-CT1-CO Econo System - Center Top Single Power Cutout L-LRT2-CO Link System - Left/Right Top Dual Power Cutout E-LRT2-CO Econo System - Left/Right Top Dual Power Cutout

Model Number Breakdown

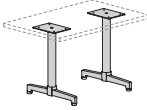
LK-TT29-2060T					
LK	TT	29	2060	T	
LOK	Rectangular Top Shape	Height	20" x 60"	Laminate	

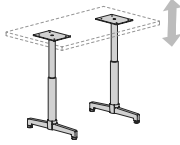
Training Table Bases

Select base preference below to go with corresponding Top. **Note:** Base depth and width must match Top depth (D) and width (W).



T-Bases

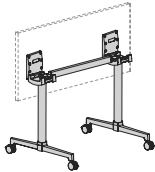
Fixed	Width	Model	List Price
 T-Base Fixed	60"	LK-TBF-TT29-2060	+\$543
		LK-TBF-TT29-2460	+\$568
		LK-TBF-TT29-3060	+\$600
	66"	LK-TBF-TT29-2066	+\$543
		LK-TBF-TT29-2466	+\$568
		LK-TBF-TT29-3066	+\$600
	72"	LK-TBF-TT29-2072	+\$552
		LK-TBF-TT29-2472	+\$579
		LK-TBF-TT29-3072	+\$611



T-Base Adjustable

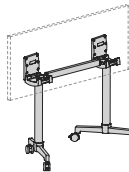
Width	Model	List Price
60"	LK-TBA-TT29-2060	+\$654
	LK-TBA-TT29-2460	+\$680
	LK-TBA-TT29-3060	+\$713
66"	LK-TBA-TT29-2066	+\$654
	LK-TBA-TT29-2466	+\$680
	LK-TBA-TT29-3066	+\$713
72"	LK-TBA-TT29-2072	+\$664
	LK-TBA-TT29-2472	+\$691
	LK-TBA-TT29-3072	+\$723

Tilt



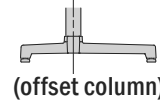
T-Base Tilt

Width	Model	List Price
60"	LK-TBT-TT29-2060	+\$989
	LK-TBT-TT29-2460	+\$1,015
	LK-TBT-TT29-3060	+\$1,046
66"	LK-TBT-TT29-2066	+\$989
	LK-TBT-TT29-2466	+\$1,015
	LK-TBT-TT29-3066	+\$1,046
72"	LK-TBT-TT29-2072	+\$1,017
	LK-TBT-TT29-2472	+\$1,045
	LK-TBT-TT29-3072	+\$1,076

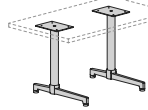


Inline T-Base

Width	Model	List Price
60"	LK-IBT-TT29-2060	+\$1,015
	LK-IBT-TT29-2460	+\$1,015
66"	LK-IBT-TT29-2066	+\$1,015
	LK-IBT-TT29-2466	+\$1,015
72"	LK-IBT-TT29-2072	+\$1,031
	LK-IBT-TT29-2472	+\$1,031



Cantilever T-Bases

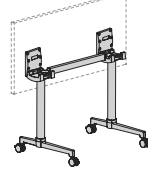
Fixed	Width	Model	List Price
 Cantilever T-Base Fixed	60"	LK-CBF-TT29-2060	+\$555
		LK-CBF-TT29-2460	+\$570
		LK-CBF-TT29-3060	+\$598
	66"	LK-CBF-TT29-2066	+\$555
		LK-CBF-TT29-2466	+\$570
		LK-CBF-TT29-3066	+\$598
	72"	LK-CBF-TT29-2072	+\$566
		LK-CBF-TT29-2472	+\$582
		LK-CBF-TT29-3072	+\$607



Cantilever T-Base Adj.

Width	Model	List Price
60"	LK-CBA-TT29-2060	+\$668
	LK-CBA-TT29-2460	+\$682
	LK-CBA-TT29-3060	+\$711
66"	LK-CBA-TT29-2066	+\$668
	LK-CBA-TT29-2466	+\$682
	LK-CBA-TT29-3066	+\$711
72"	LK-CBA-TT29-2072	+\$678
	LK-CBA-TT29-2472	+\$693
	LK-CBA-TT29-3072	+\$719

Tilt



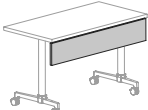
Cantilever T-Base Tilt

Width	Model	List Price
60"	LK-CBT-TT29-2060	+\$1,016
	LK-CBT-TT29-2460	+\$1,033
	LK-CBT-TT29-3060	+\$1,059
66"	LK-CBT-TT29-2066	+\$1,016
	LK-CBT-TT29-2466	+\$1,033
	LK-CBT-TT29-3066	+\$1,059
72"	LK-CBT-TT29-2072	+\$1,046
	LK-CBT-TT29-2472	+\$1,061
	LK-CBT-TT29-3072	+\$1,088

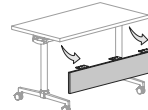
See pages 6-7 for additional information on Lok Bases.

See pages 38-44 on how to order/specify Lok Bases for Rectangular Tops, including caster color options.

Training Table Modesty Panels

	Material	Model	Standard List	Graded In HPL 2	Graded In HPL 3
 Fixed Modesty	Acrylic	LK-MPF-60A	+\$424	--	--
		LK-MPF-66A	+\$453	--	--
		LK-MPF-72A	+\$478	--	--
	TFL	LK-MPF-60T	+\$196	--	--
		LK-MPF-66T	+\$201	--	--
		LK-MPF-72T	+\$204	--	--
	HPL	LK-MPF-60H	+\$290	+\$303	+\$384
		LK-MPF-66H	+\$298	+\$313	+\$403
		LK-MPF-72H	+\$307	+\$321	+\$421

Note: Fixed modesty panels are intended to always be attached to top and should not be specified in conjunction with Tilt T-Bases.

	Material	Model	Standard List	Graded In HPL 2	Graded In HPL 3
 Removable Modesty	Acrylic	LK-MPR-60A	+\$480	--	--
		LK-MPR-66A	+\$509	--	--
		LK-MPR-72A	+\$533	--	--
	TFL	LK-MPR-60T	+\$253	--	--
		LK-MPR-66T	+\$257	--	--
		LK-MPR-72T	+\$261	--	--
	HPL	LK-MPR-60H	+\$346	+\$358	+\$441
		LK-MPR-66H	+\$354	+\$369	+\$460
		LK-MPR-72H	+\$363	+\$379	+\$478

Note: Removable modesty panels when used with Tilt T-bases must be removed before tilting table.

See pages 8-9 for additional information on Lok Modesty Panels.

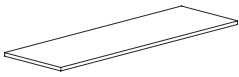
See pages 64-66 on how to order/specify Lok Modesty Panels.

	Material	Model	Standard List	Graded In HPL 2	Graded In HPL 3
 Hinged Modesty	Acrylic	LK-MPH-60A	+\$475	--	--
		LK-MPH-66A	+\$507	--	--
		LK-MPH-72A	+\$528	--	--
	TFL	LK-MPH-60T	+\$244	--	--
		LK-MPH-66T	+\$249	--	--
		LK-MPH-72T	+\$253	--	--
	HPL	LK-MPH-60H	+\$338	+\$351	+\$434
		LK-MPH-66H	+\$347	+\$360	+\$454
		LK-MPH-72H	+\$355	+\$371	+\$470

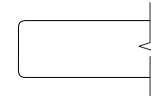
Note: Hinged modesty panels are intended to be used with Tilt T-Bases for tilting and table nesting. Not to be specified with Fixed T-Bases.

Description

Rectangular Training Top



top shape



Eased Edge (R3)

D	W	H	CTN WT	CU FT	❶ Model	TFL	Standard		
							HPL 1	HPL 2	HPL 3
20	84	29	51	4	LK-TT29-2084T	\$400	\$537	\$570	\$689
24	84	29	61	4	LK-TT29-2484T	\$471	\$592	\$633	\$775
30	84	29	76	5	LK-TT29-3084T	\$492	\$676	\$726	\$904
20	96	29	58	4	LK-TT29-2096T	\$416	\$583	\$621	\$757
24	96	29	69	5	LK-TT29-2496T	\$489	\$647	\$692	\$854
30	96	29	86	6	LK-TT29-3096T	\$513	\$742	\$800	\$1,001

LAMINATE

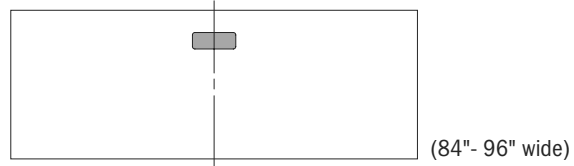
Table Components: (order separately)

- base, modesty panel, electrical, and privacy screens sold and ship separately
- specify power option, see below
- optional set of (2) linking bracket, specify and add an additional \$60 list

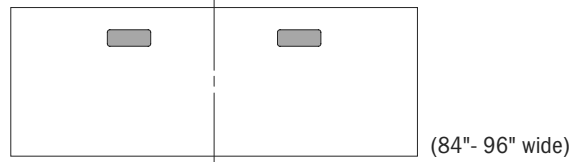
Electrical Options/Cutout Locations:

- specify power cutout and indicate if Link or Econo System will be used
- reference drawing below for approximate location

CT1 : Single Power Center Top Cutout Location



LRT2 : Dual Power Left/Right Top Cutout Location



To Order Specify

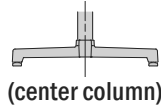
❶ Model #	❷a Laminate Selection	❷b PVC Edge Color	❸ Electrical
Model (LK)	See Laminate Selection	See PVC Edge Color Options	N None L-CT1-CO Link System - Center Top Single Power Cutout E-CT1-CO Econo System - Center Top Single Power Cutout L-LRT2-CO Link System - Left/Right Top Dual Power Cutout E-LRT2-CO Econo System - Left/Right Top Dual Power Cutout

Model Number Breakdown

LK-TT29-2084T				
LK	TT	29	2084	T
LOK	Rectangular Top Shape	Height	20" x 84"	Laminate

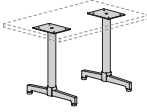
Training Table Bases


Select base preference below to go with corresponding Top. Note: Base depth and width must match Top depth (D) and width (W).

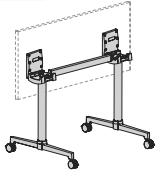


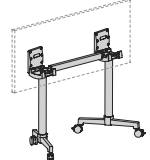
T-Bases

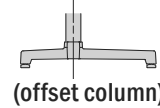
(center column)

Fixed	Width	Model	List Price
 T-Base Fixed	84"	LK-TBF-TT29-2084	+\$552
		LK-TBF-TT29-2484	+\$579
		LK-TBF-TT29-3084	+\$611
	96"	LK-TBF-TT29-2096	+\$570
		LK-TBF-TT29-2496	+\$598
		LK-TBF-TT29-3096	+\$630

T-Base Adjustable	Width	Model	List Price
 T-Base Adjustable	84"	LK-TBA-TT29-2084	+\$664
		LK-TBA-TT29-2484	+\$691
		LK-TBA-TT29-3084	+\$723
	96"	LK-TBA-TT29-2096	+\$682
		LK-TBA-TT29-2496	+\$711
		LK-TBA-TT29-3096	+\$742

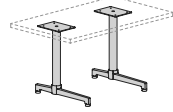
Tilt	Width	Model	List Price
 T-Base Tilt	84"	LK-TBT-TT29-2084	+\$1,017
		LK-TBT-TT29-2484	+\$1,045
		LK-TBT-TT29-3084	+\$1,076
	96"	LK-TBT-TT29-2096	+\$1,073
		LK-TBT-TT29-2496	+\$1,100
		LK-TBT-TT29-3096	+\$1,130

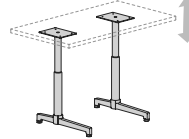
Inline T-Base	Width	Model	List Price
 Inline T-Base	84"	LK-IBT-TT29-2084	+\$1,060
		LK-IBT-TT29-2484	+\$1,060
	96"	LK-IBT-TT29-2096	+\$1,115
		LK-IBT-TT29-2496	+\$1,115

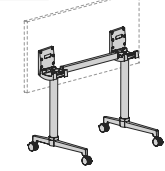


Cantilever T-Bases

(offset column)

Fixed	Width	Model	List Price
 Cantilever T-Base Fixed	84"	LK-CBF-TT29-2084	+\$566
		LK-CBF-TT29-2484	+\$582
		LK-CBF-TT29-3084	+\$607
	96"	LK-CBF-TT29-2096	+\$586
		LK-CBF-TT29-2496	+\$600
		LK-CBF-TT29-3096	+\$627

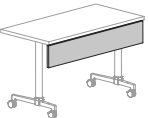
Cantilever T-Base Adj.	Width	Model	List Price
 Cantilever T-Base Adj.	84"	LK-CBA-TT29-2084	+\$678
		LK-CBA-TT29-2484	+\$693
		LK-CBA-TT29-3084	+\$719
	96"	LK-CBA-TT29-2096	+\$697
		LK-CBA-TT29-2496	+\$713
		LK-CBA-TT29-3096	+\$738

Tilt	Width	Model	List Price
 Cantilever T-Base Tilt	84"	LK-CBT-TT29-2084	+\$1,046
		LK-CBT-TT29-2484	+\$1,061
		LK-CBT-TT29-3084	+\$1,088
	96"	LK-CBT-TT29-2096	+\$1,101
		LK-CBT-TT29-2496	+\$1,117
		LK-CBT-TT29-3096	+\$1,142

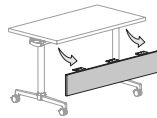
See pages 6-7 for additional information on Lok Bases.

See pages 38-44 on how to order/specify Lok Bases for Rectangular Tops, including caster color options.

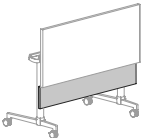
Training Table Modesty Panels

Fixed Modesty	Material	Model	Standard List	Graded In HPL 2	Graded In HPL 3
 Fixed Modesty	Acrylic	LK-MPF-84A	+\$527	--	--
		LK-MPF-96A	+\$576	--	--
	TFL	LK-MPF-84T	+\$213	--	--
		LK-MPF-96T	+\$220	--	--
	HPL	LK-MPF-84H	+\$325	+\$342	+\$458
		LK-MPF-96H	+\$341	+\$362	+\$494

Note: Fixed modesty panels are intended to always be attached to top and should not be specified in conjunction with Tilt T-Bases.

Removable Modesty	Material	Model	Standard List	Graded In HPL 2	Graded In HPL 3
 Removable Modesty	Acrylic	LK-MPR-84A	+\$584	--	--
		LK-MPR-96A	+\$632	--	--
	TFL	LK-MPR-84T	+\$269	--	--
		LK-MPR-96T	+\$276	--	--
	HPL	LK-MPR-84H	+\$381	+\$399	+\$514
		LK-MPR-96H	+\$397	+\$419	+\$551

Note: Removable modesty panels when used with Tilt T-bases must be removed before tilting table.

Hinged Modesty	Material	Model	Standard List	Graded In HPL 2	Graded In HPL 3
 Hinged Modesty	Acrylic	LK-MPH-84A	+\$578	--	--
		LK-MPH-96A	+\$627	--	--
	TFL	LK-MPH-84T	+\$261	--	--
		LK-MPH-96T	+\$269	--	--
	HPL	LK-MPH-84H	+\$373	+\$391	+\$507
		LK-MPH-96H	+\$391	+\$412	+\$544

Note: Hinged modesty panels are intended to be used with Tilt T-Bases for tilting and table nesting. Not to be specified with Fixed T-Bases.

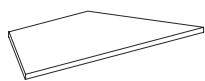
See pages 8-9 for additional information on Lok Modesty Panels.

See pages 64-66 on how to order/specify Lok Modesty Panels.

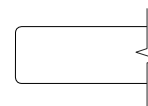
LOK - TRAINING

Description

Trapezoid Training Top



top shape



Eased Edge (R3)

D	W	H	CTN WT	CU FT	❶ Model	TFL	Standard		Graded In	
							HPL 1	HPL 2	HPL 2	HPL 3
24	48	29	35	3	LK-TZ29-2448T	\$364	\$472	\$483	\$565	
30	48	29	43	3	LK-TZ29-3048T	\$383	\$529	\$544	\$645	

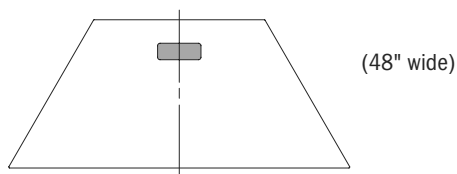
Table Components: (order separately)

- base, modesty panel, electrical, and privacy screens sold and ship separately
- specify power option, see below
- optional set of (2) linking bracket, specify and add an additional \$60 list

Electrical Options/Cutout Locations:

- specify power cutout and indicate if Link or Econo System will be used
- reference drawing below for approximate location

CT1 : Single Power Center Top Cutout Location



To Order Specify

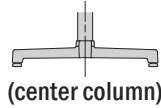
❶ Model #	❷a Laminate Selection	❷b PVC Edge Color	❸ Electrical
Model (LK)	See Laminate Selection	See PVC Edge Color Options	N None L-CT1-CO Link System - Center Top Single Power Cutout E-CT1-CO Econo System - Center Top Single Power Cutout

Model Number Breakdown

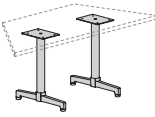
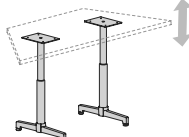
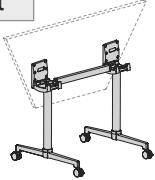
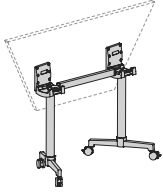
LK-TZ29-2448T					
LK	TZ	29	2448	T	
LOK	Trapezoid Top Shape	Height	24" x 48"	Laminate	

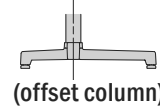
Training Table Bases

Select base preference below to go with corresponding Top. Note: Base depth and width must match Top depth (D) and width (W).

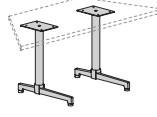
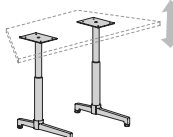
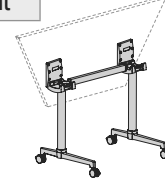


T-Bases

Fixed				
	Width	Model	List Price	
 T-Base Fixed	48"	LK-TBF-TZ29-2448	+\$513	
		LK-TBF-TZ29-3048	+\$545	
Tilt				
	Width	Model	List Price	
 T-Base Adjustable	48"	LK-TBA-TZ29-2448	+\$626	
		LK-TBA-TZ29-3048	+\$656	
Tilt				
	Width	Model	List Price	
 T-Base Tilt	48"	LK-TBT-TZ29-2448	+\$1,000	
		LK-TBT-TZ29-3048	+\$1,033	
Tilt				
	Width	Model	List Price	
 Inline T-Base	48"	LK-IBT-TZ29-2448	+\$892	
		LK-IBT-TZ29-3048	+\$925	



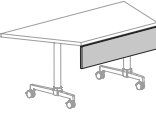
Cantilever T-Bases

Fixed				
	Width	Model	List Price	
 Cantilever T-Base Fixed	48"	LK-CBF-TZ29-2448	+\$515	
		LK-CBF-TZ29-3048	+\$542	
Tilt				
	Width	Model	List Price	
 Cantilever T-Base Adj.	48"	LK-CBA-TZ29-2448	+\$628	
		LK-CBA-TZ29-3048	+\$653	
Tilt				
	Width	Model	List Price	
 Cantilever T-Base Tilt	48"	LK-CBT-TZ29-2448	+\$1,017	
		LK-CBT-TZ29-3048	+\$1,043	

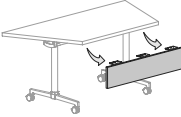
See pages 6-7 for additional information on Lok Bases.

See pages 46-49 on how to order/specify Lok Bases for Trapezoid Tops, including caster color options.


Training Table Modesty Panels

	Material	Model	Standard List	Graded In HPL 2	Graded In HPL 3
 Fixed Modesty	Acrylic	LK-MPF-26A	+\$306	--	--
		LK-MPF-30A	+\$307	--	--
	TFL	LK-MPF-26T	+\$161	--	--
		LK-MPF-30T	+\$163	--	--
	HPL	LK-MPF-26H	+\$239	+\$246	+\$296
		LK-MPF-30H	+\$240	+\$248	+\$297

Note: Fixed modesty panels are intended to always be attached to top and should not be specified in conjunction with Tilt T-Bases.

	Material	Model	Standard List	Graded In HPL 2	Graded In HPL 3
 Removable Modesty	Acrylic	LK-MPR-26A	+\$343	--	--
		LK-MPR-30A	+\$345	--	--
	TFL	LK-MPR-26T	+\$200	--	--
		LK-MPR-30T	+\$201	--	--
	HPL	LK-MPR-26H	+\$276	+\$284	+\$334
		LK-MPR-30H	+\$277	+\$285	+\$335

Note: Removable modesty panels when used with Tilt T-bases must be removed before tilting table.

	Material	Model	Standard List	Graded In HPL 2	Graded In HPL 3
 Hinged Modesty	Acrylic	LK-MPH-26A	+\$326	--	--
		LK-MPH-30A	+\$327	--	--
	TFL	LK-MPH-26T	+\$200	--	--
		LK-MPH-30T	+\$200	--	--
	HPL	LK-MPH-26H	+\$275	+\$283	+\$333
		LK-MPH-30H	+\$276	+\$284	+\$334

Note: Hinged modesty panels are intended to be used with Tilt T-Bases for tilting and table nesting. Not to be specified with Fixed T-Bases.

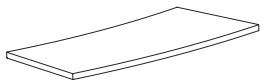
See pages 8-9 for additional information on Lok Modesty Panels.

See pages 64-66 on how to order/specify Lok Modesty Panels.

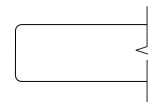
LOK-TRAINING

Description

Lecture Training Top



top shape



Eased Edge (R3)

D	W	H	CTN WT	CU FT	❶ Model	TFL	Standard		Graded In	
							HPL 1	HPL 2	HPL 2	HPL 3
24	48	29	35	3	LK-LC29-2448T	\$371	\$491	\$504	\$592	
30	48	29	43	3	LK-LC29-3048T	\$478	\$549	\$564	\$671	
24	60	29	43	3	LK-LC29-2460T	\$415	\$554	\$569	\$679	
30	60	29	54	4	LK-LC29-3060T	\$546	\$626	\$643	\$778	

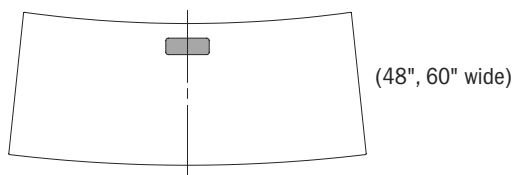
Table Components: (order separately)

- base, modesty panel, electrical, and privacy screens sold and ship separately
- specify power option, see below
- optional set of (2) linking bracket, specify and add an additional \$60 list

Electrical Options/Cutout Locations:

- specify power cutout and indicate if Link or Econo System will be used
- reference drawing below for approximate location

CT1 : Single Power Center Top Cutout Location



LAMINATE

To Order Specify

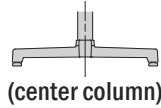
❶ Model #	❷a Laminate Selection	❷b PVC Edge Color	❸ Electrical
Model (LK)	See Laminate Selection	See PVC Edge Color Options	N None L-CT1-CO Link System - Center Top Single Power Cutout E-CT1-CO Econo System - Center Top Single Power Cutout

Model Number Breakdown

LK-LC29-2448T				
LK	LC	29	2448	T
LOK	Lecture Top Shape	Height	24" x 48"	Laminate

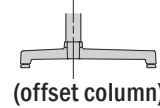
Training Table Bases

Select base preference below to go with corresponding Top. Note: Base depth and width must match Top depth (D) and width (W).



T-Bases

Fixed			
	Width	Model	List Price
 T-Base Fixed	48"	LK-TBF-LC29-2448	+\$528
		LK-TBF-LC29-3048	+\$561
	60"	LK-TBF-LC29-2460	+\$568
		LK-TBF-LC29-3060	+\$600
Adjustable			
	Width	Model	List Price
 T-Base Adjustable	48"	LK-TBA-LC29-2448	+\$640
		LK-TBA-LC29-3048	+\$673
	60"	LK-TBA-LC29-2460	+\$680
		LK-TBA-LC29-3060	+\$713
Tilt			
	Width	Model	List Price
 T-Base Tilt	48"	LK-TBT-LC29-2448	+\$1,015
		LK-TBT-LC29-3048	+\$1,047
	60"	LK-TBT-LC29-2460	+\$1,031
		LK-TBT-LC29-3060	+\$1,061
Inline			
	Width	Model	List Price
 Inline T-Base	48"	LK-IBT-LC29-2448	+\$892
		LK-IBT-LC29-3048	+\$925
	60"	LK-IBT-LC29-2460	+\$1,015
		LK-IBT-LC29-3060	+\$1,047



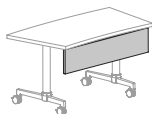
Cantilever T-Bases

Fixed			
	Width	Model	List Price
 Cantilever T-Base Fixed	48"	LK-CBF-LC29-2448	+\$515
		LK-CBF-LC29-3048	+\$556
	60"	LK-CBF-LC29-2460	+\$555
		LK-CBF-LC29-3060	+\$598
Adjustable			
	Width	Model	List Price
 Cantilever T-Base Adj.	48"	LK-CBA-LC29-2448	+\$628
		LK-CBA-LC29-3048	+\$669
	60"	LK-CBA-LC29-2460	+\$668
		LK-CBA-LC29-3060	+\$711
Tilt			
	Width	Model	List Price
 Cantilever T-Base Tilt	48"	LK-CBT-LC29-2448	+\$1,033
		LK-CBT-LC29-3048	+\$1,043
	60"	LK-CBT-LC29-2460	+\$1,017
		LK-CBT-LC29-3060	+\$1,059

See pages 6-7 for additional information on Lok Bases.

See pages 50-53 on how to order/specify Lok Bases for Lecture Tops, including caster color options.

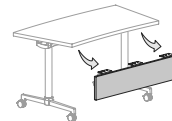
Training Table Modesty Panels



Fixed Modesty

Material	Model	List Price
Acrylic	LK-MPF-48A	+\$346
	LK-MPF-60A	+\$424

Note: Fixed modesty panels are intended to always be attached to top and should not be specified in conjunction with Tilt T-Bases.



Removable Modesty

Material	Model	List Price
Acrylic	LK-MPR-48A	+\$383
	LK-MPR-60A	+\$480

Note: Removable modesty panels when used with Tilt T-bases must be removed before tilting table.

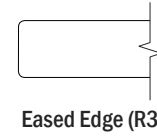
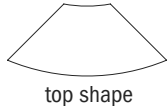
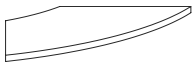
See pages 8-9 for additional information on Lok Modesty Panels.

See pages 64-66 on how to order/specify Lok Modesty Panels.

LOK-TRAINING

Description

Crescent Training Top



LAM

D	W	H	CTN WT	CU FT	❶ Model	TFL	Standard		Graded In	
							HPL 1	HPL 2	HPL 2	HPL 3
24	48	29	35	3	LK-CR29-2448T	\$378	\$511	\$524	\$618	
30	48	29	43	3	LK-CR29-3048T	\$483	\$567	\$583	\$699	

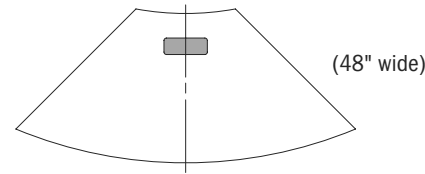
Table Components: (order separately)

- base, electrical, and privacy screens sold and ship separately
- top does not accommodate modesty panel
- specify power option, see below
- optional set of (2) linking bracket, specify and add an additional \$60 list

Electrical Options/Cutout Locations:

- specify power cutout and indicate if Link or Econo System will be used
- reference drawing below for approximate location

CT1 : Single Power Center Top Cutout Location



To Order Specify

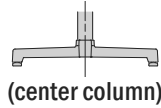
❶ Model #	❷a Laminate Selection	❷b PVC Edge Color	❸ Electrical
Model (LK)	See Laminate Selection	See PVC Edge Color Options	N None L-CT1-CO Link System - Center Top Single Power Cutout E-CT1-CO Econo System - Center Top Single Power Cutout

Model Number Breakdown

LK-CR29-2448T					
LK	CR	29	2448	T	
LOK	Crescent Top Shape	Height	24" x 48"	Laminate	

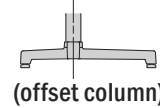
Training Table Bases

Select base preference below to go with corresponding Top. Note: Base depth and width must match Top depth (D) and width (W).



T-Bases

Fixed			
	Width	Model	List Price
 T-Base Fixed	48"	LK-TBF-CR29-2448	+\$513
		LK-TBF-CR29-3048	+\$545
Adjustable			
	Width	Model	List Price
 T-Base Adjustable	48"	LK-TBA-CR29-2448	+\$626
		LK-TBA-CR29-3048	+\$656
Tilt			
	Width	Model	List Price
 T-Base Tilt	48"	LK-TBT-CR29-2448	+\$1,000
		LK-TBT-CR29-3048	+\$1,033
 Inline T-Base	48"	LK-IBT-CR29-2448	+\$892
		LK-IBT-CR29-3048	+\$925



Cantilever T-Bases

Fixed			
	Width	Model	List Price
 Cantilever T-Base Fixed	48"	LK-CBF-CR29-2448	+\$515
		LK-CBF-CR29-3048	+\$542
Adjustable			
	Width	Model	List Price
 Cantilever T-Base Adj.	48"	LK-CBA-CR29-2448	+\$628
		LK-CBA-CR29-3048	+\$653
Tilt			
	Width	Model	List Price
 Cantilever T-Base Tilt	48"	LK-CBT-CR29-2448	+\$1,017
		LK-CBT-CR29-3048	+\$1,043

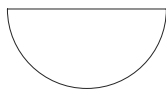
See pages 6-7 for additional information on Lok Bases.

See pages 54-57 on how to order/specify Lok Bases for Crescent Tops, including caster color options.

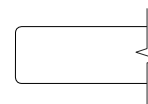
Note: Standard Training Table Modesty Panels are not available for Crescent Top shaped tables

Description

Half Round Training Top



top shape



Eased Edge (R3)

D	W	H	CTN WT	CU FT	❶ Model	TFL	Standard		
							HPL 1	HPL 2	HPL 3
24	48	29	35	3	LK-HR29-2448T	\$373	\$472	\$472	\$483
30	60	29	54	4	LK-HR29-3060T	\$479	\$529	\$529	\$546

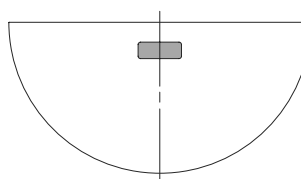
Table Components: (order separately)

- base, modesty panel, electrical, and privacy screens sold and ship separately
- specify power option or power jumper, see below
- optional set of (2) linking bracket, specify and add an additional \$60 list

Electrical Options/Cutout Locations:

- specify power cutout and indicate if Link or Econo System will be used
- reference drawing below for approximate location

CT1 : Single Power Center Top Cutout Location



(48"- 60" wide)

To Order Specify

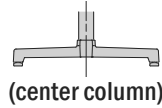
❶ Model #	❷a Laminate Selection	❷b PVC Edge Color	❸ Electrical
Model (LK)	See Laminate Selection	See PVC Edge Color Options	N None L-CT1-CO Link System - Center Top Single Power Cutout E-CT1-CO Econo System - Center Top Single Power Cutout

Model Number Breakdown

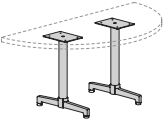
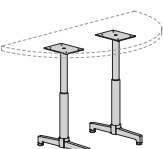
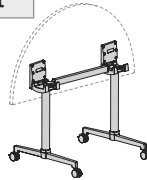
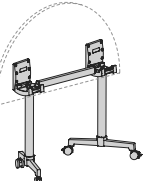
LK-HR29-2448T					
LK	HR	29	2448	T	
LOK	Half Round Top Shape	Height	24" x 48"	Laminate	

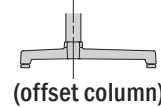
Training Table Bases

Select base preference below to go with corresponding Top. Note: Base depth and width must match Top depth (D) and width (W).

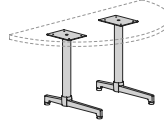
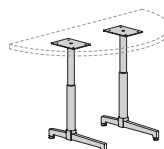
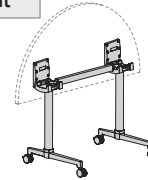


T-Bases
(center column)

Fixed		Width	Model	List Price
	T-Base Fixed	48"	LK-TBF-HR29-2448	+\$513
		60"	LK-TBF-HR29-3060	+\$600
	T-Base Adjustable	48"	LK-TBA-HR29-2448	+\$626
		60"	LK-TBA-HR29-3060	+\$713
	T-Base Tilt	48"	LK-TBT-HR29-2448	+\$892
		60"	LK-TBT-HR29-3060	+\$1,047
	Inline T-Base	48"	LK-IBT-HR29-2448	+\$892
		60"	LK-IBT-HR29-3060	+\$1,047



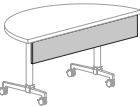
Cantilever T-Bases
(offset column)

Fixed		Width	Model	List Price
	Cantilever T-Base Fixed	48"	LK-CBF-HR29-2448	+\$501
		60"	LK-CBF-HR29-3060	+\$598
	Cantilever T-Base Adj.	48"	LK-CBA-HR29-2448	+\$612
		60"	LK-CBA-HR29-3060	+\$711
	Cantilever T-Base Tilt	48"	LK-CBT-HR29-2448	+\$894
		60"	LK-CBT-HR29-3060	+\$1,043

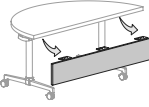
See pages 6-7 for additional information on Lok Bases.

See pages 58-61 on how to order/specify Lok Bases for Half Round Tops, including caster color options.


Training Table Modesty Panels

	Material	Model	Standard List	Graded In HPL 2	Graded In HPL 3
Fixed Modesty	Acrylic	LK-MPF-48A	+\$346	--	--
		LK-MPF-60A	+\$424	--	--
	TFL	LK-MPF-48T	+\$174	--	--
		LK-MPF-60T	+\$196	--	--
	HPL	LK-MPF-48H	+\$257	+\$268	+\$334
		LK-MPF-60H	+\$290	+\$303	+\$384

Note: Fixed modesty panels are intended to always be attached to top and should not be specified in conjunction with Tilt T-Bases.

	Material	Model	Standard List	Graded In HPL 2	Graded In HPL 3
Removable Modesty	Acrylic	LK-MPR-48A	+\$383	--	--
		LK-MPR-60A	+\$480	--	--
	TFL	LK-MPR-48T	+\$211	--	--
		LK-MPR-60T	+\$253	--	--
	HPL	LK-MPR-48H	+\$295	+\$306	+\$372
		LK-MPR-60H	+\$346	+\$358	+\$441

Note: Removable modesty panels when used with Tilt T-bases must be removed before tilting table.

	Material	Model	Standard List	Graded In HPL 2	Graded In HPL 3
Hinged Modesty	Acrylic	LK-MPH-48A	+\$380	--	--
		LK-MPH-60A	+\$475	--	--
	TFL	LK-MPH-48T	+\$210	--	--
		LK-MPH-60T	+\$244	--	--
	HPL	LK-MPH-48H	+\$294	+\$305	+\$371
		LK-MPH-60H	+\$338	+\$351	+\$434

Note: Hinged modesty panels are intended to be used with Tilt T-Bases for tilting and table nesting. Not to be specified with Fixed T-Bases.

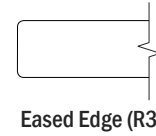
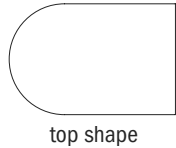
See pages 8-9 for additional information on Lok Modesty Panels.

See pages 64-66 on how to order/specify Lok Modesty Panels.

LOK-TRAINING

Description

Bullet Training Top



D	W	H	CTN WT	CU FT	❶ Model	TFL	Standard		
							HPL 1	HPL 2	HPL 3
30	60	29	54	4	LK-BU29-3060T	\$415	\$554	\$569	\$679
36	60	29	61	5	LK-BU29-3660T	\$555	\$649	\$701	\$886
30	66	29	58	4	LK-BU29-3066T	\$453	\$593	\$618	\$751
36	66	29	67	5	LK-BU29-3666T	\$579	\$676	\$729	\$922
30	72	29	61	5	LK-BU29-3072T	\$486	\$623	\$667	\$817
36	72	29	73	6	LK-BU29-3672T	\$637	\$750	\$787	\$995
48	72	29	96	7	LK-BU29-4872T	\$725	\$847	\$915	\$1,157

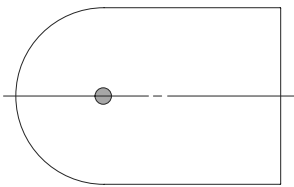
LOK - TRAINING LAMINATE

Table Components: (order separately)

- base, electrical, and privacy screens sold and ship separately
- optional set of (2) ganging bracket, specify and add an additional \$60 list
- specify power option, see below for options

Electrical Options/Cutout Locations:

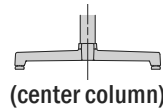
- specify power cutout
- reference drawing below for approximate location



(60"- 72" wide)

Select base preference below to go with corresponding Top.

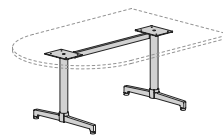
Note: Base depth and width must match Top depth (D) and width (W).



T-Bases

Width	Model	List Price
60"	LK-TBF-BU29-3060	+\$600
	LK-TBF-BU29-3660	+\$636
66"	LK-TBF-BU29-3066	+\$600
	LK-TBF-BU29-3666	+\$636
72"	LK-TBF-BU29-3072	+\$611
	LK-TBF-BU29-3672	+\$647
	LK-TBF-BU29-4872	+\$636

Fixed



See intro page 6 for additional information on Lok Bases, including base color options.

See pricing page 62 on how to order/specify Lok Bases for Bullet Tops, including caster color options.

To Order Specify

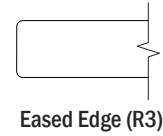
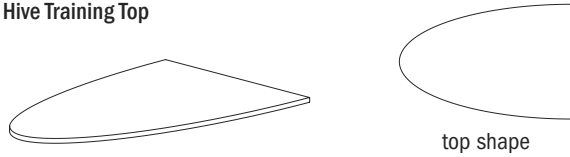
❶ Model #	❷a Laminate Selection	❷b PVC Edge Color	❸ Electrical
Model (LK)	See Laminate Selection	See PVC Edge Color Options	N None CTEC23-CO Electrical Cutout for EC23 CTEC24-CO Electrical Cutout for EC24

Model Number Breakdown

LK-BU29-3060T				
LK	BU	29	3060	T
LOK	Bullet Top Shape	Height	30" x 60"	Laminate

Description

Hive Training Top



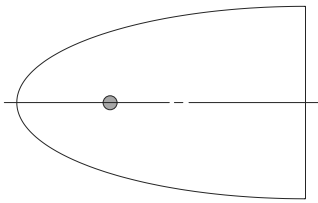
LAMINATE	W	D	H	CTN WT	CU FT	1 Model	TFL	Standard		
								HPL 1	HPL 2	HPL 3
	30	60	29	54	4	LK-HV29-3060T	\$417	\$556	\$571	\$681
	36	60	29	61	5	LK-HV29-3660T	\$557	\$651	\$703	\$888
	30	66	29	58	4	LK-HV29-3066T	\$455	\$595	\$620	\$754
	36	66	29	67	5	LK-HV29-3666T	\$582	\$678	\$732	\$925
	30	72	29	61	5	LK-HV29-3072T	\$488	\$626	\$669	\$819
	36	72	29	73	6	LK-HV29-3672T	\$639	\$753	\$789	\$997
	48	72	29	96	7	LK-HV29-4872T	\$728	\$850	\$918	\$1,161

Table Components: (order separately)

- base, electrical, and privacy screens sold and ship separately
- optional set of (2) ganging bracket, specify and add an additional \$60 list
- specify power option, see below for options

Electrical Options/Cutout Locations:

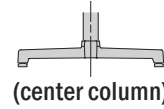
- specify power cutout
- reference drawing below for approximate location



(60"- 72" wide)

Select base preference below to go with corresponding Top.

Note: Base depth and width must match Top depth (D) and width (W).



(center column)

T-Bases

Width	Model	List Price
60"	LK-TBF-HV29-3060	+\$600
	LK-TBF-HV29-3660	+\$636
66"	LK-TBF-HV29-3066	+\$600
	LK-TBF-HV29-3666	+\$636
72"	LK-TBF-HV29-3072	+\$611
	LK-TBF-HV29-3672	+\$636
	LK-TBF-HV29-4872	+\$636

See page 6 for additional information on Lok Bases.

See page 62 on how to order/specify Lok Bases for Hive Tops, including caster color options.

To Order Specify

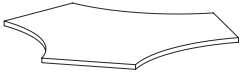
1 Model #	2a Laminate Selection	2b PVC Edge Color	3 Electrical
Model (LK)	See Laminate Selection	See PVC Edge Color Options	N None CTEC23-CO Electrical Cutout for EC23 CTEC24-CO Electrical Cutout for EC24

Model Number Breakdown

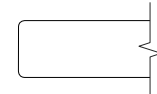
LK-HV29-3060T					
LK	HV	29	3060	T	
LOK	Hive Top Shape	Height	30" x 60"	Laminate	

Description

Intersect Training Top



top shape



Eased Edge (R3)

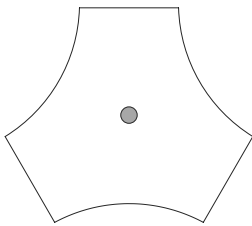
D	W	H	CTN WT	CU FT	❶ Model	TFL	Standard		Graded In	
							HPL 1	HPL 2	HPL 2	HPL 3
24	60	29	88	7	LK-IN29-2460T	\$606	\$877	\$950	\$1,199	
30	60	29	96	7	LK-IN29-3060T	\$610	\$881	\$953	\$1,203	

Table Components: (order separately)

- base, electrical, and privacy screens sold and ship separately
- specify power option, see below
- optional set of (2) linking bracket, specify and add an additional \$60 list

Electrical Options/Cutout Locations:

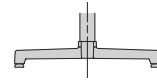
- specify power cutout
- reference drawing below for approximate location



(60" wide)

Select base preference below to go with corresponding Top.

Note: Base depth and width must match Top depth (D) and width (W).



(center column)

Fixed

T-Bases

Width	T-Bases	
	Model	List Price
60"	LK-TBF-IN29-2460	+\$765
	LK-TBF-IN29-3060	+\$765

T-Base Fixed

See intro page 6 for additional information on Lok Bases, including base color options.

See pricing page 63 on how to order/specify Lok Bases for Intersect Tops, including caster color options.

To Order Specify

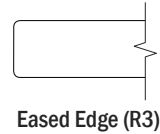
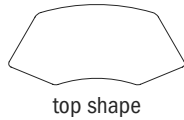
❶ Model #	❷a Laminate Selection	❷b PVC Edge Color	❸ Electrical
Model (LK)	See Laminate Selection	See PVC Edge Color Options	N None CTEC23-CO Electrical Cutout for EC23 CTEC24-CO Electrical Cutout for EC24

Model Number Breakdown

LK-IN29-2460T				
LK	IN	29	2460	T
LOK	Intersect Top Shape	Height	24" x 60"	Laminate

Description

Huddle Training Top



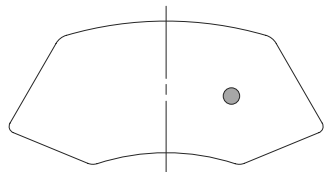
W	D	H	CTN WT	CU FT	Model	TFL	Standard		
							HPL 1	HPL 2	HPL 3
30	72	29	65	5	LK-HU29-3072T	\$486	\$623	\$667	\$817
36	84	29	91	6	LK-HU29-3684T	\$707	\$775	\$835	\$1,047

Table Components: (order separately)

- base and electrical sold and ship separately
- specify power option, see below
- optional set of (2) linking bracket, specify and add an additional \$60 list

Electrical Options/Cutout Locations:

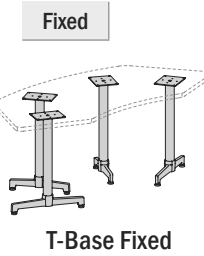
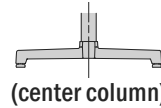
- specify power cutout and indicate if Link or Econo System will be used
- reference drawing below for approximate location



(72"- 84" wide)

Select base preference below to go with corresponding Top.

Note: Base depth and width must match Top depth (D) and width (W).



Fixed

T-Bases

Width	Model	List Price
72"	LK-TBF-HU29-3072	+\$998
84"	LK-TBF-HU29-3684	+\$998

See page 6 for additional information on Lok Bases.

See page 63 on how to order/specify Lok Bases for Huddle Tops, including caster color options.

To Order Specify

1 Model #	2a Laminate Selection	2b PVC Edge Color	3 Electrical
Model (LK)	See Laminate Selection	See PVC Edge Color Options	N None CTEC23-CO Electrical Cutout for EC23 CTEC24-CO Electrical Cutout for EC24

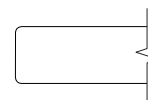
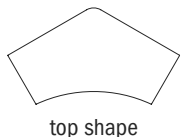
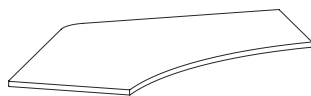
Model Number Breakdown

LK-HU29-3072T					
LK	HU	29	3072	T	
LOK	Huddle Top Shape	Height	30" x 72"	Laminate	

LOK-TRAINING

Description

One-twenty Training Top



Eased Edge (R3)

D	W	H	CTN WT	CU FT	❶ Model	TFL	Standard		
							HPL 1	HPL 2	HPL 3
42	72	29	81	6	LK-YG29-4272T	\$704	\$777	\$839	\$1,053
45	84	29	95	8	LK-YG29-4584T	\$732	\$896	\$972	\$1,235

Table Components: (order separately)

- base, modesty panel, electrical, and privacy screens sold and ship separately
- specify power option, see below

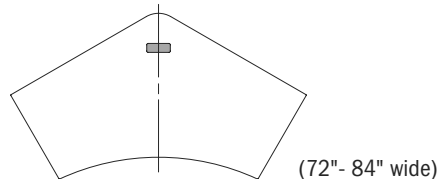
Options:

- optional set of (2) linking bracket, specify and add an additional \$60 list

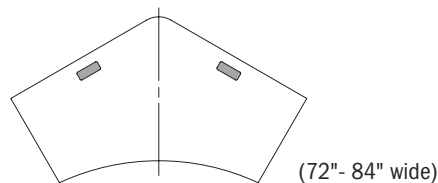
Electrical Options/Cutout Locations:

- specify power cutout and indicate if Link or Econo System will be used
- reference drawing below for approximate location

CT1 : Single Power Center Top



LRT2 : Dual Power Left/Right Top



To Order Specify

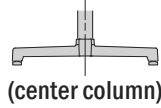
❶ Model #	❷a Laminate Selection	❷b PVC Edge Color	❸ Electrical
Model (LK)	See Laminate Selection	See PVC Edge Color Options	N None L-CT1-CO Link System - Center Top Single Power Cutout E-CT1-CO Econo System - Center Top Single Power Cutout L-LRT2-CO Link System - Left/Right Top Dual Power Cutout E-LRT2-CO Econo System - Left/Right Top Dual Power Cutout

Model Number Breakdown

LK-YG29-4272T					
LK	YG	29	4272	T	
LOK	One-twenty Top Shape	Height	42" x 72"	Laminate	

Training Table Bases

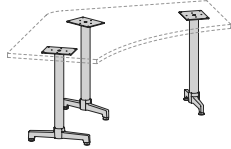
Select base preference below to go with corresponding Top. Note: Base depth and width must match Top depth (D) and width (W).



T-Bases

(center column)

Fixed



T-Base Fixed

Width	Model	List Price
72"	LK-TBF-YG29-4272	+\$725
84"	LK-TBF-YG29-4584	+\$725

LOK - TRAINING

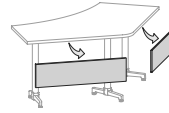
Training Table Modesty Panels



Fixed Modesty

Material	Model	Standard List	Graded In HPL 2	Graded In HPL 3
Acrylic	LK-MPF-36A	+\$309	--	--
	LK-MPF-42A	+\$343	--	--
TFL	LK-MPF-36T	+\$166	--	--
	LK-MPF-42T	+\$171	--	--
HPL	LK-MPF-36H	+\$242	+\$251	+\$300
	LK-MPF-42H	+\$255	+\$266	+\$332

Note: Fixed modesty panels are intended to always be attached to top and should not be specified in conjunction with Tilt T-Bases.



Removable Modesty

Material	Model	Standard List	Graded In HPL 2	Graded In HPL 3
Acrylic	LK-MPR-36A	+\$347	--	--
	LK-MPR-42A	+\$380	--	--
TFL	LK-MPR-36T	+\$203	--	--
	LK-MPR-42T	+\$209	--	--
HPL	LK-MPR-36H	+\$279	+\$289	+\$338
	LK-MPR-42H	+\$293	+\$304	+\$369

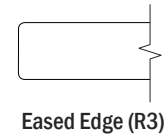
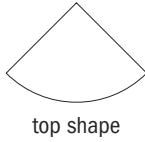
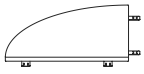
Note: Removable modesty panels when used with Tilt T-bases must be removed before tilting table.

See pages 8-9 for additional information on Lok Modesty Panels.

See pages 64-66 on how to order/specify Lok Modesty Panels.

Description

Quarter Round Training Top



Eased Edge (R3)

D	W	H	CTN WT	CU FT	❶ Model	TFL	Standard		
							Graded In		
							HPL 1	HPL 2	HPL 3
24			15	2	LK-Q90-24T	\$306	\$368	\$373	\$415
30			22	2	LK-Q90-30T	\$328	\$431	\$439	\$503

Features:

- electrical sold and ship separately
- base not required; flat plates included - use for attachment between two tables

Options:

- power continued from adjacent tables with jumper; specify no (PJN) or yes Link(PJY-L) -add \$112 list or Econo(PJY-E) -add \$125 list

LAM
LOK - TRAINING

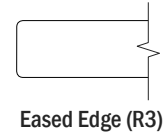
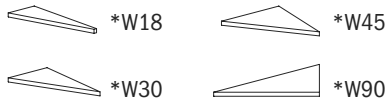
To Order Specify

❶ Model #	❷a Laminate Selection	❷b PVC Edge Color	❸ Electrical
Model (LK)	See Laminate Selection	See PVC Edge Color Options	PJY-L LINK System Jumper PJY-E ECONO System Jumper

Model Number Breakdown

LK-Q90-24T				
LK	Q	90	24	T
LOK	Quarter Round Top Shape	90° Quarter Round	24" Depth	Laminate

Wedge LinkTraining Top



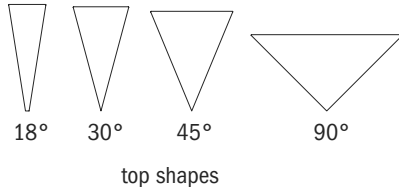
LAMINATE	D	W	H	CTN WT	CU FT	① Model	TFL	Standard		
								HPL 1	HPL 2	HPL 3
	24			6	1	LK-W18-24T	\$224	\$276	\$278	\$295
	30			7	1	LK-W18-30T	\$236	\$300	\$303	\$327
	24			7	1	LK-W30-24T	\$240	\$295	\$298	\$320
	30			9	1	LK-W30-30T	\$263	\$330	\$333	\$368
	24			9	1	LK-W45-24T	\$258	\$325	\$328	\$360
	30			11	2	LK-W45-30T	\$294	\$371	\$377	\$426
	24			13	2	LK-W90-24T	\$284	\$350	\$354	\$395
	30			17	2	LK-W90-30T	\$308	\$413	\$420	\$483

Features:

- electrical sold and ship separately
- base not required; flat plates included - use for attachment between two tables

Options:

- power continued from adjacent tables with jumper; specify no (PJN) or yes Link(PJY-L) -add \$112 list or Econo(PJY-E) -add \$125 list



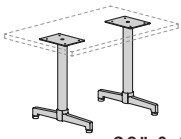
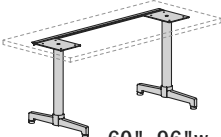
To Order Specify

① Model #	②a Laminate Selection	②b PVC Edge Color	③ Electrical
Model (LK)	See Laminate Selection	See PVC Edge Color Options	PJY-L LINK System Jumper PJY-E ECONO System Jumper

Model Number Breakdown

LK-W18-24T					
LK	W	18	24	T	
LOK	Wedge Top Shape	18° Wedge	24" Depth	Laminate	

LOK - TRAINING

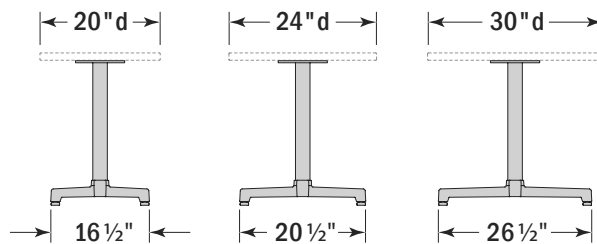
Description	D	W	H	CTN WT	CU FT	1 Model	List Price
Fixed T Base for Rectangular Top	20	36	29	22	4	LK-TBF-TT29-2036	\$486
	24	36	29	23	5	LK-TBF-TT29-2436	\$513
	30	36	29	24	7	LK-TBF-TT29-3036	\$545
 36" & 48" w	20	48	29	22	4	LK-TBF-TT29-2048	\$486
	24	48	29	23	5	LK-TBF-TT29-2448	\$513
	30	48	29	24	7	LK-TBF-TT29-3048	\$545
 60" - 96" w includes a metal support rail	20	60	29	26	5	LK-TBF-TT29-2060	\$543
	24	60	29	27	6	LK-TBF-TT29-2460	\$568
	30	60	29	28	8	LK-TBF-TT29-3060	\$600
	20	66	29	26	5	LK-TBF-TT29-2066	\$543
	24	66	29	27	6	LK-TBF-TT29-2466	\$568
	30	66	29	28	8	LK-TBF-TT29-3066	\$600
	20	72	29	27	5	LK-TBF-TT29-2072	\$552
	24	72	29	28	6	LK-TBF-TT29-2472	\$579
	30	72	29	29	8	LK-TBF-TT29-3072	\$611
	20	84	29	27	5	LK-TBF-TT29-2084	\$552
	24	84	29	28	6	LK-TBF-TT29-2484	\$579
	30	84	29	29	8	LK-TBF-TT29-3084	\$611
	20	96	29	28	6	LK-TBF-TT29-2096	\$570
	24	96	29	29	7	LK-TBF-TT29-2496	\$598
	30	96	29	30	9	LK-TBF-TT29-3096	\$630

Features:

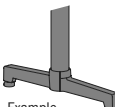
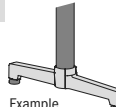
- bases include all necessary field assembly hardware

Options:

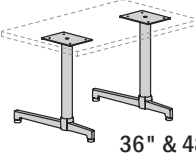
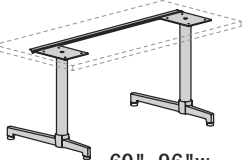
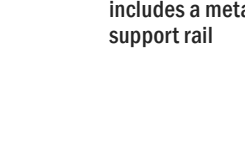



- specify Glide (G) or Caster(C) -choice of Black(BL) or White/Grey (WG) Caster; add \$41 list for casters
- specify metal finish, see below for options and two-tone capabilities



To Order Specify

1 Model #	2 Feet & Post Finish	Dual Finish	3 Glides or Casters
Lok (LK)	See Feet & Post Finish Options 	2a Feet Finish See Feet Finish Options 2b Post Finish See Post Finish Options 	G Glides Standard (no upcharge) C Casters - BL Black +\$40 - WG White w/Grey Wheels +\$40

LK-TBF-TT29-3072					
LK	TBF	TT	29	3072	
LOK	T-Base Fixed	Rectangular Top Shape	Height	Used on 30" x 72" Tops	

Description	D	W	H	CTN WT	CU FT	① Model	List Price
Cantilever Fixed T-Base for Rectangular Top	20	36	29	22	4	LK-CBF-TT29-2036	\$501
	24	36	29	23	5	LK-CBF-TT29-2436	\$515
	30	36	29	24	7	LK-CBF-TT29-3036	\$542
 36" & 48" w	20	48	29	22	4	LK-CBF-TT29-2048	\$501
	24	48	29	23	5	LK-CBF-TT29-2448	\$515
	30	48	29	24	7	LK-CBF-TT29-3048	\$542
 60" - 96" w includes a metal support rail	20	60	29	26	5	LK-CBF-TT29-2060	\$555
	24	60	29	27	6	LK-CBF-TT29-2460	\$570
	30	60	29	28	8	LK-CBF-TT29-3060	\$598
 66" - 96" w includes a metal support rail	20	66	29	26	5	LK-CBF-TT29-2066	\$555
	24	66	29	27	6	LK-CBF-TT29-2466	\$570
	30	66	29	28	8	LK-CBF-TT29-3066	\$598
 72" - 96" w includes a metal support rail	20	72	29	27	5	LK-CBF-TT29-2072	\$566
	24	72	29	28	6	LK-CBF-TT29-2472	\$582
	30	72	29	29	8	LK-CBF-TT29-3072	\$607
 84" - 96" w includes a metal support rail	20	84	29	27	5	LK-CBF-TT29-2084	\$566
	24	84	29	28	6	LK-CBF-TT29-2484	\$582
	30	84	29	29	8	LK-CBF-TT29-3084	\$607
 96" - 96" w includes a metal support rail	20	96	29	28	6	LK-CBF-TT29-2096	\$586
	24	96	29	29	7	LK-CBF-TT29-2496	\$600
	30	96	29	30	9	LK-CBF-TT29-3096	\$627

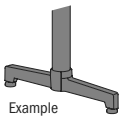
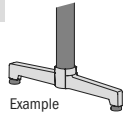


Features:

- bases include all necessary field assembly hardware

Options:

- specify metal finish, see below for options and two-tone capabilities
- specify Glide (G) or Caster(C) -choice of Black(BL) or White/Grey (WG) Caster; add \$41 list for casters

To Order Specify

① Model #	② Feet & Post Finish	Dual Finish	③ Glides or Casters
Lok (LK)	See Feet & Post Finish Options  Example	2a Feet Finish See Feet Finish Options 2b Post Finish See Post Finish Options  Example	G Glides Standard (no upcharge)  C Casters - BL Black +\$40 - WG White w/Grey Wheels +\$40 

LK-CBF-TT29-3072					
LK	CBF	TT	29	3072	
LOK	Cantilever T-Base Fixed	Rectangular Top Shape	Height	Used on 30" x 72" Tops	

LOK - TRAINING

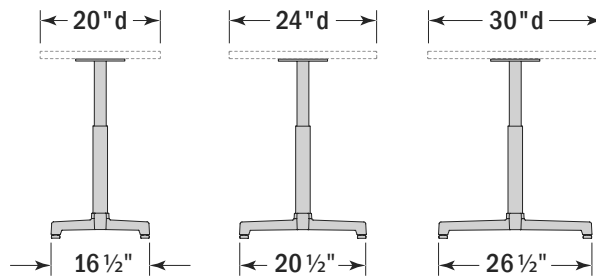
Description	D	W	H	CTN WT	CU FT	1 Model	List Price
	20	36	29	22	4	LK-TBA-TT29-2036	\$598
	24	36	29	23	5	LK-TBA-TT29-2436	\$626
	30	36	29	24	7	LK-TBA-TT29-3036	\$656
	20	48	29	22	4	LK-TBA-TT29-2048	\$598
	24	48	29	23	5	LK-TBA-TT29-2448	\$626
	30	48	29	24	7	LK-TBA-TT29-3048	\$656
	20	60	29	26	5	LK-TBA-TT29-2060	\$654
	24	60	29	27	6	LK-TBA-TT29-2460	\$680
	30	60	29	28	8	LK-TBA-TT29-3060	\$713
	20	66	29	26	5	LK-TBA-TT29-2066	\$654
	24	66	29	27	6	LK-TBA-TT29-2466	\$680
	30	66	29	28	8	LK-TBA-TT29-3066	\$713
	20	72	29	27	5	LK-TBA-TT29-2072	\$664
	24	72	29	28	6	LK-TBA-TT29-2472	\$691
	30	72	29	29	8	LK-TBA-TT29-3072	\$723
	20	84	29	27	5	LK-TBA-TT29-2084	\$664
	24	84	29	28	6	LK-TBA-TT29-2484	\$691
	30	84	29	29	8	LK-TBA-TT29-3084	\$723
20	96	29	28	6	LK-TBA-TT29-2096	\$682	
24	96	29	29	7	LK-TBA-TT29-2496	\$711	
30	96	29	30	9	LK-TBA-TT29-3096	\$742	

Features:

- pin adjustment base provides range of 26"-34"
- bases include all necessary field assembly hardware

Options:

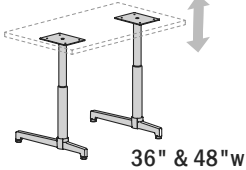
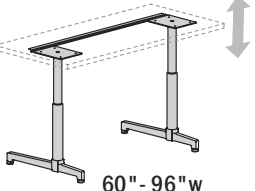
- specify metal finish, see below for options and two-tone capabilities



To Order Specify

1 Model #	2 Feet & Post Finish	Dual Finish		G Glides
Lok (LK)	See Feet & Post Finish Options 	2a Feet Finish See Feet Finish Options	2b Post Finish See Post Finish Options 	 Standard (no upcharge)

LK-TBA-TT29-3072				
LK	TBA	TT	29	3072
LOK	T-Base Adjustable	Rectangular Top Shape	Height	Used on 30" x 72" Tops

Description	D	W	H	CTN WT	CU FT	1 Model	List Price
 <p>36" & 48" w</p>	20	36	29	22	4	LK-CBA-TT29-2036	\$612
	24	36	29	23	5	LK-CBA-TT29-2436	\$628
	30	36	29	24	7	LK-CBA-TT29-3036	\$653
	20	48	29	22	4	LK-CBA-TT29-2048	\$612
	24	48	29	23	5	LK-CBA-TT29-2448	\$628
	30	48	29	24	7	LK-CBA-TT29-3048	\$653
 <p>60" - 96" w includes a metal support rail</p>	20	60	29	26	5	LK-CBA-TT29-2060	\$668
	24	60	29	27	6	LK-CBA-TT29-2460	\$682
	30	60	29	28	8	LK-CBA-TT29-3060	\$711
	20	66	29	26	5	LK-CBA-TT29-2066	\$668
	24	66	29	27	6	LK-CBA-TT29-2466	\$682
	30	66	29	28	8	LK-CBA-TT29-3066	\$711
	20	72	29	27	5	LK-CBA-TT29-2072	\$678
	24	72	29	28	6	LK-CBA-TT29-2472	\$693
	30	72	29	29	8	LK-CBA-TT29-3072	\$719
	20	84	29	27	5	LK-CBA-TT29-2084	\$678
	24	84	29	28	6	LK-CBA-TT29-2484	\$693
	30	84	29	29	8	LK-CBA-TT29-3084	\$719
	20	96	29	28	6	LK-CBA-TT29-2096	\$697
	24	96	29	29	7	LK-CBA-TT29-2496	\$713
	30	96	29	30	9	LK-CBA-TT29-3096	\$738

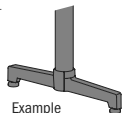
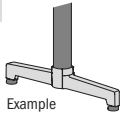

Features:

- pin adjustment base provides range of 26"-34"
- bases include all necessary field assembly hardware

Options:

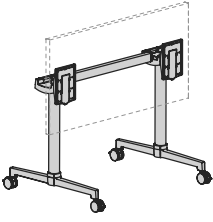
- specify metal finish, see below for options and two-tone capabilities

To Order Specify

1 Model #	2 Feet & Post Finish	Dual Finish		G Glides
Lok (LK)	See Feet & Post Finish Options  <p>Example</p>	2a Feet Finish See Feet Finish Options	2b Post Finish See Post Finish Options  <p>Example</p>	 Standard (no upcharge)

LK-CBA-TT29-3072					
LK	CBA	TT	29	3072	
LOK	Cantilever T-Base Adjustable	Rectangular Top Shape	Height	Used on 30" x 72" Tops	

LOK - TRAINING

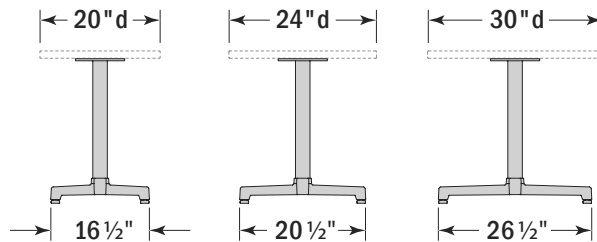
Description	D	W	H	CTN WT	CU FT	1 Model	List Price
	20	36	29	27	5	LK-TBT-TT29-2036	\$850
	24	36	29	28	6	LK-TBT-TT29-2436	\$877
	30	36	29	28	8	LK-TBT-TT29-3036	\$910
	20	48	29	28	6	LK-TBT-TT29-2048	\$973
	24	48	29	29	7	LK-TBT-TT29-2448	\$1,000
	30	48	29	30	9	LK-TBT-TT29-3048	\$1,033
	20	60	29	29	6	LK-TBT-TT29-2060	\$989
	24	60	29	30	7	LK-TBT-TT29-2460	\$1,015
	30	60	29	31	9	LK-TBT-TT29-3060	\$1,046
	20	66	29	31	9	LK-TBT-TT29-2066	\$989
	24	66	29	30	7	LK-TBT-TT29-2466	\$1,015
	30	66	29	29	6	LK-TBT-TT29-3066	\$1,046
	20	72	29	30	6	LK-TBT-TT29-2072	\$1,017
	24	72	29	31	7	LK-TBT-TT29-2472	\$1,045
	30	72	29	32	9	LK-TBT-TT29-3072	\$1,076
	20	84	29	30	6	LK-TBT-TT29-2084	\$1,017
	24	84	29	31	7	LK-TBT-TT29-2484	\$1,045
	30	84	29	32	9	LK-TBT-TT29-3084	\$1,076
	20	96	29	32	6	LK-TBT-TT29-2096	\$1,073
	24	96	29	32	7	LK-TBT-TT29-2496	\$1,100
30	96	29	33	9	LK-TBT-TT29-3096	\$1,130	

Features:

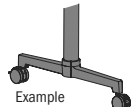
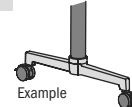

- base nests in offset position when top is tilted
- bases include all necessary field assembly hardware

Options:

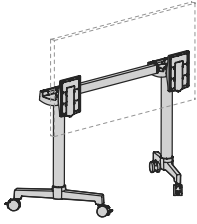
- specify Black (BL) or White/Grey (WG) Caster
- specify metal finish, see below for options and two-tone capabilities



To Order Specify

1 Model #	2 Feet & Post Finish	Dual Finish		3 Casters
Lok (LK)	See Feet & Post Finish Options 	2a Feet Finish See Feet Finish Options	2b Post Finish See Post Finish Options 	C Casters - Standard (no upcharge) - BL Black - WG White w/Grey Wheels 

LK-TBT-TT29-3072				
LK	TBT	TT	29	3072
LOK	T-Base Tilt	Rectangular Top Shape	Height	Used on 30" x 72" Tops

Description	D	W	H	CTN WT	CU FT	1 Model	List Price
Inline Tilt T-Base for Rectangular Top 	20	48	29	28	6	LK-IBT-TT29-2048	\$892
	24	48	29	28	6	LK-IBT-TT29-2448	\$892
	20	60	29	29	7	LK-IBT-TT29-2060	\$1,015
	24	60	29	29	7	LK-IBT-TT29-2460	\$1,015
	20	66	29	29	7	LK-IBT-TT29-2066	\$1,015
	24	66	29	29	7	LK-IBT-TT29-2466	\$1,015
	20	72	29	30	7	LK-IBT-TT29-2072	\$1,031
	24	72	29	30	7	LK-IBT-TT29-2472	\$1,031
	20	84	29	31	7	LK-IBT-TT29-2084	\$1,060
	24	84	29	31	7	LK-IBT-TT29-2484	\$1,060
	20	96	29	32	7	LK-IBT-TT29-2096	\$1,115
	24	96	29	32	7	LK-IBT-TT29-2496	\$1,115

Features:

- base nests in inline position when top is tilted
- bases include all necessary field assembly hardware

Options:

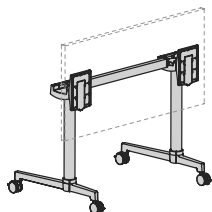
- specify Black (BL) or White/Grey (WG) Caster
- specify metal finish, see below for options and two-tone capabilities

LOK - TRAINING

To Order Specify

1 Model #	2 Feet & Post Finish	Dual Finish		3 Casters
Lok (LK)	See Feet & Post Finish Options  Example	2a Feet Finish See Feet Finish Options	2b Post Finish See Post Finish Options  Example	C Casters - Standard (no upcharge) - BL Black - WG White w/ Grey Wheels 
LK-IBT-TT29-3072				
LK	IBT	TT	29	3072
LOK	Inline T-Base Tilt	Rectangular Top Shape	Height	Used on 30" x 72" Tops

Description	D	W	H	CTN WT	CU FT	1 Model	List Price
Cantilever Tilt T-Base for Rectangular Top	20	36	29	27	5	LK-CBT-TT29-2036	\$879
	24	36	29	28	6	LK-CBT-TT29-2436	\$894
	30	36	29	28	8	LK-CBT-TT29-3036	\$921
	20	48	29	28	6	LK-CBT-TT29-2048	\$1,002
	24	48	29	29	7	LK-CBT-TT29-2448	\$1,017
	30	48	29	30	9	LK-CBT-TT29-3048	\$1,043
	20	60	29	29	6	LK-CBT-TT29-2060	\$1,016
	24	60	29	30	7	LK-CBT-TT29-2460	\$1,033
	30	60	29	31	9	LK-CBT-TT29-3060	\$1,059
	20	66	29	29	6	LK-CBT-TT29-2066	\$1,016
	24	66	29	30	7	LK-CBT-TT29-2466	\$1,033
	30	66	29	31	9	LK-CBT-TT29-3066	\$1,059
	20	72	29	30	6	LK-CBT-TT29-2072	\$1,046
	24	72	29	31	7	LK-CBT-TT29-2472	\$1,061
	30	72	29	32	9	LK-CBT-TT29-3072	\$1,088
	20	84	29	30	6	LK-CBT-TT29-2084	\$1,046
	24	84	29	31	7	LK-CBT-TT29-2484	\$1,061
	30	84	29	32	9	LK-CBT-TT29-3084	\$1,088
	20	96	29	32	6	LK-CBT-TT29-2096	\$1,101
	24	96	29	32	7	LK-CBT-TT29-2496	\$1,117
	30	96	29	33	9	LK-CBT-TT29-3096	\$1,142



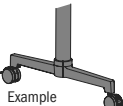
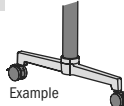

Features:

- base nests in offset position when top is tilted
- bases include all necessary field assembly hardware

Options:

- specify Black (BL) or White/Grey (WG) Caster
- specify metal finish, see below for options and two-tone capabilities

To Order Specify

1 Model #	2 Feet & Post Finish	Dual Finish		3 Casters
Lok (LK)	See Feet & Post Finish Options 	2a Feet Finish See Feet Finish Options	2b Post Finish See Post Finish Options 	C Casters - Standard (no upcharge) - BL Black - WG White w/Grey Wheels 

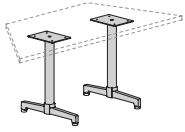
LK-CBT-TT29-3072				
LK	CBT	TT	29	3072
LOK	Cantilever T-Base Tilt	Rectangular Top Shape	Height	Used on 30" x 72" Tops

Description	D	W	H	CTN WT	CU FT	Model	List Price
-------------	---	---	---	-----------	----------	-------	---------------

LOK- TRAINING

Page left intentionally blank

Description	D	W	H	CTN WT	CU FT	1 Model	List Price
Fixed T Base for Trapezoid Top	24	48	29	23	5	LK-TBF-TZ29-2448	\$513
	30	48	29	24	7	LK-TBF-TZ29-3048	\$545

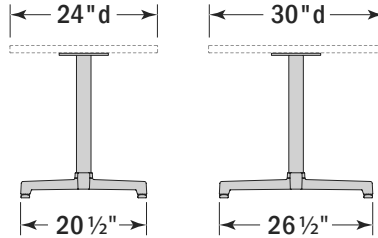


Features:

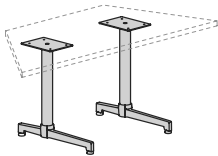
- specify Glide (G) or Caster(C) -choice of Black(BL) or White/Grey (WG) Caster; add \$41 list for casters

Options:

- bases include all necessary field assembly hardware
- specify metal finish, see below for options and two-tone capabilities



Cantilever Fixed T-Base for Trapezoid Top	24	48	29	23	5	LK-CBF-TZ29-2448	\$515
	30	48	29	24	7	LK-CBF-TZ29-3048	\$542



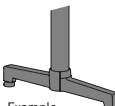
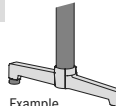



Features:

- specify Glide (G) or Caster(C) -choice of Black(BL) or White/Grey (WG) Caster; add \$41 list for casters

Options:

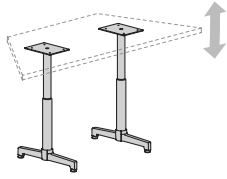
- bases include all necessary field assembly hardware
- specify metal finish, see below for options and two-tone capabilities

To Order Specify

1 Model #	2 Feet & Post Finish	Dual Finish		3 Glides or Casters		
Lok (LK)	See Feet & Post Finish Options  Example	2a Feet Finish See Feet Finish Options	2b Post Finish See Post Finish Options  Example	G Glides Standard (no upcharge) 	C Casters - BL Black + \$40 	- WG White w/Grey Wheels + \$40 

LK-TBF-TZ29-3072					
LK	TBF	TZ	29	3072	
LOK	T-Base Fixed	Trapezoid Top Shape	Height	Used on 30" x 72" Tops	

Description	D	W	H	CTN WT	CU FT	① Model	List Price
Adjustable T Base for Trapezoid Top	24	48	29	23	5	LK-TBA-TZ29-2448	\$626
	30	48	29	24	7	LK-TBA-TZ29-3048	\$656

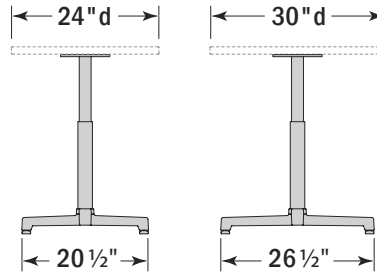


Features:

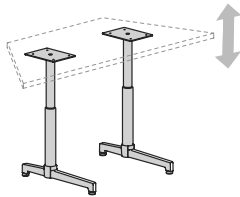
- pin adjustment base provides range of 26"-34"
- ADA Compliant
- bases include all necessary field assembly hardware

Options:

- specify metal finish, see below for options and two-tone capabilities



Description	D	W	H	CTN WT	CU FT	Model	List Price
Cantilever Adjustable T-Base for Trapezoid Top	24	48	29	23	5	LK-CBA-TZ29-2448	\$628
	30	48	29	24	7	LK-CBA-TZ29-3048	\$653

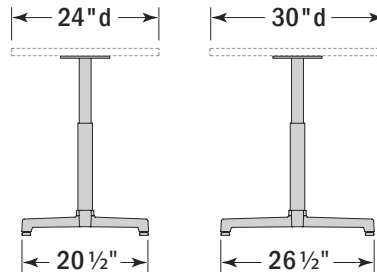


Features:

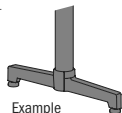
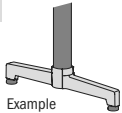

- pin adjustment base provides range of 26"-34"
- ADA Compliant
- bases include all necessary field assembly hardware

Options:

- specify metal finish, see below for options and two-tone capabilities

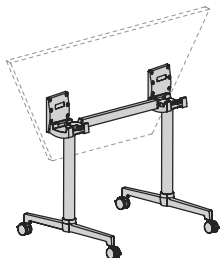


To Order Specify

① Model #	② Feet & Post Finish	Dual Finish		G Glides
Lok (LK)	See Feet & Post Finish Options 	2a Feet Finish See Feet Finish Options	2b Post Finish See Post Finish Options 	 Standard (no upcharge)

LK-TBF-TZ29-3072					
LK	TBA	TZ	29	3072	
LOK	T-Base Adjustable	Trapezoid Top Shape	Height	Used on 30" x 72" Tops	

Description	D	W	H	CTN WT	CU FT	① Model	List Price
Tilt T Base for Trapezoid Top	24	48	29	29	7	LK-TBT-TZ29-2448	\$1,000
	30	48	29	30	9	LK-TBT-TZ29-3048	\$1,033

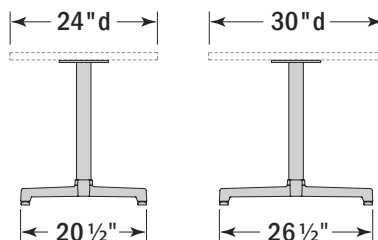


Features:

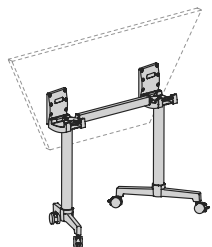
- base nests in offset position when top is tilted
- bases include all necessary field assembly hardware

Options:

- specify Black (BL) or White/Grey (WG) Caster
- specify metal finish, see below for options and two-tone capabilities



Inline Tilt T-Base for Trapezoid Top	24	48	29	27	6	LK-IBT-TZ29-2448	\$892
	30	48	29	28	8	LK-IBT-TZ29-3048	\$925




Features:

- base nests in inline position when top is tilted
- bases include all necessary field assembly hardware

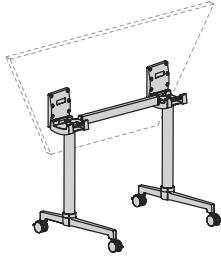
Options:

- specify metal finish, see below for options and two-tone capabilities
- specify Black (BL) or White/Grey (WG) Caster

To Order Specify

① Model #	② Feet & Post Finish	Dual Finish		③ Casters
Lok (LK)	See Feet & Post Finish Options 	2a Feet Finish See Feet Finish Options	2b Post Finish See Post Finish Options 	C Casters - Standard (no upcharge) - BL Black - WG White w/Grey Wheels 
LK-TBT-TZ29-3048				
LK	TBT	TZ	29	3048
LOK	T-Base Tilt	Trapezoid Top Shape	Height	Used on 30" x 48" Tops

Description	D	W	H	CTN WT	CU FT	1 Model	List Price
Cantilever Tilt T-Base for Trapezoid Top	24	48	29	29	7	LK-CBT-TZ29-2448	\$1,017
	30	48	29	30	9	LK-CBT-TZ29-3048	\$1,043



Features:

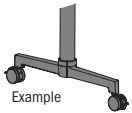
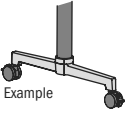

- base nests in offset position when top is tilted
- bases include all necessary field assembly hardware

Options:

- specify Black (BL) or White/Grey (WG) Caster
- specify metal finish, see below for options and two-tone capabilities

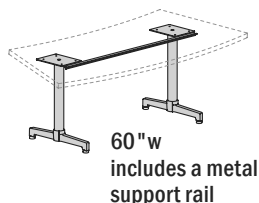
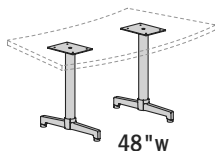
LOK - TRAINING

To Order Specify

1 Model #	2 Feet & Post Finish	Dual Finish		3 Casters
Lok (LK)	See Feet & Post Finish Options 	2a Feet Finish See Feet Finish Options	2b Post Finish See Post Finish Options 	C Casters - Standard (no upcharge) - BL Black - WG White w/Grey Wheels 

LK-IBT-TT29-3072					
LK	IBT	TZ	29	3072	
LOK	Inline T-Base Tilt	Trapezoid Top Shape	Height	Used on 30" x 72" Tops	

Description	D	W	H	CTN WT	CU FT	1 Model	List Price
Fixed T Base for Lecture Top	24	48	29	23	5	LK-TBF-LC29-2448	\$528
	30	48	29	24	7	LK-TBF-LC29-3048	\$561
	24	60	29	27	6	LK-TBF-LC29-2460	\$568
	30	60	29	28	8	LK-TBF-LC29-3060	\$600

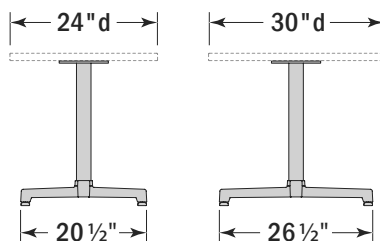


Features:

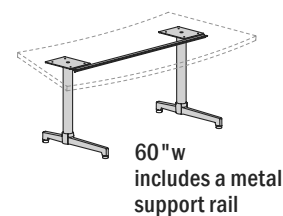
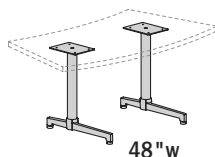
- bases include all necessary field assembly hardware

Options:

- specify metal finish, see below for options and two-tone capabilities
- specify Glide (G) or Caster(C) -choice of Black(BL) or White/Grey (WG) Caster; add \$41 list for casters



Description	D	W	H	CTN WT	CU FT	1 Model	List Price
Cantilever Fixed T-Base for Lecture Top	24	48	29	22	4	LK-CBF-LC29-2448	\$515
	30	48	29	24	7	LK-CBF-LC29-3048	\$556
	24	60	29	26	5	LK-CBF-LC29-2460	\$555
	30	60	29	28	8	LK-CBF-LC29-3060	\$598



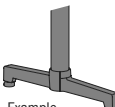
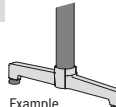


Features:

- bases include all necessary field assembly hardware

Options:

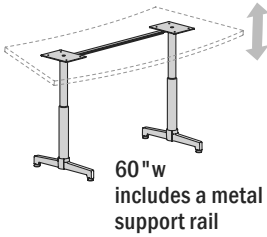
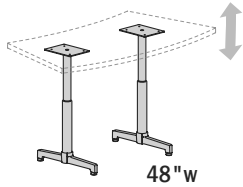
- specify metal finish, see below for options and two-tone capabilities
- specify Glide (G) or Caster(C) -choice of Black(BL) or White/Grey (WG) Caster; add \$41 list for casters

To Order Specify

1 Model #	2 Feet & Post Finish	Dual Finish		3 Glides or Casters		
Lok (LK)	See Feet & Post Finish Options 	2a Feet Finish See Feet Finish Options	2b Post Finish See Post Finish Options 	G Glides Standard (no upcharge) 	C Casters - BL Black + \$40 	- WG White w/Grey Wheels + \$40 

LK-CBF-LC29-3072						
LK	CBF	LC	29	3060		
LOK	T-Base Fixed	Lecture Top Shape	Height	Used on 30" x 72" Tops		

Description	D	W	H	CTN WT	CU FT	① Model	List Price
Adjustable T Base for Lecture Top	24	48	29	23	5	LK-TBA-LC29-2448	\$640
	30	48	29	24	7	LK-TBA-LC29-3048	\$673
	24	60	29	27	6	LK-TBA-LC29-2460	\$680
	30	60	29	28	8	LK-TBA-LC29-3060	\$713

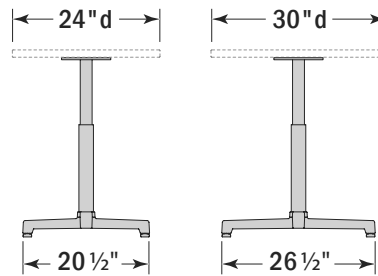


Features:

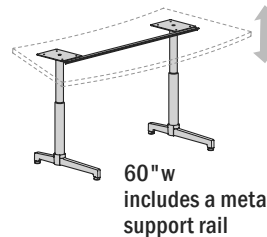
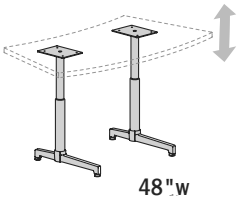
- pin adjustment base provides range of 26"-34"
- ADA Compliant
- bases include all necessary field assembly hardware

Options:

- specify metal finish, see below for options and two-tone capabilities



Description	D	W	H	CTN WT	CU FT	Model	List Price
Cantilever Adjustable T-Base for Lecture Top	24	48	29	22	4	LK-CBA-LC29-2448	\$628
	30	48	29	24	7	LK-CBA-LC29-3048	\$669
	24	60	29	26	5	LK-CBA-LC29-2460	\$668
	30	60	29	28	8	LK-CBA-LC29-3060	\$711



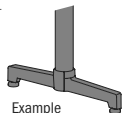
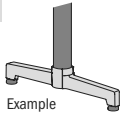
Features:

- pin adjustment base provides range of 26"-34"
- ADA Compliant
- bases include all necessary field assembly hardware

Options:

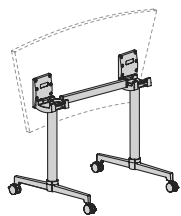
- specify metal finish, see below for options and two-tone capabilities

To Order Specify

① Model #	② Feet & Post Finish	Dual Finish	
Lok (LK)	See Feet & Post Finish Options 	②a Feet Finish See Feet Finish Options	②b Post Finish See Post Finish Options 

LK-CBA-LC29-3060					
LK	CBA	LC	29	3060	
LOK	Cantilever T-Base Adjustable	Lecture Top Shape	Height	Used on 30" x 60" Tops	

Description	D	W	H	CTN WT	CU FT	1 Model	List Price
Tilt T Base for Lecture Top	24	48	29	29	7	LK-TBT-LC29-2448	\$1,015
	30	48	29	30	9	LK-TBT-LC29-3048	\$1,047
	24	60	29	30	7	LK-TBT-LC29-2460	\$1,031
	30	60	29	31	9	LK-TBT-LC29-3060	\$1,061

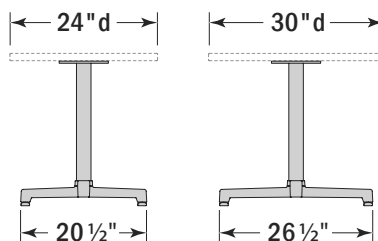


Features:

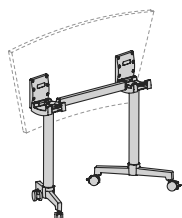
- base nests in offset position when top is tilted
- bases include all necessary field assembly hardware

Options:

- specify metal finish, see below for options and two-tone capabilities



Description	D	W	H	CTN WT	CU FT	Model	List Price
Inline Tilt T-Base for Lecture Top	24	48	29	28	6	LK-IBT-LC29-2448	\$892
	30	48	29	28	8	LK-IBT-LC29-3048	\$925
	24	60	29	29	7	LK-IBT-LC29-2460	\$1,015
	30	60	29	30	9	LK-IBT-LC29-3060	\$1,047



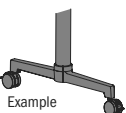
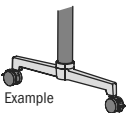

Features:

- base nests in inline position when top is tilted
- bases include all necessary field assembly hardware

Options:

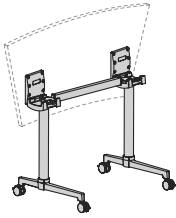
- specify metal finish, see below for options and two-tone capabilities
- specify Black (BL) or White/Grey (WG) Caster

To Order Specify

1 Model #	2 Feet & Post Finish	Dual Finish	3 Casters
Lok (LK)	See Feet & Post Finish Options 	2a Feet Finish See Feet Finish Options 2b Post Finish See Post Finish Options 	C Casters - Standard (no upcharge) - BL Black - WG White w/Grey Wheels 

LK-TBF-TT29-3072					
LK	TBF	TT	29	3072	
LOK	T-Base Fixed	Rectangular Top Shape	Height	Used on 30" x 72" Tops	

Description	D	W	H	CTN WT	CU FT	① Model	List Price
Cantilever Tilt T-Base for Lecture Top	24	48	29	29	7	LK-CBT-LC29-2448	\$1,033
	30	48	29	30	9	LK-CBT-LC29-3048	\$1,043
	24	60	29	30	7	LK-CBT-LC29-2460	\$1,017
	30	60	29	31	9	LK-CBT-LC29-3060	\$1,059



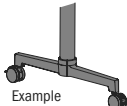
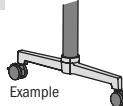

Features:

- bases include all necessary field assembly hardware
- specify metal finish, see below for options and two-tone capabilities

Options:

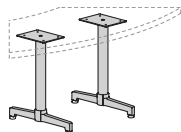
- specify Black (BL) or White/Grey (WG) Caster

To Order Specify

① Model #	② Feet & Post Finish	Dual Finish	③ Casters
Lok (LK)	See Feet & Post Finish Options 	2a Feet Finish See Feet Finish Options 2b Post Finish See Post Finish Options 	C Casters - Standard (no upcharge) - BL Black - WG White w/Grey Wheels 

LK-TBF-TT29-3072					
LK	TBA	TT	29	3072	
LOK	T-Base Adjustable	Rectangular Top Shape	Height	Used on 30" x 72" Tops	

Description	D	W	H	CTN WT	CU FT	1 Model	List Price
Fixed T Base for Crescent Top	24	48	29	23	5	LK-TBF-CR29-2448	\$513
	30	48	29	24	7	LK-TBF-CR29-3048	\$545

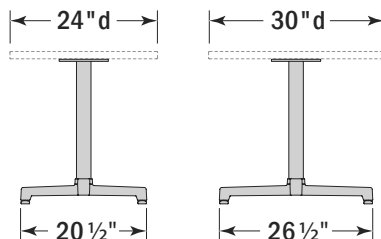


Features:

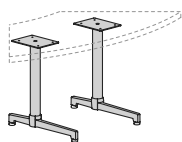
- bases include all necessary field assembly hardware

Options:

- specify metal finish, see below for options and two-tone capabilities
- specify Glide (G) or Caster(C) -choice of Black(BL) or White/Grey (WG) Caster; add \$41 list for casters



Cantilever Fixed T-Base for Crescent Top	24	48	29	23	5	LK-CBF-CR29-2448	\$515
	30	48	29	24	7	LK-CBF-CR29-3048	\$542



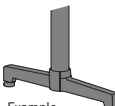
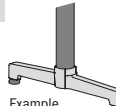


Features:

- bases include all necessary field assembly hardware

Options:

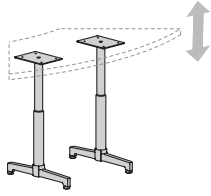
- specify metal finish, see below for options and two-tone capabilities
- specify Glide (G) or Caster(C) -choice of Black(BL) or White/Grey (WG) Caster; add \$41 list for casters

To Order Specify

1 Model #	2 Feet & Post Finish	Dual Finish		3 Glides or Casters		
Lok (LK)	See Feet & Post Finish Options  Example	2a Feet Finish See Feet Finish Options	2b Post Finish See Post Finish Options  Example	G Glides Standard (no upcharge) 	C Casters - BL Black + \$40 	- WG White w/Grey Wheels + \$40 

LK-TBF-TT29-3072					
LK	TBF	TT	29	3072	
LOK	T-Base Fixed	Rectangular Top Shape	Height	Used on 30" x 72" Tops	

Description	D	W	H	CTN WT	CU FT	① Model	List Price
Adjustable T Base for Crescent Top	24	48	29	23	5	LK-TBA-CR29-2448	\$626
	30	48	29	24	7	LK-TBA-CR29-3048	\$656

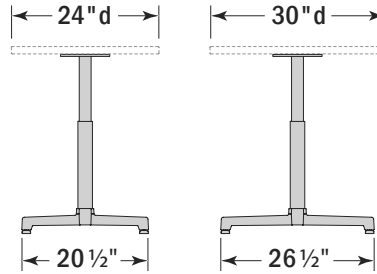


Features:

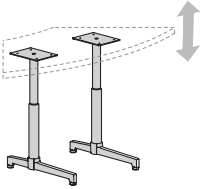
- pin adjustment base provides range of 26"-34"
- ADA Compliant
- bases include all necessary field assembly hardware

Options:

- specify metal finish, see below for options and two-tone capabilities



Cantilever Adjustable T-Base for Crescent Top	24	48	29	23	5	LK-CBA-CR29-2448	\$628
	30	48	29	24	7	LK-CBA-CR29-3048	\$653



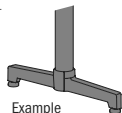
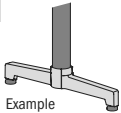
Features:

- pin adjustment base provides range of 26"-34"
- ADA Compliant
- bases include all necessary field assembly hardware

Options:

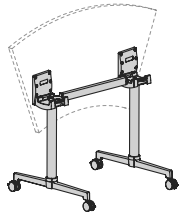
- specify metal finish, see below for options and two-tone capabilities

To Order Specify

① Model #	② Feet & Post Finish	Dual Finish	
Lok (LK)	See Feet & Post Finish Options  <p>Example</p>	2a Feet Finish See Feet Finish Options	2b Post Finish See Post Finish Options  <p>Example</p>

LK-TBF-TT29-3072					
LK	TBA	TT	29	3072	
LOK	T-Base Adjustable	Rectangular Top Shape	Height	Used on 30" x 72" Tops	

Description	D	W	H	CTN WT	CU FT	1 Model	List Price
Tilt T Base for Crescent Top	24	48	29	29	7	LK-TBT-CR29-2448	\$1,000
	30	48	29	30	9	LK-TBT-CR29-3048	\$1,033

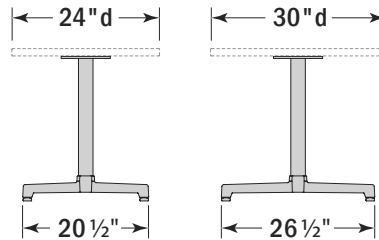


Features:

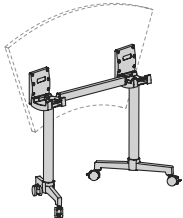
- base nests in offset position when top is tilted
- bases include all necessary field assembly hardware

Options:

- specify metal finish, see below for options and two-tone capabilities



Description	D	W	H	CTN WT	CU FT	1 Model	List Price
Inline Tilt T-Base for Crescent Top	24	48	29	28	6	LK-IBT-CR29-2448	\$892
	30	48	29	28	8	LK-IBT-CR29-3048	\$925



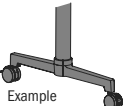
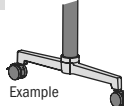

Features:

- base nests in inline position when top is tilted
- bases include all necessary field assembly hardware

Options:

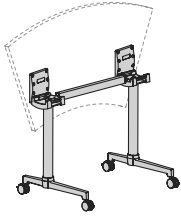
- specify metal finish, see below for options and two-tone capabilities
- specify Black (BL) or White/Grey (WG) Caster

To Order Specify

1 Model #	2 Feet & Post Finish	Dual Finish		3 Casters
Lok (LK)	See Feet & Post Finish Options 	2a Feet Finish See Feet Finish Options	2b Post Finish See Post Finish Options 	C Casters - Standard (no upcharge) - BL Black - WG White w/Grey Wheels 

LK-TBF-TT29-3072					
LK	TBF	TT	29	3072	
LOK	T-Base Fixed	Rectangular Top Shape	Height	Used on 30" x 72" Tops	

Description	D	W	H	CTN WT	CU FT	1 Model	List Price
Cantilever Tilt T-Base for Crescent Top	24	48	29	29	7	LK-CBT-CR29-2448	\$1,017
	30	48	29	30	9	LK-CBT-CR29-3048	\$1,043



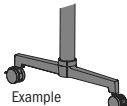
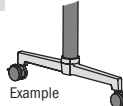


Features:

- bases include all necessary field assembly hardware
- specify metal finish, see below for options and two-tone capabilities

Options:

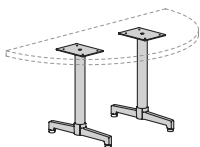
- specify Black (BL) or White/Grey (WG) Caster

To Order Specify

1 Model #	2 Feet & Post Finish	Dual Finish		3 Casters
Lok (LK)	See Feet & Post Finish Options 	2a Feet Finish See Feet Finish Options	2b Post Finish See Post Finish Options 	C Casters - Standard (no upcharge) - BL Black - WG White w/Grey Wheels  

LK-TBF-TT29-3072					
LK	TBA	TT	29	3072	
LOK	T-Base Adjustable	Rectangular Top Shape	Height	Used on 30" x 72" Tops	

Description	D	W	H	CTN WT	CU FT	① Model	List Price
Fixed T Base for Half Round Top	24	48	29	23	5	LK-TBF-HR29-2448	\$513
	30	60	29	28	8	LK-TBF-HR29-3060	\$600

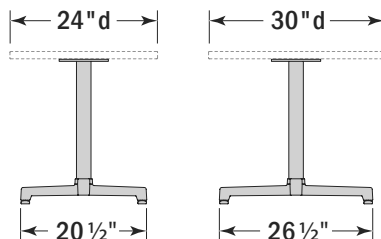


Features:

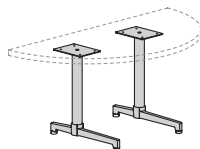
- bases include all necessary field assembly hardware

Options:

- specify metal finish, see below for options and two-tone capabilities
- specify Glide (G) or Caster(C) -choice of Black(BL) or White/Grey (WG) Caster; add \$41 list for casters



Cantilever Fixed T-Base for Half Round Top	24	48	29	23	5	LK-CBF-HR29-2448	\$501
	30	60	29	28	8	LK-CBF-HR29-3060	\$598



Features:

- bases include all necessary field assembly hardware

Options:

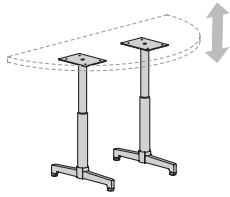
- specify metal finish, see below for options and two-tone capabilities
- specify Glide (G) or Caster(C) -choice of Black(BL) or White/Grey (WG) Caster; add \$41 list for casters

To Order Specify

① Model #	② Feet & Post Finish	Dual Finish	③ Glides or Casters
Lok (LK)	See Feet & Post Finish Options Example	2a Feet Finish See Feet Finish Options 2b Post Finish See Post Finish Options Example	G Glides Standard (no upcharge) C Casters - BL Black +\$40 - WG White w/Grey Wheels +\$40

LK-TBF-TT29-3072					
LK	TBF	TT	29	3072	
LOK	T-Base Fixed	Rectangular Top Shape	Height	Used on 30" x 72" Tops	

Description	D	W	H	CTN WT	CU FT	① Model	List Price
Adjustable T Base for Half Round Top	24	48	29	23	5	LK-TBA-HR29-2448	\$626
	30	60	29	28	8	LK-TBA-HR29-3060	\$713

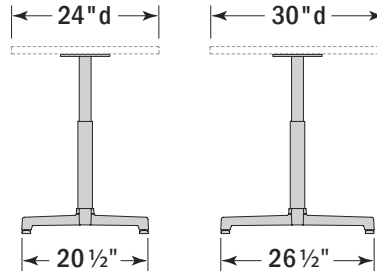


Features:

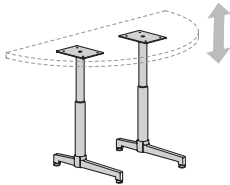
- pin adjustment base provides range of 26"-34"
- ADA Compliant
- bases include all necessary field assembly hardware

Options:

- specify metal finish, see below for options and two-tone capabilities



Cantilever Adjustable T-Base for Half Round Top	24	48	29	23	5	LK-CBA-HR29-2448	\$612
	30	60	29	28	8	LK-CBA-HR29-3060	\$711



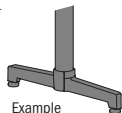
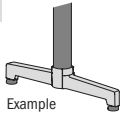
Features:

- pin adjustment base provides range of 26"-34"
- ADA Compliant
- bases include all necessary field assembly hardware

Options:

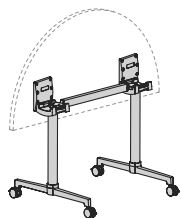
- specify metal finish, see below for options and two-tone capabilities

To Order Specify

① Model #	② Feet & Post Finish	Dual Finish	
Lok (LK)	See Feet & Post Finish Options 	2a Feet Finish See Feet Finish Options	2b Post Finish See Post Finish Options 

LK-TBF-TT29-3072					
LK	TBA	TT	29	3072	
LOK	T-Base Adjustable	Rectangular Top Shape	Height	Used on 30" x 72" Tops	

Description	D	W	H	CTN WT	CU FT	1 Model	List Price
Tilt T Base for Half Round Top	24	48	29	28	6	LK-TBT-HR29-2448	\$892
	30	60	29	30	9	LK-TBT-HR29-3060	\$1,047

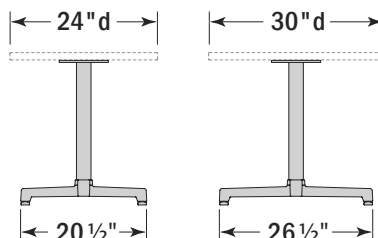


Features:

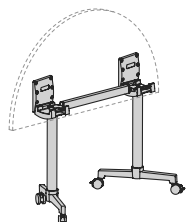
- base nests in offset position when top is tilted
- bases include all necessary field assembly hardware

Options:

- specify metal finish, see below for options and two-tone capabilities



Description	D	W	H	CTN WT	CU FT	1 Model	List Price
Inline Tilt T-Base for Half Round Top	24	48	29	28	6	LK-IBT-HR29-2448	\$892
	30	60	29	30	9	LK-IBT-HR29-3060	\$1,047



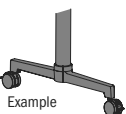
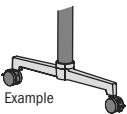


Features:

- base nests in inline position when top is tilted
- bases include all necessary field assembly hardware

Options:

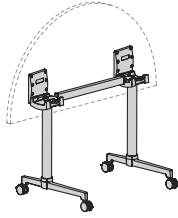
- specify metal finish, see below for options and two-tone capabilities
- specify Black (BL) or White/Grey (WG) Caster

To Order Specify

1 Model #	2 Feet & Post Finish	Dual Finish	3 Casters		
Lok (LK)	See Feet & Post Finish Options 	<table border="0"> <tr> <td>2a Feet Finish See Feet Finish Options</td> <td>2b Post Finish See Post Finish Options</td> </tr> </table> 	2a Feet Finish See Feet Finish Options	2b Post Finish See Post Finish Options	C Casters - Standard (no upcharge) - BL Black - WG White w/Grey Wheels  
2a Feet Finish See Feet Finish Options	2b Post Finish See Post Finish Options				

LK-TBF-TT29-3072					
LK	TBF	TT	29	3072	
LOK	T-Base Fixed	Rectangular Top Shape	Height	Used on 30" x 72" Tops	

Description	D	W	H	CTN WT	CU FT	1 Model	List Price
Cantilever Tilt T-Base for Half Round Top	24	48	29	28	6	LK-CBT-HR29-2448	\$894
	30	60	29	30	9	LK-CBT-HR29-3060	\$1,043

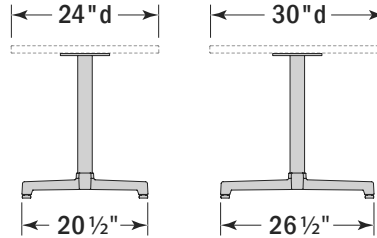


Features:

- bases include all necessary field assembly hardware
- specify metal finish, see below for options and two-tone capabilities

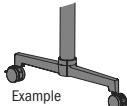
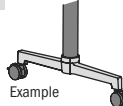

Options:

- specify Black (BL) or White/Grey (WG) Caster

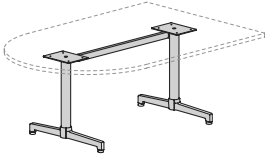


LOK - TRAINING

To Order Specify

1 Model #	2 Feet & Post Finish	Dual Finish		3 Casters
Lok (LK)	See Feet & Post Finish Options 	2a Feet Finish See Feet Finish Options	2b Post Finish See Post Finish Options 	C Casters - Standard (no upcharge) - BL Black - WG White w/Grey Wheels 

LK-TBF-TT29-3072					
LK	TBA	TT	29	3072	
LOK	T-Base Adjustable	Rectangular Top Shape	Height	Used on 30" x 72" Tops	

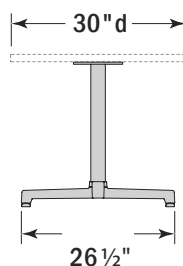
Description	D	W	H	CTN WT	CU FT	① Model	List Price
	30	60	29	28	8	LK-TBF-BU29-3060	\$600
	36	60	29	29	8	LK-TBF-BU29-3660	\$636
	30	66	29	28	8	LK-TBF-BU29-3066	\$600
	36	66	29	29	8	LK-TBF-BU29-3666	\$636
	30	72	29	29	8	LK-TBF-BU29-3072	\$611
	36	72	29	29	8	LK-TBF-BU29-3672	\$647
	48	72	29	29	8	LK-TBF-BU29-4872	\$636

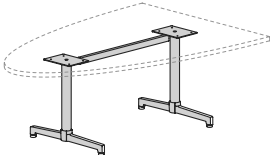
Features:

- bases include all necessary top support and field assembly hardware

Options:

- specify metal finish, see below for options and two-tone capabilities
- specify Glide (G) or Caster(C) -choice of Black(BL) or White/Grey (WG) Caster; add \$41 list for casters



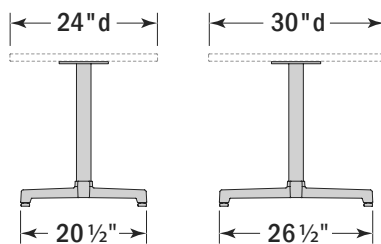
Description	D	W	H	CTN WT	CU FT	① Model	List Price
	30	60	29	28	8	LK-TBF-HV29-3060	\$600
	36	60	29	29	8	LK-TBF-HV29-3660	\$636
	30	66	29	28	8	LK-TBF-HV29-3066	\$600
	36	66	29	29	8	LK-TBF-HV29-3666	\$636
	30	72	29	29	8	LK-TBF-HV29-3072	\$611
	36	72	29	29	8	LK-TBF-HV29-3672	\$636
	48	72	29	29	8	LK-TBF-HV29-4872	\$647

Features:

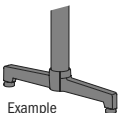


- specify metal finish, see below for options and two-tone capabilities

Options:

- specify metal finish, see below for options and two-tone capabilities
- specify Glide (G) or Caster(C) -choice of Black(BL) or White/Grey (WG) Caster; add \$41 list for casters

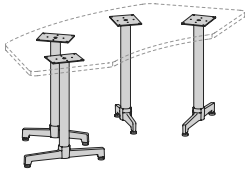


To Order Specify

① Model #	② Feet & Post Finish	Dual Finish		③ Glides or Casters		
Lok (LK)	See Feet & Post Finish Options 	②a Feet Finish See Feet Finish Options	②b Post Finish See Post Finish Options 	G Glides Standard (no upcharge) 	C Casters - BL Black + \$40 	- WG White w/Grey Wheels + \$40 

LK-TBF-TT29-3072					
LK	TBF	TT	29	3072	
LOK	T-Base Fixed	Rectangular Top Shape	Height	Used on 30" x 72" Tops	

Description	D	W	H	CTN WT	CU FT	① Model	List Price
Fixed T Base for Huddle Top	30	72	29	45	9	LK-TBF-HU29-3072	\$998
	36	84	29	45	9	LK-TBF-HU29-3684	\$998



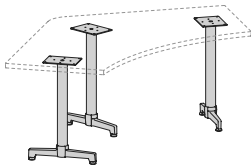
Features:

- bases include all necessary top support and field assembly hardware

Options:

- specify metal finish, see below for options and two-tone capabilities
- specify Glide (G) or Caster(C) -choice of Black(BL) or White/Grey (WG) Caster; add \$81 list for casters

Fixed T Base for One-twenty Top	42	72	29	33	7	LK-TBF-YG29-4272	\$725
	45	84	29	33	7	LK-TBF-YG29-4584	\$725



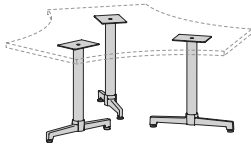
Features:

- bases include all necessary top support and field assembly hardware

Options:

- specify metal finish, see below for options and two-tone capabilities
- specify Glide (G) or Caster(C) -choice of Black(BL) or White/Grey (WG) Caster; add \$61 list for casters

Fixed T Base for Intersect Top	24	60	29	35	8	LK-TBF-IN29-2460	\$765
	30	60	29	35	8	LK-TBF-IN29-3060	\$765



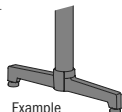
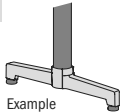
Features:

- bases include all necessary top support and field assembly hardware

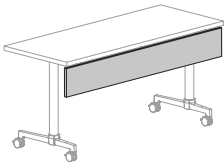
Options:

- specify metal finish, see below for options and two-tone capabilities
- specify Glide (G) or Caster(C) -choice of Black(BL) or White/Grey (WG) Caster; add \$61 list for casters

To Order Specify

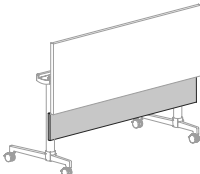
① Model #	② Feet & Post Finish	Dual Finish	
Lok (LK)	See Feet & Post Finish Options  <p>Example</p>	2a Feet Finish See Feet Finish Options	2b Post Finish See Post Finish Options  <p>Example</p>

LK-TBF-TT29-3072						
LK	TBA	TT	29	3072		
LOK	T-Base Adjustable	Rectangular Top Shape	Height	Used on 30" x 72" Tops		

Description	D	W	H	CTN WT	CU FT	① Model	TFL	Standard		
								HPL 1	HPL 2	HPL 3
Fixed Laminate Modesty Panel	¾	26	8	10	2	LK-MPF-26T	\$161			
	¾	26	8	10	2	LK-MPF-26H		\$239	\$246	\$296
	¾	30	8	10	2	LK-MPF-30T	\$163			
	¾	30	8	10	2	LK-MPF-30H		\$240	\$248	\$297
	¾	36	8	10	2	LK-MPF-36T	\$166			
	¾	36	8	10	2	LK-MPF-36H		\$242	\$251	\$300
	¾	42	8	10	3	LK-MPF-42T	\$171			
	¾	42	8	10	3	LK-MPF-42H		\$255	\$266	\$332
	¾	48	8	10	3	LK-MPF-48T	\$174			
	¾	48	8	10	3	LK-MPF-48H		\$257	\$268	\$334
	¾	60	8	11	3	LK-MPF-60T	\$196			
	¾	60	8	11	3	LK-MPF-60H		\$290	\$303	\$384
	¾	66	8	12	3	LK-MPF-66T	\$201			
	¾	66	8	12	3	LK-MPF-66H		\$298	\$313	\$403
	¾	72	8	12	4	LK-MPF-72T	\$204			
	¾	72	8	12	4	LK-MPF-72H		\$307	\$321	\$421
	¾	84	8	14	4	LK-MPF-84T	\$213			
	¾	84	8	14	4	LK-MPF-84H		\$325	\$342	\$458
	¾	96	8	15	5	LK-MPF-96T	\$220			
	¾	96	8	15	5	LK-MPF-96H		\$341	\$362	\$494

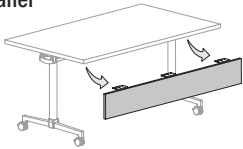
Features:

- not intended to be used on a table with tilt bases.

Description	D	W	H	CTN WT	CU FT	① Model	TFL	Standard		
								HPL 1	HPL 2	HPL 3
Hinged Laminate Modesty Panel	¾	26	8	10	2	LK-MPH-26T	\$200			
	¾	26	8	10	2	LK-MPH-26H		\$275	\$283	\$333
	¾	30	8	10	2	LK-MPH-30T	\$201			
	¾	30	8	10	2	LK-MPH-30H		\$276	\$284	\$334
	¾	36	8	10	2	LK-MPH-36T	\$202			
	¾	36	8	10	2	LK-MPH-36H		\$278	\$287	\$336
	¾	48	8	10	3	LK-MPH-48T	\$210			
	¾	48	8	10	3	LK-MPH-48H		\$294	\$305	\$371
	¾	60	8	11	3	LK-MPH-60T	\$244			
	¾	60	8	11	3	LK-MPH-60H		\$338	\$351	\$434
	¾	66	8	12	3	LK-MPH-66T	\$249			
	¾	66	8	12	3	LK-MPH-66H		\$347	\$360	\$454
	¾	72	8	12	4	LK-MPH-72T	\$253			
	¾	72	8	12	4	LK-MPH-72H		\$355	\$371	\$470
	¾	84	8	14	4	LK-MPH-84T	\$261			
	¾	84	8	14	4	LK-MPH-84H		\$373	\$391	\$507
	¾	96	8	15	5	LK-MPH-96T	\$269			
	¾	96	8	15	5	LK-MPH-96H		\$391	\$412	\$544

Features:

- not intended to be used on a table with fixed bases.
- magnetic hinge holds modesty panel in vertical position
- magnetic hinge releases for self-storage when table is tilted

Description	D	W	H	CTN WT	CU FT	① Model	TFL	Standard		
								HPL 1	HPL 2	HPL 3
Removable Laminate Modesty Panel	¾	26	8	10	2	LK-MPR-26T	\$200			
	¾	26	8	10	2	LK-MPR-26H		\$276	\$284	\$334
	¾	30	8	10	2	LK-MPR-30T	\$201			
	¾	30	8	10	2	LK-MPR-30H		\$277	\$285	\$335
	¾	36	8	10	2	LK-MPR-36T	\$203			
	¾	36	8	10	2	LK-MPR-36H		\$279	\$289	\$338
	¾	42	8	10	3	LK-MPR-42T	\$209			
	¾	42	8	10	3	LK-MPR-42H		\$293	\$304	\$369
	¾	48	8	10	3	LK-MPR-48T	\$211			
	¾	48	8	10	3	LK-MPR-48H		\$295	\$306	\$372
	¾	60	8	11	3	LK-MPR-60T	\$253			
	¾	60	8	11	3	LK-MPR-60H		\$346	\$358	\$441
	¾	66	8	12	3	LK-MPR-66T	\$257			
	¾	66	8	12	3	LK-MPR-66H		\$354	\$369	\$460
	¾	72	8	12	4	LK-MPR-72T	\$261			
	¾	72	8	12	4	LK-MPR-72H		\$363	\$379	\$478
	¾	84	8	14	4	LK-MPR-84T	\$269			
	¾	84	8	14	4	LK-MPR-84H		\$381	\$399	\$514
	¾	96	8	15	5	LK-MPR-96T	\$276			
	¾	96	8	15	5	LK-MPR-96H		\$397	\$419	\$551

Features:

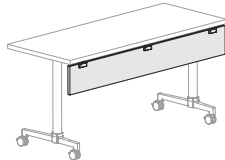
- when selecting removable modesty panels on a tilt training table, modesty must be removed prior to tilting

To Order Specify

① Model #	②a Laminate Selection	②b PVC Edge Color
Model (LK)	See Laminate Selection	See PVC Edge Color Options

Model Number Breakdown

LK-MPF-48H				
LK	MPF	48	H	
LOK	Modesty Panel Fixed	48" Wide	HPL Laminate	

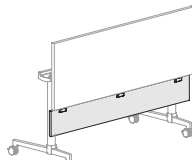
Description	D	W	H	CTN WT	CU FT	① Model	List Price
 <p>Fixed Acrylic Modesty Panel</p>	¼	26	8	10	2	LK-MPF-26A	\$306
	¼	30	8	10	2	LK-MPF-30A	\$307
	¼	36	8	10	2	LK-MPF-36A	\$309
	¼	42	8	10	3	LK-MPF-42A	\$343
	¼	48	8	10	3	LK-MPF-48A	\$346
	¼	60	8	11	3	LK-MPF-60A	\$424
	¼	66	8	12	3	LK-MPF-66A	\$453
	¼	72	8	12	4	LK-MPF-72A	\$478
	¼	84	8	14	4	LK-MPF-84A	\$527
¼	96	8	15	5	LK-MPF-96A	\$576	

Features:

- not intended to be used on a table with tilt bases.

Options:

- specify trim cap; Matte Black (MBK), Pewter (PEW), Arctic Silver (ASL), Soft Nickel (SNK)

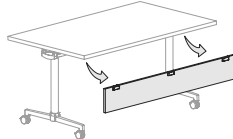
Description	D	W	H	CTN WT	CU FT	① Model	List Price
 <p>Hinged Acrylic Modesty Panel</p>	¼	26	8	10	2	LK-MPH-26A	\$326
	¼	30	8	10	2	LK-MPH-30A	\$327
	¼	36	8	10	2	LK-MPH-36A	\$330
	¼	48	8	10	3	LK-MPH-48A	\$380
	¼	60	8	11	3	LK-MPH-60A	\$475
	¼	66	8	12	3	LK-MPH-66A	\$507
	¼	72	8	12	4	LK-MPH-72A	\$528
	¼	84	8	14	4	LK-MPH-84A	\$578
	¼	96	8	15	5	LK-MPH-96A	\$627

Features:

- not intended to be used on a table with fixed bases.
- magnetic hinge holds modesty panel in vertical position
- magnetic hinge holds modesty panel in vertical position

Options:

- magnetic hinge holds modesty panel in vertical position

Description	D	W	H	CTN WT	CU FT	① Model	List Price
 <p>Removable Acrylic Modesty Panel</p>	¼	26	8	10	2	LK-MPR-26A	\$343
	¼	30	8	10	2	LK-MPR-30A	\$345
	¼	36	8	10	2	LK-MPR-36A	\$347
	¼	42	8	10	3	LK-MPR-42A	\$380
	¼	48	8	10	3	LK-MPR-48A	\$383
	¼	60	8	11	3	LK-MPR-60A	\$480
	¼	66	8	12	3	LK-MPR-66A	\$509
	¼	72	8	12	4	LK-MPR-72A	\$533
	¼	84	8	14	4	LK-MPR-84A	\$584
¼	96	8	15	5	LK-MPR-96A	\$632	

Features:

- when selecting removable modesty panels on a tilt training table, modesty must be removed prior to tilting

Options:

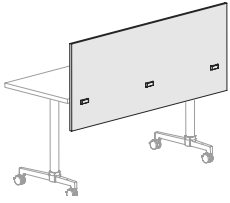
- specify trim cap; Matte Black (MBK), Pewter (PEW), Arctic Silver (ASL), Soft Nickel (SNK)

To Order Specify

① Model #	② Trim Cap Finish
Lok (LK)	<p>See Trim Cap Finish Options</p> 

Model Number Breakdown

LK-MPF-48A				
LK	MPF	48	A	
LOK	Modesty Panel Fixed	48" Wide	Acrylic	

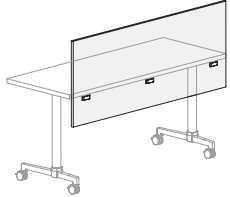
Description	D	W	H	CTN WT	CU FT	① Model	List Price
 <p>Acoustic Privacy Screen</p>	½	20	23 ¾	10	2	LK-PSP-2024P	\$389
	½	24	23 ¾	10	2	LK-PSP-2424P	\$432
	½	30	23 ¾	10	2	LK-PSP-3024P	\$505
	½	36	23 ¾	10	4	LK-PSP-3624P	\$512
	½	42	23 ¾	10	4	LK-PSP-4224P	\$665
	½	48	23 ¾	10	5	LK-PSP-4824P	\$671
	½	60	23 ¾	10	6	LK-PSP-6024P	\$1,144
	½	66	23 ¾	10	7	LK-PSP-6624P	\$1,147
	½	72	23 ¾	10	7	LK-PSP-7224P	\$1,152
	½	84	23 ¾	10	8	LK-PSP-8424P	\$1,160
½	96	23 ¾	10	9	LK-PSP-9624P	\$1,167	

Features:

- when adding privacy screen on tilting training table, privacy screen must be removed prior to tilting
- acoustic privacy screen can only be installed on straight edge of tables
- 13 ¾" height above surface

Options:

- specify Ash Grey (ASH) or Silver Grey (SIL)

Description	D	W	H	CTN WT	CU FT	① Model	List Price
 <p>Frosted Acrylic Privacy Screen</p>	¼	20	23 ¾	10	3	LK-PSP-2024A	\$375
	¼	24	23 ¾	10	3	LK-PSP-2424A	\$412
	¼	30	23 ¾	10	3	LK-PSP-3024A	\$467
	¼	36	23 ¾	10	3	LK-PSP-3624A	\$523
	¼	42	23 ¾	10	4	LK-PSP-4224A	\$596
	¼	48	23 ¾	10	5	LK-PSP-4824A	\$635
	¼	60	23 ¾	10	6	LK-PSP-6024A	\$781
	¼	66	23 ¾	10	7	LK-PSP-6624A	\$835
	¼	72	23 ¾	10	7	LK-PSP-7224A	\$892
	¼	84	23 ¾	10	8	LK-PSP-8424A	\$1,005
¼	96	23 ¾	10	9	LK-PSP-9624A	\$1,120	

Features:

- when adding privacy screen on tilting training table, privacy screen must be removed prior to tilting
- acrylic privacy screen can be installed on rectangular, crescent or lecture tables
- 13 ¾" height above surface

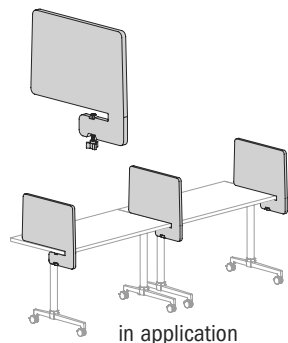
Options:

- specify trim cap; Matte Black (MBK), Pewter (PEW), Arctic Silver (ASL)

Model Number Breakdown

LK-PSP-4824A					
LK	PSP	48	24	A	
LOK	Privacy Screen Panel	48" Wide	24" Height	Acrylic	

Description	D	W	H	CTN WT	CU FT	① Model	List Price
Acoustic Portable Slide On Screen	1	24	21½	10	2	GP-PSO-2422P	\$790
	1	28	29½	14	3	GP-PSO-2830P	\$1,042



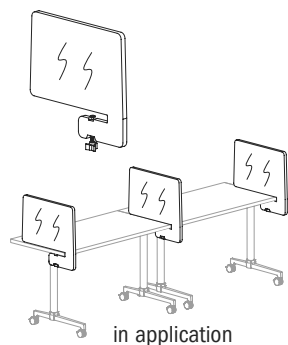
Features:

- works with any surface material
- works in any location, with the exception of where tilt release paddle is located on tilting tables
- GP-PSO-2422P - 16" height above surface; GP-PSO-2830P - 24" height above surface
- GP-PSO-2830P - not for use with surfaces 20" depth

Options:

- Specify Ash Grey (ASH) or Silver Grey (SIL)

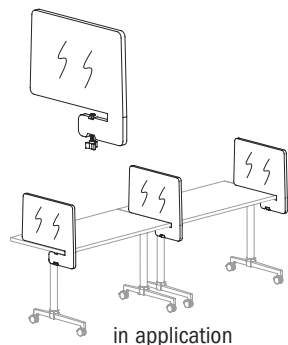
Markerboard Portable Slide On Screen	1	28	29½	26	3	GP-PSO-2830MB	\$909
--------------------------------------	---	----	-----	----	---	---------------	-------



Features:

- works with any surface material
- works in any location, with the exception of where tilt release paddle is located on tilting tables
- not for use with surfaces 20" depth
- white marker laminate surfaces with white PVC edges
- 24" height above surface

Magnetic Markerboard Portable Slide On Screen	1	24	21½	10	2	GP-PSO-2422MMB	\$1,042
	1	28	29½	14	3	GP-PSO-2830MMB	\$1,536



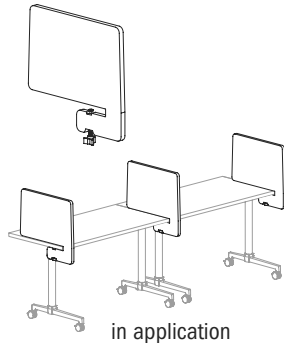
Features:

- works with any surface material
- works in any location, with the exception of where tilt release paddle is located on tilting tables
- GP-PSO-2422MMB - 16" height above surface; GP-PSO-2830MMB - 24" height above surface
- GP-PSO-2830MMB - not for use with surfaces 20" depth
- white magnetic marker laminate surfaces with white PVC edges

Model Number Breakdown

GP-PSO-2830MB						
GP	PSO	28	30	MB		
General Product	Portable Screen On	28" Wide	30" Height	Markerboard		

Description	D	W	H	CTN WT	CU FT	Model	List Price
HPL Portable Slide On Screen	1	28	29 ½	26	3	GP-PSO-2830H	\$959



Features:

- works with any surface material
- works in any location, with the exception of where tilt release paddle is located on tilting tables
- 24" height above surface
- not for use with surfaces 20" depth

Options:

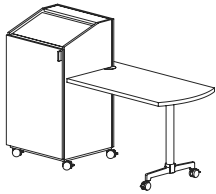
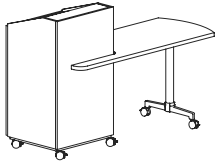
- specify standard JSI laminates with matching PVC edges

Model Number Breakdown

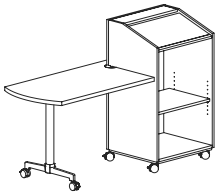
GP-PSO-2830H					
GP	PSO	28	30	H	
General Product	Portable Screen On	28" Wide	30" Height	HPL	

LOK - TRAINING

Description	D	W	H	CTN WT	CU FT	① Model	TFL	Standard HPL 1
Rounded Arc Rectangular Instructor Mobile Station Left with T Base	26	66	42	51	38	LK-29IRLO-2666RT	\$2,231	\$2,390
	26	66	42	51	38	LK-29IRRO-2666RT	\$2,231	\$2,390
	26	66	42	51	38	LK-29IRL7-2666RT	\$2,382	\$2,540
	26	66	42	51	38	LK-29IRR7-2666RT	\$2,382	\$2,540
	26	72	42	56	41	LK-29IRLO-2672RT	\$2,243	\$2,411
	26	72	42	56	41	LK-29IRRO-2672RT	\$2,243	\$2,411
	26	72	42	56	41	LK-29IRL7-2672RT	\$2,394	\$2,562
	26	72	42	56	41	LK-29IRR7-2672RT	\$2,394	\$2,562



LK-29IRL7-2666RT
(door unit, left)



LK-29IRRO-2666RT
(open unit, right)

Features:

- price reflects complete station
- ships KD in multiple cartons
- one adjustable shelf in podium
- cable routing opening at back of podium slanted surface
- wire access grommets in surface of top, as well as side and bottom panel of podium
- hand of model dictates what side the podium is located from user side
- models ending in OT have open compartment, models ending in TT have a door.
- table surface is at 29" high
- contact customer service for graded in HPL on worksurface pricing
- podium is always TFL

Options:

- order 48" fixed or removable modesty panel separately
- specify Podium grommet; None (GN) or tablet and cup holder grommets (GY) add \$86 list
- specify power option; see below

**Laminate Tops
"LKT" Models**



Eased Edge (R3)

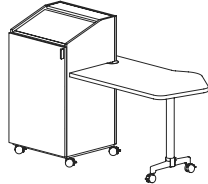
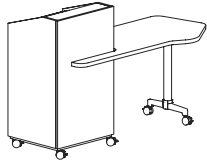
To Order Specify

① Model #	②a Laminate Selection	②b PVC Edge Color	③ Grommet
Model (LK)	See Laminate Selection	See PVC Edge Color Options	GN No Grommet
			GY Tablet and Cup Holder Grommet
			④ Electrical
			N No Cutout
			CTEC23-CO EC23 - Cut Out Center of Top
			CTEC24-CO EC24 - Cut Out Center of Top
			⑤ Caster
			C Caster
			- BL Black Caster
			- WG White Caster w/Grey Wheels
			⑥ Metal Finish
			See Metal Finish Color Options

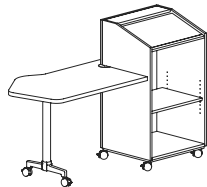
Model Number Breakdown

LK-29IRLO-2672RT								
LK	29	IR	L	0	26	72	R	T
LOK	Height	Rectangular Instructor Top	Left	Open Compartment	Depth	Wide	Rounded Arc	Laminate

Description	D	W	H	CTN WT	CU FT	① Model	TFL	Standard HPL 1
Interactive Instructor Mobile Station Left with T Base	31	66	42	52	44	LK-29IIL0-3166T	\$2,312	\$2,449
	31	66	42	52	44	LK-29IIR0-3166T	\$2,312	\$2,449
	31	66	42	52	44	LK-29IIL7-3166T	\$2,463	\$2,600
	31	66	42	52	44	LK-29IIR7-3166T	\$2,463	\$2,600
	31	72	42	57	48	LK-29IIL0-3172T	\$2,325	\$2,474
	31	72	42	57	48	LK-29IIR0-3172T	\$2,325	\$2,474
	31	72	42	57	48	LK-29IIL7-3172T	\$2,476	\$2,624
	31	72	42	57	48	LK-29IIR7-3172T	\$2,476	\$2,624



LK-29IIL7-3166T
(door unit, left)



LK-29IIR0-3166T
(open unit, right)

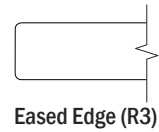
Features:

- price reflects complete station
- ships KD in multiple cartons
- one adjustable shelf in podium
- cable routing opening at back of podium slanted surface
- wire access grommets in surface of top, as well as side and bottom panel of podium
- hand of model dictates what side the podium is located from user side
- models ending in OT have open compartment, models ending in TT have a door.
- table surface is at 29" high
- contact customer service for graded in HPL on worksurface pricing
- podium is always TFL

Options:

- order 48" fixed or removable modesty panel separately
- specify Podium grommet; None (GN) or tablet and cup holder grommets (GY) add \$86 list
- specify power option; see below

Laminate Tops "LKT" Models



Eased Edge (R3)

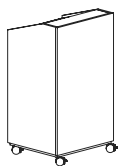
To Order Specify

① Model #	2a Laminate Selection	2b PVC Edge Color	③ Grommet
Model (LK)	See Laminate Selection	See PVC Edge Color Options	GN No Grommet GY Tablet and Cup Holder Grommet
			④ Electrical
			N No Cutout CTEC23-CO EC23 - Cut Out Center of Top CTEC24-CO EC24 - Cut Out Center of Top
			⑤ Caster
			C Caster - BL Black Caster - WG White Caster w/ Grey Wheels
			⑥ Metal Finish
			See Metal Finish Color Options

Model Number Breakdown

LK-29IIL0-3172T							
LK	29	II	L	7	26	72	T
LOK	Height	Interactive Instructor Top	Left	Door Unit	Depth	Wide	Laminate

Description	D	W	H	CTN WT	CU FT	① Model	List Price
Mobile Podium Open	22	24	42	18	19	LK-PDO-2224	\$1,512
	22	24	42	18	19	LK-PDL-2224	\$1,663
	22	24	42	18	19	LK-PDR-2224	\$1,663



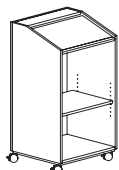
Features:

- one adjustable shelf
- wire access grommet in bottom panel
- cable routing opening at back of slanted surface

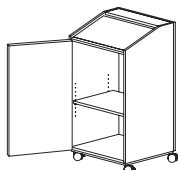
Options:

- specify grommet; None (GN) or tablet and cup holder grommets (GY) add \$86 list
- specify caster color option, Black (BL) or White with Grey Wheels (WG)

LOK - TRAINING

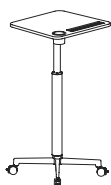


LK-PDO-2224
(open unit)



LK-PDR-2224
(door unit, right)

Description	D	W	H	CTN WT	CU FT	① Model	TFL	Standard	Graded In	
								HPL 1	HPL 2	HPL 3
Adjustable Mobile Stand	22	24	29	36	14	LK-29ISA-2224T	\$1,717	\$1,817	\$1,830	\$1,874



Features:

- pneumatic height adjustment range 29" - 41"

Options:

- specify caster color option, Black (BL) or White with Grey Wheels (WG)
- specify grommet; None (GN) or tablet and cup holder grommets (GY) add \$86 list

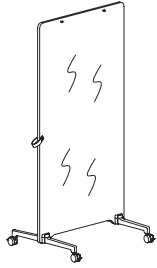
To Order Specify

① Model #	② Chasis	③ Grommet	④ Caster	⑤ Metal Finish
Model (LK)	See Laminate Selection	GN No Grommet GY Tablet and Cup Holder Grommet	C Caster - BL Black Caster - WG White Caster w/Grey Wheels	See Metal Finish Color Options

Model Number Breakdown

LK-PDL-2224					
LK	PD	L	22	24	
Lok	Podium	Left	22" Depth	24" Wide	

Description	D	W	H	CTN WT	CU FT	Model	List Price
Marker Board Mobile Screen	27	36	72	75	13	LKB-MS-3672M	\$1,667
	27	48	72	95	16	LKB-MS-4872M	\$1,893



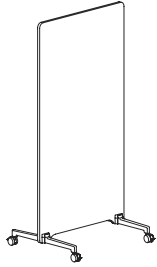
Features:

- marker board HPL on both surfaces
- capable for hanging flip charts on both sides

Options:

- specify caster color option, Black (BL) or White caster with Grey (WG)

Mobile Laminate Screen	27	36	72	75	13	LKB-MS-3672T	\$1,097
	27	48	72	95	16	LKB-MS-4872T	\$1,154



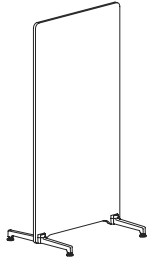
Features:

- laminate on both surfaces

Options:

- specify caster color option, Black (BL) or White caster with Grey (WG)

Fixed Laminate Screen	27	36	72	75	13	LKB-FS-3672T	\$983
	27	48	72	95	16	LKB-FS-4872T	\$1,047



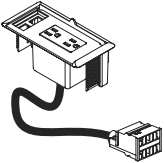
Features:

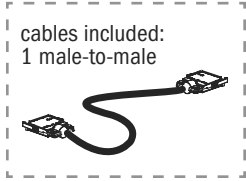
- laminate on both surfaces
- black leveling glides

Model Number Breakdown

LKB-MS-3672M						
LKB	MS	36	72	M		
Lok	Mobile Screen	36" Wide	72" Height	Markerboard		


ECONO Power

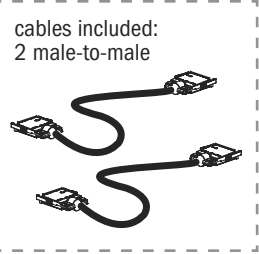
Description	D	W	H	CTN WT	CU FT	① Model	List Price
Electrical CT1 for Econo 	36			4	1	EC-E-CT1-36	\$266
	48			4	1	EC-E-CT1-48	\$270
	60			4	1	EC-E-CT1-60	\$272
	66			4	1	EC-E-CT1-66	\$276
	72			5	1	EC-E-CT1-72	\$278
	84			5	1	EC-E-CT1-84	\$290
	96			5	1	EC-E-CT1-96	\$292



Features:

- (1) econo electrical unit to be placed in top of surface
- use in conjunction with other econo electrical items
- table link bracket MUST be used in conjunction with electrical to meet code requirements
- data jack openings accepts Type 2 jacks - two .58 x .76 hole openings (customer supplied)
- must order power infeed separately

Electrical LRT2 for Econo 	66			7	1	EC-E-LRT2-66	\$529
	72			7	1	EC-E-LRT2-72	\$529
	84			8	1	EC-E-LRT2-84	\$529
	96			8	1	EC-E-LRT2-96	\$533



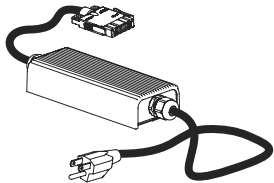
Features:

- (2) econo electrical unit to be placed in top of surface
- use in conjunction with other econo electrical items
- data jack openings accepts Type 2 jacks - two .58 x .76 hole openings (customer supplied)
- must order power infeed separately

Options:

- specify color black (BL) or grey (SG)

3 Prong Plug - 110 Power Smart-box Infeed for Econo System				1	1	EC-PI-E-72A	\$519
--	--	--	--	---	---	-------------	-------



Features:

- 72" plug power infeed
- 20 amps/110 volts max
- 3 prong plug - 15 amp adapter plug
- single circuit use only
- use in conjunction with other econo electrical items

Electrical Jumper for Econo System	84			3	1	EC-E-J-84	\$125
------------------------------------	----	--	--	---	---	-----------	-------

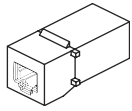


Features:

- use to jump power around a corner configuration
- one male and one female H-block cable end

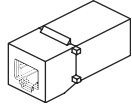
Data Jacks for ECONO

Description	D	W	H	CTN WT	CU FT	① Model	List Price
Telecom Phone Jack - Type 2				1	1	TCP201	\$67

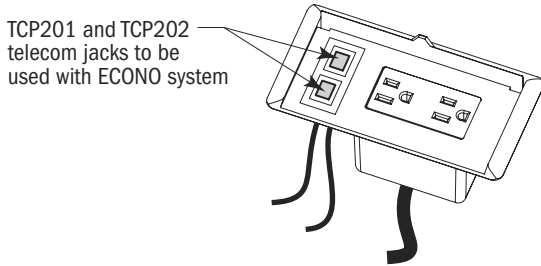


- Features:**
- RJ-11 phone jack
 - for use with Econo system

Telecom Data Jack - Type 2				1	1	TCP202	\$89
----------------------------	--	--	--	---	---	--------	------

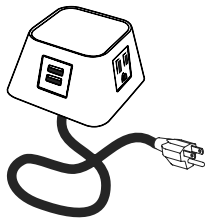


- Features:**
- CAT6-RJ45 data jack
 - for use with Econo system



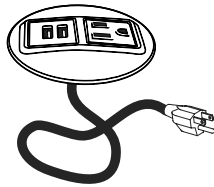
Corded Power

Description	D	W	H	CTN WT	CU FT	① Model	List Price
Moire Power Unit	3 3/8	3 3/8	2	5	1	EC23	\$481



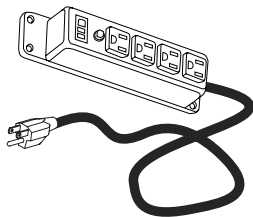
- Features:**
- three 110 outlets
 - dual USB-A charging ports
 - 72" 3-prong - 15amp plug power feed
 - 15amp/110 volt
- Options:**
- specify Black(BL) or White(WH)

Node Power Unit	3 3/8	3 3/8	3/8	5	1	EC24	\$384
-----------------	-------	-------	-----	---	---	------	-------



- Features:**
- one 110 outlet
 - dual USB-A charging ports
 - 72" 3-prong - 15amp plug power feed
 - 15amp/110 volt
- Options:**
- specify Black(BL) or White(WH)

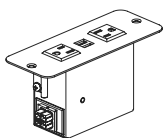
Power Strip	1 1/2	1 7/8	8	3	1	GP9ACP1-0212	\$93
-------------	-------	-------	---	---	---	--------------	------



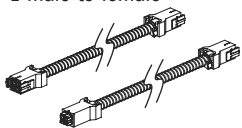
- Features:**
- power surge with 10" cord
 - four electrical outlets
 - includes switch
 - field installed
 - use in conjunction with other econo electrical items

LINK Power

Description	D	W	H	CTN WT	CU FT	① Model	List Price
Electrical CT1 for Link	36			4	1	EC-L-CT1-36	\$588
	48			4	1	EC-L-CT1-48	\$598
	60			4	1	EC-L-CT1-60	\$610
	66			4	1	EC-L-CT1-66	\$615
	72			5	1	EC-L-CT1-72	\$621
	84			5	1	EC-L-CT1-84	\$633
	96			5	1	EC-L-CT1-96	\$645



cables included:
1 female-to-female
1 male-to-female



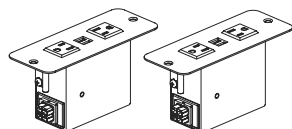
Features:

- (1) link electrical unit to be placed in top of surface
- use in conjunction with other link electrical items
- table link bracket **MUST** be used in conjunction with electrical to meet code requirements

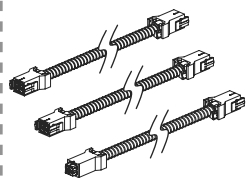
Options:

- specify circuit (C1 or C2); specify color black (BL) or white (WH)
- must order power infeed separately

Electrical LRT2 for Link	66			7	1	EC-L-LRT2-66	\$1,078
	72			7	1	EC-L-LRT2-72	\$1,073
	84			8	1	EC-L-LRT2-84	\$1,084
	96			8	1	EC-L-LRT2-96	\$1,096



cables included:
2 female-to-female
1 male-to-female



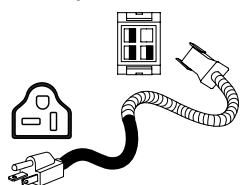
Features:

- (2) link electrical unit to be placed in top of surface
- use in conjunction with other link electrical items
- circuit 1 - 8 units can be connected on 3 prong infeed
- circuit 1 & 2 - 16 units (8) circuit 1 & (8) circuit 2 on hardwire or quick disconnect infeed options

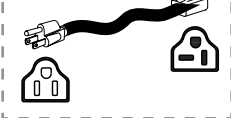
Options:

- specify circuit (C1 or C2); specify color black (BL) or white (WH)
- must order power infeed separately

3 Prong Plug - 110 Power Infeed for Link System	72			1	1	EC-PI-L-72-A	\$271
---	----	--	--	---	---	--------------	-------



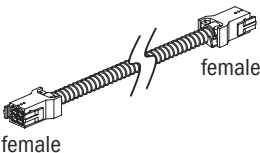
plug included:
15 amp adapter



Features:

- 72" plug power infeed
- 20 amps/110 volts max
- 3 prong plug - 15 amp adapter plug
- single circuit use only
- use in conjunction with other link electrical items

Quick Disconnect Power Infeed for Link System				1	1	EC-PI-L-72-QD	\$227
---	--	--	--	---	---	---------------	-------

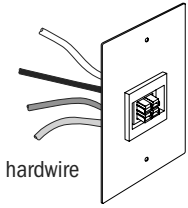


Features:

- must be used with QD1
- 72" modular power infeed
- 20 amps/120 volts max
- works for both single or double circuit
- use in conjunction with other link electrical items

LINK Power

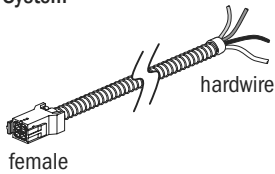
Description	D	W	H	CTN WT	CU FT	Model	List Price
Quick Disconnect Wall Outlet for Link System				1	1	EC-L-QD1	\$116



Features:

- must be used with MP72
- works for both single or double circuit
- 20 amps/120 volts max
- electrical contractor responsible for connection to building power source
- use in conjunction with other link electrical items

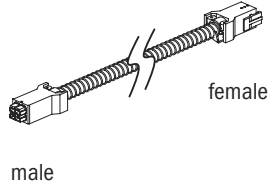
Hardwire Power Infeed for Link System	72			1	1	EC-PI-L-72-H	\$176
---------------------------------------	----	--	--	---	---	--------------	-------



Features:

- 72" hardwire power infeed
- 20 amps/120 volts max
- single or two circuit
- electrical contractor responsible for connection to building power source
- use in conjunction with other link electrical items

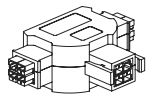
Electrical Jumper for Link System	12			2	1	EC-L-J-12	\$112
-----------------------------------	----	--	--	---	---	-----------	-------



Features:

- use to jump power around a corner configuration
- use with Link EC-L-3W 3 way electrical connector when additional cable is required
- one male and one female cable end

3 way electrical connector for Link System				1	1	EC-L-3W	\$180
--	--	--	--	---	---	---------	-------

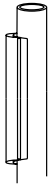


Features:

- branches power for infeed or T-connection
- two male and one female connector plugs
- may require repositioning of jumper cables

Wire Management

Description	D	W	H	CTN WT	CU FT	① Model	List Price
Vertical Wire Manager	2	2 ¼	17	1	1	AVL17	\$80
	2	2 ¼	22	1	1	AVL20	\$85
	2	2 ¼	25	1	1	AVL25	\$104



Features:

- field installed
- use AVL17 for 29" h tables
- use AVL20 for 36" h tables
- use AVL25 for 42" h tables

Options:

- specify plastic color, Black (B) or Silver (S)

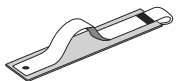
Flexible Vertical Wire Manager	1 ½	1 ½	45	4	1	45VWM	\$131
--------------------------------	-----	-----	----	---	---	-------	-------



Features:

- black plastic
- field installed to bottom of table top, with screws provided
- wire manager is 1 ½" diameter
- weighted base is 4" diameter
- length can be adjusted by removing individual discs as required

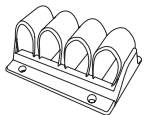
Wire Management Velcro Straps	1 ¾	3 ½	¼	1	1	04WVS	\$56
-------------------------------	-----	-----	---	---	---	-------	------



Features:

- black, set of 4
- field installed to bottom of table top, with adhesive tape provided

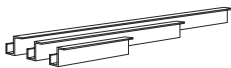
Cable Management Clips	2 ⅝	3 ¾	1 ⅝	1	1	0304CMC	\$54
------------------------	-----	-----	-----	---	---	---------	------



Features:

- black plastic
- installed to bottom of table top
- four retention loops

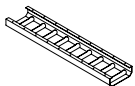
Wire Manager Trough	2 ½	12	2 ½	2	1	12WCT	\$119
	2 ½	24	2 ½	3	1	24WCT	\$138
	2 ½	36	2 ½	4	1	36WCT	\$152



Features:

- black plastic
- field installed to bottom of table top, with screws provided

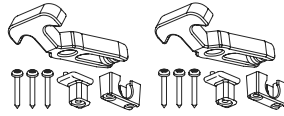
Wire Management Tray	7 ½	25	3	4	1	GP9WMT1-0825	\$185
	7 ½	35	3	6	1	GP9WMT1-0835	\$228
	7 ½	45	3	8	2	GP9WMT1-0845	\$270



Features:

- silver powder-coated finish
- four hanging brackets (C12C00)

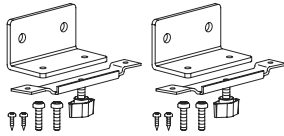
Description	D	W	H	CTN WT	CU FT	Model	List Price
Table Link Bracket	2 ¾	3	7	1	1	LKB03TBL-LINK	\$60



Features:

- includes set of 2 brackets with attachment hardware
- can be installed on ends and approach edges of tables
- field installed
- MUST be used tables specifying electrical

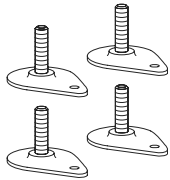
Screen Link Bracket	1 ¾	2 ¾	1 ½	1	1	LKB03SCN-LINK	\$72
---------------------	-----	-----	-----	---	---	---------------	------



Features:

- links two tables along one edge with screen between tables
- set of 2 with attachment hardware
- field installed

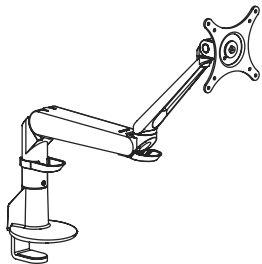
Floor Mount Glide	3	2 ¼	½	1	1	LKB38-16ANCHOR	\$39
-------------------	---	-----	---	---	---	----------------	------



Features:

- field installed glides for mounting table base to floor
- ¼" diameter hole in the glide for mounting
- set of 4
- replaces standard leveling glide
- note: floor mounting hardware to be supplied by installer

Single Monitor Arm	4	11	10	9	1	GP5901MA	\$688
--------------------	---	----	----	---	---	----------	-------



Features:

- one-touch reposition monitor adjustment
- tension adjustment at each joint
- flat panel mount rotates for portrait or landscape viewing
- edge mount installation from above surface
- cable management routes cables below monitor arm
- quick install VESA mount adapter

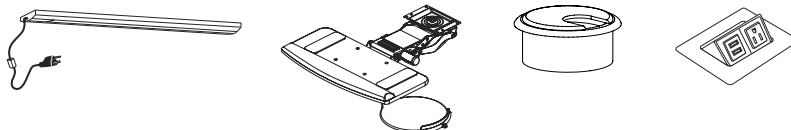
Options:

- specify Black (B) or Silver (S)

Accessories/ Keyboard/ Tasklights

For an additional list of electrical units, grommets, keyboards, wire management, monitor arms & telecom jacks, please see our [accessories price list](#)

Contact your customer service representative for specific questions regarding which units can be used with Lok Training.



Page left intentionally blank



Training



Teamwork



Conference



Lounge

LOK - TEAMWORK

Lok - Teamwork

Product Information

Teamwork Overview 86
 Tables Shapes & Sizes 88-91
 Laminate Specifications 92
 Veneer Specifications 93
 Base Styles - Features 94
 Electrical Planning - Options 95

Pricing Pages

Teamwork Tables at Working Height . . . 96-129
 Teamwork Tables at Counter Height . . . 130-133
 Teamwork Tables at Bar Height 134-167
 Electrical 168-169

Teamwork - Overview



rectangular
29"H - Pages 68, 72
36"H - Pages 116, 120
42"H - Pages 164, 168



rounded rectangular
29"H - Pages 70, 74
36"H - Pages 118, 122
42"H - Pages 166, 170



arc rectangular
29"H - Pages 76
36"H - Pages 124
42"H - Pages 172



rounded arc rectangular
29"H - Pages 78
36"H - Pages 126
42"H - Pages 174



racetrack
29"H - Pages 80
36"H - Pages 128
42"H - Pages 176



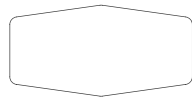
oval
29"H - Pages 82
36"H - Pages 130
42"H - Pages 178



boat
29"H - Pages 84
36"H - Pages 132
42"H - Pages 180



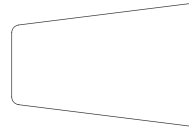
rounded boat
29"H - Pages 86
36"H - Pages 134
42"H - Pages 182



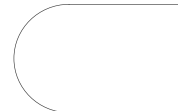
rounded double chevron
29"H - Pages 88
36"H - Pages 136
42"H - Pages 184



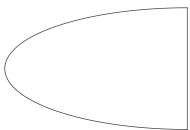
taper
29"H - Pages 90
36"H - Pages 138
42"H - Pages 186



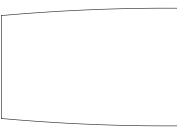
rounded taper
29"H - Pages 92
36"H - Pages 138
42"H - Pages 184



bullet
29"H - Pages 94
36"H - Pages 142
42"H - Pages 190



hive
29"H - Pages 96
36"H - Pages 144
42"H - Pages 192



wedge
29"H - Pages 112
36"H - Pages 160
42"H - Pages 208



rounded wedge
29"H - Pages 114
36"H - Pages 162
42"H - Pages 210

Teamwork - Top Shapes

Lok offers 24 teamwork table top shapes. Tables are available in 29", 36" or 42" high and in laminate or veneer. Compatible bases are: T Base or X Base



rectangular

29"h

36" x 60" Seats 4
 36" x 66" Seats 6
 36" x 72" Seats 6
 42" x 72" Seats 6
 48" x 72" Seats 6

36"h

36" x 60" Seats 4
 36" x 66" Seats 6
 36" x 72" Seats 6
 42" x 72" Seats 6
 48" x 72" Seats 6

42"h

36" x 60" Seats 4
 36" x 66" Seats 6
 36" x 72" Seats 6
 42" x 72" Seats 6
 48" x 72" Seats 6



rounded rectangular

29"h

36" x 60" Seats 4
 36" x 66" Seats 6
 36" x 72" Seats 6
 42" x 72" Seats 6
 48" x 72" Seats 6

36"h

36" x 60" Seats 4
 36" x 66" Seats 6
 36" x 72" Seats 6
 42" x 72" Seats 6
 48" x 72" Seats 6

42"h

36" x 60" Seats 4
 36" x 66" Seats 6
 36" x 72" Seats 6
 42" x 72" Seats 6
 48" x 72" Seats 6



arc rectangular

29"h

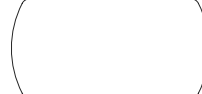
36" x 60" Seats 4
 36" x 66" Seats 6
 36" x 72" Seats 6
 42" x 72" Seats 6
 48" x 72" Seats 6

36"h

36" x 60" Seats 4
 36" x 66" Seats 6
 36" x 72" Seats 6
 42" x 72" Seats 6
 48" x 72" Seats 6

42"h

36" x 60" Seats 4
 36" x 66" Seats 6
 36" x 72" Seats 6
 42" x 72" Seats 6
 48" x 72" Seats 6



rounded arc rectangular

29"h

36" x 60" Seats 4
 36" x 66" Seats 6
 36" x 72" Seats 6
 42" x 72" Seats 6
 48" x 72" Seats 6

36"h

36" x 60" Seats 4
 36" x 66" Seats 6
 36" x 72" Seats 6
 42" x 72" Seats 6
 48" x 72" Seats 6

42"h

36" x 60" Seats 4
 36" x 66" Seats 6
 36" x 72" Seats 6
 42" x 72" Seats 6
 48" x 72" Seats 6



racetrack

29"h

36" x 60" Seats 4
 36" x 66" Seats 6
 36" x 72" Seats 6
 42" x 72" Seats 6
 48" x 72" Seats 6

36"h

36" x 60" Seats 4
 36" x 66" Seats 6
 36" x 72" Seats 6
 42" x 72" Seats 6
 48" x 72" Seats 6

42"h

36" x 60" Seats 4
 36" x 66" Seats 6
 36" x 72" Seats 6
 42" x 72" Seats 6
 48" x 72" Seats 6



oval

29"h

36" x 72" Seats 6

36"h

36" x 72" Seats 6

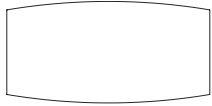
42"h

36" x 72" Seats 6

Teamwork - Top Shapes

Lok offers 24 teamwork table top shapes. Tables are available in 29", 36" or 42" high and in laminate or veneer. Compatible bases are: T Base or X Base

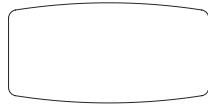
LOK - TEAMWORK



boat
29"h
36" x 60" Seats 4
36" x 66" Seats 6
36" x 72" Seats 6
42" x 72" Seats 6
48" x 72" Seats 6

36"h
36" x 60" Seats 4
36" x 66" Seats 6
36" x 72" Seats 6
42" x 72" Seats 6
48" x 72" Seats 6

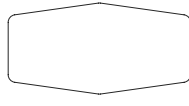
42"h
36" x 60" Seats 4
36" x 66" Seats 6
36" x 72" Seats 6
42" x 72" Seats 6
48" x 72" Seats 6



rounded boat
29"h
36" x 60" Seats 4
36" x 66" Seats 6
36" x 72" Seats 6
42" x 72" Seats 6
48" x 72" Seats 6

36"h
36" x 60" Seats 4
36" x 66" Seats 6
36" x 72" Seats 6
42" x 72" Seats 6
48" x 72" Seats 6

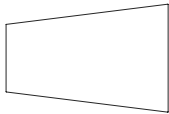
42"h
36" x 60" Seats 4
36" x 66" Seats 6
36" x 72" Seats 6
42" x 72" Seats 6
48" x 72" Seats 6



rounded double chevron
29"h
36" x 60" Seats 4
36" x 72" Seats 6
42" x 72" Seats 6
48" x 72" Seats 6

36"h
36" x 60" Seats 4
36" x 72" Seats 6
42" x 72" Seats 6
48" x 72" Seats 6

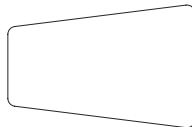
42"h
36" x 60" Seats 4
36" x 72" Seats 6
42" x 72" Seats 6
48" x 72" Seats 6



taper
29"h
48" x 72" Seats 6

36"h
48" x 72" Seats 6

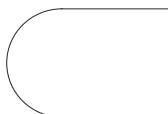
42"h
48" x 72" Seats 6



rounded taper
29"h
48" x 72" Seats 6

36"h
48" x 72" Seats 6

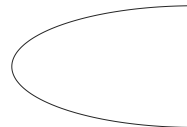
42"h
48" x 72" Seats 6



bullet
29"h
48" x 72" Seats 6

36"h
48" x 72" Seats 6

42"h
48" x 72" Seats 6



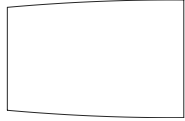
hive
29"h
48" x 72" Seats 6

36"h
48" x 72" Seats 6

42"h
48" x 72" Seats 6

Teamwork - Top Shapes cont.

Lok offers 24 teamwork table top shapes. Tables are available in 29", 36" or 42" high and in laminate or veneer. Compatible bases are: T Base or X Base



wedge

29"h

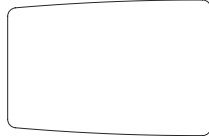
48" x 72" Seats 6

36"h

48" x 72" Seats 6

42"h

48" x 72" Seats 6



rounded wedge

29"h

48" x 72" Seats 6

36"h

48" x 72" Seats 6

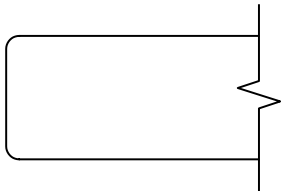
42"h

48" x 72" Seats 6

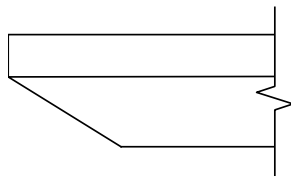
Teamwork - Materials

Laminate Tops

HPL tops are 1 3/16" thick, 3 ply balanced construction. The laminate face is horizontal grade high pressure laminate. Particle board core and a phenolic backer sheet complete the balanced construction.



Eased Edge (R3)
PVC



Reverse Bevel (K9)
PVC on painted top of painted MDF

Standard PVC Edge Colors

JSI supports 24 standard PVC edge colors listed below. These coordinate with our Standard (Tier1) Laminates.

When selecting a Standard (Tier 1) Laminate, the coordinating PVC edge color is automatically applied. When selecting a Graded-In Laminate (Tier 2 or 3), you will be prompted to choose one these 24 PVC edge colors to be applied to the edge.

ALB Alabaster	GRH Graphite
ALL Ale Light	MIN Mineral
BLK Black	OAT Oatmeal Cookie
BOL Bourbon Light	PIN Pinnacle Walnut
BZW Brazilwood	PLT Platinum
BBL Bridal Blanco	SHD Shadow
BGL Brighton Light	SLG Slate Grey
CLL Collectors	STU Studio Teak
DWH Designer White	UMB Umber
DOV Dove Grey	VAL Valley
FAW Fawn	VIN Vintage
FLO Florence Walnut	WEA Weathered Ash

Standard Laminates

JSI Standard Laminate program consists of 22 solid and wood grain patterns, and establish our Tier 1 laminate pricing. Each has a coordinating PVC edge color that is automatically used with the Standard Laminates.

Wood Grain Laminate

ALL Ale Light	MIN Mineral
BOL Bourbon Light	OAT Oatmeal Cookie
BZW Brazilwood	PIN Pinnacle Walnut
BGL Brighton Light	STU Studio Teak
CLL Collectors	UMB Umber
FAW Fawn	VAL Valley
FLO Florence Walnut	VIN Vintage
GRH Graphite	WEA Weathered Ash

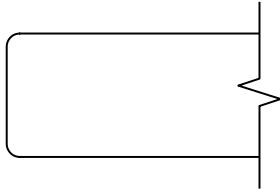
Solid Laminate

ALB Alabaster
BLK Black
BBL Bridal Blanco
DWH Designer White
SHD Shadow
SLG Slate Grey

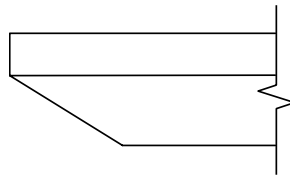
Teamwork - Materials cont.

Veneer Tops

Tops are 1 3/4" thick, 5 ply balanced construction with particle board core. Standard Tier 1 veneer is flat cut, book matched for cherry, maple and walnut veneer. Standard Tier 2 veneer is double cut.



Eased Edge (R3)
Internal Lumber Band



Reverse Bevel (K9)
Veneer Band on Stained MDF

Finish - Stain/Colors

CH1 Cherry	<i>Flat Cut Veneer</i>		
BBM Bourbon Medium		CLL Collectors	
BRM Brighton Medium		HRV Harvest	
CLA Classic		PRL Praline	

MA1 Maple	<i>Flat Cut Veneer</i>		
ALM Ale Medium		FLX Flax	
BUT Butterscotch		VEN Venetian	

WA1 Walnut	<i>Flat Cut Veneer</i>		
ESP Espresso		TRF Truffle	
MCH Mocha		UMB Umber	
SIE Sienna			

B01 Black Oak	<i>Flat Cut Veneer</i>		
RAV Raven			

DC1 Double Cut Veneer			
BAR Barrel - Oak Pattern		KHK Khaki	
BUF Buff - Oak Pattern		MIN Mineral - Oak Pattern	
CND Cinder - Oak Pattern		RYE Rye - Oak Pattern	
COF Coffee		SAB Sable - Oak Pattern	
EGR Egret		SAD Saddle - Oak Pattern	
FAW Fawn		STU Studio Teak	
GRH Graphite		VAL Valley	

Protective Top Coat

DuraTex™ offers exceptional hardness along with abrasion and impact resistance, it has been formulated to eliminate hazardous and harmful gases that are normally associated with wood finish.

DuraTex™ Features

Safety - Significantly reduces hazardous formaldehyde emissions which help improve the quality of the of the indoor air we breathe.

Quality - Developed to be tough and durable with special attention to appearance. The DuraTex™ finish preserves the natural beauty of wood.

Durability - Designed to meet a wide range of demanding performance and environmental standards to withstand even the highest wear and tear.

Special Finishes

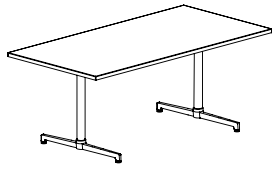
Special finishes can be requested by contacting customer service. There is a one time charge of \$372 list per order.

Finish Sheen

All veneer finishes are standard in 35-sheen, with the exception of Raven. Raven is only offered in 15 sheen. All other finishes can have their sheen modified with a 15% upcharge added to the list price of each item.

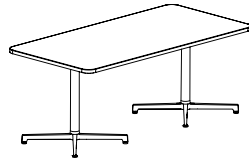
Teamwork - Base Styles

Lok provides a choice selection of bases in both function and aesthetics to serve a variety of needs. The teamwork offering includes: T-base and X-base



T-Base

- available in 29" with options of glide or caster
- available in 36"h and 42"h only in glides
- compatible with the following top shapes: arc rectangular, boat, boomerang, bullet, double chevron, hive, home base, huddle, intersect, one-twenty, racetrack, rectangular, taper, wedge
- base finish aged bronze, arctic silver, gold, pewter, matte black, soft bronze, soft nickel
- two-tone base aesthetics are achieved when selecting polished aluminum foot, and then any of the other finishes on the column



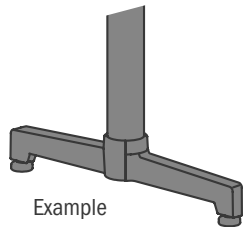
X-Base

- available in 16", 29"h, 36"h or 42"h only in glides.
- compatible with the following top shapes: rectangular, round, square, squircle
- base finish aged bronze, arctic silver, gold, pewter, matte black, soft bronze, soft nickel
- two-tone base aesthetics are achieved when selecting polished aluminum foot, and then any of the other finishes on the column

LOK - TEAMWORK

Single Metal Finish

- ABZ** Aged Bronze Feet & Post
- ASL** Arctic Silver Feet & Post
- GLD** Gold Feet & Post
- PEW** Pewter Feet & Post
- MBK** Matte Black Feet & Post
- SBZ** Soft Bronze Feet & Post
- SNK** Soft Nickel Feet & Post



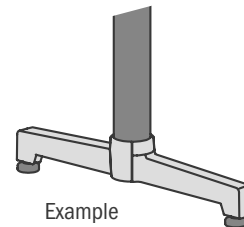
Example

Two - Tone Metal Finish

Two- Tone Aesthetics can be achieved by specifying Polished Aluminum on the foot and a contrasting finish on the post

Polished Aluminum Feet

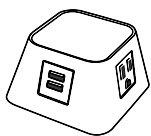
- ABZ** - Aged Bronze Post
- ASL** - Arctic Silver Post
- GLD** - Gold Post
- PEW** - Pewter Post
- MBK** - Matte Black Post
- SBZ** - Soft Bronze Post
- SNK** - Soft Nickel Post



Example

Power/Charging Options

Lok offers the ability to place power and charging options in the center of select tables. Select your choice of EC23 or EC24, available in black and white.



Moire - EC23

- Three 110 outlets
- Dual USB port with 72" power cord
- Black (B) or White (W)

select CTEC23 for cutout in worksurfaces

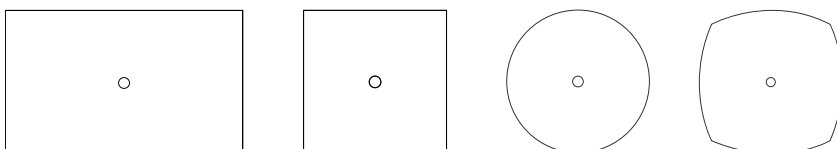


Node - EC24

- One 110 outlet
- Dual USB port with 72" power cord
- Black (B) or White (W)

select CTEC24 for cutout in worksurfaces

Cut outs are located in the center of each table. See below for representation or location.

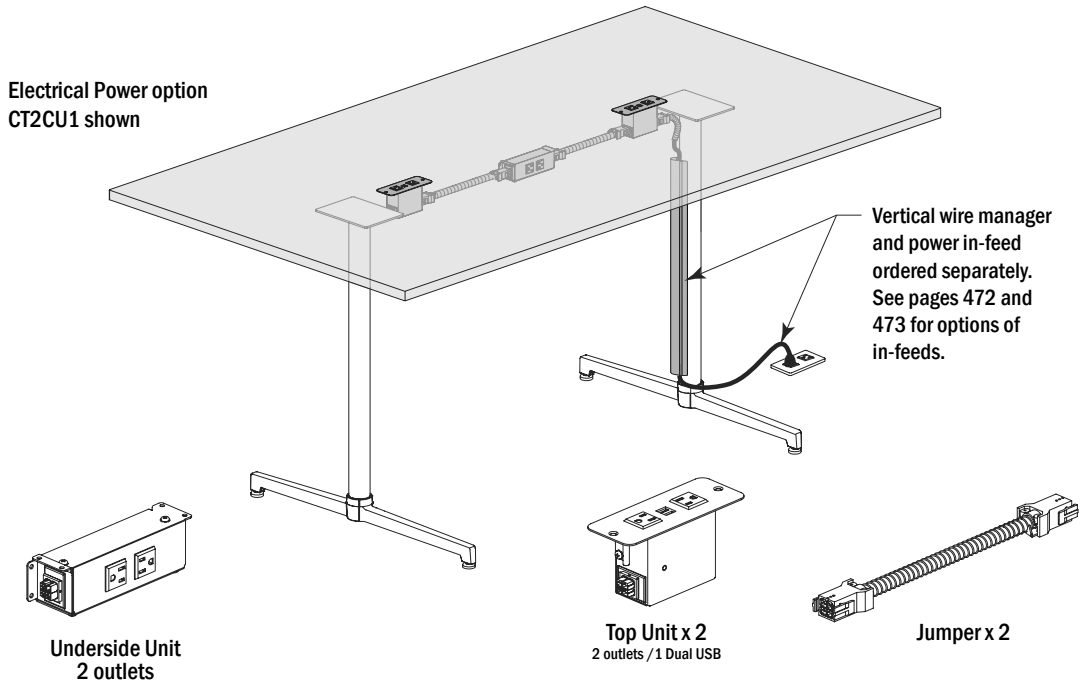


Teamwork - Electrical

Electrical Overview

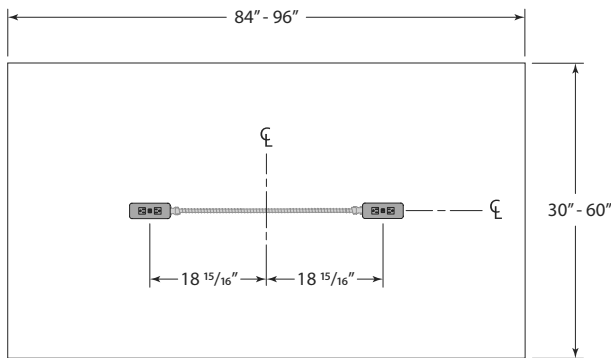
Lok provides several packages to choose from for your electrical needs. Choose solutions for top surface power, underneath outlets, wireless charging, or a combination.

Specifying an electrical package eliminates your need to calculate additional components, as all units and necessary jumpers will ship with your table. You will only need to determine which power in-feed best suits your needs and order separately.



Electrical

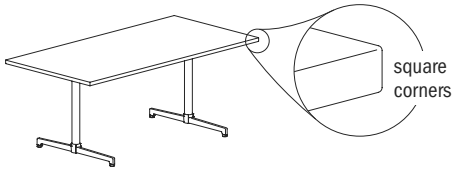
Power and Charging Packages are measured and located out from the center of the table. Shown on rectangular tops, these dimensions are the same from center regardless of table shape (ie huddle, boomerang, etc.). Power in-feed is specified separately to support building electrical connection.



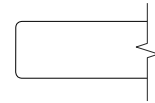
CT2 - Dual Power Top of Surface

Description

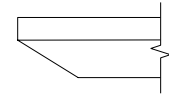
Rectangular Table with T Base at Working Height



Laminate Tables "LKT" Models



Eased Edge (R3)



Reverse Bevel Edge (K9)

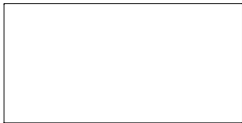
LAMINATE	D	W	H	CTN WT	CU FT	Model	Standard			Graded In		
							Tier 1	Tier 2	Tier 3	Tier 1	Tier 2	Tier 3
	48	72	29	148	71	LKT4872-29TTT	\$2,082	\$2,127	\$2,403	\$2,603	\$2,647	\$2,845
42	72	29	143	63	LKT4272-29TTT	\$1,982	\$2,020	\$2,264	\$2,490	\$2,528	\$2,703	
36	72	29	132	56	LKT3672-29TTT	\$1,809	\$1,878	\$2,028	\$2,265	\$2,333	\$2,482	
36	66	29	123	51	LKT3666-29TTT	\$1,744	\$1,809	\$1,946	\$2,200	\$2,265	\$2,401	
36	60	29	115	46	LKT3660-29TTT	\$1,667	\$1,729	\$1,849	\$2,121	\$2,182	\$2,305	

Features:

- price reflects complete table - top and base
- ships KD in multiple cartons

Options:

- specify power/charging option, see below for options and upcharges
- specify glide (G) or caster (C) -choice of black (BL) or white/grey casters (WG)



top shape

LOK - TEAMWORK

To Order Specify

1 Laminate Model #	2 Edge Detail	3 Laminate Selection	3a PVC Edge Color	4 Electrical
Laminate (LKT)	See Edge Detail Options	See Laminate Selection	See PVC Edge Color Options	<p>N None</p> <p>CT2 Dual Power Center Top (See chart on next page)</p> <p>CU1 Single Power Underside</p>
				5 Foot/Caster
				<p>G Glide</p> <p>C Caster</p> <ul style="list-style-type: none"> - BL Black Caster - WG White Caster w/ Grey Wheels
				6 Metal Finish
				See Metal Finish Color Options

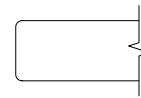
Model Number Breakdown

LKT4872-29TTT					
LK	T	4872	29	TT	T
LOK	Laminate	48" x 72"	Height	Rectangular Top Shape	T base

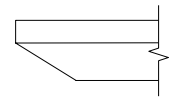
Description

Rectangular Table with T Base
at Working Height
(continued)

Veneer Tables
"LKV" Models



Eased Edge (R3)



Reverse Bevel Edge (K9)

VENEER	D	W	H	CTN WT	CU FT	① Model	Flat Cut	Double Cut	Flat Cut	Double Cut
		48	72	29	148	71	LKV4872-29TTT	\$2,400	\$2,632	\$2,652
	42	72	29	143	63	LKV4272-29TTT	\$2,291	\$2,499	\$2,535	\$2,722
	36	72	29	132	56	LKV3672-29TTT	\$2,113	\$2,314	\$2,288	\$2,485
	36	66	29	123	51	LKV3666-29TTT	\$2,069	\$2,255	\$2,239	\$2,421
	36	60	29	115	46	LKV3660-29TTT	\$2,007	\$2,181	\$2,171	\$2,342

LOK - TEAMWORK

Electrical Options and Upcharges

CT2	
Dual Power Center Top - Black	CT2BL - add \$1,437
Dual Power Center Top - White	CT2WH - add \$1,437
CU1	
Single Power Underside - Black	CU11C - add \$559
Single Power Underside with Wireless Charging- Black	CU11CW - add \$1,338

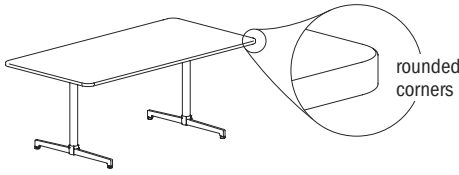
Note: Order power infeed that best fits application

To Order, Specify:

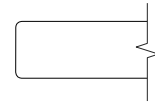
① Veneer Model #	② Edge Detail	③ Wood Species	④ Top Wood Finish	⑤ Electrical	⑥ Base - Foot/Caster	⑦ Metal Color
Veneer (LKV)	See Edge Detail Options	Flat Cut BO1 Black Oak CH1 Cherry MA1 Maple WA1 Walnut	See Flat Cut Top Wood Finish Options	N None CT2 Dual Power Center Top CU1 Single Power Underside (See chart above)	G Glide C Caster - BL Black Caster - WG White Caster with Grey Wheels	See Metal Finish Color Options
			Double Cut DC1 Double Cut			

Description

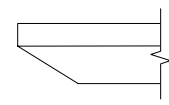
Rounded Rectangular Table with T Base at Working Height



Laminate Tables "LKT" Models



Eased Edge (R3)



Reverse Bevel Edge (K9)

LAMINATE	D	W	H	CTN WT	CU FT	Model	Standard			Graded In		
							Tier 1	Tier 2	Tier 3	Tier 1	Tier 2	Tier 3
	48	72	29	148	71	LKT4872-29TTRT	\$2,143	\$2,187	\$2,463	\$2,663	\$2,709	\$2,904
42	72	29	143	63	LKT4272-29TTRT	\$2,039	\$2,076	\$2,319	\$2,547	\$2,587	\$2,759	
36	72	29	132	56	LKT3672-29TTRT	\$1,908	\$1,979	\$2,127	\$2,364	\$2,433	\$2,581	
36	66	29	123	51	LKT3666-29TTRT	\$1,849	\$1,915	\$2,050	\$2,305	\$2,371	\$2,505	
36	60	29	115	46	LKT3660-29TTRT	\$1,779	\$1,841	\$1,961	\$2,235	\$2,299	\$2,416	

Features:

- price reflects complete table - top and base
- ships KD in multiple cartons

Options:

- specify power/charging option, see below for options and upcharges
- specify glide (G) or caster (C) -choice of black (BL) or white/grey casters (WG)



top shape

LOK - TEAMWORK

To Order Specify

1 Laminite Model #	2 Edge Detail	3 Laminite Selection	3a PVC Edge Color	4 Electrical
Laminite (LKT)	See Edge Detail Options	See Laminite Selection	See PVC Edge Color Options	N None CT2 Dual Power Center Top (See chart on next page) CU1 Single Power Underside 5 Foot/Caster G Glide C Caster - BL Black Caster - WG White Caster w/Grey Wheels 6 Metal Finish See Metal Finish Color Options

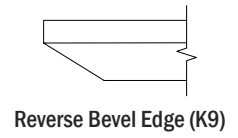
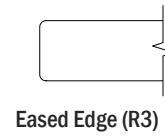
Model Number Breakdown

LKT4872-29TTRT						
LK	T	4872	29	TT	R	T
LOK	Laminite	48" x 72"	Height	Rectangular Top Shape	Rounded Corner	T base

Description

Rounded Rectangular Table with T Base at Working Height (continued)

Veneer Tables "LKV" Models



VENEER	D	W	H	CTN WT	CU FT	① Model	Flat Cut	Double Cut	Flat Cut	Double Cut
		48	72	29	148	71	LKV4872-29TTRT	\$2,462	\$2,694	\$2,714
	42	72	29	143	63	LKV4272-29TTRT	\$2,350	\$2,556	\$2,591	\$2,779
	36	72	29	132	56	LKV3672-29TTRT	\$2,271	\$2,482	\$2,357	\$2,557
	36	66	29	123	51	LKV3666-29TTRT	\$2,224	\$2,421	\$2,308	\$2,491
	36	60	29	115	46	LKV3660-29TTRT	\$2,158	\$2,342	\$2,238	\$2,408

LOK - TEAMWORK

Electrical Options and Upcharges

CT2	
Dual Power Center Top - Black	CT2BL - add \$1,437
Dual Power Center Top - White	CT2WH - add \$1,437
CU1	
Single Power Underside - Black	CU11C - add \$559
Single Power Underside with Wireless Charging- Black	CU11CW - add \$1,338

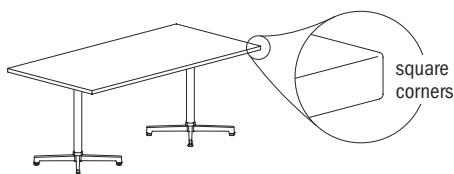
Note: Order power infeed that best fits application

To Order, Specify:

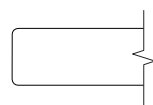
① Veneer Model #	② Edge Detail	③ Wood Species	④ Top Wood Finish	⑤ Electrical	⑥ Base - Foot/Caster	⑦ Metal Color
Veneer (LKV)	See Edge Detail Options	Flat Cut BO1 Black Oak CH1 Cherry MA1 Maple WA1 Walnut	See Flat Cut Top Wood Finish Options	N None CT2 Dual Power Center Top CU1 Single Power Underside (See chart above)	G Glide C Caster - BL Black Caster - WG White Caster with Grey Wheels	See Metal Finish Color Options
		Double Cut DC1 Double Cut	④ Top Wood Finish See Double Cut Top Wood Finish Options			

Description

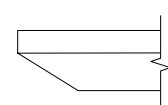
Rectangular Table with X Base at Working Height



Laminate Tables "LKT" Models



Eased Edge (R3)



Reverse Bevel Edge (K9)

LAMINATE	D	W	H	CTN WT	CU FT	Model	Eased Edge (R3)			Reverse Bevel Edge (K9)		
							Standard	Graded In		Standard	Graded In	
							Tier 1	Tier 2	Tier 3	Tier 1	Tier 2	Tier 3
	48	72	29	163	71	LKT4872-29TTX	\$2,687	\$2,731	\$3,009	\$3,208	\$3,251	\$3,449
	42	72	29	147	63	LKT4272-29TTX	\$2,587	\$2,626	\$2,865	\$3,096	\$3,135	\$3,307
	36	72	29	130	55	LKT3672-29TTX	\$2,367	\$2,437	\$2,587	\$2,822	\$2,891	\$3,041

Features:

- price reflects complete table - top and base
- ships KD in multiple cartons

Options:

- specify power/charging option, see below for options and upcharges



top shape

LOK - TEAMWORK

To Order Specify

1 Laminate Model #	2 Edge Detail	3 Laminate Selection	3a PVC Edge Color	4 Electrical
Laminate (LKT)	See Edge Detail Options	See Laminate Selection	See PVC Edge Color Options	N None CT2 Dual Power Center Top (See chart on next page) CU1 Single Power Underside 5 Metal Finish See Metal Finish Color Options

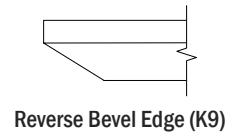
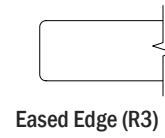
Model Number Breakdown

LKT4872-29TTX					
LK	T	4872	29	TT	X
LOK	Laminate	48" x 72"	Height	Rectangular Top Shape	X base

Description

Rectangular Table with X Base
at Working Height
(continued)

Veneer Tables
"LKV" Models



VENEER	D	W	H	CTN WT	CU FT	① Model	Eased Edge (R3)		Reverse Bevel Edge (K9)	
							Flat Cut	Double Cut	Flat Cut	Double Cut
	48	72	29	163	71	LKV4872-29TTX	\$3,007	\$3,238	\$3,258	\$3,472
	42	72	29	147	63	LKV4272-29TTX	\$2,898	\$3,102	\$3,140	\$3,329
	36	72	29	130	55	LKV3672-29TTX	\$2,673	\$2,875	\$2,848	\$3,044

LOK - TEAMWORK

Electrical Options and Upcharges

CT2	
Dual Power Center Top - Black	CT2BL - add \$1,437
Dual Power Center Top - White	CT2WH - add \$1,437
CU1	
Single Power Underside - Black	CU11C - add \$559
Single Power Underside with Wireless Charging- Black	CU11CW - add \$1,338

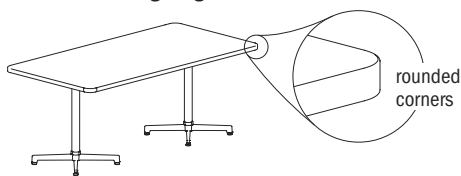
Note: Order power infeed that best fits application

To Order, Specify:

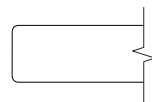
① Veneer Model #	② Edge Detail	③ Wood Species	④ Top Wood Finish	⑤ Electrical	⑥ Metal Color
Veneer (LKV)	See Edge Detail Options	Flat Cut BO1 Black Oak CH1 Cherry MA1 Maple WA1 Walnut	See Flat Cut Top Wood Finish Options	N None CT2 Dual Power Center Top CU1 Single Power Underside (See chart above)	See Metal Finish Color Options
		Double Cut DC1 Double Cut	④ Top Wood Finish See Double Cut Top Wood Finish Options		

Description

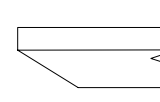
Rounded Rectangular Table with X Base at Working Height



**Laminate Tables
"LKT" Models**



Eased Edge (R3)



Reverse Bevel Edge (K9)

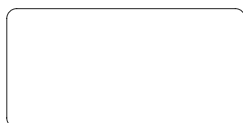
LAMINATE	D	W	H	CTN WT	CU FT	❶ Model	Eased Edge (R3)		Reverse Bevel Edge (K9)			
							Standard	Graded In		Standard	Graded In	
							Tier 1	Tier 2	Tier 3	Tier 1	Tier 2	Tier 3
	48	72	29	163	71	LKT4872-29TTRX	\$2,749	\$2,793	\$3,069	\$3,268	\$3,313	\$3,510
	42	72	29	147	63	LKT4272-29TTRX	\$2,643	\$2,682	\$2,924	\$3,152	\$3,190	\$3,364
	36	72	29	125	55	LKT3672-29TTRX	\$2,468	\$2,537	\$2,686	\$2,923	\$2,991	\$3,141

Features:

- price reflects complete table - top and base
- ships KD in multiple cartons

Options:

- specify power/charging option, see below for options and upcharges



top shape

LOK - TEAMWORK

To Order Specify

❶ Laminate Model #	❷ Edge Detail	❸ Laminate Selection	❹ PVC Edge Color	❺ Electrical
Laminate (LKT)	See Edge Detail Options	See Laminate Selection	See PVC Edge Color Options	N None CT2 Dual Power Center Top (See chart on next page) CU1 Single Power Underside ❺ Metal Finish See Metal Finish Color Options

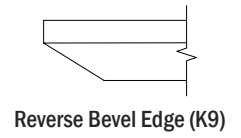
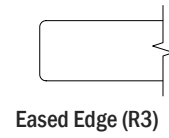
Model Number Breakdown

LKT4872-29TTRX						
LK	T	4872	29	TT	R	X
LOK	Laminate	48" x 72"	Height	Rectangular Top Shape	Rounded Corner	X base

Description

Rounded Rectangular Table with X Base at Working Height (continued)

Veneer Tables "LKV" Models



VENEER	D	W	H	CTN WT	CU FT	① Model	Eased Edge (R3)		Reverse Bevel Edge (K9)	
							Flat Cut	Double Cut	Flat Cut	Double Cut
	48	72	29	163	71	LKV4872-29TTRX	\$3,065	\$3,298	\$3,319	\$3,534
	42	72	29	147	63	LKV4272-29TTRX	\$2,955	\$3,161	\$3,197	\$3,385
	36	72	29	130	55	LKV3672-29TTRX	\$2,864	\$3,075	\$2,952	\$3,150

LOK - TEAMWORK

Electrical Options and Upcharges

CT2	
Dual Power Center Top - Black	CT2BL - add \$1,437
Dual Power Center Top - White	CT2WH - add \$1,437
CU1	
Single Power Underside - Black	CU11C - add \$559
Single Power Underside with Wireless Charging- Black	CU11CW - add \$1,338

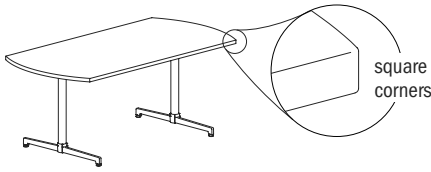
Note: Order power infeed that best fits application

To Order, Specify:

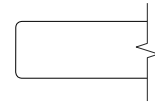
① Veneer Model #	② Edge Detail	③ Wood Species	④ Top Wood Finish	⑤ Electrical	⑥ Metal Color
Veneer (LKV)	See Edge Detail Options	Flat Cut B01 Black Oak CH1 Cherry MA1 Maple WA1 Walnut	See Flat Cut Top Wood Finish Options	N None CT2 Dual Power Center Top CU1 Single Power Underside (See chart above)	See Metal Finish Color Options
		Double Cut DC1 Double Cut	④ Top Wood Finish See Double Cut Top Wood Finish Options		

Description

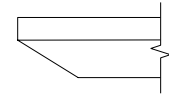
Arc Rectangular Table with T Base at Working Height



Laminate Tables "LKT" Models



Eased Edge (R3)



Reverse Bevel Edge (K9)

LAMINATE	D	W	H	CTN WT	CU FT	Model	Standard			Graded In		
							Tier 1	Tier 2	Tier 3	Tier 1	Tier 2	Tier 3
	48	72	29	148	71	LKT4872-29ART	\$2,042	\$2,084	\$2,347	\$2,537	\$2,579	\$2,767
42	72	29	140	63	LKT4272-29ART	\$1,943	\$1,979	\$2,209	\$2,427	\$2,463	\$2,629	
36	72	29	128	56	LKT3672-29ART	\$1,818	\$1,883	\$2,026	\$2,251	\$2,318	\$2,458	
36	66	29	119	51	LKT3666-29ART	\$1,762	\$1,822	\$1,953	\$2,196	\$2,258	\$2,387	
36	60	29	110	46	LKT3660-29ART	\$1,697	\$1,753	\$1,870	\$2,129	\$2,187	\$2,304	

Features:

- price reflects complete table - top and base
- ships KD in multiple cartons

Options:

- specify power/charging option, see below for options and upcharges
- specify glide (G) or caster (C) -choice of black (BL) or white/grey casters (WG)



top shape

LOK - TEAMWORK

To Order Specify

1 Laminate Model #	2 Edge Detail	3 Laminate Selection	3a PVC Edge Color	4 Electrical
Laminate (LKT)	See Edge Detail Options	See Laminate Selection	See PVC Edge Color Options	<p>N None</p> <p>CT2 Dual Power Center Top (See chart on next page)</p> <p>CU1 Single Power Underside</p> <p>5 Foot/Caster</p> <p>G Glide</p> <p>C Caster</p> <ul style="list-style-type: none"> - BL Black Caster - WG White Caster w/Grey Wheels <p>6 Metal Finish</p> <p>See Metal Finish Color Options</p>

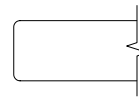
Model Number Breakdown

LKT4872-29ART					
LK	T	4872	29	AR	T
LOK	Laminate	48" x 72"	Height	Arc Rectangular Top Shape	T base

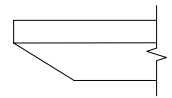
Description

Arc Rectangular Table with T Base at Working Height (continued)

Veneer Tables "LKV" Models



Eased Edge (R3)



Reverse Bevel Edge (K9)

D	W	H	CTN WT	CU FT	① Model	Eased Edge (R3)		Reverse Bevel Edge (K9)	
						Flat Cut	Double Cut	Flat Cut	Double Cut
48	72	29	148	71	LKV4872-29ART	\$2,615	\$2,824	\$2,851	\$3,037
42	72	29	140	63	LKV4272-29ART	\$2,508	\$2,711	\$2,736	\$2,913
36	72	29	128	56	LKV3672-29ART	\$2,403	\$2,593	\$2,617	\$2,788
36	66	29	119	51	LKV3666-29ART	\$2,317	\$2,501	\$2,525	\$2,688
36	60	29	110	46	LKV3660-29ART	\$2,265	\$2,445	\$2,468	\$2,628

VENEER

LOK - TEAMWORK

Electrical Options and Upcharges

CT2	
Dual Power Center Top - Black	CT2BL - add \$1,437
Dual Power Center Top - White	CT2WH - add \$1,437
CU1	
Single Power Underside - Black	CU11C - add \$559
Single Power Underside with Wireless Charging- Black	CU11CW - add \$1,338

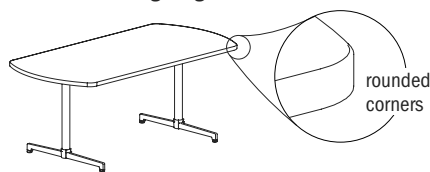
Note: Order power infeed that best fits application

To Order, Specify:

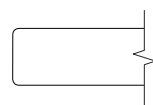
① Veneer Model #	② Edge Detail	③ Wood Species	④ Top Wood Finish	⑤ Electrical	⑥ Base - Foot/Caster	⑦ Metal Color
Veneer (LKV)	See Edge Detail Options	Flat Cut BO1 Black Oak CH1 Cherry MA1 Maple WA1 Walnut	See Flat Cut Top Wood Finish Options	N None CT2 Dual Power Center Top CU1 Single Power Underside (See chart above)	G Glide C Caster - BL Black Caster - WG White Caster with Grey Wheels	See Metal Finish Color Options
		Double Cut DC1 Double Cut	④ Top Wood Finish See Double Cut Top Wood Finish Options			

Description

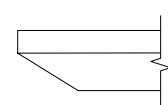
Rounded Arc Rectangular Table with T Base at Working Height



Laminate Tables "LKT" Models



Eased Edge (R3)



Reverse Bevel Edge (K9)

LAMINATE	D	W	H	CTN WT	CU FT	Model	Standard		Graded In		Standard		Graded In		
							Tier 1	Tier 2	Tier 3	Tier 1	Tier 2	Tier 3	Tier 1	Tier 2	Tier 3
		48	72	29	148	71	LKT4872-29ARRT	\$2,042	\$2,084	\$2,347	\$2,537	\$2,579	\$2,767		
	42	72	29	140	63	LKT4272-29ARRT	\$1,943	\$1,979	\$2,209	\$2,427	\$2,463	\$2,629			
	36	72	29	128	56	LKT3672-29ARRT	\$1,818	\$1,883	\$2,026	\$2,251	\$2,318	\$2,458			
	36	66	29	119	51	LKT3666-29ARRT	\$1,762	\$1,822	\$1,953	\$2,196	\$2,258	\$2,387			
	36	60	29	110	46	LKT3660-29ARRT	\$1,697	\$1,753	\$1,870	\$2,129	\$2,187	\$2,304			

Features:

- price reflects complete table - top and base
- ships KD in multiple cartons

Options:

- specify power/charging option, see below for options and upcharges
- specify glide (G) or caster (C) -choice of black (BL) or white/grey casters (WG)



top shape

LOK - TEAMWORK

To Order Specify

1 Laminite Model #	2 Edge Detail	3 Laminite Selection	3a PVC Edge Color	4 Electrical
Laminite (LKT)	See Edge Detail Options	See Laminite Selection	See PVC Edge Color Options	<p>N None</p> <p>CT2 Dual Power Center Top (See chart on next page)</p> <p>CU1 Single Power Underside</p>
				5 Foot/Caster
				<p>G Glide</p> <p>C Caster</p> <p>- BL Black Caster</p> <p>- WG White Caster w/Grey Wheels</p>
				6 Metal Finish
				See Metal Finish Color Options

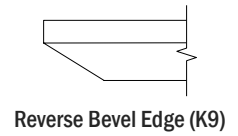
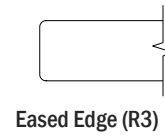
Model Number Breakdown

LKT4872-29ARRT						
LK	T	4872	29	AR	R	T
LOK	Laminite	48" x 72"	Height	Arc Rectangular Top Shape	Rounded Corner	T base

Description

Rounded Arc Rectangular Table with T Base at Working Height (continued)

Veneer Tables "LKV" Models



VENEER	D	W	H	CTN WT	CU FT	① Model	Eased Edge (R3)		Reverse Bevel Edge (K9)	
							Flat Cut	Double Cut	Flat Cut	Double Cut
	48	72	29	148	71	LKV4872-29ARRT	\$2,615	\$2,824	\$2,851	\$3,037
	42	72	29	140	63	LKV4272-29ARRT	\$2,508	\$2,711	\$2,736	\$2,913
	36	72	29	128	56	LKV3672-29ARRT	\$2,403	\$2,593	\$2,617	\$2,788
	36	66	29	119	51	LKV3666-29ARRT	\$2,317	\$2,501	\$2,525	\$2,688
	36	60	29	110	46	LKV3660-29ARRT	\$2,265	\$2,445	\$2,468	\$2,628

LOK - TEAMWORK

Electrical Options and Upcharges

CT2	
Dual Power Center Top - Black	CT2BL - add \$1,437
Dual Power Center Top - White	CT2WH - add \$1,437
CU1	
Single Power Underside - Black	CU11C - add \$559
Single Power Underside with Wireless Charging- Black	CU11CW - add \$1,338

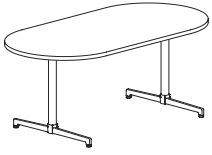
Note: Order power infeed that best fits application

To Order, Specify:

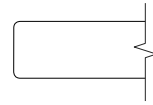
① Veneer Model #	② Edge Detail	③ Wood Species	④ Top Wood Finish	⑤ Electrical	⑥ Base - Foot/Caster	⑦ Metal Color
Veneer (LKV)	See Edge Detail Options	Flat Cut BO1 Black Oak CH1 Cherry MA1 Maple WA1 Walnut	See Flat Cut Top Wood Finish Options	N None CT2 Dual Power Center Top CU1 Single Power Underside (See chart above)	G Glide C Caster - BL Black Caster - WG White Caster with Grey Wheels	See Metal Finish Color Options
			④ Top Wood Finish See Double Cut Top Wood Finish Options			
		Double Cut DC1 Double Cut				

Description

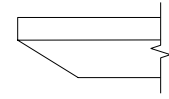
Racetrack Table with T Base at Working Height



Laminate Tables
"LKT" Models



Eased Edge (R3)



Reverse Bevel Edge (K9)

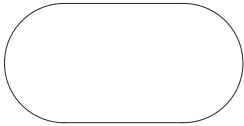
LAMINATE	D	W	H	CTN WT	CU FT	Model	Standard		Graded In		Standard		Graded In		
							Tier 1	Tier 2	Tier 3	Tier 1	Tier 2	Tier 3	Tier 1	Tier 2	Tier 3
		48	72	29	135	71	LKT4872-29RKT	\$2,042	\$2,084	\$2,347	\$2,537	\$2,579	\$2,767		
	42	72	29	133	63	LKT4272-29RKT	\$1,943	\$1,979	\$2,209	\$2,427	\$2,463	\$2,629			
	36	72	29	122	56	LKT3672-29RKT	\$1,818	\$1,883	\$2,026	\$2,251	\$2,318	\$2,458			
	36	66	29	113	51	LKT3666-29RKT	\$1,762	\$1,822	\$1,953	\$2,196	\$2,258	\$2,387			
	36	60	29	104	46	LKT3660-29RKT	\$1,697	\$1,753	\$1,870	\$2,129	\$2,187	\$2,304			

Features:

- price reflects complete table - top and base
- ships KD in multiple cartons

Options:

- specify power/charging option, see below for options and upcharges
- specify glide (G) or caster (C) -choice of black (BL) or white/grey casters (WG)



top shape

LOK - TEAMWORK

To Order Specify

1 Laminate Model #	2 Edge Detail	3 Laminate Selection	3a PVC Edge Color	4 Electrical
Laminate (LKT)	See Edge Detail Options	See Laminate Selection	See PVC Edge Color Options	<p>N None</p> <p>CT2 Dual Power Center Top (See chart on next page)</p> <p>CU1 Single Power Underside</p>
				5 Foot/Caster
				<p>G Glide</p> <p>C Caster</p> <ul style="list-style-type: none"> - BL Black Caster - WG White Caster w/Grey Wheels
				6 Metal Finish
				See Metal Finish Color Options

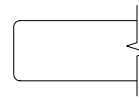
Model Number Breakdown

LKT4872-29RKT					
LK	T	4872	29	RK	T
LOK	Laminate	48" x 72"	Height	Racetrack Top Shape	T base

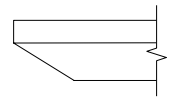
Description

Racetrack Table with T Base
at Working Height
(continued)

Veneer Tables
"LKV" Models



Eased Edge (R3)



Reverse Bevel Edge (K9)

VENEER	D	W	H	CTN WT	CU FT	① Model	Flat Cut	Double Cut	Flat Cut	Double Cut
		48	72	29	135	71	LKV4872-29RKT	\$2,615	\$2,824	\$2,851
	42	72	29	133	63	LKV4272-29RKT	\$2,508	\$2,711	\$2,736	\$2,913
	36	72	29	122	56	LKV3672-29RKT	\$2,403	\$2,593	\$2,617	\$2,788
	36	66	29	113	51	LKV3666-29RKT	\$2,317	\$2,501	\$2,525	\$2,688
	36	60	29	104	46	LKV3660-29RKT	\$2,191	\$2,365	\$2,388	\$2,541

LOK - TEAMWORK

Electrical Options and Upcharges

CT2	
Dual Power Center Top - Black	CT2BL - add \$1,437
Dual Power Center Top - White	CT2WH - add \$1,437
CU1	
Single Power Underside - Black	CU11C - add \$559
Single Power Underside with Wireless Charging- Black	CU11CW - add \$1,338

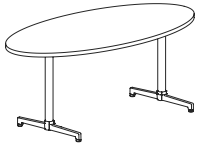
Note: Order power infeed that best fits application

To Order, Specify:

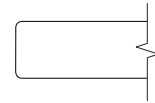
① Veneer Model #	② Edge Detail	③ Wood Species	④ Top Wood Finish	⑤ Electrical	⑥ Base - Foot/Caster	⑦ Metal Color
Veneer (LKV)	See Edge Detail Options	Flat Cut BO1 Black Oak CH1 Cherry MA1 Maple WA1 Walnut	See Flat Cut Top Wood Finish Options	N None CT2 Dual Power Center Top CU1 Single Power Underside (See chart above)	G Glide C Caster - BL Black Caster - WG White Caster with Grey Wheels	See Metal Finish Color Options
			Double Cut DC1 Double Cut			

Description

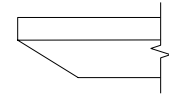
Oval Table with T Base at Working Height



Laminate Tables "LKT" Models



Eased Edge (R3)



Reverse Bevel Edge (K9)

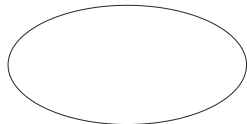
LAM.	D	W	H	CTN WT	CU FT	Model	Standard Tier 1	Graded In Tier 2	Graded In Tier 3	Standard Tier 1	Graded In Tier 2	Graded In Tier 3
		36	72	29	110	56	LKT3672-29OVT	\$1,818	\$1,883	\$2,026	\$2,251	\$2,318

Features:

- price reflects complete table - top and base
- ships KD in multiple cartons

Options:

- specify power option and or charging option, see below for options and upcharges
- specify glide (always black) or caster; Black (BL) or White with Grey Wheels (WG)



top shape

LOK - TEAMWORK

To Order Specify

1 Laminate Model #	2 Edge Detail	3 Laminate Selection	3a PVC Edge Color	4 Electrical
Laminate (LKT)	See Edge Detail Options	See Laminate Selection	See PVC Edge Color Options	<p>N None</p> <p>CT2 Dual Power Center Top (See chart on next page)</p> <p>CU1 Single Power Underside</p>
				5 Foot/Caster
				<p>G Glide</p> <p>C Caster</p> <ul style="list-style-type: none"> - BL Black Caster - WG White Caster w/Grey Wheels
				6 Metal Finish
				See Metal Finish Color Options

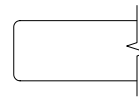
Model Number Breakdown

LKT3672-29OVT					
LK	T	3672	29	OV	T
LOK	Laminate	36" x 72"	Height	Oval Top Shape	T base

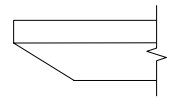
Description

Oval Table with T Base at Working Height (continued)

Veneer Tables "LKV" Models



Eased Edge (R3)



Reverse Bevel Edge (K9)

VEN.	D	W	H	CTN WT	CU FT	① Model	Veneer Tables "LKV" Models			
							Flat Cut	Double Cut	Flat Cut	Double Cut
	36	72	29	110	56	LKV3672-29OVT	\$2,249	\$2,429	\$2,452	\$2,610

LOK - TEAMWORK

Electrical Options and Upcharges

CT2	
Dual Power Center Top - Black	CT2BL - add \$1,437
Dual Power Center Top - White	CT2WH - add \$1,437
CU1	
Single Power Underside - Black	CU11C - add \$559
Single Power Underside with Wireless Charging- Black	CU11CW - add \$1,338

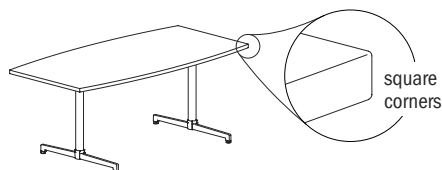
Note: Order power infeed that best fits application

To Order, Specify:

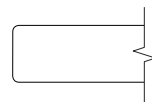
① Veneer Model #	② Edge Detail	③ Wood Species	④ Top Wood Finish	⑤ Electrical	⑥ Base - Foot/Caster	⑦ Metal Color
Veneer (LKV)	See Edge Detail Options	Flat Cut BO1 Black Oak CH1 Cherry MA1 Maple WA1 Walnut	See Flat Cut Top Wood Finish Options	N None CT2 Dual Power Center Top CU1 Single Power Underside (See chart above)	G Glide C Caster - BL Black Caster - WG White Caster with Grey Wheels	See Metal Finish Color Options.
		Double Cut DC1 Double Cut	④ Top Wood Finish See Double Cut Top Wood Finish Options			

Description

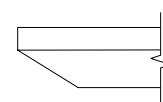
Boat Table with T Base at Working Height



Laminate Tables "LKT" Models



Eased Edge (R3)



Reverse Bevel Edge (K9)

LAMINATE	D	W	H	CTN WT	CU FT	Model	Standard		Graded In		Standard		Graded In		
							Tier 1	Tier 2	Tier 3	Tier 1	Tier 2	Tier 3	Tier 1	Tier 2	Tier 3
		48	72	29	145	71	LKT4872-29BTT	\$2,042	\$2,084	\$2,347	\$2,537	\$2,579	\$2,767		
	42	72	29	142	63	LKT4272-29BTT	\$1,943	\$1,979	\$2,209	\$2,427	\$2,463	\$2,629			
	36	72	29	128	56	LKT3672-29BTT	\$1,818	\$1,883	\$2,026	\$2,251	\$2,318	\$2,458			
	36	66	29	119	51	LKT3666-29BTT	\$1,762	\$1,822	\$1,953	\$2,196	\$2,258	\$2,387			
	36	60	29	111	46	LKT3660-29BTT	\$1,697	\$1,753	\$1,870	\$2,129	\$2,187	\$2,304			

Features:

- price reflects complete table - top and base
- ships KD in multiple cartons



top shape

Options:

- specify power/charging option, see below for options and upcharges
- specify glide (G) or caster (C) -choice of black (BL) or white/grey casters (WG)

LOK - TEAMWORK

To Order Specify

1 Laminate Model #	2 Edge Detail	3 Laminate Selection	3a PVC Edge Color	4 Electrical
Laminate (LKT)	See Edge Detail Options	See Laminate Selection	See PVC Edge Color Options	<p>N None</p> <p>CT2 Dual Power Center Top (See chart on next page)</p> <p>CU1 Single Power Underside</p>
				5 Foot/Caster
				<p>G Glide</p> <p>C Caster</p> <ul style="list-style-type: none"> - BL Black Caster - WG White Caster w/Grey Wheels
				6 Metal Finish
				See Metal Finish Color Options

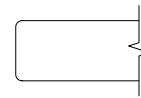
Model Number Breakdown

LKT4872-29BTT					
LK	T	4872	29	BT	T
LOK	Laminate	48" x 72"	Height	Boat Top Shape	T base

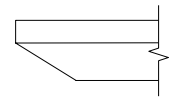
Description

Boat Table with T Base at Working Height (continued)

Veneer Tables "LKV" Models



Eased Edge (R3)



Reverse Bevel Edge (K9)

VENEER	D	W	H	CTN WT	CU FT	① Model	Eased Edge (R3)		Reverse Bevel Edge (K9)	
							Flat Cut	Double Cut	Flat Cut	Double Cut
	48	72	29	145	71	LKV4872-29BTT	\$2,615	\$2,824	\$2,851	\$3,037
	42	72	29	145	71	LKV4272-29BTT	\$2,508	\$2,711	\$2,736	\$2,913
	36	72	29	142	63	LKV3672-29BTT	\$2,403	\$2,593	\$2,617	\$2,788
	36	66	29	128	56	LKV3666-29BTT	\$2,317	\$2,501	\$2,525	\$2,688
	36	60	29	119	46	LKV3660-29BTT	\$2,265	\$2,445	\$2,468	\$2,628

LOK - TEAMWORK

Electrical Options and Upcharges

CT2	
Dual Power Center Top - Black	CT2BL - add \$1,437
Dual Power Center Top - White	CT2WH - add \$1,437
CU1	
Single Power Underside - Black	CU11C - add \$559
Single Power Underside with Wireless Charging- Black	CU11CW - add \$1,338

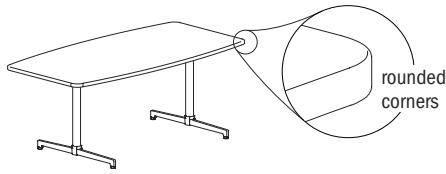
Note: Order power infeed that best fits application

To Order, Specify:

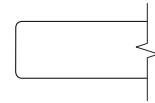
① Veneer Model #	② Edge Detail	③ Wood Species	④ Top Wood Finish	⑤ Electrical	⑥ Base - Foot/Caster	⑦ Metal Color
Veneer (LKV)	See Edge Detail Options	Flat Cut BO1 Black Oak CH1 Cherry MA1 Maple WA1 Walnut	See Flat Cut Top Wood Finish Options	N None CT2 Dual Power Center Top CU1 Single Power Underside (See chart above)	G Glide C Caster - BL Black Caster - WG White Caster with Grey Wheels	See Metal Finish Color Options
			Double Cut DC1 Double Cut			

Description

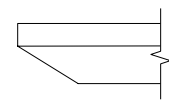
Rounded Boat Table with T Base at Working Height



Laminate Tables "LKT" Models



Eased Edge (R3)



Reverse Bevel Edge (K9)

LAMINATE	D	W	H	CTN WT	CU FT	Model	Standard		Graded In		Standard		Graded In		
							Tier 1	Tier 2	Tier 3	Tier 1	Tier 2	Tier 3	Tier 1	Tier 2	Tier 3
		48	72	29	145	71	LKT4872-29BTRT	\$2,042	\$2,084	\$2,347	\$2,537	\$2,579	\$2,767		
	42	72	29	142	63	LKT4272-29BTRT	\$1,943	\$1,979	\$2,209	\$2,427	\$2,463	\$2,629			
	36	72	29	128	56	LKT3672-29BTRT	\$1,818	\$1,883	\$2,026	\$2,251	\$2,318	\$2,458			
	36	66	29	119	51	LKT3666-29BTRT	\$1,762	\$1,822	\$1,953	\$2,196	\$2,258	\$2,387			
	36	60	29	111	46	LKT3660-29BTRT	\$1,697	\$1,753	\$1,870	\$2,129	\$2,187	\$2,304			

Features:

- price reflects complete table - top and base
- ships KD in multiple cartons



top shape

Options:

- specify power/charging option, see below for options and upcharges
- specify glide (G) or caster (C) -choice of black (BL) or white/grey casters (WG)

LOK - TEAMWORK

To Order Specify

1 Laminate Model #	2 Edge Detail	3 Laminate Selection	3a PVC Edge Color	4 Electrical
Laminate (LKT)	See Edge Detail Options	See Laminate Selection	See PVC Edge Color Options	<p>N None</p> <p>CT2 Dual Power Center Top (See chart on next page)</p> <p>CU1 Single Power Underside</p>
				5 Foot/Caster
				<p>G Glide</p> <p>C Caster</p> <ul style="list-style-type: none"> - BL Black Caster - WG White Caster w/Grey Wheels
				6 Metal Finish
				See Metal Finish Color Options

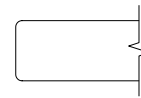
Model Number Breakdown

LKT4872-29BTRT						
LK	T	4872	29	BT	R	T
LOK	Laminate	48" x 72"	Height	Boat Top Shape	Rounded Corner	T base

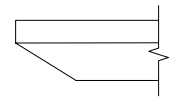
Description

Rounded Boat Table with T Base at Working Height (continued)

Veneer Tables "LKV" Models



Eased Edge (R3)



Reverse Bevel Edge (K9)

VENEER	D	W	H	CTN WT	CU FT	① Model	Flat Cut	Double Cut	Flat Cut	Double Cut
		48	72	29	145	71	LKV4872-29BTRT	\$2,615	\$2,824	\$2,851
	42	72	29	142	63	LKV4272-29BTRT	\$2,508	\$2,711	\$2,736	\$2,913
	36	72	29	128	56	LKV3672-29BTRT	\$2,403	\$2,593	\$2,617	\$2,788
	36	66	29	119	51	LKV3666-29BTRT	\$2,317	\$2,501	\$2,525	\$2,688
	36	60	29	111	46	LKV3660-29BTRT	\$2,265	\$2,445	\$2,468	\$2,628

LOK - TEAMWORK

Electrical Options and Upcharges

CT2	
Dual Power Center Top - Black	CT2BL - add \$1,437
Dual Power Center Top - White	CT2WH - add \$1,437
CU1	
Single Power Underside - Black	CU11C - add \$559
Single Power Underside with Wireless Charging- Black	CU11CW - add \$1,338

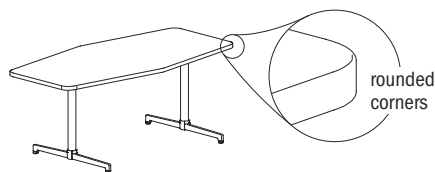
Note: Order power infeed that best fits application

To Order, Specify:

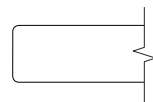
① Veneer Model #	② Edge Detail	③ Wood Species	④ Top Wood Finish	⑤ Electrical	⑥ Base - Foot/Caster	⑦ Metal Color
Veneer (LKV)	See Edge Detail Options	Flat Cut BO1 Black Oak CH1 Cherry MA1 Maple WA1 Walnut	See Flat Cut Top Wood Finish Options	N None CT2 Dual Power Center Top CU1 Single Power Underside (See chart above)	G Glide C Caster - BL Black Caster - WG White Caster with Grey Wheels	See Metal Finish Color Options
		Double Cut DC1 Double Cut	④ Top Wood Finish See Double Cut Top Wood Finish Options			

Description

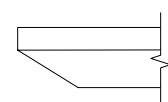
Rounded Double Chevron Table with T Base at Working Height



Laminate Tables "LKT" Models



Eased Edge (R3)



Reverse Bevel Edge (K9)

LAMINATE

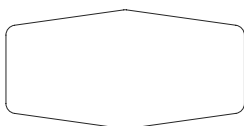
D	W	H	CTN WT	CU FT	Model	Standard			Graded In		
						Tier 1	Tier 2	Tier 3	Tier 1	Tier 2	Tier 3
48	72	29	148	71	LKT4872-29DCRT	\$2,042	\$2,084	\$2,347	\$2,537	\$2,579	\$2,767
48	60	29	138	60	LKT4860-29DCRT	\$1,804	\$1,840	\$2,058	\$2,286	\$2,323	\$2,480
42	72	29	133	63	LKT4272-29DCRT	\$1,943	\$1,979	\$2,209	\$2,427	\$2,463	\$2,629
42	60	29	123	52	LKT4260-29DCRT	\$1,719	\$1,749	\$1,944	\$2,196	\$2,226	\$2,362
36	72	29	107	56	LKT3672-29DCRT	\$1,818	\$1,883	\$2,026	\$2,251	\$2,318	\$2,458
36	60	29	101	46	LKT3660-29DCRT	\$1,672	\$1,700	\$1,865	\$2,140	\$2,167	\$2,283

Features:

- price reflects complete table - top and base
- ships KD in multiple cartons

Options:

- specify power/charging option, see below for options and upcharges
- specify glide (G) or caster (C) -choice of black (BL) or white/grey casters (WG)



top shape

LOK - TEAMWORK

To Order Specify

1 Laminate Model #	2 Edge Detail	3 Laminate Selection	3a PVC Edge Color	4 Electrical
Laminate (LKT)	See Edge Detail Options	See Laminate Selection	See PVC Edge Color Options	<p>N None</p> <p>CT2 Dual Power Center Top (See chart on next page)</p> <p>CU1 Single Power Underside</p>
				5 Foot/Caster
				<p>G Glide</p> <p>C Caster</p> <ul style="list-style-type: none"> - BL Black Caster - WG White Caster w/Grey Wheels
				6 Metal Finish
				See Metal Finish Color Options

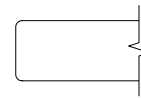
Model Number Breakdown

LKT4872-29DCRT						
LK	T	4872	29	DC	R	T
LOK	Laminate	48" x 72"	Height	Double Chevron Top Shape	Rounded Corner	T base

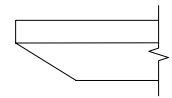
Description

Rounded Double Chevron Table with T Base
at Working Height
(continued)

Veneer Tables
"LKV" Models



Eased Edge (R3)



Reverse Bevel Edge (K9)

D	W	H	CTN WT	CU FT	① Model	Eased Edge (R3)		Reverse Bevel Edge (K9)		
						Flat Cut	Double Cut	Flat Cut	Double Cut	
48	72	29	148	71	LKV4872-29DCRT	\$2,615	\$2,824	\$2,851	\$3,037	
48	60	29	138	60	LKV4860-29DCRT	\$2,371	\$2,561	\$2,585	\$2,752	
VENEER	42	72	29	133	63	LKV4272-29DCRT	\$2,508	\$2,711	\$2,736	\$2,913
	42	60	29	123	52	LKV4260-29DCRT	\$2,280	\$2,463	\$2,486	\$2,647
36	72	29	107	56	LKV3672-29DCRT	\$2,249	\$2,429	\$2,452	\$2,610	
36	60	29	101	46	LKV3660-29DCRT	\$2,110	\$2,279	\$2,302	\$2,450	

LOK - TEAMWORK

Electrical Options and Upcharges

CT2	
Dual Power Center Top - Black	CT2BL - add \$1,437
Dual Power Center Top - White	CT2WH - add \$1,437
CU1	
Single Power Underside - Black	CU11C - add \$559
Single Power Underside with Wireless Charging - Black	CU11CW - add \$1,338

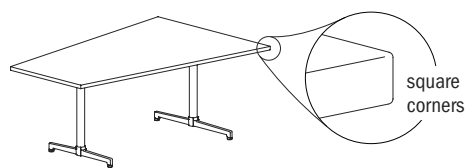
Note: Order power infeed that best fits application

To Order, Specify:

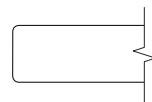
① Veneer Model #	② Edge Detail	③ Wood Species	④ Top Wood Finish	⑤ Electrical	⑥ Base - Foot/Caster	⑦ Metal Color
Veneer (LKV)	See Edge Detail Options	Flat Cut BO1 Black Oak CH1 Cherry MA1 Maple WA1 Walnut	See Flat Cut Top Wood Finish Options	N None CT2 Dual Power Center Top CU1 Single Power Underside (See chart above)	G Glide C Caster - BL Black Caster - WG White Caster with Grey Wheels	See Metal Finish Color Options
		Double Cut DC1 Double Cut	④ Top Wood Finish See Double Cut Top Wood Finish Options			

Description

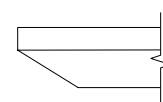
Taper Table with T Base at Working Height



Laminate Tables "LKT" Models



Eased Edge (R3)



Reverse Bevel Edge (K9)

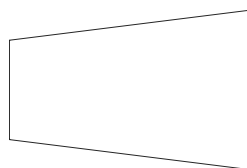
LAM.	D	W	H	CTN WT	CU FT	Model	Standard Tier 1	Graded In Tier 2	Graded In Tier 3	Standard Tier 1	Graded In Tier 2	Graded In Tier 3
		48	72	29	140	71	LKT4872-29TPT	\$2,537	\$2,580	\$2,843	\$3,033	\$3,075

Features:

- price reflects complete table - top and base
- ships KD in multiple cartons

Options:

- specify power/charging option, see below for options and upcharges
- specify glide (G) or caster (C) -choice of black (BL) or white/grey casters (WG)



top shape

LOK - TEAMWORK

To Order Specify

1 Laminate Model #	2 Edge Detail	3 Laminate Selection	3a PVC Edge Color	4 Electrical
Laminate (LKT)	See Edge Detail Options	See Laminate Selection	See PVC Edge Color Options	<p>N None</p> <p>CT2 Dual Power Center Top (See chart on next page)</p> <p>CU1 Single Power Underside</p>
				5 Foot/Caster
				<p>G Glide</p> <p>C Caster</p> <ul style="list-style-type: none"> - BL Black Caster - WG White Caster w/ Grey Wheels
				6 Metal Finish
				See Metal Finish Color Options

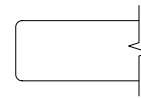
Model Number Breakdown

LKT4872-29TPT					
LK	T	4872	29	TP	T
LOK	Laminate	48" x 72"	Height	Taper Top Shape	T base

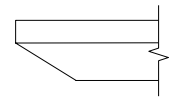
Description

Taper Table with T Base at Working Height (continued)

Veneer Tables "LKV" Models



Eased Edge (R3)



Reverse Bevel Edge (K9)

VEN.	D	W	H	CTN WT	CU FT	① Model	Veneer Tables "LKV" Models			
							Flat Cut	Double Cut	Flat Cut	Double Cut
48	72	29	140	71	LKV4872-29TPT	\$3,113	\$3,360	\$3,393	\$3,613	

LOK - TEAMWORK

Electrical Options and Upcharges

CT2	
Dual Power Center Top - Black	CT2BL - add \$1,437
Dual Power Center Top - White	CT2WH - add \$1,437
CU1	
Single Power Underside - Black	CU11C - add \$559
Single Power Underside with Wireless Charging- Black	CU11CW - add \$1,338

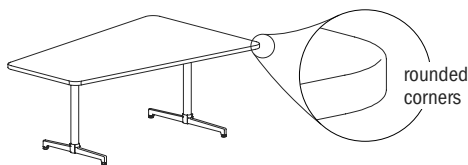
Note: Order power infeed that best fits application

To Order, Specify:

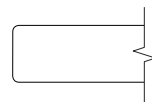
① Veneer Model #	② Edge Detail	③ Wood Species	④ Top Wood Finish	⑤ Electrical	⑥ Base - Foot/Caster	⑦ Metal Color
Veneer (LKV)	See Edge Detail Options	Flat Cut BO1 Black Oak CH1 Cherry MA1 Maple WA1 Walnut	See Flat Cut Top Wood Finish Options	N None CT2 Dual Power Center Top CU1 Single Power Underside (See chart above)	G Glide C Caster - BL Black Caster - WG White Caster with Grey Wheels	See Metal Finish Color Options
		Double Cut DC1 Double Cut	④ Top Wood Finish See Double Cut Top Wood Finish Options			

Description

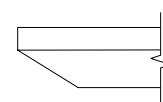
Rounded Taper Table with T Base at Working Height



Laminate Tables "LKT" Models



Eased Edge (R3)



Reverse Bevel Edge (K9)

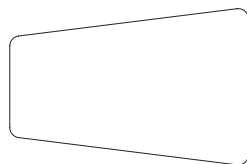
LAM.	D	W	H	CTN WT	CU FT	Model	Standard Tier 1	Graded In Tier 2	Graded In Tier 3	Standard Tier 1	Graded In Tier 2	Graded In Tier 3
		48	72	29	140	71	LKT4872-29TPRT	\$2,537	\$2,580	\$2,843	\$3,033	\$3,075

Features:

- price reflects complete table - top and base
- ships KD in multiple cartons

Options:

- specify power/charging option, see below for options and upcharges
- specify glide (G) or caster (C) -choice of black (BL) or white/grey casters (WG)



top shape

LOK - TEAMWORK

To Order Specify

1 Laminata Model #	2 Edge Detail	3 Laminata Selection	3a PVC Edge Color	4 Electrical
Laminata (LKT)	See Edge Detail Options	See Laminata Selection	See PVC Edge Color Options	<p>N None</p> <p>CT2 Dual Power Center Top (See chart on next page)</p> <p>CU1 Single Power Underside</p>
				5 Foot/Caster
				<p>G Glide</p> <p>C Caster</p> <ul style="list-style-type: none"> - BL Black Caster - WG White Caster w/Grey Wheels
				6 Metal Finish
				See Metal Finish Color Options

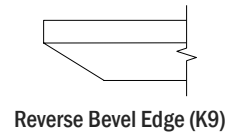
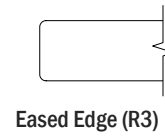
Model Number Breakdown

LKT4872-29TPRT						
LK	T	4872	29	TP	R	T
LOK	Laminata	48" x 72"	Height	Taper Top Shape	Rounded Corner	T base

Description

Rounded Taper Table with T Base at Working Height (continued)

Veneer Tables "LKV" Models



VEN.	D	W	H	CTN WT	CU FT	① Model	Eased Edge (R3)		Reverse Bevel Edge (K9)	
							Flat Cut	Double Cut	Flat Cut	Double Cut
	48	72	29	140	71	LKV4872-29TPRT	\$3,113	\$3,360	\$3,393	\$3,613

LOK - TEAMWORK

Electrical Options and Upcharges

CT2	
Dual Power Center Top - Black	CT2BL - add \$1,437
Dual Power Center Top - White	CT2WH - add \$1,437
CU1	
Single Power Underside - Black	CU11C - add \$559
Single Power Underside with Wireless Charging- Black	CU11CW - add \$1,338

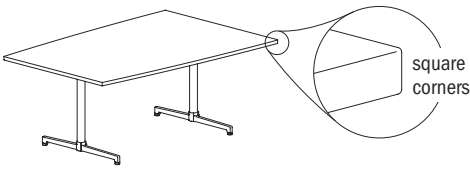
Note: Order power infeed that best fits application

To Order, Specify:

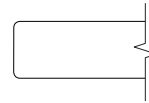
① Veneer Model #	② Edge Detail	③ Wood Species	④ Top Wood Finish	⑤ Electrical	⑥ Base - Foot/Caster	⑦ Metal Color
Veneer (LKV)	See Edge Detail Options	Flat Cut BO1 Black Oak CH1 Cherry MA1 Maple WA1 Walnut	See Flat Cut Top Wood Finish Options	N None CT2 Dual Power Center Top CU1 Single Power Underside (See chart above)	G Glide C Caster - BL Black Caster - WG White Caster with Grey Wheels	See Metal Finish Color Options.
		Double Cut DC1 Double Cut	④ Top Wood Finish See Double Cut Top Wood Finish Options			

Description

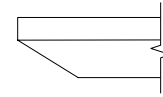
Wedge Table with T Base
at Working Height



**Laminate Tables
"LKT" Models**



Eased Edge (R3)



Reverse Bevel Edge (K9)

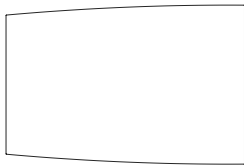
LAM.	D	W	H	CTN WT	CU FT	Model	Standard			Graded In		
							Tier 1	Tier 2	Tier 3	Tier 1	Tier 2	Tier 3
	48	72	29	127	71	LKT4872-29WDT	\$2,842	\$2,885	\$3,146	\$3,337	\$3,380	\$3,567

Features:

- price reflects complete table - top and base
- ships KD in multiple cartons

Options:

- specify power/charging option, see below for options and upcharges
- specify glide (G) or caster (C) -choice of black (BL) or white/grey casters (WG)



top shape

LOK - TEAMWORK

To Order Specify

1 Laminate Model #	2 Edge Detail	3 Laminate Selection	3a PVC Edge Color	4 Electrical
Laminate (LKT)	See Edge Detail Options	See Laminate Selection	See PVC Edge Color Options	<p>N None</p> <p>CT2 Dual Power Center Top (See chart on next page)</p> <p>CU1 Single Power Underside</p>
				5 Foot/Caster
				<p>G Glide</p> <p>C Caster</p> <ul style="list-style-type: none"> - BL Black Caster - WG White Caster w/Grey Wheels
				6 Metal Finish
				See Metal Finish Color Options

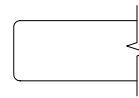
Model Number Breakdown

LKT4872-29WDT					
LK	T	4872	29	WD	T
LOK	Laminate	48" x 72"	Height	Wedge Top Shape	T base

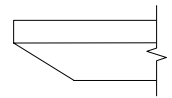
Description

Wedge Table with T Base
at Working Height
(continued)

Veneer Tables
"LKV" Models



Eased Edge (R3)



Reverse Bevel Edge (K9)

VEN.	D	W	H	CTN WT	CU FT	① Model	Eased Edge (R3)		Reverse Bevel Edge (K9)	
							Flat Cut	Double Cut	Flat Cut	Double Cut
	48	72	29	124	71	LKV4872-29WDT	\$3,418	\$3,689	\$3,722	\$3,965

LOK - TEAMWORK

Electrical Options and Upcharges

CT2	
Dual Power Center Top - Black	CT2BL - add \$1,437
Dual Power Center Top - White	CT2WH - add \$1,437
CU1	
Single Power Underside - Black	CU11C - add \$559
Single Power Underside with Wireless Charging- Black	CU11CW - add \$1,338

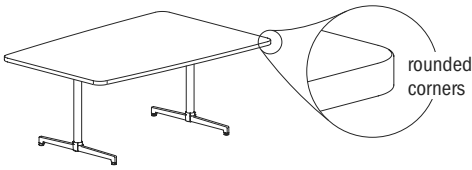
Note: Order power infeed that best fits application

To Order, Specify:

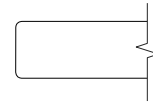
① Veneer Model #	② Edge Detail	③ Wood Species	④ Top Wood Finish	⑤ Electrical	⑥ Base - Foot/Caster	⑦ Metal Color
Veneer (LKV)	See Edge Detail Options	Flat Cut BO1 Black Oak CH1 Cherry MA1 Maple WA1 Walnut	See Flat Cut Top Wood Finish Options	N None CT2 Dual Power Center Top CU1 Single Power Underside (See chart above)	G Glide C Caster - BL Black Caster - WG White Caster with Grey Wheels	See Metal Finish Color Options.
		Double Cut DC1 Double Cut	④ Top Wood Finish See Double Cut Top Wood Finish Options			

Description

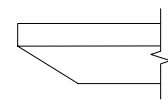
Wedge Table with T Base
at Working Height



**Laminate Tables
"LKT" Models**



Eased Edge (R3)



Reverse Bevel Edge (K9)

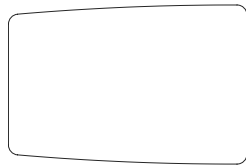
LAM.	D	W	H	CTN WT	CU FT	Model	Standard		Graded In		Standard		Graded In	
							Tier 1	Tier 2	Tier 3	Tier 1	Tier 2	Tier 3		
	48	72	29	156	71	LKT4872-29WDRT	\$2,042	\$2,084	\$2,347	\$2,537	\$2,579	\$2,767		

Features:

- price reflects complete table - top and base
- ships KD in multiple cartons

Options:

- specify power/charging option, see below for options and upcharges
- specify glide (G) or caster (C) -choice of black (BL) or white/grey casters (WG)



top shape

LOK - TEAMWORK

To Order Specify

1 Laminate Model #	2 Edge Detail	3 Laminate Selection	3a PVC Edge Color	4 Electrical
Laminate (LKT)	See Edge Detail Options	See Laminate Selection	See PVC Edge Color Options	<p>N None</p> <p>CT2 Dual Power Center Top (See chart on next page)</p> <p>CU1 Single Power Underside</p>
				5 Foot/Caster
				<p>G Glide</p> <p>C Caster</p> <ul style="list-style-type: none"> - BL Black Caster - WG White Caster w/Grey Wheels
				6 Metal Finish
				See Metal Finish Color Options

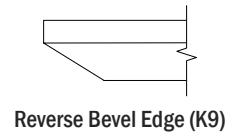
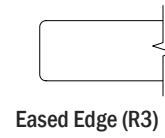
Model Number Breakdown

LKT4872-29WDRT						
LK	T	4872	29	WD	R	T
LOK	Laminate	48" x 72"	Height	Wedge Top Shape	Rounded Corner	T base

Description

Wedge Table with T Base
at Working Height
(continued)

Veneer Tables
"LKV" Models



VEN.	D	W	H	CTN WT	CU FT	① Model	Eased Edge (R3)		Reverse Bevel Edge (K9)	
							Flat Cut	Double Cut	Flat Cut	Double Cut
	48	72	29	156	71	LKV4872-29WDRT	\$2,615	\$2,824	\$2,851	\$3,037

LOK - TEAMWORK

Electrical Options and Upcharges

CT2	
Dual Power Center Top - Black	CT2BL - add \$1,437
Dual Power Center Top - White	CT2WH - add \$1,437
CU1	
Single Power Underside - Black	CU11C - add \$559
Single Power Underside with Wireless Charging- Black	CU11CW - add \$1,338

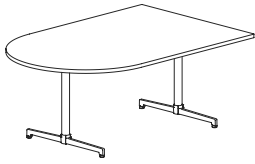
Note: Order power infeed that best fits application

To Order, Specify:

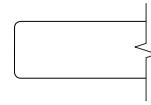
① Veneer Model #	② Edge Detail	③ Wood Species	④ Top Wood Finish	⑤ Electrical	⑥ Base - Foot/Caster	⑦ Metal Color
Veneer (LKV)	See Edge Detail Options	Flat Cut BO1 Black Oak CH1 Cherry MA1 Maple WA1 Walnut	See Flat Cut Top Wood Finish Options	N None CT2 Dual Power Center Top CU1 Single Power Underside (See chart above)	G Glide C Caster - BL Black Caster - WG White Caster with Grey Wheels	See Metal Finish Color Options.
		Double Cut DC1 Double Cut	④ Top Wood Finish See Double Cut Top Wood Finish Options			

Description

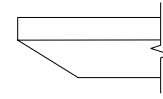
Bullet Table with T Base at Working Height



Laminate Tables "LKT" Models



Eased Edge (R3)



Reverse Bevel Edge (K9)

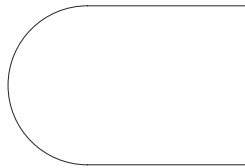
LAM.	D	W	H	CTN WT	CU FT	① Model	Standard		Graded In		Standard		Graded In	
							Tier 1	Tier 2	Tier 3	Tier 1	Tier 2	Tier 3		
	48	72	29	153	71	LKT4872-29BUT	\$2,042	\$2,084	\$2,347	\$2,537	\$2,579	\$2,767		

Features:

- price reflects complete table - top and base
- ships KD in multiple cartons

Options:

- specify power/charging option, see below for options and upcharges
- specify glide (G) or caster (C) -choice of black (BL) or white/grey casters (WG)



top shape

LOK - TEAMWORK

To Order Specify

① Laminate Model #	② Edge Detail	③ Laminate Selection	④ PVC Edge Color	⑤ Electrical
Laminate (LKT)	See Edge Detail Options	See Laminate Selection	See PVC Edge Color Options	<p>N None</p> <p>CT2 Dual Power Center Top (See chart on next page)</p> <p>CU1 Single Power Underside</p>
				⑤ Foot/Caster
				<p>G Glide</p> <p>C Caster</p> <ul style="list-style-type: none"> - BL Black Caster - WG White Caster w/Grey Wheels
				⑥ Metal Finish
				See Metal Finish Color Options

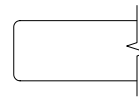
Model Number Breakdown

LKT4872-29BUT					
LK	T	4872	29	BU	T
LOK	Laminate	48" x 72"	Height	Bullet Top Shape	T base

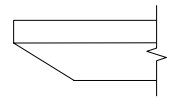
Description

Bullet Table with T Base
at Working Height
(continued)

Veneer Tables
"LKV" Models



Eased Edge (R3)



Reverse Bevel Edge (K9)

VEN.	D	W	H	CTN WT	CU FT	① Model				
							Flat Cut	Double Cut	Flat Cut	Double Cut
48	72	29	153	71	LKV4872-29BUT	\$2,615	\$2,824	\$2,851	\$3,037	

LOK - TEAMWORK

Electrical Options and Upcharges

CT2	
Dual Power Center Top - Black	CT2BL - add \$1,437
Dual Power Center Top - White	CT2WH - add \$1,437
CU1	
Single Power Underside - Black	CU11C - add \$559
Single Power Underside with Wireless Charging- Black	CU11CW - add \$1,338

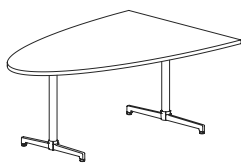
Note: Order power infeed that best fits application

To Order, Specify:

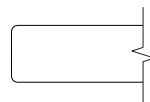
① Veneer Model #	② Edge Detail	③ Wood Species	④ Top Wood Finish	⑤ Electrical	⑥ Base - Foot/Caster	⑦ Metal Color
Veneer (LKV)	See Edge Detail Options	Flat Cut BO1 Black Oak CH1 Cherry MA1 Maple WA1 Walnut	See Flat Cut Top Wood Finish Options	N None CT2 Dual Power Center Top CU1 Single Power Underside (See chart above)	G Glide C Caster - BL Black Caster - WG White Caster with Grey Wheels	See Metal Finish Color Options.
		Double Cut DC1 Double Cut	④ Top Wood Finish See Double Cut Top Wood Finish Options			

Description

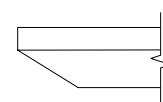
Hive Table with T Base at Working Height



Laminate Tables
"LKT" Models



Eased Edge (R3)



Reverse Bevel Edge (K9)

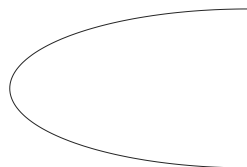
LAM.	D	W	H	CTN WT	CU FT	Model	Standard			Graded In		
							Tier 1	Tier 2	Tier 3	Tier 1	Tier 2	Tier 3
	48	72	29	135	71	LKT4872-29HVT	\$2,042	\$2,084	\$2,347	\$2,537	\$2,579	\$2,767

Features:

- price reflects complete table - top and base
- ships KD in multiple cartons

Options:

- specify power/charging option, see below for options and upcharges
- specify glide (G) or caster (C) -choice of black (BL) or white/grey casters (WG)



top shape

LOK - TEAMWORK

To Order Specify

1 Laminate Model #	2 Edge Detail	3 Laminate Selection	3a PVC Edge Color	4 Electrical
Laminate (LKT)	See Edge Detail Options	See Laminate Selection	See PVC Edge Color Options	<p>N None</p> <p>CT2 Dual Power Center Top (See chart on next page)</p> <p>CU1 Single Power Underside</p>
				5 Foot/Caster
				<p>G Glide</p> <p>C Caster</p> <ul style="list-style-type: none"> - BL Black Caster - WG White Caster w/Grey Wheels
				6 Metal Finish
				See Metal Finish Color Options

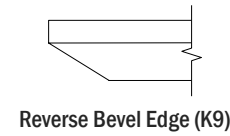
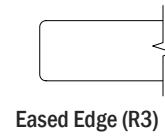
Model Number Breakdown

LKT4872-29HVT					
LK	T	4872	29	HV	T
LOK	Laminate	48" x 72"	Height	Hive Top Shape	T base

Description

Hive Table with T Base at Working Height (continued)

Veneer Tables "LKV" Models



VEN.	D	W	H	CTN WT	CU FT	① Model	Eased Edge (R3)		Reverse Bevel Edge (K9)	
							Flat Cut	Double Cut	Flat Cut	Double Cut
	48	72	29	135	71	LKV4872-29HVT	\$2,615	\$2,824	\$2,851	\$3,037

LOK - TEAMWORK

Electrical Options and Upcharges

CT2	
Dual Power Center Top - Black	CT2BL - add \$1,437
Dual Power Center Top - White	CT2WH - add \$1,437
CU1	
Single Power Underside - Black	CU11C - add \$559
Single Power Underside with Wireless Charging- Black	CU11CW - add \$1,338

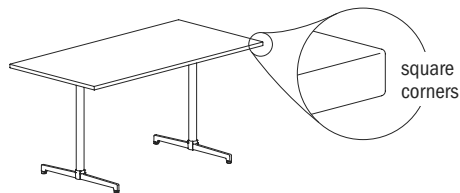
Note: Order power infeed that best fits application

To Order, Specify:

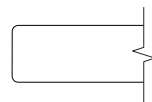
① Veneer Model #	② Edge Detail	③ Wood Species	④ Top Wood Finish	⑤ Electrical	⑥ Base - Foot/Caster	⑦ Metal Color
Veneer (LKV)	See Edge Detail Options	Flat Cut BO1 Black Oak CH1 Cherry MA1 Maple WA1 Walnut	See Flat Cut Top Wood Finish Options	N None CT2 Dual Power Center Top CU1 Single Power Underside (See chart above)	G Glide C Caster - BL Black Caster - WG White Caster with Grey Wheels	See Metal Finish Color Options.
		Double Cut DC1 Double Cut	④ Top Wood Finish See Double Cut Top Wood Finish Options			

Description

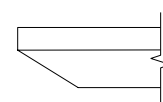
Rectangular Table with T Base at Counter Height



**Laminate Tables
"LKT" Models**



Eased Edge (R3)



Reverse Bevel Edge (K9)

LAMINATE	D	W	H	CTN WT	CU FT	Model	Eased Edge (R3)			Reverse Bevel Edge (K9)		
							Standard	Graded In		Standard	Graded In	
							Tier 1	Tier 2	Tier 3	Tier 1	Tier 2	Tier 3
	48	72	36	144	87	LKT4872-36TTT	\$2,258	\$2,304	\$2,579	\$2,778	\$2,822	\$3,020
	42	72	36	146	77	LKT4272-36TTT	\$2,157	\$2,197	\$2,438	\$2,668	\$2,706	\$2,879
	36	72	36	135	66	LKT3672-36TTT	\$1,953	\$2,021	\$2,171	\$2,408	\$2,478	\$2,627
	36	66	36	126	62	LKT3666-36TTT	\$1,893	\$1,953	\$2,090	\$2,344	\$2,408	\$2,545
	36	60	36	135	57	LKT3660-36TTT	\$1,811	\$1,872	\$1,993	\$2,268	\$2,326	\$2,450

Features:

- price reflects complete table - top and base
- ships KD in multiple cartons
- model includes adjustable glide

Options:

- specify power option and or charging option, see below for options and upcharges



top shape

LOK - TEAMWORK

To Order Specify

1 Laminite Model #	2 Edge Detail	3 Laminite Selection	3a PVC Edge Color	4 Electrical
Laminite (LKT)	See Edge Detail Options	See Laminite Selection	See PVC Edge Color Options	N None CT2 Dual Power Center Top (See chart on next page) CU1 Single Power Underside 5 Metal Finish See Metal Finish Color Options

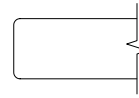
Model Number Breakdown

LKT4872-36TTT					
LK	T	4872	36	TT	T
LOK	Laminite	48" x 72"	Height	Rectangular Top Shape	T base

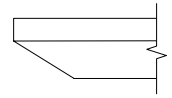
Description

Rectangular Table with T Base at Counter Height
(continued)

Veneer Tables
"LKV" Models



Eased Edge (R3)



Reverse Bevel Edge (K9)

D	W	H	CTN WT	CU FT	① Model	Eased Edge (R3)		Reverse Bevel Edge (K9)	
						Flat Cut	Double Cut	Flat Cut	Double Cut
48	72	36	140	87	LKV4872-36TTT	\$2,577	\$2,811	\$2,828	\$3,046
42	72	36	146	77	LKV4272-36TTT	\$2,470	\$2,675	\$2,712	\$2,899
36	72	36	135	66	LKV3672-36TTT	\$2,257	\$2,457	\$2,433	\$2,629
36	66	36	126	62	LKV3666-36TTT	\$2,213	\$2,400	\$2,383	\$2,566
36	60	36	135	57	LKV3660-36TTT	\$2,152	\$2,326	\$2,315	\$2,485

VENEER

LOK - TEAMWORK

Electrical Options and Upcharges

CT2	
Dual Power Center Top - Black	CT2BL - add \$1,437
Dual Power Center Top - White	CT2WH - add \$1,437
CU1	
Single Power Underside - Black	CU11C - add \$559
Single Power Underside with Wireless Charging- Black	CU11CW - add \$1,338

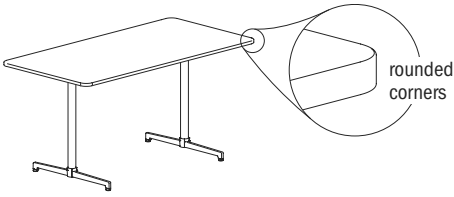
Note: Order power infeed that best fits application

To Order, Specify:

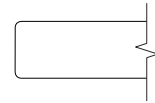
① Veneer Model #	② Edge Detail	③ Wood Species	④ Top Wood Finish	⑤ Electrical	⑥ Metal Color
Veneer (LKV)	See Edge Detail Options	Flat Cut B01 Black Oak CH1 Cherry MA1 Maple WA1 Walnut	See Flat Cut Top Wood Finish Options	N None CT2 Dual Power Center Top CU1 Single Power Underside (See chart above)	See Metal Finish Color Options
		Double Cut DC1 Double Cut	④ Top Wood Finish See Double Cut Top Wood Finish Options		

Description

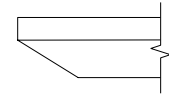
Rounded Rectangular Table with T Base at Counter Height



Laminate Tables "LKT" Models



Eased Edge (R3)



Reverse Bevel Edge (K9)

LAMINATE	D	W	H	CTN WT	CU FT	Model	Eased Edge (R3)			Reverse Bevel Edge (K9)		
							Standard	Graded In		Standard	Graded In	
							Tier 1	Tier 2	Tier 3	Tier 1	Tier 2	Tier 3
	48	72	36	144	87	LKT4872-36TTRT	\$2,319	\$2,365	\$2,641	\$2,840	\$2,885	\$3,082
	42	72	36	136	77	LKT4272-36TTRT	\$2,214	\$2,253	\$2,494	\$2,723	\$2,763	\$2,934
	36	72	36	135	66	LKT3672-36TTRT	\$2,053	\$2,121	\$2,271	\$2,507	\$2,578	\$2,726
	36	66	36	126	62	LKT3666-36TTRT	\$1,993	\$2,058	\$2,194	\$2,450	\$2,516	\$2,649
	36	60	36	135	57	LKT3660-36TTRT	\$1,922	\$1,985	\$2,106	\$2,378	\$2,441	\$2,561

Features:

- price reflects complete table - top and base
- ships KD in multiple cartons
- model includes adjustable glide

Options:

- specify power option and or charging option, see below for options and upcharges



top shape

LOK - TEAMWORK

To Order Specify

1 Laminite Model #	2 Edge Detail	3 Laminite Selection	3a PVC Edge Color	4 Electrical
Laminite (LKT)	See Edge Detail Options	See Laminite Selection	See PVC Edge Color Options	N None CT2 Dual Power Center Top (See chart on next page) CU1 Single Power Underside 5 Metal Finish See Metal Finish Color Options

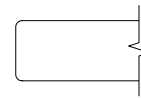
Model Number Breakdown

LKT4872-36TTRT						
LK	T	4872	36	TT	R	T
LOK	Laminite	48" x 72"	Height	Rectangular Top Shape	Rounded Corner	T base

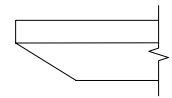
Description

Rounded Rectangular Table with T Base at Counter Height
(continued)

Veneer Tables
"LKV" Models



Eased Edge (R3)



Reverse Bevel Edge (K9)

D	W	H	CTN WT	CU FT	① Model	Eased Edge (R3)		Reverse Bevel Edge (K9)	
						Flat Cut	Double Cut	Flat Cut	Double Cut
48	72	36	144	87	LKV4872-36TTRT	\$2,639	\$2,872	\$2,890	\$3,106
42	72	36	146	77	LKV4272-36TTRT	\$2,526	\$2,731	\$2,770	\$2,957
36	72	36	135	66	LKV3672-36TTRT	\$2,415	\$2,627	\$2,503	\$2,703
36	66	36	126	62	LKV3666-36TTRT	\$2,324	\$2,489	\$2,551	\$2,699
36	60	36	135	57	LKV3660-36TTRT	\$2,304	\$2,485	\$2,382	\$2,553

VENEER

LOK - TEAMWORK

Electrical Options and Upcharges

CT2	
Dual Power Center Top - Black	CT2BL - add \$1,437
Dual Power Center Top - White	CT2WH - add \$1,437
CU1	
Single Power Underside - Black	CU11C - add \$559
Single Power Underside with Wireless Charging- Black	CU11CW - add \$1,338

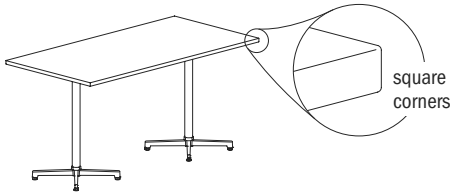
Note: Order power infeed that best fits application

To Order, Specify:

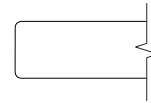
① Veneer Model #	② Edge Detail	③ Wood Species	④ Top Wood Finish	⑤ Electrical	⑥ Metal Color
Veneer (LKV)	See Edge Detail Options	Flat Cut B01 Black Oak CH1 Cherry MA1 Maple WA1 Walnut	See Flat Cut Top Wood Finish Options	N None CT2 Dual Power Center Top CU1 Single Power Underside (See chart above)	See Metal Finish Color Options
		Double Cut DC1 Double Cut	④ Top Wood Finish See Double Cut Top Wood Finish Options		

Description

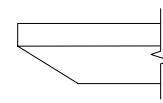
Rectangular Table with X Base at Counter Height



**Laminate Tables
"LKT" Models**



Eased Edge (R3)



Reverse Bevel Edge (K9)

LAMINATE	D	W	H	CTN WT	CU FT	Model	Eased Edge (R3)			Reverse Bevel Edge (K9)		
							Standard	Graded In		Standard	Graded In	
							Tier 1	Tier 2	Tier 3	Tier 1	Tier 2	Tier 3
	48	72	36	165	87	LKT4872-36TTX	\$2,770	\$2,814	\$3,090	\$3,289	\$3,333	\$3,531
	42	72	36	150	77	LKT4272-36TTX	\$2,668	\$2,706	\$2,949	\$3,177	\$3,215	\$3,389
	36	72	36	133	67	LKT3672-36TTX	\$2,513	\$2,580	\$2,730	\$2,967	\$3,036	\$3,185

Features:

- price reflects complete table - top and base
- ships KD in multiple cartons
- model includes adjustable glide

Options:

- specify power option and or charging option, see below for options and upcharges



top shape

LOK - TEAMWORK

To Order Specify

1 Laminate Model #	2 Edge Detail	3 Laminate Selection	3a PVC Edge Color	4 Electrical
Laminate (LKT)	See Edge Detail Options	See Laminate Selection	See PVC Edge Color Options	N None CT2 Dual Power Center Top (See chart on next page) CU1 Single Power Underside 5 Metal Finish See Metal Finish Color Options

Model Number Breakdown

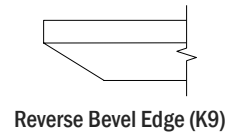
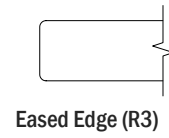
LKT4872-36TTX					
LK	T	4872	36	TT	X
LOK	Laminate	48" x 72"	Height	Rectangular Top Shape	X base

133.1 Lok

Description

Rectangular Table with X Base at Counter Height
(continued)

Veneer Tables
"LKV" Models



VENEER	D	W	H	CTN WT	CU FT	① Model	Eased Edge (R3)		Reverse Bevel Edge (K9)	
							Flat Cut	Double Cut	Flat Cut	Double Cut
	48	72	36	165	87	LKV4872-36TTX	\$3,087	\$3,319	\$3,339	\$3,555
	42	72	36	150	77	LKV4272-36TTX	\$2,979	\$3,185	\$3,221	\$3,411
	36	72	36	133	67	LKV3672-36TTX	\$2,816	\$3,017	\$2,991	\$3,187

LOK - TEAMWORK

Electrical Options and Upcharges

CT2	
Dual Power Center Top - Black	CT2BL - add \$1,437
Dual Power Center Top - White	CT2WH - add \$1,437
CU1	
Single Power Underside - Black	CU11C - add \$559
Single Power Underside with Wireless Charging- Black	CU11CW - add \$1,338

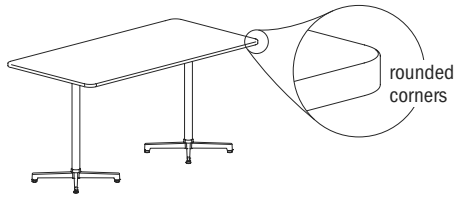
Note: Order power infeed that best fits application

To Order, Specify:

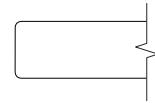
① Veneer Model #	② Edge Detail	③ Wood Species	④ Top Wood Finish	⑤ Electrical	⑥ Metal Color
Veneer (LKV)	See Edge Detail Options	Flat Cut B01 Black Oak CH1 Cherry MA1 Maple WA1 Walnut	See Flat Cut Top Wood Finish Options	N None CT2 Dual Power Center Top CU1 Single Power Underside (See chart above)	See Metal Finish Color Options
		Double Cut DC1 Double Cut	④ Top Wood Finish See Double Cut Top Wood Finish Options		

Description

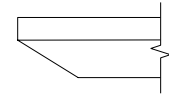
Rounded Rectangular Table with X Base at Counter Height



Laminate Tables "LKT" Models



Eased Edge (R3)



Reverse Bevel Edge (K9)

LAMINATE	D	W	H	CTN WT	CU FT	Model	Standard Tier 1	Graded In Tier 2	Graded In Tier 3	Standard Tier 1	Graded In Tier 2	Graded In Tier 3
	48	72	36	165	87	LKT4872-36TTRX	\$2,828	\$2,876	\$3,149	\$3,350	\$3,394	\$3,592
	42	72	36	150	77	LKT4272-36TTRX	\$2,588	\$2,627	\$2,870	\$3,097	\$3,136	\$3,310
36	72	36	133	67	LKT3672-36TTRX	\$2,611	\$2,681	\$2,828	\$3,065	\$3,137	\$3,286	

Features:

- price reflects complete table - top and base
- ships KD in multiple cartons
- model includes adjustable glide

Options:

- specify power option and or charging option, see below for options and upcharges



top shape

LOK - TEAMWORK

To Order Specify

1 Laminate Model #	2 Edge Detail	3 Laminate Selection	3a PVC Edge Color	4 Electrical
Laminate (LKT)	See Edge Detail Options	See Laminate Selection	See PVC Edge Color Options	N None CT2 Dual Power Center Top (See chart on next page) CU1 Single Power Underside 5 Metal Finish See Metal Finish Color Options

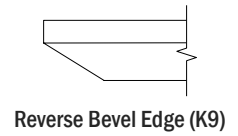
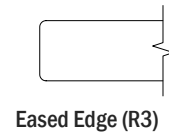
Model Number Breakdown

LKT4872-36TTRX						
LK	T	4872	36	TT	R	X
LOK	Laminate	48" x 72"	Height	Rectangular Top Shape	Rounded Corner	X base

Description

Rounded Rectangular Table with X Base at Counter Height
(continued)

Veneer Tables
"LKV" Models



VENEER	D	W	H	CTN WT	CU FT	① Model	Flat Cut	Double Cut	Flat Cut	Double Cut
		48	72	36	165	87	LKV4872-36TTRX	\$3,148	\$3,382	\$3,399
	42	72	36	150	77	LKV4272-36TTRX	\$2,899	\$3,106	\$3,141	\$3,330
	36	72	36	133	67	LKV3672-36TTRX	\$3,010	\$3,220	\$3,097	\$3,295

LOK - TEAMWORK

Electrical Options and Upcharges

CT2	
Dual Power Center Top - Black	CT2BL - add \$1,437
Dual Power Center Top - White	CT2WH - add \$1,437
CU1	
Single Power Underside - Black	CU11C - add \$559
Single Power Underside with Wireless Charging- Black	CU11CW - add \$1,338

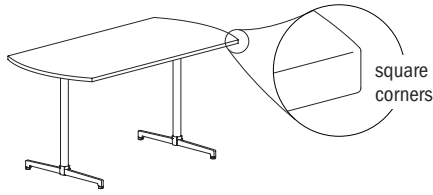
Note: Order power infeed that best fits application

To Order, Specify:

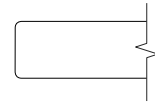
① Veneer Model #	② Edge Detail	③ Wood Species	④ Top Wood Finish	⑤ Electrical	⑥ Metal Color
Veneer (LKV)	See Edge Detail Options	Flat Cut B01 Black Oak CH1 Cherry MA1 Maple WA1 Walnut	See Flat Cut Top Wood Finish Options	N None CT2 Dual Power Center Top CU1 Single Power Underside (See chart above)	See Metal Finish Color Options
		Double Cut DC1 Double Cut	④ Top Wood Finish See Double Cut Top Wood Finish Options		

Description

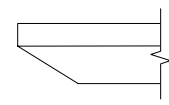
Arc Rectangular Table with T Base at Counter Height



Laminate Tables
"LKT" Models



Eased Edge (R3)



Reverse Bevel Edge (K9)

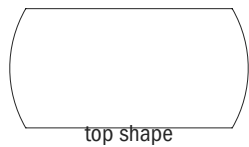
LAMINATE	D	W	H	CTN WT	CU FT	Model	Eased Edge (R3)			Reverse Bevel Edge (K9)		
							Standard	Graded In		Standard	Graded In	
							Tier 1	Tier 2	Tier 3	Tier 1	Tier 2	Tier 3
	48	72	36	153	87	LKT4872-36ART	\$2,209	\$2,253	\$2,516	\$2,705	\$2,749	\$2,935
	42	72	36	140	78	LKT4272-36ART	\$2,109	\$2,147	\$2,377	\$2,594	\$2,632	\$2,796
	36	72	36	131	66	LKT3672-36ART	\$1,955	\$2,022	\$2,164	\$2,389	\$2,455	\$2,598
	36	66	36	122	62	LKT3666-36ART	\$1,899	\$1,961	\$2,090	\$2,333	\$2,395	\$2,524
	36	60	36	131	57	LKT3660-36ART	\$1,833	\$1,893	\$2,005	\$2,267	\$2,325	\$2,439

Features:

- price reflects complete table - top and base
- ships KD in multiple cartons
- model includes adjustable glide

Options:

- specify power option and or charging option, see below for options and upcharges



LOK - TEAMWORK

To Order Specify

1 Laminite Model #	2 Edge Detail	3 Laminite Selection	3a PVC Edge Color	4 Electrical
Laminite (LKT)	See Edge Detail Options	See Laminite Selection	See PVC Edge Color Options	N None CT2 Dual Power Center Top (See chart on next page) CU1 Single Power Underside 5 Metal Finish See Metal Finish Color Options

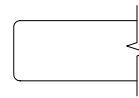
Model Number Breakdown

LKT4872-36ART					
LK	T	4872	36	AR	T
LOK	Laminite	48" x 72"	Height	Arc Rectangular Top Shape	T base

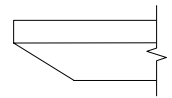
Description

Arc Rectangular Table with T Base at Counter Height
(continued)

Veneer Tables
"LKV" Models



Eased Edge (R3)



Reverse Bevel Edge (K9)

VENEER	D	W	H	CTN WT	CU FT	① Model	Flat Cut	Double Cut	Flat Cut	Double Cut
		48	72	36	153	87	LKV4872-36ART	\$2,784	\$3,007	\$3,033
	42	72	36	140	78	LKV4272-36ART	\$2,678	\$2,891	\$2,920	\$3,108
	36	72	36	131	66	LKV3672-36ART	\$2,570	\$2,776	\$2,803	\$2,985
	36	66	36	122	62	LKV3666-36ART	\$2,485	\$2,684	\$2,710	\$2,885
	36	60	36	131	57	LKV3660-36ART	\$2,430	\$2,626	\$2,649	\$2,821

LOK - TEAMWORK

Electrical Options and Upcharges

CT2	
Dual Power Center Top - Black	CT2BL - add \$1,437
Dual Power Center Top - White	CT2WH - add \$1,437
CU1	
Single Power Underside - Black	CU11C - add \$559
Single Power Underside with Wireless Charging- Black	CU11CW - add \$1,338

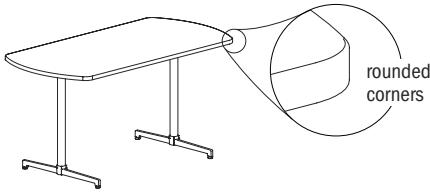
Note: Order power infeed that best fits application

To Order, Specify:

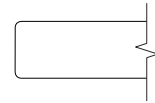
① Veneer Model #	② Edge Detail	③ Wood Species	④ Top Wood Finish	⑤ Electrical	⑥ Metal Color
Veneer (LKV)	See Edge Detail Options	Flat Cut B01 Black Oak CH1 Cherry MA1 Maple WA1 Walnut	See Flat Cut Top Wood Finish Options	N None CT2 Dual Power Center Top CU1 Single Power Underside (See chart above)	See Metal Finish Color Options
		Double Cut DC1 Double Cut	④ Top Wood Finish See Double Cut Top Wood Finish Options		

Description

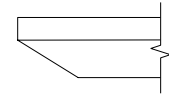
Rounded Arc Rectangular Table with T Base at Counter Height



Laminate Tables "LKT" Models



Eased Edge (R3)



Reverse Bevel Edge (K9)

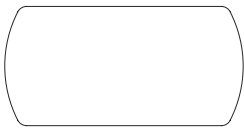
LAMINATE	D	W	H	CTN WT	CU FT	Model	Eased Edge (R3)		Reverse Bevel Edge (K9)			
							Standard	Graded In		Standard	Graded In	
							Tier 1	Tier 2	Tier 3	Tier 1	Tier 2	Tier 3
	48	72	36	153	87	LKT4872-36ARRT	\$2,209	\$2,253	\$2,516	\$2,705	\$2,749	\$2,935
	42	72	36	140	78	LKT4272-36ARRT	\$2,109	\$2,147	\$2,377	\$2,594	\$2,632	\$2,796
	36	72	36	131	66	LKT3672-36ARRT	\$1,955	\$2,022	\$2,164	\$2,389	\$2,455	\$2,598
	36	66	36	122	62	LKT3666-36ARRT	\$1,899	\$1,961	\$2,090	\$2,333	\$2,395	\$2,524
	36	60	36	131	57	LKT3660-36ARRT	\$1,833	\$1,893	\$2,005	\$2,267	\$2,325	\$2,439

Features:

- price reflects complete table - top and base
- ships KD in multiple cartons
- model includes adjustable glide

Options:

- specify power option and or charging option, see below for options and upcharges



top shape

LOK - TEAMWORK

To Order Specify

1 Laminite Model #	2 Edge Detail	3 Laminite Selection	3a PVC Edge Color	4 Electrical
Laminite (LKT)	See Edge Detail Options	See Laminite Selection	See PVC Edge Color Options	N None CT2 Dual Power Center Top (See chart on next page) CU1 Single Power Underside 5 Metal Finish See Metal Finish Color Options

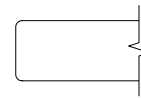
Model Number Breakdown

LKT4872-36ARRT						
LK	T	4872	36	AR	R	T
LOK	Laminite	48" x 72"	Height	Arc Rectangular Top Shape	Rounded Corner	T base

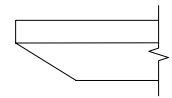
Description

Rounded Arc Rectangular Table with T Base
at Counter Height
(continued)

Veneer Tables
"LKV" Models



Eased Edge (R3)



Reverse Bevel Edge (K9)

D	W	H	CTN WT	CU FT	① Model	Eased Edge (R3)		Reverse Bevel Edge (K9)	
						Flat Cut	Double Cut	Flat Cut	Double Cut
48	72	36	153	87	LKV4872-36ARRT	\$2,784	\$3,007	\$3,033	\$3,231
42	72	36	140	78	LKV4272-36ARRT	\$2,678	\$2,891	\$2,920	\$3,108
36	72	36	131	66	LKV3672-36ARRT	\$2,570	\$2,776	\$2,803	\$2,985
36	66	36	122	62	LKV3666-36ARRT	\$2,485	\$2,684	\$2,710	\$2,885
36	60	36	131	57	LKV3660-36ARRT	\$2,430	\$2,626	\$2,649	\$2,821

VENEER

LOK - TEAMWORK

Electrical Options and Upcharges

CT2	
Dual Power Center Top - Black	CT2BL - add \$1,437
Dual Power Center Top - White	CT2WH - add \$1,437
CU1	
Single Power Underside - Black	CU11C - add \$559
Single Power Underside with Wireless Charging - Black	CU11CW - add \$1,338

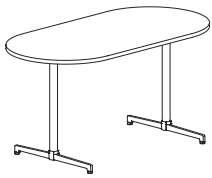
Note: Order power infeed that best fits application

To Order, Specify:

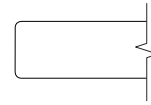
① Veneer Model #	② Edge Detail	③ Wood Species	④ Top Wood Finish	⑤ Electrical	⑥ Metal Color
Veneer (LKV)	See Edge Detail Options	Flat Cut B01 Black Oak CH1 Cherry MA1 Maple WA1 Walnut	See Flat Cut Top Wood Finish Options	N None CT2 Dual Power Center Top CU1 Single Power Underside (See chart above)	See Metal Finish Color Options
		Double Cut DC1 Double Cut	④ Top Wood Finish See Double Cut Top Wood Finish Options		

Description

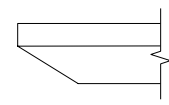
Racetrack Table with T Base at Counter Height



Laminate Tables
"LKT" Models



Eased Edge (R3)



Reverse Bevel Edge (K9)

LAMINATE	D	W	H	CTN WT	CU FT	❶ Model	Standard			Graded In		
							Tier 1	Tier 2	Tier 3	Tier 1	Tier 2	Tier 3
	42	72	36	136	77	LKT4272-36RKT	\$2,109	\$2,147	\$2,377	\$2,594	\$2,632	\$2,796
36	72	36	125	66	LKT3672-36RKT	\$1,955	\$2,022	\$2,164	\$2,389	\$2,455	\$2,598	
36	66	36	117	62	LKT3666-36RKT	\$1,899	\$1,961	\$2,090	\$2,333	\$2,395	\$2,524	
36	60	36	125	57	LKT3660-36RKT	\$1,833	\$1,893	\$2,005	\$2,267	\$2,325	\$2,439	

Features:

- price reflects complete table - top and base
- ships KD in multiple cartons
- model includes adjustable glide

Options:

- specify power option and or charging option, see below for options and upcharges



top shape

LOK - TEAMWORK

To Order Specify

❶ Laminate Model #	❷ Edge Detail	❸ Laminate Selection	❹ PVC Edge Color	❺ Electrical
Laminate (LKT)	See Edge Detail Options	See Laminate Selection	See PVC Edge Color Options	N None CT2 Dual Power Center Top (See chart on next page) CU1 Single Power Underside ❻ Metal Finish See Metal Finish Color Options

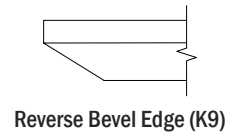
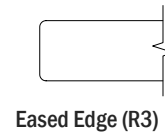
Model Number Breakdown

LKT4272-36RKT					
LK	T	4272	36	RK	T
LOK	Laminate	42" x 72"	Height	Racetrack Top Shape	T base

Description

Racetrack Table with T Base at Counter Height
(continued)

Veneer Tables
"LKV" Models



VENEER	D	W	H	CTN WT	CU FT	① Model	Eased Edge (R3)		Reverse Bevel Edge (K9)	
							Flat Cut	Double Cut	Flat Cut	Double Cut
	48	72	36	144	87	LKV4872-36RKT	\$2,784	\$3,007	\$3,033	\$3,231
	36	72	36	125	66	LKV3672-36RKT	\$2,570	\$2,776	\$2,803	\$2,985
	36	66	36	117	62	LKV3666-36RKT	\$2,485	\$2,684	\$2,710	\$2,885
	36	60	36	125	57	LKV3660-36RKT	\$2,430	\$2,626	\$2,649	\$2,821

LOK - TEAMWORK

Electrical Options and Upcharges

CT2	
Dual Power Center Top - Black	CT2BL - add \$1,437
Dual Power Center Top - White	CT2WH - add \$1,437
CU1	
Single Power Underside - Black	CU11C - add \$559
Single Power Underside with Wireless Charging- Black	CU11CW - add \$1,338

Note: Order power infeed that best fits application

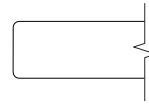
To Order, Specify:

① Veneer Model #	② Edge Detail	③ Wood Species	④ Top Wood Finish	⑤ Electrical	⑥ Metal Color
Veneer (LKV)	See Edge Detail Options	Flat Cut B01 Black Oak CH1 Cherry MA1 Maple WA1 Walnut	See Flat Cut Top Wood Finish Options	N None CT2 Dual Power Center Top CU1 Single Power Underside (See chart above)	See Metal Finish Color Options
		Double Cut DC1 Double Cut	④ Top Wood Finish See Double Cut Top Wood Finish Options		

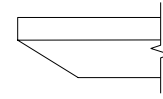
Description

Oval Table with T Base at Counter Height

**Laminate Tables
"LKT" Models**



Eased Edge (R3)



Reverse Bevel Edge (K9)

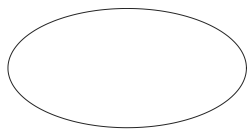
LAM.	D	W	H	CTN WT	CU FT	❶ Model	Standard	Graded In		Standard	Graded In	
							Tier 1	Tier 2	Tier 3	Tier 1	Tier 2	Tier 3
	36	72	36	113	67	LKT3672-360VT	\$1,955	\$2,022	\$2,164	\$2,389	\$2,455	\$2,598

Features:

- price reflects complete table - top and base
- ships KD in multiple cartons
- model includes adjustable glide

Options:

- specify power option and or charging option, see below for options and upcharges



top shape

LOK - TEAMWORK

To Order Specify

❶ Laminate Model #	❷ Edge Detail	❸ Laminate Selection	❹ PVC Edge Color	❺ Electrical
Laminate (LKT)	See Edge Detail Options	See Laminate Selection	See PVC Edge Color Options	N None CT2 Dual Power Center Top (See chart on next page) CU1 Single Power Underside ❺ Metal Finish See Metal Finish Color Options

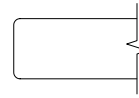
Model Number Breakdown

LKT3672-360VT					
LK	T	3672	36	OV	T
LOK	Laminate	36" x 72"	Height	Oval Top Shape	T base

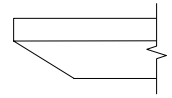
Description

Oval Table with T Base at Counter Height
(continued)

Veneer Tables
"LKV" Models



Eased Edge (R3)



Reverse Bevel Edge (K9)

VEN.	D	W	H	CTN WT	CU FT	① Model	Eased Edge (R3)		Reverse Bevel Edge (K9)	
							Flat Cut	Double Cut	Flat Cut	Double Cut
	36	72	36	113	67	LKV3672-360VT	\$2,415	\$2,609	\$2,632	\$2,804

LOK - TEAMWORK

Electrical Options and Upcharges

CT2	
Dual Power Center Top - Black	CT2BL - add \$1,437
Dual Power Center Top - White	CT2WH - add \$1,437
CU1	
Single Power Underside - Black	CU11C - add \$559
Single Power Underside with Wireless Charging- Black	CU11CW - add \$1,338

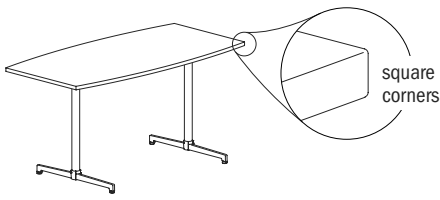
Note: Order power infeed that best fits application

To Order, Specify:

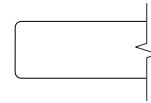
① Veneer Model #	② Edge Detail	③ Wood Species	④ Top Wood Finish	⑤ Electrical	⑥ Metal Color
Veneer (LKV)	See Edge Detail Options	Flat Cut B01 Black Oak CH1 Cherry MA1 Maple WA1 Walnut	See Flat Cut Top Wood Finish Options	N None CT2 Dual Power Center Top CU1 Single Power Underside (See chart above)	See Metal Finish Color Options
		Double Cut DC1 Double Cut	④ Top Wood Finish See Double Cut Top Wood Finish Options		

Description

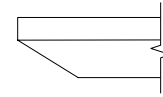
Boat Table with T Base at Counter Height



Laminate Tables
"LKT" Models



Eased Edge (R3)



Reverse Bevel Edge (K9)

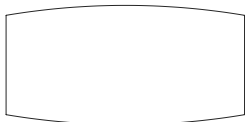
LAMINATE	D	W	H	CTN WT	CU FT	Model	Standard			Graded In		
							Tier 1	Tier 2	Tier 3	Tier 1	Tier 2	Tier 3
		48	72	36	156	87	LKT4872-36BTT	\$2,209	\$2,253	\$2,516	\$2,705	\$2,749
	42	72	36	107	87	LKT4272-36BTT	\$2,109	\$2,147	\$2,377	\$2,594	\$2,632	\$2,796
	36	72	36	130	66	LKT3672-36BTT	\$1,955	\$2,022	\$2,164	\$2,389	\$2,455	\$2,598
	36	66	36	122	62	LKT3666-36BTT	\$1,899	\$1,961	\$2,090	\$2,333	\$2,395	\$2,524
	36	60	36	130	57	LKT3660-36BTT	\$1,833	\$1,893	\$2,005	\$2,267	\$2,325	\$2,439

Features:

- price reflects complete table - top and base
- ships KD in multiple cartons
- model includes adjustable glide

Options:

- specify power option and or charging option, see below for options and upcharges



top shape

LOK - TEAMWORK

To Order Specify

1 Laminite Model #	2 Edge Detail	3 Laminite Selection	3a PVC Edge Color	4 Electrical
Laminite (LKT)	See Edge Detail Options	See Laminite Selection	See PVC Edge Color Options	N None CT2 Dual Power Center Top (See chart on next page) CU1 Single Power Underside 5 Metal Finish See Metal Finish Color Options

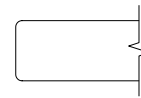
Model Number Breakdown

LKT4872-36BTT					
LK	T	4872	36	BT	T
LOK	Laminite	48" x 72"	Height	Boat Top Shape	T base

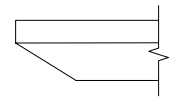
Description

Boat Table with T Base at Counter Height
(continued)

Veneer Tables
"LKV" Models



Eased Edge (R3)



Reverse Bevel Edge (K9)

D	W	H	CTN WT	CU FT	① Model	Eased Edge (R3)		Reverse Bevel Edge (K9)	
						Flat Cut	Double Cut	Flat Cut	Double Cut
48	72	36	156	87	LKV4872-36BTT	\$2,784	\$3,007	\$3,033	\$3,231
42	72	36	143	78	LKV4272-36BTT	\$2,678	\$2,891	\$2,920	\$3,108
36	72	36	130	66	LKV3672-36BTT	\$2,570	\$2,776	\$2,803	\$2,985
36	66	36	122	62	LKV3666-36BTT	\$2,485	\$2,684	\$2,710	\$2,885
36	60	36	130	57	LKV3660-36BTT	\$2,430	\$2,626	\$2,649	\$2,821

VENEER

LOK - TEAMWORK

Electrical Options and Upcharges

CT2	
Dual Power Center Top - Black	CT2BL - add \$1,437
Dual Power Center Top - White	CT2WH - add \$1,437
CU1	
Single Power Underside - Black	CU11C - add \$559
Single Power Underside with Wireless Charging- Black	CU11CW - add \$1,338

Note: Order power infeed that best fits application

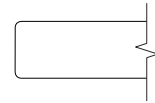
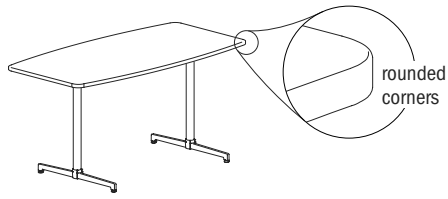
To Order, Specify:

① Veneer Model #	② Edge Detail	③ Wood Species	④ Top Wood Finish	⑤ Electrical	⑥ Metal Color
Veneer (LKV)	See Edge Detail Options	Flat Cut B01 Black Oak CH1 Cherry MA1 Maple WA1 Walnut	See Flat Cut Top Wood Finish Options	N None CT2 Dual Power Center Top CU1 Single Power Underside (See chart above)	See Metal Finish Color Options
		Double Cut DC1 Double Cut	④ Top Wood Finish See Double Cut Top Wood Finish Options		

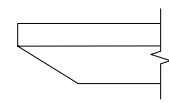
Description

Rounded Boat Table with T Base at Counter Height

Laminate Tables
"LKT" Models



Eased Edge (R3)



Reverse Bevel Edge (K9)

LAMINATE	D	W	H	CTN WT	CU FT	Model	Standard			Graded In		
							Tier 1	Tier 2	Tier 3	Tier 1	Tier 2	Tier 3
	48	72	36	156	87	LKT4872-36BTRT	\$2,209	\$2,253	\$2,516	\$2,705	\$2,749	\$2,935
42	72	36	143	78	LKT4272-36BTRT	\$2,109	\$2,147	\$2,377	\$2,594	\$2,632	\$2,796	
36	72	36	130	66	LKT3672-36BTRT	\$1,955	\$2,022	\$2,164	\$2,389	\$2,455	\$2,598	
36	66	36	122	62	LKT3666-36BTRT	\$1,899	\$1,961	\$2,090	\$2,333	\$2,395	\$2,524	
36	60	36	130	57	LKT3660-36BTRT	\$1,833	\$1,893	\$2,005	\$2,267	\$2,325	\$2,439	

Features:

- price reflects complete table - top and base
- ships KD in multiple cartons
- model includes adjustable glide

Options:

- specify power option and or charging option, see below for options and upcharges



top shape

LOK - TEAMWORK

To Order Specify

1 Laminite Model #	2 Edge Detail	3 Laminite Selection	3a PVC Edge Color	4 Electrical
Laminite (LKT)	See Edge Detail Options	See Laminite Selection	See PVC Edge Color Options	N None CT2 Dual Power Center Top (See chart on next page) CU1 Single Power Underside 5 Metal Finish See Metal Finish Color Options

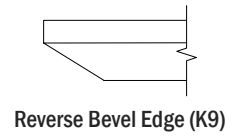
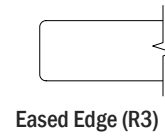
Model Number Breakdown

LKT3048-29TTT						
LK	T	4872	36	BT	R	T
LOK	Laminite	48" x 72"	Height	Boat Top Shape	Rounded Corner	T base

Description

Rounded Boat Table with T Base at Counter Height
(continued)

Veneer Tables
"LKV" Models



VENEER	D	W	H	CTN WT	CU FT	① Model	Eased Edge (R3)		Reverse Bevel Edge (K9)	
							Flat Cut	Double Cut	Flat Cut	Double Cut
	48	72	36	156	87	LKV4872-36BTRT	\$2,784	\$3,007	\$3,033	\$3,231
	42	72	36	143	78	LKV4272-36BTRT	\$2,678	\$2,891	\$2,920	\$3,108
	36	72	36	130	66	LKV3672-36BTRT	\$2,570	\$2,776	\$2,803	\$2,985
	36	66	36	122	62	LKV3666-36BTRT	\$2,485	\$2,684	\$2,710	\$2,885
	36	60	36	130	57	LKV3660-36BTRT	\$2,430	\$2,626	\$2,649	\$2,821

LOK - TEAMWORK

Electrical Options and Upcharges

CT2	
Dual Power Center Top - Black	CT2BL - add \$1,437
Dual Power Center Top - White	CT2WH - add \$1,437
CU1	
Single Power Underside - Black	CU11C - add \$559
Single Power Underside with Wireless Charging- Black	CU11CW - add \$1,338

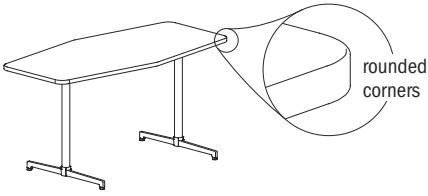
Note: Order power infeed that best fits application

To Order, Specify:

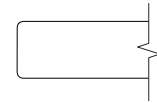
① Veneer Model #	② Edge Detail	③ Wood Species	④ Top Wood Finish	⑤ Electrical	⑥ Metal Color
Veneer (LKV)	See Edge Detail Options	Flat Cut B01 Black Oak CH1 Cherry MA1 Maple WA1 Walnut	See Flat Cut Top Wood Finish Options	N None CT2 Dual Power Center Top CU1 Single Power Underside (See chart above)	See Metal Finish Color Options
		Double Cut DC1 Double Cut	④ Top Wood Finish See Double Cut Top Wood Finish Options		

Description

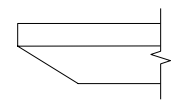
Rounded Double Chevron Table with T Base at Counter Height



Laminate Tables "LKT" Models



Eased Edge (R3)



Reverse Bevel Edge (K9)

D	W	H	CTN WT	CU FT	Model	Standard		Graded In		Standard		Graded In	
						Tier 1	Tier 2	Tier 3	Tier 1	Tier 2	Tier 3		
48	72	36	150	87	LKT4872-36DCRT	\$2,209	\$2,253	\$2,516	\$2,705	\$2,749	\$2,935		
48	60	36	131	74	LKT4860-36DCRT	\$2,044	\$2,079	\$2,302	\$2,527	\$2,563	\$2,719		
42	72	36	136	77	LKT4272-36DCRT	\$2,109	\$2,147	\$2,377	\$2,594	\$2,632	\$2,796		
42	60	36	119	65	LKT4260-36DCRT	\$1,960	\$1,991	\$2,183	\$2,435	\$2,467	\$2,604		
36	72	36	122	66	LKT3672-36DCRT	\$1,955	\$2,022	\$2,164	\$2,389	\$2,455	\$2,598		
36	60	36	122	57	LKT3660-36DCRT	\$1,833	\$1,893	\$2,005	\$2,267	\$2,325	\$2,439		

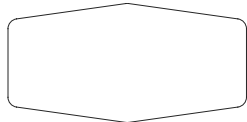
LAMINATE

Features:

- price reflects complete table - top and base
- ships KD in multiple cartons
- model includes adjustable glide

Options:

- specify power option and or charging option, see below for options and upcharges



top shape

LOK - TEAMWORK

To Order Specify

1 Laminate Model #	2 Edge Detail	3 Laminate Selection	3a PVC Edge Color	4 Electrical
Laminate (LKT)	See Edge Detail Options	See Laminate Selection	See PVC Edge Color Options	N None CT2 Dual Power Center Top (See chart on next page) CU1 Single Power Underside 5 Metal Finish See Metal Finish Color Options

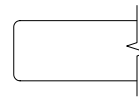
Model Number Breakdown

LKT4872-36DCRT						
LK	T	4872	36	DC	R	T
LOK	Laminate	48" x 72"	Height	Double Chevron Top Shape	Rounded Corner	T base

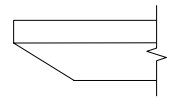
Description

Rounded Double Chevron Table with T Base at Counter Height
(continued)

Veneer Tables
"LKV" Models



Eased Edge (R3)



Reverse Bevel Edge (K9)

VENEER	D	W	H	CTN WT	CU FT	① Model	Eased Edge (R3)		Reverse Bevel Edge (K9)	
							Flat Cut	Double Cut	Flat Cut	Double Cut
	48	72	36	150	87	LKV4872-36DCRT	\$2,784	\$3,007	\$3,033	\$3,231
	48	60	36	131	74	LKV4860-36DCRT	\$2,610	\$2,818	\$2,846	\$3,029
	42	72	36	136	77	LKV4272-36DCRT	\$2,678	\$2,891	\$2,920	\$3,108
	42	60	36	119	65	LKV4260-36DCRT	\$2,522	\$2,722	\$2,749	\$2,926
	36	72	36	122	66	LKV3672-36DCRT	\$2,535	\$2,738	\$2,763	\$2,942
	36	60	36	122	57	LKV3660-36DCRT	\$2,394	\$2,587	\$2,610	\$2,779

LOK - TEAMWORK

Electrical Options and Upcharges

CT2	
Dual Power Center Top - Black	CT2BL - add \$1,437
Dual Power Center Top - White	CT2WH - add \$1,437
CU1	
Single Power Underside - Black	CU11C - add \$559
Single Power Underside with Wireless Charging - Black	CU11CW - add \$1,338

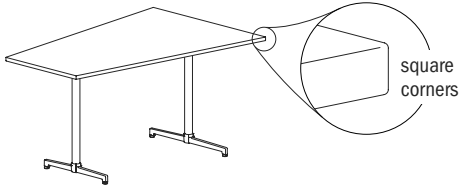
Note: Order power infeed that best fits application

To Order, Specify:

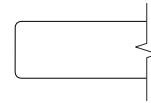
① Veneer Model #	② Edge Detail	③ Wood Species	④ Top Wood Finish	⑤ Electrical	⑥ Metal Color
Veneer (LKV)	See Edge Detail Options	Flat Cut BO1 Black Oak CH1 Cherry MA1 Maple WA1 Walnut	See Flat Cut Top Wood Finish Options	N None CT2 Dual Power Center Top CU1 Single Power Underside (See chart above)	See Metal Finish Color Options
		Double Cut DC1 Double Cut	④ Top Wood Finish See Double Cut Top Wood Finish Options		

Description

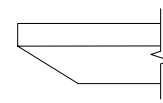
Taper Table with T Base at Counter Height



**Laminate Tables
"LKT" Models**



Eased Edge (R3)



Reverse Bevel Edge (K9)

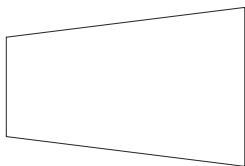
LAM.	D	W	H	CTN WT	CU FT	Model	Standard	Graded In		Standard	Graded In	
							Tier 1	Tier 2	Tier 3	Tier 1	Tier 2	Tier 3
	48	72	36	140	87	LKT4872-36TPT	\$2,220	\$2,265	\$2,526	\$2,715	\$2,759	\$2,947

Features:

- price reflects complete table - top and base
- ships KD in multiple cartons
- model includes adjustable glide

Options:

- specify power option and or charging option, see below for options and upcharges



top shape

LOK - TEAMWORK

To Order Specify

1 Laminate Model #	2 Edge Detail	3 Laminate Selection	3a PVC Edge Color	4 Electrical
Laminate (LKT)	See Edge Detail Options	See Laminate Selection	See PVC Edge Color Options	N None CT2 Dual Power Center Top (See chart on next page) CU1 Single Power Underside 5 Metal Finish See Metal Finish Color Options

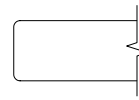
Model Number Breakdown

LKT4872-36TPT					
LK	T	4872	36	TP	T
LOK	Laminate	48" x 72"	Height	Taper Top Shape	T base

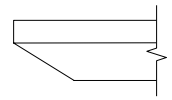
Description

Taper Table with T Base at Counter Height
(continued)

Veneer Tables
"LKV" Models



Eased Edge (R3)



Reverse Bevel Edge (K9)

VEN.	D	W	H	CTN WT	CU FT	① Model	Eased Edge (R3)		Reverse Bevel Edge (K9)	
							Flat Cut	Double Cut	Flat Cut	Double Cut
	48	72	36	140	87	LKV4872-36TPT	\$2,794	\$3,019	\$3,047	\$3,245

LOK - TEAMWORK

Electrical Options and Upcharges

CT2	
Dual Power Center Top - Black	CT2BL - add \$1,437
Dual Power Center Top - White	CT2WH - add \$1,437
CU1	
Single Power Underside - Black	CU11C - add \$559
Single Power Underside with Wireless Charging- Black	CU11CW - add \$1,338

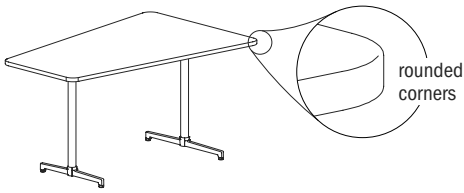
Note: Order power infeed that best fits application

To Order, Specify:

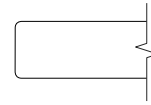
① Veneer Model #	② Edge Detail	③ Wood Species	④ Top Wood Finish	⑤ Electrical	⑥ Metal Color
Veneer (LKV)	See Edge Detail Options	Flat Cut B01 Black Oak CH1 Cherry MA1 Maple WA1 Walnut	See Flat Cut Top Wood Finish Options	N None CT2 Dual Power Center Top CU1 Single Power Underside (See chart above)	See Metal Finish Color Options
		Double Cut DC1 Double Cut	④ Top Wood Finish See Double Cut Top Wood Finish Options		

Description

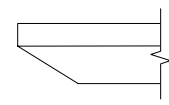
Rounded Taper Table with T Base at Counter Height



Laminate Tables
"LKT" Models



Eased Edge (R3)



Reverse Bevel Edge (K9)

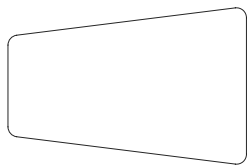
LAM.	D	W	H	CTN WT	CU FT	Model	Standard	Graded In		Standard	Graded In	
							Tier 1	Tier 2	Tier 3	Tier 1	Tier 2	Tier 3
	48	72	36	140	87	LKT4872-36TPRT	\$2,220	\$2,265	\$2,526	\$2,715	\$2,759	\$2,947

Features:

- price reflects complete table - top and base
- ships KD in multiple cartons
- model includes adjustable glide

Options:

- specify power option and or charging option, see below for options and upcharges



top shape

LOK - TEAMWORK

To Order Specify

1 Laminate Model #	2 Edge Detail	3 Laminate Selection	3a PVC Edge Color	4 Electrical
Laminate (LKT)	See Edge Detail Options	See Laminate Selection	See PVC Edge Color Options	N None CT2 Dual Power Center Top (See chart on next page) CU1 Single Power Underside 5 Metal Finish See Metal Finish Color Options

Model Number Breakdown

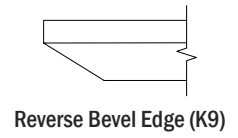
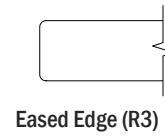
LKT4872-36TPRT						
LK	T	4872	36	TP	R	T
LOK	Laminate	48" x 72"	Height	Taper Top Shape	Rounded Corner	T base

133.21 Lok

Description

Rounded Taper Table with T Base at Counter Height
(continued)

Veneer Tables
"LKV" Models



VEN.	D	W	H	CTN WT	CU FT	① Model	Eased Edge (R3)		Reverse Bevel Edge (K9)	
							Flat Cut	Double Cut	Flat Cut	Double Cut
	48	72	36	140	87	LKV4872-36TPRT	\$2,794	\$3,019	\$3,047	\$3,245

LOK - TEAMWORK

Electrical Options and Upcharges

CT2	
Dual Power Center Top - Black	CT2BL - add \$1,437
Dual Power Center Top - White	CT2WH - add \$1,437
CU1	
Single Power Underside - Black	CU11C - add \$559
Single Power Underside with Wireless Charging- Black	CU11CW - add \$1,338

Note: Order power infeed that best fits application

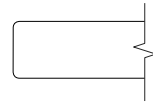
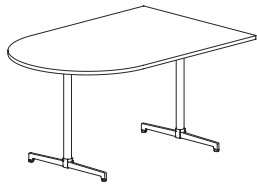
To Order, Specify:

① Veneer Model #	② Edge Detail	③ Wood Species	④ Top Wood Finish	⑤ Electrical	⑥ Metal Color
Veneer (LKV)	See Edge Detail Options	Flat Cut B01 Black Oak CH1 Cherry MA1 Maple WA1 Walnut	See Flat Cut Top Wood Finish Options	N None CT2 Dual Power Center Top CU1 Single Power Underside (See chart above)	See Metal Finish Color Options
		Double Cut DC1 Double Cut	④ Top Wood Finish See Double Cut Top Wood Finish Options		

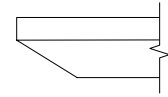
Description

Bullet Table with T Base at Counter Height

Laminate Tables
"LKT" Models



Eased Edge (R3)



Reverse Bevel Edge (K9)

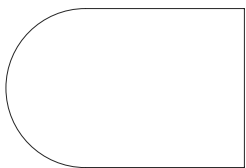
LAM.	D	W	H	CTN WT	CU FT	Model	Standard	Graded In		Standard	Graded In	
							Tier 1	Tier 2	Tier 3	Tier 1	Tier 2	Tier 3
	48	72	36	154	87	LKT4872-36BUT	\$2,209	\$2,253	\$2,516	\$2,705	\$2,749	\$2,935

Features:

- price reflects complete table - top and base
- ships KD in multiple cartons
- model includes adjustable glide

Options:

- specify power option and or charging option, see below for options and upcharges



top shape

LOK - TEAMWORK

To Order Specify

1 Laminate Model #	2 Edge Detail	3 Laminate Selection	3a PVC Edge Color	4 Electrical
Laminate (LKT)	See Edge Detail Options	See Laminate Selection	See PVC Edge Color Options	N None CT2 Dual Power Center Top (See chart on next page) CU1 Single Power Underside 5 Metal Finish See Metal Finish Color Options

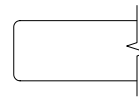
Model Number Breakdown

LKT4872-36BUT					
LK	T	4872	36	BU	T
LOK	Laminate	48" x 72"	Height	Bullet Top Shape	T base

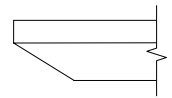
Description

Bullet Table with T Base at Counter Height
(continued)

Veneer Tables
"LKV" Models



Eased Edge (R3)



Reverse Bevel Edge (K9)

VEN.	D	W	H	CTN WT	CU FT	① Model	Eased Edge (R3)		Reverse Bevel Edge (K9)	
							Flat Cut	Double Cut	Flat Cut	Double Cut
	48	72	36	154	87	LKV4872-36BUT	\$2,784	\$3,007	\$3,033	\$3,231

LOK - TEAMWORK

Electrical Options and Upcharges

CT2	
Dual Power Center Top - Black	CT2BL - add \$1,437
Dual Power Center Top - White	CT2WH - add \$1,437
CU1	
Single Power Underside - Black	CU11C - add \$559
Single Power Underside with Wireless Charging- Black	CU11CW - add \$1,338

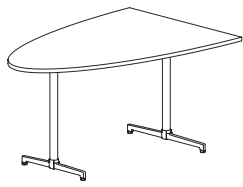
Note: Order power infeed that best fits application

To Order, Specify:

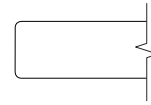
① Veneer Model #	② Edge Detail	③ Wood Species	④ Top Wood Finish	⑤ Electrical	⑥ Metal Color
Veneer (LKV)	See Edge Detail Options	Flat Cut BO1 Black Oak CH1 Cherry MA1 Maple WA1 Walnut	See Flat Cut Top Wood Finish Options	N None CT2 Dual Power Center Top CU1 Single Power Underside (See chart above)	See Metal Finish Color Options
		Double Cut DC1 Double Cut	④ Top Wood Finish See Double Cut Top Wood Finish Options		

Description

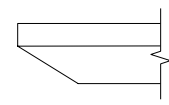
Hive Table with T Base at Counter Height



**Laminate Tables
"LKT" Models**



Eased Edge (R3)



Reverse Bevel Edge (K9)

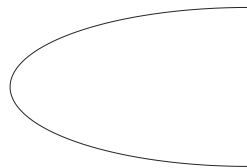
LAM.	D	W	H	CTN WT	CU FT	Model	Standard		Graded In		Standard		Graded In	
							Tier 1	Tier 2	Tier 3	Tier 1	Tier 2	Tier 3		
							48	72	36	135	87	LKT4872-36HVT	\$2,209	\$2,253

Features:

- price reflects complete table - top and base
- ships KD in multiple cartons
- model includes adjustable glide

Options:

- specify power option and or charging option, see below for options and upcharges



top shape

LOK - TEAMWORK

To Order Specify

1 Laminate Model #	2 Edge Detail	3 Laminate Selection	3a PVC Edge Color	4 Electrical
Laminate (LKT)	See Edge Detail Options	See Laminate Selection	See PVC Edge Color Options	N None CT2 Dual Power Center Top (See chart on next page) CU1 Single Power Underside 5 Metal Finish See Metal Finish Color Options

Model Number Breakdown

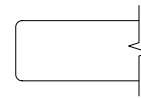
LKT4872-36HVT					
LK	T	4872	36	HV	T
LOK	Laminate	48" x 72"	Height	Hive Top Shape	T base

133.25 Lok

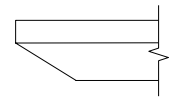
Description

Hive Table with T Base at Counter Height
(continued)

Veneer Tables
"LKV" Models



Eased Edge (R3)



Reverse Bevel Edge (K9)

VEN.	D	W	H	CTN WT	CU FT	① Model	Eased Edge (R3)		Reverse Bevel Edge (K9)	
							Flat Cut	Double Cut	Flat Cut	Double Cut
	48	72	36	135	87	LKV4872-36HVT	\$2,784	\$3,007	\$3,033	\$3,231

LOK - TEAMWORK

Electrical Options and Upcharges

CT2	
Dual Power Center Top - Black	CT2BL - add \$1,437
Dual Power Center Top - White	CT2WH - add \$1,437
CU1	
Single Power Underside - Black	CU11C - add \$559
Single Power Underside with Wireless Charging- Black	CU11CW - add \$1,338

Note: Order power infeed that best fits application

To Order, Specify:

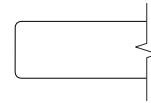
① Veneer Model #	② Edge Detail	③ Wood Species	④ Top Wood Finish	⑤ Electrical	⑥ Metal Color
Veneer (LKV)	See Edge Detail Options	Flat Cut B01 Black Oak CH1 Cherry MA1 Maple WA1 Walnut	See Flat Cut Top Wood Finish Options	N None CT2 Dual Power Center Top CU1 Single Power Underside (See chart above)	See Metal Finish Color Options
		Double Cut DC1 Double Cut	④ Top Wood Finish See Double Cut Top Wood Finish Options		

Description

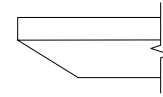
Intersect Table with T Base at Counter Height



Laminate Tables
"LKT" Models



Eased Edge (R3)



Reverse Bevel Edge (K9)

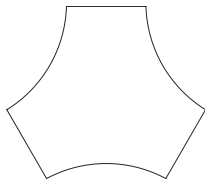
LAMINATE	D	W	H	CTN WT	CU FT	❶ Model	Standard			Graded In		
							Tier 1	Tier 2	Tier 3	Tier 1	Tier 2	Tier 3
	30	60	36	118	48	LKT3060-36INT	\$1,980	\$2,002	\$2,141	\$2,438	\$2,460	\$2,559
24	60	36	113	40	LKT2460-36INT	\$1,935	\$1,953	\$2,065	\$2,384	\$2,403	\$2,481	

Features:

- price reflects complete table - top and base
- ships KD in multiple cartons
- model includes adjustable glide

Options:

- specify power option; None (N), add \$643 for EC23 (CTEC23), add \$533 for EC24 (CTEC24)



top shape

LOK - TEAMWORK

To Order Specify

Laminate Model #	❷ Edge Detail	❸ Laminate Selection	❹ PVC Edge Color	❺ Electrical
Laminate (LKT)	See Edge Detail Options	See Laminate Selection	See PVC Edge Color Options	N None CTEC23 Power Center Top (See chart on next page) CTEC24 Power Center Top ❺ Metal Finish See Metal Finish Color Options

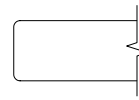
Model Number Breakdown

LKT3060-36INT					
LK	T	3060	36	IN	T
LOK	Laminate	30" x 60"	Height	Intersect Top Shape	T base

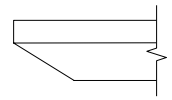
Description

Intersect Table with T Base at Counter Height
(continued)

Veneer Tables
"LKV" Models



Eased Edge (R3)



Reverse Bevel Edge (K9)

VENEER	D	W	H	CTN WT	CU FT	① Model	Eased Edge (R3)		Reverse Bevel Edge (K9)	
							Flat Cut	Double Cut	Flat Cut	Double Cut
	30	60	36	118	48	LKV3060-36INT	\$2,529	\$2,731	\$2,756	\$2,935
	24	60	36	113	40	LKV2460-36INT	\$2,485	\$2,684	\$2,710	\$2,885

LOK - TEAMWORK

Electrical Options and Upcharges

CTEC23	
EC23 Power Center Top - Black	CTEC23BL - add \$643
EC23 Power Center Top - White	CTEC23WH - add \$643
CTEC24	
EC24 Power Center Top - Black	CTEC43BL - add \$533
EC24 Power Center Top - White	CTEC43WH - add \$533

Note: Order power infeed that best fits application

To Order, Specify:

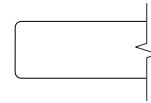
① Veneer Model #	② Edge Detail	③ Wood Species	④ Top Wood Finish	⑤ Electrical	⑥ Metal Color
Veneer (LKV)	See Edge Detail Options	Flat Cut B01 Black Oak CH1 Cherry MA1 Maple WA1 Walnut	See Flat Cut Top Wood Finish Options	N None CTEC23 Power Center Top CTEC24 Power Center Top (See chart above)	See Metal Finish Color Options
		Double Cut DC1 Double Cut	④ Top Wood Finish See Double Cut Top Wood Finish Options		

Description

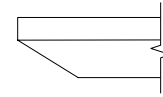
Huddle Table with T Base at Counter Height



Laminate Tables
"LKT" Models



Eased Edge (R3)



Reverse Bevel Edge (K9)

LAMINATE	D	W	H	CTN WT	CU FT	❶ Model	Standard Tier 1	Graded In Tier 2 Tier 3		Standard Tier 1	Graded In Tier 2 Tier 3	
	36	84	36	143	78	LKT3684-36HUT	\$3,037	\$3,079	\$3,337	\$3,575	\$3,618	\$3,801
	30	72	36	116	56	LKT3072-36HUT	\$2,358	\$2,387	\$2,553	\$2,824	\$2,851	\$2,969

Features:

- price reflects complete table - top and base
- ships KD in multiple cartons
- model includes adjustable glide

Options:

- specify power option; None (N), add \$643 for EC23 (CTEC23), add \$533 for EC24 (CTEC24)



top shape

LOK - TEAMWORK

To Order Specify

❶ Laminate Model #	❷ Edge Detail	❸ Laminate Selection	❹ PVC Edge Color	❺ Electrical
Laminate (LKT)	See Edge Detail Options	See Laminate Selection	See PVC Edge Color Options	N None CTEC23 Power Center Top (See chart on next page) CTEC24 Power Center Top ❻ Metal Finish See Metal Finish Color Options.

Model Number Breakdown

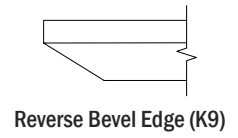
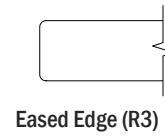
LKT3684-36HUT					
LK	T	3684	36	HU	T
LOK	Laminate	36" x 84"	Height	Huddle Top Shape	T base

133.29 Lok

Description

Huddle Table with T Base at Counter Height
(continued)

Veneer Tables
"LKV" Models



VENEER	D	W	H	CTN WT	CU FT	① Model	Eased Edge (R3)		Reverse Bevel Edge (K9)	
							Flat Cut	Double Cut	Flat Cut	Double Cut
	36	84	36	143	78	LKV3684-36HUT	\$3,426	\$3,702	\$3,736	\$3,977
	30	72	36	116	56	LKV3072-36HUT	\$2,914	\$3,147	\$3,177	\$3,383

LOK - TEAMWORK

Electrical Options and Upcharges

CTEC23	
EC23 Power Center Top - Black	CTEC23BL - add \$643
EC23 Power Center Top - White	CTEC23WH - add \$643
CTEC24	
EC24 Power Center Top - Black	CTEC43BL - add \$533
EC24 Power Center Top - White	CTEC43WH - add \$533

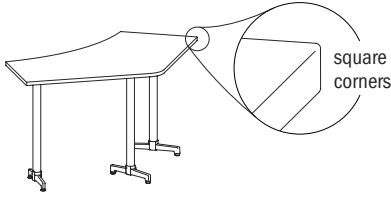
Note: Order power infeed that best fits application

To Order, Specify:

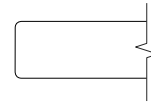
① Veneer Model #	② Edge Detail	③ Wood Species	④ Top Wood Finish	⑤ Electrical	⑥ Metal Color
Veneer (LKV)	See Edge Detail Options	Flat Cut B01 Black Oak CH1 Cherry MA1 Maple WA1 Walnut	See Flat Cut Top Wood Finish Options	N None CTEC23 Power Center Top CTEC24 Power Center Top (See chart above)	See Metal Finish Color Options
		Double Cut DC1 Double Cut	④ Top Wood Finish See Double Cut Top Wood Finish Options		

Description

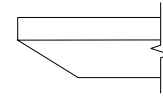
One-twenty Table with T Base at Counter Height



Laminate Tables
"LKT" Models



Eased Edge (R3)



Reverse Bevel Edge (K9)

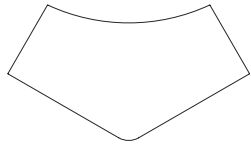
LAMINATE	D	W	H	CTN WT	CU FT	Model	Standard			Graded In		
							Tier 1	Tier 2	Tier 3	Tier 1	Tier 2	Tier 3
	45	84	36	118	94	LKT4584-36YGT	\$2,913	\$2,962	\$3,262	\$3,419	\$3,467	\$3,681
42	73	36	107	78	LKT4273-36YGT	\$2,524	\$2,561	\$2,791	\$3,010	\$3,047	\$3,211	

Features:

- price reflects complete table - top and base
- ships KD in multiple cartons
- model includes adjustable glide

Options:

- specify power option and or charging option, see below for options and upcharges



top shape

LOK - TEAMWORK

To Order Specify

1 Laminate Model #	2 Edge Detail	3 Laminate Selection	4 PVC Edge Color	5 Electrical
Laminate (LKT)	See Edge Detail Options	See Laminate Selection	See PVC Edge Color Options	N None CT1 Single Power Center Top CU1 Single Power Underside CT1U1 Single Power Center Top LRT2 Dual Power Left/Right LRT2CU1 Dual Power Left/Right Top w/Underside (See chart on next page)
				6 Metal Finish
				See Metal Finish Color Options

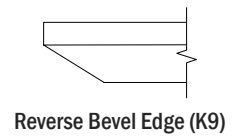
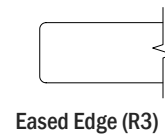
Model Number Breakdown

LKT4584-36YGT					
LK	T	4584	36	YG	T
LOK	Laminate	45" x 84"	Height	One-Twenty Top Shape	T base

Description

One-twenty Table with T Base at Counter Height
(continued)

Veneer Tables
"LKV" Models



VENEER	D	W	H	CTN WT	CU FT	① Model	Flat Cut	Double Cut	Flat Cut	Double Cut
		45	84	36	118	94	LKV4584-36YGT	\$3,307	\$3,571	\$3,604
	42	73	36	107	78	LKV4273-36YGT	\$3,094	\$3,341	\$3,371	\$3,591

Electrical Options and Upcharges

	73 - 84 wide	
	Circuit 1	Circuit 2
CT1		
Single Power Center Top - Black	CT11CBL - add \$665	CT12CBL - add \$665
Single Power Center Top - White	CT11CWH - add \$665	CT12CWH - add \$665
CU1		
Single Power Underside - Black	CU11C - add \$691	CU12C - add \$691
Single Power Underside with Wireless Charging - Black	CU11CW - add \$1,495	CU12CW - add \$1,495
CT1U1		
Single Power Center Top - Black with Underside	CT1U1-1CBL - add \$1,297	CT1U1-2CBL - add \$1,297
Single Power Center Top - White with Underside	CT1U1-1CWH - add \$1,297	CT1U1-2CWH - add \$1,297
Single Power Center Top - Black with Wireless Charging	CT1U1-1CWBL - add \$2,075	CT1U1-2CWBL - add \$2,075
Single Power Center Top - White with Wireless Charging	CT1U1-1CWHW - add \$2,075	CT1U1-2CWHW - add \$2,075
LRT2CU1		
Dual Power Left/Right Top with Underside - Black	LRT2CU1-1CBL - add \$2,416	LRT2CU1-2CBL - add \$2,416
Dual Power Left/Right Top with Underside - White	LRT2CU1-1CWH - add \$2,416	LRT2CU1-2CWH - add \$2,416
Dual Power Left/Right Top - Black with Underside & Wireless Charging	LRT2CU1-1CWBL - add \$3,196	LRT2CU1-2CWBL - add \$3,196
Dual Power Left/Right Top - White with Underside & Wireless Charging	LRT2CU1-1CWHW - add \$3,196	LRT2CU1-2CWHW - add \$3,196
LRT2		
Dual Power Left/Right Top - Black	LRT2-1CBL - add \$1,173	LRT2-2CBL - add \$1,173
Dual Power Left/Right Top - White	LRT2-1CWH - add \$1,173	LRT2-2CWH - add \$1,173

LOK - TEAMWORK

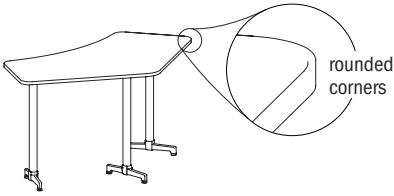
Note: Order power infeed that best fits application

To Order, Specify:

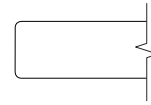
① Veneer Model #	② Edge Detail	③ Wood Species	④ Top Wood Finish	⑤ Electrical	⑥ Metal Color
Veneer (LKV)	See Edge Detail Options	Flat Cut BO1 Black Oak CH1 Cherry MA1 Maple WA1 Walnut	See Flat Cut Top Wood Finish Options	N None CT1 Single Power Center Top CU1 Single Power Underside CT1U1 Single Power Center Top LRT2 Dual Power Left/Right LRT2CU1 Dual Power Left/Right with Underside (See chart above)	See Metal Finish Color Options
		Double Cut DC1 Double Cut	④ Top Wood Finish See Double Cut Top Wood Finish Options		

Description

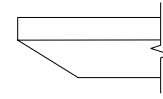
Rounded One-twenty Table with T Base at Counter Height



Laminate Tables "LKT" Models



Eased Edge (R3)



Reverse Bevel Edge (K9)

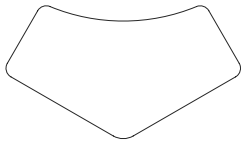
LAMINATE	D	W	H	CTN WT	CU FT	Model	Standard			Graded In		
							Tier 1	Tier 2	Tier 3	Tier 1	Tier 2	Tier 3
	45	84	36	118	94	LKT4584-36YGRT	\$2,913	\$2,962	\$3,262	\$3,419	\$3,467	\$3,681
42	73	36	107	78	LKT4273-36YGRT	\$2,524	\$2,561	\$2,791	\$3,010	\$3,047	\$3,211	

Features:

- price reflects complete table - top and base
- ships KD in multiple cartons
- model includes adjustable glide

Options:

- specify power option and or charging option, see below for options and upcharges



top shape

LOK - TEAMWORK

To Order Specify

1 Laminite Model #	2 Edge Detail	3 Laminite Selection	3a PVC Edge Color	4 Electrical
Laminite (LKT)	See Edge Detail Options	See Laminite Selection	See PVC Edge Color Options	N None CT2 Dual Power Center Top (See chart on next page) CU1 Single Power Underside 5 Metal Finish See Metal Finish Color Options

Model Number Breakdown

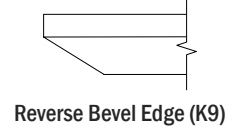
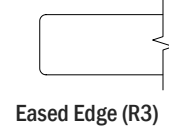
LKT4584-36YGRT						
LK	T	4584	36	YG	R	T
LOK	Laminite	45" x 84"	Height	One-Twenty Top Shape	Rounded Corner	T base

133.33 Lok

Description

Rounded One-twenty Table with T Base
at Counter Height
(continued)

Veneer Tables
"LKV" Models



VENEER	D	W	H	CTN WT	CU FT	① Model	Flat Cut	Double Cut	Flat Cut	Double Cut
		45	84	36	118	94	LKV4584-36YGRT	\$3,307	\$3,571	\$3,604
	42	73	36	107	78	LKV4273-36YGRT	\$3,094	\$3,341	\$3,371	\$3,591

Electrical Options and Upcharges

	73 - 84 wide	
	Circuit 1	Circuit 2
CT1		
Single Power Center Top - Black	CT11CBL - add \$665	CT12CBL - add \$665
Single Power Center Top - White	CT11CWH - add \$665	CT12CWH - add \$665
CU1		
Single Power Underside - Black	CU11C - add \$691	CU12C - add \$691
Single Power Underside with Wireless Charging - Black	CU11CW - add \$1,495	CU12CW - add \$1,495
CT1U1		
Single Power Center Top - Black with Underside	CT1U1-1CBL - add \$1,297	CT1U1-2CBL - add \$1,297
Single Power Center Top - White with Underside	CT1U1-1CWH - add \$1,297	CT1U1-2CWH - add \$1,297
Single Power Center Top - Black with Wireless Charging	CT1U1-1CWBL - add \$2,075	CT1U1-2CWBL - add \$2,075
Single Power Center Top - White with Wireless Charging	CT1U1-1CWHW - add \$2,075	CT1U1-2CWHW - add \$2,075
LRT2CU1		
Dual Power Left/Right Top with Underside - Black	LRT2CU1-1CBL - add \$2,416	LRT2CU1-2CBL - add \$2,416
Dual Power Left/Right Top with Underside - White	LRT2CU1-1CWH - add \$2,416	LRT2CU1-2CWH - add \$2,416
Dual Power Left/Right Top - Black with Underside & Wireless Charging	LRT2CU1-1CWBL - add \$3,196	LRT2CU1-2CWBL - add \$3,196
Dual Power Left/Right Top - White with Underside & Wireless Charging	LRT2CU1-1CWHW - add \$3,196	LRT2CU1-2CWHW - add \$3,196
LRT2		
Dual Power Left/Right Top - Black	LRT2-1CBL - add \$1,173	LRT2-2CBL - add \$1,173
Dual Power Left/Right Top - White	LRT2-1CWH - add \$1,173	LRT2-2CWH - add \$1,173

LOK - TEAMWORK

Note: Order power infeed that best fits application

To Order, Specify:

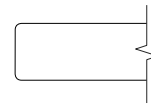
① Veneer Model #	② Edge Detail	③ Wood Species	④ Top Wood Finish	⑤ Electrical	⑥ Metal Color
Veneer (LKV)	See Edge Detail Options	Flat Cut BO1 Black Oak CH1 Cherry MA1 Maple WA1 Walnut	See Flat Cut Top Wood Finish Options	N None CT1 Single Power Center Top CU1 Single Power Underside CT1U1 Single Power Center Top LRT2 Dual Power Left/Right LRT2CU1 Dual Power Left/Right with Underside (See chart above)	See Metal Finish Color Options
	Double Cut DC1 Double Cut	④ Top Wood Finish See Double Cut Top Wood Finish Options			

Description

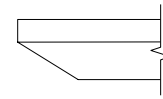
Home Base Table with X Base at Counter Height



Laminate Tables
"LKT" Models



Eased Edge (R3)

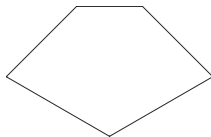


Reverse Bevel Edge (K9)

LAMINATE	D	W	H	CTN WT	CU FT	❶ Model	Standard			Graded In		
							Tier 1	Tier 2	Tier 3	Tier 1	Tier 2	Tier 3
	30	36	36	75	30	LKT3036-36HBX	\$1,396	\$1,430	\$1,473	\$1,840	\$1,868	\$1,905
24	30	36	59	21	LKT2430-36HBX	\$1,187	\$1,198	\$1,271	\$1,628	\$1,640	\$1,694	

Features:

- price reflects complete table - top and base
- ships KD in multiple cartons
- model includes adjustable glide



top shape

To Order Specify

❶ Laminite Model #	❷ Edge Detail	❸ Laminite Selection	❹ PVC Edge Color	❺ Metal Finish
Laminite (LKT)	See Edge Detail Options	See Laminite Selection	See PVC Edge Color Options.	See Metal Finish Color Options.

Model Number Breakdown

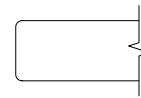
LKT3036-36HBX					
LK	T	3036	36	HB	X
LOK	Laminite	30" x 36"	Height	Home Base Top Shape	X base

133.35 Lok

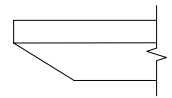
Description

Home Base Table with X Base at Counter Height
(continued)

Veneer Tables
"LKV" Models



Eased Edge (R3)



Reverse Bevel Edge (K9)

VENEER	D	W	H	CTN WT	CU FT	① Model	Eased Edge (R3)		Reverse Bevel Edge (K9)	
							Flat Cut	Double Cut	Flat Cut	Double Cut
	30	36	36	75	30	LKV3036-36HBX	\$1,828	\$1,976	\$1,991	\$2,120
	24	30	36	59	21	LKV2430-36HBX	\$1,717	\$1,854	\$1,872	\$1,993

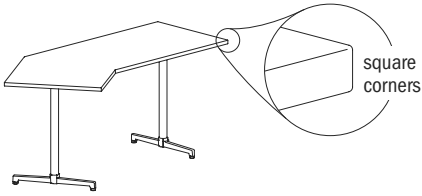
TEAMWORK

To Order, Specify:

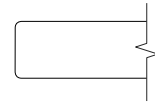
① Veneer Model #	② Edge Detail	③ Wood Species	④ Top Wood Finish	⑤ Metal Color
Veneer (LKV)	See Edge Detail Options	Flat Cut B01 Black Oak CH1 Cherry MA1 Maple WA1 Walnut	See Flat Cut Top Wood Finish Options	See Metal Finish Color Options
		Double Cut DC1 Double Cut	④ Top Wood Finish See Double Cut Top Wood Finish Options	

Description

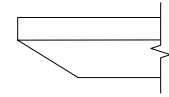
Boomerang Table - Left with T Base at Counter Height



Laminate Tables "LKT" Models



Eased Edge (R3)



Reverse Bevel Edge (K9)

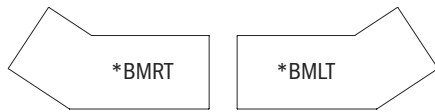
LAMINATE	D	W	H	CTN WT	CU FT	Model	Standard			Graded In		
							Tier 1	Tier 2	Tier 3	Tier 1	Tier 2	Tier 3
		36	84	36	139	78	LKT3684-36BMLT	\$2,518	\$2,559	\$2,816	\$3,057	\$3,098
	36	84	36	139	78	LKT3684-36BMRT	\$2,518	\$2,559	\$2,816	\$3,057	\$3,098	\$3,283
	30	84	36	121	66	LKT3084-36BMLT	\$2,154	\$2,184	\$2,378	\$2,626	\$2,656	\$2,794
	30	84	36	121	66	LKT3084-36BMRT	\$2,154	\$2,184	\$2,378	\$2,626	\$2,656	\$2,794

Features:

- price reflects complete table - top and base
- ships KD in multiple cartons
- model includes adjustable glide

Options:

- specify power option and or charging option, see below for options and upcharges



plan view

LOK - TEAMWORK

To Order Specify

1 Laminate Model #	2 Edge Detail	3 Laminate Selection	3a PVC Edge Color	4 Electrical
Laminate (LKT)	See Edge Detail Options	See Laminate Selection	See PVC Edge Color Options	<p>4 Electrical</p> <p>N None CT1 Single Power Center Top CU1 Single Power Underside</p> <p>CT1U1 Single Power Center Top LRT2 Dual Power Left/Right LRT2CU1 Dual Power Left/Right Top w/Underside (See chart on next page)</p> <p>5 Metal Finish</p> <p>See Metal Finish Color Options.</p>

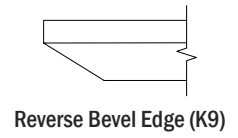
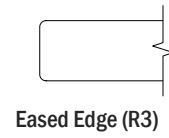
Model Number Breakdown

LKT3684-36BMLT					
LK	T	3684	36	BML	T
LOK	Laminate	36" x 84"	Height	Boomerang Left Top Shape	T base

Description

Boomerang Table - Left with T Base
at Counter Height
(continued)

Veneer Tables
"LKV" Models



VENEER	D	W	H	CTN WT	CU FT	① Model	Flat Cut	Double Cut	Flat Cut	Double Cut
		36	84	36	139	78	LKV3684-36BMLT	\$3,209	\$3,464	\$3,497
	36	84	36	139	78	LKV3684-36BMRT	\$3,209	\$3,464	\$3,497	\$3,722
	30	84	36	121	66	LKV3084-36BMLT	\$2,810	\$3,032	\$3,060	\$3,258
	30	84	36	121	66	LKV3084-36BMRT	\$2,810	\$3,032	\$3,060	\$3,258

Electrical Options and Upcharges

	73 - 84 wide	
	Circuit 1	Circuit 2
CT1		
Single Power Center Top - Black	CT11CBL - add \$665	CT12CBL - add \$665
Single Power Center Top - White	CT11CWH - add \$665	CT12CWH - add \$665
CU1		
Single Power Underside - Black	CU11C - add \$691	CU12C - add \$691
Single Power Underside with Wireless Charging - Black	CU11CW - add \$1,495	CU12CW - add \$1,495
CT1U1		
Single Power Center Top - Black with Underside	CT1U1-1CBL - add \$1,297	CT1U1-2CBL - add \$1,297
Single Power Center Top - White with Underside	CT1U1-1CWH - add \$1,297	CT1U1-2CWH - add \$1,297
Single Power Center Top - Black with Wireless Charging	CT1U1-1CWBL - add \$2,075	CT1U1-2CWBL - add \$2,075
Single Power Center Top - White with Wireless Charging	CT1U1-1CWHW - add \$2,075	CT1U1-2CWHW - add \$2,075
LRT2CU1		
Dual Power Left/Right Top with Underside - Black	LRT2CU1-1CBL - add \$2,416	LRT2CU1-2CBL - add \$2,416
Dual Power Left/Right Top with Underside - White	LRT2CU1-1CWH - add \$2,416	LRT2CU1-2CWH - add \$2,416
Dual Power Left/Right Top with Underside & Wireless Charging	LRT2CU1-1CWBL - add \$3,196	LRT2CU1-2CWBL - add \$3,196
Dual Power Left/Right Top with Underside & Wireless Charging	LRT2CU1-1CWHW - add \$3,196	LRT2CU1-2CWHW - add \$3,196
LRT2		
Dual Power Left/Right Top - Black	LRT2-1CBL - add \$1,173	LRT2-2CBL - add \$1,173
Dual Power Left/Right Top - White	LRT2-1CWH - add \$1,173	LRT2-2CWH - add \$1,173

LOK - TEAMWORK

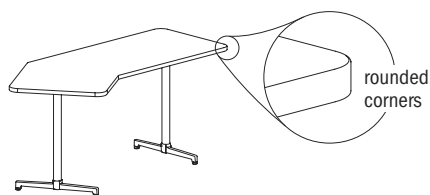
Note: Order power infeed that best fits application

To Order, Specify:

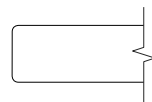
① Veneer Model #	② Edge Detail	③ Wood Species	④ Top Wood Finish	⑤ Electrical	⑥ Metal Color
Veneer (LKV)	See Edge Detail Options	<p>Flat Cut</p> <p>BO1 Black Oak CH1 Cherry MA1 Maple WA1 Walnut</p>	See Flat Cut Top Wood Finish Options	<p>N None</p> <p>CT1 Single Power Center Top</p> <p>CU1 Single Power Underside</p> <p>CT1U1 Single Power Center Top</p> <p>LRT2 Dual Power Left/Right</p> <p>LRT2CU1 Dual Power Left/Right with Underside</p> <p>(See chart above)</p>	See Metal Finish Color Options
		<p>Double Cut</p> <p>DC1 Double Cut</p>	<p>④ Top Wood Finish</p> <p>See Double Cut Top Wood Finish Options</p>		

Description

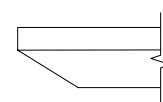
Rounded Boomerang Table - Left with T Base at Counter Height



Laminate Tables "LKT" Models



Eased Edge (R3)



Reverse Bevel Edge (K9)

LAMINATE	D	W	H	CTN WT	CU FT	Model	Standard			Graded In		
							Tier 1	Tier 2	Tier 3	Tier 1	Tier 2	Tier 3
	36	84	36	101	78	LKT3684-36BMLRT	\$2,518	\$2,559	\$2,816	\$3,057	\$3,098	\$3,283
36	84	36	139	78	LKT3684-36BMRRT	\$2,518	\$2,559	\$2,816	\$3,057	\$3,098	\$3,283	
30	84	36	121	66	LKT3084-36BMLRT	\$2,154	\$2,184	\$2,378	\$2,626	\$2,656	\$2,794	
30	84	36	121	66	LKT3084-36BMRRT	\$2,154	\$2,184	\$2,378	\$2,626	\$2,656	\$2,794	

Features:

- price reflects complete table - top and base
- ships KD in multiple cartons
- model includes adjustable glide

Options:

- specify power option and or charging option, see below for options and upcharges



top shape

LOK - TEAMWORK

To Order Specify

1 Laminate Model #	2 Edge Detail	3 Laminate Selection	3a PVC Edge Color	4 Electrical
Laminate (LKT)	See Edge Detail Options	See Laminate Selection	See PVC Edge Color Options	N None CT1 Single Power Center Top CU1 Single Power Underside CT1U1 Single Power Center Top LRT2 Dual Power Left/Right LRT2CU1 Dual Power Left/Right Top w/Underside (See chart on next page)
				5 Metal Finish
				See Metal Finish Color Options.

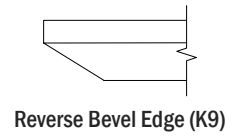
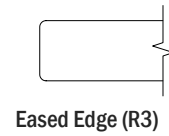
Model Number Breakdown

LKT3684-36BMLRT						
LK	T	3684	36	BML	R	T
LOK	Laminate	36" x 84"	Height	Boomerang Left Top Shape	Rounded Corner	T base

Description

Rounded Boomerang Table - Left with T Base at Counter Height
(continued)

Veneer Tables
"LKV" Models



VENEER	D	W	H	CTN WT	CU FT	① Model	Flat Cut	Double Cut	Flat Cut	Double Cut
		36	84	36	143	78	LKV3684-36BMLRT	\$3,209	\$3,464	\$3,497
	36	84	36	139	78	LKV3684-36BMRRT	\$3,209	\$3,464	\$3,497	\$3,722
	30	84	36	101	66	LKV3084-36BMLRT	\$2,810	\$3,032	\$3,060	\$3,258
	30	84	36	121	66	LKV3084-36BMRRT	\$2,810	\$3,032	\$3,060	\$3,258

Electrical Options and Upcharges

	73 - 84 wide	
	Circuit 1	Circuit 2
CT1		
Single Power Center Top - Black	CT11CBL - add \$665	CT12CBL - add \$665
Single Power Center Top - White	CT11CWH - add \$665	CT12CWH - add \$665
CU1		
Single Power Underside - Black	CU11C - add \$691	CU12C - add \$691
Single Power Underside with Wireless Charging - Black	CU11CW - add \$1,495	CU12CW - add \$1,495
CT1U1		
Single Power Center Top - Black with Underside	CT1U1-1CBL - add \$1,297	CT1U1-2CBL - add \$1,297
Single Power Center Top - White with Underside	CT1U1-1CWH - add \$1,297	CT1U1-2CWH - add \$1,297
Single Power Center Top - Black with Wireless Charging	CT1U1-1CWBL - add \$2,075	CT1U1-2CWBL - add \$2,075
Single Power Center Top - White with Wireless Charging	CT1U1-1CWHW - add \$2,075	CT1U1-2CWHW - add \$2,075
LRT2CU1		
Dual Power Left/Right Top with Underside - Black	LRT2CU1-1CBL - add \$2,416	LRT2CU1-2CBL - add \$2,416
Dual Power Left/Right Top with Underside - White	LRT2CU1-1CWH - add \$2,416	LRT2CU1-2CWH - add \$2,416
Dual Power Left/Right Top with Underside & Wireless Charging	LRT2CU1-1CWBL - add \$3,196	LRT2CU1-2CWBL - add \$3,196
Dual Power Left/Right Top - White with Underside & Wireless Charging	LRT2CU1-1CWHW - add \$3,196	LRT2CU1-2CWHW - add \$3,196
LRT2		
Dual Power Left/Right Top - Black	LRT2-1CBL - add \$1,173	LRT2-2CBL - add \$1,173
Dual Power Left/Right Top - White	LRT2-1CWH - add \$1,173	LRT2-2CWH - add \$1,173

LOK - TEAMWORK

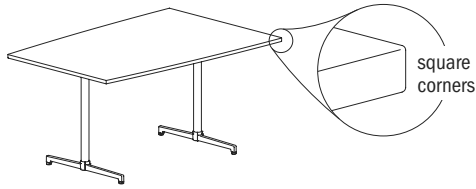
Note: Order power infeed that best fits application

To Order, Specify:

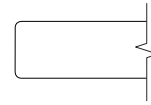
① Veneer Model #	② Edge Detail	③ Wood Species	④ Top Wood Finish	⑤ Electrical	⑥ Metal Color
Veneer (LKV)	See Edge Detail Options	Flat Cut BO1 Black Oak CH1 Cherry MA1 Maple WA1 Walnut	See Flat Cut Top Wood Finish Options	N None CT1 Single Power Center Top CU1 Single Power Underside CT1U1 Single Power Center Top LRT2 Dual Power Left/Right LRT2CU1 Dual Power Left/Right with Underside (See chart above)	See Metal Finish Color Options
	Double Cut DC1 Double Cut	④ Top Wood Finish See Double Cut Top Wood Finish Options			

Description

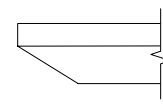
Wedge Table with T Base at Counter Height



Laminate Tables
"LKT" Models



Eased Edge (R3)



Reverse Bevel Edge (K9)

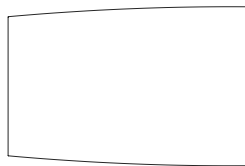
LAM.	D	W	H	CTN WT	CU FT	Model	Standard	Graded In		Standard	Graded In	
							Tier 1	Tier 2	Tier 3	Tier 1	Tier 2	Tier 3
	48	72	36	156	87	LKT4872-36WDT	\$2,209	\$2,253	\$2,516	\$2,705	\$2,749	\$2,935

Features:

- price reflects complete table - top and base
- ships KD in multiple cartons
- model includes adjustable glide

Options:

- specify power option and or charging option, see below for options and upcharges



top shape

LOK - TEAMWORK

To Order Specify

1 Laminate Model #	2 Edge Detail	3 Laminate Selection	3a PVC Edge Color	4 Electrical
Laminate (LKT)	See Edge Detail Options	See Laminate Selection	See PVC Edge Color Options	N None CT2 Dual Power Center Top (See chart on next page) CU1 Single Power Underside 5 Metal Finish See Metal Finish Color Options

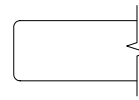
Model Number Breakdown

LKT4872-36WDT					
LK	T	4872	36	WD	T
LOK	Laminate	48" x 72"	Height	Wedge Top Shape	T base

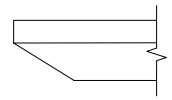
Description

Wedge Table with T Base at Counter Height
(continued)

Veneer Tables
"LKV" Models



Eased Edge (R3)



Reverse Bevel Edge (K9)

VEN.	D	W	H	CTN WT	CU FT	① Model	Eased Edge (R3)		Reverse Bevel Edge (K9)	
							Flat Cut	Double Cut	Flat Cut	Double Cut
	48	72	36	156	87	LKV4872-36WDT	\$2,784	\$3,007	\$3,033	\$3,231

LOK - TEAMWORK

Electrical Options and Upcharges

CT2	
Dual Power Center Top - Black	CT2BL - add \$1,437
Dual Power Center Top - White	CT2WH - add \$1,437
CU1	
Single Power Underside - Black	CU11C - add \$559
Single Power Underside with Wireless Charging - Black	CU11CW - add \$1,338

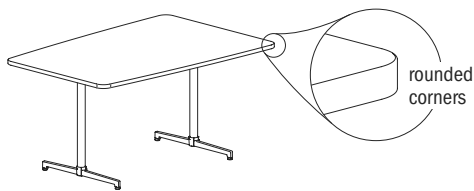
Note: Order power infeed that best fits application

To Order, Specify:

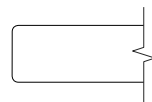
① Veneer Model #	② Edge Detail	③ Wood Species	④ Top Wood Finish	⑤ Electrical	⑥ Metal Color
Veneer (LKV)	See Edge Detail Options	Flat Cut B01 Black Oak CH1 Cherry MA1 Maple WA1 Walnut	See Flat Cut Top Wood Finish Options	N None CT2 Dual Power Center Top CU1 Single Power Underside (See chart above)	See Metal Finish Color Options
		Double Cut DC1 Double Cut	④ Top Wood Finish See Double Cut Top Wood Finish Options		

Description

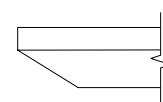
Rounded Wedge Table with T Base at Counter Height



**Laminate Tables
"LKT" Models**



Eased Edge (R3)



Reverse Bevel Edge (K9)

LAM.	D	W	H	CTN WT	CU FT	Model	Standard	Graded In		Standard	Graded In	
							Tier 1	Tier 2	Tier 3	Tier 1	Tier 2	Tier 3
	48	72	36	156	87	LKT4872-36WDRT	\$2,209	\$2,253	\$2,516	\$2,705	\$2,749	\$2,935

Features:

- price reflects complete table - top and base
- ships KD in multiple cartons
- model includes adjustable glide

Options:

- specify power option and or charging option, see below for options and upcharges



top shape

LOK - TEAMWORK

To Order Specify

1 Laminate Model #	2 Edge Detail	3 Laminate Selection	3a PVC Edge Color	4 Electrical
Laminate (LKT)	See Edge Detail Options	See Laminate Selection	See PVC Edge Color Options	N None CT2 Dual Power Center Top (See chart on next page) CU1 Single Power Underside 5 Metal Finish See Metal Finish Color Options

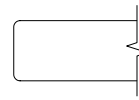
Model Number Breakdown

LKT4872-36WDRT						
LK	T	4872	36	WD	R	T
LOK	Laminate	48" x 72"	Height	Wedge Top Shape	Rounded Corner	T base

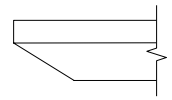
Description

Rounded Wedge Table with T Base at Counter Height
(continued)

Veneer Tables
"LKV" Models



Eased Edge (R3)



Reverse Bevel Edge (K9)

VEN.	D	W	H	CTN WT	CU FT	① Model	Eased Edge (R3)		Reverse Bevel Edge (K9)	
							Flat Cut	Double Cut	Flat Cut	Double Cut
	48	72	36	156	87	LKV4872-36WDRT	\$2,784	\$3,007	\$3,033	\$3,231

LOK - TEAMWORK

Electrical Options and Upcharges

CT2	
Dual Power Center Top - Black	CT2BL - add \$1,437
Dual Power Center Top - White	CT2WH - add \$1,437
CU1	
Single Power Underside - Black	CU11C - add \$559
Single Power Underside with Wireless Charging- Black	CU11CW - add \$1,338

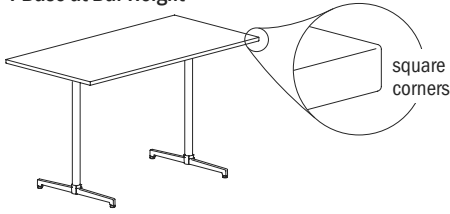
Note: Order power infeed that best fits application

To Order, Specify:

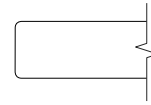
① Veneer Model #	② Edge Detail	③ Wood Species	④ Top Wood Finish	⑤ Electrical	⑥ Metal Color
Veneer (LKV)	See Edge Detail Options	Flat Cut B01 Black Oak CH1 Cherry MA1 Maple WA1 Walnut	See Flat Cut Top Wood Finish Options	N None CT2 Dual Power Center Top CU1 Single Power Underside (See chart above)	See Metal Finish Color Options
		Double Cut DC1 Double Cut	④ Top Wood Finish See Double Cut Top Wood Finish Options		

Description

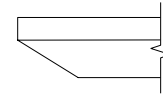
Rectangular Table with T Base at Bar Height



Laminate Tables "LKT" Models



Eased Edge (R3)



Reverse Bevel Edge (K9)

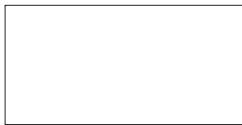
LAMINATE	D	W	H	CTN WT	CU FT	Model	Standard			Graded In		
							Tier 1	Tier 2	Tier 3	Tier 1	Tier 2	Tier 3
		48	72	42	164	101	LKT4872-42TTT	\$2,278	\$2,321	\$2,599	\$2,797	\$2,842
	42	72	42	149	89	LKT4272-42TTT	\$2,177	\$2,216	\$2,456	\$2,686	\$2,725	\$2,897
	36	72	42	139	77	LKT3672-42TTT	\$1,968	\$2,036	\$2,185	\$2,425	\$2,492	\$2,642
	36	66	42	129	72	LKT3666-42TTT	\$1,905	\$1,968	\$2,106	\$2,358	\$2,425	\$2,561
	36	60	42	121	66	LKT3660-42TTT	\$1,828	\$1,885	\$2,008	\$2,282	\$2,343	\$2,465

Features:

- price reflects complete table - top and base
- ships KD in multiple cartons
- model includes adjustable glide

Options:

- specify power/charging option, see below for options and upcharges



top shape

LOK - TEAMWORK

To Order Specify

1 Laminate Model #	2 Edge Detail	3 Laminate Selection	3a PVC Edge Color	4 Electrical
Laminate (LKT)	See Edge Detail Options	See Laminate Selection	See PVC Edge Color Options	N None CT2 Dual Power Center Top (See chart on next page) CU1 Single Power Underside 5 Metal Finish See Metal Finish Color Options

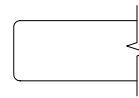
Model Number Breakdown

LKT4872-42TTT					
LK	T	4872	42	TT	T
LOK	Laminate	48" x 72"	Height	Rectangular Top Shape	T base

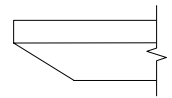
Description

Rectangular Table with
T Base at Bar Height
(continued)

Veneer Tables
"LKV" Models



Eased Edge (R3)



Reverse Bevel Edge (K9)

D	W	H	CTN WT	CU FT	① Model	Eased Edge (R3)		Reverse Bevel Edge (K9)	
						Flat Cut	Double Cut	Flat Cut	Double Cut
48	72	42	140	101	LKV4872-42TTT	\$2,597	\$2,827	\$2,849	\$3,062
42	72	42	149	89	LKV4272-42TTT	\$2,489	\$2,693	\$2,729	\$2,920
36	72	42	139	77	LKV3672-42TTT	\$2,272	\$2,474	\$2,449	\$2,644
36	66	42	129	72	LKV3666-42TTT	\$2,228	\$2,415	\$2,398	\$2,580
36	60	42	121	66	LKV3660-42TTT	\$2,168	\$2,343	\$2,330	\$2,500

VENEER

LOK - TEAMWORK

Electrical Options and Upcharges

CT2	
Dual Power Center Top - Black	CT2BL - add \$1,437
Dual Power Center Top - White	CT2WH - add \$1,437
CU1	
Single Power Underside - Black	CU11C - add \$559
Single Power Underside with Wireless Charging- Black	CU11CW - add \$1,338

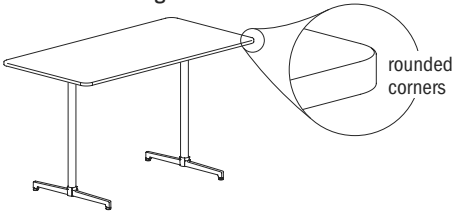
Note: Order power infeed that best fits application

To Order, Specify:

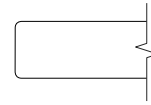
① Veneer Model #	② Edge Detail	③ Wood Species	④ Top Wood Finish	⑤ Electrical	⑥ Metal Color
Veneer (LKV)	See Edge Detail Options	Flat Cut B01 Black Oak CH1 Cherry MA1 Maple WA1 Walnut	See Flat Cut Top Wood Finish Options	N None CT2 Dual Power Center Top CU1 Single Power Underside (See chart above)	See Metal Finish Color Options
		Double Cut DC1 Double Cut	④ Top Wood Finish See Double Cut Top Wood Finish Options		

Description

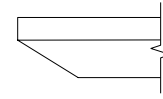
Rounded Rectangular Table with T Base at Bar Height



Laminate Tables "LKT" Models



Eased Edge (R3)



Reverse Bevel Edge (K9)

LAMINATE	D	W	H	CTN WT	CU FT	Model	Eased Edge (R3)		Reverse Bevel Edge (K9)			
							Standard	Graded In		Standard	Graded In	
							Tier 1	Tier 2	Tier 3	Tier 1	Tier 2	Tier 3
	48	72	42	164	101	LKT4872-42TTRT	\$2,340	\$2,384	\$2,660	\$2,858	\$2,903	\$3,100
	42	72	42	149	89	LKT4272-42TTRT	\$2,234	\$2,272	\$2,515	\$2,742	\$2,782	\$2,954
	36	72	42	139	77	LKT3672-42TTRT	\$2,129	\$2,162	\$2,370	\$2,628	\$2,661	\$2,810
	36	66	42	129	72	LKT3666-42TTRT	\$2,043	\$2,073	\$2,267	\$2,539	\$2,569	\$2,706
	36	60	42	121	66	LKT3660-42TTRT	\$1,988	\$2,016	\$2,189	\$2,479	\$2,506	\$2,630

Features:

- price reflects complete table - top and base
- ships KD in multiple cartons
- model includes adjustable glide

Options:

- specify power/charging option, see below for options and upcharges



top shape

LOK - TEAMWORK

To Order Specify

1 Laminite Model #	2 Edge Detail	3 Laminite Selection	3a PVC Edge Color	4 Electrical
Laminite (LKT)	See Edge Detail Options	See Laminite Selection	See PVC Edge Color Options	N None CT2 Dual Power Center Top (See chart on next page) CU1 Single Power Underside 5 Metal Finish See Metal Finish Color Options

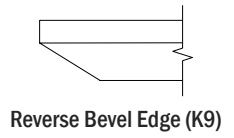
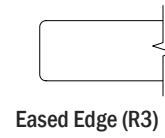
Model Number Breakdown

LKT4872-42TTRT						
LK	T	4872	42	TT	R	T
LOK	Laminite	48" x 72"	Height	Rectangular Top Shape	Rounded Corner	T base

Description

Rounded Rectangular Table with T Base at Bar Height (continued)

Veneer Tables "LKV" Models



D	W	H	CTN WT	CU FT	① Model	Eased Edge (R3)		Reverse Bevel Edge (K9)	
						Flat Cut	Double Cut	Flat Cut	Double Cut
48	72	42	164	101	LKV4872-42TTRT	\$2,656	\$2,889	\$2,910	\$3,125
42	72	42	149	89	LKV4272-42TTRT	\$2,545	\$2,751	\$2,786	\$2,975
36	72	42	139	77	LKV3672-42TTRT	\$2,432	\$2,642	\$2,518	\$2,717
36	66	42	129	72	LKV3666-42TTRT	\$2,344	\$2,507	\$2,568	\$2,718
36	60	42	121	66	LKV3660-42TTRT	\$2,318	\$2,500	\$2,395	\$2,567

VENEER

LOK - TEAMWORK

Electrical Options and Upcharges

CT2	
Dual Power Center Top - Black	CT2BL - add \$1,437
Dual Power Center Top - White	CT2WH - add \$1,437
CU1	
Single Power Underside - Black	CU11C - add \$559
Single Power Underside with Wireless Charging- Black	CU11CW - add \$1,338

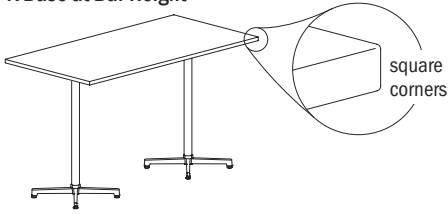
Note: Order power infeed that best fits application

To Order, Specify:

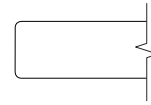
① Veneer Model #	② Edge Detail	③ Wood Species	④ Top Wood Finish	⑤ Electrical	⑥ Metal Color
Veneer (LKV)	See Edge Detail Options	Flat Cut B01 Black Oak CH1 Cherry MA1 Maple WA1 Walnut	See Flat Cut Top Wood Finish Options	N None CT2 Dual Power Center Top CU1 Single Power Underside (See chart above)	See Metal Finish Color Options
		Double Cut DC1 Double Cut	④ Top Wood Finish See Double Cut Top Wood Finish Options		

Description

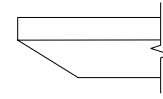
Rectangular Table with X Base at Bar Height



Laminate Tables "LKT" Models



Eased Edge (R3)



Reverse Bevel Edge (K9)

LAMINATE	D	W	H	CTN WT	CU FT	Model	Eased Edge (R3)		Reverse Bevel Edge (K9)			
							Standard	Graded In	Standard	Graded In		
							Tier 1	Tier 2	Tier 3	Tier 1	Tier 2	Tier 3
	48	72	42	169	101	LKT4872-42TTX	\$2,777	\$2,822	\$3,098	\$3,296	\$3,343	\$3,540
	42	72	42	153	90	LKT4272-42TTX	\$2,676	\$2,715	\$2,958	\$3,185	\$3,224	\$3,397
	36	72	42	136	78	LKT3672-42TTX	\$2,527	\$2,597	\$2,746	\$2,984	\$3,052	\$3,202

Features:

- price reflects complete table - top and base
- ships KD in multiple cartons
- model includes adjustable glide

Options:

- specify power/charging option, see below for options and upcharges



top shape

LOK - TEAMWORK

To Order Specify

1 Laminate Model #	2 Edge Detail	3 Laminate Selection	3a PVC Edge Color	4 Electrical
Laminate (LKT)	See Edge Detail Options	See Laminate Selection	See PVC Edge Color Options	N None CT2 Dual Power Center Top (See chart on next page) CU1 Single Power Underside 5 Metal Finish See Metal Finish Color Options

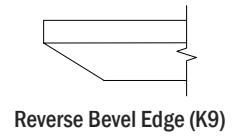
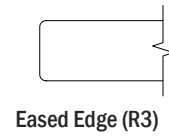
Model Number Breakdown

LKT4872-42TTX					
LK	T	4872	42	TT	X
LOK	Laminate	48" x 72"	Height	Rectangular Top Shape	X base

Description

Rectangular Table with X Base at Bar Height (continued)

Veneer Tables "LKV" Models



VENEER	D	W	H	CTN WT	CU FT	① Model	Flat Cut	Double Cut	Flat Cut	Double Cut
		48	72	42	169	101	LKV4872-42TTX	\$3,096	\$3,329	\$3,349
	42	72	42	153	90	LKV4272-42TTX	\$2,988	\$3,193	\$3,230	\$3,419
	36	72	42	136	78	LKV3672-42TTX	\$2,833	\$3,032	\$3,008	\$3,203

LOK - TEAMWORK

Electrical Options and Upcharges

CT2	
Dual Power Center Top - Black	CT2BL - add \$1,437
Dual Power Center Top - White	CT2WH - add \$1,437
CU1	
Single Power Underside - Black	CU11C - add \$559
Single Power Underside with Wireless Charging- Black	CU11CW - add \$1,338

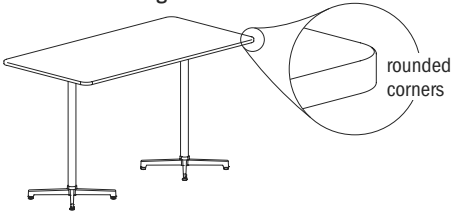
Note: Order power infeed that best fits application

To Order, Specify:

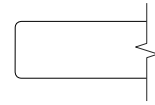
① Veneer Model #	② Edge Detail	③ Wood Species	④ Top Wood Finish	⑤ Electrical	⑥ Metal Color
Veneer (LKV)	See Edge Detail Options	Flat Cut B01 Black Oak CH1 Cherry MA1 Maple WA1 Walnut	See Flat Cut Top Wood Finish Options	N None CT2 Dual Power Center Top CU1 Single Power Underside (See chart above)	See Metal Finish Color Options
		Double Cut DC1 Double Cut	④ Top Wood Finish See Double Cut Top Wood Finish Options		

Description

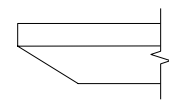
Rectangular Table with X Base at Bar Height



Laminate Tables "LKT" Models



Eased Edge (R3)



Reverse Bevel Edge (K9)

LAMINATE	D	W	H	CTN WT	CU FT	Model	Standard Tier 1	Graded In Tier 2	Graded In Tier 3	Standard Tier 1	Graded In Tier 2	Graded In Tier 3
	48	72	42	169	101	LKT4872-42TTRX	\$2,777	\$2,822	\$3,098	\$3,296	\$3,343	\$3,540
	42	72	42	153	90	LKT4272-42TTRX	\$2,676	\$2,715	\$2,958	\$3,185	\$3,224	\$3,397
36	72	42	136	78	LKT3672-42TTRX	\$2,627	\$2,697	\$2,846	\$3,082	\$3,156	\$3,300	

Features:

- price reflects complete table - top and base
- ships KD in multiple cartons
- model includes adjustable glide

Options:

- specify power/charging option, see below for options and upcharges



top shape

LOK - TEAMWORK

To Order Specify

1 Laminate Model #	2 Edge Detail	3 Laminate Selection	3a PVC Edge Color	4 Electrical
Laminate (LKT)	See Edge Detail Options	See Laminate Selection	See PVC Edge Color Options	N None CT2 Dual Power Center Top (See chart on next page) CU1 Single Power Underside 5 Metal Finish See Metal Finish Color Options

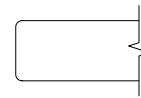
Model Number Breakdown

LKT4872-42TTRX						
LK	T	4872	42	TT	R	X
LOK	Laminate	48" x 72"	Height	Rectangular Top Shape	Rounded Corner	X base

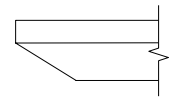
Description

Rectangular Table with X Base at Bar Height (continued)

Veneer Tables "LKV" Models



Eased Edge (R3)



Reverse Bevel Edge (K9)

VENEER	D	W	H	CTN WT	CU FT	① Model	Flat Cut	Double Cut	Flat Cut	Double Cut
		48	72	42	169	101	LKV4872-42TTRX	\$3,096	\$3,329	\$3,349
	42	72	42	153	90	LKV4272-42TTRX	\$3,025	\$3,235	\$3,230	\$3,419
	36	72	42	136	78	LKV3672-42TTRX	\$2,988	\$3,193	\$3,112	\$3,311

LOK - TEAMWORK

Electrical Options and Upcharges

CT2	
Dual Power Center Top - Black	CT2BL - add \$1,437
Dual Power Center Top - White	CT2WH - add \$1,437
CU1	
Single Power Underside - Black	CU11C - add \$559
Single Power Underside with Wireless Charging- Black	CU11CW - add \$1,338

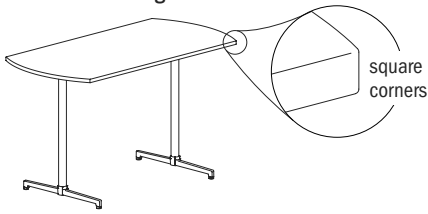
Note: Order power infeed that best fits application

To Order, Specify:

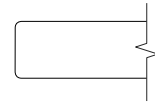
① Veneer Model #	② Edge Detail	③ Wood Species	④ Top Wood Finish	⑤ Electrical	⑥ Metal Color
Veneer (LKV)	See Edge Detail Options	Flat Cut B01 Black Oak CH1 Cherry MA1 Maple WA1 Walnut	See Flat Cut Top Wood Finish Options	N None CT2 Dual Power Center Top CU1 Single Power Underside (See chart above)	See Metal Finish Color Options
		Double Cut DC1 Double Cut	④ Top Wood Finish See Double Cut Top Wood Finish Options		

Description

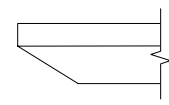
Arc Rectangular Table with T Base at Bar Height



Laminate Tables "LKT" Models



Eased Edge (R3)



Reverse Bevel Edge (K9)

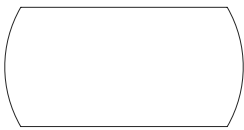
LAMINATE	D	W	H	CTN WT	CU FT	Model	Eased Edge (R3)			Reverse Bevel Edge (K9)		
							Standard	Graded In		Standard	Graded In	
							Tier 1	Tier 2	Tier 3	Tier 1	Tier 2	Tier 3
	48	72	42	155	101	LKT4872-42ART	\$2,228	\$2,271	\$2,534	\$2,722	\$2,765	\$2,954
	42	72	42	143	89	LKT4272-42ART	\$2,127	\$2,165	\$2,394	\$2,612	\$2,650	\$2,814
	36	72	42	134	77	LKT3672-42ART	\$2,028	\$2,058	\$2,257	\$2,504	\$2,535	\$2,676
	36	66	42	125	72	LKT3666-42ART	\$1,947	\$1,977	\$2,158	\$2,418	\$2,449	\$2,578
	36	60	42	116	66	LKT3660-42ART	\$1,895	\$1,920	\$2,085	\$2,361	\$2,388	\$2,506

Features:

- price reflects complete table - top and base
- ships KD in multiple cartons
- model includes adjustable glide

Options:

- specify power/charging option, see below for options and upcharges



top shape

Lok - TEAMWORK

To Order Specify

1 Laminate Model #	2 Edge Detail	3 Laminate Selection	3a PVC Edge Color	4 Electrical
Laminate (LKT)	See Edge Detail Options	See Laminate Selection	See PVC Edge Color Options	N None CT2 Dual Power Center Top (See chart on next page) CU1 Single Power Underside 5 Metal Finish See Metal Finish Color Options

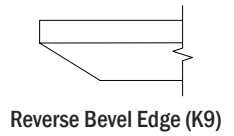
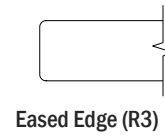
Model Number Breakdown

LKT4872-42ART					
LK	T	4872	42	AR	T
LOK	Laminate	48" x 72"	Height	Arc Rectangular Top Shape	T base

Description

Arc Rectangular Table with T Base at Bar Height (continued)

Veneer Tables "LKV" Models



D	W	H	CTN WT	CU FT	① Model	Eased Edge (R3)		Reverse Bevel Edge (K9)	
						Flat Cut	Double Cut	Flat Cut	Double Cut
48	72	42	155	101	LKV4872-42ART	\$2,803	\$3,026	\$3,054	\$3,252
42	72	42	143	89	LKV4272-42ART	\$2,696	\$2,911	\$2,939	\$3,129
36	72	42	134	77	LKV3672-42ART	\$2,589	\$2,796	\$2,821	\$3,006
36	66	42	125	72	LKV3666-42ART	\$2,504	\$2,704	\$2,729	\$2,907
36	60	42	116	66	LKV3660-42ART	\$2,178	\$2,321	\$2,388	\$2,518

VENEER

LOK - TEAMWORK

Electrical Options and Upcharges

CT2	
Dual Power Center Top - Black	CT2BL - add \$1,437
Dual Power Center Top - White	CT2WH - add \$1,437
CU1	
Single Power Underside - Black	CU11C - add \$559
Single Power Underside with Wireless Charging- Black	CU11CW - add \$1,338

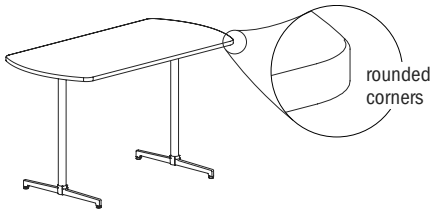
Note: Order power infeed that best fits application

To Order, Specify:

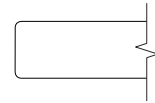
① Veneer Model #	② Edge Detail	③ Wood Species	④ Top Wood Finish	⑤ Electrical	⑥ Metal Color
Veneer (LKV)	See Edge Detail Options	Flat Cut B01 Black Oak CH1 Cherry MA1 Maple WA1 Walnut	See Flat Cut Top Wood Finish Options	N None CT2 Dual Power Center Top CU1 Single Power Underside (See chart above)	See Metal Finish Color Options
		Double Cut DC1 Double Cut	④ Top Wood Finish See Double Cut Top Wood Finish Options		

Description

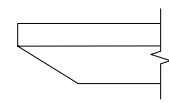
Rounded Arc Rectangular Table with T Base at Bar Height



Laminate Tables "LKT" Models



Eased Edge (R3)



Reverse Bevel Edge (K9)

LAMINATE	D	W	H	CTN WT	CU FT	Model	Standard			Graded In		
							Tier 1	Tier 2	Tier 3	Tier 1	Tier 2	Tier 3
	48	72	42	155	101	LKT4872-42ARRT	\$2,228	\$2,271	\$2,534	\$2,722	\$2,765	\$2,954
42	72	42	143	89	LKT4272-42ARRT	\$2,127	\$2,165	\$2,394	\$2,612	\$2,650	\$2,814	
36	72	42	134	77	LKT3672-42ARRT	\$2,028	\$2,058	\$2,257	\$2,504	\$2,535	\$2,676	
36	66	42	125	72	LKT3666-42ARRT	\$1,947	\$1,977	\$2,158	\$2,418	\$2,449	\$2,578	
36	60	42	116	66	LKT3660-42ARRT	\$1,895	\$1,920	\$2,085	\$2,361	\$2,388	\$2,506	

Features:

- price reflects complete table - top and base
- ships KD in multiple cartons
- model includes adjustable glide

Options:

- specify power/charging option, see below for options and upcharges



top shape

LOK - TEAMWORK

To Order Specify

1 Laminite Model #	2 Edge Detail	3 Laminite Selection	3a PVC Edge Color	4 Electrical
Laminite (LKT)	See Edge Detail Options	See Laminite Selection	See PVC Edge Color Options	N None CT2 Dual Power Center Top (See chart on next page) CU1 Single Power Underside 5 Metal Finish See Metal Finish Color Options

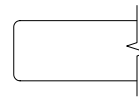
Model Number Breakdown

LKT4872-42ARRT						
LK	T	4872	42	AR	R	T
LOK	Laminite	48" x 72"	Height	Arc Rectangular Top Shape	Rounded Corner	T base

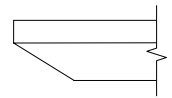
Description

Rounded Arc Rectangular Table with T Base at Bar Height (continued)

Veneer Tables "LKV" Models



Eased Edge (R3)



Reverse Bevel Edge (K9)

D	W	H	CTN WT	CU FT	① Model	Eased Edge (R3)		Reverse Bevel Edge (K9)	
						Flat Cut	Double Cut	Flat Cut	Double Cut
48	72	42	155	101	LKV4872-42ARRT	\$2,531	\$2,753	\$2,773	\$2,976
42	72	42	143	89	LKV4272-42ARRT	\$2,426	\$2,621	\$2,655	\$2,836
36	72	42	134	77	LKV3672-42ARRT	\$2,318	\$2,487	\$2,537	\$2,692
36	66	42	125	72	LKV3666-42ARRT	\$2,233	\$2,389	\$2,448	\$2,590
36	60	42	116	66	LKV3660-42ARRT	\$2,178	\$2,321	\$2,388	\$2,518

VENEER

LOK - TEAMWORK

Electrical Options and Upcharges

CT2	
Dual Power Center Top - Black	CT2BL - add \$1,437
Dual Power Center Top - White	CT2WH - add \$1,437
CU1	
Single Power Underside - Black	CU11C - add \$559
Single Power Underside with Wireless Charging- Black	CU11CW - add \$1,338

Note: Order power infeed that best fits application

To Order, Specify:

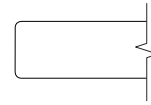
① Veneer Model #	② Edge Detail	③ Wood Species	④ Top Wood Finish	⑤ Electrical	⑥ Metal Color
Veneer (LKV)	See Edge Detail Options	Flat Cut B01 Black Oak CH1 Cherry MA1 Maple WA1 Walnut	See Flat Cut Top Wood Finish Options	N None CT2 Dual Power Center Top CU1 Single Power Underside (See chart above)	See Metal Finish Color Options
		Double Cut DC1 Double Cut	④ Top Wood Finish See Double Cut Top Wood Finish Options		

Description

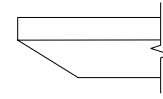
Racetrack Table with T Base at Bar Height



Laminate Tables "LKT" Models



Eased Edge (R3)



Reverse Bevel Edge (K9)

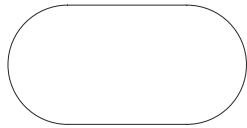
LAMINATE	D	W	H	CTN WT	CU FT	① Model	Eased Edge (R3)			Reverse Bevel Edge (K9)		
							Standard	Graded In		Standard	Graded In	
							Tier 1	Tier 2	Tier 3	Tier 1	Tier 2	Tier 3
	42	72	42	136	89	LKT4272-42RKT	\$2,127	\$2,165	\$2,394	\$2,612	\$2,650	\$2,814
	36	72	42	129	77	LKT3672-42RKT	\$2,028	\$2,058	\$2,257	\$2,504	\$2,535	\$2,676
	36	66	42	120	72	LKT3666-42RKT	\$1,947	\$1,977	\$2,158	\$2,418	\$2,449	\$2,578
	36	60	42	110	66	LKT3660-42RKT	\$1,895	\$1,920	\$2,085	\$2,361	\$2,388	\$2,506

Features:

- price reflects complete table - top and base
- ships KD in multiple cartons
- model includes adjustable glide

Options:

- specify power/charging option, see below for options and upcharges



top shape

LOK - TEAMWORK

To Order Specify

① Laminate Model #	② Edge Detail	③ Laminate Selection	④ PVC Edge Color	⑤ Electrical
Laminate (LKT)	See Edge Detail Options	See Laminate Selection	See PVC Edge Color Options	N None CT2 Dual Power Center Top (See chart on next page) CU1 Single Power Underside ⑤ Metal Finish See Metal Finish Color Options

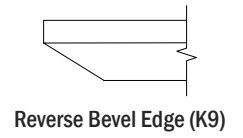
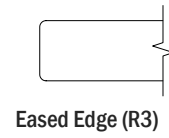
Model Number Breakdown

LKT4872-42RKT					
LK	T	4872	42	RK	T
LOK	Laminate	48" x 72"	Height	Racetrack Top Shape	T base

Description

Racetrack Table with
T Base at Bar Height
(continued)

Veneer Tables
"LKV" Models



VENEER	D	W	H	CTN WT	CU FT	① Model	Eased Edge (R3)		Reverse Bevel Edge (K9)	
							Flat Cut	Double Cut	Flat Cut	Double Cut
	48	72	42	147	101	LKV4872-42RKT	\$2,803	\$3,026	\$3,054	\$3,252
	36	72	42	129	77	LKV3672-42RKT	\$2,589	\$2,796	\$2,821	\$3,006
	36	66	42	120	72	LKV3666-42RKT	\$2,504	\$2,704	\$2,729	\$2,907
	36	60	42	110	66	LKV3660-42RKT	\$2,450	\$2,646	\$2,671	\$2,843

LOK - TEAMWORK

Electrical Options and Upcharges

CT2	
Dual Power Center Top - Black	CT2BL - add \$1,437
Dual Power Center Top - White	CT2WH - add \$1,437
CU1	
Single Power Underside - Black	CU11C - add \$559
Single Power Underside with Wireless Charging- Black	CU11CW - add \$1,338

Note: Order power infeed that best fits application

To Order, Specify:

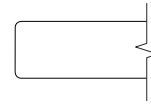
① Veneer Model #	② Edge Detail	③ Wood Species	④ Top Wood Finish	⑤ Electrical	⑥ Metal Color
Veneer (LKV)	See Edge Detail Options	Flat Cut B01 Black Oak CH1 Cherry MA1 Maple WA1 Walnut	See Flat Cut Top Wood Finish Options	N None CT2 Dual Power Center Top CU1 Single Power Underside (See chart above)	See Metal Finish Color Options
		Double Cut DC1 Double Cut	④ Top Wood Finish See Double Cut Top Wood Finish Options		

Description

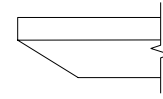
Oval Table with T Base
at Bar Height



**Laminate Tables
"LKT" Models**



Eased Edge (R3)



Reverse Bevel Edge (K9)

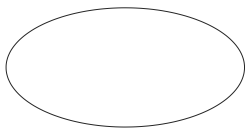
LAM.	D	W	H	CTN WT	CU FT	❶ Model	Standard			Graded In		
							Tier 1	Tier 2	Tier 3	Tier 1	Tier 2	Tier 3
	36	72	42	119	77	LKT3672-420VT	\$2,028	\$2,058	\$2,257	\$2,504	\$2,535	\$2,676

Features:

- price reflects complete table - top and base
- ships KD in multiple cartons
- model includes adjustable glide

Options:

- specify power/charging option, see below for options and upcharges



top shape

LOK - TEAMWORK

To Order Specify

❶ Laminate Model #	❷ Edge Detail	❸ Laminate Selection	❹ PVC Edge Color	❺ Electrical
Laminate (LKT)	See Edge Detail Options	See Laminate Selection	See PVC Edge Color Options	N None CT2 Dual Power Center Top (See chart on next page) CU1 Single Power Underside ❺ Metal Finish See Metal Finish Color Options

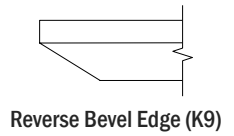
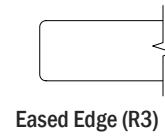
Model Number Breakdown

LKT4272-42RKT					
LK	T	4272	42	OV	T
LOK	Laminate	42" x 72"	Height	Oval Top Shape	T base

Description

Oval Table with T Base at Bar Height
(continued)

Veneer Tables "LKV" Models



VEN.	D	W	H	CTN WT	CU FT	① Model	Eased Edge (R3)		Reverse Bevel Edge (K9)	
							Flat Cut	Double Cut	Flat Cut	Double Cut
	36	72	42	119	77	LKV3672-42OVT	\$2,568	\$2,774	\$2,800	\$2,982

LOK - TEAMWORK

Electrical Options and Upcharges

CT2	
Dual Power Center Top - Black	CT2BL - add \$1,437
Dual Power Center Top - White	CT2WH - add \$1,437
CU1	
Single Power Underside - Black	CU11C - add \$559
Single Power Underside with Wireless Charging - Black	CU11CW - add \$1,338

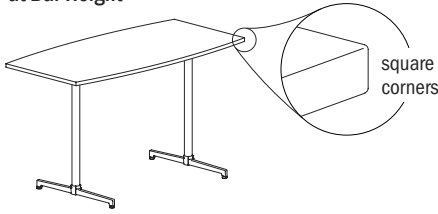
Note: Order power infeed that best fits application

To Order, Specify:

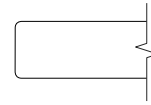
① Veneer Model #	② Edge Detail	③ Wood Species	④ Top Wood Finish	⑤ Electrical	⑥ Metal Color
Veneer (LKV)	See Edge Detail Options	Flat Cut BO1 Black Oak CH1 Cherry MA1 Maple WA1 Walnut	See Flat Cut Top Wood Finish Options	N None CT2 Dual Power Center Top CU1 Single Power Underside (See chart above)	See Metal Finish Color Options
		Double Cut DC1 Double Cut	④ Top Wood Finish See Double Cut Top Wood Finish Options		

Description

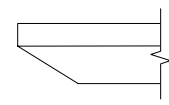
Boat Table with T Base
at Bar Height



**Laminate Tables
"LKT" Models**



Eased Edge (R3)



Reverse Bevel Edge (K9)

LAMINATE	D	W	H	CTN WT	CU FT	Model	Eased Edge (R3)			Reverse Bevel Edge (K9)		
							Standard	Graded In		Standard	Graded In	
							Tier 1	Tier 2	Tier 3	Tier 1	Tier 2	Tier 3
	48	72	42	159	101	LKT4872-42BTT	\$2,228	\$2,271	\$2,534	\$2,722	\$2,765	\$2,954
	42	72	42	144	89	LKT4272-42BTT	\$2,127	\$2,165	\$2,394	\$2,612	\$2,650	\$2,814
	36	72	42	133	77	LKT3672-42BTT	\$2,028	\$2,058	\$2,257	\$2,504	\$2,535	\$2,676
	36	66	42	125	72	LKT3666-42BTT	\$1,947	\$1,977	\$2,158	\$2,418	\$2,449	\$2,578
	36	60	42	117	66	LKT3660-42BTT	\$1,895	\$1,920	\$2,085	\$2,361	\$2,388	\$2,506

Features:

- price reflects complete table - top and base
- ships KD in multiple cartons
- model includes adjustable glide

Options:

- specify power/charging option, see below for options and upcharges



top shape

LOK - TEAMWORK

To Order Specify

1 Laminate Model #	2 Edge Detail	3 Laminate Selection	3a PVC Edge Color	4 Electrical
Laminate (LKT)	See Edge Detail Options	See Laminate Selection	See PVC Edge Color Options	N None CT2 Dual Power Center Top (See chart on next page) CU1 Single Power Underside 5 Metal Finish See Metal Finish Color Options

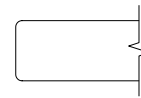
Model Number Breakdown

LKT4872-42BTT					
LK	T	4872	42	BT	T
LOK	Laminate	48" x 72"	Height	Boat Top Shape	T base

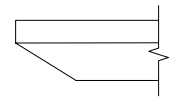
Description

Boat Table with T Base
at Bar Height
(continued)

Veneer Tables
"LKV" Models



Eased Edge (R3)



Reverse Bevel Edge (K9)

D	W	H	CTN WT	CU FT	① Model	Eased Edge (R3)		Reverse Bevel Edge (K9)	
						Flat Cut	Double Cut	Flat Cut	Double Cut
48	72	42	159	101	LKV4872-42BTT	\$2,803	\$3,026	\$3,054	\$3,252
42	72	42	144	89	LKV4272-42BTT	\$2,696	\$2,911	\$2,939	\$3,129
36	72	42	133	77	LKV3672-42BTT	\$2,589	\$2,796	\$2,821	\$3,006
36	66	42	125	72	LKV3666-42BTT	\$2,504	\$2,704	\$2,729	\$2,907
36	60	42	117	66	LKV3660-42BTT	\$2,450	\$2,646	\$2,671	\$2,843

VENEER

LOK - TEAMWORK

Electrical Options and Upcharges

CT2	
Dual Power Center Top - Black	CT2BL - add \$1,437
Dual Power Center Top - White	CT2WH - add \$1,437
CU1	
Single Power Underside - Black	CU11C - add \$559
Single Power Underside with Wireless Charging- Black	CU11CW - add \$1,338

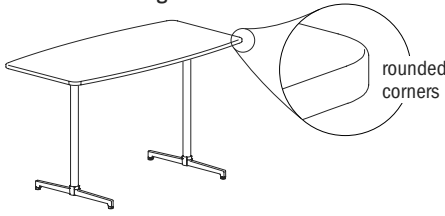
Note: Order power infeed that best fits application

To Order, Specify:

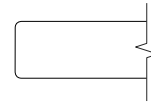
① Veneer Model #	② Edge Detail	③ Wood Species	④ Top Wood Finish	⑤ Electrical	⑥ Metal Color
Veneer (LKV)	See Edge Detail Options	Flat Cut B01 Black Oak CH1 Cherry MA1 Maple WA1 Walnut	See Flat Cut Top Wood Finish Options	N None CT2 Dual Power Center Top CU1 Single Power Underside (See chart above)	See Metal Finish Color Options
		Double Cut DC1 Double Cut	④ Top Wood Finish See Double Cut Top Wood Finish Options		

Description

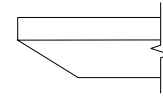
Rounded Boat Table with T Base at Bar Height



Laminate Tables "LKT" Models



Eased Edge (R3)



Reverse Bevel Edge (K9)

LAMINATE	D	W	H	CTN WT	CU FT	Model	Eased Edge (R3)			Reverse Bevel Edge (K9)		
							Standard	Graded In		Standard	Graded In	
							Tier 1	Tier 2	Tier 3	Tier 1	Tier 2	Tier 3
	48	72	42	159	101	LKT4872-42BTRT	\$2,228	\$2,271	\$2,534	\$2,722	\$2,765	\$2,954
	42	72	42	144	89	LKT4272-42BTRT	\$2,127	\$2,165	\$2,394	\$2,612	\$2,650	\$2,814
	36	72	42	133	77	LKT3672-42BTRT	\$2,028	\$2,058	\$2,257	\$2,504	\$2,535	\$2,676
	36	66	42	125	72	LKT3666-42BTRT	\$1,947	\$1,977	\$2,158	\$2,418	\$2,449	\$2,578
	36	60	42	117	66	LKT3660-42BTRT	\$1,895	\$1,920	\$2,085	\$2,361	\$2,388	\$2,506

Features:

- price reflects complete table - top and base
- ships KD in multiple cartons
- model includes adjustable glide

Options:

- specify power/charging option, see below for options and upcharges



top shape

LOK - TEAMWORK

To Order Specify

1 Laminite Model #	2 Edge Detail	3 Laminite Selection	3a PVC Edge Color	4 Electrical
Laminite (LKT)	See Edge Detail Options	See Laminite Selection	See PVC Edge Color Options	N None CT2 Dual Power Center Top (See chart on next page) CU1 Single Power Underside 5 Metal Finish See Metal Finish Color Options

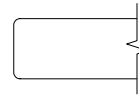
Model Number Breakdown

LKT4872-42BTRT						
LK	T	4872	42	BT	R	T
LOK	Laminite	48" x 72"	Height	Boat Top Shape	Rounded Corner	T base

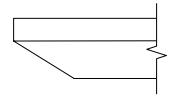
Description

Rounded Boat Table with
T Base at Bar Height
(continued)

Veneer Tables
"LKV" Models



Eased Edge (R3)



Reverse Bevel Edge (K9)

D	W	H	CTN WT	CU FT	① Model	Eased Edge (R3)		Reverse Bevel Edge (K9)	
						Flat Cut	Double Cut	Flat Cut	Double Cut
48	72	42	159	101	LKV4872-42BTRT	\$2,803	\$3,026	\$3,054	\$3,252
42	72	42	144	89	LKV4272-42BTRT	\$2,696	\$2,911	\$2,939	\$3,129
36	72	42	133	77	LKV3672-42BTRT	\$2,589	\$2,796	\$2,821	\$3,006
36	66	42	125	72	LKV3666-42BTRT	\$2,504	\$2,704	\$2,729	\$2,907
36	60	42	117	66	LKV3660-42BTRT	\$2,450	\$2,646	\$2,671	\$2,843

VENEER

LOK - TEAMWORK

Electrical Options and Upcharges

CT2	
Dual Power Center Top - Black	CT2BL - add \$1,437
Dual Power Center Top - White	CT2WH - add \$1,437
CU1	
Single Power Underside - Black	CU11C - add \$559
Single Power Underside with Wireless Charging- Black	CU11CW - add \$1,338

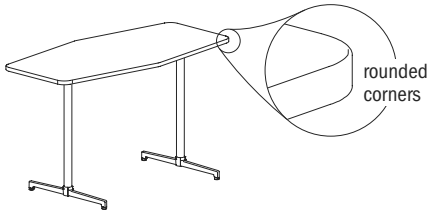
Note: Order power infeed that best fits application

To Order, Specify:

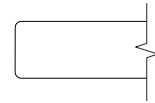
① Veneer Model #	② Edge Detail	③ Wood Species	④ Top Wood Finish	⑤ Electrical	⑥ Metal Color
Veneer (LKV)	See Edge Detail Options	Flat Cut B01 Black Oak CH1 Cherry MA1 Maple WA1 Walnut	See Flat Cut Top Wood Finish Options	N None CT2 Dual Power Center Top CU1 Single Power Underside (See chart above)	See Metal Finish Color Options
		Double Cut DC1 Double Cut	④ Top Wood Finish See Double Cut Top Wood Finish Options		

Description

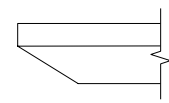
Rounded Double Chevron Table with T Base at Bar Height



Laminate Tables "LKT" Models



Eased Edge (R3)



Reverse Bevel Edge (K9)

D	W	H	CTN WT	CU FT	Model	Standard		Graded In		Standard		Graded In		
						Tier 1	Tier 2	Tier 3	Tier 1	Tier 2	Tier 3	Tier 1	Tier 2	Tier 3
						48	72	42	153	101	LKT4872-42DCRT	\$2,228	\$2,271	\$2,534
48	60	42	135	85	LKT4860-42DCRT	\$2,064	\$2,100	\$2,318	\$2,545	\$2,581	\$2,738			
42	72	42	137	89	LKT4272-42DCRT	\$2,127	\$2,165	\$2,394	\$2,612	\$2,650	\$2,814			
42	60	42	121	75	LKT4260-42DCRT	\$1,979	\$2,008	\$2,203	\$2,453	\$2,483	\$2,622			
36	72	42	125	77	LKT3672-42DCRT	\$2,028	\$2,058	\$2,257	\$2,504	\$2,535	\$2,676			
36	60	42	111	66	LKT3660-42DCRT	\$1,895	\$1,920	\$2,085	\$2,361	\$2,388	\$2,506			

LAMINATE

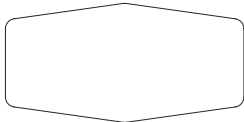
LOK - TEAMWORK

Features:

- price reflects complete table - top and base
- ships KD in multiple cartons
- model includes adjustable glide

Options:

- specify power/charging option, see below for options and upcharges



top shape

To Order Specify

1 Laminate Model #	2 Edge Detail	3 Laminate Selection	3a PVC Edge Color	4 Electrical
Laminate (LKT)	See Edge Detail Options	See Laminate Selection	See PVC Edge Color Options	N None CT2 Dual Power Center Top (See chart on next page) CU1 Single Power Underside 5 Metal Finish See Metal Finish Color Options

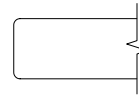
Model Number Breakdown

LKT4872-42DCRT						
LK	T	4872	42	DC	R	T
LOK	Laminate	48" x 72"	Height	Double Chevron Top Shape	Rounded Corner	T base

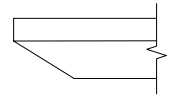
Description

Rounded Double Chevron Table with
T Base at Bar Height
(continued)

Veneer Tables
"LKV" Models



Eased Edge (R3)



Reverse Bevel Edge (K9)

VENEER	D	W	H	CTN WT	CU FT	① Model	Eased Edge (R3)		Reverse Bevel Edge (K9)	
							Flat Cut	Double Cut	Flat Cut	Double Cut
	48	72	42	153	101	LKV4872-42DCRT	\$2,803	\$3,026	\$3,054	\$3,252
	48	60	42	135	85	LKV4860-42DCRT	\$2,629	\$2,840	\$2,864	\$3,052
	42	72	42	137	89	LKV4272-42DCRT	\$2,696	\$2,911	\$2,939	\$3,129
	42	60	42	121	75	LKV4260-42DCRT	\$2,539	\$2,742	\$2,770	\$2,948
	36	72	42	125	77	LKV3672-42DCRT	\$2,647	\$2,858	\$2,885	\$3,072
	36	60	42	111	66	LKV3660-42DCRT	\$2,471	\$2,669	\$2,693	\$2,866

LOK - TEAMWORK

Electrical Options and Upcharges

CT2	
Dual Power Center Top - Black	CT2BL - add \$1,437
Dual Power Center Top - White	CT2WH - add \$1,437
CU1	
Single Power Underside - Black	CU11C - add \$559
Single Power Underside with Wireless Charging - Black	CU11CW - add \$1,338

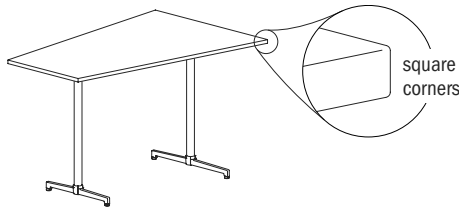
Note: Order power infeed that best fits application

To Order, Specify:

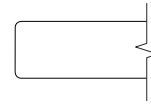
① Veneer Model #	② Edge Detail	③ Wood Species	④ Top Wood Finish	⑤ Electrical	⑥ Metal Color
Veneer (LKV)	See Edge Detail Options	Flat Cut B01 Black Oak CH1 Cherry MA1 Maple WA1 Walnut	See Flat Cut Top Wood Finish Options	N None CT2 Dual Power Center Top CU1 Single Power Underside (See chart above)	See Metal Finish Color Options
		Double Cut DC1 Double Cut	④ Top Wood Finish See Double Cut Top Wood Finish Options		

Description

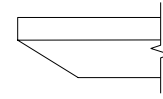
Taper Table with T Base
at Bar Height



**Laminate Tables
"LKT" Models**



Eased Edge (R3)



Reverse Bevel Edge (K9)

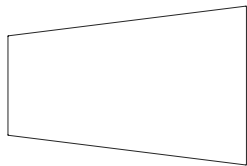
LAM.	D	W	H	CTN WT	CU FT	Model	Standard			Graded In		
	Tier 1	Tier 2	Tier 3	Tier 1	Tier 2	Tier 3	Tier 1	Tier 2	Tier 3	Tier 1	Tier 2	Tier 3
	48	72	42	140	101	LKT4872-42TPT	\$2,239	\$2,280	\$2,542	\$2,734	\$2,776	\$2,963

Features:

- price reflects complete table - top and base
- ships KD in multiple cartons
- model includes adjustable glide

Options:

- specify power/charging option, see below for options and upcharges



top shape

LOK - TEAMWORK

To Order Specify

1 Laminate Model #	2 Edge Detail	3 Laminate Selection	3a PVC Edge Color	4 Electrical
Laminate (LKT)	See Edge Detail Options	See Laminate Selection	See PVC Edge Color Options	N None CT2 Dual Power Center Top (See chart on next page) CU1 Single Power Underside 5 Metal Finish See Metal Finish Color Options

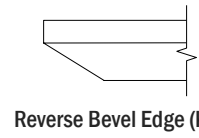
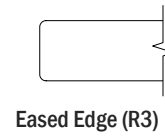
Model Number Breakdown

LKT4872-42TPT					
LK	T	4872	42	TP	T
LOK	Laminate	48" x 72"	Height	Taper Top Shape	T base

Description

Taper Table with T Base
at Bar Height
(continued)

Veneer Tables
"LKV" Models



VEN.	D	W	H	CTN WT	CU FT	① Model	Veneer Tables "LKV" Models			
							Flat Cut	Double Cut	Flat Cut	Double Cut
	48	72	42	140	101	LKV4872-42TPT	\$2,813	\$3,037	\$3,064	\$3,265

LOK - TEAMWORK

Electrical Options and Upcharges

CT2	
Dual Power Center Top - Black	CT2BL - add \$1,437
Dual Power Center Top - White	CT2WH - add \$1,437
CU1	
Single Power Underside - Black	CU11C - add \$559
Single Power Underside with Wireless Charging- Black	CU11CW - add \$1,338

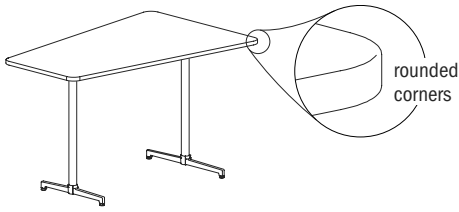
Note: Order power infeed that best fits application

To Order, Specify:

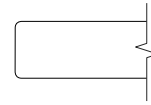
① Veneer Model #	② Edge Detail	③ Wood Species	④ Top Wood Finish	⑤ Electrical	⑥ Metal Color
Veneer (LKV)	See Edge Detail Options	Flat Cut BO1 Black Oak CH1 Cherry MA1 Maple WA1 Walnut	See Flat Cut Top Wood Finish Options	N None CT2 Dual Power Center Top CU1 Single Power Underside (See chart above)	See Metal Finish Color Options
		Double Cut DC1 Double Cut	④ Top Wood Finish See Double Cut Top Wood Finish Options		

Description

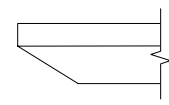
Rounded Taper Table with T Base at Bar Height



Laminate Tables "LKT" Models



Eased Edge (R3)



Reverse Bevel Edge (K9)

Standard	Graded In		Standard	Graded In	
	Tier 1	Tier 2		Tier 3	Tier 1
\$2,239	\$2,280	\$2,542	\$2,734	\$2,776	\$2,963

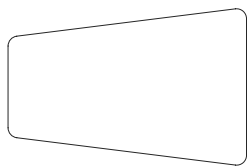
LAM.	D	W	H	CTN WT	CU FT	Model
		48	72	42	140	101

Features:

- price reflects complete table - top and base
- ships KD in multiple cartons
- model includes adjustable glide

Options:

- specify power/charging option, see below for options and upcharges



top shape

LOK - TEAMWORK

To Order Specify

1 Laminite Model #	2 Edge Detail	3 Laminite Selection	3a PVC Edge Color	4 Electrical
Laminite (LKT)	See Edge Detail Options	See Laminite Selection	See PVC Edge Color Options	N None CT2 Dual Power Center Top (See chart on next page) CU1 Single Power Underside 5 Metal Finish See Metal Finish Color Options

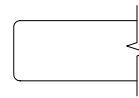
Model Number Breakdown

LKT4872-42TPRT						
LK	T	4872	42	TP	R	T
LOK	Laminite	48" x 72"	Height	Taper Top Shape	Rounded Corner	T base

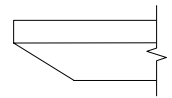
Description

Rounded Taper Table with T Base
at Bar Height
(continued)

Veneer Tables
"LKV" Models



Eased Edge (R3)



Reverse Bevel Edge (K9)

VEN.	D	W	H	CTN WT	CU FT	① Model	Eased Edge (R3)		Reverse Bevel Edge (K9)	
							Flat Cut	Double Cut	Flat Cut	Double Cut
	48	72	42	140	101	LKV4872-42TPRT	\$2,813	\$3,037	\$3,064	\$3,265

LOK - TEAMWORK

Electrical Options and Upcharges

CT2	
Dual Power Center Top - Black	CT2BL - add \$1,437
Dual Power Center Top - White	CT2WH - add \$1,437
CU1	
Single Power Underside - Black	CU11C - add \$559
Single Power Underside with Wireless Charging - Black	CU11CW - add \$1,338

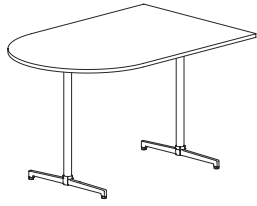
Note: Order power infeed that best fits application

To Order, Specify:

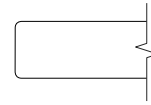
① Veneer Model #	② Edge Detail	③ Wood Species	④ Top Wood Finish	⑤ Electrical	⑥ Metal Color
Veneer (LKV)	See Edge Detail Options	Flat Cut B01 Black Oak CH1 Cherry MA1 Maple WA1 Walnut	See Flat Cut Top Wood Finish Options	N None CT2 Dual Power Center Top CU1 Single Power Underside (See chart above)	See Metal Finish Color Options
		Double Cut DC1 Double Cut	④ Top Wood Finish See Double Cut Top Wood Finish Options		

Description

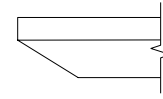
**Bullet Table with T Base
at Bar Height**



**Laminate Tables
"LKT" Models**



Eased Edge (R3)



Reverse Bevel Edge (K9)

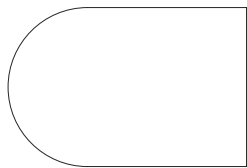
LAM.	D	W	H	CTN WT	CU FT	Model	Standard	Graded In		Standard	Graded In	
							Tier 1	Tier 2	Tier 3	Tier 1	Tier 2	Tier 3
	48	72	42	156	101	LKT4872-42BUT	\$2,228	\$2,271	\$2,534	\$2,722	\$2,765	\$2,954

Features:

- price reflects complete table - top and base
- ships KD in multiple cartons
- model includes adjustable glide

Options:

- specify power/charging option, see below for options and upcharges



top shape

LOK - TEAMWORK

To Order Specify

1 Laminate Model #	2 Edge Detail	3 Laminate Selection	3a PVC Edge Color	4 Electrical
Laminate (LKT)	See Edge Detail Options	See Laminate Selection	See PVC Edge Color Options	N None CT2 Dual Power Center Top (See chart on next page) CU1 Single Power Underside 5 Metal Finish See Metal Finish Color Options

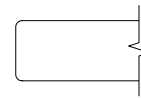
Model Number Breakdown

LKT4872-42BUT					
LK	T	4872	42	BU	T
LOK	Laminate	48" x 72"	Height	Bullet Top Shape	T base

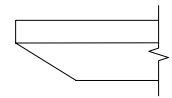
Description

Bullet Table with T Base
at Bar Height
(continued)

Veneer Tables
"LKV" Models



Eased Edge (R3)



Reverse Bevel Edge (K9)

VEN.	D	W	H	CTN WT	CU FT	① Model	Eased Edge (R3)		Reverse Bevel Edge (K9)	
							Flat Cut	Double Cut	Flat Cut	Double Cut
	48	72	42	156	101	LKV4872-42BUT	\$2,803	\$3,026	\$3,054	\$3,252

LOK - TEAMWORK

Electrical Options and Upcharges

CT2	
Dual Power Center Top - Black	CT2BL - add \$1,437
Dual Power Center Top - White	CT2WH - add \$1,437
CU1	
Single Power Underside - Black	CU11C - add \$559
Single Power Underside with Wireless Charging- Black	CU11CW - add \$1,338

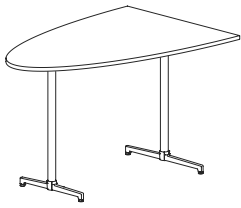
Note: Order power infeed that best fits application

To Order, Specify:

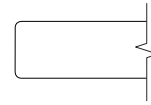
① Veneer Model #	② Edge Detail	③ Wood Species	④ Top Wood Finish	⑤ Electrical	⑥ Metal Color
Veneer (LKV)	See Edge Detail Options	Flat Cut B01 Black Oak CH1 Cherry MA1 Maple WA1 Walnut	See Flat Cut Top Wood Finish Options	N None CT2 Dual Power Center Top CU1 Single Power Underside (See chart above)	See Metal Finish Color Options
		Double Cut DC1 Double Cut	④ Top Wood Finish See Double Cut Top Wood Finish Options		

Description

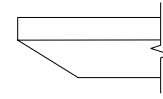
Hive Table with T Base
at Bar Height



Laminate Tables
"LKT" Models



Eased Edge (R3)



Reverse Bevel Edge (K9)

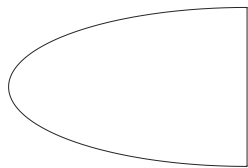
LAM.	D	W	H	CTN WT	CU FT	Model	Standard			Graded In		
	Tier 1	Tier 2	Tier 3	Tier 1	Tier 2	Tier 3	Tier 1	Tier 2	Tier 3	Tier 1	Tier 2	Tier 3
	48	72	42	138	101	LKT4872-42HVT	\$2,228	\$2,271	\$2,534	\$2,722	\$2,765	\$2,954

Features:

- price reflects complete table - top and base
- ships KD in multiple cartons
- model includes adjustable glide

Options:

- specify power/charging option, see below for options and upcharges



top shape

LOK - TEAMWORK

To Order Specify

1 Laminate Model #	2 Edge Detail	3 Laminate Selection	3a PVC Edge Color	4 Electrical
Laminate (LKT)	See Edge Detail Options	See Laminate Selection	See PVC Edge Color Options	N None CT2 Dual Power Center Top (See chart on next page) CU1 Single Power Underside 5 Metal Finish See Metal Finish Color Options

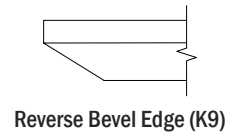
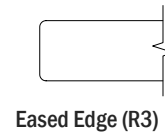
Model Number Breakdown

LKT4872-42HVT					
LK	T	4872	42	HV	T
LOK	Laminate	48" x 72"	Height	Hive Top Shape	T base

Description

Hive Table with T Base
at Bar Height
(continued)

Veneer Tables
"LKV" Models



VEN.	D	W	H	CTN WT	CU FT	① Model	Eased Edge (R3)		Reverse Bevel Edge (K9)	
							Flat Cut	Double Cut	Flat Cut	Double Cut
	48	72	42	138	101	LKV4872-42HVT	\$2,803	\$3,026	\$3,054	\$3,252

LOK - TEAMWORK

Electrical Options and Upcharges

CT2	
Dual Power Center Top - Black	CT2BL - add \$1,437
Dual Power Center Top - White	CT2WH - add \$1,437
CU1	
Single Power Underside - Black	CU11C - add \$559
Single Power Underside with Wireless Charging- Black	CU11CW - add \$1,338

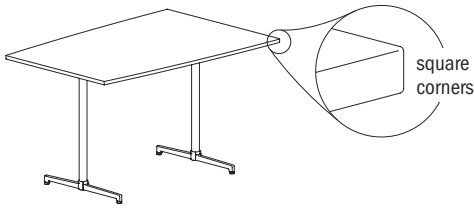
Note: Order power infeed that best fits application

To Order, Specify:

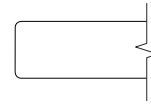
① Veneer Model #	② Edge Detail	③ Wood Species	④ Top Wood Finish	⑤ Electrical	⑥ Metal Color
Veneer (LKV)	See Edge Detail Options	Flat Cut B01 Black Oak CH1 Cherry MA1 Maple WA1 Walnut	See Flat Cut Top Wood Finish Options	N None CT2 Dual Power Center Top CU1 Single Power Underside (See chart above)	See Metal Finish Color Options
		Double Cut DC1 Double Cut	④ Top Wood Finish See Double Cut Top Wood Finish Options		

Description

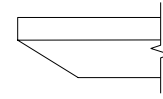
Wedge Table with T Base
at Bar Height



**Laminate Tables
"LKT" Models**



Eased Edge (R3)



Reverse Bevel Edge (K9)

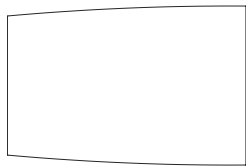
LAM.	D	W	H	CTN WT	CU FT	Model	Standard	Graded In		Standard	Graded In	
							Tier 1	Tier 2	Tier 3	Tier 1	Tier 2	Tier 3
	48	72	42	160	101	LKT4872-42WDT	\$2,228	\$2,271	\$2,534	\$2,722	\$2,765	\$2,954

Features:

- price reflects complete table - top and base
- ships KD in multiple cartons
- model includes adjustable glide

Options:

- specify power/charging option, see below for options and upcharges



top shape

LOK - TEAMWORK

To Order Specify

1 Laminate Model #	2 Edge Detail	3 Laminate Selection	3a PVC Edge Color	4 Electrical
Laminate (LKT)	See Edge Detail Options	See Laminate Selection	See PVC Edge Color Options	N None CT2 Dual Power Center Top (See chart on next page) CU1 Single Power Underside 5 Metal Finish See Metal Finish Color Options

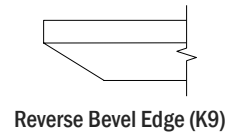
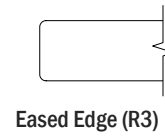
Model Number Breakdown

LKT4872-42WDT					
LK	T	4872	42	WD	T
LOK	Laminate	48" x 72"	Height	Wedge Top Shape	T base

Description

Wedge Table with T Base
at Bar Height
(continued)

Veneer Tables
"LKV" Models



VEN.	D	W	H	CTN WT	CU FT	① Model	Eased Edge (R3)		Reverse Bevel Edge (K9)	
							Flat Cut	Double Cut	Flat Cut	Double Cut
	48	72	42	160	101	LKV4872-42WDT	\$2,803	\$3,026	\$3,054	\$3,252

LOK - TEAMWORK

Electrical Options and Upcharges

CT2	
Dual Power Center Top - Black	CT2BL - add \$1,437
Dual Power Center Top - White	CT2WH - add \$1,437
CU1	
Single Power Underside - Black	CU11C - add \$559
Single Power Underside with Wireless Charging- Black	CU11CW - add \$1,338

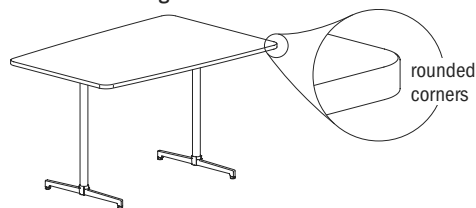
Note: Order power infeed that best fits application

To Order, Specify:

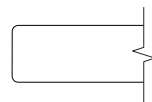
① Veneer Model #	② Edge Detail	③ Wood Species	④ Top Wood Finish	⑤ Electrical	⑥ Metal Color
Veneer (LKV)	See Edge Detail Options	Flat Cut B01 Black Oak CH1 Cherry MA1 Maple WA1 Walnut	See Flat Cut Top Wood Finish Options	N None CT2 Dual Power Center Top CU1 Single Power Underside (See chart above)	See Metal Finish Color Options
		Double Cut DC1 Double Cut	④ Top Wood Finish See Double Cut Top Wood Finish Options		

Description

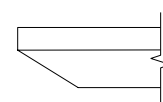
Rounded Wedge Table with T Base at Bar Height



Laminate Tables "LKT" Models



Eased Edge (R3)



Reverse Bevel Edge (K9)

LAM.	D	W	H	CTN WT	CU FT	Model	Standard Tier 1	Graded In Tier 2	Graded In Tier 3	Standard Tier 1	Graded In Tier 2	Graded In Tier 3
		48	72	42	160	101	LKT4872-42WDRT	\$2,228	\$2,271	\$2,534	\$2,722	\$2,765

Features:

- price reflects complete table - top and base
- ships KD in multiple cartons
- model includes adjustable glide

Options:

- specify power/charging option, see below for options and upcharges



top shape

LOK - TEAMWORK

To Order Specify

1 Laminate Model #	2 Edge Detail	3 Laminate Selection	3a PVC Edge Color	4 Electrical
Laminate (LKT)	See Edge Detail Options	See Laminate Selection	See PVC Edge Color Options	N None CT2 Dual Power Center Top (See chart on next page) CU1 Single Power Underside 5 Metal Finish See Metal Finish Color Options

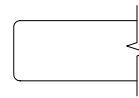
Model Number Breakdown

LKT4872-42WDRT						
LK	T	4872	42	WD	R	T
LOK	Laminate	48" x 72"	Height	Wedge Top Shape	Rounded Corner	T base

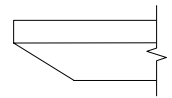
Description

Rounded Wedge Table with
T Base at Bar Height
(continued)

Veneer Tables
"LKV" Models



Eased Edge (R3)



Reverse Bevel Edge (K9)

VEN.	D	W	H	CTN WT	CU FT	① Model	Eased Edge (R3)		Reverse Bevel Edge (K9)	
							Flat Cut	Double Cut	Flat Cut	Double Cut
	48	72	42	160	101	LKV4872-42WDRT	\$2,803	\$3,026	\$3,054	\$3,252

LOK - TEAMWORK

Electrical Options and Upcharges

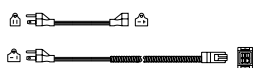
CT2	
Dual Power Center Top - Black	CT2BL - add \$1,437
Dual Power Center Top - White	CT2WH - add \$1,437
CU1	
Single Power Underside - Black	CU11C - add \$559
Single Power Underside with Wireless Charging- Black	CU11CW - add \$1,338

Note: Order power infeed that best fits application

To Order, Specify:

① Veneer Model #	② Edge Detail	③ Wood Species	④ Top Wood Finish	⑤ Electrical	⑥ Metal Color
Veneer (LKV)	See Edge Detail Options	Flat Cut B01 Black Oak CH1 Cherry MA1 Maple WA1 Walnut	See Flat Cut Top Wood Finish Options	N None CT2 Dual Power Center Top CU1 Single Power Underside (See chart above)	See Metal Finish Color Options
		Double Cut DC1 Double Cut	④ Top Wood Finish See Double Cut Top Wood Finish Options		

Description	D	W	H	CTN WT	CU FT	① Model	List Price
3 Prong Plug - 110 Power Infeed				1	1	AP72	\$322



- Features:**
- 72" plug power infeed
 - 20 amps/110 volts max
 - 3 prong plug - 15 amp adapter plug included
 - single circuit use only

Hardwire Power Infeed				1	1	HP72	\$262
------------------------------	--	--	--	---	---	------	-------



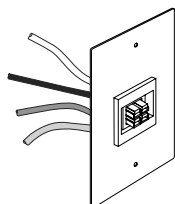
- Features:**
- 72" hardwire power infeed
 - 20 amps/120 volts max
 - single or double circuit
 - electrical contractor responsible for connection to building power source

Quick Disconnect Power Infeed				1	1	MP72	\$241
--------------------------------------	--	--	--	---	---	------	-------



- Features:**
- must be used with QD1
 - 72" modular power infeed
 - 20 amps/120 volts max
 - single or double circuit

Quick Disconnect Wall Outlet				1	1	QD1	\$123
-------------------------------------	--	--	--	---	---	-----	-------



- Features:**
- must be used with MP72
 - works for both single or double circuit
 - 20 amps/120 volts max
 - electrical contractor responsible for connection to building power source

Vertical Wire Manager	½	2 ¼	33	1	1	AVL33	\$138
	½	2 ¼	25	1	1	AVL25	\$104
	½	2 ¼	22	1	1	AVL20	\$85
	½	2 ¼	17	1	1	AVL17	\$80



- Features:**
- field installed
 - use AVL33 for 42" h tables with disk base
 - use AVL25 for 42" h tables
 - use AVL20 for 36" h tables
 - use AVL17 for 29" h tables

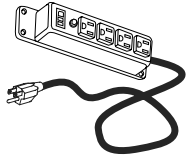
- Options:**
- specify plastic color, Black (B) or Silver (S)

Flexible Vertical Wire Manager	1 ½	1 ½	45	4	1	45VWM	\$131
---------------------------------------	-----	-----	----	---	---	-------	-------



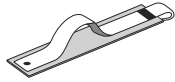
- Features:**
- black plastic
 - field installed to bottom of table top, with screws provided
 - wire manager is 1 ½" diameter
 - weighted base is 4" diameter
 - length can be adjusted by removing individual discs as required

Description	D	W	H	CTN WT	CU FT	Model	List Price
Power Strip	1 1/2	1 7/8	8	3	1	GP9ACP1-0212	\$93



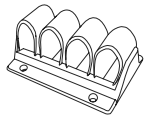
- Features:**
- power surge with 10" cord
 - four electrical outlets
 - includes switch
 - field installed

Wire Management Velcro Straps	1 3/4	3 1/2	1/4	1	1	04WVS	\$56
--------------------------------------	-------	-------	-----	---	---	-------	------



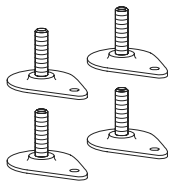
- Features:**
- black, set of 4
 - field installed to bottom of table top, with adhesive tape provided

Cable Management Clips	2 5/8	3 3/4	1 5/8	1	1	0304CMC	\$54
-------------------------------	-------	-------	-------	---	---	---------	------



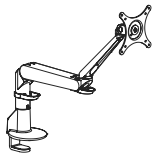
- Features:**
- black plastic
 - installed to bottom of table top
 - four retention loops

Floor Mount Glide	3	2 1/4	1/2	1	1	LKB516-18ANCHOR	\$41
--------------------------	---	-------	-----	---	---	-----------------	------



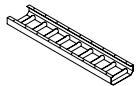
- Features:**
- field installed glides for mounting table base to floor
 - 1/4" diameter hole in the glide for mounting
 - set of 4
 - table can be leveled before attached to floor
 - floor attachment hardware provided by installer
 - glide threads 3/8"-16

Single Monitor Arm	4	11	10	9	1	GP5901MA	\$688
---------------------------	---	----	----	---	---	----------	-------



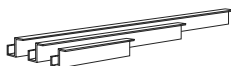
- Features:**
- one-touch reposition monitor adjustment
 - tension adjustment at each joint
 - flat panel mount rotates for portrait or landscape viewing
 - edge mount installation from above surface
 - cable management routes cables below monitor arm
 - specify Black (B) or Silver (S)
 - quick install VESA mount adapter

Wire Management Tray	7 1/2	45	3	8	2	GP9WMT1-0845	\$270
	7 1/2	35	3	6	1	GP9WMT1-0835	\$228
	7 1/2	25	3	4	1	GP9WMT1-0825	\$185



- Features:**
- silver powder-coated finish
 - four hanging brackets (CI2C00)

Wire Manager Trough	2 1/2	36	2 1/2	4	1	36WCT	\$152
	2 1/2	24	2 1/2	3	1	24WCT	\$138
	2 1/2	12	2 1/2	2	1	12WCT	\$119

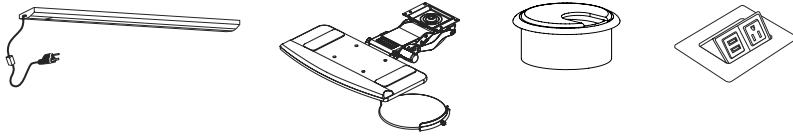


- Features:**
- black plastic
 - field installed to bottom of table top, with screws provided

Accessories/ Keyboard/ Tasklights

For an additional list of electrical units, grommets, keyboards, wire management, monitor arms & telecom jacks, please see our [accessories price list](#)

Contact your customer service representative for specific questions regarding which units can be used with Lok Teamwork.



Conference - Table of Contents



Lok - Conference

Product Information

Conference Overview 170
 Tables Shapes & Sizes 176-177
 Laminate Specifications 173
 Veneer Specifications 174
 Solid Surface Specifications 174
 Base Styles - Features 178
 Electrical Planning - Options 179-181

Pricing Pages

Conference Tables at Working Height . 182-295
 Conference Tables at Counter Height . 296-349
 Conference Tables at Bar Height . . . 350-403
 Credenzas 404-407
 Electrical 408-409

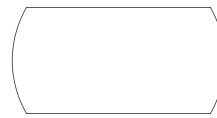
Conference - Overview



rectangular
 29"H - Pages 222, 224, 226,
 234, 236, 238
 36"H - Pages 334, 338
 42"H - Pages 386, 390



rounded rectangular
 29"H - Pages 228, 230, 232,
 240, 242, 244
 36"H - Pages 336, 340
 42"H - Pages 388, 392



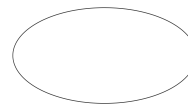
arc rectangular
 29"H - Pages 246, 248, 250
 258, 260, 262
 36"H - Pages 342, 346
 42"H - Pages 394, 398



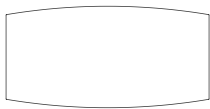
rounded arc rectangular
 29"H - Pages 252, 254, 256
 264, 266, 268
 36"H - Pages 344, 348
 42"H - Pages 396, 400



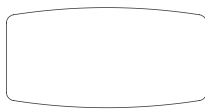
racetrack
 29"H - Pages 270, 272, 274
 36"H - Pages 350
 42"H - Pages 402



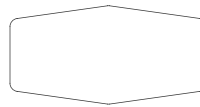
oval
 29"H - Pages 276, 278
 36"H - Pages 352
 42"H - Pages 404



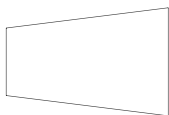
boat
 29"H - Pages 280, 282, 284
 292, 294, 296
 36"H - Pages 354, 356
 42"H - Pages 406, 408



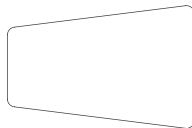
rounded boat
 29"H - Pages 286, 288, 290



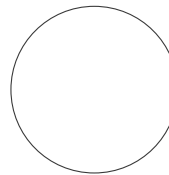
rounded double chevron
 29"H - Pages 298, 300
 36"H - Pages 358, 360
 42"H - Pages 410, 412



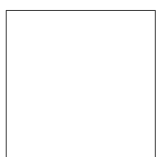
taper
 29"H - Pages 302, 304, 310, 312
 36"H - Pages 362, 366
 42"H - Pages 414, 418



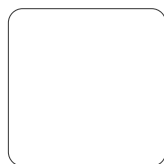
rounded taper
 29"H - Pages 306, 308, 314, 316
 36"H - Pages 364, 368
 42"H - Pages 416, 420



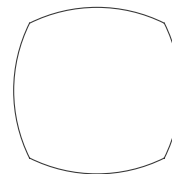
round
 29"H - Pages 318, 320
 36"H - Pages 370, 372
 42"H - Pages 422, 424



square
 29"H - Pages 322, 326
 36"H - Pages 374, 378
 42"H - Pages 426, 430



rounded square
 29"H - Pages 324, 328
 36"H - Pages 376, 378
 42"H - Pages 428, 432

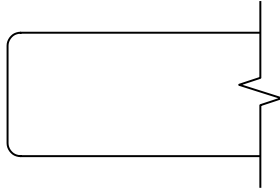


squire
 29"H - Pages 330, 332
 36"H - Pages 382, 384
 42"H - Pages 434, 436

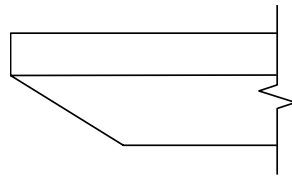
Conference - Materials

Laminate Tops

Lok conference table worksurfaces are offered in HPL (High Pressure Laminate) The tops are 1 3/16" thick, 3 ply balanced construction. Particle board core and a phenolic backer sheet complete the balanced construction.



Eased Edge (R3)
PVC



Reverse Bevel (K9)
PVC on painted top of painted MDF

Standard PVC Edge Colors

JSI supports 24 standard PVC edge colors listed below. These coordinate with our Standard (Tier1) Laminates.

When selecting a Standard (Tier 1) Laminate, the coordinating PVC edge color is automatically applied. When selecting a Graded-In Laminate (Tier 2 or 3), you will be prompted to choose one these 24 PVC edge colors to be applied to the edge.

ALB Alabaster	GRH Graphite
ALL Ale Light	MIN Mineral
BLK Black	OAT Oatmeal Cookie
BOL Bourbon Light	PIN Pinnacle Walnut
BZW Brazilwood	PLT Platinum
BBL Bridal Blanco	SHD Shadow
BGL Brighton Light	SLG Slate Grey
CLL Collectors	STU Studio Teak
DWH Designer White	UMB Umber
DOV Dove Grey	VAL Valley
FAW Fawn	VIN Vintage
FLO Florence Walnut	WEA Weathered Ash

Standard Laminates

JSI Standard Laminate program consists of 22 solid and wood grain patterns, and establish our Tier 1 laminate pricing. Each has a coordinating PVC edge color that is automatically used with the Standard Laminates.

Wood Grain Laminate

ALL Ale Light	MIN Mineral
BOL Bourbon Light	OAT Oatmeal Cookie
BZW Brazilwood	PIN Pinnacle Walnut
BGL Brighton Light	STU Studio Teak
CLL Collectors	UMB Umber
FAW Fawn	VAL Valley
FLO Florence Walnut	VIN Vintage
GRH Graphite	WEA Weathered Ash

Solid Laminate

ALB Alabaster
BLK Black
BBL Bridal Blanco
DWH Designer White
SHD Shadow
SLG Slate Grey

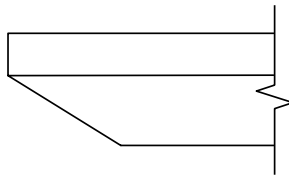
Conference - Materials

Veneer Tops

Tops are 1 3/16" thick, 5 ply balanced construction with particle board core. Standard Tier 1 veneer is flat cut, book matched for cherry, maple and walnut veneer. Standard Tier 2 veneer is double cut.



Eased Edge (R3)
Internal Lumber Band



Reverse Bevel (K9)
Veneer Band on Stained MDF

Finish - Stain/Colors

CH1 Cherry	<i>Flat Cut Veneer</i>		
BBM Bourbon Medium	CLL Collectors		
BRM Brighton Medium	HRV Harvest		
CLA Classic	PRL Praline		

MA1 Maple	<i>Flat Cut Veneer</i>		
ALM Ale Medium	FLX Flax		
BUT Butterscotch	VEN Venetian		

WA1 Walnut	<i>Flat Cut Veneer</i>		
ESP Espresso	TRF Truffle		
MCH Mocha	UMB Umber		
SIE Sienna			

B01 Black Oak	<i>Flat Cut Veneer</i>		
RAV Raven			

DC1 Double Cut Veneer			
BAR Barrel - Oak Pattern	KHK Khaki		
BUF Buff - Oak Pattern	MIN Mineral - Oak Pattern		
CND Cinder - Oak Pattern	RYE Rye - Oak Pattern		
COF Coffee	SAB Sable - Oak Pattern		
EGR Egret	SAD Saddle - Oak Pattern		
FAW Fawn	STU Studio Teak		
GRH Graphite	VAL Valley		

Protective Top Coat

DuraTex™ offers exceptional hardness along with abrasion and impact resistance, it has been formulated to eliminate hazardous and harmful gases that are normally associated with wood finish.

DuraTex™ Features

Safety - Significantly reduces hazardous formaldehyde emissions which help improve the quality of the of the indoor air we breathe.

Quality - Developed to be tough and durable with special attention to appearance. The DuraTex™ finish preserves the natural beauty of wood.

Durability - Designed to meet a wide range of demanding performance and environmental standards to withstand even the highest wear and tear.

Special Finishes

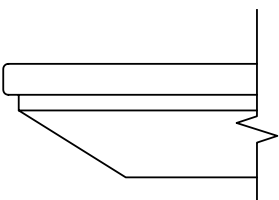
Special finishes can be requested by contacting customer service. There is a one time charge of \$372 list per order.

Finish Sheen

All veneer finishes are standard in 35-sheen, with the exception of Raven. Raven is only offered in 15 sheen. All other finishes can have their sheen modified with a 15% upcharge added to the list price of each item.

Solid Surface Tops

Tops are 1 3/16" thick constructed of 1/2" thick Solid Surface on top of a 1/16" MDF sub top. Sub top has an under cut bevel profile and is painted in a coordinated color to match the Solid Surface.



Reverse Bevel Edge (K7)
Solid Surface over painted MDF

Standard Solid Surface

ARM	Armadillo
BLP	Black Pearl
PEB	Pebble Pearl
PUR	Pure White

Conference - Top Shapes

Lok offers 16 conference table top shapes. Tables are available in 29", 36" or 42" high and in laminate, veneer or solid surface. Compatible bases are: T Base, X Base, X4 Base, or Y Base.



rectangular

29"h

- 36" x 84" Seats 6
- 36" x 96" Seats 8
- 42" x 84" Seats 6
- 42" x 96" Seats 8
- 48" x 84" Seats 6
- 48" x 96" Seats 8
- 48" x 108" Seats 8
- 48" x 120" Seats 8
- 48" x 144" Seats 12
- 48" x 168" Seats 14
- 48" x 192" Seats 16
- 48" x 216" Seats 18
- 48" x 240" Seats 20
- 54" x 120" Seats 8
- 54" x 144" Seats 12
- 54" x 168" Seats 14
- 54" x 192" Seats 16
- 54" x 216" Seats 18
- 54" x 240" Seats 20
- 60" x 120" Seats 8
- 60" x 144" Seats 12
- 60" x 168" Seats 14
- 60" x 192" Seats 16
- 60" x 216" Seats 18
- 60" x 240" Seats 20

36"h

- 36" x 84" Seats 6
- 36" x 96" Seats 8
- 42" x 84" Seats 6
- 42" x 96" Seats 8
- 48" x 84" Seats 6
- 48" x 96" Seats 8

42"h

- 36" x 84" Seats 6
- 36" x 96" Seats 8
- 42" x 84" Seats 6
- 42" x 96" Seats 8
- 48" x 84" Seats 6
- 48" x 96" Seats 8



rounded rectangular

29"h

- 36" x 84" Seats 6
- 36" x 96" Seats 8
- 42" x 84" Seats 6
- 42" x 96" Seats 8
- 48" x 84" Seats 6
- 48" x 96" Seats 8
- 48" x 108" Seats 8
- 48" x 120" Seats 8
- 48" x 144" Seats 12
- 48" x 168" Seats 14
- 48" x 192" Seats 16
- 48" x 216" Seats 18
- 48" x 240" Seats 20
- 54" x 120" Seats 8
- 54" x 144" Seats 12
- 54" x 168" Seats 14
- 54" x 192" Seats 16
- 54" x 216" Seats 18
- 54" x 240" Seats 20
- 60" x 120" Seats 8
- 60" x 144" Seats 12
- 60" x 168" Seats 14
- 60" x 192" Seats 16
- 60" x 216" Seats 18
- 60" x 240" Seats 20

36"h

- 36" x 84" Seats 6
- 36" x 96" Seats 8
- 42" x 84" Seats 6
- 42" x 96" Seats 8
- 48" x 84" Seats 6
- 48" x 96" Seats 8

42"h

- 36" x 84" Seats 6
- 36" x 96" Seats 8
- 42" x 84" Seats 6
- 42" x 96" Seats 8
- 48" x 84" Seats 6
- 48" x 96" Seats 8



arc rectangular

29"h

- 36" x 84" Seats 6
- 36" x 96" Seats 8
- 42" x 84" Seats 6
- 42" x 96" Seats 8
- 48" x 84" Seats 6
- 48" x 96" Seats 8
- 48" x 108" Seats 8
- 48" x 120" Seats 8
- 48" x 144" Seats 12
- 48" x 168" Seats 14
- 48" x 192" Seats 16
- 48" x 216" Seats 18
- 48" x 240" Seats 20
- 54" x 120" Seats 8
- 54" x 144" Seats 12
- 54" x 168" Seats 14
- 54" x 192" Seats 16
- 54" x 216" Seats 18
- 54" x 240" Seats 20
- 60" x 120" Seats 8
- 60" x 144" Seats 12
- 60" x 168" Seats 14
- 60" x 192" Seats 16
- 60" x 216" Seats 18
- 60" x 240" Seats 20

36"h

- 36" x 84" Seats 6
- 36" x 96" Seats 8
- 42" x 84" Seats 6
- 42" x 96" Seats 8
- 48" x 84" Seats 6
- 48" x 96" Seats 8

42"h

- 36" x 84" Seats 6
- 36" x 96" Seats 8
- 42" x 84" Seats 6
- 42" x 96" Seats 8
- 48" x 84" Seats 6
- 48" x 96" Seats 8



rounded arc rectangular

29"h

- 36" x 84" Seats 6
- 36" x 96" Seats 8
- 42" x 84" Seats 6
- 42" x 96" Seats 8
- 48" x 84" Seats 6
- 48" x 96" Seats 8
- 48" x 108" Seats 8
- 48" x 120" Seats 8
- 48" x 144" Seats 12
- 48" x 168" Seats 14
- 48" x 192" Seats 16
- 48" x 216" Seats 18
- 48" x 240" Seats 20
- 54" x 120" Seats 8
- 54" x 144" Seats 12
- 54" x 168" Seats 14
- 54" x 192" Seats 16
- 54" x 216" Seats 18
- 54" x 240" Seats 20
- 60" x 120" Seats 8
- 60" x 144" Seats 12
- 60" x 168" Seats 14
- 60" x 192" Seats 16
- 60" x 216" Seats 18
- 60" x 240" Seats 20

36"h

- 36" x 84" Seats 6
- 36" x 96" Seats 8
- 42" x 84" Seats 6
- 42" x 96" Seats 8
- 48" x 84" Seats 6
- 48" x 96" Seats 8

42"h

- 36" x 84" Seats 6
- 36" x 96" Seats 8
- 42" x 84" Seats 6
- 42" x 96" Seats 8
- 48" x 84" Seats 6
- 48" x 96" Seats 8



racetrack

29"h

- 36" x 84" Seats 6
- 36" x 96" Seats 8
- 42" x 84" Seats 6
- 42" x 96" Seats 8
- 48" x 84" Seats 6
- 48" x 96" Seats 8
- 48" x 108" Seats 8
- 48" x 120" Seats 8
- 48" x 144" Seats 12
- 48" x 168" Seats 14
- 48" x 192" Seats 16
- 48" x 216" Seats 18
- 48" x 240" Seats 20
- 54" x 120" Seats 8
- 54" x 144" Seats 12
- 54" x 168" Seats 14
- 54" x 192" Seats 16
- 54" x 216" Seats 18
- 54" x 240" Seats 20
- 60" x 120" Seats 8
- 60" x 144" Seats 12
- 60" x 168" Seats 14
- 60" x 192" Seats 16
- 60" x 216" Seats 18
- 60" x 240" Seats 20

36"h

- 36" x 84" Seats 6
- 36" x 96" Seats 8
- 42" x 84" Seats 6
- 42" x 96" Seats 8
- 48" x 84" Seats 6
- 48" x 96" Seats 8

42"h

- 36" x 84" Seats 6
- 36" x 96" Seats 8
- 42" x 84" Seats 6
- 42" x 96" Seats 8
- 48" x 84" Seats 6
- 48" x 96" Seats 8



oval

29"h

- 42" x 84" Seats 6
- 48" x 96" Seats 8
- 54" x 108" Seats 8
- 60" x 120" Seats 10

36"h

- 42" x 84" Seats 6
- 48" x 96" Seats 8

42"h

- 42" x 84" Seats 6
- 48" x 96" Seats 8

Conference - Top Shapes

Lok offers 15 conference table top shapes. Tables are available in 29", 36" or 42" high and in laminate, veneer or solid surface. Compatible bases are: T Base, X Base, X4 Base, or Y Base.



boat

29"h

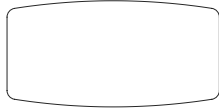
- 36" x 84" Seats 6
- 36" x 96" Seats 8
- 42" x 84" Seats 6
- 42" x 96" Seats 8
- 48" x 84" Seats 6
- 48" x 96" Seats 8
- 48" x 108" Seats 8
- 48" x 120" Seats 8
- 48" x 144" Seats 12
- 48" x 168" Seats 14
- 48" x 192" Seats 16
- 48" x 216" Seats 18
- 48" x 240" Seats 20
- 54" x 120" Seats 8
- 54" x 144" Seats 12
- 54" x 168" Seats 14
- 54" x 192" Seats 16
- 54" x 216" Seats 18
- 54" x 240" Seats 20
- 60" x 120" Seats 8
- 60" x 144" Seats 12
- 60" x 168" Seats 14
- 60" x 192" Seats 16
- 60" x 216" Seats 18
- 60" x 240" Seats 20

36"h

- 36" x 84" Seats 6
- 36" x 96" Seats 8
- 42" x 84" Seats 6
- 42" x 96" Seats 8
- 48" x 84" Seats 6
- 48" x 96" Seats 8

42"h

- 36" x 84" Seats 6
- 36" x 96" Seats 8
- 42" x 84" Seats 6
- 42" x 96" Seats 8
- 48" x 84" Seats 6
- 48" x 96" Seats 8



rounded boat

29"h

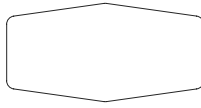
- 36" x 84" Seats 6
- 36" x 96" Seats 8
- 42" x 84" Seats 6
- 42" x 96" Seats 8
- 48" x 84" Seats 6
- 48" x 96" Seats 8
- 48" x 108" Seats 8
- 48" x 120" Seats 8
- 48" x 144" Seats 12
- 48" x 168" Seats 14
- 48" x 192" Seats 16
- 48" x 216" Seats 18
- 48" x 240" Seats 20
- 54" x 120" Seats 8
- 54" x 144" Seats 12
- 54" x 168" Seats 14
- 54" x 192" Seats 16
- 54" x 216" Seats 18
- 54" x 240" Seats 20
- 60" x 120" Seats 8
- 60" x 144" Seats 12
- 60" x 168" Seats 14
- 60" x 192" Seats 16
- 60" x 216" Seats 18
- 60" x 240" Seats 20

36"h

- 36" x 84" Seats 6
- 36" x 96" Seats 8
- 42" x 84" Seats 6
- 42" x 96" Seats 8
- 48" x 84" Seats 6
- 48" x 96" Seats 8

42"h

- 36" x 84" Seats 6
- 36" x 96" Seats 8
- 42" x 84" Seats 6
- 42" x 96" Seats 8
- 48" x 84" Seats 6
- 48" x 96" Seats 8



rounded double chevron

29"h

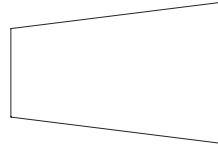
- 36" x 84" Seats 6
- 36" x 96" Seats 8
- 42" x 84" Seats 6
- 42" x 96" Seats 8
- 48" x 84" Seats 6
- 48" x 96" Seats 8

36"h

- 36" x 84" Seats 6
- 36" x 96" Seats 8
- 42" x 84" Seats 6
- 42" x 96" Seats 8
- 48" x 84" Seats 6
- 48" x 96" Seats 8

42"h

- 36" x 84" Seats 6
- 36" x 96" Seats 8
- 42" x 84" Seats 6
- 42" x 96" Seats 8
- 48" x 84" Seats 6
- 48" x 96" Seats 8



taper

29"h

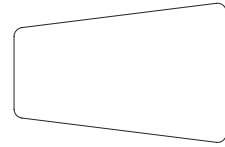
- 54" x 96" Seats 8
- 60" x 120" Seats 10

36"h

- 54" x 96" Seats 8

42"h

- 54" x 96" Seats 8



rounded taper

29"h

- 54" x 96" Seats 8
- 60" x 120" Seats 10

36"h

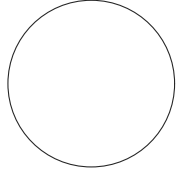
- 54" x 96" Seats 8

42"h

- 54" x 96" Seats 8

Lok - Top Shapes

Lok offers 16 conference table top shapes. Tables are available in 29", 36" or 42" high and in laminate, veneer or solid surface. Compatible bases are: T Base, X Base, X4 Base, or Y Base.



round

29"h

30"	Seats 3
36"	Seats 4
42"	Seats 4
48"	Seats 4
54"	Seats 6
60"	Seats 8



square

29"h

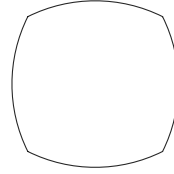
30" x 30"	Seats 4
36" x 36"	Seats 4
42" x 42"	Seats 4
48" x 48"	Seats 4
54" x 54"	Seats 6
60" x 60"	Seats 8



rounded square

29"h

30" x 30"	Seats 4
36" x 36"	Seats 4
42" x 42"	Seats 4
48" x 48"	Seats 4
54" x 54"	Seats 6
60" x 60"	Seats 8



squircle

29"h

30" x 30"	Seats 4
36" x 36"	Seats 4
42" x 42"	Seats 4
48" x 48"	Seats 4
54" x 54"	Seats 6
60" x 60"	Seats 8

36"h

30"	Seats 3
36"	Seats 4
42"	Seats 4
48"	Seats 4
54"	Seats 6
60"	Seats 8

36"h

30" x 30"	Seats 4
36" x 36"	Seats 4
42" x 42"	Seats 4
48" x 48"	Seats 4
54" x 54"	Seats 6
60" x 60"	Seats 8

36"h

30" x 30"	Seats 4
36" x 36"	Seats 4
42" x 42"	Seats 4
48" x 48"	Seats 4
54" x 54"	Seats 6
60" x 60"	Seats 8

36"h

30" x 30"	Seats 4
36" x 36"	Seats 4
42" x 42"	Seats 4
48" x 48"	Seats 4
54" x 54"	Seats 6
60" x 60"	Seats 8

42"h

30"	Seats 3
36"	Seats 4
42"	Seats 4
48"	Seats 4
54"	Seats 6
60"	Seats 8

42"h

30" x 30"	Seats 4
36" x 36"	Seats 4
42" x 42"	Seats 4
48" x 48"	Seats 4
54" x 54"	Seats 6
60" x 60"	Seats 8

42"h

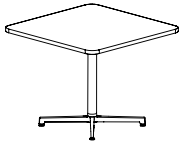
30" x 30"	Seats 4
36" x 36"	Seats 4
42" x 42"	Seats 4
48" x 48"	Seats 4
54" x 54"	Seats 6
60" x 60"	Seats 8

42"h

30" x 30"	Seats 4
36" x 36"	Seats 4
42" x 42"	Seats 4
48" x 48"	Seats 4
54" x 54"	Seats 6
60" x 60"	Seats 8

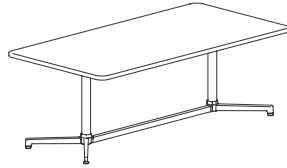
Conference - Base Styles

Lok provides a choice selection of bases in both function and aesthetics to serve a variety of needs. The conferencing offering includes: T-base, Y-Base, X-base, and X4 base



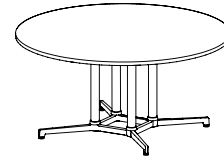
X-Base

- available 29"h, 36"h or 42"h only in glides.
- compatible with the following top shapes: round, square or squircle
- base finish aged bronze, arctic silver, gold, pewter, matte black, soft bronze, soft nickel
- two-tone base aesthetics are achieved when selecting polished aluminum foot, and then any of the other finishes on the column
- power access version, with integrated wire management available with an upcharge



Y Base

- available in 29"h, 36"h or 42"h only in glides.
- compatible with the following top shapes: arc rectangular, boat, double chevron, oval, racetrack, rectangular, round, square and taper
- base finish aged bronze, arctic silver, gold, pewter, matte black, soft bronze, soft nickel
- two-tone base aesthetics are achieved when selecting polished aluminum foot, and then any of the other finishes on the column

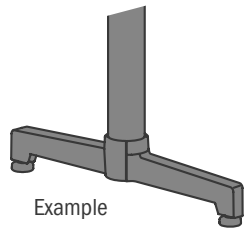


X4 Base

- available in 29"h, 36"h or 42"h only in glides
- compatible with the following top shapes: round, square, and squircle
- base finish aged bronze, arctic silver, gold, pewter, matte black, soft bronze, soft nickel
- two-tone base aesthetics are achieved when selecting polished aluminum foot, and then any of the other finishes on the column

Single Metal Finish

- ABZ** Aged Bronze Feet & Post
- ASL** Arctic Silver Feet & Post
- GLD** Gold Feet & Post
- PEW** Pewter Feet & Post
- MBK** Matte Black Feet & Post
- SBZ** Soft Bronze Feet & Post
- SNK** Soft Nickel Feet & Post



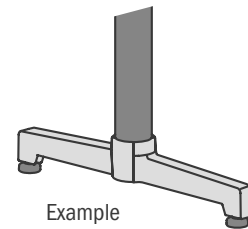
Example

Two - Tone Metal Finish

Two - Tone Aesthetics can be achieved by specifying Polished Aluminum on the foot and a contrasting finish on the post

Polished Aluminum Feet

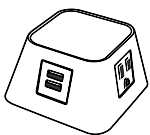
- ABZ** - Aged Bronze Post
- ASL** - Arctic Silver Post
- GLD** - Gold Post
- PEW** - Pewter Post
- MBK** - Matte Black Post
- SBZ** - Soft Bronze Post
- SNK** - Soft Nickel Post



Example

Power/Charging Options

Lok offers the ability to place power and charging options in the center of select tables. Select your choice of EC23 or EC24, available in black and white.



Moire - EC23

- Three 110 outlets
- Dual USB port with 72" power cord
- Black (B) or White (W)

select CTEC23 for cutout in worksurfaces

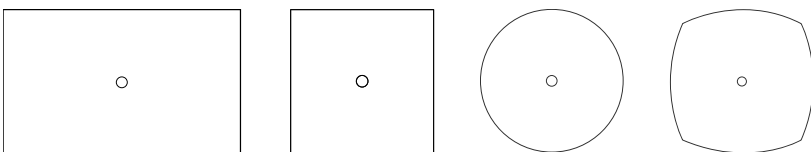


Node - EC24

- One 110 outlet
- Dual USB port with 72" power cord
- Black (B) or White (W)

select CTEC24 for cutout in worksurfaces

Cut outs are located in the center of each table. See below for representation or location.

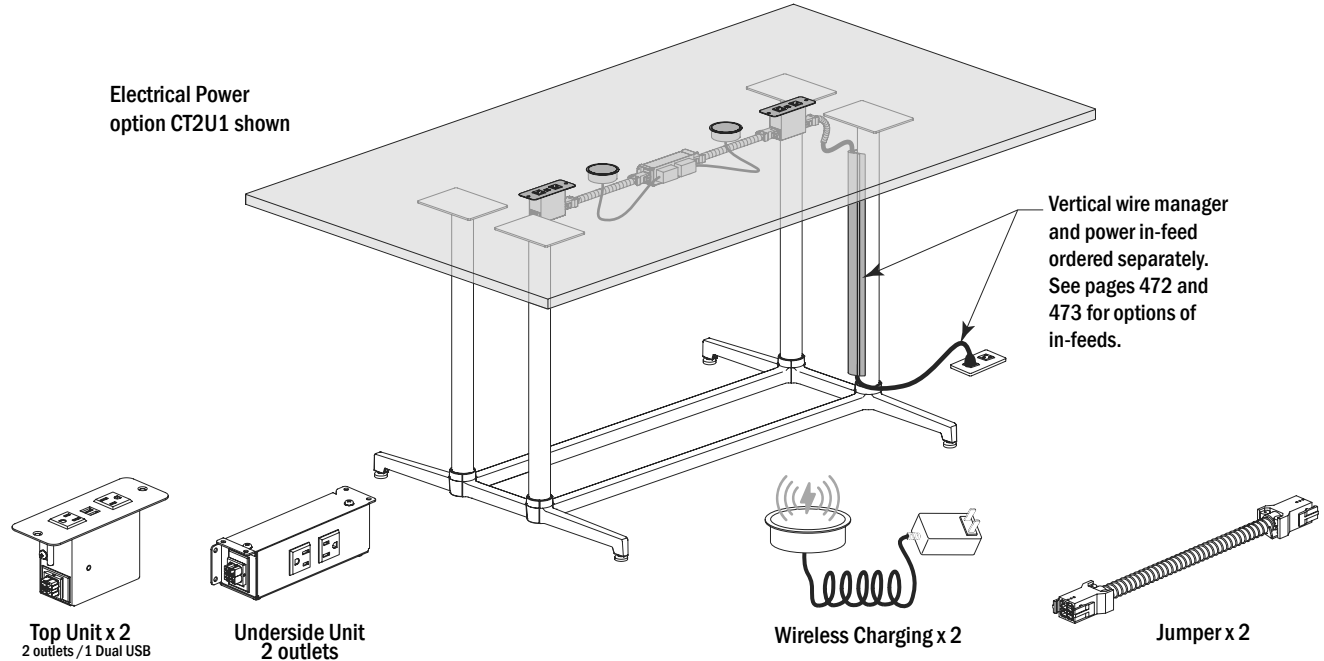


Lok Product Information

Electrical Overview

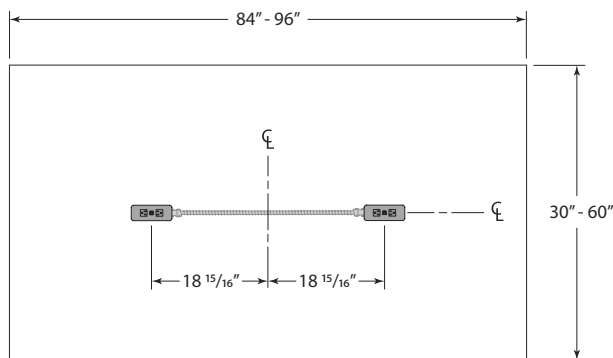
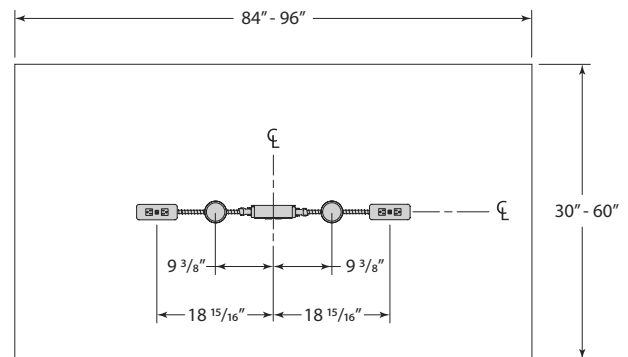
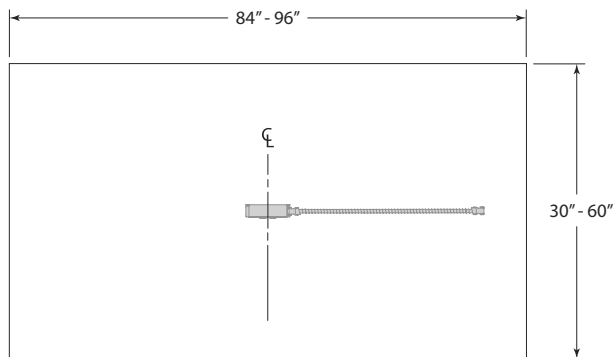
Lok provides several packages to choose from for your electrical needs. Choose solutions for top surface power, underneath outlets, wireless charging, or a combination.

Specifying an electrical package eliminates your need to calculate additional components, as all units and necessary jumpers will ship with your table. You will only need to determine which power in-feed best suits your needs and order separately.



Electrical - 1 Piece Tops

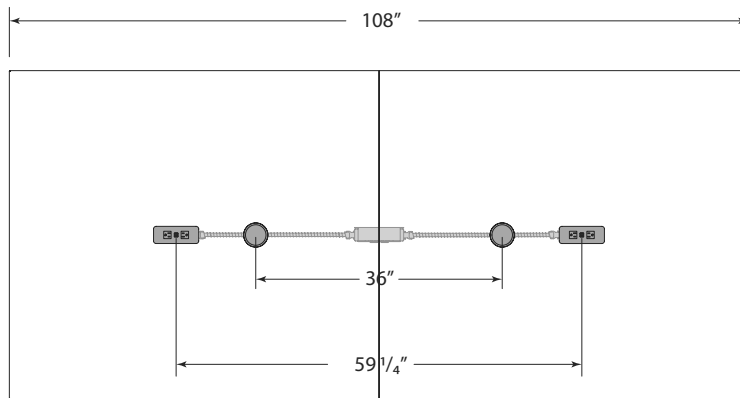
Power and Charging Packages are measured and located out from the center of the table. Shown on rectangular tops, these dimensions are the same from center regardless of table shape (ie chevron, boat, etc.). Power in-feed is specified separately to support building electrical connection.



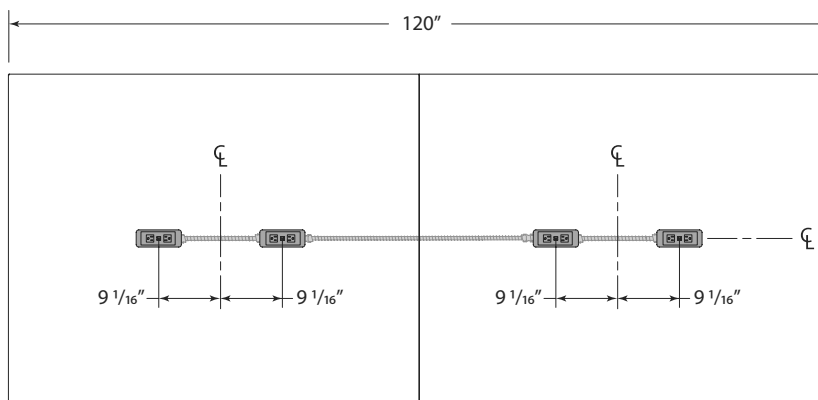
Conference - Electrical

Electrical - 2 Piece Tops

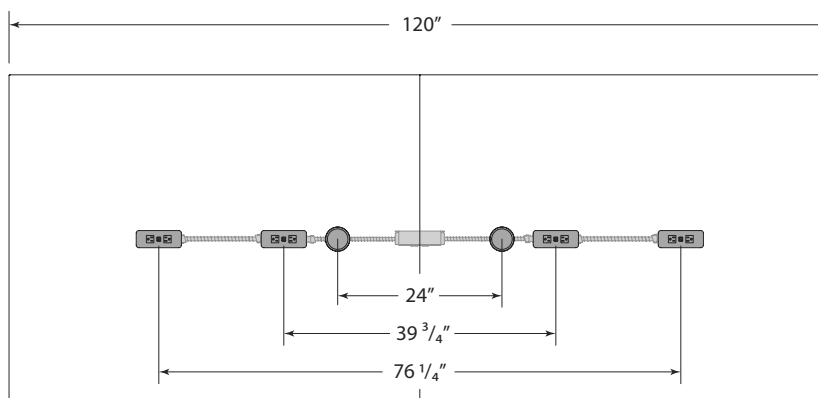
Power and Charging Packages are measured and located out from the center of the table. Shown on rectangular tops, these dimensions are the same from center regardless of table shape (ie chevron, boat, etc.). Power in-feed is specified separately to support building electrical connection.



CT2 - Dual Power Top with Underside and Two Wireless Charging



CT4 - Four Power Top

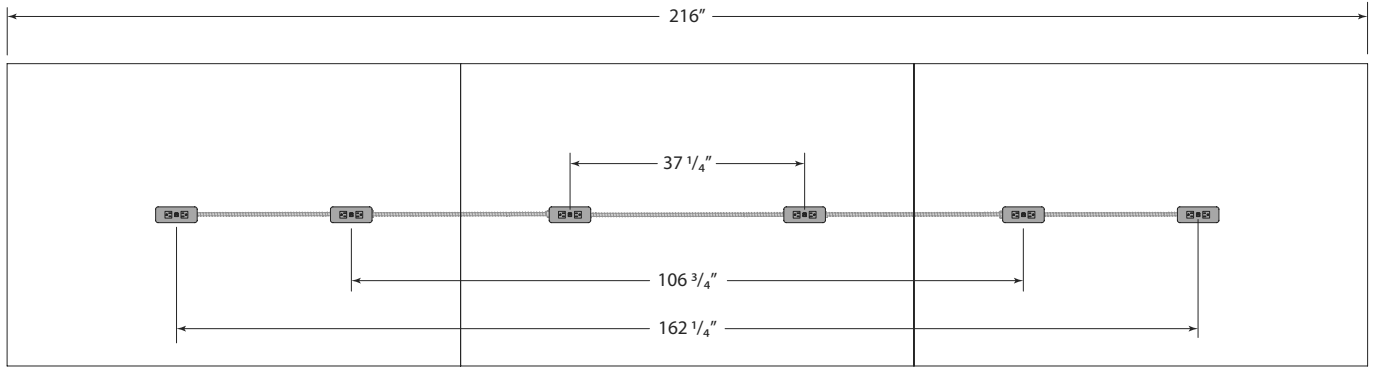


CT4 - Four Power Top with Underside and Two Wireless Charging

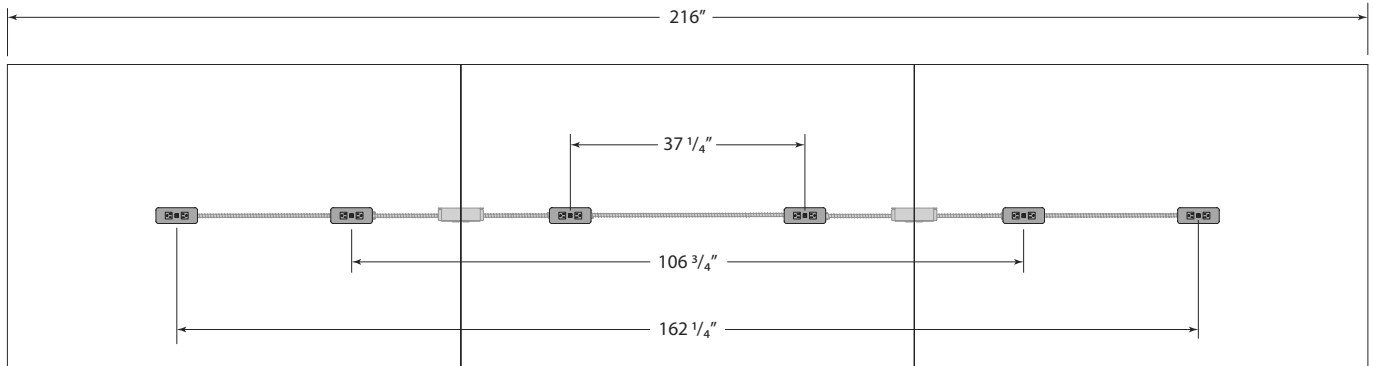
Conference - Electrical

Electrical - 3 Piece Tops

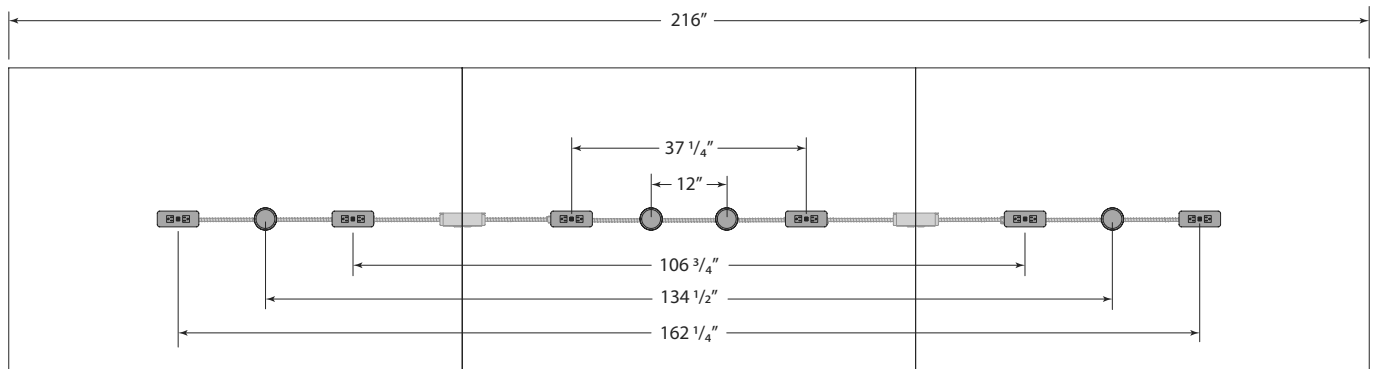
Power and Charging Packages are measured and located out from the center of the table. Shown on rectangular tops, these dimensions are the same from center regardless of table shape (ie chevron, boat, etc.). Power in-feed is specified separately to support building electrical connection.



CT6 - Six Power Top



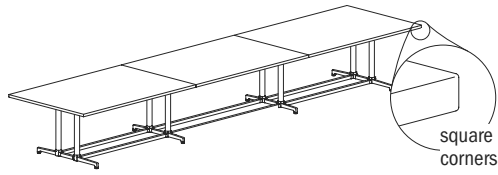
CT6 - Six Power Top



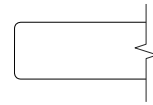
CT6 - Six Power Top with Dual Underside and Four Wireless Charging

Description

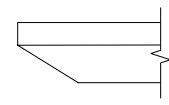
Rectangular 3pc Table with T Base at Working Height



**Laminate Tables
"LKT" Models**



Eased Edge (R3)



Reverse Bevel Edge (K9)

LAMINATE	D	W	H	CTN WT	CU FT	Model	Eased Edge (R3)			Reverse Bevel Edge (K9)		
							Standard	Graded In		Standard	Graded In	
							Tier 1	Tier 2	Tier 3	Tier 1	Tier 2	Tier 3
	60	240	29	653	281	LKT60240-29TTT	\$9,780	\$9,940	\$10,930	\$10,461	\$10,619	\$11,325
	60	216	29	598	253	LKT60216-29TTT	\$8,205	\$8,348	\$9,240	\$8,854	\$8,997	\$9,632
	54	240	29	603	254	LKT54240-29TTT	\$7,868	\$8,012	\$8,904	\$8,513	\$8,657	\$9,293
	54	216	29	453	229	LKT54216-29TTT	\$7,404	\$7,534	\$8,336	\$8,023	\$8,152	\$8,725
	48	240	29	551	228	LKT48240-29TTT	\$7,503	\$7,632	\$8,423	\$8,114	\$8,241	\$8,808
	48	216	29	553	206	LKT48216-29TTT	\$7,068	\$7,184	\$7,898	\$7,656	\$7,771	\$8,280

Features:

- price reflects complete table - top and base
- ships KD in multiple cartons
- three piece top
- model includes adjustable glide

Options:

- specify power/charging option, see below for options and upcharges



top shape

LOK - CONFERENCE

To Order Specify

1 Laminate Model #	2 Edge Detail	3 Laminate Selection	3a PVC Edge Color	4 Electrical	5 Metal Color
Laminate (LKT)	See Edge Detail Options	See Laminate Selection	See PVC Edge Color Options	N None CT6 Six Power Center Top CU2 Dual Power Underside CT6U2 Six Power Center Top with Underside (See chart on next page)	See Metal Finish Color Options

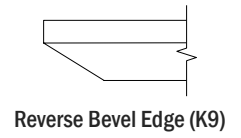
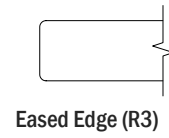
Model Number Breakdown

LKT60240-29TTT					
LK	T	60240	29	TT	T
LOK	Laminate	60" x 240"	Height	Rectangular Top Shape	T base

Description

Rectangular 3pc Table with T Base at Working Height (continued)

Veneer Tables "LKV" Models



VENEER	D	W	H	CTN WT	CU FT	1 Model	Eased Edge (R3)		Reverse Bevel Edge (K9)	
							Flat Cut	Double Cut	Flat Cut	Double Cut
	60	240	29	653	281	LKV60240-29TTT	\$15,224	\$16,441	\$16,592	\$17,670
	60	216	29	598	253	LKV60216-29TTT	\$13,391	\$14,461	\$14,596	\$15,545
	54	240	29	603	254	LKV54240-29TTT	\$12,878	\$13,944	\$13,499	\$14,511
	54	216	29	603	254	LKV54216-29TTT	\$11,958	\$12,901	\$12,528	\$13,425
	48	240	29	324	130	LKV48240-29TTT	\$11,117	\$12,056	\$11,678	\$12,566
	48	216	29	551	228	LKV48216-29TTT	\$11,241	\$12,071	\$11,758	\$12,543

Electrical Options and Upcharges

	216 - 240 wide
CT6	
Six Power Center Top - Black	CT6BL - add \$4,016
Six Power Center Top - White	CT6WH - add \$4,016
CU2	
Dual Power Underside - Black	CU2-1C - add \$1,052
Dual Power Underside with 4 Wireless Charging - Black	CU2-1CW - add \$2,660
CT6U2	
Six Power Center Top - Black with Dual Underside	CT6U2-BL - add \$4,665
Six Power Center Top - White with Dual Underside	CT6U2-WH - add \$4,665
Six Power Center Top - Black Dual Underside with 4 Wireless Charging	CT6U2-BLW2 - add \$6,223
Six Power Center Top - White Dual Underside with 4 Wireless Charging	CT6U2-WHW2 - add \$6,223

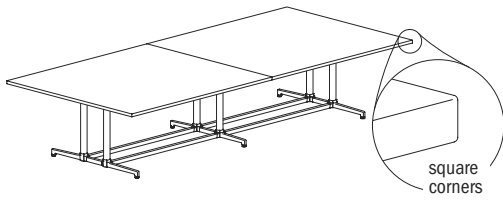
Note: Order power infeed that best fits application

To Order Specify

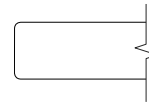
1 Veneer Model #	2 Edge Detail	3 Wood Species	4 Wood Finish	5 Electrical	6 Metal Color
Veneer (LKV)	See Edge Detail Options	Flat Cut CH1 Cherry MA1 Maple WA1 Walnut BO1 Black Oak	See Flat Cut Wood Finish Options	N None CT6 Six Power Center Top CU2 Dual Power Underside CT6U2 Six Power Center Top with Underside (See chart above)	See Metal Finish Color Options
		Double Cut DC1 Double Cut	4 Wood Finish See Double Cut Wood Finish Options		

Description

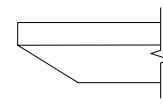
Rectangular 2pc Table with T Base at Working Height



Laminate Tables "LKT" Models



Eased Edge (R3)



Reverse Bevel Edge (K9)

LAMINATE	D	W	H	CTN WT	CU FT	Model	Standard			Graded In		
							Tier 1	Tier 2	Tier 3	Tier 1	Tier 2	Tier 3
		60	192	29	513	226	LKT60192-29TTT	\$6,926	\$7,055	\$7,846	\$7,542	\$7,670
	60	168	29	460	198	LKT60168-29TTT	\$6,475	\$6,588	\$7,281	\$7,062	\$7,174	\$7,669
	60	144	29	405	169	LKT60144-29TTT	\$5,988	\$6,083	\$6,677	\$6,546	\$6,640	\$7,067
	60	120	29	350	143	LKT60120-29TTT	\$5,204	\$5,283	\$5,779	\$5,731	\$5,813	\$6,165
	54	192	29	472	204	LKT54192-29TTT	\$6,480	\$6,595	\$7,308	\$7,070	\$7,185	\$7,694
	54	168	29	389	178	LKT54168-29TTT	\$5,871	\$5,970	\$6,595	\$6,435	\$6,536	\$6,981
	54	144	29	375	154	LKT54144-29TTT	\$5,410	\$5,497	\$6,033	\$5,949	\$6,036	\$6,417
	54	120	29	324	130	LKT54120-29TTT	\$4,896	\$4,968	\$5,412	\$5,407	\$5,479	\$5,797
	48	192	29	432	183	LKT48192-29TTT	\$5,650	\$5,753	\$6,387	\$6,214	\$6,317	\$6,769
	48	168	29	389	161	LKT48168-29TTT	\$5,256	\$5,346	\$5,900	\$5,796	\$5,887	\$6,284
	48	144	29	344	139	LKT48144-29TTT	\$4,822	\$4,900	\$5,376	\$5,342	\$5,419	\$5,758
	48	120	29	298	116	LKT48120-29TTT	\$4,335	\$4,400	\$4,796	\$4,832	\$4,896	\$5,180
	48	108	29	275	105	LKT48108-29TTT	\$3,664	\$3,721	\$4,079	\$4,149	\$4,206	\$4,462

Features:

- price reflects complete table - top and base
- ships KD in multiple cartons
- two piece top
- model includes adjustable glide

· specify power/charging option, see below for options and upcharges



top shape

LOK - CONFERENCE

To Order Specify

1 Laminate Model #	2 Edge Detail	3 Laminate Selection	3a PVC Edge Color	4 Electrical	5 Metal Color
Laminate (LKT)	See Edge Detail Options	See Laminate Selection	See PVC Edge Color Options	N None CT2 Dual Power Center Top CU2 Dual Power Underside CT2U1 Dual Power Center Top with Underside CT4U2 Four Power Center Top with Underside CT4 Four Power Center Top (See chart on next page)	See Metal Finish Color Options

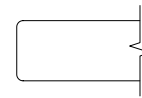
Model Number Breakdown

LKT60192-29TTT					
LK	T	60192	29	TT	T
LOK	Laminate	60" x 192"	Height	Rectangular Top Shape	T base

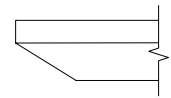
Description

Rectangular 2pc Table with T Base at Working Height (continued)

Veneer Tables "LKV" Models



Eased Edge (R3)



Reverse Bevel Edge (K9)

D	W	H	CTN WT	CU FT	Model	Eased Edge (R3)		Reverse Bevel Edge (K9)	
						Flat Cut	Double Cut	Flat Cut	Double Cut
60	192	29	513	226	LKV60192-29TTT	\$10,604	\$11,453	\$11,559	\$12,310
60	168	29	460	198	LKV60168-29TTT	\$9,763	\$10,543	\$10,639	\$11,331
60	144	29	460	198	LKV60144-29TTT	\$8,890	\$9,601	\$9,692	\$10,320
60	120	29	405	169	LKV60120-29TTT	\$7,848	\$8,476	\$8,555	\$9,111
54	192	29	453	204	LKV54192-29TTT	\$9,702	\$10,479	\$10,574	\$11,263
54	168	29	472	204	LKV54168-29TTT	\$9,927	\$10,720	\$10,818	\$11,523
54	144	29	389	178	LKV54144-29TTT	\$8,068	\$8,712	\$8,794	\$9,364
54	120	29	375	154	LKV54120-29TTT	\$7,206	\$7,782	\$7,854	\$8,364
48	192	29	553	206	LKV48192-29TTT	\$9,733	\$10,462	\$10,208	\$10,895
48	168	29	432	183	LKV48168-29TTT	\$7,991	\$8,621	\$8,425	\$9,016
48	144	29	389	161	LKV48144-29TTT	\$7,240	\$7,771	\$7,635	\$8,133
48	120	29	344	139	LKV48120-29TTT	\$6,440	\$6,874	\$6,793	\$7,200
48	108	29	298	116	LKV48108-29TTT	\$5,279	\$5,698	\$5,753	\$6,126

Electrical Options and Upcharges

CT2	108 wide	120 - 192 wide
Dual Power Center Top - Black	CT2BL - add \$1,490	n/a
Dual Power Center Top - White	CT2WH - add \$1,490	n/a
CU1		
Single Power Underside - Black	CU1-1C - add \$592	CU1-1C - add \$688
Single Power Underside with Wireless Charging - Black	CU1-1CW - add \$1,371	CU1-1CW - add \$1,440
CT2U1		
Dual Power Center Top - Black with Underside	CT2U1-BL - add \$1,813	n/a
Dual Power Center Top - White with Underside	CT2U1-WH - add \$1,813	n/a
Dual Power Center Top - Black with Wireless Charging	CT2U1-BLW2 - add \$2,592	n/a
Dual Power Center Top - White with Wireless Charging	CT2U1-WHW2 - add \$2,592	n/a

CT4U1	108 wide	120 - 192 wide
Four Power Center Top with Single Underside - Black	n/a	CT4U1-BL - add \$3,169
Four Power Center Top with Single Underside - White	n/a	CT4U1-WH - add \$3,169
Four Power Center Top - Black with Underside & Wireless Charging	n/a	CT4U1-BLW2 - add \$3,928
Four Power Center Top - White with Underside & Wireless Charging	n/a	CT4U1-WHW2 - add \$3,928
CT4		
Four Power Center Top - Black	n/a	CT4BL - add \$2,775
Four Power Center Top - White	n/a	CT4WH - add \$2,775

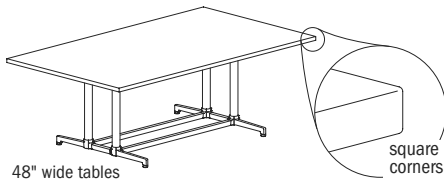
Note: Order power infed that best fits application

To Order Specify

1 Veneer Model #	2 Edge Detail	3 Wood Species	4 Wood Finish	5 Electrical	6 Metal Color
Veneer (LKV)	See Edge Detail Options	Flat Cut CH1 Cherry MA1 Maple WA1 Walnut BO1 Black Oak	See Flat Cut Wood Finish Options	N None CT2 Dual Power Center Top CU2 Dual Power Underside CT2U1 Dual Power Center Top with Underside CT4U2 Four Power Center Top with Underside CT4 Four Power Center Top	See Metal Finish Color Options
		Double Cut DC1 Double Cut	See Double Cut Wood Finish Options		

Description

Rectangular Table with T Base at Working Height

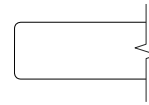


48" wide tables have double column base

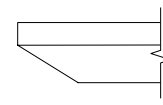
D	W	H	CTN WT	CU FT	❶ Model
48	84	29	204	83	LKT4884-29TTT
42	96	29	183	73	LKT4296-29TTT
42	84	29	164	72	LKT4284-29TTT
36	96	29	162	72	LKT3696-29TTT
36	84	29	151	64	LKT3684-29TTT

LAMINATE

Laminate Tables "LKT" Models



Eased Edge (R3)



Reverse Bevel Edge (K9)

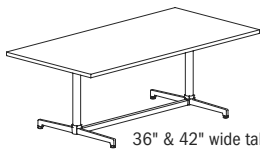
Standard Tier 1	Graded In		Standard Tier 1	Graded In	
	Tier 2	Tier 3		Tier 2	Tier 3
\$3,070	\$3,123	\$3,438	\$3,543	\$3,594	\$3,822
\$2,734	\$2,778	\$3,058	\$3,194	\$3,239	\$3,437
\$2,796	\$2,842	\$3,120	\$3,256	\$3,301	\$3,500
\$2,300	\$2,339	\$2,580	\$2,749	\$2,788	\$2,962
\$2,347	\$2,387	\$2,627	\$2,794	\$2,834	\$3,006
\$2,104	\$2,138	\$2,347	\$2,542	\$2,577	\$2,726

Features:

- price reflects complete table - top and base
- ships KD in multiple cartons
- one piece top
- model includes adjustable glide

Options:

- specify power/charging option, see below for options and upcharges



36" & 42" wide tables have single column base



top shape

LOK - CONFERENCE

To Order Specify

❶ Laminate Model #	❷ Edge Detail	❸ Laminate Selection	❹ PVC Edge Color	❺ Electrical	❻ Metal Color
Laminate (LKT)	See Edge Detail Options	See Laminate Selection	See PVC Edge Color Options	N None CT2 Dual Power Center Top CU2 Dual Power Underside CT2U1 Dual Power Center Top with Underside (See chart on next page)	See Metal Finish Color Options

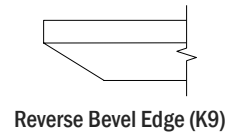
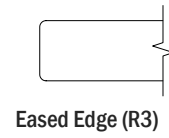
Model Number Breakdown

LKT4896-29TTT					
LK	T	4896	29	TT	T
LOK	Laminate	48" x 96"	Height	Rectangular Top Shape	T base

Description

Rectangular Table with T Base
at Working Height
(continued)

Veneer Tables
"LKV" Models



VENEER	D	W	H	CTN WT	CU FT	1 Model	Eased Edge (R3)		Reverse Bevel Edge (K9)	
							Flat Cut	Double Cut	Flat Cut	Double Cut
	48	96	29	275	105	LKV4896-29TTT	\$4,299	\$4,638	\$4,608	\$4,923
	48	84	29	204	94	LKV4884-29TTT	\$3,908	\$4,201	\$4,198	\$4,467
	42	96	29	183	83	LKV4296-29TTT	\$4,690	\$5,067	\$5,112	\$5,443
	42	84	29	164	73	LKV4284-29TTT	\$3,569	\$3,854	\$3,890	\$4,143
	36	96	29	162	72	LKV3696-29TTT	\$3,174	\$3,426	\$3,459	\$3,682
	36	84	29	145	72	LKV3684-29TTT	\$2,975	\$3,213	\$3,245	\$3,455

Electrical Options and Upcharges

CT2	84 - 96 wide
Dual Power Center Top - Black	CT2BL - add \$1,490
Dual Power Center Top - White	CT2WH - add \$1,490
CU1	
Single Power Underside - Black	CU1-1C - add \$592
Single Power Underside with Wireless Charging - Black	CU1-1CW - add \$1,371
CT2U1	
Dual Power Center Top - Black with Underside	CT2U1-BL - add \$1,813
Dual Power Center Top - White with Underside	CT2U1-WH - add \$1,813
Dual Power Center Top - Black with Wireless Charging	CT2U1-BLW2 - add \$2,592
Dual Power Center Top - White with Wireless Charging	CT2U1-WhW2 - add \$2,592

Note: Order power infeed that best fits application

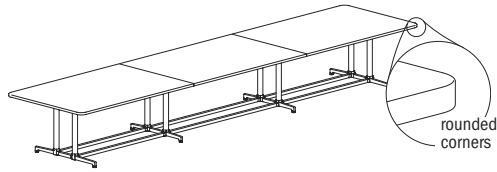
To Order Specify

1 Veneer Model #	2 Edge Detail	3 Wood Species	4 Wood Finish	5 Electrical	6 Metal Color
Veneer (LKV)	See Edge Detail Options	Flat Cut CH1 Cherry MA1 Maple WA1 Walnut BO1 Black Oak	See Flat Cut Wood Finish Options	N None CT2 Dual Power Center Top CU2 Dual Power Underside CT2U1 Dual Power Center Top with Underside (See chart above)	See Metal Finish Color Options
		Double Cut DC1 Double Cut	See Double Cut Wood Finish Options		

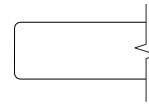
LOK - CONFERENCE

Description

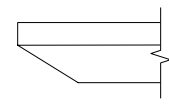
Rounded Rectangular 3pc Table with T Base at Working Height



Laminate Tables
"LKT" Models



Eased Edge (R3)



Reverse Bevel Edge (K9)

LAMINATE	D	W	H	CTN WT	CU FT	Model	Standard			Graded In		
							Tier 1	Tier 2	Tier 3	Tier 1	Tier 2	Tier 3
	60	240	29	653	281	LKT60240-29TTRT	\$9,960	\$10,122	\$11,109	\$10,639	\$10,800	\$11,505
60	216	29	598	253	LKT60216-29TTRT	\$8,490	\$8,633	\$9,526	\$9,139	\$9,284	\$9,918	
54	240	29	603	254	LKT54240-29TTRT	\$8,034	\$8,177	\$9,068	\$8,679	\$8,823	\$9,458	
54	216	29	453	229	LKT54216-29TTRT	\$7,555	\$7,686	\$8,486	\$8,176	\$8,304	\$8,878	
48	240	29	551	228	LKT48240-29TTRT	\$7,653	\$7,782	\$8,576	\$8,265	\$8,392	\$8,958	
48	216	29	553	206	LKT48216-29TTRT	\$6,770	\$6,886	\$7,600	\$7,360	\$7,475	\$7,984	

Features:

- price reflects complete table - top and base
- ships KD in multiple cartons
- three piece top
- model includes adjustable glide

Options:

- specify power/charging option, see below for options and upcharges



top shape

LOK - CONFERENCE

To Order Specify

1 Laminate Model #	2 Edge Detail	3 Laminate Selection	3a PVC Edge Color	4 Electrical	5 Metal Color
Laminate (LKT)	See Edge Detail Options	See Laminate Selection	See PVC Edge Color Options	N None CT6 Six Power Center Top CU2 Dual Power Underside CT6U2 Six Power Center Top with Underside (See chart on next page)	See Metal Finish Color Options

Model Number Breakdown

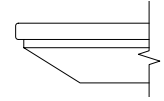
LKT60240-29TTRT						
LK	T	60240	29	TT	R	T
LOK	Laminate	60" x 240"	Height	Rectangular Top Shape	Rounded Corner	T base

Description

Rounded Rectangular 3pc Table with T Base at Working Height (continued)

Veneer Tables "LKV" Models

Solid Surface Tables "LKS" Models



Reverse Bevel Edge (S7)

	D	W	H	CTN WT	CU FT	1 Model	Flat Cut	Double Cut	Flat Cut	Double Cut	Standard
VENEER	60	240	29	653	281	LKV60240-29TTRT	\$15,492	\$16,732	\$16,886	\$17,984	--
	60	216	29	598	253	LKV60216-29TTRT	\$13,636	\$14,727	\$14,863	\$15,830	--
	54	240	29	603	254	LKV54240-29TTRT	\$13,125	\$14,188	\$13,743	\$14,754	--
	54	216	29	453	229	LKV54216-29TTRT	\$12,179	\$13,125	\$12,747	\$13,643	--
	48	240	29	551	228	LKV48240-29TTRT	\$12,313	\$13,251	\$12,876	\$13,762	--
	48	216	29	553	206	LKV48216-29TTRT	\$10,815	\$11,648	\$11,334	\$12,120	--
SOLID SURFACE	60	240	29	653	281	LKS60240-29TTRT	--	--	--	--	\$34,782
	60	216	29	598	253	LKS60216-29TTRT	--	--	--	--	\$31,437
	54	240	29	603	254	LKS54240-29TTRT	--	--	--	--	\$31,650
	54	216	29	453	229	LKS54216-29TTRT	--	--	--	--	\$28,639
	48	240	29	551	228	LKS48240-29TTRT	--	--	--	--	\$28,583
	48	216	29	553	206	LKS48216-29TTRT	--	--	--	--	\$25,273

Electrical Options and Upcharges

CT6	216 - 240 wide
Six Power Center Top - Black	CT6BL - add \$4,016
Six Power Center Top - White	CT6WH - add \$4,016
CU2	
Dual Power Underside - Black	CU2-1C - add \$1,052
Dual Power Underside with 4 Wireless Charging - Black	CU2-1CW - add \$2,660
CT6U2	
Six Power Center Top - Black with Dual Underside	CT6U2-BL - add \$4,665
Six Power Center Top - White with Dual Underside	CT6U2-WH - add \$4,665
Six Power Center Top - Black Dual Underside with 4 Wireless Charging	CT6U2-BLW2 - add \$6,223
Six Power Center Top - White Dual Underside with 4 Wireless Charging	CT6U2-WHW2 - add \$6,223

LOK - CONFERENCE

To Order Specify

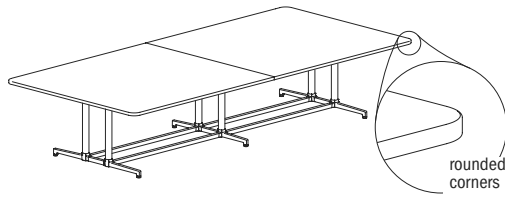
Note: Order power infeed that best fits application, see page 408.

1 Veneer Model #	2 Edge Detail	3 Wood Species	4 Wood Finish	5 Electrical	6 Metal Color
Veneer (LKV)	See Edge Detail Options	Flat Cut CH1 Cherry MA1 Maple WA1 Walnut BO1 Black Oak	See Flat Cut Wood Finish Options	N None CT6 Six Power Center Top CU2 Dual Power Underside CT6U2 Six Power Center Top with Underside (See chart above)	See Metal Finish Color Options
		Double Cut DC1 Double Cut	See Double Cut Wood Finish Options		

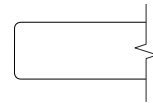
1 Solid Surface Model #	2 Top Surface Selection	3 Electrical	4 Metal Color
Solid Surface (LKS)	See Solid Surface Top Surface Selection Options	N None CT6 Six Power Center Top CU2 Dual Power Underside CT6U2 Six Power Center Top with Underside (See chart above)	See Metal Finish Color Options

Description

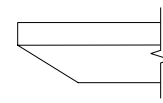
Rounded Rectangular 2pc Table with T Base at Working Height



Laminate Tables "LKT" Models



Eased Edge (R3)



Reverse Bevel Edge (K9)

LAMINATE	D	W	H	CTN WT	CU FT	Model	Standard			Graded In		
							Tier 1	Tier 2	Tier 3	Tier 1	Tier 2	Tier 3
		60	192	29	513	226	LKT60192-29TTRT	\$6,937	\$7,067	\$7,857	\$7,554	\$7,682
	60	168	29	460	198	LKT60168-29TTRT	\$6,474	\$6,586	\$7,280	\$7,061	\$7,173	\$7,667
	60	144	29	405	169	LKT60144-29TTRT	\$5,973	\$6,068	\$6,663	\$6,532	\$6,627	\$7,050
	60	120	29	350	143	LKT60120-29TTRT	\$5,296	\$5,375	\$5,872	\$5,825	\$5,904	\$6,257
	54	192	29	472	204	LKT54192-29TTRT	\$6,601	\$6,718	\$7,431	\$7,192	\$7,307	\$7,815
	54	168	29	389	178	LKT54168-29TTRT	\$5,979	\$6,081	\$6,704	\$6,546	\$6,645	\$7,091
	54	144	29	375	154	LKT54144-29TTRT	\$5,508	\$5,596	\$6,129	\$6,048	\$6,134	\$6,514
	54	120	29	324	130	LKT54120-29TTRT	\$4,934	\$5,006	\$5,453	\$5,444	\$5,517	\$5,835
	48	192	29	432	183	LKT48192-29TTRT	\$5,760	\$5,863	\$6,499	\$6,325	\$6,427	\$6,879
	48	168	29	389	161	LKT48168-29TTRT	\$5,355	\$5,444	\$6,001	\$5,896	\$5,986	\$6,384
	48	144	29	344	139	LKT48144-29TTRT	\$4,912	\$4,989	\$5,468	\$5,431	\$5,508	\$5,849
	48	120	29	298	116	LKT48120-29TTRT	\$4,414	\$4,478	\$4,875	\$4,910	\$4,975	\$5,258
	48	108	29	275	105	LKT48108-29TTRT	\$3,739	\$3,796	\$4,154	\$4,222	\$4,280	\$4,536

Features:

- price reflects complete table - top and base
- ships KD in multiple cartons
- two piece top
- model includes adjustable glide

Options:

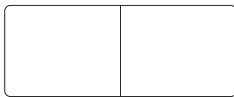
- specify power/charging option, see below for options and upcharges

Electrical Options and Upcharges

	108 wide	120 - 192 wide
CT2		
Dual Power Center Top - Black	CT2BL - add \$1,490	n/a
Dual Power Center Top - White	CT2WH - add \$1,490	n/a
CU1		
Single Power Underside - Black	CU1-1C - add \$592	CU1-1C - add \$688
Single Power Underside with Wireless Charging - Black	CU1-1CW - add \$1,371	CU1-1CW - add \$1,440
CT2U1		
Dual Power Center Top - Black with Underside	CT2U1-BL - add \$1,813	n/a
Dual Power Center Top - White with Underside	CT2U1-WH - add \$1,813	n/a
Dual Power Center Top - Black with Wireless Charging	CT2U1-BLW2 - add \$2,592	n/a
Dual Power Center Top - White with Wireless Charging	CT2U1-WHW2 - add \$2,592	n/a

Note: Order power infeed that best fits application.

	108 wide	120 - 192 wide
CT4U1		
Four Power Center Top with Single Underside - Black	n/a	CT4U1-BL - add \$3,169
Four Power Center Top with Single Underside - White	n/a	CT4U1-WH - add \$3,169
Four Power Center Top - Black with Underside & Wireless Charging	n/a	CT4U1-BLW2 - add \$3,928
Four Power Center Top - White with Underside & Wireless Charging	n/a	CT4U1-WHW2 - add \$3,928
CT4		
Four Power Center Top - Black	n/a	CT4BL - add \$2,775
Four Power Center Top - White	n/a	CT4WH - add \$2,775



top shape

To Order Specify

1 Laminate Model #	2 Edge Detail	3 Laminate Selection	3a PVC Edge Color	4 Electrical	5 Metal Color
Laminate (LKT)	See Edge Detail Options	See Laminate Selection	See PVC Edge Color Options	N None CT2 Dual Power Center Top CU2 Dual Power Underside CT2U1 Dual Power Center Top with Underside CT4U2 Four Power Center Top with Underside CT4 Four Power Center Top (See chart above)	See Metal Finish Color Options

Model Number Breakdown

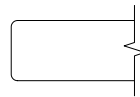
LKT60192-29TTRT						
LK	T	60192	29	TT	R	T
LOK	Laminate	60" x 192"	Height	Rectangular Top Shape	Rounded Corner	T base

Description

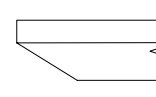
Rounded Rectangular 2pc Table with T Base at Working Height (continued)

Veneer Tables "LKV" Models

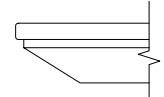
Solid Surface Tables "LKS" Models



Eased Edge (R3)



Reverse Bevel Edge (K9)



Reverse Bevel Edge (S7)

	D	W	H	CTN WT	CU FT	① Model	Veneer		Solid Surface		Standard
							Flat Cut	Double Cut	Flat Cut	Double Cut	
VENEER	60	192	29	513	226	LKV60192-29TTRT	\$10,797	\$11,661	\$11,767	\$12,532	--
	60	168	29	460	198	LKV60168-29TTRT	\$9,931	\$10,725	\$10,824	\$11,528	--
	60	144	29	405	169	LKV60144-29TTRT	\$9,039	\$9,763	\$9,852	\$10,493	--
	60	120	29	350	143	LKV60120-29TTRT	\$7,976	\$8,614	\$8,694	\$9,257	--
	54	192	29	472	204	LKV54192-29TTRT	\$9,875	\$10,667	\$10,766	\$11,463	--
	54	168	29	389	178	LKV54168-29TTRT	\$9,031	\$9,755	\$9,844	\$10,484	--
	54	144	29	375	154	LKV54144-29TTRT	\$8,202	\$8,859	\$8,942	\$9,521	--
	54	120	29	324	130	LKV54120-29TTRT	\$7,259	\$7,839	\$7,911	\$8,423	--
	48	192	29	432	183	LKV48192-29TTRT	\$8,868	\$9,596	\$9,343	\$10,029	--
	48	168	29	389	161	LKV48168-29TTRT	\$8,131	\$8,758	\$8,563	\$9,156	--
	48	144	29	344	139	LKV48144-29TTRT	\$7,363	\$7,893	\$7,756	\$8,254	--
	48	120	29	298	116	LKV48120-29TTRT	\$6,546	\$6,981	\$6,899	\$7,306	--
	48	108	29	275	105	LKV48108-29TTRT	\$5,374	\$5,804	\$5,857	\$6,237	--
	SOLID SURFACE	60	192	29	513	226	LKS60192-29TTRT	--	--	--	--
60		168	29	460	198	LKS60168-29TTRT	--	--	--	--	\$23,083
60		144	29	405	169	LKS60144-29TTRT	--	--	--	--	\$20,080
60		120	29	350	143	LKS60120-29TTRT	--	--	--	--	\$21,962
54		192	29	472	204	LKS54192-29TTRT	--	--	--	--	\$23,651
54		168	29	389	178	LKS54168-29TTRT	--	--	--	--	\$20,997
54		144	29	375	154	LKS54144-29TTRT	--	--	--	--	\$18,297
54		120	29	324	130	LKS54120-29TTRT	--	--	--	--	\$15,543
48		192	29	432	183	LKS48192-29TTRT	--	--	--	--	\$21,386
48		168	29	389	161	LKS48168-29TTRT	--	--	--	--	\$18,959
48		144	29	344	139	LKS48144-29TTRT	--	--	--	--	\$16,552
48		120	29	298	116	LKS48120-29TTRT	--	--	--	--	\$14,151
48		108	29	275	105	LKS48108-29TTRT	--	--	--	--	\$12,927

To Order Specify

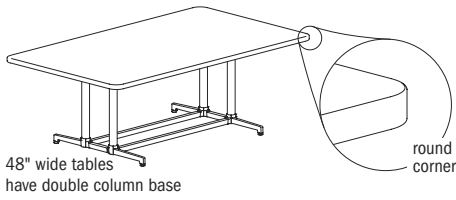
① Veneer Model #	② Edge Detail	③ Wood Species	④ Wood Finish	⑤ Electrical	⑥ Metal Color
Veneer (LKV)	See Edge Detail Options	Flat Cut CH1 Cherry MA1 Maple WA1 Walnut BO1 Black Oak	See Flat Cut Wood Finish Options	N None CT2 Dual Power Center Top CU2 Dual Power Underside CT2U1 Dual Power Center Top with Underside CT4U2 Four Power Center Top with Underside CT4 Four Power Center Top (See chart on previous page)	See Metal Finish Color Options
		Double Cut DC1 Double Cut	④ Wood Finish See Double Cut Wood Finish Options		

① Solid Surface Model #	② Top Surface Selection	③ Electrical	④ Metal Color
Solid Surface (LKS)	See Solid Surface Top Surface Selection Options	N None CT2 Dual Power Center Top CU2 Dual Power Underside CT2U1 Dual Power Center Top with Underside	See Metal Finish Color Options

LOK - CONFERENCE

Description

Rounded Rectangular Table with T Base at Working Height



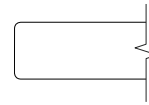
Model

D	W	H	CTN WT	CU FT	Model
48	96	29	204	105	LKT4896-29TTRT
48	84	29	183	83	LKT4884-29TTRT

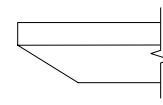
LAMINATE

						Standard Tier 1	Graded In Tier 2 Tier 3		Standard Tier 1	Graded In Tier 2 Tier 3	
42	96	29	164	73	LKT4296-29TTRT	\$2,854	\$2,899	\$3,178	\$3,314	\$3,358	\$3,558
42	84	29	162	72	LKT4284-29TTRT	\$2,351	\$2,391	\$2,636	\$2,803	\$2,842	\$3,016
36	96	29	145	72	LKT3696-29TTRT	\$2,400	\$2,439	\$2,678	\$2,848	\$2,887	\$3,058
36	84	29	151	64	LKT3684-29TTRT	\$2,154	\$2,185	\$2,395	\$2,592	\$2,627	\$2,776

Laminate Tables "LKT" Models



Eased Edge (R3)



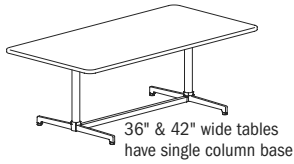
Reverse Bevel Edge (K9)

Features:

- price reflects complete table - top and base
- ships KD in multiple cartons
- one piece top
- model includes adjustable glide

Options:

- specify power/charging option, see below for options and upcharges



top shape

LOK - CONFERENCE

To Order Specify

1 Laminate Model #	2 Edge Detail	3 Laminate Selection	3a PVC Edge Color	4 Electrical	5 Metal Color
Laminate (LKT)	See Edge Detail Options	See Laminate Selection	See PVC Edge Color Options	N None CT2 Dual Power Center Top CU2 Dual Power Underside CT2U1 Dual Power Center Top with Underside (See chart on next page)	See Metal Finish Color Options

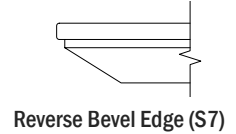
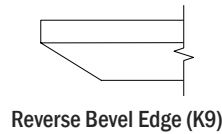
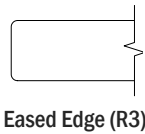
Model Number Breakdown

LKT4896-29TTRT						
LK	T	4896	29	TT	R	T
LOK	Laminate	48" x 96"	Height	Rectangular Top Shape	Rounded Corner	T base

Description

Rounded Rectangular Table with T Base at Working Height (continued)

Veneer Tables "LKV" Models Solid Surface Tables "LKS" Models



	D	W	H	CTN WT	CU FT	① Model	Eased Edge (R3)		Reverse Bevel Edge (K9)		Reverse Bevel Edge (S7)
							Flat Cut	Double Cut	Flat Cut	Double Cut	
VENEER	48	96	29	204	105	LKV4896-29TTRT	\$4,365	\$4,704	\$4,676	\$4,988	--
	48	84	29	204	83	LKV4884-29TTRT	\$3,995	\$4,286	\$4,281	\$4,553	--
	42	96	29	183	83	LKV4296-29TTRT	\$4,266	\$4,608	\$4,649	\$4,951	--
	42	84	29	164	73	LKV4284-29TTRT	\$3,586	\$3,871	\$3,908	\$4,164	--
	36	96	29	162	72	LKV3696-29TTRT	\$3,247	\$3,505	\$3,537	\$3,768	--
	36	84	29	151	64	LKV3684-29TTRT	\$2,987	\$3,224	\$3,255	\$3,466	--
SOLID SURFACE	48	96	29	204	105	LKS4896-29TTRT	--	--	--	--	\$10,244
	48	84	29	183	83	LKS4884-29TTRT	--	--	--	--	\$9,095
	42	96	29	164	73	LKS4296-29TTRT	--	--	--	--	\$8,348
	42	84	29	162	72	LKS4284-29TTRT	--	--	--	--	\$7,358
	36	96	29	145	72	LKS3696-29TTRT	--	--	--	--	\$7,335
	36	84	29	151	64	LKS3684-29TTRT	--	--	--	--	\$6,611

Electrical Options and Upcharges

CT2	84 - 96 wide
Dual Power Center Top - Black	CT2BL - add \$1,490
Dual Power Center Top - White	CT2WH - add \$1,490
CU1	
Single Power Underside - Black	CU1-1C - add \$592
Single Power Underside with Wireless Charging - Black	CU1-1CW - add \$1,371
CT2U1	
Dual Power Center Top - Black with Single Underside	CT2U1-BL - add \$1,813
Dual Power Center Top - White with Single Underside	CT2U1-WH - add \$1,813
Dual Power Center Top - Black with Wireless Charging	CT2U1-BLW2 - add \$2,592
Dual Power Center Top - White with Wireless Charging	CT2U1-WHW2 - add \$2,592

Note: Order power infeed that best fits application

To Order Specify

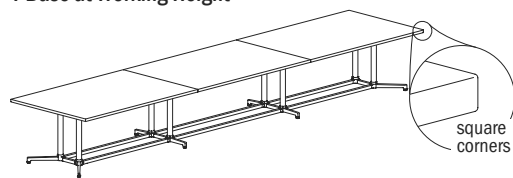
① Veneer Model #	② Edge Detail	③ Wood Species	④ Wood Finish	⑤ Electrical	⑥ Metal Color
Veneer (LKV)	See Edge Detail Options	Flat Cut CH1 Cherry MA1 Maple WA1 Walnut BO1 Black Oak	See Flat Cut Wood Finish Options	N None CT2 Dual Power Center Top CU2 Dual Power Underside CT2U1 Dual Power Center Top with Underside (See chart above)	See Metal Finish Color Options
		Double Cut DC1 Double Cut	④ Wood Finish See Double Cut Wood Finish Options		

① Solid Surface Model #	② Top Surface Selection	③ Electrical	④ Metal Color
Solid Surface (LKS)	See Solid Surface Top Surface Selection Options	N None CT2 Dual Power Center Top CU2 Dual Power Underside CT2U1 Dual Power Center Top with Underside (See chart above)	See Metal Finish Color Options

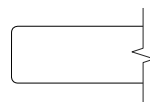
LOK - CONFERENCE

Description

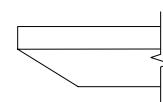
Rectangular Table 3pc with Y Base at Working Height



Laminate Tables "LKT" Models



Eased Edge (R3)



Reverse Bevel Edge (K9)

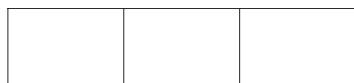
LAMINATE	D	W	H	CTN WT	CU FT	Model	Standard			Graded In		
							Tier 1	Tier 2	Tier 3	Tier 1	Tier 2	Tier 3
		60	240	29	653	281	LKT60240-29TTY	\$9,467	\$9,628	\$10,617	\$10,146	\$10,307
	60	216	29	598	253	LKT60216-29TTY	\$7,875	\$8,018	\$8,909	\$8,522	\$8,667	\$9,303
	54	240	29	584	254	LKT54240-29TTY	\$7,469	\$7,613	\$8,504	\$8,113	\$8,258	\$8,893
	54	216	29	538	229	LKT54216-29TTY	\$6,672	\$6,801	\$7,604	\$7,291	\$7,419	\$7,991
	48	240	29	545	228	LKT48240-29TTY	\$7,227	\$7,356	\$8,148	\$7,838	\$7,966	\$8,531
	48	216	29	492	206	LKT48216-29TTY	\$6,323	\$6,437	\$7,153	\$6,910	\$7,026	\$7,535

Features:

- price reflects complete table - top and base
- ships KD in multiple cartons
- three piece top
- model includes adjustable glide

Options:

- specify power/charging option, see below for options and upcharges



top shape

LOK - CONFERENCE

To Order Specify

1 Laminate Model #	2 Edge Detail	3 Laminate Selection	3a PVC Edge Color	4 Electrical	5 Metal Color
Laminate (LKT)	See Edge Detail Options	See Laminate Selection	See PVC Edge Color Options	N None CT6 Six Power Center Top CU2 Dual Power Underside CT6U2 Six Power Center Top with Underside (See chart on next page)	See Metal Finish Color Options

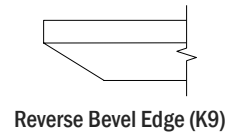
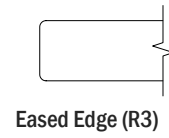
Model Number Breakdown

LKT60240-29TTY					
LK	T	60240	29	TT	Y
LOK	Laminate	60" x 240"	Height	Rectangular Top Shape	Y base

Description

Rectangular Table 3pc with
Y Base at Working Height
(continued)

Veneer Tables
"LKV" Models



VENEER	D	W	H	CTN WT	CU FT	1 Model	Eased Edge (R3)		Reverse Bevel Edge (K9)	
							Flat Cut	Double Cut	Flat Cut	Double Cut
	60	240	29	653	281	LKV60240-29TTY	\$14,753	\$15,933	\$16,081	\$17,126
	60	216	29	598	253	LKV60216-29TTY	\$12,904	\$13,937	\$14,068	\$14,979
	54	240	29	584	254	LKV54240-29TTY	\$12,289	\$13,355	\$12,909	\$13,922
	54	216	29	538	229	LKV54216-29TTY	\$10,896	\$11,840	\$11,464	\$12,361
	48	240	29	545	228	LKV48240-29TTY	\$11,692	\$12,632	\$12,254	\$13,142
	48	216	29	492	206	LKV48216-29TTY	\$10,176	\$11,009	\$10,697	\$11,482

Electrical Options and Upcharges

	216 - 240 wide
CT6	
Six Power Center Top - Black	CT6BL - add \$4,016
Six Power Center Top - White	CT6WH - add \$4,016
CU2	
Dual Power Underside - Black	CU2-1C - add \$1,052
Dual Power Underside with 4 Wireless Charging - Black	CU2-1CW - add \$2,660
CT6U2	
Six Power Center Top - Black with Dual Underside	CT6U2-BL - add \$4,665
Six Power Center Top - White with Dual Underside	CT6U2-WH - add \$4,665
Six Power Center Top - Black Dual Underside with 4 Wireless Charging	CT6U2-BLW2 - add \$6,223
Six Power Center Top - White Dual Underside with 4 Wireless Charging	CT6U2-WHW2 - add \$6,223

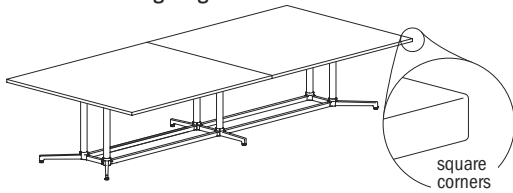
Note: Order power infeed that best fits application

To Order Specify

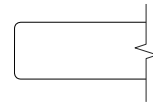
1 Veneer Model #	2 Edge Detail	3 Wood Species	4 Wood Finish	5 Electrical	6 Metal Color
Veneer (LKV)	See Edge Detail Options	Flat Cut CH1 Cherry MA1 Maple WA1 Walnut BO1 Black Oak	See Flat Cut Wood Finish Options	N None CT6 Six Power Center Top CU2 Dual Power Underside CT6U2 Six Power Center Top with Underside (See chart above)	See Metal Finish Color Options
		Double Cut DC1 Double Cut	4 Wood Finish See Double Cut Wood Finish Options		

Description

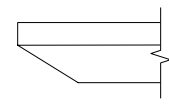
Rectangular 2pc Table with Y Base at Working Height



Laminate Tables
"LKT" Models



Eased Edge (R3)



Reverse Bevel Edge (K9)

LAMINATE	D	W	H	CTN WT	CU FT	Model	Standard			Graded In		
							Tier 1	Tier 2	Tier 3	Tier 1	Tier 2	Tier 3
		60	192	29	513	226	LKT60192-29TTY	\$6,736	\$6,864	\$7,656	\$7,354	\$7,480
	60	168	29	460	198	LKT60168-29TTY	\$6,269	\$6,384	\$7,076	\$6,859	\$6,970	\$7,466
	60	144	29	345	169	LKT60144-29TTY	\$5,725	\$5,821	\$6,416	\$6,285	\$6,379	\$6,802
	60	120	29	342	143	LKT60120-29TTY	\$5,051	\$5,133	\$5,627	\$5,581	\$5,658	\$6,014
	54	192	29	462	204	LKT54192-29TTY	\$6,391	\$6,505	\$7,220	\$6,981	\$7,097	\$7,606
	54	168	29	368	178	LKT54168-29TTY	\$5,690	\$5,792	\$6,415	\$6,254	\$6,355	\$6,800
	54	144	29	365	154	LKT54144-29TTY	\$5,175	\$5,261	\$5,796	\$5,714	\$5,799	\$6,181
	54	120	29	316	130	LKT54120-29TTY	\$4,745	\$4,816	\$5,262	\$5,257	\$5,328	\$5,647
	48	192	29	422	183	LKT48192-29TTY	\$6,222	\$6,326	\$6,960	\$6,786	\$6,888	\$7,342
	48	168	29	375	161	LKT48168-29TTY	\$5,034	\$5,122	\$5,679	\$5,575	\$5,665	\$6,061
	48	144	29	333	139	LKT48144-29TTY	\$4,666	\$4,744	\$5,220	\$5,185	\$5,261	\$5,603
	48	120	29	291	116	LKT48120-29TTY	\$4,219	\$4,282	\$4,682	\$4,714	\$4,779	\$5,064
	48	108	29	269	105	LKT48108-29TTY	\$3,755	\$3,811	\$4,170	\$4,239	\$4,297	\$4,551

Features:

- price reflects complete table - top and base
- ships KD in multiple cartons
- two piece top
- model includes adjustable glide

Options:

- specify power/charging option, see below for options and upcharges



top shape

LOK - CONFERENCE

To Order Specify

1 Laminate Model #	2 Edge Detail	3 Laminate Selection	3a PVC Edge Color	4 Electrical	5 Metal Color
Laminate (LKT)	See Edge Detail Options	See Laminate Selection	See PVC Edge Color Options	N None CT2 Dual Power Center Top CU2 Dual Power Underside CT2U1 Dual Power Center Top with Underside CT4U2 Four Power Center Top with Underside CT4 Four Power Center Top (See chart on next page)	See Metal Finish Color Options

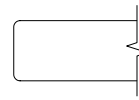
Model Number Breakdown

LKT60192-29TTY					
LK	T	60192	29	TT	Y
LOK	Laminate	60" x 192"	Height	Rectangular Top Shape	Y base

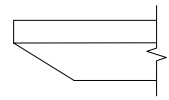
Description

Rectangular 2pc Table with Y Base at Working Height (continued)

Veneer Tables "LKV" Models



Eased Edge (R3)



Reverse Bevel Edge (K9)

D	W	H	CTN WT	CU FT	① Model	Eased Edge (R3)		Reverse Bevel Edge (K9)	
						Flat Cut	Double Cut	Flat Cut	Double Cut
60	192	29	513	226	LKV60192-29TTY	\$10,330	\$11,156	\$11,259	\$11,991
60	168	29	460	198	LKV60168-29TTY	\$9,469	\$10,228	\$10,322	\$10,992
60	144	29	345	169	LKV60144-29TTY	\$8,522	\$9,204	\$9,290	\$9,892
60	120	29	342	143	LKV60120-29TTY	\$7,641	\$8,251	\$8,327	\$8,868
54	192	29	462	204	LKV54192-29TTY	\$9,576	\$10,343	\$10,437	\$11,117
54	168	29	368	178	LKV54168-29TTY	\$8,625	\$9,315	\$9,401	\$10,012
54	144	29	365	154	LKV54144-29TTY	\$7,742	\$8,362	\$8,439	\$8,988
54	120	29	316	130	LKV54120-29TTY	\$7,003	\$7,563	\$7,633	\$8,128
48	192	29	422	183	LKV48192-29TTY	\$9,515	\$10,241	\$9,990	\$10,675
48	168	29	375	161	LKV48168-29TTY	\$7,688	\$8,314	\$8,121	\$8,711
48	144	29	333	139	LKV48144-29TTY	\$7,032	\$7,560	\$7,426	\$7,920
48	120	29	291	116	LKV48120-29TTY	\$6,287	\$6,722	\$6,639	\$7,046
48	108	29	269	105	LKV48108-29TTY	\$5,395	\$5,827	\$5,882	\$6,263

Electrical Options and Upcharges

	120 - 192 wide
CT4	
Four Power Center Top - Black	CT4BL - add \$3,169
Four Power Center Top - White	CT4WH - add \$3,169
CU1	
Single Power Underside - Black	CU1-1C - add \$688
Single Power Underside with Wireless Charging - Black	CU1-1CW - add \$1,440
CT4U1	
Four Power Center Top with Underside - Black	CT4U1-BL - add \$3,169
Four Power Center Top with Underside - White	CT4U1-WH - add \$3,169
Four Power Center Top - Black with Underside & 2 Wireless Charging	CT4U1-BLW2 - add \$3,928
Four Power Center Top - White with Underside & 2 Wireless Charging	CT4U1-WHW2 - add \$3,928

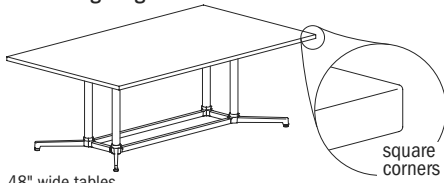
Note: Order power infed that best fits application, see page 408.

To Order Specify

① Veneer Model #	② Edge Detail	③ Wood Species	④ Wood Finish	⑤ Electrical	⑥ Metal Color
Veneer (LKV)	See Edge Detail Options	Flat Cut CH1 Cherry MA1 Maple WA1 Walnut BO1 Black Oak	See Flat Cut Wood Finish Options	N None CT2 Dual Power Center Top CU2 Dual Power Underside CT2U1 Dual Power Center Top with Underside CT4U2 Four Power Center Top with Underside CT4 Four Power Center Top	See Metal Finish Color Options
		Double Cut DC1 Double Cut	④ Wood Finish See Double Cut Wood Finish Options		

Description

Rectangular Table with Y Base at Working Height

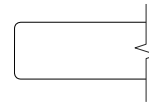


48" wide tables have double column base

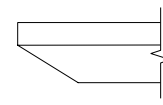
D	W	H	CTN WT	CU FT	Model
48	96	29	225	105	LKT4896-29TTY
48	84	29	333	83	LKT4884-29TTY
42	96	29	174	83	LKT4296-29TTY
42	84	29	174	72	LKT4284-29TTY
36	96	29	152	72	LKT3696-29TTY
36	84	29	156	64	LKT3684-29TTY

LAMINATE

Laminate Tables "LKT" Models



Eased Edge (R3)



Reverse Bevel Edge (K9)

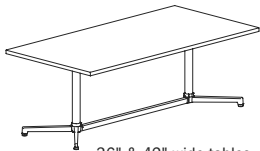
Standard		Graded In		Standard		Graded In	
Tier 1	Tier 2	Tier 3	Tier 3	Tier 1	Tier 2	Tier 3	Tier 3
\$3,099	\$3,150	\$3,469	\$3,469	\$3,572	\$3,625	\$3,851	\$3,851
\$2,717	\$2,761	\$3,041	\$3,041	\$3,180	\$3,223	\$3,422	\$3,422
\$2,954	\$2,998	\$3,277	\$3,277	\$3,414	\$3,459	\$3,657	\$3,657
\$2,470	\$2,508	\$2,753	\$2,753	\$2,921	\$2,959	\$3,134	\$3,134
\$2,357	\$2,398	\$2,637	\$2,637	\$2,806	\$2,845	\$3,016	\$3,016
\$2,155	\$2,189	\$2,398	\$2,398	\$2,594	\$2,628	\$2,778	\$2,778

Features:

- price reflects complete table - top and base
- ships KD in multiple cartons
- one piece top
- model includes adjustable glide

Options:

- specify power/charging option, see below for options and upcharges



36" & 42" wide tables have single column base



top shape

LOK - CONFERENCE

To Order Specify

1 Laminate Model #	2 Edge Detail	3 Laminate Selection	3a PVC Edge Color	4 Electrical	5 Metal Color
Laminate (LKT)	See Edge Detail Options	See Laminate Selection	See PVC Edge Color Options	N None CT2 Dual Power Center Top CU2 Dual Power Underside CT2U1 Dual Power Center Top with Underside (See chart on next page)	See Metal Finish Color Options

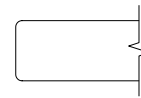
Model Number Breakdown

LKT4896-29TTY					
LK	T	4896	29	TT	Y
LOK	Laminate	48" x 96"	Height	Rectangular Top Shape	Y base

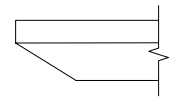
Description

Rectangular Table with Y Base
at Working Height
(continued)

Veneer Tables
"LKV" Models



Eased Edge (R3)



Reverse Bevel Edge (K9)

D	W	H	CTN WT	CU FT	① Model	Eased Edge (R3)		Reverse Bevel Edge (K9)	
						Flat Cut	Double Cut	Flat Cut	Double Cut
48	96	29	225	105	LKV4896-29TTY	\$4,324	\$4,661	\$4,633	\$4,946
48	84	29	333	83	LKV4884-29TTY	\$3,901	\$4,193	\$4,190	\$4,461
42	96	29	174	83	LKV4296-29TTY	\$4,392	\$4,744	\$4,786	\$5,098
						\$3,731	\$4,029	\$4,066	\$4,329
36	96	29	152	72	LKV3696-29TTY	\$3,194	\$3,450	\$3,482	\$3,707
36	84	29	156	64	LKV3684-29TTY	\$2,988	\$3,226	\$3,257	\$3,468

VENEER

Electrical Options and Upcharges

CT2	84 - 96 wide
Dual Power Center Top - Black	CT2BL - add \$1,490
Dual Power Center Top - White	CT2WH - add \$1,490
CU1	
Single Power Underside - Black	CU1-1C - add \$592
Single Power Underside with Wireless Charging - Black	CU1-1CW - add \$1,371
CT2U1	
Dual Power Center Top - Black with Single Underside	CT2U1-BL - add \$1,813
Dual Power Center Top - White with Single Underside	CT2U1-WH - add \$1,813
Dual Power Center Top - Black with Wireless Charging	CT2U1-BLW2 - add \$2,592
Dual Power Center Top - White with Wireless Charging	CT2U1-WHW2 - add \$2,592

Note: Order power infeed that best fits application

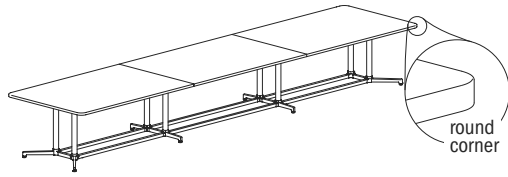
To Order Specify

① Veneer Model #	② Edge Detail	③ Wood Species	④ Wood Finish	⑤ Electrical	⑥ Metal Color
Veneer (LKV)	See Edge Detail Options	Flat Cut CH1 Cherry MA1 Maple WA1 Walnut BO1 Black Oak	See Flat Cut Wood Finish Options	N None CT2 Dual Power Center Top CU2 Dual Power Underside CT2U1 Dual Power Center Top with Underside (See chart above)	See Metal Finish Color Options
		Double Cut DC1 Double Cut	See Double Cut Wood Finish Options		

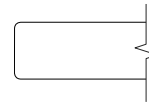
LOK - CONFERENCE

Description

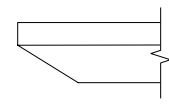
Rounded Rectangular 3pc Table with Y Base at Working Height



Laminate Tables
"LKT" Models



Eased Edge (R3)



Reverse Bevel Edge (K9)

LAMINATE	D	W	H	CTN WT	CU FT	Model	Standard			Graded In		
							Tier 1	Tier 2	Tier 3	Tier 1	Tier 2	Tier 3
	60	240	29	653	281	LKT60240-29TTRY	\$9,650	\$9,807	\$10,798	\$10,327	\$10,486	\$11,192
60	216	29	598	253	LKT60216-29TTRY	\$8,159	\$8,304	\$9,194	\$8,808	\$8,953	\$9,589	
54	240	29	584	254	LKT54240-29TTRY	\$7,634	\$7,777	\$8,670	\$8,278	\$8,422	\$9,058	
54	216	29	538	229	LKT54216-29TTRY	\$6,824	\$6,954	\$7,755	\$7,442	\$7,572	\$8,145	
48	240	29	545	228	LKT48240-29TTRY	\$7,376	\$7,506	\$8,298	\$7,987	\$8,115	\$8,683	
48	216	29	492	206	LKT48216-29TTRY	\$6,836	\$6,952	\$7,666	\$7,428	\$7,541	\$8,051	

Features:

- price reflects complete table - top and base
- ships KD in multiple cartons
- three piece top
- model includes adjustable glide

Options:

- specify power/charging option, see below for options and upcharges



top shape

LOK - CONFERENCE

To Order Specify

1 Laminate Model #	2 Edge Detail	3 Laminate Selection	3a PVC Edge Color	4 Electrical	5 Metal Color
Laminate (LKT)	See Edge Detail Options	See Laminate Selection	See PVC Edge Color Options	N None CT6 Six Power Center Top CU2 Dual Power Underside CT6U2 Six Power Center Top with Underside (See chart on next page)	See Metal Finish Color Options

Model Number Breakdown

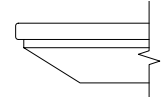
LKT60240-29TTRY						
LK	T	60240	29	TT	R	Y
LOK	Laminate	60" x 240"	Height	Rectangular Top Shape	Rounded Corner	Y base

Description

Rounded Rectangular 3pc Table with Y Base at Working Height (continued)

Veneer Tables "LKV" Models

Solid Surface Tables "LKS" Models



Reverse Bevel Edge (S7)

	D	W	H	CTN WT	CU FT	1 Model	Flat Cut	Double Cut	Flat Cut	Double Cut	Standard
VENEER	60	240	29	653	281	LKV60240-29TTRY	\$15,024	\$16,225	\$16,376	\$17,439	--
	60	216	29	598	253	LKV60216-29TTRY	\$13,148	\$14,200	\$14,330	\$15,263	--
	54	240	29	584	254	LKV54240-29TTRY	\$12,533	\$13,600	\$13,152	\$14,164	--
	54	216	29	538	229	LKV54216-29TTRY	\$11,117	\$12,061	\$11,687	\$12,582	--
	48	240	29	545	228	LKV48240-29TTRY	\$11,911	\$12,849	\$12,471	\$13,360	--
	48	216	29	492	206	LKV48216-29TTRY	\$10,912	\$11,742	\$11,429	\$12,214	--
SOLID SURFACE	60	240	29	653	281	LKS60240-29TTRY	--	--	--	--	\$34,314
	60	216	29	598	253	LKS60216-29TTRY	--	--	--	--	\$30,951
	54	240	29	584	254	LKS54240-29TTRY	--	--	--	--	\$31,064
	54	216	29	538	229	LKS54216-29TTRY	--	--	--	--	\$27,577
	48	240	29	545	228	LKS48240-29TTRY	--	--	--	--	\$28,182
	48	216	29	492	206	LKS48216-29TTRY	--	--	--	--	\$25,368

Electrical Options and Upcharges

	216 - 240 wide
CT6	
Six Power Center Top - Black	CT6BL - add \$4,016
Six Power Center Top - White	CT6WH - add \$4,016
CU2	
Dual Power Underside - Black	CU2-1C - add \$1,052
Dual Power Underside with 4 Wireless Charging - Black	CU2-1CW - add \$2,660
CT6U2	
Six Power Center Top - Black with Dual Underside	CT6U2-BL - add \$4,665
Six Power Center Top - White with Dual Underside	CT6U2-WH - add \$4,665
Six Power Center Top - Black with Dual Underside with 4 Wireless Charging	CT6U2-BLW2 - add \$6,223
Six Power Center Top - White with Dual Underside with 4 Wireless Charging	CT6U2-WHW2 - add \$6,223

LOK - CONFERENCE

Note: Order power infeed that best fits application

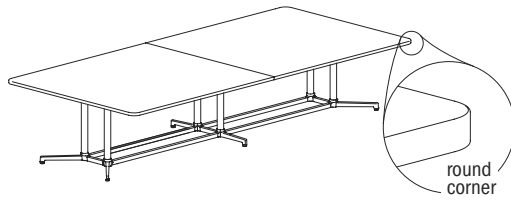
To Order Specify

1 Veneer Model #	2 Edge Detail	3 Wood Species	4 Wood Finish	5 Electrical	6 Metal Color
Veneer (LKV)	See Edge Detail Options	Flat Cut CH1 Cherry MA1 Maple WA1 Walnut BO1 Black Oak	See Flat Cut Wood Finish Options	N None CT6 Six Power Center Top CU2 Dual Power Underside CT6U2 Six Power Center Top with Underside (See chart above)	See Metal Finish Color Options
		Double Cut DC1 Double Cut	See Double Cut Wood Finish Options		

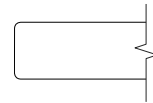
1 Solid Surface Model #	2 Top Surface Selection	3 Electrical	4 Metal Color
Solid Surface (LKS)	See Solid Surface Top Surface Selection Options	N None CT6 Six Power Center Top CU2 Dual Power Underside CT6U2 Six Power Center Top with Underside (See chart above)	See Metal Finish Color Options

Description

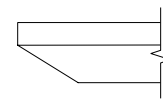
Rounded Rectangular 2pc Table with Y Base at Working Height



Laminate Tables "LKT" Models



Eased Edge (R3)



Reverse Bevel Edge (K9)

LAMINATE	D	W	H	CTN WT	CU FT	Model	Standard			Graded In		
							Tier 1	Tier 2	Tier 3	Tier 1	Tier 2	Tier 3
							60	192	29	513	226	LKT60192-29TTRY
60	168	29	460	198	LKT60168-29TTRY	\$6,268	\$6,381	\$7,075	\$6,857	\$6,969	\$7,465	
60	144	29	345	169	LKT60144-29TTRY	\$5,711	\$5,806	\$6,401	\$6,267	\$6,364	\$6,788	
60	120	29	342	143	LKT60120-29TTRY	\$5,144	\$5,223	\$5,720	\$5,673	\$5,753	\$6,106	
54	192	29	462	204	LKT54192-29TTRY	\$6,512	\$6,627	\$7,342	\$7,104	\$7,218	\$7,728	
54	168	29	368	178	LKT54168-29TTRY	\$5,799	\$5,900	\$6,525	\$6,364	\$6,465	\$6,910	
54	144	29	365	154	LKT54144-29TTRY	\$5,272	\$5,358	\$5,893	\$5,812	\$5,896	\$6,280	
54	120	29	316	130	LKT54120-29TTRY	\$4,831	\$4,902	\$5,349	\$5,343	\$5,415	\$5,732	
48	192	29	422	183	LKT48192-29TTRY	\$6,333	\$6,436	\$7,071	\$6,897	\$6,999	\$7,451	
48	168	29	375	161	LKT48168-29TTRY	\$5,135	\$5,223	\$5,780	\$5,676	\$5,764	\$6,162	
48	144	29	333	139	LKT48144-29TTRY	\$4,756	\$4,833	\$5,310	\$5,276	\$5,353	\$5,691	
48	120	29	291	116	LKT48120-29TTRY	\$4,298	\$4,363	\$4,762	\$4,795	\$4,858	\$5,143	
48	108	29	269	105	LKT48108-29TTRY	\$3,829	\$3,887	\$4,243	\$4,314	\$4,370	\$4,627	

Features:

- price reflects complete table - top and base
- ships KD in multiple cartons
- two piece top
- model includes adjustable glide

Options:

- specify power/charging option, see below for options and upcharges



top shape

Electrical Options and Upcharges

	108 wide	120 - 192 wide
CT2		
Dual Power Center Top - Black	CT2BL - add \$1,490	n/a
Dual Power Center Top - White	CT2WH - add \$1,490	n/a
CU1		
Single Power Underside - Black	CU1-1C - add \$592	CU1-1C - add \$688
Single Power Underside with Wireless Charging - Black	CU1-1CW - add \$1,371	CU1-1CW - add \$1,440
CT2U1		
Dual Power Center Top - Black with Underside	CT2U1-BL - add \$1,813	n/a
Dual Power Center Top - White with Underside	CT2U1-WH - add \$1,813	n/a
Dual Power Center Top - Black with Wireless Charging	CT2U1-BLW2 - add \$2,592	n/a
Dual Power Center Top - White with Wireless Charging	CT2U1-WHW2 - add \$2,592	n/a

Note: Order power infeed that best fits application.

	108 wide	120 - 192 wide
CT4U1		
Four Power Center Top with Single Underside - Black	n/a	CT4U1-BL - add \$3,169
Four Power Center Top with Single Underside - White	n/a	CT4U1-WH - add \$3,169
Four Power Center Top - Black with Underside & Wireless Charging	n/a	CT4U1-BLW2 - add \$3,928
Four Power Center Top - White with Underside & Wireless Charging	n/a	CT4U1-WHW2 - add \$3,928
CT4		
Four Power Center Top - Black	n/a	CT4BL - add \$2,775
Four Power Center Top - White	n/a	CT4WH - add \$2,775

To Order Specify

1 Laminate Model #	2 Edge Detail	3 Laminate Selection	3a PVC Edge Color	4 Electrical	5 Metal Color
Laminate (LKT)	See Edge Detail Options	See Laminate Selection	See PVC Edge Color Options	N None CT2 Dual Power Center Top CU2 Dual Power Underside CT2U1 Dual Power Center Top with Underside CT4U2 Four Power Center Top with Underside CT4 Four Power Center Top (See chart above)	See Metal Finish Color Options

Model Number Breakdown

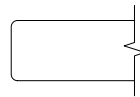
LKT60192-29TTRY						
LK	T	60192	29	TT	R	Y
LOK	Laminate	60" x 192"	Height	Rectangular Top Shape	Rounded Corner	Y base

Description

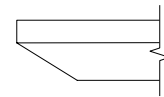
Rounded Rectangular 2pc Table with Y Base at Working Height (continued)

Veneer Tables "LKV" Models

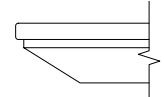
Solid Surface Tables "LKS" Models



Eased Edge (R3)



Reverse Bevel Edge (K9)



Reverse Bevel Edge (S7)

	D	W	H	CTN WT	CU FT	① Model	Veneer		Solid Surface		Standard
							Flat Cut	Double Cut	Flat Cut	Double Cut	
VENEER	60	192	29	513	226	LKV60192-29TTRY	\$10,521	\$11,363	\$11,468	\$12,213	--
	60	168	29	460	198	LKV60168-29TTRY	\$9,639	\$10,410	\$10,508	\$11,190	--
	60	144	29	345	169	LKV60144-29TTRY	\$8,671	\$9,364	\$9,451	\$10,064	--
	60	120	29	342	143	LKV60120-29TTRY	\$7,767	\$8,387	\$8,464	\$9,015	--
	54	192	29	462	204	LKV54192-29TTRY	\$9,748	\$10,529	\$10,626	\$11,315	--
	54	168	29	368	178	LKV54168-29TTRY	\$8,779	\$9,482	\$9,568	\$10,191	--
	54	144	29	365	154	LKV54144-29TTRY	\$7,877	\$8,507	\$8,586	\$9,145	--
	54	120	29	316	130	LKV54120-29TTRY	\$7,120	\$7,688	\$7,762	\$8,263	--
	48	192	29	422	183	LKV48192-29TTRY	\$9,669	\$10,397	\$10,145	\$10,833	--
	48	168	29	389	161	LKV48168-29TTRY	\$7,827	\$8,453	\$8,260	\$8,849	--
	48	144	29	333	139	LKV48144-29TTRY	\$7,153	\$7,682	\$7,544	\$8,044	--
	48	120	29	291	116	LKV48120-29TTRY	\$6,391	\$6,827	\$6,745	\$7,154	--
	48	108	29	269	105	LKV48108-29TTRY	\$5,492	\$5,931	\$5,986	\$6,375	--
	SOLID SURFACE	60	192	29	513	226	LKS60192-29TTRY	--	--	--	--
60		168	29	460	198	LKS60168-29TTRY	--	--	--	--	\$22,789
60		144	29	345	169	LKS60144-29TTRY	--	--	--	--	\$19,712
60		120	29	342	143	LKS60120-29TTRY	--	--	--	--	\$21,751
54		192	29	462	204	LKS54192-29TTRY	--	--	--	--	\$23,523
54		168	29	368	178	LKS54168-29TTRY	--	--	--	--	\$20,743
54		144	29	365	154	LKS54144-29TTRY	--	--	--	--	\$17,973
54		120	29	316	130	LKS54120-29TTRY	--	--	--	--	\$15,403
48		192	29	422	183	LKS48192-29TTRY	--	--	--	--	\$22,187
48		168	29	375	161	LKS48168-29TTRY	--	--	--	--	\$18,653
48		144	29	333	139	LKS48144-29TTRY	--	--	--	--	\$16,341
48		120	29	291	116	LKS48120-29TTRY	--	--	--	--	\$13,998
48		108	29	269	105	LKS48108-29TTRY	--	--	--	--	\$13,044

To Order Specify

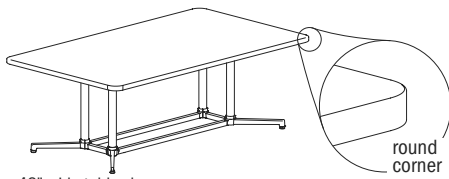
① Veneer Model #	② Edge Detail	③ Wood Species	④ Wood Finish	⑤ Electrical	⑥ Metal Color
Veneer (LKV)	See Edge Detail Options	Flat Cut CH1 Cherry MA1 Maple WA1 Walnut BO1 Black Oak Double Cut DC1 Double Cut	See Flat Cut Wood Finish Options ④ Wood Finish See Double Cut Wood Finish Options	N None CT2 Dual Power Center Top CU2 Dual Power Underside CT2U1 Dual Power Center Top with Underside CT4U2 Four Power Center Top with Underside CT4 Four Power Center Top (See chart on previous page)	See Metal Finish Color Options

① Solid Surface Model #	② Top Surface Selection	③ Electrical	④ Metal Color
Solid Surface (LKS)	See Solid Surface Top Surface Selection Options	N None CT2 Dual Power Center Top CU2 Dual Power Underside CT2U1 Dual Power Center Top with Underside CT4U2 Four Power Center Top with Underside CT4 Four Power Center Top (See chart on previous page)	See Metal Finish Color Options

LOK - CONFERENCE

Description

Rounded Rectangular Table with Y Base at Working Height

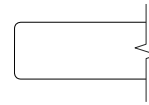


48" wide tables have double column base

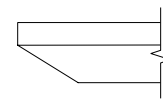
D	W	H	CTN WT	CU FT	Model
48	96	29	225	105	LKT4896-29TTRY
48	84	29	333	83	LKT4884-29TTRY
42	96	29	174	83	LKT4296-29TTRY
42	84	29	174	72	LKT4284-29TTRY
36	96	29	152	72	LKT3696-29TTRY
36	84	29	156	64	LKT3684-29TTRY

LAMINATE

Laminate Tables "LKT" Models



Eased Edge (R3)



Reverse Bevel Edge (K9)

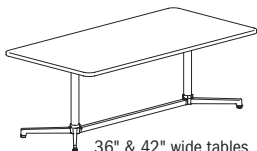
Standard		Graded In		Standard		Graded In	
Tier 1	Tier 2	Tier 3		Tier 1	Tier 2	Tier 3	
\$3,163	\$3,213	\$3,532		\$3,634	\$3,685	\$3,914	
\$2,775	\$2,820	\$3,098		\$3,235	\$3,283	\$3,481	
\$3,011	\$3,057	\$3,334		\$3,470	\$3,518	\$3,716	
\$2,523	\$2,562	\$2,806		\$2,973	\$3,014	\$3,186	
\$2,412	\$2,450	\$2,689		\$2,859	\$2,897	\$3,068	
\$2,204	\$2,239	\$2,448		\$2,644	\$2,677	\$2,826	

Features:

- price reflects complete table - top and base
- ships KD in multiple cartons
- one piece top
- model includes adjustable glide

Options:

- specify power/charging option, see below for options and upcharges



36" & 42" wide tables have single column base



top shape

LOK - CONFERENCE

To Order Specify

1 Laminate Model #	2 Edge Detail	3 Laminate Selection	3a PVC Edge Color	4 Electrical	5 Metal Color
Laminate (LKT)	See Edge Detail Options	See Laminate Selection	See PVC Edge Color Options	N None CT2 Dual Power Center Top CU2 Dual Power Underside CT2U1 Dual Power Center Top with Underside (See chart on next page)	See Metal Finish Color Options

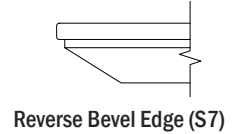
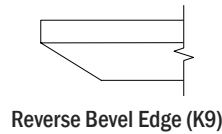
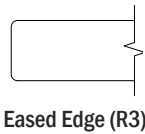
Model Number Breakdown

LKT4896-29TTRY						
LK	T	4896	29	TT	R	Y
LOK	Laminate	48" x 96"	Height	Rectangular Top Shape	Rounded Corner	Y base

Description

Rounded Rectangular Table with Y Base at Working Height (continued)

Veneer Tables "LKV" Models Solid Surface Tables "LKS" Models



	D	W	H	CTN WT	CU FT	① Model	Veneer Tables "LKV" Models		Solid Surface Tables "LKS" Models		
							Flat Cut	Double Cut	Flat Cut	Double Cut	Standard
VENEER	48	96	29	225	105	LKV4896-29TTRY	\$4,403	\$4,741	\$4,711	\$5,028	--
	48	84	29	333	83	LKV4884-29TTRY	\$3,972	\$4,264	\$4,261	\$4,533	--
	42	96	29	174	83	LKV4296-29TTRY	\$4,464	\$4,820	\$4,865	\$5,182	--
	42	84	29	174	72	LKV4284-29TTRY	\$3,796	\$4,100	\$4,137	\$4,406	--
	36	96	29	152	72	LKV3696-29TTRY	\$3,260	\$3,521	\$3,554	\$3,784	--
	36	84	29	156	64	LKV3684-29TTRY	\$3,049	\$3,293	\$3,323	\$3,537	--
SOLID SURFACE	48	96	29	225	105	LKS4896-29TTRY	--	--	--	--	\$10,283
	48	84	29	333	83	LKS4884-29TTRY	--	--	--	--	\$9,077
	42	96	29	174	83	LKS4296-29TTRY	--	--	--	--	\$8,544
	42	84	29	174	72	LKS4284-29TTRY	--	--	--	--	\$7,566
	36	96	29	152	72	LKS3696-29TTRY	--	--	--	--	\$7,347
	36	84	29	156	64	LKS3684-29TTRY	--	--	--	--	\$6,674

Electrical Options and Upcharges

CT2	84 - 96 wide
Dual Power Center Top - Black	CT2BL - add \$1,490
Dual Power Center Top - White	CT2WH - add \$1,490
CU1	
Single Power Underside - Black	CU1-1C - add \$592
Single Power Underside with Wireless Charging - Black	CU1-1CW - add \$1,371
CT2U1	
Dual Power Center Top - Black with Single Underside	CT2U1-BL - add \$1,813
Dual Power Center Top - White with Single Underside	CT2U1-WH - add \$1,813
Dual Power Center Top - Black with Wireless Charging	CT2U1-BLW2 - add \$2,592
Dual Power Center Top - White with Wireless Charging	CT2U1-WHW2 - add \$2,592

Note: Order power infeed that best fits application

To Order Specify

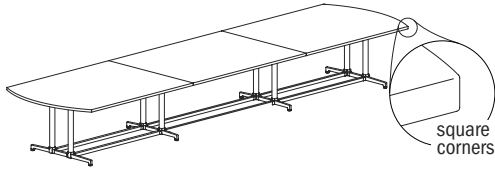
① Veneer Model #	② Edge Detail	③ Wood Species	④ Wood Finish	⑤ Electrical	⑥ Metal Color
Veneer (LKV)	See Edge Detail Options	Flat Cut CH1 Cherry MA1 Maple WA1 Walnut BO1 Black Oak	See Flat Cut Wood Finish Options	N None CT2 Dual Power Center Top CU2 Dual Power Underside CT2U1 Dual Power Center Top with Underside (See chart above)	See Metal Finish Color Options
		Double Cut DC1 Double Cut	④ Wood Finish See Double Cut Wood Finish Options		

① Solid Surface Model #	② Top Surface Selection	③ Electrical	④ Metal Color
Solid Surface (LKS)	See Solid Surface Top Surface Selection Options	N None CT2 Dual Power Center Top CU2 Dual Power Underside CT2U1 Dual Power Center Top with Underside (See chart above)	See Metal Finish Color Options

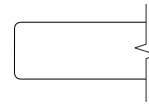
LOK - CONFERENCE

Description

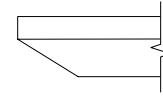
Arc Rectangular 3pc Table with T Base at Working Height



Laminate Tables
"LKT" Models



Eased Edge (R3)



Reverse Bevel Edge (K9)

LAMINATE	D	W	H	CTN WT	CU FT	Model	Standard			Graded In		
							Tier 1	Tier 2	Tier 3	Tier 1	Tier 2	Tier 3
	60	240	29	648	281	LKT60240-29ART	\$9,960	\$10,122	\$11,109	\$10,639	\$10,800	\$11,505
60	216	29	593	253	LKT60216-29ART	\$8,490	\$8,633	\$9,526	\$9,139	\$9,284	\$9,918	
54	240	29	598	254	LKT54240-29ART	\$8,034	\$8,177	\$9,068	\$8,679	\$8,823	\$9,458	
54	216	29	549	229	LKT54216-29ART	\$7,613	\$7,742	\$8,546	\$8,233	\$8,362	\$8,933	
48	240	29	548	228	LKT48240-29ART	\$7,653	\$7,782	\$8,576	\$8,265	\$8,392	\$8,958	
48	216	29	549	206	LKT48216-29ART	\$6,770	\$6,886	\$7,600	\$7,360	\$7,475	\$7,984	

Features:

- price reflects complete table - top and base
- ships KD in multiple cartons
- three piece top
- model includes adjustable glide

Options:

- specify power/charging option, see below for options and upcharges



top shape

LOK - CONFERENCE

To Order Specify

1 Laminate Model #	2 Edge Detail	3 Laminate Selection	4 PVC Edge Color	5 Electrical	6 Metal Color
Laminate (LKT)	See Edge Detail Options	See Laminate Selection	See PVC Edge Color Options	N None CT6 Six Power Center Top CU2 Dual Power Underside CT6U2 Six Power Center Top with Underside (See chart on next page)	See Metal Finish Color Options

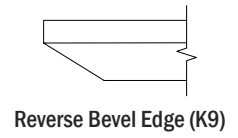
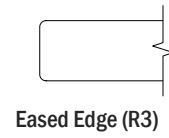
Model Number Breakdown

LKT60240-29ART					
LK	T	60240	29	TT	T
LOK	Laminate	60" x 240"	Height	Rectangular Top Shape	T base

Description

Arc Rectangular 3pc Table with T Base at Working Height (continued)

Veneer Tables "LKV" Models



VENEER	D	W	H	CTN WT	CU FT	1 Model	Eased Edge (R3)		Reverse Bevel Edge (K9)	
							Flat Cut	Double Cut	Flat Cut	Double Cut
	60	240	29	648	281	LKV60240-29ART	\$15,492	\$16,732	\$16,886	\$17,984
	60	216	29	593	253	LKV60216-29ART	\$13,636	\$14,727	\$14,863	\$15,830
	54	240	29	598	254	LKV54240-29ART	\$13,125	\$14,188	\$13,743	\$14,754
	54	216	29	549	229	LKV54216-29ART	\$12,263	\$13,206	\$12,830	\$13,727
	48	240	29	548	228	LKV48240-29ART	\$12,313	\$13,251	\$12,876	\$13,762
	48	216	29	549	206	LKV48216-29ART	\$10,815	\$11,648	\$11,334	\$12,120

Electrical Options and Upcharges

	216 - 240 wide
CT6	
Six Power Center Top - Black	CT6BL - add \$4,016
Six Power Center Top - White	CT6WH - add \$4,016
CU2	
Dual Power Underside - Black	CU2-1C - add \$1,052
Dual Power Underside with 4 Wireless Charging - Black	CU2-1CW - add \$2,660
CT6U2	
Six Power Center Top - Black with Dual Underside	CT6U2-BL - add \$4,665
Six Power Center Top - White with Dual Underside	CT6U2-WH - add \$4,665
Six Power Center Top - Black Dual Underside with 4 Wireless Charging	CT6U2-BLW2 - add \$6,223
Six Power Center Top - White Dual Underside with 4 Wireless Charging	CT6U2-WHW2 - add \$6,223

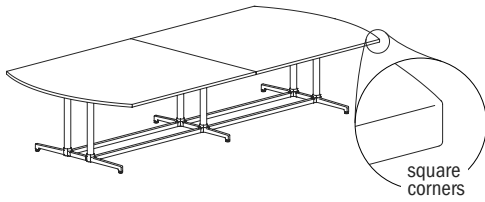
Note: Order power infeed that best fits application

To Order Specify

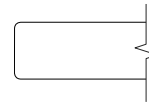
1 Veneer Model #	2 Edge Detail	3 Wood Species	4 Wood Finish	5 Electrical	6 Metal Color
Veneer (LKV)	See Edge Detail Options	Flat Cut CH1 Cherry MA1 Maple WA1 Walnut BO1 Black Oak	See Flat Cut Wood Finish Options	N None CT6 Six Power Center Top CU2 Dual Power Underside CT6U2 Six Power Center Top with Underside (See chart above)	See Metal Finish Color Options
		Double Cut DC1 Double Cut	4 Wood Finish See Double Cut Wood Finish Options		

Description

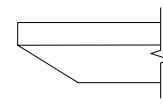
Arc Rectangular 2pc Table with T Base at Working Height



Laminate Tables "LKT" Models



Eased Edge (R3)



Reverse Bevel Edge (K9)

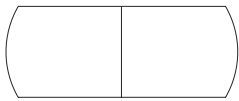
LAMINATE	D	W	H	CTN WT	CU FT	1 Model	Standard			Graded In		
							Tier 1	Tier 2	Tier 3	Tier 1	Tier 2	Tier 3
	60	192	29	507	226	LKT60192-29ART	\$6,937	\$7,067	\$7,857	\$7,554	\$7,682	\$8,248
60	168	29	453	198	LKT60168-29ART	\$6,474	\$6,586	\$7,280	\$7,061	\$7,173	\$7,667	
60	144	29	396	169	LKT60144-29ART	\$5,973	\$6,068	\$6,663	\$6,532	\$6,627	\$7,050	
60	120	29	339	143	LKT60120-29ART	\$5,296	\$5,375	\$5,872	\$5,825	\$5,904	\$6,257	
54	192	29	467	204	LKT54192-29ART	\$6,601	\$6,718	\$7,431	\$7,192	\$7,307	\$7,815	
54	168	29	389	178	LKT54168-29ART	\$5,979	\$6,081	\$6,704	\$6,546	\$6,645	\$7,091	
54	144	29	368	154	LKT54144-29ART	\$5,508	\$5,596	\$6,129	\$6,048	\$6,134	\$6,514	
54	120	29	316	130	LKT54120-29ART	\$4,934	\$5,006	\$5,453	\$5,444	\$5,517	\$5,835	
48	192	29	429	183	LKT48192-29ART	\$5,760	\$5,863	\$6,499	\$6,325	\$6,427	\$6,879	
48	168	29	385	161	LKT48168-29ART	\$5,355	\$5,444	\$6,001	\$5,896	\$5,986	\$6,384	
48	144	29	339	139	LKT48144-29ART	\$4,912	\$4,989	\$5,468	\$5,431	\$5,508	\$5,849	
48	120	29	293	116	LKT48120-29ART	\$4,414	\$4,478	\$4,875	\$4,910	\$4,975	\$5,258	
48	108	29	270	105	LKT48108-29ART	\$3,739	\$3,796	\$4,154	\$4,222	\$4,280	\$4,536	

Features:

- price reflects complete table - top and base
- ships KD in multiple cartons
- two piece top
- model includes adjustable glide

Options:

- specify power/charging option, see below for options and upcharges



top shape

LOK - CONFERENCE

To Order Specify

1 Laminate Model #	2 Edge Detail	3 Laminate Selection	3a PVC Edge Color	4 Electrical	5 Metal Color
Laminate (LKT)	See Edge Detail Options	See Laminate Selection	See PVC Edge Color Options	N None CT2 Dual Power Center Top CU2 Dual Power Underside CT2U1 Dual Power Center Top with Underside CT4U2 Four Power Center Top with Underside CT4 Four Power Center Top (See chart on next page)	See Metal Finish Color Options

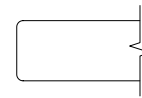
Model Number Breakdown

LKT60192-29ART					
LK	T	60192	29	TT	T
LOK	Laminate	60" x 192"	Height	Rectangular Top Shape	T base

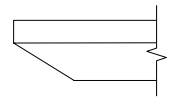
Description

Arc Rectangular 2pc Table with T Base at Working Height (continued)

Veneer Tables "LKV" Models



Eased Edge (R3)



Reverse Bevel Edge (K9)

VENEER	D	W	H	CTN WT	CU FT	Model	Flat Cut	Double Cut	Flat Cut	Double Cut
		60	192	29	507	226	LKV60192-29ART	\$10,797	\$11,661	\$11,767
	60	168	29	453	198	LKV60168-29ART	\$9,931	\$10,725	\$10,824	\$11,528
	60	144	29	396	169	LKV60144-29ART	\$9,039	\$9,763	\$9,852	\$10,493
	60	120	29	339	143	LKV60120-29ART	\$7,976	\$8,614	\$8,694	\$9,257
	54	192	29	467	204	LKV54192-29ART	\$9,875	\$10,667	\$10,766	\$11,463
	54	168	29	389	178	LKV54168-29ART	\$9,031	\$9,755	\$9,844	\$10,484
	54	144	29	368	154	LKV54144-29ART	\$8,202	\$8,859	\$8,942	\$9,521
	54	120	29	316	130	LKV54120-29ART	\$7,259	\$7,839	\$7,911	\$8,423
	48	192	29	429	183	LKV48192-29ART	\$8,868	\$9,596	\$9,343	\$10,029
	48	168	29	385	161	LKV48168-29ART	\$8,131	\$8,758	\$8,563	\$9,156
	48	144	29	339	139	LKV48144-29ART	\$7,363	\$7,893	\$7,756	\$8,254
	48	120	29	293	116	LKV48120-29ART	\$6,546	\$6,981	\$6,899	\$7,306
	48	108	29	270	105	LKV48108-29ART	\$5,374	\$5,804	\$5,857	\$6,237

Electrical Options and Upcharges

	108 wide	120 - 192 wide
CT2		
Dual Power Center Top - Black	CT2BL - add \$1,490	n/a
Dual Power Center Top - White	CT2WH - add \$1,490	n/a
CU1		
Single Power Underside - Black	CU1-1C - add \$592	CU1-1C - add \$688
Single Power Underside with Wireless Charging - Black	CU1-1CW - add \$1,371	CU1-1CW - add \$1,440
CT2U1		
Dual Power Center Top - Black with Underside	CT2U1-BL - add \$1,813	n/a
Dual Power Center Top - White with Underside	CT2U1-WH - add \$1,813	n/a
Dual Power Center Top - Black with Wireless Charging	CT2U1-BLW2 - add \$2,592	n/a
Dual Power Center Top - White with Wireless Charging	CT2U1-WHW2 - add \$2,592	n/a

	108 wide	120 - 192 wide
CT4U1		
Four Power Center Top with Single Underside - Black	n/a	CT4U1-BL - add \$3,169
Four Power Center Top with Single Underside - White	n/a	CT4U1-WH - add \$3,169
Four Power Center Top - Black with Underside & Wireless Charging	n/a	CT4U1-BLW2 - add \$3,928
Four Power Center Top - White with Underside & Wireless Charging	n/a	CT4U1-WHW2 - add \$3,928
CT4		
Four Power Center Top - Black	n/a	CT4BL - add \$2,775
Four Power Center Top - White	n/a	CT4WH - add \$2,775

Note: Order power infed that best fits application

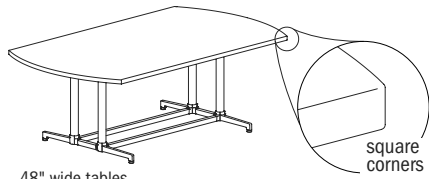
To Order Specify

1 Veneer Model #	2 Edge Detail	3 Wood Species	4 Wood Finish	5 Electrical	6 Metal Color
Veneer (LKV)	See Edge Detail Options	Flat Cut CH1 Cherry MA1 Maple WA1 Walnut BO1 Black Oak	See Flat Cut Wood Finish Options	N None CT2 Dual Power Center Top CU2 Dual Power Underside CT2U1 Dual Power Center Top with Underside CT4U2 Four Power Center Top with Underside CT4 Four Power Center Top	See Metal Finish Color Options
		Double Cut DC1 Double Cut	4 Wood Finish See Double Cut Wood Finish Options		

LOK - CONFERENCE

Description

Arc Rectangular Table with T Base at Working Height



48" wide tables have double column base

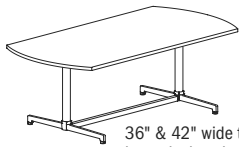
LAMINATE	D	W	H	CTN WT	CU FT	Model	Laminate Tables "LKT" Models					
							Eased Edge (R3)			Reverse Bevel Edge (K9)		
							Standard Tier 1	Graded In Tier 2 Tier 3		Standard Tier 1	Graded In Tier 2 Tier 3	
	48	96	29	219	83	LKT4896-29ART	\$3,144	\$3,194	\$3,512	\$3,616	\$3,668	\$3,894
	48	84	29	196	83	LKT4884-29ART	\$2,791	\$2,838	\$3,114	\$3,252	\$3,297	\$3,497
	42	96	29	179	73	LKT4296-29ART	\$2,854	\$2,899	\$3,178	\$3,314	\$3,358	\$3,558
	42	84	29	158	72	LKT4284-29ART	\$2,351	\$2,391	\$2,636	\$2,803	\$2,842	\$3,016
	36	96	29	160	72	LKT3696-29ART	\$2,400	\$2,439	\$2,678	\$2,848	\$2,887	\$3,058
	36	84	29	148	64	LKT3684-29ART	\$2,154	\$2,185	\$2,395	\$2,592	\$2,627	\$2,776

Features:

- price reflects complete table - top and base
- ships KD in multiple cartons
- one piece top
- model includes adjustable glide

Options:

- specify power/charging option, see below for options and upcharges



36" & 42" wide tables have single column base



top shape

To Order Specify

1 Laminate Model #	2 Edge Detail	3 Laminate Selection	3a PVC Edge Color	4 Electrical	5 Metal Color
Laminate (LKT)	See Edge Detail Options	See Laminate Selection	See PVC Edge Color Options	N None CT2 Dual Power Center Top CU2 Dual Power Underside CT2U1 Dual Power Center Top with Underside (See chart on next page)	See Metal Finish Color Options

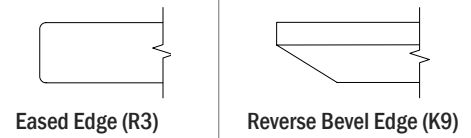
Model Number Breakdown

LKT4896-29ART					
LK	T	4896	29	AR	T
LOK	Laminate	48" x 96"	Height	Arc Rectangular Top Shape	T base

Description

Arc Rectangular Table with T Base at Working Height (continued)

Veneer Tables "LKV" Models



VENEER	D	W	H	CTN WT	CU FT	① Model	Eased Edge (R3)		Reverse Bevel Edge (K9)	
							Flat Cut	Double Cut	Flat Cut	Double Cut
	48	96	29	219	83	LKV4896-29ART	\$4,378	\$4,715	\$4,687	\$5,005
	48	84	29	196	83	LKV4884-29ART	\$3,995	\$4,286	\$4,281	\$4,553
	42	96	29	179	73	LKV4296-29ART	\$4,266	\$4,608	\$4,649	\$4,951
	42	84	29	158	72	LKV4284-29ART	\$3,586	\$3,871	\$3,908	\$4,164
	36	96	29	160	72	LKV3696-29ART	\$3,247	\$3,505	\$3,537	\$3,768
	36	84	29	148	64	LKV3684-29ART	\$2,987	\$3,224	\$3,255	\$3,466

Electrical Options and Upcharges

CT2	84 - 96 wide
Dual Power Center Top - Black	CT2BL - add \$1,490
Dual Power Center Top - White	CT2WH - add \$1,490
CU1	
Single Power Underside - Black	CU1-1C - add \$592
Single Power Underside with Wireless Charging - Black	CU1-1CW - add \$1,371
CT2U1	
Dual Power Center Top - Black with Single Underside	CT2U1-BL - add \$1,813
Dual Power Center Top - White with Single Underside	CT2U1-WH - add \$1,813
Dual Power Center Top - Black with Wireless Charging	CT2U1-BLW2 - add \$2,592
Dual Power Center Top - White with Wireless Charging	CT2U1-WHW2 - add \$2,592

Note: Order power infeed that best fits application

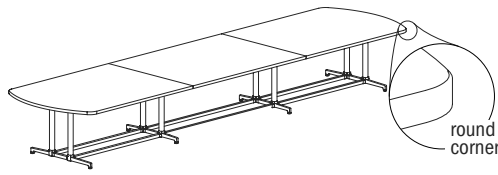
To Order Specify

① Veneer Model #	② Edge Detail	③ Wood Species	④ Wood Finish	⑤ Electrical	⑥ Metal Color
Veneer (LKV)	See Edge Detail Options	Flat Cut CH1 Cherry MA1 Maple WA1 Walnut BO1 Black Oak	See Flat Cut Wood Finish Options	N None CT2 Dual Power Center Top CU2 Dual Power Underside CT2U1 Dual Power Center Top with Underside (See chart above)	See Metal Finish Color Options
		Double Cut DC1 Double Cut	④ Wood Finish See Double Cut Wood Finish Options		

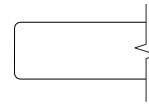
LOK - CONFERENCE

Description

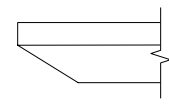
Rounded Arc Rectangular 3pc Table with T Base at Working Height



Laminate Tables
"LKT" Models



Eased Edge (R3)



Reverse Bevel Edge (K9)

LAMINATE	D	W	H	CTN WT	CU FT	① Model	Standard			Graded In		
							Tier 1	Tier 2	Tier 3	Tier 1	Tier 2	Tier 3
	60	240	29	648	281	LKT60240-29ARRT	\$9,960	\$10,122	\$11,109	\$10,639	\$10,800	\$11,505
60	216	29	593	253	LKT60216-29ARRT	\$8,490	\$8,633	\$9,526	\$9,139	\$9,284	\$9,918	
54	240	29	598	254	LKT54240-29ARRT	\$8,034	\$8,177	\$9,068	\$8,679	\$8,823	\$9,458	
54	216	29	549	229	LKT54216-29ARRT	\$7,555	\$7,686	\$8,486	\$8,176	\$8,304	\$8,878	
48	240	29	548	228	LKT48240-29ARRT	\$7,653	\$7,782	\$8,576	\$8,265	\$8,392	\$8,958	
48	216	29	549	206	LKT48216-29ARRT	\$6,770	\$6,886	\$7,600	\$7,360	\$7,475	\$7,984	

Features:

- price reflects complete table - top and base
- ships KD in multiple cartons
- three piece top
- model includes adjustable glide

Options:

- specify power/charging option, see below for options and upcharges



top shape

LOK - CONFERENCE

To Order Specify

① Laminate Model #	② Edge Detail	③ Laminate Selection	④ PVC Edge Color	⑤ Electrical	⑥ Metal Color
Laminate (LKT)	See Edge Detail Options	See Laminate Selection	See PVC Edge Color Options	N None CT6 Six Power Center Top CU2 Dual Power Underside CT6U2 Six Power Center Top with Underside (See chart on next page)	See Metal Finish Color Options

Model Number Breakdown

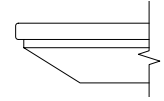
LKT60240-29ARRT						
LK	T	60240	29	AR	R	T
LOK	Laminate	60" x 240"	Height	Arc Rectangular Top Shape	Rounded Corner	T base

Description

Rounded Arc Rectangular 3pc Table with T Base at Working Height (continued)

Veneer Tables "LKV" Models

Solid Surface Tables "LKS" Models



Reverse Bevel Edge (S7)

	D	W	H	CTN WT	CU FT	1 Model	Flat Cut	Double Cut	Flat Cut	Double Cut	Standard
VENEER	60	240	29	648	281	LKV60240-29ARRT	\$15,492	\$16,732	\$16,886	\$17,984	--
	60	216	29	593	253	LKV60216-29ARRT	\$13,636	\$14,727	\$14,863	\$15,830	--
	54	240	29	598	254	LKV54240-29ARRT	\$13,125	\$14,188	\$13,743	\$14,754	--
	54	216	29	549	229	LKV54216-29ARRT	\$12,179	\$13,125	\$12,747	\$13,643	--
	48	240	29	548	228	LKV48240-29ARRT	\$12,313	\$13,251	\$12,876	\$13,762	--
	48	216	29	549	206	LKV48216-29ARRT	\$10,815	\$11,648	\$11,334	\$12,120	--
SOLID SURFACE	60	240	29	648	281	LKS60240-29ARRT	--	--	--	--	\$34,782
	60	216	29	593	253	LKS60216-29ARRT	--	--	--	--	\$31,437
	54	240	29	598	254	LKS54240-29ARRT	--	--	--	--	\$31,650
	54	216	29	549	229	LKS54216-29ARRT	--	--	--	--	\$28,639
	48	240	29	548	228	LKS48240-29ARRT	--	--	--	--	\$28,583
	48	216	29	549	206	LKS48216-29ARRT	--	--	--	--	\$25,273

Electrical Options and Upcharges

	216 - 240 wide
CT6	
Six Power Center Top - Black	CT6BL - add \$4,016
Six Power Center Top - White	CT6WH - add \$4,016
CU2	
Dual Power Underside - Black	CU2-1C - add \$1,052
Dual Power Underside with 4 Wireless Charging - Black	CU2-1CW - add \$2,660
CT6U2	
Six Power Center Top - Black with Dual Underside	CT6U2-BL - add \$4,665
Six Power Center Top - White with Dual Underside	CT6U2-WH - add \$4,665
Six Power Center Top - Black with Dual Underside with 4 Wireless Charging	CT6U2-BLW2 - add \$6,223
Six Power Center Top - White with Dual Underside with 4 Wireless Charging	CT6U2-WHW2 - add \$6,223

LOK - CONFERENCE

Note: Order power infeed that best fits application

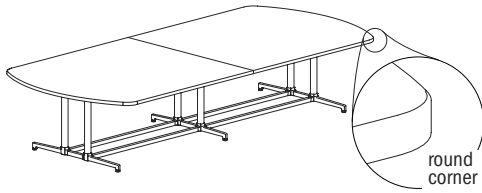
To Order Specify

1 Veneer Model #	2 Edge Detail	3 Wood Species	4 Wood Finish	5 Electrical	6 Metal Color
Veneer (LKV)	See Edge Detail Options	Flat Cut CH1 Cherry MA1 Maple WA1 Walnut BO1 Black Oak	See Flat Cut Wood Finish Options	N None CT6 Six Power Center Top CU2 Dual Power Underside CT6U2 Six Power Center Top with Underside (See chart above)	See Metal Finish Color Options
		Double Cut DC1 Double Cut	See Double Cut Wood Finish Options		

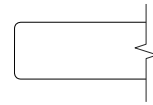
1 Solid Surface Model #	2 Top Surface Selection	3 Electrical	4 Metal Color
Solid Surface (LKS)	See Solid Surface Top Surface Selection Options	N None CT6 Six Power Center Top CU2 Dual Power Underside CT6U2 Six Power Center Top with Underside (See chart above)	See Metal Finish Color Options

Description

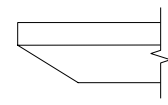
Rounded Arc Rectangular 2pc Table with T Base at Working Height



Laminate Tables "LKT" Models



Eased Edge (R3)



Reverse Bevel Edge (K9)

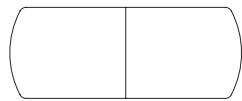
LAMINATE	D	W	H	CTN WT	CU FT	Model	Standard			Graded In		
							Tier 1	Tier 2	Tier 3	Tier 1	Tier 2	Tier 3
	60	192	29	507	226	LKT60192-29ARRT	\$6,937	\$7,067	\$7,857	\$7,554	\$7,682	\$8,248
60	168	29	453	198	LKT60168-29ARRT	\$6,474	\$6,586	\$7,280	\$7,061	\$7,173	\$7,667	
60	144	29	396	169	LKT60144-29ARRT	\$5,973	\$6,068	\$6,663	\$6,532	\$6,627	\$7,050	
60	120	29	339	143	LKT60120-29ARRT	\$5,296	\$5,375	\$5,872	\$5,825	\$5,904	\$6,257	
54	192	29	467	204	LKT54192-29ARRT	\$6,601	\$6,718	\$7,431	\$7,192	\$7,307	\$7,815	
54	168	29	389	178	LKT54168-29ARRT	\$5,979	\$6,081	\$6,704	\$6,546	\$6,645	\$7,091	
54	144	29	368	154	LKT54144-29ARRT	\$5,508	\$5,596	\$6,129	\$6,048	\$6,134	\$6,514	
54	120	29	316	130	LKT54120-29ARRT	\$4,934	\$5,006	\$5,453	\$5,444	\$5,517	\$5,835	
48	192	29	429	183	LKT48192-29ARRT	\$5,760	\$5,863	\$6,499	\$6,325	\$6,427	\$6,879	
48	168	29	385	161	LKT48168-29ARRT	\$5,355	\$5,444	\$6,001	\$5,896	\$5,986	\$6,384	
48	144	29	339	139	LKT48144-29ARRT	\$5,642	\$5,718	\$6,194	\$6,160	\$6,236	\$6,576	
48	120	29	293	116	LKT48120-29ARRT	\$4,414	\$4,478	\$4,875	\$4,910	\$4,975	\$5,258	
48	108	29	270	105	LKT48108-29ARRT	\$3,739	\$3,796	\$4,154	\$4,222	\$4,280	\$4,536	

Features:

- price reflects complete table - top and base
- ships KD in multiple cartons
- two piece top
- model includes adjustable glide

Options:

- specify power/charging option, see below for options and upcharges



top shape

Electrical Options and Upcharges

	108 wide	120 - 192 wide
CT2		
Dual Power Center Top - Black	CT2BL - add \$1,490	n/a
Dual Power Center Top - White	CT2WH - add \$1,490	n/a
CU1		
Single Power Underside - Black	CU1-1C - add \$592	CU1-1C - add \$688
Single Power Underside with Wireless Charging - Black	CU1-1CW - add \$1,371	CU1-1CW - add \$1,440
CT2U1		
Dual Power Center Top - Black with Underside	CT2U1-BL - add \$1,813	n/a
Dual Power Center Top - White with Underside	CT2U1-WH - add \$1,813	n/a
Dual Power Center Top - Black with Wireless Charging	CT2U1-BLW2 - add \$2,592	n/a
Dual Power Center Top - White with Wireless Charging	CT2U1-WHW2 - add \$2,592	n/a

Note: Order power infeed that best fits application.

	108 wide	120 - 192 wide
CT4U1		
Four Power Center Top with Single Underside - Black	n/a	CT4U1-BL - add \$3,169
Four Power Center Top with Single Underside - White	n/a	CT4U1-WH - add \$3,169
Four Power Center Top - Black with Underside & Wireless Charging	n/a	CT4U1-BLW2 - add \$3,928
Four Power Center Top - White with Underside & Wireless Charging	n/a	CT4U1-WHW2 - add \$3,928
CT4		
Four Power Center Top - Black	n/a	CT4BL - add \$2,775
Four Power Center Top - White	n/a	CT4WH - add \$2,775

To Order Specify

1 Laminate Model #	2 Edge Detail	3 Laminate Selection	3a PVC Edge Color	4 Electrical	5 Metal Color
Laminate (LKT)	See Edge Detail Options	See Laminate Selection	See PVC Edge Color Options	N None CT2 Dual Power Center Top CU2 Dual Power Underside CT2U1 Dual Power Center Top with Underside CT4U2 Four Power Center Top with Underside CT4 Four Power Center Top (See chart above)	See Metal Finish Color Options

Model Number Breakdown

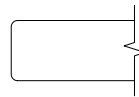
LKT60192-29ARRT						
LK	T	60192	29	AR	R	T
LOK	Laminate	60" x 192"	Height	Arc Rectangular Top Shape	Rounded Corner	T base

Description

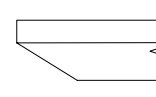
Rounded Arc Rectangular 2pc
Table with T Base at Working Height
(continued)

Veneer Tables
"LKV" Models

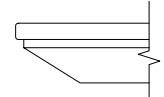
Solid Surface Tables
"LKS" Models



Eased Edge (R3)



Reverse Bevel Edge (K9)



Reverse Bevel Edge (S7)

	D	W	H	CTN WT	CU FT	① Model	Veneer		Solid Surface		Standard	
							Flat Cut	Double Cut	Flat Cut	Double Cut		
VENEER	60	192	29	507	226	LKV60192-29ARRT	\$10,797	\$11,661	\$11,767	\$12,532	--	
	60	168	29	453	198	LKV60168-29ARRT	\$9,931	\$10,725	\$10,824	\$11,528	--	
	60	144	29	396	169	LKV60144-29ARRT	\$9,039	\$9,763	\$9,852	\$10,493	--	
	60	120	29	339	143	LKV60120-29ARRT	\$7,976	\$8,614	\$8,694	\$9,257	--	
	54	192	29	467	204	LKV54192-29ARRT	\$9,875	\$10,667	\$10,766	\$11,463	--	
	54	168	29	389	178	LKV54168-29ARRT	\$9,031	\$9,755	\$9,844	\$10,484	--	
	54	144	29	368	154	LKV54144-29ARRT	\$8,202	\$8,859	\$8,942	\$9,521	--	
	54	120	29	316	130	LKV54120-29ARRT	\$7,259	\$7,839	\$7,911	\$8,423	--	
	48	192	29	429	183	LKV48192-29ARRT	\$8,868	\$9,596	\$9,343	\$10,029	--	
	48	168	29	385	161	LKV48168-29ARRT	\$8,131	\$8,758	\$8,563	\$9,156	--	
	48	144	29	339	139	LKV48144-29ARRT	\$7,363	\$7,893	\$7,756	\$8,254	--	
	48	120	29	293	116	LKV48120-29ARRT	\$6,546	\$6,981	\$6,899	\$7,306	--	
	48	108	29	270	105	LKV48108-29ARRT	\$5,374	\$5,804	\$5,857	\$6,237	--	
	SOLID SURFACE	60	192	29	507	226	LKS60192-29ARRT	--	--	--	--	\$26,124
		60	168	29	453	198	LKS60168-29ARRT	--	--	--	--	\$23,083
		60	144	29	396	169	LKS60144-29ARRT	--	--	--	--	\$20,080
60		120	29	339	143	LKS60120-29ARRT	--	--	--	--	\$21,962	
54		192	29	467	204	LKS54192-29ARRT	--	--	--	--	\$23,651	
54		168	29	389	178	LKS54168-29ARRT	--	--	--	--	\$20,997	
54		144	29	368	154	LKS54144-29ARRT	--	--	--	--	\$18,297	
54		120	29	316	130	LKS54120-29ARRT	--	--	--	--	\$15,543	
48		192	29	429	183	LKS48192-29ARRT	--	--	--	--	\$21,386	
48		168	29	385	161	LKS48168-29ARRT	--	--	--	--	\$18,959	
48		144	29	339	139	LKS48144-29ARRT	--	--	--	--	\$16,552	
48		120	29	293	116	LKS48120-29ARRT	--	--	--	--	\$14,151	
48		108	29	270	105	LKS48108-29ARRT	--	--	--	--	\$12,927	

To Order Specify

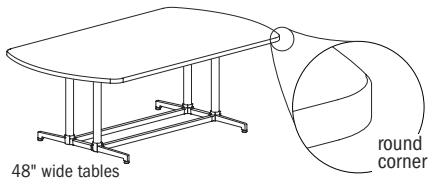
① Veneer Model #	② Edge Detail	③ Wood Species	④ Wood Finish	⑤ Electrical	⑥ Metal Color
Veneer (LKV)	See Edge Detail Options	Flat Cut CH1 Cherry MA1 Maple WA1 Walnut BO1 Black Oak	See Flat Cut Wood Finish Options	N None CT2 Dual Power Center Top CU2 Dual Power Underside CT2U1 Dual Power Center Top with Underside CT4U2 Four Power Center Top with Underside CT4 Four Power Center Top (See chart on previous page)	See Metal Finish Color Options
		Double Cut DC1 Double Cut	④ Wood Finish See Double Cut Wood Finish Options		

① Solid Surface Model #	② Top Surface Selection	③ Electrical	④ Metal Color
Solid Surface (LKS)	See Solid Surface Top Surface Selection Options	N None CT2 Dual Power Center Top CU2 Dual Power Underside CT2U1 Dual Power Center Top with Underside	See Metal Finish Color Options

LOK - CONFERENCE

Description

Rounded Arc Rectangular Table with T Base at Working Height



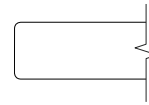
48" wide tables have double column base

D **W** **H** **CTN WT** **CU FT** **Model**

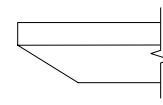
48	96	29	219	83	LKT4896-29ARRT
48	84	29	196	83	LKT4884-29ARRT
42	96	29	179	83	LKT4296-29ARRT
42	84	29	158	73	LKT4284-29ARRT
36	96	29	160	72	LKT3696-29ARRT
36	84	29	148	64	LKT3684-29ARRT

LAMINATE

Laminate Tables "LKT" Models



Eased Edge (R3)



Reverse Bevel Edge (K9)

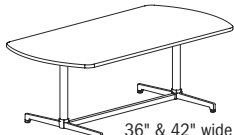
Standard		Graded In		Standard		Graded In		
Tier 1	Tier 2	Tier 3	Tier 1	Tier 2	Tier 3	Tier 1	Tier 2	Tier 3
\$3,144	\$3,194	\$3,512	\$3,616	\$3,668	\$3,894	\$3,252	\$3,297	\$3,497
\$2,854	\$2,899	\$3,178	\$3,314	\$3,358	\$3,558	\$2,803	\$2,842	\$3,016
\$2,400	\$2,439	\$2,678	\$2,848	\$2,887	\$3,058	\$2,592	\$2,627	\$2,776
\$2,154	\$2,185	\$2,395	\$2,592	\$2,627	\$2,776			

Features:

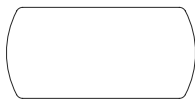
- price reflects complete table - top and base
- ships KD in multiple cartons
- one piece top
- model includes adjustable glide

Options:

- specify power/charging option, see below for options and upcharges



36" & 42" wide tables have single column base



top shape

LOK - CONFERENCE

To Order Specify

1 Laminates Model #	2 Edge Detail	3 Laminates Selection	3a PVC Edge Color	4 Electrical	5 Metal Color
Laminates (LKT)	See Edge Detail Options	See Laminates Selection	See PVC Edge Color Options	N None CT2 Dual Power Center Top CU2 Dual Power Underside CT2U1 Dual Power Center Top with Underside (See chart on next page)	See Metal Finish Color Options

Model Number Breakdown

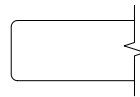
LKT4896-29ARRT						
LK	T	4896	29	AR	R	T
LOK	Laminates	48" x 96"	Height	Arc Rectangular Top Shape	Rounded Corner	T base

Description

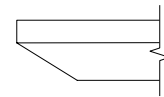
Rounded Arc Rectangular Table with T Base at Working Height (continued)

Veneer Tables "LKV" Models

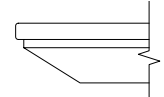
Solid Surface Tables "LKS" Models



Eased Edge (R3)



Reverse Bevel Edge (K9)



Reverse Bevel Edge (S7)

	D	W	H	CTN WT	CU FT	① Model	Veneer Tables "LKV" Models		Solid Surface Tables "LKS" Models		
							Flat Cut	Double Cut	Flat Cut	Double Cut	Standard
VENEER	48	96	29	219	83	LKV4896-29ARRT	\$4,378	\$4,715	\$4,687	\$5,005	--
	48	84	29	196	83	LKV4884-29ARRT	\$3,995	\$4,286	\$4,281	\$4,553	--
	42	96	29	179	83	LKV4296-29ARRT	\$4,266	\$4,608	\$4,649	\$4,951	--
	42	84	29	158	73	LKV4284-29ARRT	\$3,586	\$3,871	\$3,908	\$4,164	--
	36	96	29	160	72	LKV3696-29ARRT	\$3,247	\$3,505	\$3,537	\$3,768	--
	36	84	29	148	64	LKV3684-29ARRT	\$2,987	\$3,224	\$3,255	\$3,466	--
SOLID SURFACE	48	96	29	219	83	LKS4896-29ARRT	--	--	--	--	\$10,261
	48	84	29	196	83	LKS4884-29ARRT	--	--	--	--	\$9,095
	42	96	29	179	83	LKS4296-29ARRT	--	--	--	--	\$8,348
	42	84	29	158	73	LKS4284-29ARRT	--	--	--	--	\$7,358
	36	96	29	160	72	LKS3696-29ARRT	--	--	--	--	\$7,335
	36	84	29	148	64	LKS3684-29ARRT	--	--	--	--	\$6,611

Electrical Options and Upcharges

CT2	84 - 96 wide
Dual Power Center Top - Black	CT2BL - add \$1,490
Dual Power Center Top - White	CT2WH - add \$1,490
CU1	
Single Power Underside - Black	CU1-1C - add \$592
Single Power Underside with Wireless Charging - Black	CU1-1CW - add \$1,371
CT2U1	
Dual Power Center Top - Black with Single Underside	CT2U1-BL - add \$1,813
Dual Power Center Top - White with Single Underside	CT2U1-WH - add \$1,813
Dual Power Center Top - Black with Wireless Charging	CT2U1-BLW2 - add \$2,592
Dual Power Center Top - White with Wireless Charging	CT2U1-WHW2 - add \$2,592

Note: Order power infeed that best fits application

To Order Specify

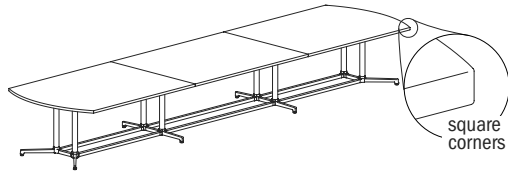
① Veneer Model #	② Edge Detail	③ Wood Species	④ Wood Finish	⑤ Electrical	⑥ Metal Color
Veneer (LKV)	See Edge Detail Options	Flat Cut CH1 Cherry MA1 Maple WA1 Walnut BO1 Black Oak	See Flat Cut Wood Finish Options	N None CT2 Dual Power Center Top CU2 Dual Power Underside CT2U1 Dual Power Center Top with Underside (See chart above)	See Metal Finish Color Options
		Double Cut DC1 Double Cut	④ Wood Finish See Double Cut Wood Finish Options		

① Solid Surface Model #	② Top Surface Selection	③ Electrical	④ Metal Color
Solid Surface (LKS)	See Solid Surface Top Surface Selection Options	N None CT2 Dual Power Center Top CU2 Dual Power Underside CT2U1 Dual Power Center Top with Underside (See chart above)	See Metal Finish Color Options

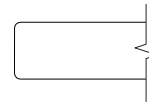
LOK - CONFERENCE

Description

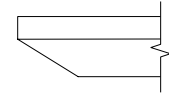
Arc Rectangular 3pc Table with Y Base at Working Height



Laminate Tables
"LKT" Models



Eased Edge (R3)



Reverse Bevel Edge (K9)

LAMINATE	D	W	H	CTN WT	CU FT	Model	Eased Edge (R3)			Reverse Bevel Edge (K9)		
							Standard Tier 1	Graded In Tier 2 Tier 3		Standard Tier 1	Graded In Tier 2 Tier 3	
		60	240	29	648	281	LKT60240-29ARY	\$9,650	\$9,807	\$10,798	\$10,327	\$10,486
	60	216	29	593	253	LKT60216-29ARY	\$8,159	\$8,304	\$9,194	\$8,808	\$8,953	\$9,589
	54	240	29	575	254	LKT54240-29ARY	\$7,634	\$7,777	\$8,670	\$8,278	\$8,422	\$9,058
	54	216	29	529	229	LKT54216-29ARY	\$6,824	\$6,954	\$7,755	\$7,442	\$7,572	\$8,145
	48	240	29	548	228	LKT48240-29ARY	\$7,376	\$7,506	\$8,298	\$7,987	\$8,115	\$8,683
	48	216	29	486	206	LKT48216-29ARY	\$6,836	\$6,952	\$7,666	\$7,428	\$7,541	\$8,051

Features:

- price reflects complete table - top and base
- ships KD in multiple cartons
- three piece top
- model includes adjustable glide

Options:

- specify power/charging option, see below for options and upcharges



top shape

LOK - CONFERENCE

To Order Specify

1 Laminate Model #	2 Edge Detail	3 Laminate Selection	4a PVC Edge Color	4 Electrical	5 Metal Color
Laminate (LKT)	See Edge Detail Options	See Laminate Selection	See PVC Edge Color Options	N None CT6 Six Power Center Top CU2 Dual Power Underside CT6U2 Six Power Center Top with Underside (See chart on next page)	See Metal Finish Color Options

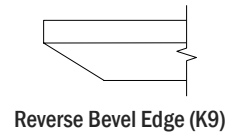
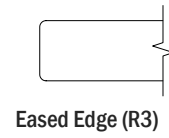
Model Number Breakdown

LKT60240-29ARY					
LK	T	60240	29	AR	Y
LOK	Laminate	60" x 240"	Height	Arc Rectangular Top Shape	Y base

Description

Arc Rectangular 3pc Table with Y Base at Working Height (continued)

Veneer Tables "LKV" Models



VENEER	D	W	H	CTN WT	CU FT	1 Model	Eased Edge (R3)		Reverse Bevel Edge (K9)	
							Flat Cut	Double Cut	Flat Cut	Double Cut
	60	240	29	648	281	LKV60240-29ARY	\$15,024	\$16,225	\$16,376	\$17,439
	60	216	29	593	253	LKV60216-29ARY	\$13,148	\$14,200	\$14,330	\$15,263
	54	240	29	575	254	LKV54240-29ARY	\$12,533	\$13,600	\$13,152	\$14,164
	54	216	29	529	229	LKV54216-29ARY	\$11,117	\$12,061	\$11,687	\$12,582
	48	240	29	548	228	LKV48240-29ARY	\$11,911	\$12,849	\$12,471	\$13,360
	48	216	29	486	206	LKV48216-29ARY	\$10,912	\$11,742	\$11,429	\$12,214

Electrical Options and Upcharges

	216 - 240 wide
CT6	
Six Power Center Top - Black	CT6BL - add \$4,016
Six Power Center Top - White	CT6WH - add \$4,016
CU2	
Dual Power Underside - Black	CU2-1C - add \$1,052
Dual Power Underside with 4 Wireless Charging - Black	CU2-1CW - add \$2,660
CT6U2	
Six Power Center Top - Black with Dual Underside	CT6U2-BL - add \$4,665
Six Power Center Top - White with Dual Underside	CT6U2-WH - add \$4,665
Six Power Center Top - Black Dual Underside with 4 Wireless Charging	CT6U2-BLW2 - add \$6,223
Six Power Center Top - White Dual Underside with 4 Wireless Charging	CT6U2-WHW2 - add \$6,223

Note: Order power infeed that best fits application

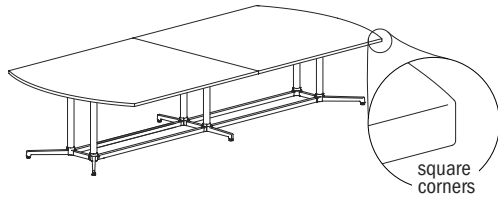
To Order Specify

1 Veneer Model #	2 Edge Detail	3 Wood Species	4 Wood Finish	5 Electrical	6 Metal Color
Veneer (LKV)	See Edge Detail Options	Flat Cut CH1 Cherry MA1 Maple WA1 Walnut BO1 Black Oak	See Flat Cut Wood Finish Options	N None CT6 Six Power Center Top CU2 Dual Power Underside CT6U2 Six Power Center Top with Underside (See chart above)	See Metal Finish Color Options
		Double Cut DC1 Double Cut	See Double Cut Wood Finish Options		

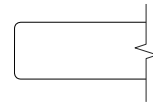
LOK - CONFERENCE

Description

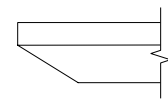
Arc Rectangular 2pc Table with Y Base at Working Height



Laminate Tables "LKT" Models



Eased Edge (R3)



Reverse Bevel Edge (K9)

LAMINATE	D	W	H	CTN WT	CU FT	Model	Standard			Graded In		
							Tier 1	Tier 2	Tier 3	Tier 1	Tier 2	Tier 3
		60	192	29	507	226	LKT60192-29ARY	\$7,510	\$7,640	\$8,431	\$8,127	\$8,257
	60	168	29	453	198	LKT60168-29ARY	\$6,268	\$6,381	\$7,075	\$6,857	\$6,969	\$7,465
	60	144	29	333	169	LKT60144-29ARY	\$5,711	\$5,806	\$6,401	\$6,267	\$6,364	\$6,788
	60	120	29	300	143	LKT60120-29ARY	\$5,144	\$5,223	\$5,720	\$5,673	\$5,753	\$6,106
	54	192	29	454	204	LKT54192-29ARY	\$6,512	\$6,627	\$7,342	\$7,104	\$7,218	\$7,728
	54	168	29	360	178	LKT54168-29ARY	\$5,799	\$5,900	\$6,525	\$6,364	\$6,465	\$6,910
	54	144	29	357	154	LKT54144-29ARY	\$5,272	\$5,358	\$5,893	\$5,812	\$5,896	\$6,280
	54	120	29	308	130	LKT54120-29ARY	\$4,831	\$4,902	\$5,349	\$5,343	\$5,415	\$5,732
	48	192	29	416	183	LKT48192-29ARY	\$6,333	\$6,436	\$7,071	\$6,897	\$6,999	\$7,451
	48	168	29	369	161	LKT48168-29ARY	\$5,135	\$5,223	\$5,780	\$5,676	\$5,764	\$6,162
	48	144	29	327	139	LKT48144-29ARY	\$4,756	\$4,833	\$5,310	\$5,276	\$5,353	\$5,691
	48	120	29	285	116	LKT48120-29ARY	\$4,298	\$4,363	\$4,762	\$4,795	\$4,858	\$5,143
	48	108	29	263	105	LKT48108-29ARY	\$3,829	\$3,887	\$4,243	\$4,314	\$4,370	\$4,627

Features:

- price reflects complete table - top and base
- ships KD in multiple cartons
- two piece top
- model includes adjustable glide

Options:

- specify power/charging option, see below for options and upcharges



top shape

LOK - CONFERENCE

To Order Specify

1 Laminate Model #	2 Edge Detail	3 Laminate Selection	3a PVC Edge Color	4 Electrical	5 Metal Color
Laminate (LKT)	See Edge Detail Options	See Laminate Selection	See PVC Edge Color Options	N None CT2 Dual Power Center Top CU2 Dual Power Underside CT2U1 Dual Power Center Top with Underside CT4U2 Four Power Center Top with Underside CT4 Four Power Center Top (See chart on next page)	See Metal Finish Color Options

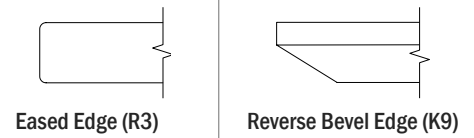
Model Number Breakdown

LKT60192-29ARY					
LK	T	60192	29	AR	Y
LOK	Laminate	60" x 192"	Height	Arc Rectangular Top Shape	Y base

Description

Arc Rectangular 2pc Table with Y Base at Working Height (continued)

Veneer Tables "LKV" Models



D	W	H	CTN WT	CU FT	Model	Eased Edge (R3)		Reverse Bevel Edge (K9)	
						Flat Cut	Double Cut	Flat Cut	Double Cut
60	192	29	507	226	LKV60192-29ARY	\$11,627	\$12,557	\$12,673	\$13,497
60	168	29	453	198	LKV60168-29ARY	\$9,639	\$10,410	\$10,508	\$11,190
60	144	29	333	169	LKV60144-29ARY	\$8,671	\$9,364	\$9,451	\$10,064
60	120	29	300	143	LKV60120-29ARY	\$7,767	\$8,387	\$8,464	\$9,015
54	192	29	454	204	LKV54192-29ARY	\$9,748	\$10,529	\$10,626	\$11,315
54	168	29	360	178	LKV54168-29ARY	\$8,779	\$9,482	\$9,568	\$10,191
54	144	29	357	154	LKV54144-29ARY	\$7,877	\$8,507	\$8,586	\$9,145
54	120	29	308	130	LKV54120-29ARY	\$7,120	\$7,688	\$7,762	\$8,263
48	192	29	416	183	LKV48192-29ARY	\$9,669	\$10,397	\$10,145	\$10,833
48	168	29	369	161	LKV48168-29ARY	\$7,827	\$8,453	\$8,260	\$8,849
48	144	29	327	139	LKV48144-29ARY	\$7,153	\$7,682	\$7,544	\$8,044
48	120	29	285	116	LKV48120-29ARY	\$6,391	\$6,827	\$6,745	\$7,154
48	108	29	263	105	LKV48108-29ARY	\$5,492	\$5,931	\$5,986	\$6,375

Electrical Options and Upcharges

CT2	108 wide	120 - 192 wide
Dual Power Center Top - Black	CT2BL - add \$1,490	n/a
Dual Power Center Top - White	CT2WH - add \$1,490	n/a
CU1		
Single Power Underside - Black	CU1-1C - add \$592	CU1-1C - add \$688
Single Power Underside with Wireless Charging - Black	CU1-1CW - add \$1,371	CU1-1CW - add \$1,440
CT2U1		
Dual Power Center Top - Black with Underside	CT2U1-BL - add \$1,813	n/a
Dual Power Center Top - White with Underside	CT2U1-WH - add \$1,813	n/a
Dual Power Center Top - Black with Wireless Charging	CT2U1-BLW2 - add \$2,592	n/a
Dual Power Center Top - White with Wireless Charging	CT2U1-WHW2 - add \$2,592	n/a

CT4U1	108 wide	120 - 192 wide
Four Power Center Top with Single Underside - Black	n/a	CT4U1-BL - add \$3,169
Four Power Center Top with Single Underside - White	n/a	CT4U1-WH - add \$3,169
Four Power Center Top - Black with Underside & Wireless Charging	n/a	CT4U1-BLW2 - add \$3,928
Four Power Center Top - White with Underside & Wireless Charging	n/a	CT4U1-WHW2 - add \$3,928
CT4		
Four Power Center Top - Black	n/a	CT4BL - add \$2,775
Four Power Center Top - White	n/a	CT4WH - add \$2,775

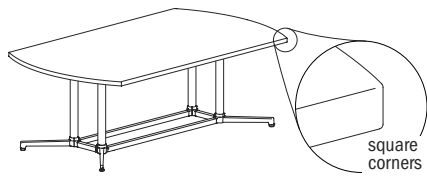
Note: Order power infed that best fits application

To Order Specify

1 Veneer Model #	2 Edge Detail	3 Wood Species	4 Wood Finish	5 Electrical	6 Metal Color
Veneer (LKV)	See Edge Detail Options	Flat Cut CH1 Cherry MA1 Maple WA1 Walnut BO1 Black Oak	See Flat Cut Wood Finish Options	N None CT2 Dual Power Center Top CU2 Dual Power Underside CT2U1 Dual Power Center Top with Underside CT4U2 Four Power Center Top with Underside CT4 Four Power Center Top	See Metal Finish Color Options
		Double Cut DC1 Double Cut	See Double Cut Wood Finish Options		

Description

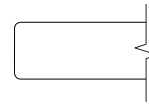
Arc Rectangular Table with Y Base at Working Height



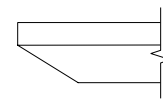
48" wide tables have double column base

LAMINATE	D	W	H	CTN WT	CU FT	Model	Standard			Graded In		
							Tier 1	Tier 2	Tier 3	Tier 1	Tier 2	Tier 3
	48	96	29	218	105	LKT4896-29ARY	\$3,163	\$3,213	\$3,532	\$3,634	\$3,685	\$3,914
48	84	29	333	83	LKT4884-29ARY	\$2,775	\$2,820	\$3,098	\$3,235	\$3,283	\$3,481	
42	96	29	169	83	LKT4296-29ARY	\$3,011	\$3,057	\$3,334	\$3,470	\$3,518	\$3,716	
42	84	29	636	281	LKT4284-29ARY	\$2,523	\$2,562	\$2,806	\$2,973	\$3,014	\$3,186	
36	96	29	636	281	LKT3696-29ARY	\$2,452	\$2,490	\$2,730	\$2,899	\$2,938	\$3,108	
36	84	29	648	281	LKT3684-29ARY	\$2,204	\$2,239	\$2,448	\$2,644	\$2,677	\$2,826	

Laminate Tables "LKT" Models



Eased Edge (R3)



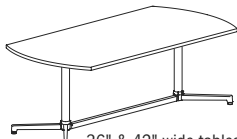
Reverse Bevel Edge (K9)

Features:

- price reflects complete table - top and base
- ships KD in multiple cartons
- one piece top
- model includes adjustable glide

Options:

- specify power/charging option, see below for options and upcharges



36" & 42" wide tables have single column base



top shape

To Order Specify

1 Laminate Model #	2 Edge Detail	3 Laminate Selection	3a PVC Edge Color	4 Electrical	5 Metal Color
Laminate (LKT)	See Edge Detail Options	See Laminate Selection	See PVC Edge Color Options	N None CT2 Dual Power Center Top CU2 Dual Power Underside CT2U1 Dual Power Center Top with Underside (See chart on next page)	See Metal Finish Color Options

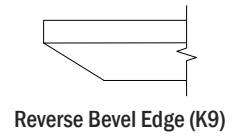
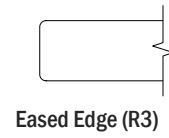
Model Number Breakdown

LKT4896-29ARY					
LK	T	4896	29	AR	Y
LOK	Laminate	48" x 96"	Height	Arc Rectangular Top Shape	Y base

Description

Arc Rectangular Table with Y Base at Working Height (continued)

Veneer Tables "LKV" Models



VENEER	D	W	H	CTN WT	CU FT	1 Model	Eased Edge (R3)		Reverse Bevel Edge (K9)	
							Flat Cut	Double Cut	Flat Cut	Double Cut
	48	96	29	218	105	LKV4896-29ARY	\$4,403	\$4,741	\$4,711	\$5,028
	48	84	29	333	83	LKV4884-29ARY	\$3,972	\$4,264	\$4,261	\$4,533
	42	96	29	169	83	LKV4296-29ARY	\$4,464	\$4,820	\$4,865	\$5,182
	42	84	29	636	281	LKV4284-29ARY	\$3,796	\$4,100	\$4,137	\$4,406
	36	96	29	636	281	LKV3696-29ARY	\$3,310	\$3,573	\$3,606	\$3,841
	36	84	29	648	281	LKV3684-29ARY	\$3,049	\$3,293	\$3,323	\$3,537

Electrical Options and Upcharges

CT2	84 - 96 wide
Dual Power Center Top - Black	CT2BL - add \$1,490
Dual Power Center Top - White	CT2WH - add \$1,490
CU1	
Single Power Underside - Black	CU1-1C - add \$592
Single Power Underside with Wireless Charging - Black	CU1-1CW - add \$1,371
CT2U1	
Dual Power Center Top - Black with Single Underside	CT2U1-BL - add \$1,813
Dual Power Center Top - White with Single Underside	CT2U1-WH - add \$1,813
Dual Power Center Top - Black with Wireless Charging	CT2U1-BLW2 - add \$2,592
Dual Power Center Top - White with Wireless Charging	CT2U1-WHW2 - add \$2,592

Note: Order power infeed that best fits application

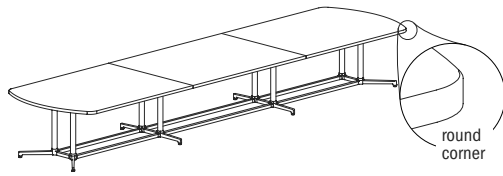
To Order Specify

1 Veneer Model #	2 Edge Detail	3 Wood Species	4 Wood Finish	5 Electrical	6 Metal Color
Veneer (LKV)	See Edge Detail Options	Flat Cut CH1 Cherry MA1 Maple WA1 Walnut BO1 Black Oak	See Flat Cut Wood Finish Options	N None CT2 Dual Power Center Top CU2 Dual Power Underside CT2U1 Dual Power Center Top with Underside (See chart above)	See Metal Finish Color Options
		Double Cut DC1 Double Cut	See Double Cut Wood Finish Options		

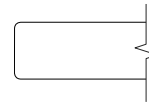
LOK - CONFERENCE

Description

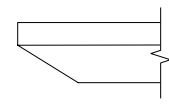
Rounded Arc Rectangular 3pc Table with Y Base at Working Height



Laminate Tables
"LKT" Models



Eased Edge (R3)



Reverse Bevel Edge (K9)

LAMINATE	D	W	H	CTN WT	CU FT	① Model	Standard			Graded In		
							Tier 1	Tier 2	Tier 3	Tier 1	Tier 2	Tier 3
	60	240	29	648	281	LKT60240-29ARRY	\$9,650	\$9,807	\$10,798	\$10,327	\$10,486	\$11,192
60	216	29	593	253	LKT60216-29ARRY	\$8,159	\$8,304	\$9,194	\$8,808	\$8,953	\$9,589	
54	240	29	575	254	LKT54240-29ARRY	\$7,634	\$7,777	\$8,670	\$8,278	\$8,422	\$9,058	
54	216	29	529	229	LKT54216-29ARRY	\$6,824	\$6,954	\$7,755	\$7,442	\$7,572	\$8,145	
48	240	29	548	228	LKT48240-29ARRY	\$7,376	\$7,506	\$8,298	\$7,987	\$8,115	\$8,683	
48	216	29	486	206	LKT48216-29ARRY	\$6,836	\$6,952	\$7,666	\$7,428	\$7,541	\$8,051	

Features:

- price reflects complete table - top and base
- ships KD in multiple cartons
- three piece top
- model includes adjustable glide

Options:

- specify power/charging option, see below for options and upcharges



top shape

LOK - CONFERENCE

To Order Specify

① Laminate Model #	② Edge Detail	③ Laminate Selection	④ PVC Edge Color	⑤ Electrical	⑥ Metal Color
Laminate (LKT)	See Edge Detail Options	See Laminate Selection	See PVC Edge Color Options	N None CT6 Six Power Center Top CU2 Dual Power Underside CT6U2 Six Power Center Top with Underside (See chart on next page)	See Metal Finish Color Options

Model Number Breakdown

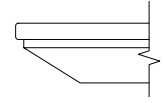
LKT60240-29ARRY						
LK	T	60240	29	AR	R	Y
LOK	Laminate	60" x 240"	Height	Arc Rectangular Top Shape	Rounded Corner	Y base

Description

Rounded Arc Rectangular 3pc Table with Y Base at Working Height (continued)

Veneer Tables "LKV" Models

Solid Surface Tables "LKS" Models



Reverse Bevel Edge (S7)

	D	W	H	CTN WT	CU FT	① Model	Veneer		Solid Surface		Standard
							Flat Cut	Double Cut	Flat Cut	Double Cut	
VENEER	60	240	29	648	281	LKV60240-29ARRY	\$15,024	\$16,225	\$16,376	\$17,439	--
	60	216	29	593	253	LKV60216-29ARRY	\$13,148	\$14,200	\$14,330	\$15,263	--
	54	240	29	575	254	LKV54240-29ARRY	\$12,533	\$13,600	\$13,152	\$14,164	--
	54	216	29	529	229	LKV54216-29ARRY	\$11,117	\$12,061	\$11,687	\$12,582	--
	48	240	29	548	228	LKV48240-29ARRY	\$11,911	\$12,849	\$12,471	\$13,360	--
	48	216	29	486	206	LKV48216-29ARRY	\$10,912	\$11,742	\$11,429	\$12,214	--
SOLID SURFACE	60	240	29	648	281	LKS60240-29ARRY	--	--	--	--	\$34,314
	60	216	29	593	253	LKS60216-29ARRY	--	--	--	--	\$30,951
	54	240	29	575	254	LKS54240-29ARRY	--	--	--	--	\$31,064
	54	216	29	529	229	LKS54216-29ARRY	--	--	--	--	\$27,577
	48	240	29	548	228	LKS48240-29ARRY	--	--	--	--	\$28,182
	48	216	29	486	206	LKS48216-29ARRY	--	--	--	--	\$25,368

Electrical Options and Upcharges

	216 - 240 wide
CT6	
Six Power Center Top - Black	CT6BL - add \$4,016
Six Power Center Top - White	CT6WH - add \$4,016
CU2	
Dual Power Underside - Black	CU2-1C - add \$1,052
Dual Power Underside with 4 Wireless Charging - Black	CU2-1CW - add \$2,660
CT6U2	
Six Power Center Top - Black with Dual Underside	CT6U2-BL - add \$4,665
Six Power Center Top - White with Dual Underside	CT6U2-WH - add \$4,665
Six Power Center Top - Black with Dual Underside with 4 Wireless Charging	CT6U2-BLW2 - add \$6,223
Six Power Center Top - White with Dual Underside with 4 Wireless Charging	CT6U2-WHW2 - add \$6,223

LOK - CONFERENCE

Note: Order power infeed that best fits application

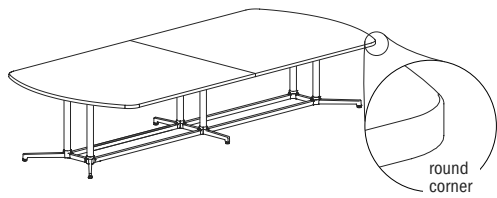
To Order Specify

① Veneer Model #	② Edge Detail	③ Wood Species	④ Wood Finish	⑤ Electrical	⑥ Metal Color
Veneer (LKV)	See Edge Detail Options	Flat Cut CH1 Cherry MA1 Maple WA1 Walnut BO1 Black Oak	See Flat Cut Wood Finish Options	N None CT6 Six Power Center Top CU2 Dual Power Underside CT6U2 Six Power Center Top with Underside (See chart above)	See Metal Finish Color Options
		Double Cut DC1 Double Cut	See Double Cut Wood Finish Options		

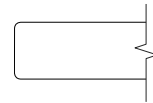
① Solid Surface Model #	② Top Surface Selection	③ Electrical	④ Metal Color
Solid Surface (LKS)	See Solid Surface Top Surface Selection Options	N None CT6 Six Power Center Top CU2 Dual Power Underside CT6U2 Six Power Center Top with Underside (See chart above)	See Metal Finish Color Options

Description

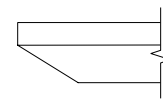
Rounded Arc Rectangular 2pc Table with Y Base at Working Height



Laminate Tables "LKT" Models



Eased Edge (R3)



Reverse Bevel Edge (K9)

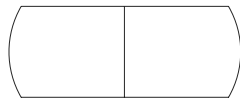
LAMINATE	D	W	H	CTN WT	CU FT	Model	Standard			Graded In		
							Tier 1	Tier 2	Tier 3	Tier 1	Tier 2	Tier 3
	60	192	29	507	226	LKT60192-29ARRY	\$6,748	\$6,875	\$7,667	\$7,365	\$7,492	\$8,056
60	168	29	453	198	LKT60168-29ARRY	\$6,268	\$6,381	\$7,075	\$6,857	\$6,969	\$7,465	
60	144	29	333	169	LKT60144-29ARRY	\$5,711	\$5,806	\$6,401	\$6,267	\$6,364	\$6,788	
60	120	29	330	143	LKT60120-29ARRY	\$5,144	\$5,223	\$5,720	\$5,673	\$5,753	\$6,106	
54	192	29	454	204	LKT54192-29ARRY	\$6,512	\$6,627	\$7,342	\$7,104	\$7,218	\$7,728	
54	168	29	360	178	LKT54168-29ARRY	\$5,799	\$5,900	\$6,525	\$6,364	\$6,465	\$6,910	
54	144	29	357	154	LKT54144-29ARRY	\$5,272	\$5,358	\$5,893	\$5,812	\$5,896	\$6,280	
54	120	29	308	130	LKT54120-29ARRY	\$4,831	\$4,902	\$5,349	\$5,343	\$5,415	\$5,732	
48	192	29	416	183	LKT48192-29ARRY	\$6,333	\$6,436	\$7,071	\$6,897	\$6,999	\$7,451	
48	168	29	369	161	LKT48168-29ARRY	\$5,135	\$5,223	\$5,780	\$5,676	\$5,764	\$6,162	
48	144	29	327	139	LKT48144-29ARRY	\$4,756	\$4,833	\$5,310	\$5,276	\$5,353	\$5,691	
48	120	29	285	116	LKT48120-29ARRY	\$4,298	\$4,363	\$4,762	\$4,795	\$4,858	\$5,143	
48	108	29	263	105	LKT48108-29ARRY	\$3,751	\$3,808	\$4,167	\$4,236	\$4,293	\$4,548	

Features:

- price reflects complete table - top and base
- ships KD in multiple cartons
- two piece top
- model includes adjustable glide

Options:

- specify power/charging option, see below for options and upcharges



top shape

Electrical Options and Upcharges

	108 wide	120 - 192 wide
CT2		
Dual Power Center Top - Black	CT2BL - add \$1,490	n/a
Dual Power Center Top - White	CT2WH - add \$1,490	n/a
CU1		
Single Power Underside - Black	CU1-1C - add \$592	CU1-1C - add \$688
Single Power Underside with Wireless Charging - Black	CU1-1CW - add \$1,371	CU1-1CW - add \$1,440
CT2U1		
Dual Power Center Top - Black with Underside	CT2U1-BL - add \$1,813	n/a
Dual Power Center Top - White with Underside	CT2U1-WH - add \$1,813	n/a
Dual Power Center Top - Black with Wireless Charging	CT2U1-BLW2 - add \$2,592	n/a
Dual Power Center Top - White with Wireless Charging	CT2U1-WHW2 - add \$2,592	n/a

Note: Order power infeed that best fits application.

	108 wide	120 - 192 wide
CT4U1		
Four Power Center Top with Single Underside - Black	n/a	CT4U1-BL - add \$3,169
Four Power Center Top with Single Underside - White	n/a	CT4U1-WH - add \$3,169
Four Power Center Top - Black with Underside & Wireless Charging	n/a	CT4U1-BLW2 - add \$3,928
Four Power Center Top - White with Underside & Wireless Charging	n/a	CT4U1-WHW2 - add \$3,928
CT4		
Four Power Center Top - Black	n/a	CT4BL - add \$2,775
Four Power Center Top - White	n/a	CT4WH - add \$2,775

To Order Specify

1 Laminate Model #	2 Edge Detail	3 Laminate Selection	3a PVC Edge Color	4 Electrical	5 Metal Color
Laminate (LKT)	See Edge Detail Options	See Laminate Selection	See PVC Edge Color Options	N None CT2 Dual Power Center Top CU2 Dual Power Underside CT2U1 Dual Power Center Top with Underside CT4U2 Four Power Center Top with Underside CT4 Four Power Center Top (See chart above)	See Metal Finish Color Options

Model Number Breakdown

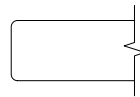
LKT60192-29ARRY						
LK	T	60192	29	AR	R	Y
LOK	Laminate	60" x 192"	Height	Arc Rectangular Top Shape	Rounded Corner	Y base

Description

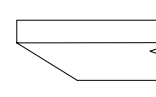
Rounded Arc Rectangular 2pc Table with Y Base at Working Height (continued)

Veneer Tables "LKV" Models

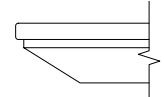
Solid Surface Tables "LKS" Models



Eased Edge (R3)



Reverse Bevel Edge (K9)



Reverse Bevel Edge (S7)

	D	W	H	CTN WT	CU FT	① Model	Veneer		Solid Surface		Standard
							Flat Cut	Double Cut	Flat Cut	Double Cut	
VENEER	60	192	29	507	226	LKV60192-29ARRY	\$10,521	\$11,363	\$11,468	\$12,213	--
	60	168	29	453	198	LKV60168-29ARRY	\$9,639	\$10,410	\$10,508	\$11,190	--
	60	144	29	333	169	LKV60144-29ARRY	\$8,671	\$9,364	\$9,451	\$10,064	--
	60	120	29	330	143	LKV60120-29ARRY	\$7,767	\$8,387	\$8,464	\$9,015	--
	54	192	29	454	204	LKV54192-29ARRY	\$9,748	\$10,529	\$10,626	\$11,315	--
	54	168	29	360	178	LKV54168-29ARRY	\$8,779	\$9,482	\$9,568	\$10,191	--
	54	144	29	357	154	LKV54144-29ARRY	\$7,877	\$8,507	\$8,586	\$9,145	--
	54	120	29	308	130	LKV54120-29ARRY	\$7,120	\$7,688	\$7,762	\$8,263	--
	48	192	29	416	183	LKV48192-29ARRY	\$9,669	\$10,397	\$10,145	\$10,833	--
	48	168	29	385	161	LKV48168-29ARRY	\$7,827	\$8,453	\$8,260	\$8,849	--
	48	144	29	327	139	LKV48144-29ARRY	\$7,153	\$7,682	\$7,544	\$8,044	--
	48	120	29	285	116	LKV48120-29ARRY	\$6,391	\$6,827	\$6,745	\$7,154	--
	48	108	29	263	105	LKV48108-29ARRY	\$5,391	\$5,821	\$5,877	\$6,257	--
	SOLID SURFACE	60	192	29	507	226	LKS60192-29ARRY	--	--	--	--
60		168	29	453	198	LKS60168-29ARRY	--	--	--	--	\$22,789
60		144	29	333	169	LKS60144-29ARRY	--	--	--	--	\$19,712
60		120	29	330	143	LKS60120-29ARRY	--	--	--	--	\$21,751
54		192	29	454	204	LKS54192-29ARRY	--	--	--	--	\$23,523
54		168	29	360	178	LKS54168-29ARRY	--	--	--	--	\$20,743
54		144	29	357	154	LKS54144-29ARRY	--	--	--	--	\$17,973
54		120	29	308	130	LKS54120-29ARRY	--	--	--	--	\$15,403
48		192	29	416	183	LKS48192-29ARRY	--	--	--	--	\$22,187
48		168	29	369	161	LKS48168-29ARRY	--	--	--	--	\$18,653
48		144	29	327	139	LKS48144-29ARRY	--	--	--	--	\$16,341
48		120	29	285	116	LKS48120-29ARRY	--	--	--	--	\$13,998
48		108	29	263	105	LKS48108-29ARRY	--	--	--	--	\$12,941

To Order Specify

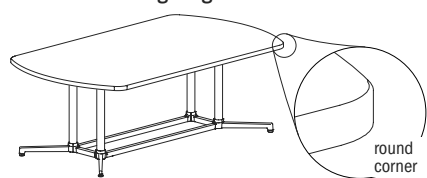
① Veneer Model #	② Edge Detail	③ Wood Species	④ Wood Finish	⑤ Electrical	⑥ Metal Color
Veneer (LKV)	See Edge Detail Options	Flat Cut CH1 Cherry MA1 Maple WA1 Walnut BO1 Black Oak	See Flat Cut Wood Finish Options	N None CT2 Dual Power Center Top CU2 Dual Power Underside CT2U1 Dual Power Center Top with Underside CT4U2 Four Power Center Top with Underside CT4 Four Power Center Top (See chart on previous page)	See Metal Finish Color Options
		Double Cut DC1 Double Cut	④ Wood Finish See Double Cut Wood Finish Options		

① Solid Surface Model #	② Top Surface Selection	③ Electrical	④ Metal Color
Solid Surface (LKS)	See Solid Surface Top Surface Selection Options	N None CT2 Dual Power Center Top CU2 Dual Power Underside CT2U1 Dual Power Center Top with Underside	See Metal Finish Color Options

LOK - CONFERENCE

Description

Rounded Arc Rectangular Table with Y Base at Working Height



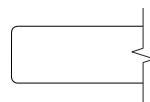
48" wide tables have double column base

D W H CTN WT CU FT **1 Model**

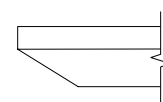
D	W	H	CTN WT	CU FT	1 Model
48	96	29	218	105	LKT4896-29ARRY
48	84	29	333	83	LKT4884-29ARRY
42	96	29	169	83	LKT4296-29ARRY
42	84	29	174	72	LKT4284-29ARRY
36	96	29	156	72	LKT3696-29ARRY
36	84	29	152	64	LKT3684-29ARRY

LAMINATE

Laminate Tables "LKT" Models



Eased Edge (R3)



Reverse Bevel Edge (K9)

Standard		Graded In		Standard		Graded In		
Tier 1	Tier 2	Tier 3	Tier 1	Tier 2	Tier 3	Tier 1	Tier 2	Tier 3
\$3,163	\$3,213	\$3,532	\$3,634	\$3,685	\$3,914	\$3,235	\$3,283	\$3,481
\$3,011	\$3,057	\$3,334	\$3,470	\$3,518	\$3,716	\$2,973	\$3,014	\$3,186
\$2,452	\$2,490	\$2,730	\$2,899	\$2,938	\$3,108	\$2,644	\$2,677	\$2,826
\$2,204	\$2,239	\$2,448	\$2,644	\$2,677	\$2,826			

Features:

- price reflects complete table - top and base
- ships KD in multiple cartons
- one piece top
- model includes adjustable glide

Options:

- specify power/charging option, see below for options and upcharges



36" & 42" wide tables have single column base



top shape

LOK - CONFERENCE

To Order Specify

1 Laminate Model #	2 Edge Detail	3 Laminate Selection	3a PVC Edge Color	4 Electrical	5 Metal Color
Laminate (LKT)	See Edge Detail Options	See Laminate Selection	See PVC Edge Color Options	N None CT2 Dual Power Center Top CU2 Dual Power Underside CT2U1 Dual Power Center Top with Underside (See chart on next page)	See Metal Finish Color Options

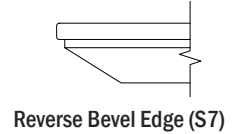
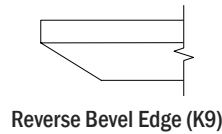
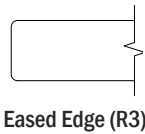
Model Number Breakdown

LKT4896-29ARRY						
LK	T	4896	29	AR	R	Y
LOK	Laminate	48" x 96"	Height	Arc Rectangular Top Shape	Rounded Corner	Y base

Description

Rounded Arc Rectangular Table with Y Base at Working Height (continued)

Veneer Tables "LKV" Models Solid Surface Tables "LKS" Models



	D	W	H	CTN WT	CU FT	① Model	Veneer Tables "LKV" Models		Solid Surface Tables "LKS" Models		
							Flat Cut	Double Cut	Flat Cut	Double Cut	Standard
VENEER	48	96	29	218	105	LKV4896-29ARRY	\$4,403	\$4,741	\$4,711	\$5,028	--
	48	84	29	333	83	LKV4884-29ARRY	\$3,972	\$4,264	\$4,261	\$4,533	--
	42	96	29	169	83	LKV4296-29ARRY	\$4,464	\$4,820	\$4,865	\$5,182	--
	42	84	29	174	72	LKV4284-29ARRY	\$3,796	\$4,100	\$4,137	\$4,406	--
	36	96	29	156	72	LKV3696-29ARRY	\$3,310	\$3,573	\$3,606	\$3,841	--
	36	84	29	152	64	LKV3684-29ARRY	\$3,049	\$3,293	\$3,323	\$3,537	--
SOLID SURFACE	48	96	29	218	105	LKS4896-29ARRY	--	--	--	--	\$10,283
	48	84	29	333	73	LKS4884-29ARRY	--	--	--	--	\$9,077
	42	96	29	169	83	LKS4296-29ARRY	--	--	--	--	\$8,544
	42	84	29	174	72	LKS4284-29ARRY	--	--	--	--	\$7,566
	36	96	29	156	72	LKS3696-29ARRY	--	--	--	--	\$7,398
	36	84	29	152	64	LKS3684-29ARRY	--	--	--	--	\$6,674

Electrical Options and Upcharges

CT2	84 - 96 wide
Dual Power Center Top - Black	CT2BL - add \$1,490
Dual Power Center Top - White	CT2WH - add \$1,490
CU1	
Single Power Underside - Black	CU1-1C - add \$592
Single Power Underside with Wireless Charging - Black	CU1-1CW - add \$1,371
CT2U1	
Dual Power Center Top - Black with Single Underside	CT2U1-BL - add \$1,813
Dual Power Center Top - White with Single Underside	CT2U1-WH - add \$1,813
Dual Power Center Top - Black with Wireless Charging	CT2U1-BLW2 - add \$2,592
Dual Power Center Top - White with Wireless Charging	CT2U1-WHW2 - add \$2,592

Note: Order power infeed that best fits application

To Order Specify

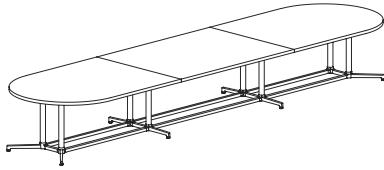
① Veneer Model #	② Edge Detail	③ Wood Species	④ Wood Finish	⑤ Electrical	⑥ Metal Color
Veneer (LKV)	See Edge Detail Options	Flat Cut CH1 Cherry MA1 Maple WA1 Walnut BO1 Black Oak	See Flat Cut Wood Finish Options	N None CT2 Dual Power Center Top CU2 Dual Power Underside CT2U1 Dual Power Center Top with Underside (See chart above)	See Metal Finish Color Options
		Double Cut DC1 Double Cut	See Double Cut Wood Finish Options		

① Solid Surface Model #	② Top Surface Selection	③ Electrical	④ Metal Color
Solid Surface (LKS)	See Solid Surface Top Surface Selection Options	N None CT2 Dual Power Center Top CU2 Dual Power Underside CT2U1 Dual Power Center Top with Underside (See chart above)	See Metal Finish Color Options

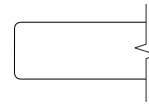
LOK - CONFERENCE

Description

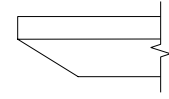
Racetrack 3pc Table with Y Base at Working Height



Laminate Tables
"LKT" Models



Eased Edge (R3)



Reverse Bevel Edge (K9)

LAMINATE	D	W	H	CTN WT	CU FT	Model	Eased Edge (R3)			Reverse Bevel Edge (K9)		
							Standard	Graded In		Standard	Graded In	
							Tier 1	Tier 2	Tier 3	Tier 1	Tier 2	Tier 3
	60	240	29	636	281	LKT60240-29RKY	\$9,650	\$9,807	\$10,798	\$10,327	\$10,486	\$11,192
	60	216	29	584	253	LKT60216-29RKY	\$8,159	\$8,304	\$9,194	\$8,808	\$8,953	\$9,589
	54	240	29	561	254	LKT54240-29RKY	\$7,634	\$7,777	\$8,670	\$8,278	\$8,422	\$9,058
	54	216	29	515	229	LKT54216-29RKY	\$6,781	\$6,910	\$7,713	\$7,401	\$7,529	\$8,101
	48	240	29	517	228	LKT48240-29RKY	\$6,856	\$6,982	\$7,776	\$7,467	\$7,595	\$8,159
	48	216	29	474	206	LKT48216-29RKY	\$6,436	\$6,551	\$7,266	\$7,025	\$7,142	\$7,650

Features:

- price reflects complete table - top and base
- ships KD in multiple cartons
- three piece top
- model includes adjustable glide

Options:

- specify power/charging option, see below for options and upcharges



top shape

LOK - CONFERENCE

To Order Specify

1 Laminate Model #	2 Edge Detail	3 Laminate Selection	3a PVC Edge Color	4 Electrical	5 Metal Color
Laminate (LKT)	See Edge Detail Options	See Laminate Selection	See PVC Edge Color Options	N None CT6 Six Power Center Top CU2 Dual Power Underside CT6U2 Six Power Center Top with Underside (See chart on next page)	See Metal Finish Color Options

Model Number Breakdown

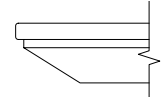
LKT60240-29RKY					
LK	T	60240	29	RK	Y
LOK	Laminate	60" x 240"	Height	Racetrack Top Shape	Y base

Description

Racetrack 3pc Table with Y Base at Working Height (continued)

Veneer Tables "LKV" Models

Solid Surface Tables "LKS" Models



Reverse Bevel Edge (S7)

	D	W	H	CTN WT	CU FT	1 Model	Flat Cut	Double Cut	Flat Cut	Double Cut	Standard
VENEER	60	240	29	636	281	LKV60240-29RKY	\$15,024	\$16,225	\$16,376	\$17,439	--
	60	216	29	584	253	LKV60216-29RKY	\$13,148	\$14,200	\$14,330	\$15,263	--
	54	240	29	561	254	LKV54240-29RKY	\$12,533	\$13,600	\$13,152	\$14,164	--
	54	216	29	515	229	LKV54216-29RKY	\$11,054	\$11,998	\$11,624	\$12,521	--
	48	240	29	517	228	LKV48240-29RKY	\$11,155	\$12,093	\$11,716	\$12,604	--
	48	216	29	474	206	LKV48216-29RKY	\$10,341	\$11,172	\$10,857	\$11,643	--
SOLID SURFACE	60	240	29	636	281	LKS60240-29RKY	--	--	--	--	\$34,314
	60	216	29	584	253	LKS60216-29RKY	--	--	--	--	\$30,951
	54	240	29	561	254	LKS54240-29RKY	--	--	--	--	\$31,064
	54	216	29	515	229	LKS54216-29RKY	--	--	--	--	\$27,515
	48	240	29	517	228	LKS48240-29RKY	--	--	--	--	\$27,426
	48	216	29	474	206	LKS48216-29RKY	--	--	--	--	\$24,798

Electrical Options and Upcharges

	216 - 240 wide
CT6	
Six Power Center Top - Black	CT6BL - add \$4,016
Six Power Center Top - White	CT6WH - add \$4,016
CU2	
Dual Power Underside - Black	CU2-1C - add \$1,052
Dual Power Underside with 4 Wireless Charging - Black	CU2-1CW - add \$2,660
CT6U2	
Six Power Center Top - Black with Dual Underside	CT6U2-BL - add \$4,665
Six Power Center Top - White with Dual Underside	CT6U2-WH - add \$4,665
Six Power Center Top - Black with Dual Underside with 4 Wireless Charging	CT6U2-BLW2 - add \$6,223
Six Power Center Top - White with Dual Underside with 4 Wireless Charging	CT6U2-WHW2 - add \$6,223

LOK - CONFERENCE

Note: Order power infeed that best fits application

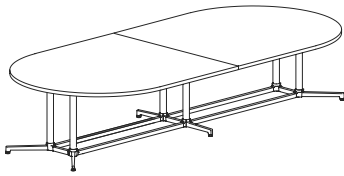
To Order Specify

1 Veneer Model #	2 Edge Detail	3 Wood Species	4 Wood Finish	5 Electrical	6 Metal Color
Veneer (LKV)	See Edge Detail Options	Flat Cut CH1 Cherry MA1 Maple WA1 Walnut BO1 Black Oak	See Flat Cut Wood Finish Options	N None CT6 Six Power Center Top CU2 Dual Power Underside CT6U2 Six Power Center Top with Underside (See chart above)	See Metal Finish Color Options
		Double Cut DC1 Double Cut	See Double Cut Wood Finish Options		

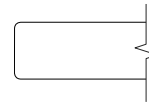
1 Solid Surface Model #	2 Top Surface Selection	3 Electrical	4 Metal Color
Solid Surface (LKS)	See Solid Surface Top Surface Selection Options	N None CT6 Six Power Center Top CU2 Dual Power Underside CT6U2 Six Power Center Top with Underside (See chart above)	See Metal Finish Color Options

Description

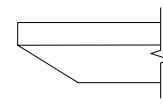
Racetrack 2pc Table with Y Base at Working Height



Laminate Tables
"LKT" Models



Eased Edge (R3)



Reverse Bevel Edge (K9)

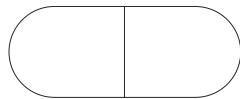
LAMINATE	D	W	H	CTN WT	CU FT	Model	Standard			Graded In		
							Tier 1	Tier 2	Tier 3	Tier 1	Tier 2	Tier 3
							60	192	29	511	226	LKT60192-29RKY
60	168	29	449	198	LKT60168-29RKY	\$6,268	\$6,381	\$7,075	\$6,857	\$6,969	\$7,465	
60	144	29	315	169	LKT60144-29RKY	\$5,578	\$5,673	\$6,267	\$6,135	\$6,230	\$6,656	
60	120	29	313	143	LKT60120-29RKY	\$5,073	\$5,154	\$5,650	\$5,603	\$5,682	\$6,036	
54	192	29	439	204	LKT54192-29RKY	\$6,417	\$6,533	\$7,246	\$7,006	\$7,123	\$7,632	
54	168	29	343	178	LKT54168-29RKY	\$5,715	\$5,816	\$6,440	\$6,279	\$6,379	\$6,825	
54	144	29	294	154	LKT54144-29RKY	\$5,186	\$5,274	\$5,810	\$5,725	\$5,813	\$6,193	
54	120	29	294	130	LKT54120-29RKY	\$4,761	\$4,832	\$5,280	\$5,272	\$5,345	\$5,663	
48	192	29	403	183	LKT48192-29RKY	\$5,510	\$5,611	\$6,248	\$6,073	\$6,177	\$6,628	
48	168	29	356	161	LKT48168-29RKY	\$5,011	\$5,101	\$5,655	\$5,552	\$5,643	\$6,038	
48	144	29	314	139	LKT48144-29RKY	\$4,551	\$4,629	\$5,107	\$5,072	\$5,148	\$5,489	
48	120	29	273	116	LKT48120-29RKY	\$4,220	\$4,286	\$4,683	\$4,715	\$4,782	\$5,065	
48	108	29	250	105	LKT48108-29RKY	\$3,710	\$3,768	\$4,127	\$4,194	\$4,253	\$4,508	

Features:

- price reflects complete table - top and base
- ships KD in multiple cartons
- two piece top
- model includes adjustable glide

Options:

- specify power/charging option, see below for options and upcharges



top shape

Electrical Options and Upcharges

	108 wide	120 - 192 wide
CT2		
Dual Power Center Top - Black	CT2BL - add \$1,490	n/a
Dual Power Center Top - White	CT2WH - add \$1,490	n/a
CU1		
Single Power Underside - Black	CU1-1C - add \$592	CU1-1C - add \$688
Single Power Underside with Wireless Charging - Black	CU1-1CW - add \$1,371	CU1-1CW - add \$1,440
CT2U1		
Dual Power Center Top - Black with Underside	CT2U1-BL - add \$1,813	n/a
Dual Power Center Top - White with Underside	CT2U1-WH - add \$1,813	n/a
Dual Power Center Top - Black with Wireless Charging	CT2U1-BLW2 - add \$2,592	n/a
Dual Power Center Top - White with Wireless Charging	CT2U1-WHW2 - add \$2,592	n/a

Note: Order power infeed that best fits application.

	108 wide	120 - 192 wide
CT4U1		
Four Power Center Top with Single Underside - Black	n/a	CT4U1-BL - add \$3,169
Four Power Center Top with Single Underside - White	n/a	CT4U1-WH - add \$3,169
Four Power Center Top - Black with Underside & Wireless Charging	n/a	CT4U1-BLW2 - add \$3,928
Four Power Center Top - White with Underside & Wireless Charging	n/a	CT4U1-WHW2 - add \$3,928
CT4		
Four Power Center Top - Black	n/a	CT4BL - add \$2,775
Four Power Center Top - White	n/a	CT4WH - add \$2,775

To Order Specify

1 Laminate Model #	2 Edge Detail	3 Laminate Selection	3a PVC Edge Color	4 Electrical	5 Metal Color
Laminate (LKT)	See Edge Detail Options	See Laminate Selection	See PVC Edge Color Options	N None CT2 Dual Power Center Top CU2 Dual Power Underside CT2U1 Dual Power Center Top with Underside CT4U2 Four Power Center Top with Underside CT4 Four Power Center Top (See chart above)	See Metal Finish Color Options

Model Number Breakdown

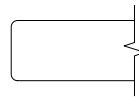
LKT60192-29RKY					
LK	T	60192	29	RK	Y
LOK	Laminate	60" x 192"	Height	Racetrack Top Shape	Y base

Description

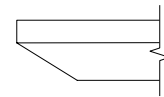
Racetrack 2pc Table with Y
Base at Working Height
(continued)

Veneer Tables
"LKV" Models

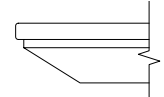
Solid Surface Tables
"LKS" Models



Eased Edge (R3)



Reverse Bevel Edge (K9)



Reverse Bevel Edge (S7)

	D	W	H	CTN WT	CU FT	① Model	Veneer		Solid Surface		Standard
							Flat Cut	Double Cut	Flat Cut	Double Cut	
VENEER	60	192	29	511	226	LKV60192-29RKY	\$11,475	\$12,393	\$12,505	\$13,318	--
	60	168	29	449	198	LKV60168-29RKY	\$9,639	\$10,410	\$10,508	\$11,190	--
	60	144	29	315	169	LKV60144-29RKY	\$8,483	\$9,162	\$9,247	\$9,848	--
	60	120	29	313	143	LKV60120-29RKY	\$7,669	\$8,282	\$8,360	\$8,904	--
	54	192	29	439	204	LKV54192-29RKY	\$9,613	\$10,381	\$10,476	\$11,158	--
	54	168	29	343	178	LKV54168-29RKY	\$8,658	\$9,352	\$9,438	\$10,050	--
	54	144	29	294	154	LKV54144-29RKY	\$7,762	\$8,380	\$8,458	\$9,008	--
	54	120	29	294	130	LKV54120-29RKY	\$7,024	\$7,584	\$7,656	\$8,153	--
	48	192	29	403	183	LKV48192-29RKY	\$8,516	\$9,244	\$8,992	\$9,676	--
	48	168	29	356	161	LKV48168-29RKY	\$7,656	\$8,285	\$8,090	\$8,680	--
	48	144	29	314	139	LKV48144-29RKY	\$6,876	\$7,407	\$7,270	\$7,767	--
	48	120	29	273	116	LKV48120-29RKY	\$6,289	\$6,723	\$6,640	\$7,048	--
	48	108	29	250	105	LKV48108-29RKY	\$5,340	\$5,764	\$5,818	\$6,197	--
	SOLID SURFACE	60	192	29	511	226	LKS60192-29RKY	--	--	--	--
60		168	29	449	198	LKS60168-29RKY	--	--	--	--	\$22,789
60		144	29	315	169	LKS60144-29RKY	--	--	--	--	\$19,526
60		120	29	313	143	LKS60120-29RKY	--	--	--	--	\$21,657
54		192	29	439	204	LKS54192-29RKY	--	--	--	--	\$23,390
54		168	29	343	178	LKS54168-29RKY	--	--	--	--	\$20,626
54		144	29	294	154	LKS54144-29RKY	--	--	--	--	\$17,857
54		120	29	294	130	LKS54120-29RKY	--	--	--	--	\$15,310
48		192	29	403	183	LKS48192-29RKY	--	--	--	--	\$21,033
48		168	29	356	161	LKS48168-29RKY	--	--	--	--	\$18,484
48		144	29	314	139	LKS48144-29RKY	--	--	--	--	\$16,067
48		120	29	273	116	LKS48120-29RKY	--	--	--	--	\$13,893
48		108	29	250	105	LKS48108-29RKY	--	--	--	--	\$12,890

To Order Specify

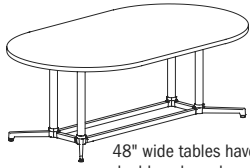
① Veneer Model #	② Edge Detail	③ Wood Species	④ Wood Finish	⑤ Electrical	⑥ Metal Color
Veneer (LKV)	See Edge Detail Options	Flat Cut CH1 Cherry MA1 Maple WA1 Walnut BO1 Black Oak	See Flat Cut Wood Finish Options	N None CT2 Dual Power Center Top CU2 Dual Power Underside CT2U1 Dual Power Center Top with Underside CT4U2 Four Power Center Top with Underside CT4 Four Power Center Top (See chart on previous page)	See Metal Finish Color Options
		Double Cut DC1 Double Cut	④ Wood Finish See Double Cut Wood Finish Options		

① Solid Surface Model #	② Top Surface Selection	③ Electrical	④ Metal Color
Solid Surface (LKS)	See Solid Surface Top Surface Selection Options	N None CT2 Dual Power Center Top CU2 Dual Power Underside CT2U1 Dual Power Center Top with Underside	See Metal Finish Color Options

LOK - CONFERENCE

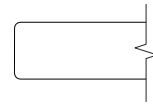
Description

Racetrack Table with Y Base at Working Height

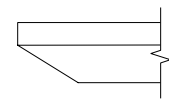


48" wide tables have double column base

Laminate Tables "LKT" Models



Eased Edge (R3)



Reverse Bevel Edge (K9)

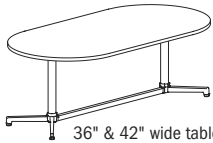
LAMINATE	D	W	H	CTN WT	CU FT	Model	Standard		Graded In		Standard		Graded In	
							Tier 1	Tier 2	Tier 3	Tier 1	Tier 2	Tier 3		
							LKT4896-29RKY	\$3,163	\$3,213	\$3,532	\$3,634	\$3,685	\$3,914	
LKT4884-29RKY	\$2,775	\$2,820	\$3,098	\$3,235	\$3,283	\$3,481								
LKT4296-29RKY	\$3,011	\$3,057	\$3,334	\$3,470	\$3,518	\$3,716								
LKT4284-29RKY	\$2,523	\$2,562	\$2,806	\$2,973	\$3,014	\$3,186								
LKT3696-29RKY	\$2,412	\$2,450	\$2,689	\$2,859	\$2,897	\$3,068								
LKT3684-29RKY	\$2,204	\$2,239	\$2,448	\$2,644	\$2,677	\$2,826								

Features:

- price reflects complete table - top and base
- ships KD in multiple cartons
- one piece top
- model includes adjustable glide

Options:

- specify power/charging option, see below for options and upcharges



36" & 42" wide tables have single column base



top shape

LOK - CONFERENCE

To Order Specify

1 Laminate Model #	2 Edge Detail	3 Laminate Selection	3a PVC Edge Color	4 Electrical	5 Metal Color
Laminate (LKT)	See Edge Detail Options	See Laminate Selection	See PVC Edge Color Options	N None CT2 Dual Power Center Top CU2 Dual Power Underside CT2U1 Dual Power Center Top with Underside (See chart on next page)	See Metal Finish Color Options

Model Number Breakdown

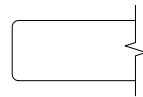
LKT4896-29RKY					
LK	T	4896	29	RK	Y
LOK	Laminate	48" x 96"	Height	Racetrack Top Shape	Y base

Description

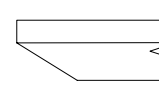
Racetrack Table with Y Base at Working Height (continued)

Veneer Tables "LKV" Models

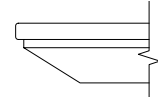
Solid Surface Tables "LKS" Models



Eased Edge (R3)



Reverse Bevel Edge (K9)



Reverse Bevel Edge (S7)

	D	W	H	CTN WT	CU FT	① Model	Veneer Tables "LKV" Models		Solid Surface Tables "LKS" Models		
							Flat Cut	Double Cut	Flat Cut	Double Cut	Standard
VENEER	48	96	29	207	105	LKV4896-29RKY	\$4,403	\$4,741	\$4,711	\$5,028	--
	48	84	29	315	83	LKV4884-29RKY	\$3,972	\$4,264	\$4,261	\$4,533	--
	42	96	29	161	83	LKV4296-29RKY	\$4,464	\$4,820	\$4,865	\$5,182	--
	42	84	29	161	72	LKV4284-29RKY	\$3,796	\$4,100	\$4,137	\$4,406	--
	36	96	29	150	72	LKV3696-29RKY	\$3,260	\$3,521	\$3,554	\$3,784	--
	36	84	29	146	64	LKV3684-29RKY	\$3,049	\$3,293	\$3,323	\$3,537	--
SOLID SURFACE	48	96	29	207	105	LKS4896-29RKY	--	--	--	--	\$10,283
	48	84	29	315	83	LKS4884-29RKY	--	--	--	--	\$9,077
	42	96	29	161	83	LKS4296-29RKY	--	--	--	--	\$8,544
	42	84	29	161	72	LKS4284-29RKY	--	--	--	--	\$7,566
	36	96	29	150	72	LKS3696-29RKY	--	--	--	--	\$7,347
	36	84	29	146	64	LKS3684-29RKY	--	--	--	--	\$6,674

Electrical Options and Upcharges

CT2	84 - 96 wide
Dual Power Center Top - Black	CT2BL - add \$1,490
Dual Power Center Top - White	CT2WH - add \$1,490
CU1	
Single Power Underside - Black	CU1-1C - add \$592
Single Power Underside with Wireless Charging - Black	CU1-1CW - add \$1,371
CT2U1	
Dual Power Center Top - Black with Single Underside	CT2U1-BL - add \$1,813
Dual Power Center Top - White with Single Underside	CT2U1-WH - add \$1,813
Dual Power Center Top - Black with Wireless Charging	CT2U1-BLW2 - add \$2,592
Dual Power Center Top - White with Wireless Charging	CT2U1-WHW2 - add \$2,592

Note: Order power infeed that best fits application

To Order Specify

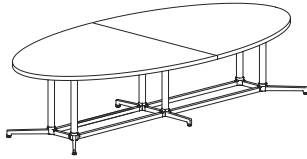
① Veneer Model #	② Edge Detail	③ Wood Species	④ Wood Finish	⑤ Electrical	⑥ Metal Color
Veneer (LKV)	See Edge Detail Options	Flat Cut CH1 Cherry MA1 Maple WA1 Walnut BO1 Black Oak	See Flat Cut Wood Finish Options	N None CT2 Dual Power Center Top CU2 Dual Power Underside CT2U1 Dual Power Center Top with Underside (See chart above)	See Metal Finish Color Options
		Double Cut DC1 Double Cut	④ Wood Finish See Double Cut Wood Finish Options		

① Solid Surface Model #	② Top Surface Selection	③ Electrical	④ Metal Color
Solid Surface (LKS)	See Solid Surface Top Surface Selection Options	N None CT2 Dual Power Center Top CU2 Dual Power Underside CT2U1 Dual Power Center Top with Underside (See chart above)	See Metal Finish Color Options

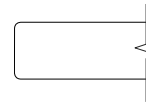
LOK - CONFERENCE

Description

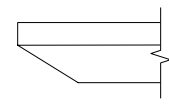
Oval 2pc Table with Y Base at Working Height



Laminate Tables "LKT" Models



Eased Edge (R3)



Reverse Bevel Edge (K9)

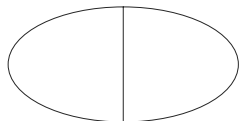
LAMINATE	D	W	H	CTN WT	CU FT	Model	Eased Edge (R3)			Reverse Bevel Edge (K9)		
							Standard	Graded In		Standard	Graded In	
							Tier 1	Tier 2	Tier 3	Tier 1	Tier 2	Tier 3
	60	120	29	294	130	LKT60120-290VY	\$5,032	\$5,111	\$5,607	\$5,560	\$5,641	\$5,994
	54	108	29	222	117	LKT54108-290VY	\$3,942	\$4,006	\$4,412	\$4,440	\$4,505	\$4,794

Features:

- price reflects complete table - top and base
- ships KD in multiple cartons
- two piece top
- model includes adjustable glide

Options:

- specify power/charging option, see below for options and upcharges



top shape

LOK - CONFERENCE

To Order Specify

1 Laminate Model #	2 Edge Detail	3 Laminate Selection	3a PVC Edge Color	4 Electrical	5 Metal Color
Laminate (LKT)	See Edge Detail Options	See Laminate Selection	See PVC Edge Color Options	N None CT2 Dual Power Center Top CU2 Dual Power Underside CT2U1 Dual Power Center Top with Underside CT4U2 Four Power Center Top with Underside CT4 Four Power Center Top (See chart above)	See Metal Finish Color Options

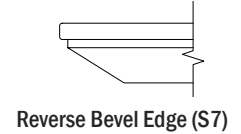
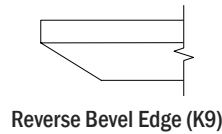
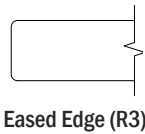
Model Number Breakdown

LKT60120-290VY					
LK	T	60120	29	OV	Y
LOK	Laminate	60" x 120"	Height	Oval Top Shape	Y base

Description

Oval 2pc Table with Y Base at Working Height (continued)

Veneer Tables "LKV" Models Solid Surface Tables "LKS" Models



	D	W	H	CTN WT	CU FT	① Model	Veneer Tables		Solid Surface Tables		Standard
							Flat Cut	Double Cut	Flat Cut	Double Cut	
VENEER	60	120	29	294	130	LKV60120-290VY	\$7,613	\$8,221	\$8,297	\$8,836	--
	54	108	29	222	117	LKV54108-290VY	\$5,914	\$6,358	\$6,269	\$6,685	--
SOL. SURF.	60	120	29	294	130	LKS60120-290VY	--	--	--	--	\$21,598
	54	108	29	222	117	LKS54108-290VY	--	--	--	--	\$17,435

Electrical Options and Upcharges

	108 wide	120 - 192 wide
CT2		
Dual Power Center Top - Black	CT2BL - add \$1,490	n/a
Dual Power Center Top - White	CT2WH - add \$1,490	n/a
CU1		
Single Power Underside - Black	CU1-1C - add \$592	CU1-1C - add \$688
Single Power Underside with Wireless Charging - Black	CU1-1CW - add \$1,371	CU1-1CW - add \$1,440
CT2U1		
Dual Power Center Top - Black with Underside	CT2U1-BL - add \$1,813	n/a
Dual Power Center Top - White with Underside	CT2U1-WH - add \$1,813	n/a
Dual Power Center Top - Black with Wireless Charging	CT2U1-BLW2 - add \$2,592	n/a
Dual Power Center Top - White with Wireless Charging	CT2U1-WHW2 - add \$2,592	n/a

	108 wide	120 - 192 wide
CT4U1		
Four Power Center Top with Single Underside - Black	n/a	CT4U1-BL - add \$3,169
Four Power Center Top with Single Underside - White	n/a	CT4U1-WH - add \$3,169
Four Power Center Top - Black with Underside & Wireless Charging	n/a	CT4U1-BLW2 - add \$3,928
Four Power Center Top - White with Underside & Wireless Charging	n/a	CT4U1-WHW2 - add \$3,928
CT4		
Four Power Center Top - Black	n/a	CT4BL - add \$2,775
Four Power Center Top - White	n/a	CT4WH - add \$2,775

Note: Order power infed that best fits application, see page 408.

To Order Specify

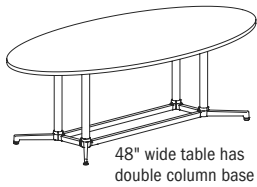
① Veneer Model #	② Edge Detail	③ Wood Species	④ Wood Finish	⑤ Electrical	⑥ Metal Color
Veneer (LKV)	See Edge Detail Options	Flat Cut CH1 Cherry MA1 Maple WA1 Walnut BO1 Black Oak	See Flat Cut Wood Finish Options	N None CT2 Dual Power Center Top CU2 Dual Power Underside CT2U1 Dual Power Center Top with Underside CT4U2 Four Power Center Top with Underside CT4 Four Power Center Top (See chart on previous page)	See Metal Finish Color Options
		Double Cut DC1 Double Cut	④ Wood Finish See Double Cut Wood Finish Options		

① Solid Surface Model #	② Top Surface Selection	③ Electrical	④ Metal Color
Solid Surface (LKS)	See Solid Surface Top Surface Selection Options	N None CT2 Dual Power Center Top CU2 Dual Power Underside CT2U1 Dual Power Center Top with Underside CT4U2 Four Power Center Top with Underside CT4 Four Power Center Top (See chart on previous page)	See Metal Finish Color Options

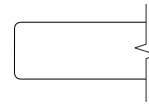
LOK - CONFERENCE

Description

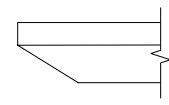
Oval Table with Y Base at Working Height



Laminate Tables "LKT" Models



Eased Edge (R3)



Reverse Bevel Edge (K9)

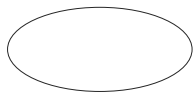
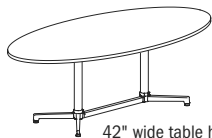
LAMINATE	D	W	H	CTN WT	CU FT	Model	Eased Edge (R3)			Reverse Bevel Edge (K9)		
							Standard	Graded In		Standard	Graded In	
							Tier 1	Tier 2	Tier 3	Tier 1	Tier 2	Tier 3
	48	96	29	186	105	LKT4896-290VY	\$3,091	\$3,143	\$3,460	\$3,564	\$3,615	\$3,842
	42	84	29	147	72	LKT4284-290VY	\$2,523	\$2,562	\$2,806	\$2,973	\$3,014	\$3,186

Features:

- price reflects complete table - top and base
- ships KD in multiple cartons
- one piece top
- model includes adjustable glide

Options:

- specify power/charging option, see below for options and upcharges



top shape

LOK - CONFERENCE

To Order Specify

1 Laminate Model #	2 Edge Detail	3 Laminate Selection	3a PVC Edge Color	4 Electrical	5 Metal Color
Laminate (LKT)	See Edge Detail Options	See Laminate Selection	See PVC Edge Color Options	N None CT2 Dual Power Center Top CU2 Dual Power Underside CT2U1 Dual Power Center Top with Underside (See chart on next page)	See Metal Finish Color Options

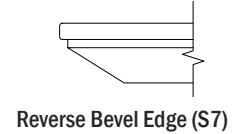
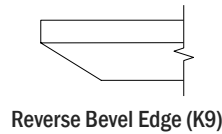
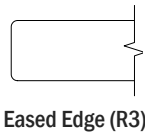
Model Number Breakdown

LKT4896-290VY					
LK	T	4896	29	OV	Y
LOK	Laminate	48" x 96"	Height	Oval Top Shape	Y base

Description

Oval Table with Y Base at Working Height (continued)

Veneer Tables "LKV" Models	Solid Surface Tables "LKS" Models
----------------------------	-----------------------------------



	D	W	H	CTN WT	CU FT	① Model	Veneer Tables "LKV" Models		Solid Surface Tables "LKS" Models		
							Flat Cut	Double Cut	Flat Cut	Double Cut	Standard
VENEER	48	96	29	186	105	LKV4896-290VY	\$4,312	\$4,649	\$4,620	\$4,936	--
	42	84	29	147	72	LKV4284-290VY	\$3,796	\$4,100	\$4,137	\$4,406	--
SOL. SURF.	48	96	29	186	105	LKS4896-290VY	--	--	--	--	\$10,192
	42	84	29	147	72	LKS4284-290VY	--	--	--	--	\$7,566

Electrical Options and Upcharges

CT2	84 - 96 wide
Dual Power Center Top - Black	CT2BL - add \$1,490
Dual Power Center Top - White	CT2WH - add \$1,490
CU1	
Single Power Underside - Black	CU1-1C - add \$592
Single Power Underside with Wireless Charging - Black	CU1-1CW - add \$1,371
CT2U1	
Dual Power Center Top - Black with Single Underside	CT2U1-BL - add \$1,813
Dual Power Center Top - White with Single Underside	CT2U1-WH - add \$1,813
Dual Power Center Top - Black with Wireless Charging	CT2U1-BLW2 - add \$2,592
Dual Power Center Top - White with Wireless Charging	CT2U1-WHW2 - add \$2,592

Note: Order power infeed that best fits application

To Order Specify

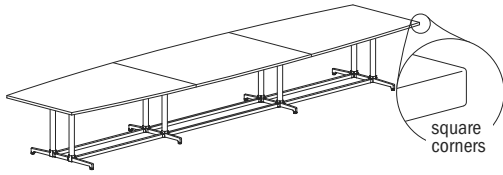
① Veneer Model #	② Edge Detail	③ Wood Species	④ Wood Finish	⑤ Electrical	⑥ Metal Color
Veneer (LKV)	See Edge Detail Options	Flat Cut CH1 Cherry MA1 Maple WA1 Walnut BO1 Black Oak	See Flat Cut Wood Finish Options	N None CT2 Dual Power Center Top CU2 Dual Power Underside CT2U1 Dual Power Center Top with Underside (See chart above)	See Metal Finish Color Options
		Double Cut DC1 Double Cut	④ Wood Finish See Double Cut Wood Finish Options		

① Solid Surface Model #	② Top Surface Selection	③ Electrical	④ Metal Color
Solid Surface (LKS)	See Solid Surface Top Surface Selection Options	N None CT2 Dual Power Center Top CU2 Dual Power Underside CT2U1 Dual Power Center Top with Underside (See chart above)	See Metal Finish Color Options

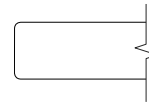
LOK - CONFERENCE

Description

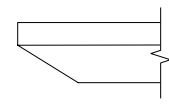
Boat 3pc Table with T Base at Working Height



Laminate Tables "LKT" Models



Eased Edge (R3)



Reverse Bevel Edge (K9)

LAMINATE	D	W	H	CTN WT	CU FT	Model	Standard			Graded In		
							Tier 1	Tier 2	Tier 3	Tier 1	Tier 2	Tier 3
	60	240	29	636	281	LKT60240-29BTT	\$9,960	\$10,122	\$11,109	\$10,639	\$10,800	\$11,505
60	216	29	584	253	LKT60216-29BTT	\$8,490	\$8,633	\$9,526	\$9,139	\$9,284	\$9,918	
54	240	29	586	254	LKT54240-29BTT	\$8,034	\$8,177	\$9,068	\$8,679	\$8,823	\$9,458	
54	216	29	538	229	LKT54216-29BTT	\$7,555	\$7,686	\$8,486	\$8,176	\$8,304	\$8,878	
48	240	29	534	228	LKT48240-29BTT	\$7,653	\$7,782	\$8,576	\$8,265	\$8,392	\$8,958	
48	216	29	538	206	LKT48216-29BTT	\$6,770	\$6,886	\$7,600	\$7,360	\$7,475	\$7,984	

Features:

- price reflects complete table - top and base
- ships KD in multiple cartons
- three piece top
- model includes adjustable glide

Options:

- specify power/charging option, see below for options and upcharges



top shape

LOK - CONFERENCE

To Order Specify

1 Laminate Model #	2 Edge Detail	3 Laminate Selection	3a PVC Edge Color	4 Electrical	5 Metal Color
Laminate (LKT)	See Edge Detail Options	See Laminate Selection	See PVC Edge Color Options	N None CT6 Six Power Center Top CU2 Dual Power Underside CT6U2 Six Power Center Top with Underside (See chart on next page)	See Metal Finish Color Options

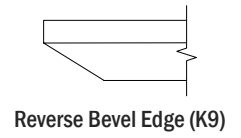
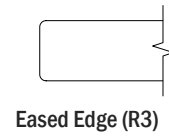
Model Number Breakdown

LKT60240-29BTT					
LK	T	60240	29	BT	T
LOK	Laminate	60" x 240"	Height	Boat Top Shape	T base

Description

Boat 3pc Table with T Base
at Working Height
(continued)

Veneer Tables
"LKV" Models



VENEER	D	W	H	CTN WT	CU FT	1 Model	Eased Edge (R3)		Reverse Bevel Edge (K9)	
							Flat Cut	Double Cut	Flat Cut	Double Cut
	60	240	29	636	281	LKV60240-29BTT	\$15,492	\$16,732	\$16,886	\$17,984
	60	216	29	584	253	LKV60216-29BTT	\$13,636	\$14,727	\$14,863	\$15,830
	54	240	29	586	254	LKV54240-29BTT	\$13,125	\$14,188	\$13,743	\$14,754
	54	216	29	538	229	LKV54216-29BTT	\$12,179	\$13,125	\$12,747	\$13,643
	48	240	29	534	228	LKV48240-29BTT	\$12,313	\$13,251	\$12,876	\$13,762
	48	216	29	538	206	LKV48216-29BTT	\$10,815	\$11,648	\$11,334	\$12,120

Electrical Options and Upcharges

	216 - 240 wide
CT6	
Six Power Center Top - Black	CT6BL - add \$4,016
Six Power Center Top - White	CT6WH - add \$4,016
CU2	
Dual Power Underside - Black	CU2-1C - add \$1,052
Dual Power Underside with 4 Wireless Charging - Black	CU2-1CW - add \$2,660
CT6U2	
Six Power Center Top - Black with Dual Underside	CT6U2-BL - add \$4,665
Six Power Center Top - White with Dual Underside	CT6U2-WH - add \$4,665
Six Power Center Top - Black Dual Underside with 4 Wireless Charging	CT6U2-BLW2 - add \$6,223
Six Power Center Top - White Dual Underside with 4 Wireless Charging	CT6U2-WHW2 - add \$6,223

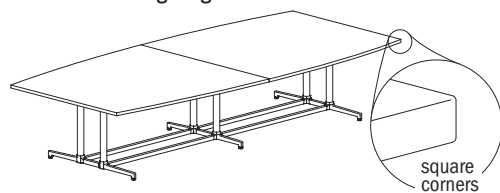
Note: Order power infeed that best fits application

To Order Specify

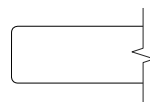
1 Veneer Model #	2 Edge Detail	3 Wood Species	4 Wood Finish	5 Electrical	6 Metal Color
Veneer (LKV)	See Edge Detail Options	Flat Cut CH1 Cherry MA1 Maple WA1 Walnut BO1 Black Oak	See Flat Cut Wood Finish Options	N None CT6 Six Power Center Top CU2 Dual Power Underside CT6U2 Six Power Center Top with Underside (See chart above)	See Metal Finish Color Options
		Double Cut DC1 Double Cut	4 Wood Finish See Double Cut Wood Finish Options		

Description

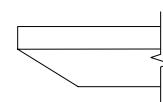
Boat 2pc Table with T Base at Working Height



Laminate Tables "LKT" Models



Eased Edge (R3)



Reverse Bevel Edge (K9)

LAMINATE	D	W	H	CTN WT	CU FT	Model	Standard			Graded In		
							Tier 1	Tier 2	Tier 3	Tier 1	Tier 2	Tier 3
	60	192	29	511	226	LKT60192-29BTT	\$6,937	\$7,067	\$7,857	\$7,554	\$7,682	\$8,248
60	168	29	449	198	LKT60168-29BTT	\$6,474	\$6,586	\$7,280	\$7,061	\$7,173	\$7,667	
60	144	29	395	169	LKT60144-29BTT	\$5,973	\$6,068	\$6,663	\$6,532	\$6,627	\$7,050	
60	120	29	342	143	LKT60120-29BTT	\$5,296	\$5,375	\$5,872	\$5,825	\$5,904	\$6,257	
54	192	29	459	204	LKT54192-29BTT	\$6,601	\$6,718	\$7,431	\$7,192	\$7,307	\$7,815	
54	168	29	377	178	LKT54168-29BTT	\$5,979	\$6,081	\$6,704	\$6,546	\$6,645	\$7,091	
54	144	29	365	154	LKT54144-29BTT	\$5,508	\$5,596	\$6,129	\$6,048	\$6,134	\$6,514	
54	120	29	316	130	LKT54120-29BTT	\$4,934	\$5,006	\$5,453	\$5,444	\$5,517	\$5,835	
48	192	29	419	183	LKT48192-29BTT	\$5,760	\$5,863	\$6,499	\$6,325	\$6,427	\$6,879	
48	168	29	377	161	LKT48168-29BTT	\$5,355	\$5,444	\$6,001	\$5,896	\$5,986	\$6,384	
48	144	29	334	139	LKT48144-29BTT	\$4,912	\$4,989	\$5,468	\$5,431	\$5,508	\$5,849	
48	120	29	290	116	LKT48120-29BTT	\$4,414	\$4,478	\$4,875	\$4,910	\$4,975	\$5,258	
48	108	29	268	105	LKT48108-29BTT	\$3,739	\$3,796	\$4,154	\$4,222	\$4,280	\$4,536	

Features:

- price reflects complete table - top and base
- ships KD in multiple cartons
- two piece top
- model includes adjustable glide

Options:

- specify power/charging option, see below for options and upcharges



top shape

LOK - CONFERENCE

To Order Specify

1 Laminate Model #	2 Edge Detail	3 Laminate Selection	3a PVC Edge Color	4 Electrical	5 Metal Color
Laminate (LKT)	See Edge Detail Options	See Laminate Selection	See PVC Edge Color Options	N None CT2 Dual Power Center Top CU2 Dual Power Underside CT2U1 Dual Power Center Top with Underside CT4U2 Four Power Center Top with Underside CT4 Four Power Center Top (See chart on next page)	See Metal Finish Color Options

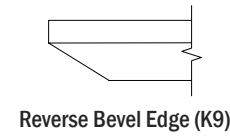
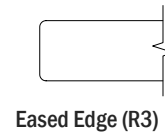
Model Number Breakdown

LKT60192-29BTT					
LK	T	60192	29	BT	T
LOK	Laminate	60" x 192"	Height	Boat Top Shape	T base

Description

Boat 2pc Table with T Base at Working Height (continued)

Veneer Tables "LKV" Models



D	W	H	CTN WT	CU FT	Model	Eased Edge (R3)		Reverse Bevel Edge (K9)		
						Flat Cut	Double Cut	Flat Cut	Double Cut	
60	192	29	511	226	LKV60192-29BTT	\$10,797	\$11,661	\$11,767	\$12,532	
60	168	29	449	198	LKV60168-29BTT	\$9,931	\$10,725	\$10,824	\$11,528	
60	144	29	395	169	LKV60144-29BTT	\$9,039	\$9,763	\$9,852	\$10,493	
60	120	29	342	143	LKV60120-29BTT	\$7,976	\$8,614	\$8,694	\$9,257	
VENEER	54	192	29	459	204	LKV54192-29BTT	\$9,875	\$10,667	\$10,766	\$11,463
	54	168	29	377	178	LKV54168-29BTT	\$9,031	\$9,755	\$9,844	\$10,484
	54	144	29	365	154	LKV54144-29BTT	\$8,202	\$8,859	\$8,942	\$9,521
	54	120	29	316	130	LKV54120-29BTT	\$7,259	\$7,839	\$7,911	\$8,423
	48	192	29	419	183	LKV48192-29BTT	\$8,868	\$9,596	\$9,343	\$10,029
	48	168	29	377	161	LKV48168-29BTT	\$8,131	\$8,758	\$8,563	\$9,156
	48	144	29	334	139	LKV48144-29BTT	\$7,363	\$7,893	\$7,756	\$8,254
	48	120	29	290	116	LKV48120-29BTT	\$6,546	\$6,981	\$6,899	\$7,306
	48	108	29	268	105	LKV48108-29BTT	\$5,374	\$5,804	\$5,857	\$6,237

Electrical Options and Upcharges

CT2	108 wide	120 - 192 wide
Dual Power Center Top - Black	CT2BL - add \$1,490	n/a
Dual Power Center Top - White	CT2WH - add \$1,490	n/a
CU1		
Single Power Underside - Black	CU1-1C - add \$592	CU1-1C - add \$688
Single Power Underside with Wireless Charging - Black	CU1-1CW - add \$1,371	CU1-1CW - add \$1,440
CT2U1		
Dual Power Center Top - Black with Underside	CT2U1-BL - add \$1,813	n/a
Dual Power Center Top - White with Underside	CT2U1-WH - add \$1,813	n/a
Dual Power Center Top - Black with Wireless Charging	CT2U1-BLW2 - add \$2,592	n/a
Dual Power Center Top - White with Wireless Charging	CT2U1-WHW2 - add \$2,592	n/a

CT4U1	108 wide	120 - 192 wide
Four Power Center Top with Single Underside - Black	n/a	CT4U1-BL - add \$3,169
Four Power Center Top with Single Underside - White	n/a	CT4U1-WH - add \$3,169
Four Power Center Top - Black with Underside & Wireless Charging	n/a	CT4U1-BLW2 - add \$3,928
Four Power Center Top - White with Underside & Wireless Charging	n/a	CT4U1-WHW2 - add \$3,928
CT4		
Four Power Center Top - Black	n/a	CT4BL - add \$2,775
Four Power Center Top - White	n/a	CT4WH - add \$2,775

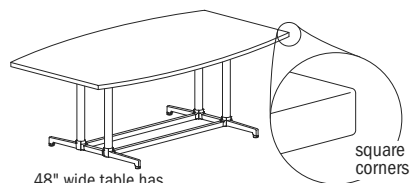
Note: Order power infed that best fits application

To Order Specify

1 Veneer Model #	2 Edge Detail	3 Wood Species	4 Wood Finish	5 Electrical	6 Metal Color
Veneer (LKV)	See Edge Detail Options	Flat Cut CH1 Cherry MA1 Maple WA1 Walnut BO1 Black Oak	See Flat Cut Wood Finish Options	N None CT2 Dual Power Center Top CU2 Dual Power Underside CT2U1 Dual Power Center Top with Underside CT4U2 Four Power Center Top with Underside CT4 Four Power Center Top	See Metal Finish Color Options
		Double Cut DC1 Double Cut	See Double Cut Wood Finish Options		

Description

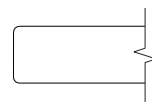
Boat Table with T Base at Working Height



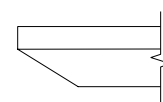
48" wide table has double column base

square corners

Laminate Tables "LKT" Models



Eased Edge (R3)



Reverse Bevel Edge (K9)

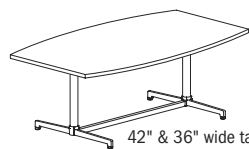
LAMINATE	D	W	H	CTN WT	CU FT	Model	Eased Edge (R3)		Reverse Bevel Edge (K9)			
							Standard	Graded In	Standard	Graded In		
							Tier 1	Tier 2	Tier 3	Tier 1	Tier 2	Tier 3
	48	96	29	219	83	LKT4896-29BTT	\$3,144	\$3,194	\$3,512	\$3,616	\$3,668	\$3,894
	48	84	29	198	83	LKT4884-29BTT	\$2,791	\$2,838	\$3,114	\$3,252	\$3,297	\$3,497
	42	96	29	177	73	LKT4296-29BTT	\$2,854	\$2,899	\$3,178	\$3,314	\$3,358	\$3,558
	42	84	29	158	72	LKT4284-29BTT	\$2,351	\$2,391	\$2,636	\$2,803	\$2,842	\$3,016
	36	96	29	156	72	LKT3696-29BTT	\$2,400	\$2,439	\$2,678	\$2,848	\$2,887	\$3,058
	36	84	29	146	64	LKT3684-29BTT	\$2,154	\$2,185	\$2,395	\$2,592	\$2,627	\$2,776

Features:

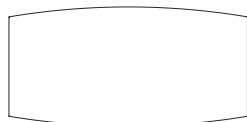
- price reflects complete table - top and base
- ships KD in multiple cartons
- one piece top
- model includes adjustable glide

Options:

- specify power/charging option, see below for options and upcharges



42" & 36" wide tables have single column base



top shape

LOK - CONFERENCE

To Order Specify

1 Laminate Model #	2 Edge Detail	3 Laminate Selection	3a PVC Edge Color	4 Electrical	5 Metal Color
Laminate (LKT)	See Edge Detail Options	See Laminate Selection	See PVC Edge Color Options	N None CT2 Dual Power Center Top CU2 Dual Power Underside CT2U1 Dual Power Center Top with Underside (See chart on next page)	See Metal Finish Color Options

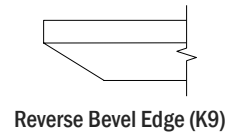
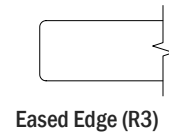
Model Number Breakdown

LKT4896-29BTT					
LK	T	4896	29	BT	T
LOK	Laminate	48" x 96"	Height	Boat Top Shape	T base

Description

Boat Table with T Base at Working Height (continued)

Veneer Tables "LKV" Models



D	W	H	CTN WT	CU FT	Model	Eased Edge (R3)		Reverse Bevel Edge (K9)	
						Flat Cut	Double Cut	Flat Cut	Double Cut
48	96	29	219	83	LKV4896-29BTT	\$4,378	\$4,715	\$4,687	\$5,005
48	84	29	198	83	LKV4884-29BTT	\$3,995	\$4,286	\$4,281	\$4,553
42	96	29	177	73	LKV4296-29BTT	\$4,266	\$4,608	\$4,649	\$4,951
	84	29	158	72	LKV4284-29BTT	\$3,586	\$3,871	\$3,908	\$4,164
36	96	29	156	72	LKV3696-29BTT	\$3,247	\$3,505	\$3,537	\$3,768
36	84	29	146	64	LKV3684-29BTT	\$2,987	\$3,224	\$3,255	\$3,466

Electrical Options and Upcharges

CT2	84 - 96 wide
Dual Power Center Top - Black	CT2BL - add \$1,490
Dual Power Center Top - White	CT2WH - add \$1,490
CU1	
Single Power Underside - Black	CU1-1C - add \$592
Single Power Underside with Wireless Charging - Black	CU1-1CW - add \$1,371
CT2U1	
Dual Power Center Top - Black with Single Underside	CT2U1-BL - add \$1,813
Dual Power Center Top - White with Single Underside	CT2U1-WH - add \$1,813
Dual Power Center Top - Black with Wireless Charging	CT2U1-BLW2 - add \$2,592
Dual Power Center Top - White with Wireless Charging	CT2U1-WHW2 - add \$2,592

Note: Order power infeed that best fits application

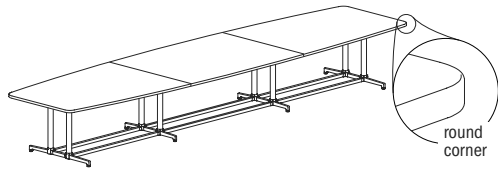
To Order Specify

1 Veneer Model #	2 Edge Detail	3 Wood Species	4 Wood Finish	5 Electrical	6 Metal Color
Veneer (LKV)	See Edge Detail Options	Flat Cut CH1 Cherry MA1 Maple WA1 Walnut BO1 Black Oak	See Flat Cut Wood Finish Options	N None CT2 Dual Power Center Top CU2 Dual Power Underside CT2U1 Dual Power Center Top with Underside (See chart above)	See Metal Finish Color Options
		Double Cut DC1 Double Cut	See Double Cut Wood Finish Options		

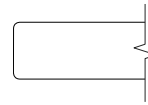
LOK - CONFERENCE

Description

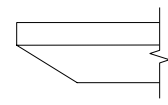
Rounded Boat 3pc Table with T Base at Working Height



Laminate Tables
"LKT" Models



Eased Edge (R3)



Reverse Bevel Edge (K9)

LAMINATE	D	W	H	CTN WT	CU FT	Model	Standard			Graded In		
							Tier 1	Tier 2	Tier 3	Tier 1	Tier 2	Tier 3
	60	240	29	636	281	LKT60240-29BTRT	\$9,960	\$10,122	\$11,109	\$10,639	\$10,800	\$11,505
60	216	29	584	253	LKT60216-29BTRT	\$8,490	\$8,633	\$9,526	\$9,139	\$9,284	\$9,918	
54	240	29	586	254	LKT54240-29BTRT	\$8,034	\$8,177	\$9,068	\$8,679	\$8,823	\$9,458	
54	216	29	538	229	LKT54216-29BTRT	\$7,555	\$7,686	\$8,486	\$8,176	\$8,304	\$8,878	
48	240	29	534	228	LKT48240-29BTRT	\$7,653	\$7,782	\$8,576	\$8,265	\$8,392	\$8,958	
48	216	29	538	206	LKT48216-29BTRT	\$6,770	\$6,886	\$7,600	\$7,360	\$7,475	\$7,984	

Features:

- price reflects complete table - top and base
- ships KD in multiple cartons
- three piece top
- model includes adjustable glide

Options:

- specify power/charging option, see below for options and upcharges



top shape

LOK - CONFERENCE

To Order Specify

1 Laminate Model #	2 Edge Detail	3 Laminate Selection	3a PVC Edge Color	4 Electrical	5 Metal Color
Laminate (LKT)	See Edge Detail Options	See Laminate Selection	See PVC Edge Color Options	N None CT6 Six Power Center Top CU2 Dual Power Underside CT6U2 Six Power Center Top with Underside (See chart on next page)	See Metal Finish Color Options

Model Number Breakdown

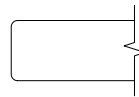
LKT60240-29BTRT						
LK	T	60240	29	BT	R	T
LOK	Laminate	60" x 240"	Height	Boat Top Shape	Rounded Corner	T base

Description

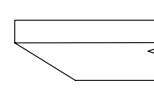
Rounded Boat 3pc Table with T Base at Working Height (continued)

Veneer Tables "LKV" Models

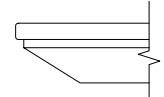
Solid Surface Tables "LKS" Models



Eased Edge (R3)



Reverse Bevel Edge (K9)



Reverse Bevel Edge (S7)

	D	W	H	CTN WT	CU FT	① Model	Veneer		Solid Surface		Standard
							Flat Cut	Double Cut	Flat Cut	Double Cut	
VENEER	60	240	29	636	281	LKV60240-29BTRT	\$15,492	\$16,732	\$16,886	\$17,984	--
	60	216	29	584	253	LKV60216-29BTRT	\$13,636	\$14,727	\$14,863	\$15,830	--
	54	240	29	586	254	LKV54240-29BTRT	\$13,125	\$14,188	\$13,743	\$14,754	--
	54	216	29	538	229	LKV54216-29BTRT	\$12,179	\$13,125	\$12,747	\$13,643	--
	48	240	29	534	228	LKV48240-29BTRT	\$12,313	\$13,251	\$12,876	\$13,762	--
	48	216	29	538	206	LKV48216-29BTRT	\$10,815	\$11,648	\$11,334	\$12,120	--
SOLID SURFACE	60	240	29	636	281	LKS60240-29BTRT	--	--	--	--	\$34,782
	60	216	29	584	253	LKS60216-29BTRT	--	--	--	--	\$31,437
	54	240	29	586	254	LKS54240-29BTRT	--	--	--	--	\$31,650
	54	216	29	538	229	LKS54216-29BTRT	--	--	--	--	\$28,639
	48	240	29	534	228	LKS48240-29BTRT	--	--	--	--	\$28,583
	48	216	29	538	206	LKS48216-29BTRT	--	--	--	--	\$25,273

Electrical Options and Upcharges

	216 - 240 wide
CT6	
Six Power Center Top - Black	CT6BL - add \$4,016
Six Power Center Top - White	CT6WH - add \$4,016
CU2	
Dual Power Underside - Black	CU2-1C - add \$1,052
Dual Power Underside with 4 Wireless Charging - Black	CU2-1CW - add \$2,660
CT6U2	
Six Power Center Top - Black with Dual Underside	CT6U2-BL - add \$4,665
Six Power Center Top - White with Dual Underside	CT6U2-WH - add \$4,665
Six Power Center Top - Black with Dual Underside with 4 Wireless Charging	CT6U2-BLW2 - add \$6,223
Six Power Center Top - White with Dual Underside with 4 Wireless Charging	CT6U2-WHW2 - add \$6,223

LOK - CONFERENCE

Note: Order power infeed that best fits application

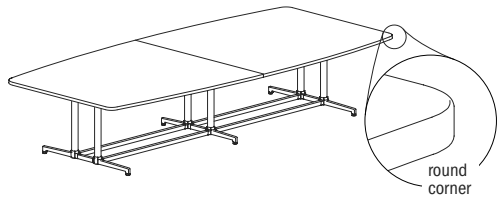
To Order Specify

① Veneer Model #	② Edge Detail	③ Wood Species	④ Wood Finish	⑤ Electrical	⑥ Metal Color
Veneer (LKV)	See Edge Detail Options	Flat Cut CH1 Cherry MA1 Maple WA1 Walnut BO1 Black Oak	See Flat Cut Wood Finish Options	N None CT6 Six Power Center Top CU2 Dual Power Underside CT6U2 Six Power Center Top with Underside (See chart above)	See Metal Finish Color Options
		Double Cut DC1 Double Cut	④ Wood Finish See Double Cut Wood Finish Options		

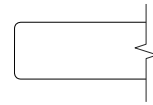
① Solid Surface Model #	② Top Surface Selection	③ Electrical	④ Metal Color
Solid Surface (LKS)	See Solid Surface Top Surface Selection Options	N None CT6 Six Power Center Top CU2 Dual Power Underside CT6U2 Six Power Center Top with Underside (See chart above)	See Metal Finish Color Options

Description

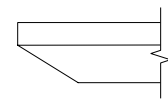
Rounded Boat 2pc Table with T Base at Working Height



Laminate Tables "LKT" Models



Eased Edge (R3)



Reverse Bevel Edge (K9)

LAMINATE	D	W	H	CTN WT	CU FT	Model	Standard			Graded In		
							Tier 1	Tier 2	Tier 3	Tier 1	Tier 2	Tier 3
	60	192	29	511	226	LKT60192-29BTRT	\$6,937	\$7,067	\$7,857	\$7,554	\$7,682	\$8,248
60	168	29	449	198	LKT60168-29BTRT	\$6,474	\$6,586	\$7,280	\$7,061	\$7,173	\$7,667	
60	144	29	395	169	LKT60144-29BTRT	\$5,973	\$6,068	\$6,663	\$6,532	\$6,627	\$7,050	
60	120	29	342	143	LKT60120-29BTRT	\$5,296	\$5,375	\$5,872	\$5,825	\$5,904	\$6,257	
54	192	29	459	204	LKT54192-29BTRT	\$6,601	\$6,718	\$7,431	\$7,192	\$7,307	\$7,815	
54	168	29	377	178	LKT54168-29BTRT	\$5,979	\$6,081	\$6,704	\$6,546	\$6,645	\$7,091	
54	144	29	365	154	LKT54144-29BTRT	\$5,508	\$5,596	\$6,129	\$6,048	\$6,134	\$6,514	
54	120	29	316	130	LKT54120-29BTRT	\$4,934	\$5,006	\$5,453	\$5,444	\$5,517	\$5,835	
48	192	29	419	183	LKT48192-29BTRT	\$5,760	\$5,863	\$6,499	\$6,325	\$6,427	\$6,879	
48	168	29	377	161	LKT48168-29BTRT	\$5,355	\$5,444	\$6,001	\$5,896	\$5,986	\$6,384	
48	144	29	334	139	LKT48144-29BTRT	\$4,912	\$4,989	\$5,468	\$5,431	\$5,508	\$5,849	
48	120	29	290	116	LKT48120-29BTRT	\$4,414	\$4,478	\$4,875	\$4,910	\$4,975	\$5,258	
48	108	29	268	105	LKT48108-29BTRT	\$3,739	\$3,796	\$4,154	\$4,222	\$4,280	\$4,536	

Features:

- price reflects complete table - top and base
- ships KD in multiple cartons
- two piece top
- model includes adjustable glide

Options:

- specify power/charging option, see below for options and upcharges

Electrical Options and Upcharges

	108 wide	120 - 192 wide
CT2		
Dual Power Center Top - Black	CT2BL - add \$1,490	n/a
Dual Power Center Top - White	CT2WH - add \$1,490	n/a
CU1		
Single Power Underside - Black	CU1-1C - add \$592	CU1-1C - add \$688
Single Power Underside with Wireless Charging - Black	CU1-1CW - add \$1,371	CU1-1CW - add \$1,440
CT2U1		
Dual Power Center Top - Black with Underside	CT2U1-BL - add \$1,813	n/a
Dual Power Center Top - White with Underside	CT2U1-WH - add \$1,813	n/a
Dual Power Center Top - Black with Wireless Charging	CT2U1-BLW2 - add \$2,592	n/a
Dual Power Center Top - White with Wireless Charging	CT2U1-WHW2 - add \$2,592	n/a

Note: Order power infeed that best fits application.

	108 wide	120 - 192 wide
CT4U1		
Four Power Center Top with Single Underside - Black	n/a	CT4U1-BL - add \$3,169
Four Power Center Top with Single Underside - White	n/a	CT4U1-WH - add \$3,169
Four Power Center Top - Black with Underside & Wireless Charging	n/a	CT4U1-BLW2 - add \$3,928
Four Power Center Top - White with Underside & Wireless Charging	n/a	CT4U1-WHW2 - add \$3,928
CT4		
Four Power Center Top - Black	n/a	CT4BL - add \$2,775
Four Power Center Top - White	n/a	CT4WH - add \$2,775



top shape

To Order Specify

1 Laminate Model #	2 Edge Detail	3 Laminate Selection	3a PVC Edge Color	4 Electrical	5 Metal Color
Laminate (LKT)	See Edge Detail Options	See Laminate Selection	See PVC Edge Color Options	N None CT2 Dual Power Center Top CU2 Dual Power Underside CT2U1 Dual Power Center Top with Underside CT4U2 Four Power Center Top with Underside CT4 Four Power Center Top (See chart above)	See Metal Finish Color Options

Model Number Breakdown

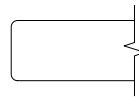
LKT60192-29BTRT						
LK	T	60192	29	BT	R	T
LOK	Laminate	60" x 192"	Height	Boat Top Shape	Rounded Corner	T base

Description

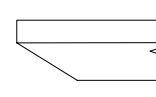
Rounded Boat 2pc Table with T Base at Working Height (continued)

Veneer Tables "LKV" Models

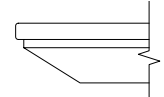
Solid Surface Tables "LKS" Models



Eased Edge (R3)



Reverse Bevel Edge (K9)



Reverse Bevel Edge (S7)

	D	W	H	CTN WT	CU FT	① Model	Veneer		Solid Surface		Standard	
							Flat Cut	Double Cut	Flat Cut	Double Cut		
VENEER	60	192	29	511	226	LKV60192-29BTRT	\$10,797	\$11,661	\$11,767	\$12,532	--	
	60	168	29	449	198	LKV60168-29BTRT	\$9,931	\$10,725	\$10,824	\$11,528	--	
	60	144	29	395	169	LKV60144-29BTRT	\$9,039	\$9,763	\$9,852	\$10,493	--	
	60	120	29	342	143	LKV60120-29BTRT	\$7,976	\$8,614	\$8,694	\$9,257	--	
	54	192	29	459	204	LKV54192-29BTRT	\$9,875	\$10,667	\$10,766	\$11,463	--	
	54	168	29	377	178	LKV54168-29BTRT	\$9,031	\$9,755	\$9,844	\$10,484	--	
	54	144	29	365	154	LKV54144-29BTRT	\$8,202	\$8,859	\$8,942	\$9,521	--	
	54	120	29	316	130	LKV54120-29BTRT	\$7,259	\$7,839	\$7,911	\$8,423	--	
	48	192	29	419	183	LKV48192-29BTRT	\$8,868	\$9,596	\$9,343	\$10,029	--	
	48	168	29	377	161	LKV48168-29BTRT	\$8,131	\$8,758	\$8,563	\$9,156	--	
	48	144	29	334	139	LKV48144-29BTRT	\$7,363	\$7,893	\$7,756	\$8,254	--	
	48	120	29	290	116	LKV48120-29BTRT	\$6,546	\$6,981	\$6,899	\$7,306	--	
	48	108	29	268	105	LKV48108-29BTRT	\$5,374	\$5,804	\$5,857	\$6,237	--	
	SOLID SURFACE	60	192	29	511	226	LKS60192-29BTRT	--	--	--	--	\$26,124
		60	168	29	449	198	LKS60168-29BTRT	--	--	--	--	\$23,083
		60	144	29	395	169	LKS60144-29BTRT	--	--	--	--	\$20,080
60		120	29	342	143	LKS60120-29BTRT	--	--	--	--	\$21,962	
54		192	29	459	204	LKS54192-29BTRT	--	--	--	--	\$23,651	
54		168	29	377	178	LKS54168-29BTRT	--	--	--	--	\$20,997	
54		144	29	365	154	LKS54144-29BTRT	--	--	--	--	\$18,297	
54		120	29	316	130	LKS54120-29BTRT	--	--	--	--	\$15,543	
48		192	29	419	183	LKS48192-29BTRT	--	--	--	--	\$21,386	
48		168	29	377	161	LKS48168-29BTRT	--	--	--	--	\$18,959	
48		144	29	334	139	LKS48144-29BTRT	--	--	--	--	\$16,552	
48		120	29	290	116	LKS48120-29BTRT	--	--	--	--	\$14,151	
48		108	29	268	105	LKS48108-29BTRT	--	--	--	--	\$12,927	

To Order Specify

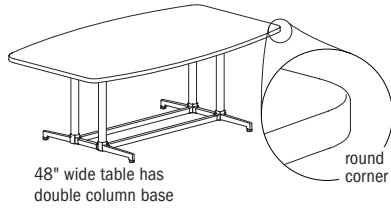
① Veneer Model #	② Edge Detail	③ Wood Species	④ Wood Finish	⑤ Electrical	⑥ Metal Color
Veneer (LKV)	See Edge Detail Options	Flat Cut CH1 Cherry MA1 Maple WA1 Walnut BO1 Black Oak	See Flat Cut Wood Finish Options	N None CT2 Dual Power Center Top CU2 Dual Power Underside CT2U1 Dual Power Center Top with Underside CT4U2 Four Power Center Top with Underside CT4 Four Power Center Top (See chart on previous page)	See Metal Finish Color Options
		Double Cut DC1 Double Cut	④ Wood Finish See Double Cut Wood Finish Options		

① Solid Surface Model #	② Top Surface Selection	③ Electrical	④ Metal Color
Solid Surface (LKS)	See Solid Surface Top Surface Selection Options	N None CT2 Dual Power Center Top CU2 Dual Power Underside CT2U1 Dual Power Center Top with Underside	See Metal Finish Color Options

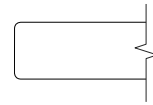
LOK - CONFERENCE

Description

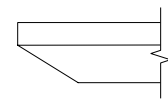
Rounded Boat Table with T Base at Working Height



Laminate Tables "LKT" Models



Eased Edge (R3)



Reverse Bevel Edge (K9)

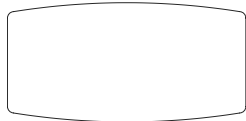
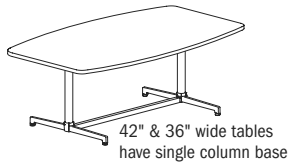
LAMINATE	D	W	H	CTN WT	CU FT	Model	Standard			Graded In		
							Tier 1	Tier 2	Tier 3	Tier 1	Tier 2	Tier 3
		48	96	29	219	83	LKT4896-29BTRT	\$3,144	\$3,194	\$3,512	\$3,616	\$3,668
	48	84	29	198	83	LKT4884-29BTRT	\$2,791	\$2,838	\$3,114	\$3,252	\$3,297	\$3,497
	42	96	29	177	73	LKT4296-29BTRT	\$2,854	\$2,899	\$3,178	\$3,314	\$3,358	\$3,558
	42	84	29	158	72	LKT4284-29BTRT	\$2,351	\$2,391	\$2,636	\$2,803	\$2,842	\$3,016
	36	96	29	156	72	LKT3696-29BTRT	\$2,400	\$2,439	\$2,678	\$2,848	\$2,887	\$3,058
	36	84	29	146	64	LKT3684-29BTRT	\$2,154	\$2,185	\$2,395	\$2,592	\$2,627	\$2,776

Features:

- price reflects complete table - top and base
- ships KD in multiple cartons
- one piece top
- model includes adjustable glide

Options:

- specify power/charging option, see below for options and upcharges



top shape

LOK - CONFERENCE

To Order Specify

1 Laminate Model #	2 Edge Detail	3 Laminate Selection	3a PVC Edge Color	4 Electrical	5 Metal Color
Laminate (LKT)	See Edge Detail Options	See Laminate Selection	See PVC Edge Color Options	N None CT2 Dual Power Center Top CU2 Dual Power Underside CT2U1 Dual Power Center Top with Underside (See chart on next page)	See Metal Finish Color Options

Model Number Breakdown

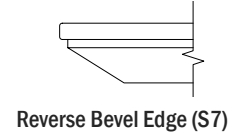
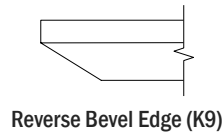
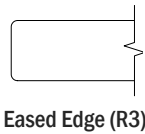
LKT4896-29BTRT						
LK	T	4896	29	BT	R	T
LOK	Laminate	48" x 96"	Height	Boat Top Shape	Rounded Corner	T base

Description

Rounded Boat Table with T Base at Working Height (continued)

Veneer Tables "LKV" Models

Solid Surface Tables "LKS" Models



	D	W	H	CTN WT	CU FT	① Model	Veneer Tables "LKV" Models		Solid Surface Tables "LKS" Models		
							Flat Cut	Double Cut	Flat Cut	Double Cut	Standard
VENEER	48	96	29	219	83	LKV4896-29BTRT	\$4,378	\$4,715	\$4,687	\$5,005	--
	48	84	29	198	83	LKV4884-29BTRT	\$3,995	\$4,286	\$4,281	\$4,553	--
	42	96	29	177	73	LKV4296-29BTRT	\$4,266	\$4,608	\$4,649	\$4,951	--
	42	84	29	158	72	LKV4284-29BTRT	\$3,586	\$3,871	\$3,908	\$4,164	--
	36	96	29	156	72	LKV3696-29BTRT	\$3,247	\$3,505	\$3,537	\$3,768	--
	36	84	29	146	64	LKV3684-29BTRT	\$2,987	\$3,224	\$3,255	\$3,466	--
SOLID SURFACE	48	96	29	219	83	LKS4896-29BTRT	--	--	--	--	\$10,261
	48	84	29	198	83	LKS4884-29BTRT	--	--	--	--	\$9,095
	42	96	29	177	73	LKS4296-29BTRT	--	--	--	--	\$8,348
	42	84	29	158	72	LKS4284-29BTRT	--	--	--	--	\$7,358
	36	96	29	156	72	LKS3696-29BTRT	--	--	--	--	\$7,335
	36	84	29	146	64	LKS3684-29BTRT	--	--	--	--	\$6,611

Electrical Options and Upcharges

CT2	84 - 96 wide
Dual Power Center Top - Black	CT2BL - add \$1,490
Dual Power Center Top - White	CT2WH - add \$1,490
CU1	
Single Power Underside - Black	CU1-1C - add \$592
Single Power Underside with Wireless Charging - Black	CU1-1CW - add \$1,371
CT2U1	
Dual Power Center Top - Black with Single Underside	CT2U1-BL - add \$1,813
Dual Power Center Top - White with Single Underside	CT2U1-WH - add \$1,813
Dual Power Center Top - Black with Wireless Charging	CT2U1-BLW2 - add \$2,592
Dual Power Center Top - White with Wireless Charging	CT2U1-WHW2 - add \$2,592

Note: Order power infeed that best fits application

To Order Specify

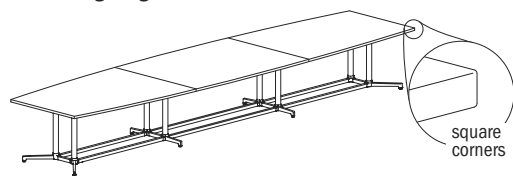
① Veneer Model #	② Edge Detail	③ Wood Species	④ Wood Finish	⑤ Electrical	⑥ Metal Color
Veneer (LKV)	See Edge Detail Options	Flat Cut CH1 Cherry MA1 Maple WA1 Walnut BO1 Black Oak	See Flat Cut Wood Finish Options	N None CT2 Dual Power Center Top CU2 Dual Power Underside CT2U1 Dual Power Center Top with Underside (See chart above)	See Metal Finish Color Options
		Double Cut DC1 Double Cut	See Double Cut Wood Finish Options		

① Solid Surface Model #	② Top Surface Selection	③ Electrical	④ Metal Color
Solid Surface (LKS)	See Solid Surface Top Surface Selection Options	N None CT2 Dual Power Center Top CU2 Dual Power Underside CT2U1 Dual Power Center Top with Underside (See chart above)	See Metal Finish Color Options

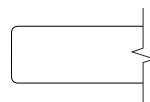
LOK - CONFERENCE

Description

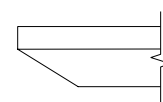
Boat 3pc Table with Y Base at Working Height



Laminate Tables "LKT" Models



Eased Edge (R3)



Reverse Bevel Edge (K9)

LAMINATE	D	W	H	CTN WT	CU FT	Model	Eased Edge (R3)			Reverse Bevel Edge (K9)		
							Standard	Graded In		Standard	Graded In	
							Tier 1	Tier 2	Tier 3	Tier 1	Tier 2	Tier 3
	60	240	29	636	281	LKT60240-29BTY	\$9,650	\$9,807	\$10,798	\$10,327	\$10,486	\$11,192
	60	216	29	584	253	LKT60216-29BTY	\$8,159	\$8,304	\$9,194	\$8,808	\$8,953	\$9,589
	54	240	29	575	254	LKT54240-29BTY	\$7,634	\$7,777	\$8,670	\$8,278	\$8,422	\$9,058
	54	216	29	523	229	LKT54216-29BTY	\$6,824	\$6,954	\$7,755	\$7,442	\$7,572	\$8,145
	48	240	29	537	228	LKT48240-29BTY	\$7,376	\$7,506	\$8,298	\$7,987	\$8,115	\$8,683
	48	216	29	477	206	LKT48216-29BTY	\$6,836	\$6,952	\$7,666	\$7,428	\$7,541	\$8,051

Features:

- price reflects complete table - top and base
- ships KD in multiple cartons
- three piece top
- model includes adjustable glide

Options:

- specify power/charging option, see below for options and upcharges



top shape

LOK - CONFERENCE

To Order Specify

1 Laminate Model #	2 Edge Detail	3 Laminate Selection	4 PVC Edge Color	5 Electrical	6 Metal Color
Laminate (LKT)	See Edge Detail Options	See Laminate Selection	See PVC Edge Color Options	N None CT6 Six Power Center Top CU2 Dual Power Underside CT6U2 Six Power Center Top with Underside (See chart on next page)	See Metal Finish Color Options

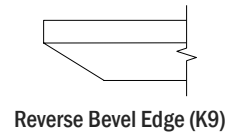
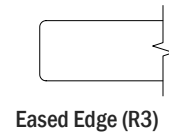
Model Number Breakdown

LKT60240-29BTY					
LK	T	60240	29	BT	Y
LOK	Laminate	60" x 240"	Height	Boat Top Shape	Y base

Description

Boat 3pc Table with Y Base
at Working Height
(continued)

Veneer Tables
"LKV" Models



VENEER	D	W	H	CTN WT	CU FT	1 Model	Eased Edge (R3)		Reverse Bevel Edge (K9)	
							Flat Cut	Double Cut	Flat Cut	Double Cut
	60	240	29	636	281	LKV60240-29BTY	\$15,024	\$16,225	\$16,376	\$17,439
	60	216	29	584	253	LKV60216-29BTY	\$13,148	\$14,200	\$14,330	\$15,263
	54	240	29	575	254	LKV54240-29BTY	\$12,533	\$13,600	\$13,152	\$14,164
	54	216	29	523	229	LKV54216-29BTY	\$11,117	\$12,061	\$11,687	\$12,582
	48	240	29	537	228	LKV48240-29BTY	\$11,911	\$12,849	\$12,471	\$13,360
	48	216	29	477	206	LKV48216-29BTY	\$10,912	\$11,742	\$11,429	\$12,214

Electrical Options and Upcharges

	216 - 240 wide
CT6	
Six Power Center Top - Black	CT6BL - add \$4,016
Six Power Center Top - White	CT6WH - add \$4,016
CU2	
Dual Power Underside - Black	CU2-1C - add \$1,052
Dual Power Underside with 4 Wireless Charging - Black	CU2-1CW - add \$2,660
CT6U2	
Six Power Center Top - Black with Dual Underside	CT6U2-BL - add \$4,665
Six Power Center Top - White with Dual Underside	CT6U2-WH - add \$4,665
Six Power Center Top - Black Dual Underside with 4 Wireless Charging	CT6U2-BLW2 - add \$6,223
Six Power Center Top - White Dual Underside with 4 Wireless Charging	CT6U2-WHW2 - add \$6,223

Note: Order power infeed that best fits application

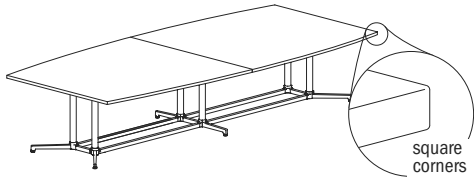
To Order Specify

1 Veneer Model #	2 Edge Detail	3 Wood Species	4 Wood Finish	5 Electrical	6 Metal Color
Veneer (LKV)	See Edge Detail Options	Flat Cut CH1 Cherry MA1 Maple WA1 Walnut BO1 Black Oak	See Flat Cut Wood Finish Options	N None CT6 Six Power Center Top CU2 Dual Power Underside CT6U2 Six Power Center Top with Underside (See chart above)	See Metal Finish Color Options
		Double Cut DC1 Double Cut	See Double Cut Wood Finish Options		

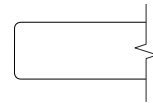
LOK - CONFERENCE

Description

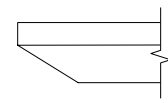
Boat 2pc Table with Y Base at Working Height



Laminate Tables "LKT" Models



Eased Edge (R3)



Reverse Bevel Edge (K9)

LAMINATE	D	W	H	CTN WT	CU FT	Model	Standard			Graded In		
							Tier 1	Tier 2	Tier 3	Tier 1	Tier 2	Tier 3
		60	192	29	511	226	LKT60192-29BTY	\$6,748	\$6,875	\$7,667	\$7,365	\$7,492
	60	168	29	449	198	LKT60168-29BTY	\$6,268	\$6,381	\$7,075	\$6,857	\$6,969	\$7,465
	60	144	29	333	169	LKT60144-29BTY	\$5,711	\$5,806	\$6,401	\$6,267	\$6,364	\$6,788
	60	120	29	334	143	LKT60120-29BTY	\$5,144	\$5,223	\$5,720	\$5,673	\$5,753	\$6,106
	54	192	29	449	204	LKT54192-29BTY	\$6,512	\$6,627	\$7,342	\$7,104	\$7,218	\$7,728
	54	168	29	359	178	LKT54168-29BTY	\$5,799	\$5,900	\$6,525	\$6,364	\$6,465	\$6,910
	54	144	29	356	154	LKT54144-29BTY	\$5,272	\$5,358	\$5,893	\$5,812	\$5,896	\$6,280
	54	120	29	308	130	LKT54120-29BTY	\$4,831	\$4,902	\$5,349	\$5,343	\$5,415	\$5,732
	48	192	29	409	183	LKT48192-29BTY	\$6,333	\$6,436	\$7,071	\$6,897	\$6,999	\$7,451
	48	168	29	363	161	LKT48168-29BTY	\$5,135	\$5,223	\$5,780	\$5,676	\$5,764	\$6,162
	48	144	29	323	139	LKT48144-29BTY	\$4,756	\$4,833	\$5,310	\$5,276	\$5,353	\$5,691
	48	120	29	283	116	LKT48120-29BTY	\$4,298	\$4,363	\$4,762	\$4,795	\$4,858	\$5,143
	48	108	29	262	105	LKT48108-29BTY	\$3,829	\$3,887	\$4,243	\$4,314	\$4,370	\$4,627

Features:

- price reflects complete table - top and base
- ships KD in multiple cartons
- two piece top
- model includes adjustable glide

Options:

- specify power/charging option, see below for options and upcharges



top shape

LOK - CONFERENCE

To Order Specify

1 Laminate Model #	2 Edge Detail	3 Laminate Selection	3a PVC Edge Color	4 Electrical	5 Metal Color
Laminate (LKT)	See Edge Detail Options	See Laminate Selection	See PVC Edge Color Options	N None CT2 Dual Power Center Top CU2 Dual Power Underside CT2U1 Dual Power Center Top with Underside CT4U2 Four Power Center Top with Underside CT4 Four Power Center Top (See chart on next page)	See Metal Finish Color Options

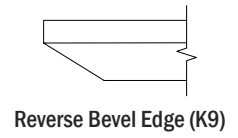
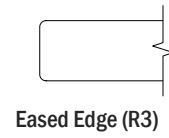
Model Number Breakdown

LKT60192-29BTY					
LK	T	60192	29	BT	Y
LOK	Laminate	60" x 192"	Height	Boat Top Shape	Y base

Description

Boat 2pc Table with Y Base
at Working Height
(continued)

Veneer Tables
"LKV" Models



VENEER	D	W	H	CTN WT	CU FT	Model	Eased Edge (R3)		Reverse Bevel Edge (K9)	
							Flat Cut	Double Cut	Flat Cut	Double Cut
	60	192	29	511	226	LKV60192-29BTY	\$10,521	\$11,363	\$11,468	\$12,213
	60	168	29	449	198	LKV60168-29BTY	\$9,639	\$10,410	\$10,508	\$11,190
	60	144	29	333	169	LKV60144-29BTY	\$8,671	\$9,364	\$9,451	\$10,064
	60	120	29	334	143	LKV60120-29BTY	\$7,767	\$8,387	\$8,464	\$9,015
	54	192	29	449	204	LKV54192-29BTY	\$9,748	\$10,529	\$10,626	\$11,315
	54	168	29	359	178	LKV54168-29BTY	\$8,779	\$9,482	\$9,568	\$10,191
	54	144	29	356	154	LKV54144-29BTY	\$7,877	\$8,507	\$8,586	\$9,145
	54	120	29	308	130	LKV54120-29BTY	\$7,120	\$7,688	\$7,762	\$8,263
	48	192	29	409	183	LKV48192-29BTY	\$9,669	\$10,397	\$10,145	\$10,833
	48	168	29	363	161	LKV48168-29BTY	\$7,827	\$8,453	\$8,260	\$8,849
	48	144	29	323	139	LKV48144-29BTY	\$7,153	\$7,682	\$7,544	\$8,044
	48	120	29	283	116	LKV48120-29BTY	\$6,391	\$6,827	\$6,745	\$7,154
	48	108	29	262	105	LKV48108-29BTY	\$5,492	\$5,931	\$5,986	\$6,375

Electrical Options and Upcharges

	108 wide	120 - 192 wide
CT2		
Dual Power Center Top - Black	CT2BL - add \$1,490	n/a
Dual Power Center Top - White	CT2WH - add \$1,490	n/a
CU1		
Single Power Underside - Black	CU1-1C - add \$592	CU1-1C - add \$688
Single Power Underside with Wireless Charging - Black	CU1-1CW - add \$1,371	CU1-1CW - add \$1,440
CT2U1		
Dual Power Center Top - Black with Underside	CT2U1-BL - add \$1,813	n/a
Dual Power Center Top - White with Underside	CT2U1-WH - add \$1,813	n/a
Dual Power Center Top - Black with Wireless Charging	CT2U1-BLW2 - add \$2,592	n/a
Dual Power Center Top - White with Wireless Charging	CT2U1-WHW2 - add \$2,592	n/a

	108 wide	120 - 192 wide
CT4U1		
Four Power Center Top with Single Underside - Black	n/a	CT4U1-BL - add \$3,169
Four Power Center Top with Single Underside - White	n/a	CT4U1-WH - add \$3,169
Four Power Center Top - Black with Underside & Wireless Charging	n/a	CT4U1-BLW2 - add \$3,928
Four Power Center Top - White with Underside & Wireless Charging	n/a	CT4U1-WHW2 - add \$3,928
CT4		
Four Power Center Top - Black	n/a	CT4BL - add \$2,775
Four Power Center Top - White	n/a	CT4WH - add \$2,775

Note: Order power infed that best fits application

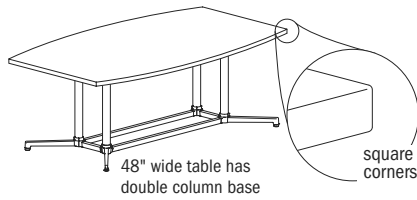
To Order Specify

1 Veneer Model #	2 Edge Detail	3 Wood Species	4 Wood Finish	5 Electrical	6 Metal Color
Veneer (LKV)	See Edge Detail Options	Flat Cut CH1 Cherry MA1 Maple WA1 Walnut BO1 Black Oak	See Flat Cut Wood Finish Options	N None CT2 Dual Power Center Top CU2 Dual Power Underside CT2U1 Dual Power Center Top with Underside CT4U2 Four Power Center Top with Underside CT4 Four Power Center Top	See Metal Finish Color Options
		Double Cut DC1 Double Cut	4 Wood Finish See Double Cut Wood Finish Options		

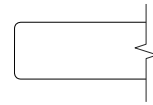
LOK - CONFERENCE

Description

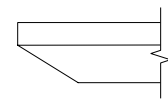
Boat Table with Y Base at Working Height



Laminate Tables "LKT" Models



Eased Edge (R3)



Reverse Bevel Edge (K9)

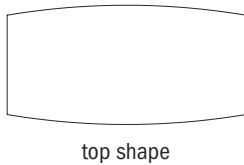
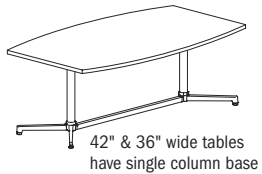
LAMINATE	D	W	H	CTN WT	CU FT	Model	Standard		Graded In		Standard		Graded In		
							Tier 1	Tier 2	Tier 3	Tier 1	Tier 2	Tier 3	Tier 1	Tier 2	Tier 3
							48	96	29	219	105	LKT4896-29BTY	\$3,163	\$3,213	\$3,532
48	84	29	327	83	LKT4884-29BTY	\$2,775	\$2,820	\$3,098	\$3,235	\$3,283	\$3,481				
42	96	29	168	83	LKT4296-29BTY	\$3,011	\$3,057	\$3,334	\$3,470	\$3,518	\$3,716				
42	84	29	636	281	LKT4284-29BTY	\$2,523	\$2,562	\$2,806	\$2,973	\$3,014	\$3,186				
36	96	29	636	281	LKT3696-29BTY	\$2,452	\$2,490	\$2,730	\$2,899	\$2,938	\$3,108				
36	84	29	648	281	LKT3684-29BTY	\$2,204	\$2,239	\$2,448	\$2,644	\$2,677	\$2,826				

Features:

- price reflects complete table - top and base
- ships KD in multiple cartons
- one piece top
- model includes adjustable glide

Options:

- specify power/charging option, see below for options and upcharges



LOK - CONFERENCE

To Order Specify

1 Laminate Model #	2 Edge Detail	3 Laminate Selection	3a PVC Edge Color	4 Electrical	5 Metal Color
Laminate (LKT)	See Edge Detail Options	See Laminate Selection	See PVC Edge Color Options	N None CT2 Dual Power Center Top CU2 Dual Power Underside CT2U1 Dual Power Center Top with Underside (See chart on next page)	See Metal Finish Color Options

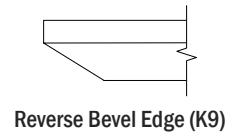
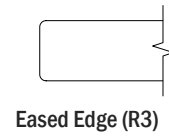
Model Number Breakdown

LKT4896-29BTY					
LK	T	4896	29	BT	Y
LOK	Laminate	48" x 96"	Height	Boat Top Shape	Y base

Description

Boat Table with
Y Base at Working Height
(continued)

Veneer Tables
"LKV" Models



D	W	H	CTN WT	CU FT	① Model	Eased Edge (R3)		Reverse Bevel Edge (K9)		
						Flat Cut	Double Cut	Flat Cut	Double Cut	
48	96	29	219	105	LKV4896-29BTY	\$4,403	\$4,741	\$4,711	\$5,028	
48	84	29	327	83	LKV4884-29BTY	\$3,972	\$4,264	\$4,261	\$4,533	
VENEER	42	96	29	168	83	LKV4296-29BTY	\$4,464	\$4,820	\$4,865	\$5,182
	42	84	29	636	281	LKV4284-29BTY	\$3,796	\$4,100	\$4,137	\$4,406
36	96	29	636	281	LKV3696-29BTY	\$3,310	\$3,573	\$3,606	\$3,841	
36	84	29	648	281	LKV3684-29BTY	\$3,049	\$3,293	\$3,323	\$3,537	

Electrical Options and Upcharges

CT2	84 - 96 wide
Dual Power Center Top - Black	CT2BL - add \$1,490
Dual Power Center Top - White	CT2WH - add \$1,490
CU1	
Single Power Underside - Black	CU1-1C - add \$592
Single Power Underside with Wireless Charging - Black	CU1-1CW - add \$1,371
CT2U1	
Dual Power Center Top - Black with Single Underside	CT2U1-BL - add \$1,813
Dual Power Center Top - White with Single Underside	CT2U1-WH - add \$1,813
Dual Power Center Top - Black with Wireless Charging	CT2U1-BLW2 - add \$2,592
Dual Power Center Top - White with Wireless Charging	CT2U1-WHW2 - add \$2,592

Note: Order power infeed that best fits application

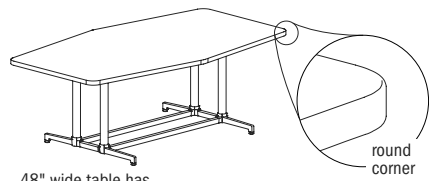
To Order Specify

① Veneer Model #	② Edge Detail	③ Wood Species	④ Wood Finish	⑤ Electrical	⑥ Metal Color
Veneer (LKV)	See Edge Detail Options	Flat Cut CH1 Cherry MA1 Maple WA1 Walnut BO1 Black Oak	See Flat Cut Wood Finish Options	N None CT2 Dual Power Center Top CU2 Dual Power Underside CT2U1 Dual Power Center Top with Underside (See chart above)	See Metal Finish Color Options
		Double Cut DC1 Double Cut	④ Wood Finish See Double Cut Wood Finish Options		

LOK - CONFERENCE

Description

Rounded Double Chevron Table with T Base at Working Height



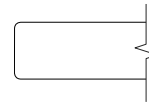
48" wide table has double column base

D W H CTN WT CU FT **1 Model**

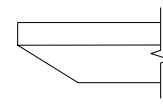
D	W	H	CTN WT	CU FT	Model
48	96	29	204	105	LKT4896-29DCRT
48	84	29	182	83	LKT4884-29DCRT
42	96	29	161	73	LKT4296-29DCRT
42	84	29	142	72	LKT4284-29DCRT
36	96	29	146	72	LKT3696-29DCRT
36	84	29	134	64	LKT3684-29DCRT

LAMINATE

Laminate Tables "LKT" Models



Eased Edge (R3)



Reverse Bevel Edge (K9)

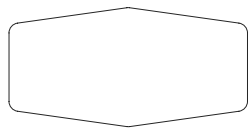
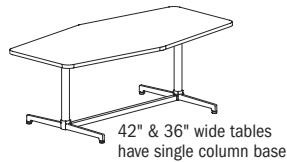
Standard		Graded In		Standard		Graded In		
Tier 1	Tier 2	Tier 3	Tier 1	Tier 2	Tier 3	Tier 1	Tier 2	Tier 3
\$3,144	\$3,194	\$3,512	\$3,616	\$3,668	\$3,894	\$3,252	\$3,297	\$3,497
\$2,854	\$2,899	\$3,178	\$3,314	\$3,358	\$3,558	\$2,803	\$2,842	\$3,016
\$2,400	\$2,439	\$2,678	\$2,848	\$2,887	\$3,058	\$2,592	\$2,627	\$2,776
\$2,154	\$2,185	\$2,395	\$2,592	\$2,627	\$2,776			

Features:

- price reflects complete table - top and base
- ships KD in multiple cartons
- one piece top
- model includes adjustable glide

Options:

- specify power/charging option, see below for options and upcharges



top shape

LOK - CONFERENCE

To Order Specify

1 Laminate Model #	2 Edge Detail	3 Laminate Selection	3a PVC Edge Color	4 Electrical	5 Metal Color
Laminate (LKT)	See Edge Detail Options	See Laminate Selection	See PVC Edge Color Options	N None CT2 Dual Power Center Top CU2 Dual Power Underside CT2U1 Dual Power Center Top with Underside (See chart on next page)	See Metal Finish Color Options

Model Number Breakdown

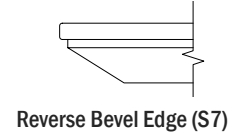
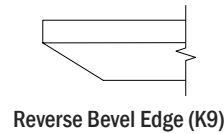
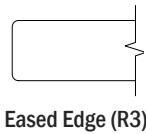
LKT4896-29DCRT						
LK	T	4896	29	DC	R	T
LOK	Laminate	48" x 96"	Height	Double Chevron Top Shape	Rounded Corner	T base

Description

Rounded Double Chevron Table with T Base at Working Height (continued)

Veneer Tables "LKV" Models

Solid Surface Tables "LKS" Models



	D	W	H	CTN WT	CU FT	① Model	Veneer		Solid Surface		Standard
							Flat Cut	Double Cut	Flat Cut	Double Cut	
VENEER	48	96	29	204	105	LKV4896-29DCRT	\$4,378	\$4,715	\$4,687	\$5,005	--
	48	84	29	182	83	LKV4884-29DCRT	\$3,995	\$4,286	\$4,281	\$4,553	--
	42	96	29	161	73	LKV4296-29DCRT	\$4,266	\$4,608	\$4,649	\$4,951	--
	42	84	29	142	72	LKV4284-29DCRT	\$3,586	\$3,871	\$3,908	\$4,164	--
	36	96	29	146	72	LKV3696-29DCRT	\$3,247	\$3,505	\$3,537	\$3,768	--
	36	84	29	134	64	LKV3684-29DCRT	\$2,987	\$3,224	\$3,255	\$3,466	--
SOLID SURFACE	48	96	29	204	105	LKS4896-29DCRT	--	--	--	--	\$10,261
	48	84	29	182	83	LKS4884-29DCRT	--	--	--	--	\$9,095
	42	96	29	161	73	LKS4296-29DCRT	--	--	--	--	\$8,348
	42	84	29	142	72	LKS4284-29DCRT	--	--	--	--	\$7,358
	36	96	29	146	72	LKS3696-29DCRT	--	--	--	--	\$7,335
	36	84	29	134	64	LKS3684-29DCRT	--	--	--	--	\$6,611

Electrical Options and Upcharges

CT2	84 - 96 wide
Dual Power Center Top - Black	CT2BL - add \$1,490
Dual Power Center Top - White	CT2WH - add \$1,490
CU1	
Single Power Underside - Black	CU1-1C - add \$592
Single Power Underside with Wireless Charging - Black	CU1-1CW - add \$1,371
CT2U1	
Dual Power Center Top - Black with Single Underside	CT2U1-BL - add \$1,813
Dual Power Center Top - White with Single Underside	CT2U1-WH - add \$1,813
Dual Power Center Top - Black with Wireless Charging	CT2U1-BLW2 - add \$2,592
Dual Power Center Top - White with Wireless Charging	CT2U1-WHW2 - add \$2,592

Note: Order power infeed that best fits application

To Order Specify

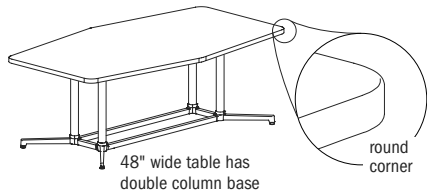
① Veneer Model #	② Edge Detail	③ Wood Species	④ Wood Finish	⑤ Electrical	⑥ Metal Color
Veneer (LKV)	See Edge Detail Options	Flat Cut CH1 Cherry MA1 Maple WA1 Walnut BO1 Black Oak	See Flat Cut Wood Finish Options	N None CT2 Dual Power Center Top CU2 Dual Power Underside CT2U1 Dual Power Center Top with Underside (See chart above)	See Metal Finish Color Options
		Double Cut DC1 Double Cut	④ Wood Finish See Double Cut Wood Finish Options		

① Solid Surface Model #	② Top Surface Selection	③ Electrical	④ Metal Color
Solid Surface (LKS)	See Solid Surface Top Surface Selection Options	N None CT2 Dual Power Center Top CU2 Dual Power Underside CT2U1 Dual Power Center Top with Underside (See chart above)	See Metal Finish Color Options

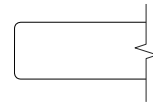
LOK - CONFERENCE

Description

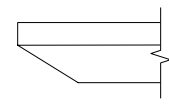
Rounded Double Chevron Table with Y Base at Working Height



Laminate Tables "LKT" Models



Eased Edge (R3)



Reverse Bevel Edge (K9)

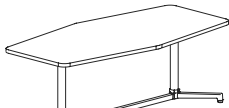
LAMINATE	D	W	H	CTN WT	CU FT	Model	Standard		Graded In		Standard		Graded In		
							Tier 1	Tier 2	Tier 3	Tier 1	Tier 2	Tier 3	Tier 1	Tier 2	Tier 3
	48	96	29	199	105	LKT4896-29DCRY	\$3,163	\$3,213	\$3,532	\$3,634	\$3,685	\$3,914			
	48	84	29	312	83	LKT4884-29DCRY	\$2,775	\$2,820	\$3,098	\$3,235	\$3,283	\$3,481			
	42	96	29	153	83	LKT4296-29DCRY	\$3,011	\$3,057	\$3,334	\$3,470	\$3,518	\$3,716			
	42	84	29	153	72	LKT4284-29DCRY	\$2,523	\$2,562	\$2,806	\$2,973	\$3,014	\$3,186			
	36	96	29	150	72	LKT3696-29DCRY	\$2,452	\$2,490	\$2,730	\$2,899	\$2,938	\$3,108			
	36	84	29	144	64	LKT3684-29DCRY	\$2,204	\$2,239	\$2,448	\$2,644	\$2,677	\$2,826			

Features:

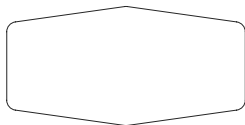
- price reflects complete table - top and base
- ships KD in multiple cartons
- one piece top
- model includes adjustable glide

Options:

- specify power/charging option, see below for options and upcharges



42" & 36" wide tables have single column base



top shape

LOK - CONFERENCE

To Order Specify

1 Laminate Model #	2 Edge Detail	3 Laminate Selection	3a PVC Edge Color	4 Electrical	5 Metal Color
Laminate (LKT)	See Edge Detail Options	See Laminate Selection	See PVC Edge Color Options	N None CT2 Dual Power Center Top CU2 Dual Power Underside CT2U1 Dual Power Center Top with Underside (See chart on next page)	See Metal Finish Color Options

Model Number Breakdown

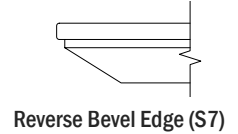
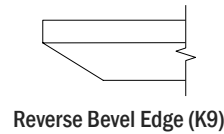
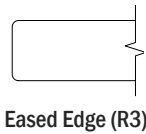
LKT4896-29DCRY						
LK	T	4896	29	DC	R	Y
LOK	Laminate	48" x 96"	Height	Double Chevron Top Shape	Rounded Corner	Y base

Description

Rounded Double Chevron Table with Y Base at Working Height (continued)

Veneer Tables "LKV" Models

Solid Surface Tables "LKS" Models



	D	W	H	CTN WT	CU FT	① Model	Veneer Tables "LKV" Models		Solid Surface Tables "LKS" Models		
							Flat Cut	Double Cut	Flat Cut	Double Cut	Standard
VENEER	48	96	29	199	105	LKV4896-29DCRY	\$4,403	\$4,741	\$4,711	\$5,028	--
	48	84	29	312	83	LKV4884-29DCRY	\$3,972	\$4,264	\$4,261	\$4,533	--
	42	96	29	153	83	LKV4296-29DCRY	\$4,464	\$4,820	\$4,865	\$5,182	--
	42	84	29	153	72	LKV4284-29DCRY	\$3,796	\$4,100	\$4,137	\$4,406	--
	36	96	29	150	72	LKV3696-29DCRY	\$3,310	\$3,573	\$3,606	\$3,841	--
	36	84	29	144	64	LKV3684-29DCRY	\$3,049	\$3,293	\$3,323	\$3,537	--
SOLID SURFACE	48	96	29	199	105	LKS4896-29DCRY	--	--	--	--	\$10,283
	48	84	29	312	83	LKS4884-29DCRY	--	--	--	--	\$9,077
	42	96	29	153	83	LKS4296-29DCRY	--	--	--	--	\$8,544
	42	84	29	153	72	LKS4284-29DCRY	--	--	--	--	\$7,566
	36	96	29	150	72	LKS3696-29DCRY	--	--	--	--	\$7,398
	36	84	29	144	64	LKS3684-29DCRY	--	--	--	--	\$6,674

Electrical Options and Upcharges

CT2	84 - 96 wide
Dual Power Center Top - Black	CT2BL - add \$1,490
Dual Power Center Top - White	CT2WH - add \$1,490
CU1	
Single Power Underside - Black	CU1-1C - add \$592
Single Power Underside with Wireless Charging - Black	CU1-1CW - add \$1,371
CT2U1	
Dual Power Center Top - Black with Single Underside	CT2U1-BL - add \$1,813
Dual Power Center Top - White with Single Underside	CT2U1-WH - add \$1,813
Dual Power Center Top - Black with Wireless Charging	CT2U1-BLW2 - add \$2,592
Dual Power Center Top - White with Wireless Charging	CT2U1-WHW2 - add \$2,592

Note: Order power infeed that best fits application

To Order Specify

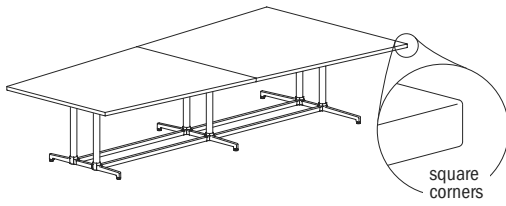
① Veneer Model #	② Edge Detail	③ Wood Species	④ Wood Finish	⑤ Electrical	⑥ Metal Color
Veneer (LKV)	See Edge Detail Options	Flat Cut CH1 Cherry MA1 Maple WA1 Walnut BO1 Black Oak	See Flat Cut Wood Finish Options	N None CT2 Dual Power Center Top CU2 Dual Power Underside CT2U1 Dual Power Center Top with Underside (See chart above)	See Metal Finish Color Options
		Double Cut DC1 Double Cut	④ Wood Finish See Double Cut Wood Finish Options		

① Solid Surface Model #	② Top Surface Selection	③ Electrical	④ Metal Color
Solid Surface (LKS)	See Solid Surface Top Surface Selection Options	N None CT2 Dual Power Center Top CU2 Dual Power Underside CT2U1 Dual Power Center Top with Underside (See chart above)	See Metal Finish Color Options

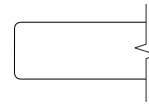
LOK - CONFERENCE

Description

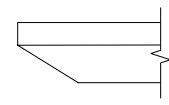
Taper 2pc Table with T Base at Working Height



Laminate Tables "LKT" Models



Eased Edge (R3)



Reverse Bevel Edge (K9)

Standard	Graded In		Standard	Graded In	
	Tier 1	Tier 2		Tier 3	Tier 1
\$5,258	\$5,340	\$5,834	\$5,787	\$5,866	\$6,221

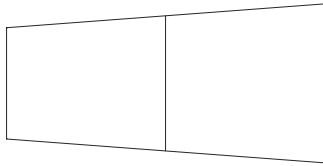
LAM.	D	W	H	CTN WT	CU FT	Model
		60	120	29	312	143

Features:

- price reflects complete table - top and base
- ships KD in multiple cartons
- two piece top
- model includes adjustable glide

Options:

- specify power/charging option, see below for options and upcharges



top shape

LOK - CONFERENCE

To Order Specify

1 Laminate Model #	2 Edge Detail	3 Laminate Selection	3a PVC Edge Color	4 Electrical	5 Metal Color
Laminate (LKT)	See Edge Detail Options	See Laminate Selection	See PVC Edge Color Options	N None CT2 Dual Power Center Top CU2 Dual Power Underside CT2U1 Dual Power Center Top with Underside (See chart on next page)	See Metal Finish Color Options

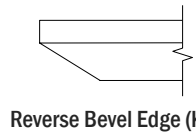
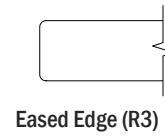
Model Number Breakdown

LKT60120-29TPT					
LK	T	60120	29	TP	T
LOK	Laminate	60" x 120"	Height	Taper Top Shape	T base

Description

Taper 2pc Table with T Base
at Working Height
(continued)

Veneer Tables
"LKV" Models



VEN.	D	W	H	CTN WT	CU FT	① Model				
							Flat Cut	Double Cut	Flat Cut	Double Cut
	60	120	29	312	143	LKV60120-29TPT	\$7,922	\$8,556	\$8,635	\$9,197

Electrical Options and Upcharges

	120 - 192 wide
CT4	
Four Power Center Top - Black	CT4BL - add \$2,775
Four Power Center Top - White	CT4WH - add \$2,775
CU1	
Single Power Underside - Black	CU1-1C - add \$688
Single Power Underside with Wireless Charging - Black	CU1-1CW - add \$1,440
CT4U1	
Four Power Center Top with Underside - Black	CT4U1-BL - add \$3,169
Four Power Center Top with Underside - White	CT4U1-WH - add \$3,169
Four Power Center Top - Black with Underside & 2 Wireless Charging	CT4U1-BLW2 - add \$3,928
Four Power Center Top - White with Underside & 2 Wireless Charging	CT4U1-WHW2 - add \$3,928

Note: Order power infeed that best fits application

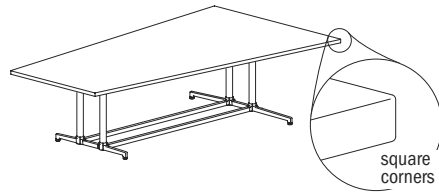
To Order Specify

① Veneer Model #	② Edge Detail	③ Wood Species	④ Wood Finish	⑤ Electrical	⑥ Metal Color
Veneer (LKV)	See Edge Detail Options	Flat Cut CH1 Cherry MA1 Maple WA1 Walnut BO1 Black Oak	See Flat Cut Wood Finish Options	N None CT2 Dual Power Center Top CU2 Dual Power Underside CT2U1 Dual Power Center Top with Underside (See chart above)	See Metal Finish Color Options
	Double Cut DC1 Double Cut	④ Wood Finish See Double Cut Wood Finish Options			

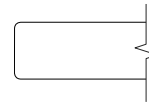
LOK - CONFERENCE

Description

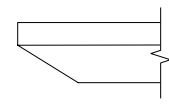
Taper Table with T Base at Working Height



Laminate Tables "LKT" Models



Eased Edge (R3)



Reverse Bevel Edge (K9)

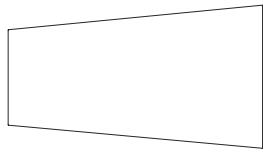
LAM.	D	W	H	CTN WT	CU FT	Model	Standard			Graded In		
	Tier 1	Tier 2	Tier 3	Tier 1	Tier 2	Tier 3	Tier 1	Tier 2	Tier 3	Tier 1	Tier 2	Tier 3
	54	96	29	216	105	LKT5496-29TPT	\$3,573	\$3,632	\$3,990	\$4,058	\$4,115	\$4,370

Features:

- price reflects complete table - top and base
- ships KD in multiple cartons
- one piece top
- model includes adjustable glide

Options:

- specify power/charging option, see below for options and upcharges



top shape

LOK - CONFERENCE

To Order Specify

1 Laminate Model #	2 Edge Detail	3 Laminate Selection	3a PVC Edge Color	4 Electrical	5 Metal Color
Laminate (LKT)	See Edge Detail Options	See Laminate Selection	See PVC Edge Color Options	N None CT2 Dual Power Center Top CU2 Dual Power Underside CT2U1 Dual Power Center Top with Underside (See chart on next page)	See Metal Finish Color Options

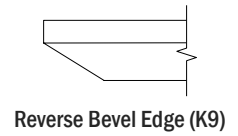
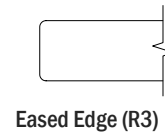
Model Number Breakdown

LKT5496-29TPT					
LK	T	5496	29	TP	T
LOK	Laminate	54" x 96"	Height	Taper Top Shape	T base

Description

Taper Table with T Base
at Working Height
(continued)

Veneer Tables
"LKV" Models



VEN.	D	W	H	CTN WT	CU FT	① Model	Eased Edge (R3)		Reverse Bevel Edge (K9)	
							Flat Cut	Double Cut	Flat Cut	Double Cut
	54	96	29	216	105	LKV5496-29TPT	\$4,886	\$5,278	\$5,325	\$5,673

Electrical Options and Upcharges

	84 - 96 wide
CT2	
Dual Power Center Top - Black	CT2BL - add \$1,490
Dual Power Center Top - White	CT2WH - add \$1,490
CU1	
Single Power Underside - Black	CU1-1C - add \$592
Single Power Underside with Wireless Charging - Black	CU1-1CW - add \$1,371
CT2U1	
Dual Power Center Top - Black with Single Underside	CT2U1-BL - add \$1,813
Dual Power Center Top - White with Single Underside	CT2U1-WH - add \$1,813
Dual Power Center Top - Black with Wireless Charging	CT2U1-BLW2 - add \$2,592
Dual Power Center Top - White with Wireless Charging	CT2U1-WHW2 - add \$2,592

Note: Order power infeed that best fits application

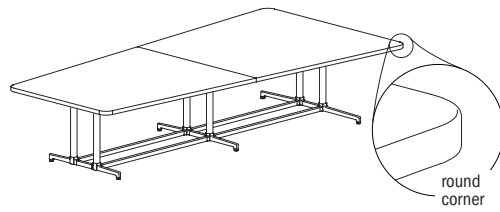
To Order Specify

① Veneer Model #	② Edge Detail	③ Wood Species	④ Wood Finish	⑤ Electrical	⑥ Metal Color
Veneer (LKV)	See Edge Detail Options	Flat Cut CH1 Cherry MA1 Maple WA1 Walnut BO1 Black Oak	See Flat Cut Wood Finish Options	N None CT2 Dual Power Center Top CU2 Dual Power Underside CT2U1 Dual Power Center Top with Underside (See chart above)	See Metal Finish Color Options
		Double Cut DC1 Double Cut	See Double Cut Wood Finish Options		

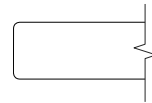
LOK - CONFERENCE

Description

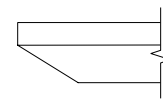
Rounded Taper 2pc Table with T Base at Working Height



Laminate Tables "LKT" Models



Eased Edge (R3)



Reverse Bevel Edge (K9)

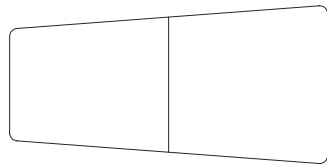
LAM.	D	W	H	CTN WT	CU FT	Model	Standard			Graded In		
	Tier 1	Tier 2	Tier 3	Tier 1	Tier 2	Tier 3	Tier 1	Tier 2	Tier 3	Tier 1	Tier 2	Tier 3
	60	120	29	312	143	LKT60120-29TPRT	\$5,258	\$5,340	\$5,834	\$5,787	\$5,866	\$6,221

Features:

- price reflects complete table - top and base
- ships KD in multiple cartons
- two piece top
- model includes adjustable glide

Options:

- specify power/charging option, see below for options and upcharges



top shape

LOK - CONFERENCE

To Order Specify

1 Laminate Model #	2 Edge Detail	3 Laminate Selection	3a PVC Edge Color	4 Electrical	5 Metal Color
Laminate (LKT)	See Edge Detail Options	See Laminate Selection	See PVC Edge Color Options	N None CT2 Dual Power Center Top CU2 Dual Power Underside CT2U1 Dual Power Center Top with Underside (See chart on next page)	See Metal Finish Color Options

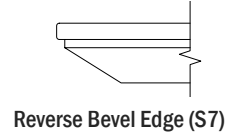
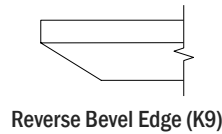
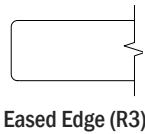
Model Number Breakdown

LKT60120-29TPRT						
LK	T	60120	29	TP	R	T
LOK	Laminate	60" x 120"	Height	Taper Top Shape	Rounded Corner	T base

Description

Rounded Taper 2pc Table with T Base at Working Height (continued)

Veneer Tables "LKV" Models	Solid Surface Tables "LKS" Models
----------------------------	-----------------------------------



VEN.	D	W	H	CTN WT	CU FT	① Model	Veneer Tables "LKV" Models		Solid Surface Tables "LKS" Models		
							Flat Cut	Double Cut	Flat Cut	Double Cut	Standard
	60	120	29	312	143	LKV60120-29TPRT	\$7,922	\$8,556	\$8,635	\$9,197	--
S.S.	60	120	29	312	143	LKS60120-29TPRT	--	--	--	--	\$21,909

Electrical Options and Upcharges

CT4	120 - 192 wide
Four Power Center Top - Black	CT4BL - add \$2,775
Four Power Center Top - White	CT4WH - add \$2,775
CU1	
Single Power Underside - Black	CU1-1C - add \$688
Single Power Underside with Wireless Charging - Black	CU1-1CW - add \$1,440
CT4U1	
Four Power Center Top with Underside - Black	CT4U1-BL - add \$3,169
Four Power Center Top with Underside - White	CT4U1-WH - add \$3,169
Four Power Center Top - Black with Underside & 2 Wireless Charging	CT4U1-BLW2 - add \$3,928
Four Power Center Top - White with Underside & 2 Wireless Charging	CT4U1-WhW2 - add \$3,928

Note: Order power infeed that best fits application, see page 408.

To Order Specify

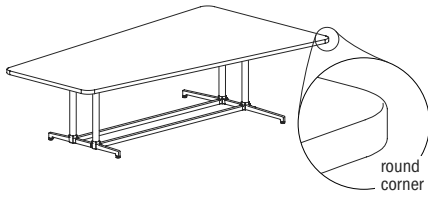
① Veneer Model #	② Edge Detail	③ Wood Species	④ Wood Finish	⑤ Electrical	⑥ Metal Color
Veneer (LKV)	See Edge Detail Options	Flat Cut CH1 Cherry MA1 Maple WA1 Walnut BO1 Black Oak	See Flat Cut Wood Finish Options	N None CT2 Dual Power Center Top CU2 Dual Power Underside CT2U1 Dual Power Center Top with Underside (See chart above)	See Metal Finish Color Options
		Double Cut DC1 Double Cut	See Double Cut Wood Finish Options		

① Solid Surface Model #	② Top Surface Selection	③ Electrical	④ Metal Color
Solid Surface (LKS)	See Solid Surface Top Surface Selection Options	N None CT2 Dual Power Center Top CU2 Dual Power Underside CT2U1 Dual Power Center Top with Underside (See chart above)	See Metal Finish Color Options

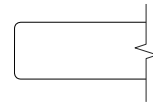
LOK - CONFERENCE

Description

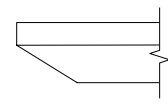
Rounded Taper Table with T Base at Working Height



Laminate Tables "LKT" Models



Eased Edge (R3)



Reverse Bevel Edge (K9)

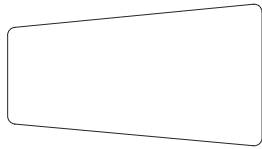
Lam.	D	W	H	CTN WT	CU FT	Model	Standard			Graded In		
	Tier 1	Tier 2	Tier 3	Tier 1	Tier 2	Tier 3	Tier 1	Tier 2	Tier 3	Tier 1	Tier 2	Tier 3
	54	96	29	216	105	LKT5496-29TPRT	\$3,573	\$3,632	\$3,990	\$4,058	\$4,115	\$4,370

Features:

- price reflects complete table - top and base
- ships KD in multiple cartons
- one piece top
- model includes adjustable glide

Options:

- specify power/charging option, see below for options and upcharges



top shape

LOK - CONFERENCE

To Order Specify

1 Laminate Model #	2 Edge Detail	3 Laminate Selection	3a PVC Edge Color	4 Electrical	5 Metal Color
Laminate (LKT)	See Edge Detail Options	See Laminate Selection	See PVC Edge Color Options	N None CT2 Dual Power Center Top CU2 Dual Power Underside CT2U1 Dual Power Center Top with Underside (See chart on next page)	See Metal Finish Color Options

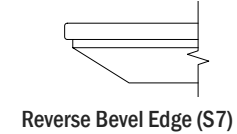
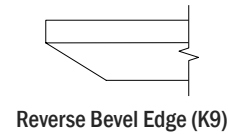
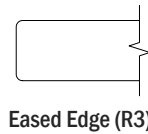
Model Number Breakdown

LKT5496-29TPRT						
LK	T	5496	29	TP	R	T
LOK	Laminate	54" x 96"	Height	Taper Top Shape	Rounded Corner	T base

Description

Rounded Taper Table with T Base at Working Height (continued)

Veneer Tables "LKV" Models	Solid Surface Tables "LKS" Models
----------------------------	-----------------------------------



	D	W	H	CTN WT	CU FT	① Model	Veneer Tables "LKV" Models		Solid Surface Tables "LKS" Models		
							Flat Cut	Double Cut	Flat Cut	Double Cut	Standard
VEN.	54	96	29	216	105	LKV5496-29TPRT	\$4,886	\$5,278	\$5,325	\$5,673	--
S.S.	54	96	29	216	105	LKS5496-29TPRT	--	--	--	--	\$13,672

Electrical Options and Upcharges

CT2	84 - 96 wide
Dual Power Center Top - Black	CT2BL - add \$1,490
Dual Power Center Top - White	CT2WH - add \$1,490
CU1	
Single Power Underside - Black	CU1-1C - add \$592
Single Power Underside with Wireless Charging - Black	CU1-1CW - add \$1,371
CT2U1	
Dual Power Center Top - Black with Single Underside	CT2U1-BL - add \$1,813
Dual Power Center Top - White with Single Underside	CT2U1-WH - add \$1,813
Dual Power Center Top - Black with Wireless Charging	CT2U1-BLW2 - add \$2,592
Dual Power Center Top - White with Wireless Charging	CT2U1-WHW2 - add \$2,592

Note: Order power infeed that best fits application, see page 408.

To Order Specify

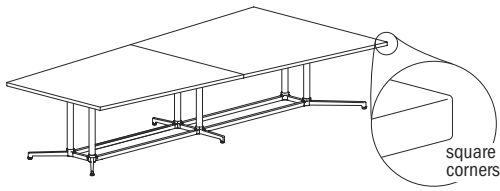
① Veneer Model #	② Edge Detail	③ Wood Species	④ Wood Finish	⑤ Electrical	⑥ Metal Color
Veneer (LKV)	See Edge Detail Options	Flat Cut CH1 Cherry MA1 Maple WA1 Walnut BO1 Black Oak	See Flat Cut Wood Finish Options	N None CT2 Dual Power Center Top CU2 Dual Power Underside CT2U1 Dual Power Center Top with Underside (See chart above)	See Metal Finish Color Options
		Double Cut DC1 Double Cut	④ Wood Finish See Double Cut Wood Finish Options		

① Solid Surface Model #	② Top Surface Selection	③ Electrical	④ Metal Color
Solid Surface (LKS)	See Solid Surface Top Surface Selection Options	N None CT2 Dual Power Center Top CU2 Dual Power Underside (See chart above) CT2U1 Dual Power Center Top with Underside	See Metal Finish Color Options

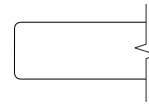
LOK - CONFERENCE

Description

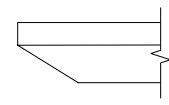
Taper 2pc Table with Y Base at Working Height



Laminate Tables "LKT" Models



Eased Edge (R3)



Reverse Bevel Edge (K9)

Standard		Graded In		Standard		Graded In		
Tier 1	Tier 2	Tier 3	Tier 1	Tier 2	Tier 3	Tier 1	Tier 2	Tier 3
\$5,106	\$5,184	\$5,680	\$5,632	\$5,714	\$6,065			

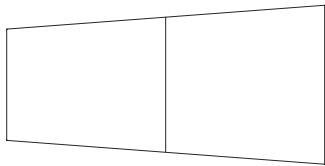
LAM.	D	W	H	CTN WT	CU FT	Model
	60	120	29	301	143	LKT60120-29TPY

Features:

- price reflects complete table - top and base
- ships KD in multiple cartons
- two piece top
- model includes adjustable glide

Options:

- specify power/charging option, see below for options and upcharges



top shape

LOK - CONFERENCE

To Order Specify

1 Laminate Model #	2 Edge Detail	3 Laminate Selection	3a PVC Edge Color	4 Electrical	5 Metal Color
Laminate (LKT)	See Edge Detail Options	See Laminate Selection	See PVC Edge Color Options	N None CT2 Dual Power Center Top CU2 Dual Power Underside CT2U1 Dual Power Center Top with Underside (See chart on next page)	See Metal Finish Color Options

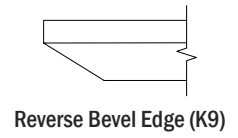
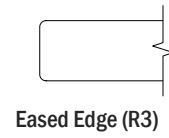
Model Number Breakdown

LKT60120-29TPY					
LK	T	60120	29	TP	Y
LOK	Laminate	60" x 120"	Height	Taper Top Shape	Y base

Description

Taper 2pc Table with Y Base
at Working Height
(continued)

Veneer Tables
"LKV" Models



VEN.	D	W	H	CTN WT	CU FT	① Model	Eased Edge (R3)		Reverse Bevel Edge (K9)	
							Flat Cut	Double Cut	Flat Cut	Double Cut
	60	120	29	301	143	LKV60120-29TPY	\$3,777	\$4,078	\$4,115	\$4,382

Electrical Options and Upcharges

	120 - 192 wide
CT4	
Four Power Center Top - Black	CT4BL - add \$2,775
Four Power Center Top - White	CT4WH - add \$2,775
CU1	
Single Power Underside - Black	CU1-1C - add \$688
Single Power Underside with Wireless Charging - Black	CU1-1CW - add \$1,440
CT4U1	
Four Power Center Top with Underside - Black	CT4U1-BL - add \$3,169
Four Power Center Top with Underside - White	CT4U1-WH - add \$3,169
Four Power Center Top - Black with Underside & 2 Wireless Charging	CT4U1-BLW2 - add \$3,928
Four Power Center Top - White with Underside & 2 Wireless Charging	CT4U1-WHW2 - add \$3,928

Note: Order power infeed that best fits application

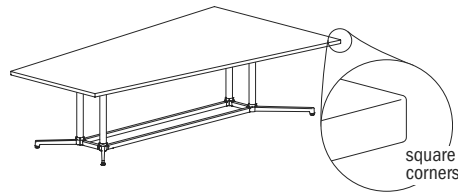
To Order Specify

① Veneer Model #	② Edge Detail	③ Wood Species	④ Wood Finish	⑤ Electrical	⑥ Metal Color
Veneer (LKV)	See Edge Detail Options	Flat Cut CH1 Cherry MA1 Maple WA1 Walnut BO1 Black Oak	See Flat Cut Wood Finish Options	N None CT2 Dual Power Center Top CU2 Dual Power Underside CT2U1 Dual Power Center Top with Underside (See chart above)	See Metal Finish Color Options
		Double Cut DC1 Double Cut	④ Wood Finish See Double Cut Wood Finish Options		

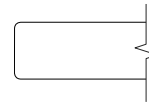
LOK - CONFERENCE

Description

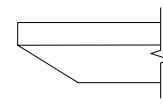
Taper Table with Y Base at Working Height



Laminate Tables "LKT" Models



Eased Edge (R3)



Reverse Bevel Edge (K9)

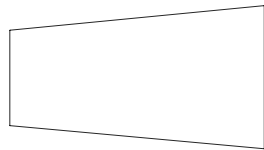
Lam.	D	W	H	CTN WT	CU FT	Model	Standard			Graded In		
							Tier 1	Tier 2	Tier 3	Tier 1	Tier 2	Tier 3
	54	96	29	198	105	LKT5496-29TPY	\$1,657	\$1,712	\$2,071	\$2,141	\$2,200	\$2,453

Features:

- price reflects complete table - top and base
- ships KD in multiple cartons
- one piece top
- model includes adjustable glide

Options:

- specify power/charging option, see below for options and upcharges



top shape

LOK - CONFERENCE

To Order Specify

1 Laminate Model #	2 Edge Detail	3 Laminate Selection	3a PVC Edge Color	4 Electrical	5 Metal Color
Laminate (LKT)	See Edge Detail Options	See Laminate Selection	See PVC Edge Color Options	N None CT2 Dual Power Center Top CU2 Dual Power Underside CT2U1 Dual Power Center Top with Underside (See chart on next page)	See Metal Finish Color Options

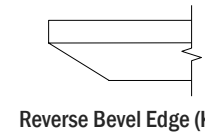
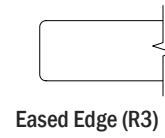
Model Number Breakdown

LKT5496-29TPY					
LK	T	5496	29	TP	Y
LOK	Laminate	54" x 96"	Height	Taper Top Shape	Y base

Description

Taper Table with Y Base
at Working Height
(continued)

Veneer Tables
"LKV" Models



VEN.	D	W	H	CTN WT	CU FT	① Model	Eased Edge (R3)		Reverse Bevel Edge (K9)	
							Flat Cut	Double Cut	Flat Cut	Double Cut
	54	96	29	198	105	LKV5496-29TPY	\$4,980	\$5,378	\$5,428	\$5,780

Electrical Options and Upcharges

	84 - 96 wide
CT2	
Dual Power Center Top - Black	CT2BL - add \$1,490
Dual Power Center Top - White	CT2WH - add \$1,490
CU1	
Single Power Underside - Black	CU1-1C - add \$592
Single Power Underside with Wireless Charging - Black	CU1-1CW - add \$1,371
CT2U1	
Dual Power Center Top - Black with Single Underside	CT2U1-BL - add \$1,813
Dual Power Center Top - White with Single Underside	CT2U1-WH - add \$1,813
Dual Power Center Top - Black with Wireless Charging	CT2U1-BLW2 - add \$2,592
Dual Power Center Top - White with Wireless Charging	CT2U1-WHW2 - add \$2,592

Note: Order power infeed that best fits application

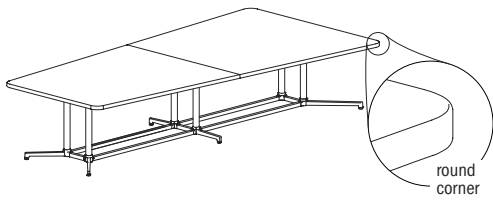
To Order Specify

① Veneer Model #	② Edge Detail	③ Wood Species	④ Wood Finish	⑤ Electrical	⑥ Metal Color
Veneer (LKV)	See Edge Detail Options	Flat Cut CH1 Cherry MA1 Maple WA1 Walnut BO1 Black Oak	See Flat Cut Wood Finish Options	N None CT2 Dual Power Center Top CU2 Dual Power Underside CT2U1 Dual Power Center Top with Underside (See chart above)	See Metal Finish Color Options
		Double Cut DC1 Double Cut	See Double Cut Wood Finish Options		

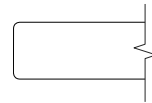
LOK - CONFERENCE

Description

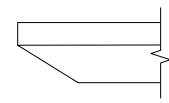
Rounded Taper 2pc Table with Y Base at Working Height



Laminate Tables "LKT" Models



Eased Edge (R3)



Reverse Bevel Edge (K9)

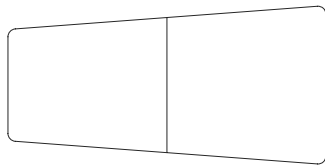
LAM.	D	W	H	CTN WT	CU FT	Model	Standard			Graded In		
	Tier 1	Tier 2	Tier 3	Tier 1	Tier 2	Tier 3	Tier 1	Tier 2	Tier 3	Tier 1	Tier 2	Tier 3
	60	120	29	301	143	LKT60120-29TPRY	\$5,106	\$5,184	\$5,680	\$5,632	\$5,714	\$6,065

Features:

- price reflects complete table - top and base
- ships KD in multiple cartons
- two piece top
- model includes adjustable glide

Options:

- specify power/charging option, see below for options and upcharges



top shape

LOK - CONFERENCE

To Order Specify

1 Laminate Model #	2 Edge Detail	3 Laminate Selection	3a PVC Edge Color	4 Electrical	5 Metal Color
Laminate (LKT)	See Edge Detail Options	See Laminate Selection	See PVC Edge Color Options	N None CT2 Dual Power Center Top CU2 Dual Power Underside CT2U1 Dual Power Center Top with Underside (See chart on next page)	See Metal Finish Color Options

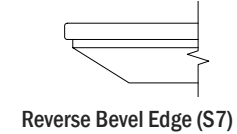
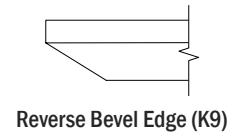
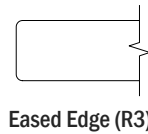
Model Number Breakdown

LKT60120-29TPRY						
LK	T	60120	29	TP	R	Y
LOK	Laminate	60" x 120"	Height	Taper Top Shape	Rounded Corner	Y base

Description

Rounded Taper 2pc Table with Y Base at Working Height (continued)

Veneer Tables "LKV" Models	Solid Surface Tables "LKS" Models
----------------------------	-----------------------------------



	D	W	H	CTN WT	CU FT	① Model	Veneer Tables "LKV" Models		Solid Surface Tables "LKS" Models		
							Flat Cut	Double Cut	Flat Cut	Double Cut	Standard
VEN.	60	120	29	301	143	LKV60120-29TPRY	\$7,713	\$8,328	\$8,407	\$8,951	--
S.S.	60	120	29	301	143	LKS60120-29TPRY	--	--	--	--	\$21,699

Electrical Options and Upcharges

120 - 192 wide	
CT4	
Four Power Center Top - Black	CT4BL - add \$2,775
Four Power Center Top - White	CT4WH - add \$2,775
CU1	
Single Power Underside - Black	CU1-1C - add \$688
Single Power Underside with Wireless Charging - Black	CU1-1CW - add \$1,440
CT4U1	
Four Power Center Top with Underside - Black	CT4U1-BL - add \$3,169
Four Power Center Top with Underside - White	CT4U1-WH - add \$3,169
Four Power Center Top - Black with Underside & 2 Wireless Charging	CT4U1-BLW2 - add \$3,928
Four Power Center Top - White with Underside & 2 Wireless Charging	CT4U1-WHW2 - add \$3,928

LOK - CONFERENCE

Note: Order power infeed that best fits application, see page 408.

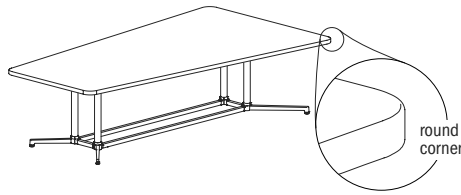
To Order Specify

① Veneer Model #	② Edge Detail	③ Wood Species	④ Wood Finish	⑤ Electrical	⑥ Metal Color
Veneer (LKV)	See Edge Detail Options	Flat Cut CH1 Cherry MA1 Maple WA1 Walnut BO1 Black Oak	See Flat Cut Wood Finish Options	N None CT2 Dual Power Center Top CU2 Dual Power Underside CT2U1 Dual Power Center Top with Underside (See chart above)	See Metal Finish Color Options
		Double Cut DC1 Double Cut	④ Wood Finish See Double Cut Wood Finish Options		

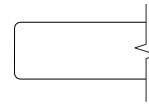
① Solid Surface Model #	② Top Surface Selection	③ Electrical	④ Metal Color
Solid Surface (LKS)	See Solid Surface Top Surface Selection Options	N None CT2 Dual Power Center Top CU2 Dual Power Underside CT2U1 Dual Power Center Top with Underside (See chart above)	See Metal Finish Color Options

Description

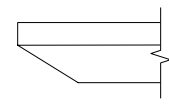
Rounded Taper Table with Y Base at Working Height



Laminate Tables "LKT" Models



Eased Edge (R3)



Reverse Bevel Edge (K9)

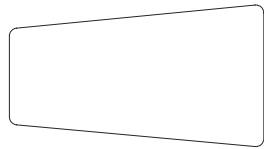
LAM.	D	W	H	CTN WT	CU FT	Model	Eased Edge (R3)			Reverse Bevel Edge (K9)		
							Standard Tier 1	Graded In Tier 2 Tier 3		Standard Tier 1	Graded In Tier 2 Tier 3	
	54	96	29	198	105	LKT5496-29TPRY	\$3,649	\$3,707	\$4,066	\$4,134	\$4,192	\$4,447

Features:

- price reflects complete table - top and base
- ships KD in multiple cartons
- one piece top
- model includes adjustable glide

Options:

- specify power/charging option, see below for options and upcharges



top shape

LOK - CONFERENCE

To Order Specify

1 Laminate Model #	2 Edge Detail	3 Laminate Selection	3a PVC Edge Color	4 Electrical	5 Metal Color
Laminate (LKT)	See Edge Detail Options	See Laminate Selection	See PVC Edge Color Options	N None CT2 Dual Power Center Top CU2 Dual Power Underside CT2U1 Dual Power Center Top with Underside (See chart on next page)	See Metal Finish Color Options

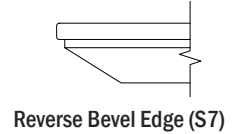
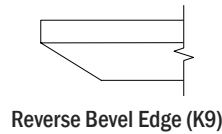
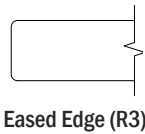
Model Number Breakdown

LKT5496-29TPRY						
LK	T	5496	29	TP	R	Y
LOK	Laminate	54" x 96"	Height	Taper Top Shape	Rounded Corner	Y base

Description

Rounded Taper Table with Y Base at Working Height (continued)

Veneer Tables "LKV" Models	Solid Surface Tables "LKS" Models
----------------------------	-----------------------------------



	D	W	H	CTN WT	CU FT	① Model	Veneer Tables "LKV" Models		Solid Surface Tables "LKS" Models		
							Flat Cut	Double Cut	Flat Cut	Double Cut	Standard
VEN.	54	96	29	198	105	LKV5496-29TPRY	\$4,980	\$5,378	\$5,428	\$5,780	--
S.S.	54	96	29	198	105	LKS5496-29TPRY	--	--	--	--	\$13,764

Electrical Options and Upcharges

CT2	84 - 96 wide
Dual Power Center Top - Black	CT2BL - add \$1,490
Dual Power Center Top - White	CT2WH - add \$1,490
CU1	
Single Power Underside - Black	CU1-1C - add \$592
Single Power Underside with Wireless Charging - Black	CU1-1CW - add \$1,371
CT2U1	
Dual Power Center Top - Black with Single Underside	CT2U1-BL - add \$1,813
Dual Power Center Top - White with Single Underside	CT2U1-WH - add \$1,813
Dual Power Center Top - Black with Wireless Charging	CT2U1-BLW2 - add \$2,592
Dual Power Center Top - White with Wireless Charging	CT2U1-WHW2 - add \$2,592

LOK - CONFERENCE

Note: Order power infeed that best fits application, see page 408.

To Order Specify

① Veneer Model #	② Edge Detail	③ Wood Species	④ Wood Finish	⑤ Electrical	⑥ Metal Color
Veneer (LKV)	See Edge Detail Options	Flat Cut CH1 Cherry MA1 Maple WA1 Walnut BO1 Black Oak	See Flat Cut Wood Finish Options	N None CT2 Dual Power Center Top CU2 Dual Power Underside CT2U1 Dual Power Center Top with Underside (See chart above)	See Metal Finish Color Options
		Double Cut DC1 Double Cut	④ Wood Finish See Double Cut Wood Finish Options		

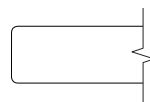
① Solid Surface Model #	② Top Surface Selection	③ Electrical	④ Metal Color
Solid Surface (LKS)	See Solid Surface Top Surface Selection Options	N None CT2 Dual Power Center Top CU2 Dual Power Underside CT2U1 Dual Power Center Top with Underside (See chart above)	See Metal Finish Color Options

Description

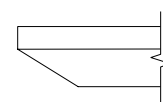
Round Table with X Base
at Working Height



Laminate Tables
"LKT" Models



Eased Edge (R3)



Reverse Bevel Edge (K9)

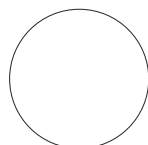
LAMINATE	D	W	H	CTN WT	CU FT	❶ Model	Standard			Graded In		
							Tier 1	Tier 2	Tier 3	Tier 1	Tier 2	Tier 3
	48	48	29	86	49	LKT48-29RDX	\$1,571	\$1,692	\$1,821	\$2,026	\$2,146	\$2,278
42	42	29	72	38	LKT42-29RDX	\$1,434	\$1,553	\$1,648	\$1,891	\$2,007	\$2,105	
36	36	29	58	29	LKT36-29RDX	\$1,388	\$1,431	\$1,499	\$1,843	\$1,885	\$1,968	
30	30	29	58	21	LKT30-29RDX	\$1,337	\$1,372	\$1,412	\$1,779	\$1,828	\$1,869	

Features:

- price reflects complete table - top and base
- ships KD in multiple cartons
- one piece top
- model includes adjustable glide
- when electrical option is selected, power accessible base is shipped; see page 178 for details
- power/charging units have 72" cord
- power cord is routed inside base column

Options:

- specify power access base with power unit option; None (N), add \$643 for EC23 (CTEC23), add \$533 for EC24 (CTEC24)



top shape

LOK - CONFERENCE

To Order Specify

❶ Laminate Model #	❷ Edge Detail	❸ Laminate Selection	❹ PVC Edge Color	❺ Electrical	❻ Metal Color
Laminate (LKT)	See Edge Detail Options	See Laminate Selection	See PVC Edge Color Options	N None CTEC23 Power Center Top CTEC24 Power Center Top (See chart on next page)	See Metal Finish Color Options

Model Number Breakdown

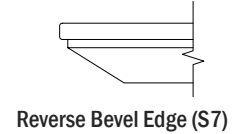
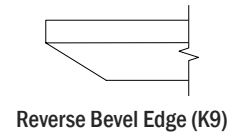
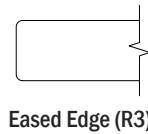
LKT48-29RDX					
LK	T	48	29	RD	X
LOK	Laminate	48" dia.	Height	Round Top Shape	X base

Description

Round Table with X Base
at Working Height
(continued)

Veneer Tables
"LKV" Models

Solid Surface Tables
"LKS" Models



	D	W	H	CTN WT	CU FT	① Model	Veneer Tables "LKV" Models		Solid Surface Tables "LKS" Models		
							Flat Cut	Double Cut	Flat Cut	Double Cut	Standard
VENEER	48	48	29	86	49	LKV48-29RDX	\$2,105	\$2,251	\$2,189	\$2,344	--
	42	42	29	72	38	LKV42-29RDX	\$1,921	\$2,057	\$2,000	\$2,140	--
	36	36	29	58	29	LKV36-29RDX	\$1,861	\$1,991	\$1,937	\$2,072	--
	30	30	29	58	21	LKV30-29RDX	\$1,791	\$1,917	\$1,864	\$1,995	--
SOLID SURFACE	48	48	29	86	49	LKS48-29RDX	--	--	--	--	\$5,047
	42	42	29	72	38	LKS42-29RDX	--	--	--	--	\$4,286
	36	36	29	58	29	LKS36-29RDX	--	--	--	--	\$3,723
	30	30	29	47	21	LKS30-29RDX	--	--	--	--	\$3,227

Electrical Options and Upcharges

CTEC23	
EC23 Power Center Top - Black	CTEC23BL - add \$643
EC23 Power Center Top - White	CTEC23WH - add \$643
CTEC24	
EC24 Power Center Top - Black	CTEC43BL - add \$533
EC24 Power Center Top - White	CTEC43WH - add \$533

To Order Specify

① Veneer Model #	② Edge Detail	③ Wood Species	④ Wood Finish	⑤ Electrical	⑥ Metal Color
Veneer (LKV)	See Edge Detail Options	Flat Cut CH1 Cherry MA1 Maple WA1 Walnut BO1 Black Oak	See Flat Cut Wood Finish Options	N None CTEC23 Power Center Top CTEC24 Power Center Top (See chart above)	See Metal Finish Color Options
		Double Cut DC1 Double Cut	④ Wood Finish See Double Cut Wood Finish Options		

① Solid Surface Model #	② Top Surface Selection	③ Electrical Cut Out	④ Metal Color
Solid Surface (LKS)	See Solid Surface Top Surface Selection Options	N None CTEC23 Power Center Top CTEC24 Power Center Top (See chart above)	See Metal Finish Color Options

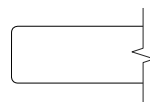
LOK - CONFERENCE

Description

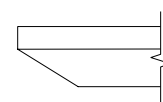
Round Table with X4 Base at Working Height



Laminate Tables "LKT" Models



Eased Edge (R3)



Reverse Bevel Edge (K9)

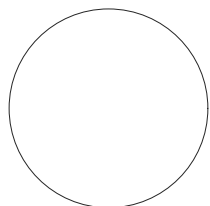
LAMINATE	D	W	H	CTN WT	CU FT	Model	Eased Edge (R3)			Reverse Bevel Edge (K9)		
							Standard	Graded In		Standard	Graded In	
							Tier 1	Tier 2	Tier 3	Tier 1	Tier 2	Tier 3
	60	60	29	148	73	LKT60-29RDZ	\$2,561	\$2,653	\$2,862	\$3,016	\$3,110	\$3,318
	54	54	29	130	61	LKT54-29RDZ	\$2,508	\$2,580	\$2,652	\$2,964	\$3,036	\$3,108

Features:

- price reflects complete table - top and base
- ships KD in multiple cartons
- one piece top
- model includes adjustable glide
- power cord is routed outside base column
- order vertical wire manager separately; see page 408

Options:

- specify power unit option; None (N), add \$643 for EC23 (CTEC23), add \$533 for EC24 (CTEC24)



top shape

LOK - CONFERENCE

To Order Specify

1 Laminates Model #	2 Edge Detail	3 Laminates Selection	3a PVC Edge Color	4 Electrical	5 Metal Color
Laminates (LKT)	See Edge Detail Options	See Laminates Selection	See PVC Edge Color Options	N None CTEC23 Power Center Top CTEC24 Power Center Top (See chart on next page)	See Metal Finish Color Options

Model Number Breakdown

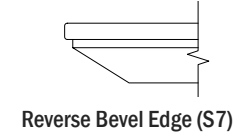
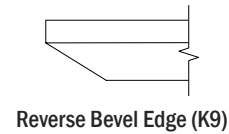
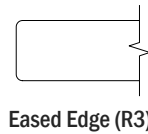
LKT60-29RDZ					
LK	T	60	29	RD	Z
LOK	Laminates	60" dia.	Height	Round Top Shape	X4 base

Description

Round Table with X4 Base
at Working Height
(continued)

Veneer Tables
"LKV" Models

Solid Surface Tables
"LKS" Models



	D	W	H	CTN WT	CU FT	① Model	Veneer Tables "LKV" Models		Solid Surface Tables "LKS" Models		
							Flat Cut	Double Cut	Flat Cut	Double Cut	Standard
VENEER	60	60	29	148	73	LKV60-29RDZ	\$3,430	\$3,671	\$3,567	\$3,820	--
	54	54	29	130	61	LKV54-29RDZ	\$3,359	\$3,595	\$3,496	\$3,741	--
SOL. SURF.	60	60	29	148	73	LKS60-29RDZ	--	--	--	--	\$7,756
	54	54	29	130	61	LKS54-29RDZ	--	--	--	--	\$6,957

Electrical Options and Upcharges

CTEC23	
EC23 Power Center Top - Black	CTEC23BL - add \$643
EC23 Power Center Top - White	CTEC23WH - add \$643
CTEC24	
EC24 Power Center Top - Black	CTEC24BL - add \$533
EC24 Power Center Top - White	CTEC24WH - add \$533

To Order Specify

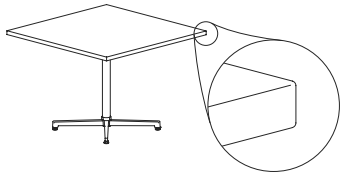
① Veneer Model #	② Edge Detail	③ Wood Species	④ Wood Finish	⑤ Electrical	⑥ Metal Color
Veneer (LKV)	See Edge Detail Options	Flat Cut CH1 Cherry MA1 Maple WA1 Walnut BO1 Black Oak	See Flat Cut Wood Finish Options	N None CTEC23 Power Center Top CTEC24 Power Center Top (See chart above)	See Metal Finish Color Options
		Double Cut DC1 Double Cut	④ Wood Finish See Double Cut Wood Finish Options		

① Solid Surface Model #	② Top Surface Selection	③ Electrical Cut Out	④ Metal Color
Solid Surface (LKS)	See Solid Surface Top Surface Selection Options	N None CTEC23 Power Center Top CTEC24 Power Center Top (See chart above)	See Metal Finish Color Options

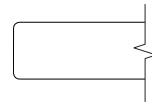
LOK - CONFERENCE

Description

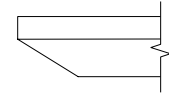
Square Table with X Base
at Working Height



Laminate Tables
"LKT" Models



Eased Edge (R3)



Reverse Bevel Edge (K9)

LAMINATE	D	W	H	CTN WT	CU FT	❶ Model	Standard			Graded In		
							Tier 1	Tier 2	Tier 3	Tier 1	Tier 2	Tier 3
	48	48	29	103	49	LKT4848-29SQX	\$1,606	\$1,662	\$1,799	\$2,063	\$2,116	\$2,254
42	42	29	85	38	LKT4242-29SQX	\$1,473	\$1,526	\$1,651	\$1,929	\$1,981	\$2,107	
36	36	29	69	29	LKT3636-29SQX	\$1,297	\$1,339	\$1,387	\$1,878	\$1,896	\$1,976	
30	30	29	53	21	LKT3030-29SQX	\$1,157	\$1,192	\$1,207	\$1,611	\$1,645	\$1,662	

Features:

- price reflects complete table - top and base
- ships KD in multiple cartons
- one piece top
- model includes adjustable glide
- when electrical option is selected, power accessible base is shipped; see page 178 for details
- power/charging units have 72" cord
- power cord is routed inside base column

Options:

- specify power access base with power unit option; None (N), add \$643 for EC23 (CTEC23), add \$533 for EC24 (CTEC24)



top shape

LOK - CONFERENCE

To Order Specify

❶ Laminite Model #	❷ Edge Detail	❸ Laminite Selection	❹ PVC Edge Color	❺ Electrical	❻ Metal Color
Laminite (LKT)	See Edge Detail Options	See Laminite Selection	See PVC Edge Color Options	N None CTEC23 Power Center Top CTEC24 Power Center Top (See chart on next page)	See Metal Finish Color Options

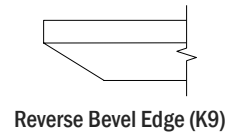
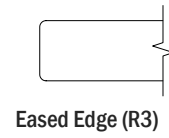
Model Number Breakdown

LKT4848-29SQX					
LK	T	4848	29	SQ	X
LOK	Laminite	48" x 48"	Height	Square Top Shape	X base

Description

Square Table with X Base
at Working Height
(continued)

Veneer Tables
"LKV" Models



VENEER	D	W	H	CTN WT	CU FT	1 Model	Eased Edge (R3)		Reverse Bevel Edge (K9)	
							Flat Cut	Double Cut	Flat Cut	Double Cut
	48	48	29	103	49	LKV4848-29SQX	\$2,120	\$2,269	\$2,205	\$2,361
	42	42	29	85	38	LKV4242-29SQX	\$1,944	\$2,079	\$2,022	\$2,164
	36	36	29	69	29	LKV3636-29SQX	\$1,711	\$1,834	\$1,782	\$1,906
	30	30	29	53	21	LKV3030-29SQX	\$1,527	\$1,634	\$1,589	\$1,700

LOK - CONFERENCE

Electrical Options and Upcharges

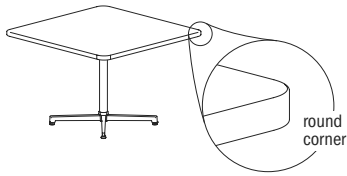
CTEC23	
EC23 Power Center Top - Black	CTEC23BL - add \$643
EC23 Power Center Top - White	CTEC23WH - add \$643
CTEC24	
EC24 Power Center Top - Black	CTEC43BL - add \$533
EC24 Power Center Top - White	CTEC43WH - add \$533

To Order Specify

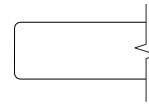
1 Veneer Model #	2 Edge Detail	3 Wood Species	4 Wood Finish	5 Electrical	6 Metal Color
Veneer (LKV)	See Edge Detail Options	Flat Cut CH1 Cherry MA1 Maple WA1 Walnut BO1 Black Oak	See Flat Cut Wood Finish Options	N None CTEC23 Power Center Top CTEC24 Power Center Top (See chart above)	See Metal Finish Color Options
		Double Cut DC1 Double Cut	4 Wood Finish See Double Cut Wood Finish Options		

Description

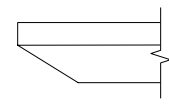
Rounded Square Table with X Base at Working Height



Laminate Tables
"LKT" Models



Eased Edge (R3)



Reverse Bevel Edge (K9)

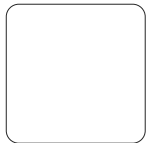
LAMINATE	D	W	H	CTN WT	CU FT	❶ Model	Standard			Graded In		
							Tier 1	Tier 2	Tier 3	Tier 1	Tier 2	Tier 3
	48	48	29	103	49	LKT4848-29SQRX	\$1,978	\$2,032	\$2,197	\$2,432	\$2,487	\$2,651
42	42	29	85	38	LKT4242-29SQRX	\$1,829	\$1,881	\$2,058	\$2,283	\$2,339	\$2,515	
36	36	29	69	29	LKT3636-29SQRX	\$1,509	\$1,551	\$1,618	\$1,964	\$2,007	\$2,073	
30	30	29	53	21	LKT3030-29SQRX	\$1,340	\$1,377	\$1,418	\$1,796	\$1,833	\$1,873	

Features:

- price reflects complete table - top and base
- ships KD in multiple cartons
- one piece top
- model includes adjustable glide
- when electrical option is selected, power accessible base is shipped; see page 178 for details
- power/charging units have 72" cord
- power cord is routed inside base column

Options:

- specify power access base with power unit option; None (N), add \$643 for EC23 (CTEC23), add \$533 for EC24 (CTEC24)



top shape

LOK - CONFERENCE

To Order Specify

❶ Laminite Model #	❷ Edge Detail	❸ Laminite Selection	❹ PVC Edge Color	❺ Electrical	❻ Metal Color
Laminite (LKT)	See Edge Detail Options	See Laminite Selection	See PVC Edge Color Options	N None CTEC23 Power Center Top CTEC24 Power Center Top (See chart on next page)	See Metal Finish Color Options

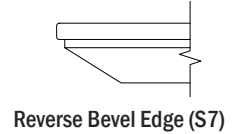
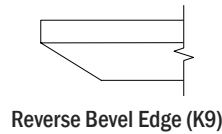
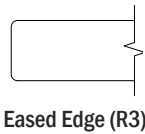
Model Number Breakdown

LKT4848-29SQRX						
LK	T	4848	29	SQ	R	X
LOK	Laminite	48" x 48"	Height	Square Top Shape	Round Corner	X base

Description

Rounded Square Table with X Base at Working Height (continued)

Veneer Tables "LKV" Models Solid Surface Tables "LKS" Models



	D	W	H	CTN WT	CU FT	① Model	Veneer Tables "LKV" Models		Solid Surface Tables "LKS" Models		
							Flat Cut	Double Cut	Flat Cut	Double Cut	Standard
VENEER	48	48	29	103	49	LKV4848-29SQRX	\$2,607	\$2,791	\$2,713	\$2,903	--
	42	42	29	85	38	LKV4242-29SQRX	\$2,423	\$2,592	\$2,522	\$2,697	--
	36	36	29	69	29	LKV3636-29SQRX	\$1,991	\$2,132	\$2,071	\$2,217	--
	30	30	29	53	21	LKV3030-29SQRX	\$1,771	\$1,895	\$1,841	\$1,970	--
SOLID SURFACE	48	48	29	103	49	LKS4848-29SQRX	--	--	--	--	\$5,549
	42	42	29	85	38	LKS4242-29SQRX	--	--	--	--	\$4,786
	36	36	29	69	29	LKS3636-29SQRX	--	--	--	--	\$3,854
	30	30	29	53	21	LKS3030-29SQRX	--	--	--	--	\$3,208

Electrical Options and Upcharges

CTEC23	
EC23 Power Center Top - Black	CTEC23BL - add \$643
EC23 Power Center Top - White	CTEC23WH - add \$643
CTEC24	
EC24 Power Center Top - Black	CTEC43BL - add \$533
EC24 Power Center Top - White	CTEC43WH - add \$533

To Order Specify

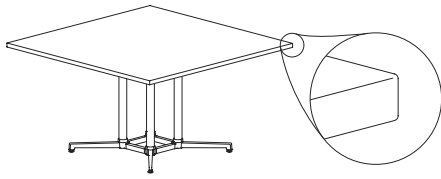
① Veneer Model #	② Edge Detail	③ Wood Species	④ Wood Finish	⑤ Electrical	⑥ Metal Color
Veneer (LKV)	See Edge Detail Options	Flat Cut CH1 Cherry MA1 Maple WA1 Walnut BO1 Black Oak	See Flat Cut Wood Finish Options	N None CTEC23 Power Center Top CTEC24 Power Center Top (See chart above)	See Metal Finish Color Options
		Double Cut DC1 Double Cut	④ Wood Finish See Double Cut Wood Finish Options		

① Solid Surface Model #	② Top Surface Selection	③ Electrical Cut Out	④ Metal Color
Solid Surface (LKS)	See Solid Surface Top Surface Selection Options	N None CTEC23 Power Center Top CTEC24 Power Center Top (See chart above)	See Metal Finish Color Options

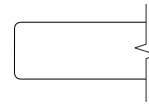
LOK - CONFERENCE

Description

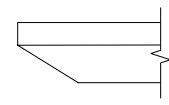
Square Table with X4 Base at Working Height



Laminate Tables "LKT" Models



Eased Edge (R3)



Reverse Bevel Edge (K9)

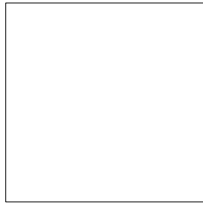
LAMINATE	D	W	H	CTN WT	CU FT	Model	Eased Edge (R3)			Reverse Bevel Edge (K9)		
							Standard	Graded In		Standard	Graded In	
							Tier 1	Tier 2	Tier 3	Tier 1	Tier 2	Tier 3
	60	60	29	174	73	LKT6060-29SQZ	\$2,940	\$3,032	\$3,244	\$3,395	\$3,488	\$3,698
	54	54	29	151	61	LKT5454-29SQZ	\$2,788	\$2,870	\$3,033	\$3,245	\$3,326	\$3,489

Features:

- price reflects complete table - top and base
- ships KD in multiple cartons
- one piece top
- model includes adjustable glide
- power cord is routed outside base column
- order vertical wire manager separately; see page 408

Options:

- specify power unit option; None (N), add \$643 for EC23 (CTEC23), add \$533 for EC24 (CTEC24)



top shape

LOK - CONFERENCE

To Order Specify

1 Laminate Model #	2 Edge Detail	3 Laminate Selection	3a PVC Edge Color	4 Electrical	5 Metal Color
Laminate (LKT)	See Edge Detail Options	See Laminate Selection	See PVC Edge Color Options	N None CTEC23 Power Center Top CTEC24 Power Center Top (See chart on next page)	See Metal Finish Color Options

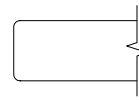
Model Number Breakdown

LKT6060-29SQZ					
LK	T	6060	29	SQ	Z
LOK	Laminate	60" x 60"	Height	Square Top Shape	X4 base

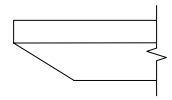
Description

Square Table with X4 Base
at Working Height
(continued)

Veneer Tables
"LKV" Models



Eased Edge (R3)



Reverse Bevel Edge (K9)

VENEER	D	W	H	CTN WT	CU FT	① Model	Eased Edge (R3)		Reverse Bevel Edge (K9)	
							Flat Cut	Double Cut	Flat Cut	Double Cut
	60	60	29	174	73	LKV6060-29SQZ	\$3,879	\$4,152	\$4,035	\$4,318
	54	54	29	151	61	LKV5454-29SQZ	\$3,681	\$3,939	\$3,828	\$4,098

LOK - CONFERENCE

Electrical Options and Upcharges

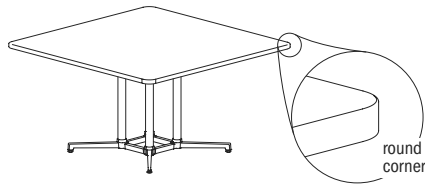
CTEC23	
EC23 Power Center Top - Black	CTEC23BL - add \$643
EC23 Power Center Top - White	CTEC23WH - add \$643
CTEC24	
EC24 Power Center Top - Black	CTEC43BL - add \$533
EC24 Power Center Top - White	CTEC43WH - add \$533

To Order Specify

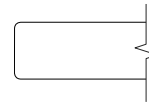
① Veneer Model #	② Edge Detail	③ Wood Species	④ Wood Finish	⑤ Electrical	⑥ Metal Color
Veneer (LKV)	See Edge Detail Options	Flat Cut CH1 Cherry MA1 Maple WA1 Walnut BO1 Black Oak	See Flat Cut Wood Finish Options	N None CTEC23 Power Center Top CTEC24 Power Center Top (See chart above)	See Metal Finish Color Options
		Double Cut DC1 Double Cut	④ Wood Finish See Double Cut Wood Finish Options		

Description

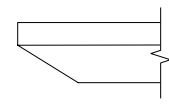
Rounded Square Table with X4 Base at Working Height



Laminate Tables "LKT" Models



Eased Edge (R3)



Reverse Bevel Edge (K9)

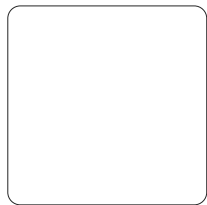
LAMINATE	D	W	H	CTN WT	CU FT	Model	Eased Edge (R3)			Reverse Bevel Edge (K9)		
							Standard	Graded In		Standard	Graded In	
							Tier 1	Tier 2	Tier 3	Tier 1	Tier 2	Tier 3
	60	60	29	174	73	LKT6060-29SQRZ	\$3,175	\$3,256	\$3,476	\$3,630	\$3,711	\$3,931
	54	54	29	151	61	LKT5454-29SQRZ	\$2,591	\$2,674	\$2,838	\$3,047	\$3,128	\$3,292

Features:

- price reflects complete table - top and base
- ships KD in multiple cartons
- one piece top
- model includes adjustable glide
- power cord is routed outside base column
- order vertical wire manager separately; see page 408

Options:

- specify power unit option; None (N), add \$643 for EC23 (CTEC23), add \$533 for EC24 (CTEC24)



top shape

LOK - CONFERENCE

To Order Specify

1 Laminates Model #	2 Edge Detail	3 Laminates Selection	3a PVC Edge Color	4 Electrical	5 Metal Color
Laminates (LKT)	See Edge Detail Options	See Laminates Selection	See PVC Edge Color Options	N None CTEC23 Power Center Top CTEC24 Power Center Top (See chart on next page)	See Metal Finish Color Options

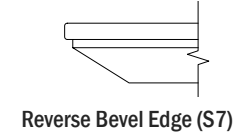
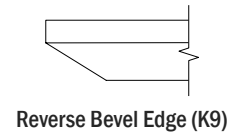
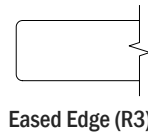
Model Number Breakdown

LKT6060-29SQRZ						
LK	T	6060	29	SQ	R	Z
LOK	Laminates	60" x 60"	Height	Square Top Shape	Round Corner	X4 base

Description

Rounded Square Table with X4 Base at Working Height (continued)

Veneer Tables "LKV" Models	Solid Surface Tables "LKS" Models
----------------------------	-----------------------------------



	D	W	H	CTN WT	CU FT	① Model	Veneer Tables "LKV" Models		Solid Surface Tables "LKS" Models		
							Flat Cut	Double Cut	Flat Cut	Double Cut	Standard
VENEER	60	60	29	174	73	LKV6060-29SQRZ	\$4,190	\$4,485	\$4,358	\$4,664	--
VENEER	54	54	29	151	61	LKV5454-29SQRZ	\$3,421	\$3,660	\$3,557	\$3,807	--
SOL. SURF.	60	60	29	174	73	LKS6060-29SQRZ	--	--	--	--	\$8,515
SOL. SURF.	54	54	29	151	61	LKS5454-29SQRZ	--	--	--	--	\$7,018

Electrical Options and Upcharges

CTEC23	
EC23 Power Center Top - Black	CTEC23BL - add \$643
EC23 Power Center Top - White	CTEC23WH - add \$643
CTEC24	
EC24 Power Center Top - Black	CTEC24BL - add \$533
EC24 Power Center Top - White	CTEC24WH - add \$533

To Order Specify

① Veneer Model #	② Edge Detail	③ Wood Species	④ Wood Finish	⑤ Electrical	⑥ Metal Color
Veneer (LKV)	See Edge Detail Options	Flat Cut CH1 Cherry MA1 Maple WA1 Walnut BO1 Black Oak	See Flat Cut Wood Finish Options	N None CTEC23 Power Center Top CTEC24 Power Center Top (See chart above)	See Metal Finish Color Options
		Double Cut DC1 Double Cut	④ Wood Finish See Double Cut Wood Finish Options		

① Solid Surface Model #	② Top Surface Selection	③ Electrical Cut Out	④ Metal Color
Solid Surface (LKS)	See Solid Surface Top Surface Selection Options	N None CTEC23 Power Center Top CTEC24 Power Center Top (See chart above)	See Metal Finish Color Options

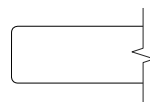
LOK - CONFERENCE

Description

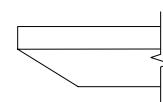
Squircle Table with X Base at Working Height



Laminate Tables "LKT" Models



Eased Edge (R3)



Reverse Bevel Edge (K9)

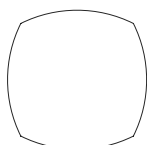
LAMINATE	D	W	H	CTN WT	CU FT	① Model	Eased Edge (R3)			Reverse Bevel Edge (K9)		
							Standard Tier 1	Graded In Tier 2 Tier 3		Standard Tier 1	Graded In Tier 2 Tier 3	
	48	48	29	92	49	LKT48-29SCX	\$1,593	\$1,710	\$1,842	\$2,048	\$2,168	\$2,302
42	42	29	101	38	LKT42-29SCX	\$1,456	\$1,574	\$1,670	\$1,914	\$2,031	\$2,127	
36	36	29	62	29	LKT36-29SCX	\$1,408	\$1,451	\$1,520	\$1,865	\$1,908	\$1,978	
30	30	29	61	21	LKT30-29SCX	\$1,357	\$1,390	\$1,431	\$1,813	\$1,848	\$1,886	

Features:

- price reflects complete table - top and base
- ships KD in multiple cartons
- one piece top
- model includes adjustable glide
- when electrical option is selected, power accessible base is shipped; see page 178 for details
- power/charging units have 72" cord
- power cord is routed inside base column

Options:

- specify power access base with power unit option; None (N), add \$643 for EC23 (CTEC23), add \$533 for EC24 (CTEC24)



top shape

LOK - CONFERENCE

To Order Specify

① Laminate Model #	② Edge Detail	③ Laminate Selection	④ PVC Edge Color	⑤ Electrical	⑥ Metal Color
Laminate (LKT)	See Edge Detail Options	See Laminate Selection	See PVC Edge Color Options	N None CTEC23 Power Center Top CTEC24 Power Center Top (See chart on next page)	See Metal Finish Color Options

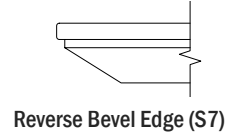
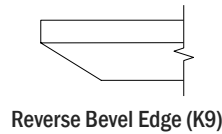
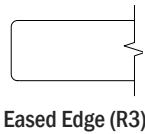
Model Number Breakdown

LKT48-29SQX					
LK	T	48	29	SQ	X
LOK	Laminate	48" dia.	Height	Squircle Top Shape	X base

Description

Squire Table with X Base at Working Height (continued)

Veneer Tables "LKV" Models	Solid Surface Tables "LKS" Models
----------------------------	-----------------------------------



	D	W	H	CTN WT	CU FT	① Model	Veneer Tables "LKV" Models		Solid Surface Tables "LKS" Models		
							Flat Cut	Double Cut	Flat Cut	Double Cut	Standard
VENEER	48	48	29	92	49	LKV48-29SCX	\$2,126	\$2,272	\$2,212	\$2,366	--
	42	42	29	101	38	LKV42-29SCX	\$1,944	\$2,077	\$2,022	\$2,163	--
	36	36	29	62	29	LKV36-29SCX	\$1,880	\$2,011	\$1,957	\$2,095	--
	30	30	29	61	21	LKV30-29SCX	\$1,811	\$1,937	\$1,884	\$2,016	--
SOLID SURFACE	48	48	29	92	49	LKS48-29SCX	--	--	--	--	\$5,086
	42	42	29	101	38	LKS42-29SCX	--	--	--	--	\$4,326
	36	36	29	62	29	LKS36-29SCX	--	--	--	--	\$3,763
	30	30	29	61	21	LKS30-29SCX	--	--	--	--	\$3,268

Electrical Options and Upcharges

CTEC23	
EC23 Power Center Top - Black	CTEC23BL - add \$643
EC23 Power Center Top - White	CTEC23WH - add \$643
CTEC24	
EC24 Power Center Top - Black	CTEC43BL - add \$533
EC24 Power Center Top - White	CTEC43WH - add \$533

To Order Specify

① Veneer Model #	② Edge Detail	③ Wood Species	④ Wood Finish	⑤ Electrical	⑥ Metal Color
Veneer (LKV)	See Edge Detail Options	Flat Cut CH1 Cherry MA1 Maple WA1 Walnut BO1 Black Oak	See Flat Cut Wood Finish Options	N None CTEC23 Power Center Top CTEC24 Power Center Top (See chart above)	See Metal Finish Color Options
		Double Cut DC1 Double Cut	④ Wood Finish See Double Cut Wood Finish Options		

① Solid Surface Model #	② Top Surface Selection	③ Electrical Cut Out	④ Metal Color
Solid Surface (LKS)	See Solid Surface Top Surface Selection Options	N None CTEC23 Power Center Top CTEC24 Power Center Top (See chart above)	See Metal Finish Color Options

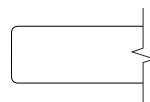
LOK - CONFERENCE

Description

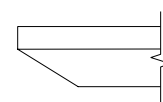
Squircle Table with X4 Base at Working Height



Laminate Tables "LKT" Models



Eased Edge (R3)



Reverse Bevel Edge (K9)

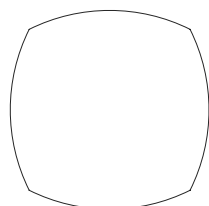
LAMINATE	D	W	H	CTN WT	CU FT	Model	Eased Edge (R3)			Reverse Bevel Edge (K9)		
							Standard	Graded In		Standard	Graded In	
							Tier 1	Tier 2	Tier 3	Tier 1	Tier 2	Tier 3
	60	60	29	156	74	LKT60-29SCZ	\$2,580	\$2,675	\$2,885	\$3,037	\$3,133	\$3,341
	54	54	29	138	61	LKT54-29SCZ	\$2,528	\$2,603	\$2,674	\$2,986	\$3,059	\$3,132

Features:

- price reflects complete table - top and base
- ships KD in multiple cartons
- one piece top
- model includes adjustable glide
- power cord is routed outside base column
- order vertical wire manager separately; see page 408

Options:

- specify power unit option; None (N), add \$643 for EC23 (CTEC23), add \$533 for EC24 (CTEC24)



top shape

LOK - CONFERENCE

To Order Specify

1 Laminates Model #	2 Edge Detail	3 Laminates Selection	3a PVC Edge Color	4 Electrical	5 Metal Color
Laminates (LKT)	See Edge Detail Options	See Laminates Selection	See PVC Edge Color Options	N None CTEC23 Power Center Top CTEC24 Power Center Top (See chart on next page)	See Metal Finish Color Options

Model Number Breakdown

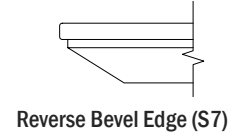
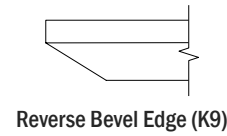
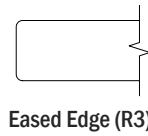
LKT60-29SCZ					
LK	T	60	29	SC	Z
LOK	Laminates	60" dia.	Height	Squircle Top Shape	X4 base

Description

Squirre Table with X4 Base
at Working Height
(continued)

Veneer Tables
"LKV" Models

Solid Surface Tables
"LKS" Models



	D	W	H	CTN WT	CU FT	① Model	Eased Edge (R3)		Reverse Bevel Edge (K9)		Reverse Bevel Edge (S7) Standard
							Flat Cut	Double Cut	Flat Cut	Double Cut	
VENEER	60	60	29	156	74	LKV60-29SCZ	\$3,451	\$3,693	\$3,591	\$3,841	--
	54	54	29	138	61	LKV54-29SCZ	\$3,382	\$3,617	\$3,518	\$3,761	--
SOL. SURF.	60	60	29	156	74	LKS60-29SCZ	--	--	--	--	\$7,796
	54	54	29	138	61	LKS54-29SCZ	--	--	--	--	\$6,996

Electrical Options and Upcharges

CTEC23	
EC23 Power Center Top - Black	CTEC23BL - add \$643
EC23 Power Center Top - White	CTEC23WH - add \$643
CTEC24	
EC24 Power Center Top - Black	CTEC43BL - add \$533
EC24 Power Center Top - White	CTEC43WH - add \$533

To Order Specify

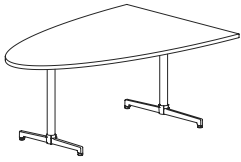
① Veneer Model #	② Edge Detail	③ Wood Species	④ Wood Finish	⑤ Electrical	⑥ Metal Color
Veneer (LKV)	See Edge Detail Options	Flat Cut CH1 Cherry MA1 Maple WA1 Walnut BO1 Black Oak	See Flat Cut Wood Finish Options	N None CTEC23 Power Center Top CTEC24 Power Center Top (See chart above)	See Metal Finish Color Options
		Double Cut DC1 Double Cut	See Double Cut Wood Finish Options		

① Solid Surface Model #	② Top Surface Selection	③ Electrical Cut Out	④ Metal Color
Solid Surface (LKS)	See Solid Surface Top Surface Selection Options	N None CTEC23 Power Center Top CTEC24 Power Center Top (See chart above)	See Metal Finish Color Options

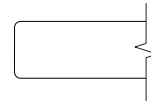
LOK - CONFERENCE

Description

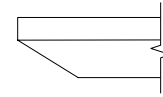
Hive Table with T Base at Working Height



Laminate Tables
"LKT" Models



Eased Edge (R3)



Reverse Bevel Edge (K9)

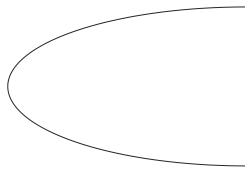
LAM.	D	W	H	CTN WT	CU FT	Model	Standard	Graded In		Standard	Graded In	
							Tier 1	Tier 2	Tier 3	Tier 1	Tier 2	Tier 3
	48	72	29	135	71	LKT4872-29HVT	\$2,042	\$2,084	\$2,347	\$2,537	\$2,579	\$2,767

Features:

- price reflects complete table - top and base
- ships KD in multiple cartons

Options:

- specify power/charging option, see below for options and upcharges
- specify glide (G) or caster (C) -choice of black (BL) or white/grey casters (WG)



top shape

To Order Specify

1 Laminate Model #	2 Edge Detail	3 Laminate Selection	3a PVC Edge Color	4 Electrical
Laminate (LKT)	See Edge Detail Options	See Laminate Selection	See PVC Edge Color Options	N None CT2 Dual Power Center Top (See chart on next page) CU1 Single Power Underside 5 Foot/Caster G Glide C Caster - BL Black Caster - WG White Caster w/Grey Wheels 6 Metal Finish See Metal Finish Color Options

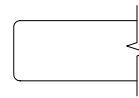
Model Number Breakdown

LKT4872-29HVT					
LK	T	4872	29	HV	T
LOK	Laminate	48" x 72"	Height	Hive Top Shape	T base

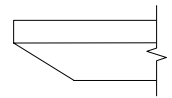
Description

Hive Table with T Base at Working Height (continued)

Veneer Tables "LKV" Models



Eased Edge (R3)



Reverse Bevel Edge (K9)

VEN.	D	W	H	CTN WT	CU FT	① Model	Eased Edge (R3)		Reverse Bevel Edge (K9)	
							Flat Cut	Double Cut	Flat Cut	Double Cut
	48	72	29	135	71	LKV4872-29HVT	\$2,615	\$2,824	\$2,851	\$3,037

Electrical Options and Upcharges

CT2	
Dual Power Center Top - Black	CT2BL - add \$1,437
Dual Power Center Top - White	CT2WH - add \$1,437
CU1	
Single Power Underside - Black	CU11C - add \$559
Single Power Underside with Wireless Charging - Black	CU11CW - add \$1,338

Note: Order power infeed that best fits application, see page 408.

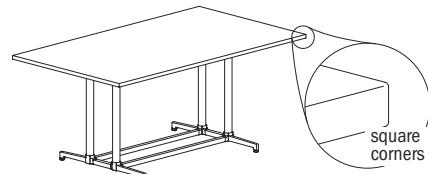
To Order, Specify:

① Veneer Model #	② Edge Detail	③ Wood Species	④ Top Wood Finish	⑤ Electrical	⑥ Base - Foot/ Caster	⑦ Metal Color
Veneer (LKV)	See Edge Detail Options	Flat Cut CH1 Cherry MA1 Maple WA1 Walnut BO1 Black Oak	See Flat Cut Wood Finish Options	N None CT2 Dual Power Center Top CU1 Single Power Underside (See chart above)	G Glide C Caster - BL Black Caster - WG White Caster with Grey Wheels	See Metal Finish Color Options
		Double Cut DC1 Double Cut	④ Top Wood Finish See Double Cut Wood Finish Options			

LOK - CONFERENCE

Description

Rectangular Table with T Base at Counter Height

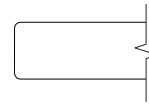


48" wide tables have double column base

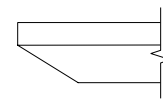
D	W	H	CTN WT	CU FT	Model
48	96	36	233	115	LKT4896-36TTT
48	84	36	209	101	LKT4884-36TTT
42	96	36	186	83	LKT4296-36TTT
42	84	36	167	90	LKT4284-36TTT
36	96	36	166	89	LKT3696-36TTT
36	84	36	149	78	LKT3684-36TTT

LAMINATE

Laminate Tables "LKT" Models



Eased Edge (R3)



Reverse Bevel Edge (K9)

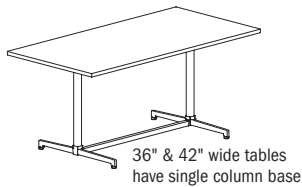
Standard		Graded In		Standard		Graded In		
Tier 1	Tier 2	Tier 3	Tier 1	Tier 2	Tier 3	Tier 1	Tier 2	Tier 3
\$3,287	\$3,338	\$3,656	\$3,759	\$3,809	\$4,038	\$3,467	\$3,511	\$3,711
\$2,945	\$2,988	\$3,268	\$3,401	\$3,449	\$3,647	\$2,896	\$2,934	\$3,110
\$2,445	\$2,485	\$2,729	\$2,896	\$2,934	\$3,110	\$2,445	\$2,485	\$2,729
\$2,494	\$2,534	\$2,774	\$2,944	\$2,982	\$3,150	\$2,494	\$2,534	\$2,774
\$2,250	\$2,284	\$2,494	\$2,691	\$2,723	\$2,876	\$2,250	\$2,284	\$2,494

Features:

- price reflects complete table - top and base
- ships KD in multiple cartons
- one piece top
- model includes adjustable glide

Options:

- specify power/charging option, see below for options and upcharges



top shape

Lok - CONFERENCE

To Order Specify

1 Laminate Model #	2 Edge Detail	3 Laminate Selection	3a PVC Edge Color	4 Electrical	5 Metal Color
Laminate (LKT)	See Edge Detail Options	See Laminate Selection	See PVC Edge Color Options	N None CT2 Dual Power Center Top CU2 Dual Power Underside CT2U1 Dual Power Center Top with Underside (See chart on next page)	See Metal Finish Color Options

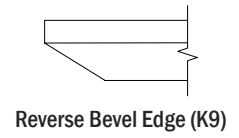
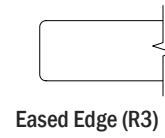
Model Number Breakdown

LKT4896-36TTT					
LK	T	4896	36	TT	T
LOK	Laminate	48" x 96"	Height	Rectangular Top Shape	T base

Description

Rectangular Table with T Base
at Counter Height
(continued)

Veneer Tables
"LKV" Models



VENEER	D	W	H	CTN WT	CU FT	① Model	Flat Cut	Double Cut	Flat Cut	Double Cut
		48	96	36	233	115	LKV4896-36TTT	\$4,562	\$4,900	\$4,871
	48	84	36	209	101	LKV4884-36TTT	\$4,261	\$4,554	\$4,550	\$4,820
	42	96	36	186	83	LKV4296-36TTT	\$4,378	\$4,728	\$4,773	\$5,082
	42	84	36	167	90	LKV4284-36TTT	\$3,700	\$3,996	\$4,033	\$4,295
	36	96	36	166	89	LKV3696-36TTT	\$3,361	\$3,631	\$3,665	\$3,902
	36	84	36	149	78	LKV3684-36TTT	\$3,107	\$3,355	\$3,386	\$3,606

Electrical Options and Upcharges

CT2	84 - 96 wide
Dual Power Center Top - Black	CT2BL - add \$1,490
Dual Power Center Top - White	CT2WH - add \$1,490
CU1	
Dual Power Underside - Black	CU1-1C - add \$592
Dual Power Underside with Wireless Charging - Black	CU1-1CW - add \$1,371
CT2U1	
Dual Power Center Top - Black with Underside	CT2U1-BL - add \$1,813
Dual Power Center Top - White with Underside	CT2U1-WH - add \$1,813
Dual Power Center Top - Black with Wireless Charging	CT2U1-BLW2 - add \$2,592
Dual Power Center Top - White with Wireless Charging	CT2U1-WhW2 - add \$2,592

Note: Order power infeed that best fits application

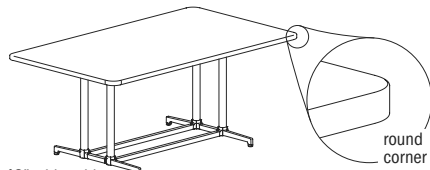
To Order Specify

① Veneer Model #	② Edge Detail	③ Wood Species	④ Wood Finish	⑤ Electrical	⑥ Metal Color
Veneer (LKV)	See Edge Detail Options	Flat Cut CH1 Cherry MA1 Maple WA1 Walnut BO1 Black Oak	See Flat Cut Wood Finish Options	N None CT2 Dual Power Center Top CU2 Dual Power Underside CT2U1 Dual Power Center Top with Underside (See chart above)	See Metal Finish Color Options
		Double Cut DC1 Double Cut	④ Wood Finish See Double Cut Wood Finish Options		

LOK - CONFERENCE

Description

Rounded Rectangular Table with T Base at Counter Height



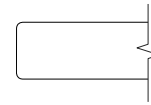
48" wide tables have double column base

D	W	H	CTN WT	CU FT	Model
48	96	36	233	115	LKT4896-36TTRT
48	84	36	209	101	LKT4884-36TTRT

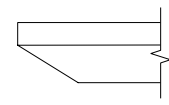
LAMINATE

42	96	36	186	83	LKT4296-36TTRT
42	84	36	167	90	LKT4284-36TTRT
36	96	36	166	89	LKT3696-36TTRT
36	84	36	149	78	LKT3684-36TTRT

Laminate Tables "LKT" Models



Eased Edge (R3)



Reverse Bevel Edge (K9)

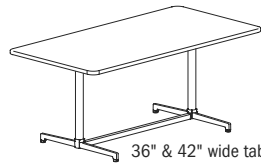
Standard		Graded In		Standard		Graded In		
Tier 1	Tier 2	Tier 3	Tier 1	Tier 2	Tier 3	Tier 1	Tier 2	Tier 3
\$3,368	\$3,420	\$3,739	\$3,841	\$3,892	\$4,119	\$3,524	\$3,570	\$3,768
\$3,000	\$3,047	\$3,326	\$3,461	\$3,506	\$3,705	\$2,949	\$2,988	\$3,163
\$2,549	\$2,587	\$2,825	\$2,996	\$3,033	\$3,205	\$2,740	\$2,774	\$2,924
\$2,302	\$2,335	\$2,544						

Features:

- price reflects complete table - top and base
- ships KD in multiple cartons
- one piece top
- model includes adjustable glide

Options:

- specify power/charging option, see below for options and upcharges



36" & 42" wide tables have single column base



top shape

LOK - CONFERENCE

To Order Specify

1 Laminate Model #	2 Edge Detail	3 Laminate Selection	3a PVC Edge Color	4 Electrical	5 Metal Color
Laminate (LKT)	See Edge Detail Options	See Laminate Selection	See PVC Edge Color Options	N None CT2 Dual Power Center Top CU2 Dual Power Underside CT2U1 Dual Power Center Top with Underside (See chart on next page)	See Metal Finish Color Options

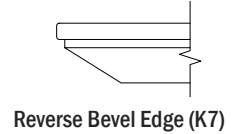
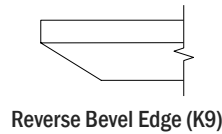
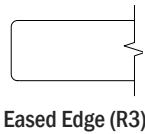
Model Number Breakdown

LKT4896-36TTRT						
LK	T	4896	36	TT	R	T
LOK	Laminate	48" x 96"	Height	Rectangular Top Shape	Rounded Corner	T Base

Description

Rounded Rectangular Table with T Base at Counter Height (continued)

Veneer Tables "LKV" Models	Solid Surface Tables "LKS" Models
----------------------------	-----------------------------------



	D	W	H	CTN WT	CU FT	① Model	Veneer Tables "LKV" Models		Solid Surface Tables "LKS" Models		
							Flat Cut	Double Cut	Flat Cut	Double Cut	Standard
VENEER	48	96	36	233	115	LKV4896-36TTRT	\$4,665	\$5,005	\$4,975	\$5,287	--
	48	84	36	209	101	LKV4884-36TTRT	\$4,334	\$4,625	\$4,623	\$4,894	--
	42	96	36	186	83	LKV4296-36TTRT	\$4,451	\$4,808	\$4,851	\$5,168	--
	42	84	36	167	90	LKV4284-36TTRT	\$3,767	\$4,068	\$4,106	\$4,370	--
	36	96	36	166	89	LKV3696-36TTRT	\$3,426	\$3,702	\$3,736	\$3,977	--
	36	84	36	149	78	LKV3684-36TTRT	\$3,166	\$3,421	\$3,454	\$3,676	--
SOLID SURFACE	48	96	36	233	115	LKS4896-36TTRT	--	--	--	--	\$10,547
	48	84	36	209	101	LKS4884-36TTRT	--	--	--	--	\$9,437
	42	96	36	186	83	LKS4296-36TTRT	--	--	--	--	\$8,528
	42	84	36	167	90	LKS4284-36TTRT	--	--	--	--	\$7,537
	36	96	36	166	89	LKS3696-36TTRT	--	--	--	--	\$7,515
	36	84	36	149	78	LKS3684-36TTRT	--	--	--	--	\$6,790

Electrical Options and Upcharges

CT2	84 - 96 wide
Dual Power Center Top - Black	CT2BL - add \$1,490
Dual Power Center Top - White	CT2WH - add \$1,490
CU1	
Dual Power Underside - Black	CU1-1C - add \$592
Dual Power Underside with Wireless Charging - Black	CU1-1CW - add \$1,371
CT2U1	
Dual Power Center Top - Black with Underside	CT2U1-BL - add \$1,813
Dual Power Center Top - White with Underside	CT2U1-WH - add \$1,813
Dual Power Center Top - Black with Wireless Charging	CT2U1-BLW2 - add \$2,592
Dual Power Center Top - White with Wireless Charging	CT2U1-WHW2 - add \$2,592

Note: Order power infed that best fits application

To Order Specify

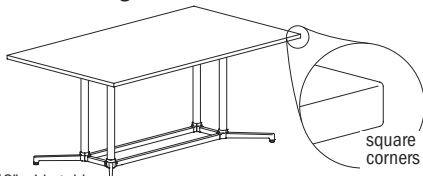
① Veneer Model #	② Edge Detail	③ Wood Species	④ Wood Finish	⑤ Electrical	⑥ Metal Color
Veneer (LKV)	See Edge Detail Options	Flat Cut CH1 Cherry MA1 Maple WA1 Walnut BO1 Black Oak	See Flat Cut Wood Finish Options	N None CT2 Dual Power Center Top CU2 Dual Power Underside CT2U1 Dual Power Center Top with Underside (See chart above)	See Metal Finish Color Options
		Double Cut DC1 Double Cut	See Double Cut Wood Finish Options		

① Solid Surface Model #	② Top Surface Selection	③ Electrical	④ Metal Color
Solid Surface (LKS)	See Solid Surface Top Surface Selection Options	N None CT2 Dual Power Center Top CU2 Dual Power Underside CT2U1 Dual Power Center Top with Underside (See chart above)	See Metal Finish Color Options

LOK - CONFERENCE

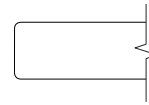
Description

Rectangular Table with Y Base at Counter Height

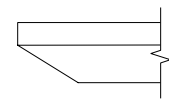


48" wide tables have double column base

Laminate Tables "LKT" Models



Eased Edge (R3)



Reverse Bevel Edge (K9)

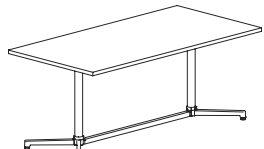
LAMINATE	D	W	H	CTN WT	CU FT	Model	Eased Edge (R3)			Reverse Bevel Edge (K9)		
							Standard	Graded In		Standard	Graded In	
							Tier 1	Tier 2	Tier 3	Tier 1	Tier 2	Tier 3
	48	96	36	232	115	LKT4896-36TTY	\$3,319	\$3,371	\$3,690	\$3,792	\$3,844	\$4,070
	48	84	36	209	101	LKT4884-36TTY	\$2,938	\$2,983	\$3,261	\$3,398	\$3,444	\$3,641
	42	96	36	197	102	LKT4296-36TTY	\$3,761	\$3,807	\$4,086	\$4,222	\$4,266	\$4,466
	42	84	36	178	89	LKT4284-36TTY	\$2,560	\$2,599	\$2,843	\$3,010	\$3,049	\$3,223
	36	96	36	177	89	LKT3696-36TTY	\$2,572	\$2,611	\$2,850	\$3,020	\$3,059	\$3,230
	36	84	36	159	78	LKT3684-36TTY	\$2,286	\$2,320	\$2,529	\$2,726	\$2,760	\$2,910

Features:

- price reflects complete table - top and base
- ships KD in multiple cartons
- one piece top
- model includes adjustable glide

Options:

- specify power/charging option, see below for options and upcharges



36" & 42" wide tables have single column base



top shape

LOK - CONFERENCE

To Order Specify

1 Laminate Model #	2 Edge Detail	3 Laminate Selection	3a PVC Edge Color	4 Electrical	5 Metal Color
Laminate (LKT)	See Edge Detail Options	See Laminate Selection	See PVC Edge Color Options	N None CT2 Dual Power Center Top CU2 Dual Power Underside CT2U1 Dual Power Center Top with Underside (See chart on next page)	See Metal Finish Color Options

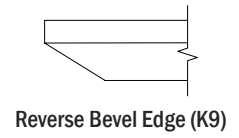
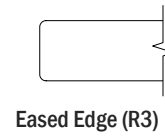
Model Number Breakdown

LKT4896-36TTY					
LK	T	4896	36	TT	Y
LOK	Laminate	48" x 96"	Height	Rectangular Top Shape	Y Base

Description

Rectangular Table with Y Base
at Counter Height
(continued)

Veneer Tables
"LKV" Models



VENEER	D	W	H	CTN WT	CU FT	① Model	Flat Cut	Double Cut	Flat Cut	Double Cut
		48	96	36	232	115	LKV4896-36TTY	\$4,604	\$4,941	\$4,912
	48	84	36	209	101	LKV4884-36TTY	\$4,175	\$4,467	\$4,465	\$4,735
	42	96	36	197	102	LKV4296-36TTY	\$5,403	\$5,834	\$5,888	\$6,269
	42	84	36	178	89	LKV4284-36TTY	\$3,842	\$4,149	\$4,188	\$4,460
	36	96	36	177	89	LKV3696-36TTY	\$3,458	\$3,734	\$3,768	\$4,012
	36	84	36	159	78	LKV3684-36TTY	\$3,149	\$3,400	\$3,433	\$3,656

Electrical Options and Upcharges

CT2	84 - 96 wide
Dual Power Center Top - Black	CT2BL - add \$1,490
Dual Power Center Top - White	CT2WH - add \$1,490
CU1	
Dual Power Underside - Black	CU1-1C - add \$592
Dual Power Underside with Wireless Charging - Black	CU1-1CW - add \$1,371
CT2U1	
Dual Power Center Top - Black with Underside	CT2U1-BL - add \$1,813
Dual Power Center Top - White with Underside	CT2U1-WH - add \$1,813
Dual Power Center Top - Black with Wireless Charging	CT2U1-BLW2 - add \$2,592
Dual Power Center Top - White with Wireless Charging	CT2U1-WhW2 - add \$2,592

Note: Order power infeed that best fits application

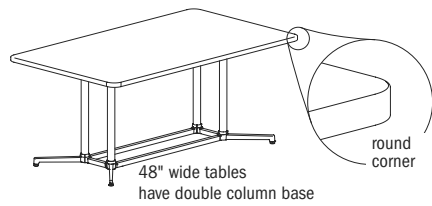
To Order Specify

① Veneer Model #	② Edge Detail	③ Wood Species	④ Wood Finish	⑤ Electrical	⑥ Metal Color
Veneer (LKV)	See Edge Detail Options	Flat Cut CH1 Cherry MA1 Maple WA1 Walnut BO1 Black Oak	See Flat Cut Wood Finish Options	N None CT2 Dual Power Center Top CU2 Dual Power Underside CT2U1 Dual Power Center Top with Underside (See chart above)	See Metal Finish Color Options
		Double Cut DC1 Double Cut	④ Wood Finish See Double Cut Wood Finish Options		

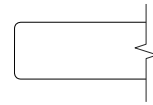
LOK - CONFERENCE

Description

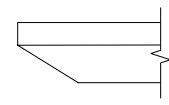
Rounded Rectangular Table with Y Base at Counter Height



Laminate Tables
"LKT" Models



Eased Edge (R3)



Reverse Bevel Edge (K9)

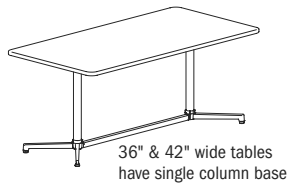
LAMINATE	D	W	H	CTN WT	CU FT	Model	Eased Edge (R3)			Reverse Bevel Edge (K9)		
							Standard	Graded In		Standard	Graded In	
							Tier 1	Tier 2	Tier 3	Tier 1	Tier 2	Tier 3
	48	96	36	232	115	LKT4896-36TTRY	\$3,383	\$3,433	\$3,753	\$3,854	\$3,906	\$4,133
	48	84	36	209	101	LKT4884-36TTRY	\$2,995	\$3,040	\$3,318	\$3,457	\$3,501	\$3,700
	42	96	36	197	102	LKT4296-36TTRY	\$3,821	\$3,865	\$4,144	\$4,279	\$4,325	\$4,525
	42	84	36	178	89	LKT4284-36TTRY	\$2,612	\$2,651	\$2,897	\$3,063	\$3,102	\$3,277
	36	96	36	177	89	LKT3696-36TTRY	\$2,626	\$2,664	\$2,903	\$3,073	\$3,111	\$3,284
	36	84	36	159	78	LKT3684-36TTRY	\$2,336	\$2,370	\$2,579	\$2,776	\$2,811	\$2,959

Features:

- price reflects complete table - top and base
- ships KD in multiple cartons
- one piece top
- model includes adjustable glide

Options:

- specify power/charging option, see below for options and upcharges



To Order Specify

1 Laminate Model #	2 Edge Detail	3 Laminate Selection	3a PVC Edge Color	4 Electrical	5 Metal Color
Laminate (LKT)	See Edge Detail Options	See Laminate Selection	See PVC Edge Color Options	N None CT2 Dual Power Center Top CU2 Dual Power Underside CT2U1 Dual Power Center Top with Underside (See chart on next page)	See Metal Finish Color Options

Model Number Breakdown

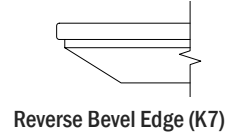
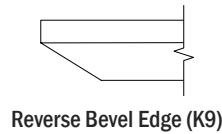
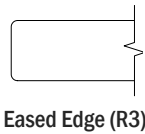
LKT4896-36TTRY						
LK	T	4896	36	TT	R	Y
LOK	Laminate	48" x 96"	Height	Rectangular Top Shape	Rounded Corner	Y Base

Description

Rounded Rectangular Table with Y Base at Counter Height (continued)

Veneer Tables "LKV" Models

Solid Surface Tables "LKS" Models



	D	W	H	CTN WT	CU FT	① Model	Veneer Tables "LKV" Models		Solid Surface Tables "LKS" Models		
							Flat Cut	Double Cut	Flat Cut	Double Cut	Standard
VENEER	48	96	36	232	115	LKV4896-36TTRY	\$4,683	\$5,022	\$4,992	\$5,309	--
	48	84	36	209	101	LKV4884-36TTRY	\$4,249	\$4,539	\$4,536	\$4,809	--
	42	96	36	197	102	LKV4296-36TTRY	\$5,474	\$5,912	\$5,967	\$6,354	--
	42	84	36	178	89	LKV4284-36TTRY	\$3,906	\$4,218	\$4,257	\$4,535	--
	36	96	36	177	89	LKV3696-36TTRY	\$3,521	\$3,803	\$3,836	\$4,087	--
	36	84	36	159	78	LKV3684-36TTRY	\$3,211	\$3,467	\$3,499	\$3,726	--
SOLID SURFACE	48	96	36	232	115	LKS4896-36TTRY	--	--	--	--	\$10,564
	48	84	36	209	101	LKS4884-36TTRY	--	--	--	--	\$9,352
	42	96	36	197	102	LKS4296-36TTRY	--	--	--	--	\$9,553
	42	84	36	178	89	LKS4284-36TTRY	--	--	--	--	\$7,677
	36	96	36	177	89	LKS3696-36TTRY	--	--	--	--	\$7,610
	36	84	36	159	78	LKS3684-36TTRY	--	--	--	--	\$6,833

Electrical Options and Upcharges

CT2	84 - 96 wide
Dual Power Center Top - Black	CT2BL - add \$1,490
Dual Power Center Top - White	CT2WH - add \$1,490
CU1	
Dual Power Underside - Black	CU1-1C - add \$592
Dual Power Underside with Wireless Charging - Black	CU1-1CW - add \$1,371
CT2U1	
Dual Power Center Top - Black with Underside	CT2U1-BL - add \$1,813
Dual Power Center Top - White with Underside	CT2U1-WH - add \$1,813
Dual Power Center Top - Black with Wireless Charging	CT2U1-BLW2 - add \$2,592
Dual Power Center Top - White with Wireless Charging	CT2U1-WHW2 - add \$2,592

Note: Order power infeed that best fits application

To Order Specify

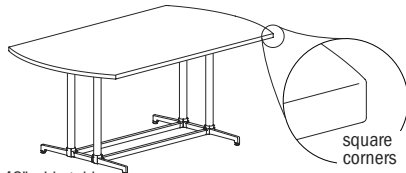
① Veneer Model #	② Edge Detail	③ Wood Species	④ Wood Finish	⑤ Electrical	⑥ Metal Color
Veneer (LKV)	See Edge Detail Options	Flat Cut CH1 Cherry MA1 Maple WA1 Walnut BO1 Black Oak	See Flat Cut Wood Finish Options	N None CT2 Dual Power Center Top CU2 Dual Power Underside CT2U1 Dual Power Center Top with Underside (See chart above)	See Metal Finish Color Options
		Double Cut DC1 Double Cut	④ Wood Finish See Double Cut Wood Finish Options		

① Solid Surface Model #	② Top Surface Selection	③ Electrical	④ Metal Color
Solid Surface (LKS)	See Solid Surface Top Surface Selection Options	N None CT2 Dual Power Center Top CU2 Dual Power Underside CT2U1 Dual Power Center Top with Underside (See chart above)	See Metal Finish Color Options

LOK - CONFERENCE

Description

Arc Rectangular Table with T Base at Counter Height



48" wide tables have double column base

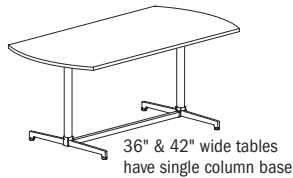
LAMINATE	D	W	H	CTN WT	CU FT	Model	Laminate Tables "LKT" Models					
							Eased Edge (R3)			Reverse Bevel Edge (K9)		
							Standard Tier 1	Graded In Tier 2 Tier 3		Standard Tier 1	Graded In Tier 2 Tier 3	
	48	96	36	226	115	LKT4896-36ART	\$3,368	\$3,420	\$3,739	\$3,841	\$3,892	\$4,119
	48	84	36	202	101	LKT4884-36ART	\$3,063	\$3,108	\$3,388	\$3,524	\$3,570	\$3,768
	42	96	36	182	83	LKT4296-36ART	\$3,000	\$3,047	\$3,326	\$3,461	\$3,506	\$3,705
	42	84	36	162	90	LKT4284-36ART	\$2,499	\$2,538	\$2,782	\$2,949	\$2,988	\$3,163
	36	96	36	163	89	LKT3696-36ART	\$2,549	\$2,587	\$2,825	\$2,996	\$3,033	\$3,205
	36	84	36	145	78	LKT3684-36ART	\$2,302	\$2,335	\$2,544	\$2,740	\$2,774	\$2,924

Features:

- price reflects complete table - top and base
- ships KD in multiple cartons
- one piece top
- model includes adjustable glide

Options:

- specify power/charging option, see below for options and upcharges



LOK - CONFERENCE

To Order Specify

1 Laminate Model #	2 Edge Detail	3 Laminate Selection	3a PVC Edge Color	4 Electrical	5 Metal Color
Laminate (LKT)	See Edge Detail Options	See Laminate Selection	See PVC Edge Color Options	N None CT2 Dual Power Center Top CU2 Dual Power Underside CT2U1 Dual Power Center Top with Underside (See chart on next page)	See Metal Finish Color Options

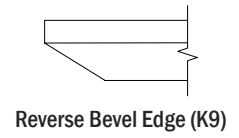
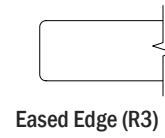
Model Number Breakdown

LKT4896-36ART					
LK	T	4896	36	AR	T
LOK	Laminate	48" x 96"	Height	Arc Rectangular Top Shape	T Base

Description

Arc Rectangular Table with T Base at Counter Height (continued)

Veneer Tables "LKV" Models



D	W	H	CTN WT	CU FT	① Model	Eased Edge (R3)		Reverse Bevel Edge (K9)	
						Flat Cut	Double Cut	Flat Cut	Double Cut
48	96	36	226	115	LKV4896-36ART	\$4,665	\$5,005	\$4,975	\$5,287
48	84	36	202	101	LKV4884-36ART	\$4,334	\$4,625	\$4,623	\$4,894
42	96	36	182	83	LKV4296-36ART	\$4,451	\$4,808	\$4,851	\$5,168
	84	36	162	90	LKV4284-36ART	\$3,767	\$4,068	\$4,106	\$4,370
36	96	36	163	89	LKV3696-36ART	\$3,426	\$3,702	\$3,736	\$3,977
36	84	36	145	78	LKV3684-36ART	\$3,166	\$3,421	\$3,454	\$3,676

Electrical Options and Upcharges

CT2	84 - 96 wide
Dual Power Center Top - Black	CT2BL - add \$1,490
Dual Power Center Top - White	CT2WH - add \$1,490
CU1	
Dual Power Underside - Black	CU1-1C - add \$592
Dual Power Underside with Wireless Charging - Black	CU1-1CW - add \$1,371
CT2U1	
Dual Power Center Top - Black with Underside	CT2U1-BL - add \$1,813
Dual Power Center Top - White with Underside	CT2U1-WH - add \$1,813
Dual Power Center Top - Black with Wireless Charging	CT2U1-BLW2 - add \$2,592
Dual Power Center Top - White with Wireless Charging	CT2U1-WHW2 - add \$2,592

Note: Order power infeed that best fits application

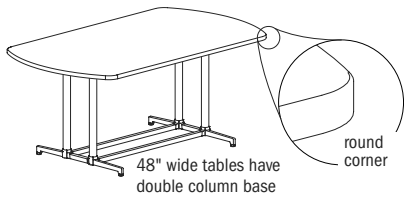
To Order Specify

① Veneer Model #	② Edge Detail	③ Wood Species	④ Wood Finish	⑤ Electrical	⑥ Metal Color
Veneer (LKV)	See Edge Detail Options	Flat Cut CH1 Cherry MA1 Maple WA1 Walnut BO1 Black Oak	See Flat Cut Wood Finish Options	N None CT2 Dual Power Center Top CU2 Dual Power Underside CT2U1 Dual Power Center Top with Underside (See chart above)	See Metal Finish Color Options
		Double Cut DC1 Double Cut	④ Wood Finish See Double Cut Wood Finish Options		

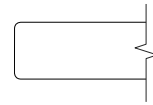
LOK - CONFERENCE

Description

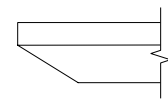
Rounded Arc Rectangular Table with T Base at Counter Height



Laminate Tables "LKT" Models



Eased Edge (R3)



Reverse Bevel Edge (K9)

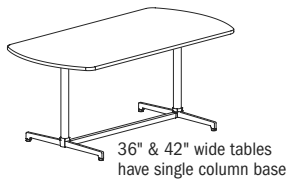
LAMINATE	D	W	H	CTN WT	CU FT	Model	Eased Edge (R3)		Reverse Bevel Edge (K9)			
							Standard	Graded In	Standard	Graded In		
							Tier 1	Tier 2	Tier 3	Tier 1	Tier 2	Tier 3
	48	96	36	226	115	LKT4896-36ARRT	\$3,368	\$3,420	\$3,739	\$3,841	\$3,892	\$4,119
	48	84	36	202	101	LKT4884-36ARRT	\$3,063	\$3,108	\$3,388	\$3,524	\$3,570	\$3,768
	42	96	36	182	83	LKT4296-36ARRT	\$3,000	\$3,047	\$3,326	\$3,461	\$3,506	\$3,705
	42	84	36	162	90	LKT4284-36ARRT	\$2,499	\$2,538	\$2,782	\$2,949	\$2,988	\$3,163
	36	96	36	163	89	LKT3696-36ARRT	\$2,549	\$2,587	\$2,825	\$2,996	\$3,033	\$3,205
	36	84	36	145	78	LKT3684-36ARRT	\$2,302	\$2,335	\$2,544	\$2,740	\$2,774	\$2,924

Features:

- price reflects complete table - top and base
- ships KD in multiple cartons
- one piece top
- model includes adjustable glide

Options:

- specify power/charging option, see below for options and upcharges



LOK - CONFERENCE

To Order Specify

1 Laminate Model #	2 Edge Detail	3 Laminate Selection	3a PVC Edge Color	4 Electrical	5 Metal Color
Laminate (LKT)	See Edge Detail Options	See Laminate Selection	See PVC Edge Color Options	N None CT2 Dual Power Center Top CU2 Dual Power Underside CT2U1 Dual Power Center Top with Underside (See chart on next page)	See Metal Finish Color Options

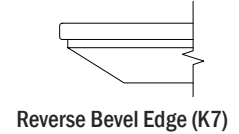
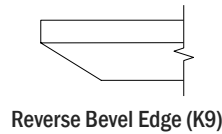
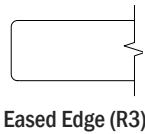
Model Number Breakdown

LKT4896-36ARRT						
LK	T	4896	36	AR	R	T
LOK	Laminate	48" x 96"	Height	Arc Rectangular Top Shape	Rounded Corner	T Base

Description

Rounded Arc Rectangular Table with T Base at Counter Height (continued)

Veneer Tables "LKV" Models Solid Surface Tables "LKS" Models



	D	W	H	CTN WT	CU FT	① Model	Veneer Tables "LKV" Models		Solid Surface Tables "LKS" Models		
							Flat Cut	Double Cut	Flat Cut	Double Cut	Standard
VENEER	48	96	36	226	115	LKV4896-36ARRT	\$4,665	\$5,005	\$4,975	\$5,287	--
	48	84	36	202	101	LKV4884-36ARRT	\$4,334	\$4,625	\$4,623	\$4,894	--
	42	96	36	182	83	LKV4296-36ARRT	\$4,451	\$4,808	\$4,851	\$5,168	--
	42	84	36	162	90	LKV4284-36ARRT	\$3,767	\$4,068	\$4,106	\$4,370	--
	36	96	36	163	89	LKV3696-36ARRT	\$3,426	\$3,702	\$3,736	\$3,977	--
	36	84	36	145	78	LKV3684-36ARRT	\$3,166	\$3,421	\$3,454	\$3,676	--
SOLID SURFACE	48	96	36	226	115	LKS4896-36ARRT	--	--	--	--	\$10,547
	48	84	36	202	101	LKS4884-36ARRT	--	--	--	--	\$9,437
	42	96	36	182	83	LKS4296-36ARRT	--	--	--	--	\$8,528
	42	84	36	162	90	LKS4284-36ARRT	--	--	--	--	\$7,537
	36	96	36	163	89	LKS3696-36ARRT	--	--	--	--	\$7,515
	36	84	36	145	78	LKS3684-36ARRT	--	--	--	--	\$6,790

Electrical Options and Upcharges

CT2	84 - 96 wide
Dual Power Center Top - Black	CT2BL - add \$1,490
Dual Power Center Top - White	CT2WH - add \$1,490
CU1	
Dual Power Underside - Black	CU1-1C - add \$592
Dual Power Underside with Wireless Charging - Black	CU1-1CW - add \$1,371
CT2U1	
Dual Power Center Top - Black with Underside	CT2U1-BL - add \$1,813
Dual Power Center Top - White with Underside	CT2U1-WH - add \$1,813
Dual Power Center Top - Black with Wireless Charging	CT2U1-BLW2 - add \$2,592
Dual Power Center Top - White with Wireless Charging	CT2U1-WHW2 - add \$2,592

Note: Order power infed that best fits application

To Order Specify

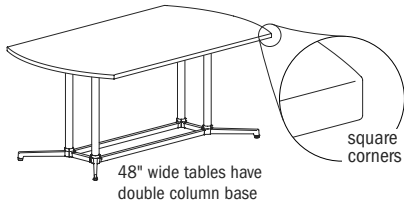
① Veneer Model #	② Edge Detail	③ Wood Species	④ Wood Finish	⑤ Electrical	⑥ Metal Color
Veneer (LKV)	See Edge Detail Options	Flat Cut CH1 Cherry MA1 Maple WA1 Walnut BO1 Black Oak	See Flat Cut Wood Finish Options	N None CT2 Dual Power Center Top CU2 Dual Power Underside CT2U1 Dual Power Center Top with Underside (See chart above)	See Metal Finish Color Options
		Double Cut DC1 Double Cut	④ Wood Finish See Double Cut Wood Finish Options		

① Solid Surface Model #	② Top Surface Selection	③ Electrical	④ Metal Color
Solid Surface (LKS)	See Solid Surface Top Surface Selection Options	N None CT2 Dual Power Center Top CU2 Dual Power Underside CT2U1 Dual Power Center Top with Underside (See chart above)	See Metal Finish Color Options

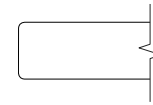
LOK - CONFERENCE

Description

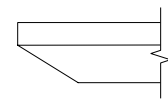
Arc Rectangular Table with Y Base at Counter Height



Laminate Tables "LKT" Models



Eased Edge (R3)



Reverse Bevel Edge (K9)

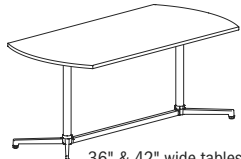
LAMINATE	D	W	H	CTN WT	CU FT	Model	Eased Edge (R3)			Reverse Bevel Edge (K9)		
							Standard	Graded In		Standard	Graded In	
							Tier 1	Tier 2	Tier 3	Tier 1	Tier 2	Tier 3
	48	96	36	226	115	LKT4896-36ARY	\$3,383	\$3,433	\$3,753	\$3,854	\$3,906	\$4,133
	48	84	36	201	101	LKT4884-36ARY	\$2,995	\$3,040	\$3,318	\$3,457	\$3,501	\$3,700
	42	96	36	193	102	LKT4296-36ARY	\$3,821	\$3,865	\$4,144	\$4,279	\$4,325	\$4,525
	42	84	36	172	89	LKT4284-36ARY	\$2,612	\$2,651	\$2,897	\$3,063	\$3,102	\$3,277
	36	96	36	177	89	LKT3696-36ARY	\$2,626	\$2,664	\$2,903	\$3,073	\$3,111	\$3,284
	36	84	36	156	78	LKT3684-36ARY	\$2,336	\$2,370	\$2,579	\$2,776	\$2,811	\$2,959

Features:

- price reflects complete table - top and base
- ships KD in multiple cartons
- one piece top
- model includes adjustable glide

Options:

- specify power/charging option, see below for options and upcharges



36" & 42" wide tables have single column base

LOK - CONFERENCE

To Order Specify

1 Laminate Model #	2 Edge Detail	3 Laminate Selection	3a PVC Edge Color	4 Electrical	5 Metal Color
Laminate (LKT)	See Edge Detail Options	See Laminate Selection	See PVC Edge Color Options	N None CT2 Dual Power Center Top CU2 Dual Power Underside CT2U1 Dual Power Center Top with Underside (See chart on next page)	See Metal Finish Color Options

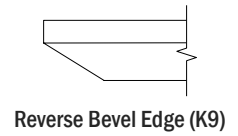
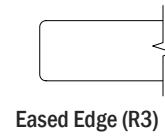
Model Number Breakdown

LKT4896-36ARY					
LK	T	4896	36	AR	Y
LOK	Laminate	48" x 96"	Height	Arc Rectangular Top Shape	Y Base

Description

Arc Rectangular Table with Y Base at Counter Height (continued)

Veneer Tables "LKV" Models



VENEER	D	W	H	CTN WT	CU FT	1 Model	Flat Cut	Double Cut	Flat Cut	Double Cut
		48	96	36	226	115	LKV4896-36ARY	\$4,683	\$5,022	\$4,992
	48	84	36	201	101	LKV4884-36ARY	\$4,249	\$4,539	\$4,536	\$4,809
	42	96	36	193	102	LKV4296-36ARY	\$5,474	\$5,912	\$5,967	\$6,354
	42	84	36	172	89	LKV4284-36ARY	\$3,906	\$4,218	\$4,257	\$4,535
	36	96	36	177	89	LKV3696-36ARY	\$3,521	\$3,803	\$3,836	\$4,087
	36	84	36	156	78	LKV3684-36ARY	\$3,211	\$3,467	\$3,499	\$3,726

Electrical Options and Upcharges

CT2	84 - 96 wide
Dual Power Center Top - Black	CT2BL - add \$1,490
Dual Power Center Top - White	CT2WH - add \$1,490
CU1	
Dual Power Underside - Black	CU1-1C - add \$592
Dual Power Underside with Wireless Charging - Black	CU1-1CW - add \$1,371
CT2U1	
Dual Power Center Top - Black with Underside	CT2U1-BL - add \$1,813
Dual Power Center Top - White with Underside	CT2U1-WH - add \$1,813
Dual Power Center Top - Black with Wireless Charging	CT2U1-BLW2 - add \$2,592
Dual Power Center Top - White with Wireless Charging	CT2U1-WhW2 - add \$2,592

Note: Order power infeed that best fits application

To Order Specify

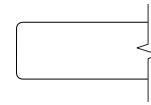
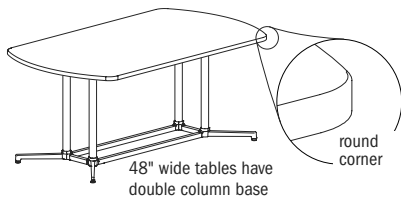
1 Veneer Model #	2 Edge Detail	3 Wood Species	4 Wood Finish	5 Electrical	6 Metal Color
Veneer (LKV)	See Edge Detail Options	Flat Cut CH1 Cherry MA1 Maple WA1 Walnut BO1 Black Oak	See Flat Cut Wood Finish Options	N None CT2 Dual Power Center Top CU2 Dual Power Underside CT2U1 Dual Power Center Top with Underside (See chart above)	See Metal Finish Color Options
		Double Cut DC1 Double Cut	4 Wood Finish See Double Cut Wood Finish Options		

LOK - CONFERENCE

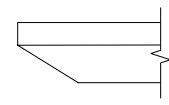
Description

Rounded Arc Rectangular Table with Y Base at Counter Height

Laminate Tables "LKT" Models



Eased Edge (R3)



Reverse Bevel Edge (K9)

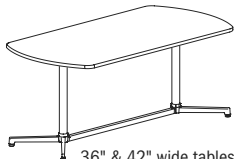
LAMINATE	D	W	H	CTN WT	CU FT	Model	Eased Edge (R3)			Reverse Bevel Edge (K9)		
							Standard	Graded In		Standard	Graded In	
							Tier 1	Tier 2	Tier 3	Tier 1	Tier 2	Tier 3
	48	96	36	226	115	LKT4896-36ARRY	\$3,383	\$3,433	\$3,753	\$3,854	\$3,906	\$4,133
	48	84	36	201	101	LKT4884-36ARRY	\$2,995	\$3,040	\$3,318	\$3,457	\$3,501	\$3,700
	42	96	36	193	102	LKT4296-36ARRY	\$3,821	\$3,865	\$4,144	\$4,279	\$4,325	\$4,525
	42	84	36	172	89	LKT4284-36ARRY	\$2,612	\$2,651	\$2,897	\$3,063	\$3,102	\$3,277
	36	96	36	177	89	LKT3696-36ARRY	\$2,626	\$2,664	\$2,903	\$3,073	\$3,111	\$3,284
	36	84	36	156	78	LKT3684-36ARRY	\$2,336	\$2,370	\$2,579	\$2,776	\$2,811	\$2,959

Features:

- price reflects complete table - top and base
- ships KD in multiple cartons
- one piece top
- model includes adjustable glide

Options:

- specify power/charging option, see below for options and upcharges



36" & 42" wide tables have single column base

LOK - CONFERENCE

To Order Specify

1 Laminate Model #	2 Edge Detail	3 Laminate Selection	3a PVC Edge Color	4 Electrical	5 Metal Color
Laminate (LKT)	See Edge Detail Options	See Laminate Selection	See PVC Edge Color Options	N None CT2 Dual Power Center Top CU2 Dual Power Underside CT2U1 Dual Power Center Top with Underside (See chart on next page)	See Metal Finish Color Options

Model Number Breakdown

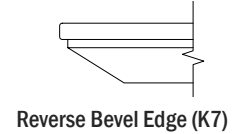
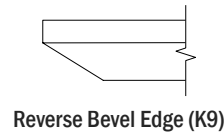
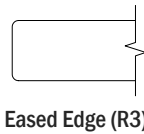
LKT4896-36ARRY						
LK	T	4896	36	AR	R	Y
LOK	Laminate	48" x 96"	Height	Arc Rectangular Top Shape	Rounded Corner	Y Base

Description

Rounded Arc Rectangular Table with Y Base at Counter Height (continued)

Veneer Tables "LKV" Models

Solid Surface Tables "LKS" Models



	D	W	H	CTN WT	CU FT	① Model	Veneer Tables "LKV" Models		Solid Surface Tables "LKS" Models		
							Flat Cut	Double Cut	Flat Cut	Double Cut	Standard
VENEER	48	96	36	226	115	LKV4896-36ARRY	\$4,683	\$5,022	\$4,992	\$5,309	--
	48	84	36	201	101	LKV4884-36ARRY	\$4,249	\$4,539	\$4,536	\$4,809	--
	42	96	36	193	102	LKV4296-36ARRY	\$5,474	\$5,912	\$5,967	\$6,354	--
	42	84	36	172	89	LKV4284-36ARRY	\$3,906	\$4,218	\$4,257	\$4,535	--
	36	96	36	177	89	LKV3696-36ARRY	\$3,521	\$3,803	\$3,836	\$4,087	--
	36	84	36	156	78	LKV3684-36ARRY	\$3,211	\$3,467	\$3,499	\$3,726	--
SOLID SURFACE	48	96	36	226	115	LKS4896-36ARRY	--	--	--	--	\$10,564
	48	84	36	201	101	LKS4884-36ARRY	--	--	--	--	\$9,352
	42	96	36	193	102	LKS4296-36ARRY	--	--	--	--	\$9,553
	42	84	36	172	89	LKS4284-36ARRY	--	--	--	--	\$7,677
	36	96	36	177	89	LKS3696-36ARRY	--	--	--	--	\$7,610
	36	84	36	156	78	LKS3684-36ARRY	--	--	--	--	\$6,833

Electrical Options and Upcharges

CT2	84 - 96 wide
Dual Power Center Top - Black	CT2BL - add \$1,490
Dual Power Center Top - White	CT2WH - add \$1,490
CU1	
Dual Power Underside - Black	CU1-1C - add \$592
Dual Power Underside with Wireless Charging - Black	CU1-1CW - add \$1,371
CT2U1	
Dual Power Center Top - Black with Underside	CT2U1-BL - add \$1,813
Dual Power Center Top - White with Underside	CT2U1-WH - add \$1,813
Dual Power Center Top - Black with Wireless Charging	CT2U1-BLW2 - add \$2,592
Dual Power Center Top - White with Wireless Charging	CT2U1-WHW2 - add \$2,592

Note: Order power infed that best fits application

To Order Specify

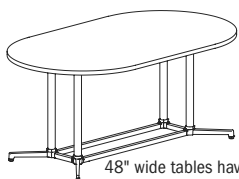
① Veneer Model #	② Edge Detail	③ Wood Species	④ Wood Finish	⑤ Electrical	⑥ Metal Color
Veneer (LKV)	See Edge Detail Options	Flat Cut CH1 Cherry MA1 Maple WA1 Walnut BO1 Black Oak	See Flat Cut Wood Finish Options	N None CT2 Dual Power Center Top CU2 Dual Power Underside CT2U1 Dual Power Center Top with Underside (See chart above)	See Metal Finish Color Options
		Double Cut DC1 Double Cut	See Double Cut Wood Finish Options		

① Solid Surface Model #	② Top Surface Selection	③ Electrical	④ Metal Color
Solid Surface (LKS)	See Solid Surface Top Surface Selection Options	N None CT2 Dual Power Center Top CU2 Dual Power Underside CT2U1 Dual Power Center Top with Underside (See chart above)	See Metal Finish Color Options

LOK - CONFERENCE

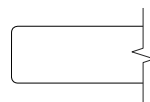
Description

Racetrack Table with Y Base at Counter Height

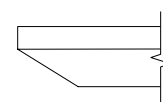


48" wide tables have double column base

Laminate Tables "LKT" Models



Eased Edge (R3)



Reverse Bevel Edge (K9)

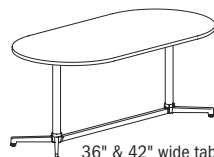
LAMINATE	D	W	H	CTN WT	CU FT	Model	Eased Edge (R3)			Reverse Bevel Edge (K9)		
							Standard	Graded In		Standard	Graded In	
							Tier 1	Tier 2	Tier 3	Tier 1	Tier 2	Tier 3
	48	96	36	213	115	LKT4896-36RKY	\$3,256	\$3,309	\$3,628	\$3,728	\$3,782	\$4,006
	48	84	36	191	101	LKT4884-36RKY	\$2,995	\$3,040	\$3,318	\$3,457	\$3,501	\$3,700
	42	96	36	185	102	LKT4296-36RKY	\$3,821	\$3,865	\$4,144	\$4,279	\$4,325	\$4,525
	42	84	36	164	89	LKT4284-36RKY	\$2,612	\$2,651	\$2,897	\$3,063	\$3,102	\$3,277
	36	96	36	168	89	LKT3696-36RKY	\$2,626	\$2,664	\$2,903	\$3,073	\$3,111	\$3,284
	36	84	36	150	78	LKT3684-36RKY	\$2,336	\$2,370	\$2,579	\$2,776	\$2,811	\$2,959

Features:

- price reflects complete table - top and base
- ships KD in multiple cartons
- one piece top
- model includes adjustable glide

Options:

- specify power/charging option, see below for options and upcharges



36" & 42" wide tables have single column base

LOK - CONFERENCE

To Order Specify

1 Laminate Model #	2 Edge Detail	3 Laminate Selection	3a PVC Edge Color	4 Electrical	5 Metal Color
Laminate (LKT)	See Edge Detail Options	See Laminate Selection	See PVC Edge Color Options	N None CT2 Dual Power Center Top CU2 Dual Power Underside CT2U1 Dual Power Center Top with Underside (See chart on next page)	See Metal Finish Color Options

Model Number Breakdown

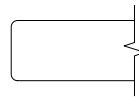
LKT4896-36RKY					
LK	T	4896	36	RK	Y
LOK	Laminate	48" x 96"	Height	Racetrack Top Shape	Y Base

Description

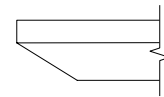
Racetrack Table with Y Base at Counter Height (continued)

Veneer Tables "LKV" Models

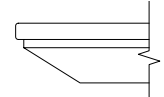
Solid Surface Tables "LKS" Models



Eased Edge (R3)



Reverse Bevel Edge (K9)



Reverse Bevel Edge (K7)

	D	W	H	CTN WT	CU FT	① Model	Veneer Tables "LKV" Models		Solid Surface Tables "LKS" Models		
							Flat Cut	Double Cut	Flat Cut	Double Cut	Standard
VENEER	48	96	36	213	115	LKV4896-36RKY	\$4,525	\$4,861	\$4,833	\$5,148	--
	48	84	36	191	101	LKV4884-36RKY	\$4,249	\$4,539	\$4,536	\$4,809	--
	42	96	36	185	102	LKV4296-36RKY	\$5,474	\$5,912	\$5,967	\$6,354	--
	42	84	36	164	89	LKV4284-36RKY	\$3,906	\$4,218	\$4,257	\$4,535	--
	36	96	36	168	89	LKV3696-36RKY	\$3,521	\$3,803	\$3,836	\$4,087	--
	36	84	36	150	78	LKV3684-36RKY	\$3,211	\$3,467	\$3,499	\$3,726	--
SOLID SURFACE	48	96	36	213	115	LKS4896-36RKY	--	--	--	--	\$10,403
	48	84	36	191	101	LKS4884-36RKY	--	--	--	--	\$9,352
	42	96	36	185	102	LKS4296-36RKY	--	--	--	--	\$9,553
	42	84	36	164	89	LKS4284-36RKY	--	--	--	--	\$7,677
	36	96	36	168	89	LKS3696-36RKY	--	--	--	--	\$7,610
	36	84	36	150	78	LKS3684-36RKY	--	--	--	--	\$6,833

Electrical Options and Upcharges

CT2	84 - 96 wide
Dual Power Center Top - Black	CT2BL - add \$1,490
Dual Power Center Top - White	CT2WH - add \$1,490
CU1	
Dual Power Underside - Black	CU1-1C - add \$592
Dual Power Underside with Wireless Charging - Black	CU1-1CW - add \$1,371
CT2U1	
Dual Power Center Top - Black with Underside	CT2U1-BL - add \$1,813
Dual Power Center Top - White with Underside	CT2U1-WH - add \$1,813
Dual Power Center Top - Black with Wireless Charging	CT2U1-BLW2 - add \$2,592
Dual Power Center Top - White with Wireless Charging	CT2U1-WHW2 - add \$2,592

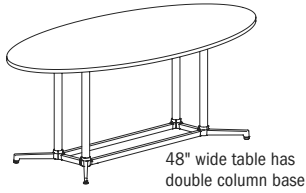
Note: Order power infeed that best fits application

To Order Specify

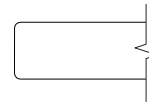
① Veneer Model #	② Edge Detail	③ Wood Species	④ Wood Finish	⑤ Electrical	⑥ Metal Color
Veneer (LKV)	See Edge Detail Options	Flat Cut CH1 Cherry MA1 Maple WA1 Walnut BO1 Black Oak	See Flat Cut Wood Finish Options	N None CT2 Dual Power Center Top CU2 Dual Power Underside CT2U1 Dual Power Center Top with Underside (See chart above)	See Metal Finish Color Options
		Double Cut DC1 Double Cut	See Double Cut Wood Finish Options		

Description

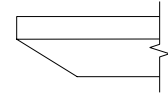
Oval Table with Y Base at Counter Height



Laminate Tables
"LKT" Models



Eased Edge (R3)



Reverse Bevel Edge (K9)

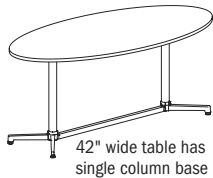
LAMINATE	D	W	H	CTN WT	CU FT	Model	Eased Edge (R3)			Reverse Bevel Edge (K9)		
							Standard	Graded In		Standard	Graded In	
							Tier 1	Tier 2	Tier 3	Tier 1	Tier 2	Tier 3
	48	96	36	194	115	LKT4896-360VY	\$3,143	\$3,193	\$3,511	\$3,616	\$3,666	\$3,893
	42	84	36	150	89	LKT4284-360VY	\$2,612	\$2,651	\$2,897	\$3,063	\$3,102	\$3,277

Features:

- price reflects complete table - top and base
- ships KD in multiple cartons
- one piece top
- model includes adjustable glide

Options:

- specify power/charging option, see below for options and upcharges



LOK - CONFERENCE

To Order Specify

1 Laminate Model #	2 Edge Detail	3 Laminate Selection	3a PVC Edge Color	4 Electrical	5 Metal Color
Laminate (LKT)	See Edge Detail Options	See Laminate Selection	See PVC Edge Color Options	N None CT2 Dual Power Center Top CU2 Dual Power Underside CT2U1 Dual Power Center Top with Underside (See chart on next page)	See Metal Finish Color Options

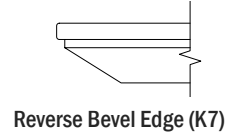
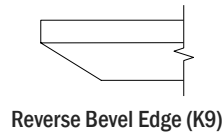
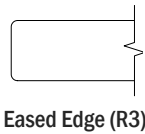
Model Number Breakdown

LKT4896-36RKY					
LK	T	4896	36	RK	Y
LOK	Laminate	48" x 96"	Height	Racetrack Top Shape	Y Base

Description

Oval Table with Y Base at Counter Height (continued)

Veneer Tables "LKV" Models Solid Surface Tables "LKS" Models



	D	W	H	CTN WT	CU FT	① Model	Eased Edge (R3)		Reverse Bevel Edge (K9)		Reverse Bevel Edge (K7)
							Flat Cut	Double Cut	Flat Cut	Double Cut	
VENEER	48	96	36	194	115	LKV4896-360VY	\$4,378	\$4,714	\$4,686	\$5,001	--
	42	84	36	150	89	LKV4284-360VY	\$3,906	\$4,218	\$4,257	\$4,535	--
SOL. SURF.	48	96	36	194	115	LKS4896-360VY	--	--	--	--	\$10,259
	42	84	36	150	89	LKS4284-360VY	--	--	--	--	\$7,677

Electrical Options and Upcharges

CT2	84 - 96 wide
Dual Power Center Top - Black	CT2BL - add \$1,490
Dual Power Center Top - White	CT2WH - add \$1,490
CU1	
Dual Power Underside - Black	CU1-1C - add \$592
Dual Power Underside with Wireless Charging - Black	CU1-1CW - add \$1,371
CT2U1	
Dual Power Center Top - Black with Underside	CT2U1-BL - add \$1,813
Dual Power Center Top - White with Underside	CT2U1-WH - add \$1,813
Dual Power Center Top - Black with Wireless Charging	CT2U1-BLW2 - add \$2,592
Dual Power Center Top - White with Wireless Charging	CT2U1-WHW2 - add \$2,592

Note: Order power infeed that best fits application

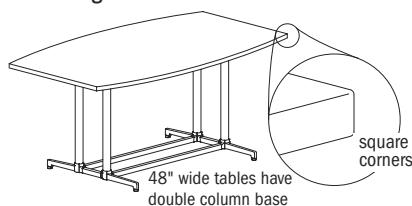
To Order Specify

① Veneer Model #	② Edge Detail	③ Wood Species	④ Wood Finish	⑤ Electrical	⑥ Metal Color
Veneer (LKV)	See Edge Detail Options	Flat Cut CH1 Cherry MA1 Maple WA1 Walnut BO1 Black Oak	See Flat Cut Wood Finish Options	N None CT2 Dual Power Center Top CU2 Dual Power Underside CT2U1 Dual Power Center Top with Underside (See chart above)	See Metal Finish Color Options
		Double Cut DC1 Double Cut	④ Wood Finish See Double Cut Wood Finish Options		

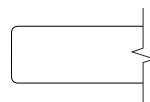
LOK - CONFERENCE

Description

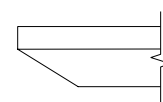
Boat Table with T Base at Counter Height



Laminate Tables
"LKT" Models



Eased Edge (R3)



Reverse Bevel Edge (K9)

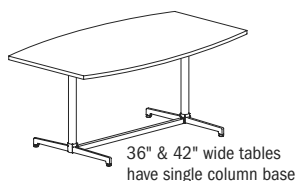
LAMINATE	D	W	H	CTN WT	CU FT	Model	Standard			Graded In		
							Tier 1	Tier 2	Tier 3	Tier 1	Tier 2	Tier 3
	48	96	36	226	101	LKT4896-36BTT	\$3,368	\$3,420	\$3,739	\$3,841	\$3,892	\$4,119
48	84	36	204	101	LKT4884-36BTT	\$3,063	\$3,108	\$3,388	\$3,524	\$3,570	\$3,768	
42	96	36	180	83	LKT4296-36BTT	\$3,000	\$3,047	\$3,326	\$3,461	\$3,506	\$3,705	
42	84	36	162	90	LKT4284-36BTT	\$2,499	\$2,538	\$2,782	\$2,949	\$2,988	\$3,163	
36	96	36	159	89	LKT3696-36BTT	\$2,549	\$2,587	\$2,825	\$2,996	\$3,033	\$3,205	
36	84	36	143	78	LKT3684-36BTT	\$2,302	\$2,335	\$2,544	\$2,740	\$2,774	\$2,924	

Features:

- price reflects complete table - top and base
- ships KD in multiple cartons
- one piece top
- model includes adjustable glide

Options:

- specify power/charging option, see below for options and upcharges



36" & 42" wide tables have single column base

LOK - CONFERENCE

To Order Specify

1 Laminate Model #	2 Edge Detail	3 Laminate Selection	3a PVC Edge Color	4 Electrical	5 Metal Color
Laminate (LKT)	See Edge Detail Options	See Laminate Selection	See PVC Edge Color Options	N None CT2 Dual Power Center Top CU2 Dual Power Underside CT2U1 Dual Power Center Top with Underside (See chart on next page)	See Metal Finish Color Options

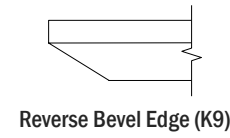
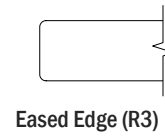
Model Number Breakdown

LKT4896-36BTT					
LK	T	4896	36	BT	T
LOK	Laminate	48" x 96"	Height	Boat Top Shape	T Base

Description

Boat Table with T Base at Counter Height
(continued)

Veneer Tables
"LKV" Models



D	W	H	CTN WT	CU FT	① Model	Eased Edge (R3)		Reverse Bevel Edge (K9)	
						Flat Cut	Double Cut	Flat Cut	Double Cut
48	96	36	226	101	LKV4896-36BTT	\$4,665	\$5,005	\$4,975	\$5,287
48	84	36	204	101	LKV4884-36BTT	\$4,334	\$4,625	\$4,623	\$4,894
42	96	36	180	83	LKV4296-36BTT	\$4,451	\$4,808	\$4,851	\$5,168
	84	36	162	90	LKV4284-36BTT	\$3,767	\$4,068	\$4,106	\$4,370
36	96	36	159	89	LKV3696-36BTT	\$3,426	\$3,702	\$3,736	\$3,977
36	84	36	143	78	LKV3684-36BTT	\$3,166	\$3,421	\$3,454	\$3,676

Electrical Options and Upcharges

CT2	84 - 96 wide
Dual Power Center Top - Black	CT2BL - add \$1,490
Dual Power Center Top - White	CT2WH - add \$1,490
CU1	
Dual Power Underside - Black	CU1-1C - add \$592
Dual Power Underside with Wireless Charging - Black	CU1-1CW - add \$1,371
CT2U1	
Dual Power Center Top - Black with Underside	CT2U1-BL - add \$1,813
Dual Power Center Top - White with Underside	CT2U1-WH - add \$1,813
Dual Power Center Top - Black with Wireless Charging	CT2U1-BLW2 - add \$2,592
Dual Power Center Top - White with Wireless Charging	CT2U1-WHW2 - add \$2,592

Note: Order power infeed that best fits application

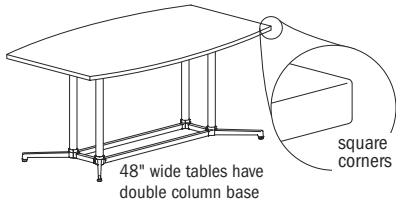
To Order Specify

① Veneer Model #	② Edge Detail	③ Wood Species	④ Wood Finish	⑤ Electrical	⑥ Metal Color
Veneer (LKV)	See Edge Detail Options	Flat Cut CH1 Cherry MA1 Maple WA1 Walnut BO1 Black Oak	See Flat Cut Wood Finish Options	N None CT2 Dual Power Center Top CU2 Dual Power Underside CT2U1 Dual Power Center Top with Underside (See chart above)	See Metal Finish Color Options
		Double Cut DC1 Double Cut	See Double Cut Wood Finish Options		

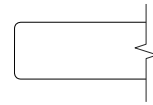
LOK - CONFERENCE

Description

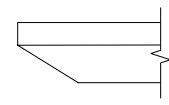
Boat Table with Y Base at Counter Height



Laminate Tables
"LKT" Models



Eased Edge (R3)



Reverse Bevel Edge (K9)

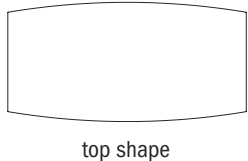
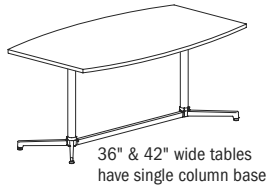
LAMINATE	D	W	H	CTN WT	CU FT	Model	Standard			Graded In		
							Tier 1	Tier 2	Tier 3	Tier 1	Tier 2	Tier 3
	48	96	36	225	115	LKT4896-36BTY	\$3,383	\$3,433	\$3,753	\$3,854	\$3,906	\$4,133
48	84	36	204	101	LKT4884-36BTY	\$2,995	\$3,040	\$3,318	\$3,457	\$3,501	\$3,700	
42	96	36	194	102	LKT4296-36BTY	\$3,821	\$3,865	\$4,144	\$4,279	\$4,325	\$4,525	
42	84	36	172	89	LKT4284-36BTY	\$2,612	\$2,651	\$2,897	\$3,063	\$3,102	\$3,277	
36	96	36	175	89	LKT3696-36BTY	\$2,626	\$2,664	\$2,903	\$3,073	\$3,111	\$3,284	
36	84	36	153	78	LKT3684-36BTY	\$2,336	\$2,370	\$2,579	\$2,776	\$2,811	\$2,959	

Features:

- price reflects complete table - top and base
- ships KD in multiple cartons
- one piece top
- model includes adjustable glide

Options:

- specify power/charging option, see below for options and upcharges



top shape

LOK - CONFERENCE

To Order Specify

1 Laminate Model #	2 Edge Detail	3 Laminate Selection	3a PVC Edge Color	4 Electrical	5 Metal Color
Laminate (LKT)	See Edge Detail Options	See Laminate Selection	See PVC Edge Color Options	N None CT2 Dual Power Center Top CU2 Dual Power Underside CT2U1 Dual Power Center Top with Underside (See chart on next page)	See Metal Finish Color Options

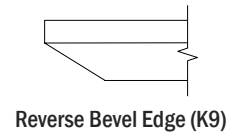
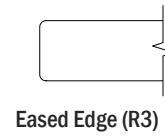
Model Number Breakdown

LKT4896-36BTY					
LK	T	4896	36	BT	Y
LOK	Laminate	48" x 96"	Height	Boat Top Shape	Y Base

Description

Boat Table with Y Base at Counter Height (continued)

Veneer Tables "LKV" Models



D	W	H	CTN WT	CU FT	① Model	Eased Edge (R3)		Reverse Bevel Edge (K9)		
						Flat Cut	Double Cut	Flat Cut	Double Cut	
VENEER	48	96	36	225	115	LKV4896-36BTY	\$4,683	\$5,022	\$4,992	\$5,309
	48	84	36	204	101	LKV4884-36BTY	\$4,249	\$4,539	\$4,536	\$4,809
	42	96	36	194	102	LKV4296-36BTY	\$5,474	\$5,912	\$5,967	\$6,354
	42	84	36	172	89	LKV4284-36BTY	\$3,906	\$4,218	\$4,257	\$4,535
	36	96	36	175	89	LKV3696-36BTY	\$3,521	\$3,803	\$3,836	\$4,087
	36	84	36	153	78	LKV3684-36BTY	\$3,211	\$3,467	\$3,499	\$3,726

Electrical Options and Upcharges

CT2	84 - 96 wide
Dual Power Center Top - Black	CT2BL - add \$1,490
Dual Power Center Top - White	CT2WH - add \$1,490
CU1	
Dual Power Underside - Black	CU1-1C - add \$592
Dual Power Underside with Wireless Charging - Black	CU1-1CW - add \$1,371
CT2U1	
Dual Power Center Top - Black with Underside	CT2U1-BL - add \$1,813
Dual Power Center Top - White with Underside	CT2U1-WH - add \$1,813
Dual Power Center Top - Black with Wireless Charging	CT2U1-BLW2 - add \$2,592
Dual Power Center Top - White with Wireless Charging	CT2U1-WHW2 - add \$2,592

Note: Order power infeed that best fits application

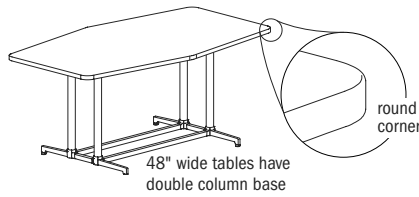
To Order Specify

① Veneer Model #	② Edge Detail	③ Wood Species	④ Wood Finish	⑤ Electrical	⑥ Metal Color
Veneer (LKV)	See Edge Detail Options	Flat Cut CH1 Cherry MA1 Maple WA1 Walnut BO1 Black Oak	See Flat Cut Wood Finish Options	N None CT2 Dual Power Center Top CU2 Dual Power Underside CT2U1 Dual Power Center Top with Underside (See chart above)	See Metal Finish Color Options
		Double Cut DC1 Double Cut	④ Wood Finish See Double Cut Wood Finish Options		

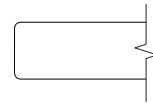
LOK - CONFERENCE

Description

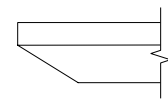
Rounded Double Chevron Table with T Base at Counter Height



Laminate Tables "LKT" Models



Eased Edge (R3)



Reverse Bevel Edge (K9)

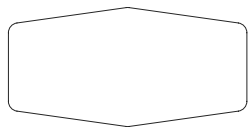
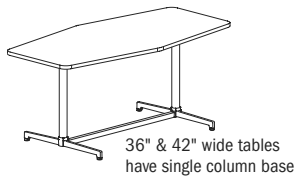
LAMINATE	D	W	H	CTN WT	CU FT	Model	Eased Edge (R3)		Reverse Bevel Edge (K9)			
							Standard	Graded In	Standard	Graded In		
							Tier 1	Tier 2	Tier 3	Tier 1	Tier 2	Tier 3
	48	96	36	211	115	LKT4896-36DCRT	\$3,368	\$3,420	\$3,739	\$3,841	\$3,892	\$4,119
	48	84	36	189	101	LKT4884-36DCRT	\$3,063	\$3,108	\$3,388	\$3,524	\$3,570	\$3,768
	42	96	36	165	83	LKT4296-36DCRT	\$3,000	\$3,047	\$3,326	\$3,461	\$3,506	\$3,705
	42	84	36	146	90	LKT4284-36DCRT	\$2,499	\$2,538	\$2,782	\$2,949	\$2,988	\$3,163
	36	96	36	149	89	LKT3696-36DCRT	\$2,549	\$2,587	\$2,825	\$2,996	\$3,033	\$3,205
	36	84	36	142	78	LKT3684-36DCRT	\$2,302	\$2,335	\$2,544	\$2,740	\$2,774	\$2,924

Features:

- price reflects complete table - top and base
- ships KD in multiple cartons
- one piece top
- model includes adjustable glide

Options:

- specify power/charging option, see below for options and upcharges



top shape

LOK - CONFERENCE

To Order Specify

1 Laminate Model #	2 Edge Detail	3 Laminate Selection	3a PVC Edge Color	4 Electrical	5 Metal Color
Laminate (LKT)	See Edge Detail Options	See Laminate Selection	See PVC Edge Color Options	N None CT2 Dual Power Center Top CU2 Dual Power Underside CT2U1 Dual Power Center Top with Underside (See chart on next page)	See Metal Finish Color Options

Model Number Breakdown

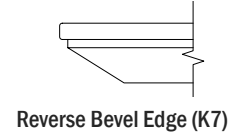
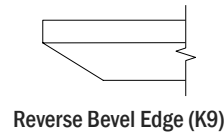
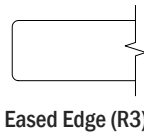
LKT4896-36DCRT						
LK	T	4896	36	DC	R	T
LOK	Laminate	48" x 96"	Height	Double Chevron Top Shape	Rounded Corner	T Base

Description

Rounded Double Chevron Table with T Base at Counter Height (continued)

Veneer Tables "LKV" Models

Solid Surface Tables "LKS" Models



	D	W	H	CTN WT	CU FT	① Model	Veneer Tables "LKV" Models		Solid Surface Tables "LKS" Models		
							Flat Cut	Double Cut	Flat Cut	Double Cut	Standard
VENEER	48	96	36	211	115	LKV4896-36DCRT	\$4,665	\$5,005	\$4,975	\$5,287	--
	48	84	36	189	101	LKV4884-36DCRT	\$4,334	\$4,625	\$4,623	\$4,894	--
	42	96	36	165	83	LKV4296-36DCRT	\$4,451	\$4,808	\$4,851	\$5,168	--
	42	84	36	146	90	LKV4284-36DCRT	\$3,767	\$4,068	\$4,106	\$4,370	--
	36	96	36	149	89	LKV3696-36DCRT	\$3,426	\$3,702	\$3,736	\$3,977	--
	36	84	36	142	78	LKV3684-36DCRT	\$3,166	\$3,421	\$3,454	\$3,676	--
SOLID SURFACE	48	96	36	211	115	LKS4896-36DCRT	--	--	--	--	\$10,547
	48	84	36	189	101	LKS4884-36DCRT	--	--	--	--	\$9,437
	42	96	36	165	83	LKS4296-36DCRT	--	--	--	--	\$8,528
	42	84	36	146	90	LKS4284-36DCRT	--	--	--	--	\$7,537
	36	96	36	149	89	LKS3696-36DCRT	--	--	--	--	\$7,515
	36	84	36	142	78	LKS3684-36DCRT	--	--	--	--	\$6,790

Electrical Options and Upcharges

CT2	84 - 96 wide
Dual Power Center Top - Black	CT2BL - add \$1,490
Dual Power Center Top - White	CT2WH - add \$1,490
CU1	
Dual Power Underside - Black	CU1-1C - add \$592
Dual Power Underside with Wireless Charging - Black	CU1-1CW - add \$1,371
CT2U1	
Dual Power Center Top - Black with Underside	CT2U1-BL - add \$1,813
Dual Power Center Top - White with Underside	CT2U1-WH - add \$1,813
Dual Power Center Top - Black with Wireless Charging	CT2U1-BLW2 - add \$2,592
Dual Power Center Top - White with Wireless Charging	CT2U1-WHW2 - add \$2,592

Note: Order power infed that best fits application

To Order Specify

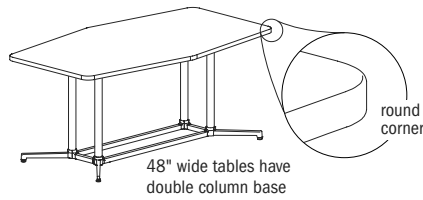
① Veneer Model #	② Edge Detail	③ Wood Species	④ Wood Finish	⑤ Electrical	⑥ Metal Color
Veneer (LKV)	See Edge Detail Options	Flat Cut CH1 Cherry MA1 Maple WA1 Walnut BO1 Black Oak	See Flat Cut Wood Finish Options	N None CT2 Dual Power Center Top CU2 Dual Power Underside CT2U1 Dual Power Center Top with Underside (See chart above)	See Metal Finish Color Options
		Double Cut DC1 Double Cut	See Double Cut Wood Finish Options		

① Solid Surface Model #	② Top Surface Selection	③ Electrical	④ Metal Color
Solid Surface (LKS)	See Solid Surface Top Surface Selection Options	N None CT2 Dual Power Center Top CU2 Dual Power Underside CT2U1 Dual Power Center Top with Underside (See chart above)	See Metal Finish Color Options

LOK - CONFERENCE

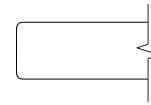
Description

Rounded Double Chevron Table with Y Base at Counter Height

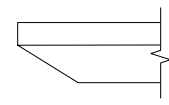


48" wide tables have double column base

Laminate Tables "LKT" Models



Eased Edge (R3)



Reverse Bevel Edge (K9)

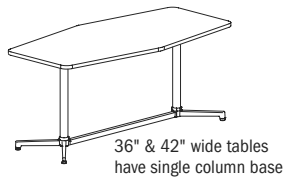
LAMINATE	D	W	H	CTN WT	CU FT	Model	Eased Edge (R3)		Reverse Bevel Edge (K9)			
							Standard	Graded In	Standard	Graded In		
							Tier 1	Tier 2	Tier 3	Tier 1	Tier 2	Tier 3
	48	96	36	206	115	LKT4896-36DCRY	\$3,383	\$3,433	\$3,753	\$3,854	\$3,906	\$4,133
	48	84	36	188	101	LKT4884-36DCRY	\$2,995	\$3,040	\$3,318	\$3,457	\$3,501	\$3,700
	42	96	36	172	102	LKT4296-36DCRY	\$3,821	\$3,865	\$4,144	\$4,279	\$4,325	\$4,525
	42	84	36	156	89	LKT4284-36DCRY	\$2,612	\$2,651	\$2,897	\$3,063	\$3,102	\$3,277
	36	96	36	175	89	LKT3696-36DCRY	\$2,626	\$2,664	\$2,903	\$3,073	\$3,111	\$3,284
	36	84	36	144	78	LKT3684-36DCRY	\$2,336	\$2,370	\$2,579	\$2,776	\$2,811	\$2,959

Features:

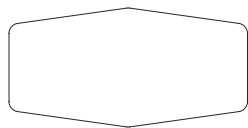
- price reflects complete table - top and base
- ships KD in multiple cartons
- one piece top
- model includes adjustable glide

Options:

- specify power/charging option, see below for options and upcharges



36" & 42" wide tables have single column base



top shape

LOK - CONFERENCE

To Order Specify

1 Laminate Model #	2 Edge Detail	3 Laminate Selection	3a PVC Edge Color	4 Electrical	5 Metal Color
Laminate (LKT)	See Edge Detail Options	See Laminate Selection	See PVC Edge Color Options	N None CT2 Dual Power Center Top CU2 Dual Power Underside CT2U1 Dual Power Center Top with Underside (See chart on next page)	See Metal Finish Color Options

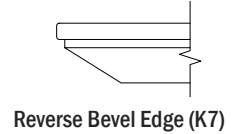
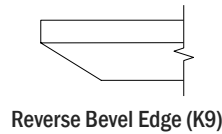
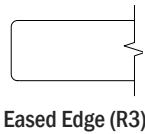
Model Number Breakdown

LKT4896-36DCRY						
LK	T	4896	36	DC	R	Y
LOK	Laminate	48" x 96"	Height	Double Chevron Top Shape	Rounded Corner	Y Base

Description

Rounded Double Chevron Table with Y Base at Counter Height (continued)

Veneer Tables "LKV" Models	Solid Surface Tables "LKS" Models
----------------------------	-----------------------------------



	D	W	H	CTN WT	CU FT	① Model	Veneer Tables "LKV" Models		Solid Surface Tables "LKS" Models		
							Flat Cut	Double Cut	Flat Cut	Double Cut	Standard
VENEER	48	96	36	206	115	LKV4896-36DCRY	\$4,683	\$5,022	\$4,992	\$5,309	--
	48	84	36	188	101	LKV4884-36DCRY	\$4,249	\$4,539	\$4,536	\$4,809	--
	42	96	36	172	102	LKV4296-36DCRY	\$5,474	\$5,912	\$5,967	\$6,354	--
	42	84	36	156	89	LKV4284-36DCRY	\$3,906	\$4,218	\$4,257	\$4,535	--
	36	96	36	175	89	LKV3696-36DCRY	\$3,521	\$3,803	\$3,836	\$4,087	--
	36	84	36	144	78	LKV3684-36DCRY	\$3,211	\$3,467	\$3,499	\$3,726	--
SOLID SURFACE	48	96	36	206	115	LKS4896-36DCRY	--	--	--	--	\$10,564
	48	84	36	188	101	LKS4884-36DCRY	--	--	--	--	\$9,352
	42	96	36	172	102	LKS4296-36DCRY	--	--	--	--	\$9,553
	42	84	36	156	89	LKS4284-36DCRY	--	--	--	--	\$7,677
	36	96	36	175	89	LKS3696-36DCRY	--	--	--	--	\$7,610
	36	84	36	144	78	LKS3684-36DCRY	--	--	--	--	\$6,833

Electrical Options and Upcharges

CT2	84 - 96 wide
Dual Power Center Top - Black	CT2BL - add \$1,490
Dual Power Center Top - White	CT2WH - add \$1,490
CU1	
Dual Power Underside - Black	CU1-1C - add \$592
Dual Power Underside with Wireless Charging - Black	CU1-1CW - add \$1,371
CT2U1	
Dual Power Center Top - Black with Underside	CT2U1-BL - add \$1,813
Dual Power Center Top - White with Underside	CT2U1-WH - add \$1,813
Dual Power Center Top - Black with Wireless Charging	CT2U1-BLW2 - add \$2,592
Dual Power Center Top - White with Wireless Charging	CT2U1-WHW2 - add \$2,592

Note: Order power infed that best fits application

To Order Specify

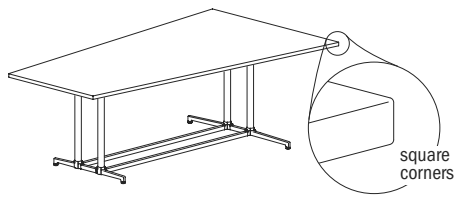
① Veneer Model #	② Edge Detail	③ Wood Species	④ Wood Finish	⑤ Electrical	⑥ Metal Color
Veneer (LKV)	See Edge Detail Options	Flat Cut CH1 Cherry MA1 Maple WA1 Walnut BO1 Black Oak	See Flat Cut Wood Finish Options	N None CT2 Dual Power Center Top CU2 Dual Power Underside CT2U1 Dual Power Center Top with Underside (See chart above)	See Metal Finish Color Options
		Double Cut DC1 Double Cut	See Double Cut Wood Finish Options		

① Solid Surface Model #	② Top Surface Selection	③ Electrical	④ Metal Color
Solid Surface (LKS)	See Solid Surface Top Surface Selection Options	N None CT2 Dual Power Center Top CU2 Dual Power Underside CT2U1 Dual Power Center Top with Underside (See chart above)	See Metal Finish Color Options

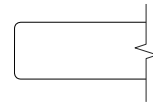
LOK - CONFERENCE

Description

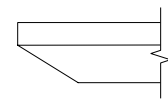
Taper Table with T Base at Counter Height



Laminate Tables "LKT" Models



Eased Edge (R3)



Reverse Bevel Edge (K9)

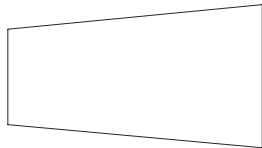
LAM.	D	W	H	CTN WT	CU FT	Model	Standard			Graded In		
	Tier 1	Tier 2	Tier 3	Tier 1	Tier 2	Tier 3	Tier 1	Tier 2	Tier 3	Tier 1	Tier 2	Tier 3
	54	96	36	222	127	LKT5496-36TPT	\$3,598	\$3,657	\$4,014	\$4,084	\$4,141	\$4,398

Features:

- price reflects complete table - top and base
- ships KD in multiple cartons
- one piece top
- model includes adjustable glide

Options:

- specify power/charging option, see below for options and upcharges



top shape

LOK - CONFERENCE

To Order Specify

1 Laminate Model #	2 Edge Detail	3 Laminate Selection	3a PVC Edge Color	4 Electrical	5 Metal Color
Laminate (LKT)	See Edge Detail Options	See Laminate Selection	See PVC Edge Color Options	N None CT2 Dual Power Center Top CU2 Dual Power Underside CT2U1 Dual Power Center Top with Underside (See chart on next page)	See Metal Finish Color Options

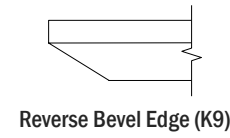
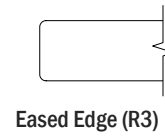
Model Number Breakdown

LKT5496-36TPT					
LK	T	5496	36	TP	T
LOK	Laminate	54" x 96"	Height	Taper Top Shape	T Base

Description

Taper Table with T Base at Counter Height
(continued)

Veneer Tables "LKV" Models



VEN.	D	W	H	CTN WT	CU FT	① Model	Eased Edge (R3)		Reverse Bevel Edge (K9)	
							Flat Cut	Double Cut	Flat Cut	Double Cut
	54	96	36	222	127	LKV5496-36TPT	\$4,918	\$5,311	\$5,360	\$5,709

Electrical Options and Upcharges

CT2	84 - 96 wide
Dual Power Center Top - Black	CT2BL - add \$1,490
Dual Power Center Top - White	CT2WH - add \$1,490
CU1	
Dual Power Underside - Black	CU1-1C - add \$592
Dual Power Underside with Wireless Charging - Black	CU1-1CW - add \$1,371
CT2U1	
Dual Power Center Top - Black with Underside	CT2U1-BL - add \$1,813
Dual Power Center Top - White with Underside	CT2U1-WH - add \$1,813
Dual Power Center Top - Black with Wireless Charging	CT2U1-BLW2 - add \$2,592
Dual Power Center Top - White with Wireless Charging	CT2U1-WHW2 - add \$2,592

Note: Order power infeed that best fits application

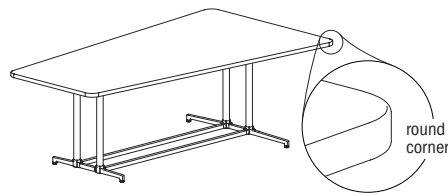
To Order Specify

① Veneer Model #	② Edge Detail	③ Wood Species	④ Wood Finish	⑤ Electrical	⑥ Metal Color
Veneer (LKV)	See Edge Detail Options	Flat Cut CH1 Cherry MA1 Maple WA1 Walnut BO1 Black Oak	See Flat Cut Wood Finish Options	N None CT2 Dual Power Center Top CU2 Dual Power Underside CT2U1 Dual Power Center Top with Underside (See chart above)	See Metal Finish Color Options
		Double Cut DC1 Double Cut	See Double Cut Wood Finish Options		

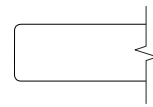
LOK - CONFERENCE

Description

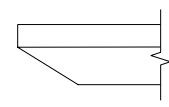
Rounded Taper Table with T Base at Counter Height



Laminate Tables "LKT" Models



Eased Edge (R3)



Reverse Bevel Edge (K9)

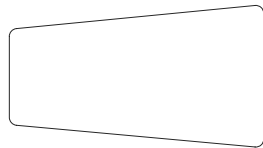
LAM.	D	W	H	CTN WT	CU FT	Model	Standard			Graded In		
	Tier 1	Tier 2	Tier 3	Tier 1	Tier 2	Tier 3	Tier 1	Tier 2	Tier 3	Tier 1	Tier 2	Tier 3
	54	96	36	222	127	LKT5496-36TPRT	\$3,598	\$3,657	\$4,014	\$4,084	\$4,141	\$4,398

Features:

- price reflects complete table - top and base
- ships KD in multiple cartons
- one piece top
- model includes adjustable glide

Options:

- specify power/charging option, see below for options and upcharges



top shape

LOK - CONFERENCE

To Order Specify

1 Laminata Model #	2 Edge Detail	3 Laminata Selection	3a PVC Edge Color	4 Electrical	5 Metal Color
Laminata (LKT)	See Edge Detail Options	See Laminata Selection	See PVC Edge Color Options	N None CT2 Dual Power Center Top CU2 Dual Power Underside CT2U1 Dual Power Center Top with Underside (See chart on next page)	See Metal Finish Color Options

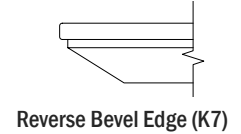
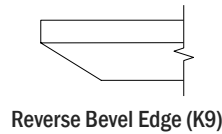
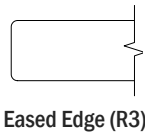
Model Number Breakdown

LKT5496-36TPRT						
LK	T	4896	36	TP	R	T
LOK	Laminata	48" x 96"	Height	Taper Top Shape	Rounded Corner	T Base

Description

Rounded Taper Table with T Base at Counter Height (continued)

Veneer Tables "LKV" Models	Solid Surface Tables "LKS" Models
----------------------------	-----------------------------------



	D	W	H	CTN WT	CU FT	① Model	Veneer Tables "LKV" Models		Solid Surface Tables "LKS" Models		
							Flat Cut	Double Cut	Flat Cut	Double Cut	Standard
VEN.	54	96	36	222	127	LKV5496-36TPRT	\$4,918	\$5,311	\$5,360	\$5,709	--
S.S.	54	96	36	222	127	LKS5496-36TPRT	--	--	--	--	\$13,704

Electrical Options and Upcharges

CT2	84 - 96 wide
Dual Power Center Top - Black	CT2BL - add \$1,490
Dual Power Center Top - White	CT2WH - add \$1,490
CU1	
Dual Power Underside - Black	CU1-1C - add \$592
Dual Power Underside with Wireless Charging - Black	CU1-1CW - add \$1,371
CT2U1	
Dual Power Center Top - Black with Underside	CT2U1-BL - add \$1,813
Dual Power Center Top - White with Underside	CT2U1-WH - add \$1,813
Dual Power Center Top - Black with Wireless Charging	CT2U1-BLW2 - add \$2,592
Dual Power Center Top - White with Wireless Charging	CT2U1-WHW2 - add \$2,592

LOK - CONFERENCE

Note: Order power infeed that best fits application

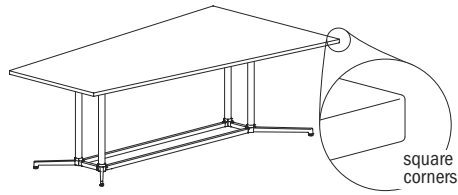
To Order Specify

① Veneer Model #	② Edge Detail	③ Wood Species	④ Wood Finish	⑤ Electrical	⑥ Metal Color
Veneer (LKV)	See Edge Detail Options	Flat Cut CH1 Cherry MA1 Maple WA1 Walnut BO1 Black Oak	See Flat Cut Wood Finish Options	N None CT2 Dual Power Center Top CU2 Dual Power Underside CT2U1 Dual Power Center Top with Underside (See chart above)	See Metal Finish Color Options
		Double Cut DC1 Double Cut	④ Wood Finish See Double Cut Wood Finish Options		

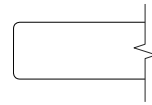
① Solid Surface Model #	② Top Surface Selection	③ Electrical	④ Metal Color
Solid Surface (LKS)	See Solid Surface Top Surface Selection Options	N None CT2 Dual Power Center Top CU2 Dual Power Underside CT2U1 Dual Power Center Top with Underside (See chart above)	See Metal Finish Color Options

Description

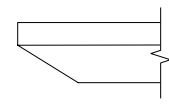
Taper Table with Y Base at Counter Height



Laminate Tables "LKT" Models



Eased Edge (R3)



Reverse Bevel Edge (K9)

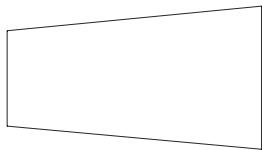
LAM.	D	W	H	CTN WT	CU FT	Model	Standard			Graded In		
							Tier 1	Tier 2	Tier 3	Tier 1	Tier 2	Tier 3
		54	96	36	198	127	LKT5496-36TPY	\$3,405	\$3,463	\$3,821	\$3,890	\$3,948

Features:

- price reflects complete table - top and base
- ships KD in multiple cartons
- one piece top
- model includes adjustable glide

Options:

- specify power/charging option, see below for options and upcharges



top shape

LOK - CONFERENCE

To Order Specify

1 Laminate Model #	2 Edge Detail	3 Laminate Selection	3a PVC Edge Color	4 Electrical	5 Metal Color
Laminate (LKT)	See Edge Detail Options	See Laminate Selection	See PVC Edge Color Options	N None CT2 Dual Power Center Top CU2 Dual Power Underside CT2U1 Dual Power Center Top with Underside (See chart on next page)	See Metal Finish Color Options

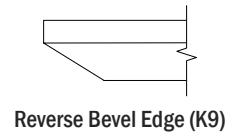
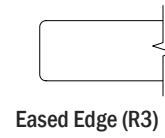
Model Number Breakdown

LKT4896-36TPY					
LK	T	4896	36	TP	Y
LOK	Laminate	48" x 96"	Height	Taper Top Shape	Y Base

Description

Taper Table with Y Base at Counter Height
(continued)

Veneer Tables "LKV" Models



VEN.	D	W	H	CTN WT	CU FT	1 Model	Flat Cut	Double Cut	Flat Cut	Double Cut
		54	96	36	198	127	LKV5496-36TPY	\$4,682	\$5,055	\$5,104

Electrical Options and Upcharges

CT2		84 - 96 wide
Dual Power Center Top - Black	CT2BL	- add \$1,490
Dual Power Center Top - White	CT2WH	- add \$1,490
CU1		
Dual Power Underside - Black	CU1-1C	- add \$592
Dual Power Underside with Wireless Charging - Black	CU1-1CW	- add \$1,371
CT2U1		
Dual Power Center Top - Black with Underside	CT2U1-BL	- add \$1,813
Dual Power Center Top - White with Underside	CT2U1-WH	- add \$1,813
Dual Power Center Top - Black with Wireless Charging	CT2U1-BLW2	- add \$2,592
Dual Power Center Top - White with Wireless Charging	CT2U1-WhW2	- add \$2,592

Note: Order power infeed that best fits application

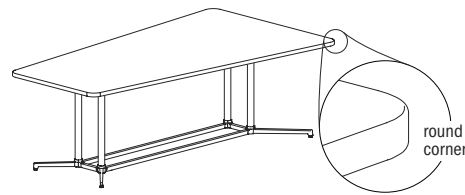
To Order Specify

1 Veneer Model #	2 Edge Detail	3 Wood Species	4 Wood Finish	5 Electrical	6 Metal Color
Veneer (LKV)	See Edge Detail Options	Flat Cut CH1 Cherry MA1 Maple WA1 Walnut BO1 Black Oak	See Flat Cut Wood Finish Options	N None CT2 Dual Power Center Top CU2 Dual Power Underside CT2U1 Dual Power Center Top with Underside (See chart above)	See Metal Finish Color Options
		Double Cut DC1 Double Cut	See Double Cut Wood Finish Options		

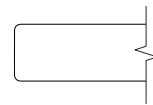
LOK - CONFERENCE

Description

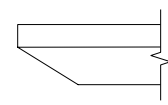
Rounded Taper Table with Y Base at Counter Height



Laminate Tables "LKT" Models



Eased Edge (R3)



Reverse Bevel Edge (K9)

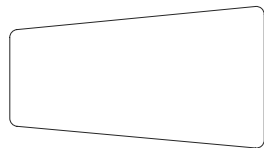
LAM.	D	W	H	CTN WT	CU FT	Model	Standard			Graded In		
	Tier 1	Tier 2	Tier 3	Tier 1	Tier 2	Tier 3	Tier 1	Tier 2	Tier 3	Tier 1	Tier 2	Tier 3
	54	96	36	198	127	LKT5496-36TPRY	\$3,405	\$3,463	\$3,821	\$3,890	\$3,948	\$4,204

Features:

- price reflects complete table - top and base
- ships KD in multiple cartons
- one piece top
- model includes adjustable glide

Options:

- specify power/charging option, see below for options and upcharges



top shape

LOK - CONFERENCE

To Order Specify

1 Laminate Model #	2 Edge Detail	3 Laminate Selection	3a PVC Edge Color	4 Electrical	5 Metal Color
Laminate (LKT)	See Edge Detail Options	See Laminate Selection	See PVC Edge Color Options	N None CT2 Dual Power Center Top CU2 Dual Power Underside CT2U1 Dual Power Center Top with Underside (See chart on next page)	See Metal Finish Color Options

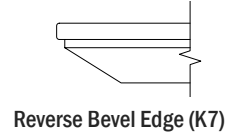
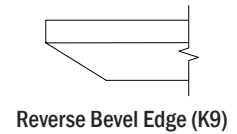
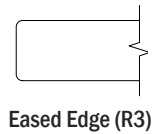
Model Number Breakdown

LKT5496-36TPRY						
LK	T	4896	36	TP	R	Y
LOK	Laminate	48" x 96"	Height	Taper Top Shape	Rounded Corner	Y Base

Description

Rounded Taper Table with Y Base at Counter Height (continued)

Veneer Tables "LKV" Models	Solid Surface Tables "LKS" Models
----------------------------	-----------------------------------



	D	W	H	CTN WT	CU FT	① Model	Flat Cut	Double Cut	Flat Cut	Double Cut	Standard
VEN.	54	96	36	198	127	LKV5496-36TPRY	\$4,682	\$5,055	\$5,104	\$5,435	--
S.S.	54	96	36	198	127	LKS5496-36TPRY	--	--	--	--	\$13,467

Electrical Options and Upcharges

CT2	84 - 96 wide
Dual Power Center Top - Black	CT2BL - add \$1,490
Dual Power Center Top - White	CT2WH - add \$1,490
CU1	
Dual Power Underside - Black	CU1-1C - add \$592
Dual Power Underside with Wireless Charging - Black	CU1-1CW - add \$1,371
CT2U1	
Dual Power Center Top - Black with Underside	CT2U1-BL - add \$1,813
Dual Power Center Top - White with Underside	CT2U1-WH - add \$1,813
Dual Power Center Top - Black with Wireless Charging	CT2U1-BLW2 - add \$2,592
Dual Power Center Top - White with Wireless Charging	CT2U1-WHW2 - add \$2,592

LOK - CONFERENCE

Note: Order power infeed that best fits application

To Order Specify

① Veneer Model #	② Edge Detail	③ Wood Species	④ Wood Finish	⑤ Electrical	⑥ Metal Color
Veneer (LKV)	See Edge Detail Options	Flat Cut CH1 Cherry MA1 Maple WA1 Walnut BO1 Black Oak	See Flat Cut Wood Finish Options	N None CT2 Dual Power Center Top CU2 Dual Power Underside CT2U1 Dual Power Center Top with Underside (See chart above)	See Metal Finish Color Options
		Double Cut DC1 Double Cut	④ Wood Finish See Double Cut Wood Finish Options		

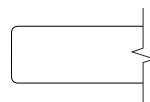
① Solid Surface Model #	② Top Surface Selection	③ Electrical	④ Metal Color
Solid Surface (LKS)	See Solid Surface Top Surface Selection Options	N None CT2 Dual Power Center Top CU2 Dual Power Underside CT2U1 Dual Power Center Top with Underside (See chart above)	See Metal Finish Color Options

Description

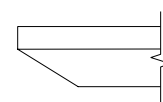
Round Table with X Base
at Counter Height



Laminate Tables
"LKT" Models



Eased Edge (R3)



Reverse Bevel Edge (K9)

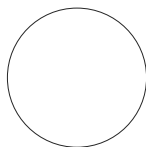
LAMINATE	D	W	H	CTN WT	CU FT	❶ Model	Eased Edge (R3)			Reverse Bevel Edge (K9)		
							Standard	Graded In		Standard	Graded In	
							Tier 1	Tier 2	Tier 3	Tier 1	Tier 2	Tier 3
	48	48	36	88	37	LKT48-36RDX	\$1,683	\$1,803	\$1,934	\$2,139	\$2,257	\$2,389
	42	42	36	74	35	LKT42-36RDX	\$1,548	\$1,666	\$1,762	\$2,003	\$2,120	\$2,217
	36	36	36	60	33	LKT36-36RDX	\$1,499	\$1,544	\$1,612	\$1,956	\$2,000	\$2,068
	30	30	36	48	30	LKT30-36RDX	\$1,449	\$1,484	\$1,525	\$1,905	\$1,940	\$1,980

Features:

- price reflects complete table - top and base
- ships KD in multiple cartons
- one piece top
- model includes adjustable glide
- when electrical option is selected, power accessible base is shipped; see page 178 for details
- power/charging units have 72" cord
- power cord is routed inside base column

Options:

- specify power access base with power unit option; None (N), add \$643 for EC23 (CTEC23), add \$533 for EC24 (CTEC24)



top shape

LOK - CONFERENCE

To Order Specify

❶ Laminate Model #	❷ Edge Detail	❸ Laminate Selection	❹ PVC Edge Color	❺ Electrical	❻ Metal Color
Laminate (LKT)	See Edge Detail Options	See Laminate Selection	See PVC Edge Color Options	N None CTEC23 Power Center Top CTEC24 Power Center Top (See chart on next page)	See Metal Finish Color Options

Model Number Breakdown

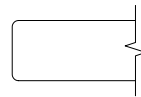
LKT48-36RDX					
LK	T	48	36	RD	X
LOK	Laminate	48" dia.	Height	Round Top Shape	X Base

Description

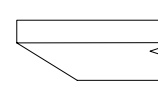
Round Table with X Base
at Counter Height
(continued)

Veneer Tables
"LKV" Models

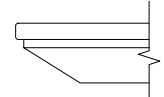
Solid Surface Tables
"LKS" Models



Eased Edge (R3)



Reverse Bevel Edge (K9)



Reverse Bevel Edge (K7)

	D	W	H	CTN WT	CU FT	① Model	Veneer Tables "LKV" Models		Solid Surface Tables "LKS" Models		
							Flat Cut	Double Cut	Flat Cut	Double Cut	Standard
VENEER	48	48	36	88	37	LKV48-36RDX	\$2,217	\$2,364	\$2,303	\$2,454	--
	42	42	36	74	35	LKV42-36RDX	\$2,034	\$2,169	\$2,112	\$2,251	--
	36	36	36	60	33	LKV36-36RDX	\$1,972	\$2,104	\$2,048	\$2,184	--
	30	30	36	48	30	LKV30-36RDX	\$1,904	\$2,030	\$1,978	\$2,107	--
SOLID SURFACE	48	48	36	118	37	LKS48-36RDX	--	--	--	--	\$5,157
	42	42	36	95	35	LKS42-36RDX	--	--	--	--	\$4,399
	36	36	36	76	33	LKS36-36RDX	--	--	--	--	\$3,834
	30	30	36	59	30	LKS30-36RDX	--	--	--	--	\$3,341

Electrical Options and Upcharges

CTEC23	
EC23 Power Center Top - Black	CTEC23BL - add \$643
EC23 Power Center Top - White	CTEC23WH - add \$643
CTEC24	
EC24 Power Center Top - Black	CTEC43BL - add \$533
EC24 Power Center Top - White	CTEC43WH - add \$533

To Order Specify

① Veneer Model #	② Edge Detail	③ Wood Species	④ Wood Finish	⑤ Electrical	⑥ Metal Color
Veneer (LKV)	See Edge Detail Options	Flat Cut CH1 Cherry MA1 Maple WA1 Walnut BO1 Black Oak	See Flat Cut Wood Finish Options	N None CTEC23 Power Center Top CTEC24 Power Center Top (See chart above)	See Metal Finish Color Options
		Double Cut DC1 Double Cut	④ Wood Finish See Double Cut Wood Finish Options		

① Solid Surface Model #	② Top Surface Selection	③ Electrical Cut Out	④ Metal Color
Solid Surface (LKS)	See Solid Surface Top Surface Selection Options	N None CTEC23 Power Center Top CTEC24 Power Center Top (See chart above)	See Metal Finish Color Options

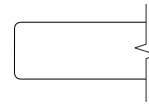
LOK - CONFERENCE

Description

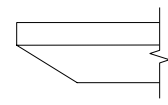
Round Table with X4 Base at Counter Height



Laminate Tables "LKT" Models



Eased Edge (R3)



Reverse Bevel Edge (K9)

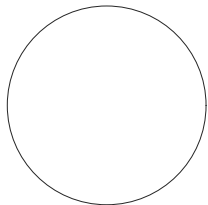
LAMINATE	D	W	H	CTN WT	CU FT	Model	Eased Edge (R3)			Reverse Bevel Edge (K9)		
							Standard	Graded In		Standard	Graded In	
							Tier 1	Tier 2	Tier 3	Tier 1	Tier 2	Tier 3
	60	60	36	157	66	LKT60-36RDZ	\$2,805	\$2,899	\$3,108	\$3,261	\$3,355	\$3,564
	54	54	36	215	63	LKT54-36RDZ	\$2,621	\$2,693	\$2,764	\$3,075	\$3,148	\$3,220

Features:

- price reflects complete table - top and base
- ships KD in multiple cartons
- one piece top
- model includes adjustable glide
- power cord is routed outside base column
- order vertical wire manager separately; see page 407

Options:

- specify power unit option; None (N), add \$643 for EC23 (CTEC23), add \$533 for EC24 (CTEC24)



top shape

LOK - CONFERENCE

To Order Specify

1 Laminates Model #	2 Edge Detail	3 Laminates Selection	3a PVC Edge Color	4 Electrical	5 Metal Color
Laminates (LKT)	See Edge Detail Options	See Laminates Selection	See PVC Edge Color Options	N None CTEC23 Power Center Top CTEC24 Power Center Top (See chart on next page)	See Metal Finish Color Options

Model Number Breakdown

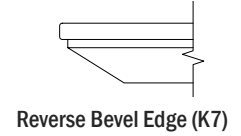
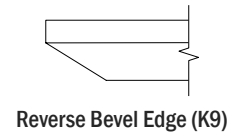
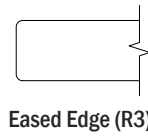
LKT60-36RDZ					
LK	T	60	36	RD	Z
LOK	Laminates	60" dia.	Height	Round Top Shape	X4 Base

Description

Round Table with X4 Base
at Counter Height
(continued)

Veneer Tables
"LKV" Models

Solid Surface Tables
"LKS" Models



	D	W	H	CTN WT	CU FT	① Model	Eased Edge (R3)		Reverse Bevel Edge (K9)		Reverse Bevel Edge (K7)
							Flat Cut	Double Cut	Flat Cut	Double Cut	
VENEER	60	60	36	215	66	LKV60-36RDZ	\$3,676	\$3,917	\$3,811	\$4,064	--
	54	54	36	186	63	LKV54-36RDZ	\$3,471	\$3,707	\$3,606	\$3,852	--
SOL SURF.	60	60	36	157	66	LKS60-36RDZ	--	--	--	--	\$8,003
	54	54	36	186	63	LKS54-36RDZ	--	--	--	--	\$7,069

Electrical Options and Upcharges

CTEC23	
EC23 Power Center Top - Black	CTEC23BL - add \$643
EC23 Power Center Top - White	CTEC23WH - add \$643
CTEC24	
EC24 Power Center Top - Black	CTEC43BL - add \$533
EC24 Power Center Top - White	CTEC43WH - add \$533

To Order Specify

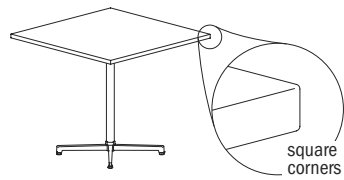
① Veneer Model #	② Edge Detail	③ Wood Species	④ Wood Finish	⑤ Electrical	⑥ Metal Color
Veneer (LKV)	See Edge Detail Options	Flat Cut CH1 Cherry MA1 Maple WA1 Walnut BO1 Black Oak	See Flat Cut Wood Finish Options	N None CTEC23 Power Center Top CTEC24 Power Center Top (See chart above)	See Metal Finish Color Options
		Double Cut DC1 Double Cut	See Double Cut Wood Finish Options		

① Solid Surface Model #	② Top Surface Selection	③ Electrical Cut Out	④ Metal Color
Solid Surface (LKS)	See Solid Surface Top Surface Selection Options	N None CTEC23 Power Center Top CTEC24 Power Center Top (See chart above)	See Metal Finish Color Options

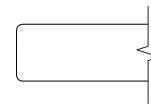
LOK - CONFERENCE

Description

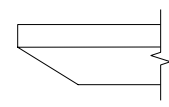
Square Table with X Base at Counter Height



Laminate Tables "LKT" Models



Eased Edge (R3)



Reverse Bevel Edge (K9)

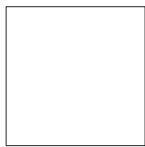
LAMINATE	D	W	H	CTN WT	CU FT	Model	Eased Edge (R3)			Reverse Bevel Edge (K9)		
							Standard	Graded In		Standard	Graded In	
							Tier 1	Tier 2	Tier 3	Tier 1	Tier 2	Tier 3
	42	42	36	93	35	LKT4242-36SQX	\$1,584	\$1,636	\$1,765	\$2,041	\$2,093	\$2,218
	36	36	36	81	33	LKT3636-36SQX	\$1,409	\$1,451	\$1,482	\$1,865	\$1,907	\$1,936
	30	30	36	62	30	LKT3030-36SQX	\$1,269	\$1,302	\$1,318	\$1,721	\$1,757	\$1,774

Features:

- price reflects complete table - top and base
- ships KD in multiple cartons
- one piece top
- model includes adjustable glide
- when electrical option is selected, power accessible base is shipped; see page 178 for details
- power/charging units have 72" cord
- power cord is routed inside base column

Options:

- specify power access base with power unit option; None (N), add \$643 for EC23 (CTEC23), add \$533 for EC24 (CTEC24)



top shape

LOK - CONFERENCE

To Order Specify

1 Laminate Model #	2 Edge Detail	3 Laminate Selection	3a PVC Edge Color	4 Electrical	5 Metal Color
Laminate (LKT)	See Edge Detail Options	See Laminate Selection	See PVC Edge Color Options	N None CTEC23 Power Center Top CTEC24 Power Center Top (See chart on next page)	See Metal Finish Color Options

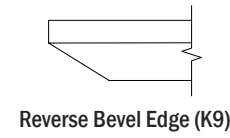
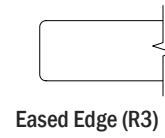
Model Number Breakdown

LKT4242-36SQX					
LK	T	4242	36	SQ	X
LOK	Laminate	42" x 42"	Height	Square Top Shape	X Base

Description

Square Table with X Base
at Counter Height
(continued)

Veneer Tables
"LKV" Models



VENEER	D	W	H	CTN WT	CU FT	① Model	Flat Cut	Double Cut	Flat Cut	Double Cut
		42	42	36	93	35	LKV4242-36SQX	\$2,056	\$2,192	\$2,135
	36	36	36	81	33	LKV3636-36SQX	\$1,825	\$1,945	\$1,894	\$2,019
	30	30	36	62	30	LKV3030-36SQX	\$1,638	\$1,746	\$1,700	\$1,812

LOK - CONFERENCE

Electrical Options and Upcharges

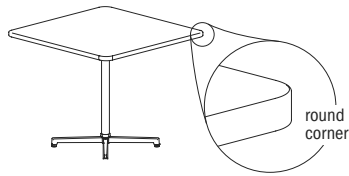
CTEC23	
EC23 Power Center Top - Black	CTEC23BL - add \$643
EC23 Power Center Top - White	CTEC23WH - add \$643
CTEC24	
EC24 Power Center Top - Black	CTEC43BL - add \$533
EC24 Power Center Top - White	CTEC43WH - add \$533

To Order Specify

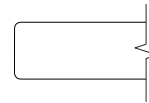
① Veneer Model #	② Edge Detail	③ Wood Species	④ Wood Finish	⑤ Electrical	⑥ Metal Color
Veneer (LKV)	See Edge Detail Options	Flat Cut CH1 Cherry MA1 Maple WA1 Walnut BO1 Black Oak	See Flat Cut Wood Finish Options	N None CTEC23 Power Center Top CTEC24 Power Center Top (See chart above)	See Metal Finish Color Options
		Double Cut DC1 Double Cut	④ Wood Finish See Double Cut Wood Finish Options		

Description

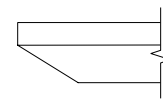
Rounded Square Table with X Base at Counter Height



Laminate Tables
"LKT" Models



Eased Edge (R3)



Reverse Bevel Edge (K9)

LAMINATE	D	W	H	CTN WT	CU FT	Model	Eased Edge (R3)		Reverse Bevel Edge (K9)			
							Standard	Graded In	Standard	Graded In		
							Tier 1	Tier 2	Tier 3	Tier 1	Tier 2	Tier 3
	42	42	36	93	35	LKT4242-36SQRX	\$1,942	\$1,995	\$2,171	\$2,395	\$2,450	\$2,627
	36	36	36	81	33	LKT3636-36SQRX	\$1,509	\$1,551	\$1,618	\$1,964	\$2,007	\$2,073
	30	30	36	62	30	LKT3030-36SQRX	\$1,403	\$1,431	\$1,496	\$1,858	\$1,895	\$1,940

Features:

- price reflects complete table - top and base
- ships KD in multiple cartons
- one piece top
- model includes adjustable glide
- when electrical option is selected, power accessible base is shipped; see page 178 for details
- power/charging units have 72" cord
- power cord is routed inside base column

Options:

- specify power access base with power unit option; None (N), add \$643 for EC23 (CTEC23), add \$533 for EC24 (CTEC24)



top shape

LOK - CONFERENCE

To Order Specify

1 Laminate Model #	2 Edge Detail	3 Laminate Selection	3a PVC Edge Color	4 Electrical	5 Metal Color
Laminate (LKT)	See Edge Detail Options	See Laminate Selection	See PVC Edge Color Options	N None CTEC23 Power Center Top CTEC24 Power Center Top (See chart on next page)	See Metal Finish Color Options

Model Number Breakdown

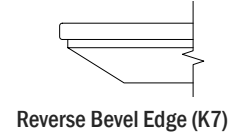
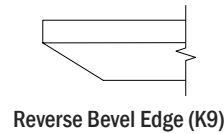
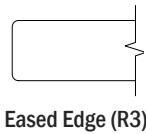
LKT4242-36SQRX						
LK	T	4242	36	SQ	R	X
LOK	Laminate	42" x 42"	Height	Square Top Shape	Rounded Corner	X Base

Description

Rounded Square Table with X Base at Counter Height (continued)

Veneer Tables "LKV" Models

Solid Surface Tables "LKS" Models



	D	W	H	CTN WT	CU FT	① Model	Veneer Tables "LKV" Models		Solid Surface Tables "LKS" Models		
							Flat Cut	Double Cut	Flat Cut	Double Cut	Standard
VENEER	42	42	36	93	35	LKV4242-36SQRX	\$2,536	\$2,705	\$2,632	\$2,811	--
	36	36	36	81	33	LKV3636-36SQRX	\$2,104	\$2,243	\$2,183	\$2,328	--
	30	30	36	62	30	LKV3030-36SQRX	\$1,881	\$2,006	\$1,954	\$2,083	--
SOLID SURFACE	42	42	36	93	35	LKS4242-36SQRX	--	--	--	--	\$5,010
	36	36	36	81	33	LKS3636-36SQRX	--	--	--	--	\$3,967
	30	30	36	62	30	LKS3030-36SQRX	--	--	--	--	\$3,319

Electrical Options and Upcharges

CTEC23	
EC23 Power Center Top - Black	CTEC23BL - add \$643
EC23 Power Center Top - White	CTEC23WH - add \$643
CTEC24	
EC24 Power Center Top - Black	CTEC43BL - add \$533
EC24 Power Center Top - White	CTEC43WH - add \$533

To Order Specify

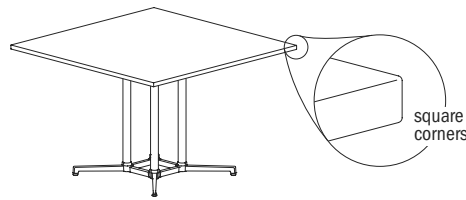
① Veneer Model #	② Edge Detail	③ Wood Species	④ Wood Finish	⑤ Electrical	⑥ Metal Color
Veneer (LKV)	See Edge Detail Options	Flat Cut CH1 Cherry MA1 Maple WA1 Walnut BO1 Black Oak	See Flat Cut Wood Finish Options	N None CTEC23 Power Center Top CTEC24 Power Center Top (See chart above)	See Metal Finish Color Options
		Double Cut DC1 Double Cut	See Double Cut Wood Finish Options		

① Solid Surface Model #	② Top Surface Selection	③ Electrical Cut Out	④ Metal Color
Solid Surface (LKS)	See Solid Surface Top Surface Selection Options	N None CTEC23 Power Center Top CTEC24 Power Center Top (See chart above)	See Metal Finish Color Options

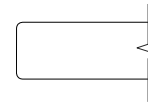
LOK - CONFERENCE

Description

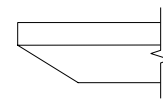
Square Table with X4 Base at Counter Height



Laminate Tables "LKT" Models



Eased Edge (R3)



Reverse Bevel Edge (K9)

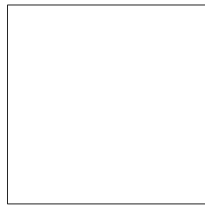
LAMINATE	D	W	H	CTN WT	CU FT	Model	Eased Edge (R3)			Reverse Bevel Edge (K9)		
							Standard	Graded In		Standard	Graded In	
							Tier 1	Tier 2	Tier 3	Tier 1	Tier 2	Tier 3
	60	60	36	181	66	LKT6060-36SQZ	\$3,185	\$3,277	\$3,488	\$3,640	\$3,734	\$3,942
	54	54	36	157	63	LKT5454-36SQZ	\$3,033	\$3,114	\$3,279	\$3,489	\$3,570	\$3,735
	48	48	36	108	60	LKT4848-36SQZ	\$2,524	\$2,579	\$2,717	\$2,979	\$3,034	\$3,174

Features:

- price reflects complete table - top and base
- ships KD in multiple cartons
- one piece top
- model includes adjustable glide
- power cord is routed outside base column
- order vertical wire manager separately; see page 407

Options:

- specify power unit option; None (N), add \$643 for EC23 (CTEC23), add \$533 for EC24 (CTEC24)



top shape

LOK - CONFERENCE

To Order Specify

1 Laminate Model #	2 Edge Detail	3 Laminate Selection	3a PVC Edge Color	4 Electrical	5 Metal Color
Laminate (LKT)	See Edge Detail Options	See Laminate Selection	See PVC Edge Color Options	N None CTEC23 Power Center Top CTEC24 Power Center Top (See chart on next page)	See Metal Finish Color Options

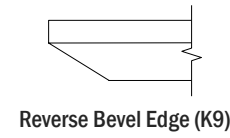
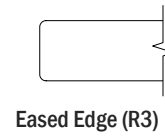
Model Number Breakdown

LKT6060-36SQZ					
LK	T	6060	36	SQ	Z
LOK	Laminate	60" x 60"	Height	Square Top Shape	X4 Base

Description

Square Table with X4 Base
at Counter Height
(continued)

Veneer Tables
"LKV" Models



VENEER	D	W	H	CTN WT	CU FT	① Model	Flat Cut	Double Cut	Flat Cut	Double Cut
		60	60	36	181	66	LKV6060-36SQZ	\$4,126	\$4,398	\$4,280
	54	54	36	157	63	LKV5454-36SQZ	\$3,927	\$4,186	\$4,072	\$4,342
	48	48	36	108	60	LKV4848-36SQZ	\$3,037	\$3,186	\$3,124	\$3,279

LOK - CONFERENCE

Electrical Options and Upcharges

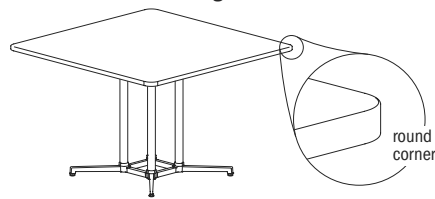
CTEC23	
EC23 Power Center Top - Black	CTEC23BL - add \$643
EC23 Power Center Top - White	CTEC23WH - add \$643
CTEC24	
EC24 Power Center Top - Black	CTEC43BL - add \$533
EC24 Power Center Top - White	CTEC43WH - add \$533

To Order Specify

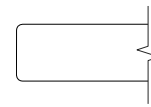
① Veneer Model #	② Edge Detail	③ Wood Species	④ Wood Finish	⑤ Electrical	⑥ Metal Color
Veneer (LKV)	See Edge Detail Options	Flat Cut CH1 Cherry MA1 Maple WA1 Walnut BO1 Black Oak	See Flat Cut Wood Finish Options	N None CTEC23 Power Center Top CTEC24 Power Center Top (See chart above)	See Metal Finish Color Options
		Double Cut DC1 Double Cut	④ Wood Finish See Double Cut Wood Finish Options		

Description

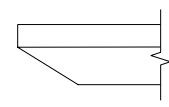
Rounded Square Table with X4 Base at Counter Height



Laminate Tables "LKT" Models



Eased Edge (R3)



Reverse Bevel Edge (K9)

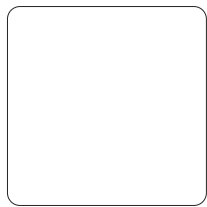
LAMINATE	D	W	H	CTN WT	CU FT	Model	Eased Edge (R3)			Reverse Bevel Edge (K9)		
							Standard	Graded In		Standard	Graded In	
							Tier 1	Tier 2	Tier 3	Tier 1	Tier 2	Tier 3
	60	60	36	181	66	LKT6060-36SQRZ	\$3,382	\$3,433	\$3,760	\$3,975	\$4,029	\$4,262
	54	54	36	157	63	LKT5454-36SQRZ	\$2,838	\$2,920	\$3,082	\$3,292	\$3,374	\$3,536
	48	48	36	181	60	LKT4848-36SQRZ	\$2,892	\$2,950	\$3,113	\$3,349	\$3,405	\$3,569

Features:

- price reflects complete table - top and base
- ships KD in multiple cartons
- one piece top
- model includes adjustable glide
- power cord is routed outside base column
- order vertical wire manager separately; see page 407

Options:

- specify power unit option; None (N), add \$643 for EC23 (CTEC23), add \$533 for EC24 (CTEC24)



top shape

LOK - CONFERENCE

To Order Specify

1 Laminate Model #	2 Edge Detail	3 Laminate Selection	3a PVC Edge Color	4 Electrical	5 Metal Color
Laminate (LKT)	See Edge Detail Options	See Laminate Selection	See PVC Edge Color Options	N None CTEC23 Power Center Top CTEC24 Power Center Top (See chart on next page)	See Metal Finish Color Options

Model Number Breakdown

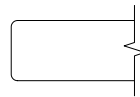
LKT6060-36SQRX						
LK	T	6060	36	SQ	R	Z
LOK	Laminate	60" x 60"	Height	Square Top Shape	Rounded Corner	X Base

Description

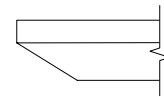
Rounded Square Table with X4 Base at Counter Height (continued)

Veneer Tables "LKV" Models

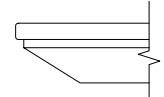
Solid Surface Tables "LKS" Models



Eased Edge (R3)



Reverse Bevel Edge (K9)



Reverse Bevel Edge (K7)

	D	W	H	CTN WT	CU FT	① Model	Veneer Tables "LKV" Models		Solid Surface Tables "LKS" Models		
							Flat Cut	Double Cut	Flat Cut	Double Cut	Standard
VENEER	60	60	36	181	66	LKV6060-36SQRZ	\$4,435	\$4,729	\$4,603	\$4,908	--
	54	54	36	157	63	LKV5454-36SQRZ	\$3,666	\$3,905	\$3,803	\$4,054	--
	48	48	36	142	60	LKV4848-36SQRZ	\$3,525	\$3,708	\$3,631	\$3,822	--
SOLID SURFACE	60	60	36	215	66	LKS6060-36SQRZ	--	--	--	--	\$8,760
	54	54	36	186	63	LKS5454-36SQRZ	--	--	--	--	\$7,262
	48	48	36	181	60	LKS4848-36SQRZ	--	--	--	--	\$5,775

Electrical Options and Upcharges

CTEC23	
EC23 Power Center Top - Black	CTEC23BL - add \$643
EC23 Power Center Top - White	CTEC23WH - add \$643
CTEC24	
EC24 Power Center Top - Black	CTEC43BL - add \$533
EC24 Power Center Top - White	CTEC43WH - add \$533

To Order Specify

① Veneer Model #	② Edge Detail	③ Wood Species	④ Wood Finish	⑤ Electrical	⑥ Metal Color
Veneer (LKV)	See Edge Detail Options	Flat Cut CH1 Cherry MA1 Maple WA1 Walnut BO1 Black Oak	See Flat Cut Wood Finish Options	N None CTEC23 Power Center Top CTEC24 Power Center Top (See chart above)	See Metal Finish Color Options
		Double Cut DC1 Double Cut	④ Wood Finish See Double Cut Wood Finish Options		

① Solid Surface Model #	② Top Surface Selection	③ Electrical Cut Out	④ Metal Color
Solid Surface (LKS)	See Solid Surface Top Surface Selection Options	N None CTEC23 Power Center Top CTEC24 Power Center Top (See chart above)	See Metal Finish Color Options

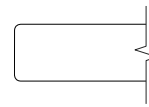
LOK - CONFERENCE

Description

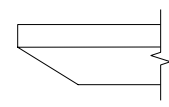
Squircle Table with X Base at Counter Height



Laminate Tables "LKT" Models



Eased Edge (R3)



Reverse Bevel Edge (K9)

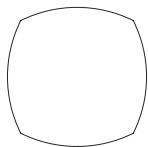
LAMINATE	D	W	H	CTN WT	CU FT	Model	Eased Edge (R3)		Reverse Bevel Edge (K9)			
							Standard	Graded In	Standard	Graded In		
							Tier 1	Tier 2	Tier 3	Tier 1	Tier 2	Tier 3
	42	42	36	93	35	LKT42-36SCX	\$1,569	\$1,685	\$1,783	\$2,024	\$2,142	\$2,240
	36	36	36	81	33	LKT36-36SCX	\$1,519	\$1,563	\$1,631	\$1,978	\$2,021	\$2,089
	30	30	36	62	30	LKT30-36SCX	\$1,468	\$1,504	\$1,544	\$1,923	\$1,847	\$2,001

Features:

- price reflects complete table - top and base
- ships KD in multiple cartons
- one piece top
- model includes adjustable glide
- when electrical option is selected, power accessible base is shipped; see page 178 for details
- power/charging units have 72" cord
- power cord is routed inside base column

Options:

- specify power access base with power unit option; None (N), add \$643 for EC23 (CTEC23), add \$533 for EC24 (CTEC24)



top shape

LOK - CONFERENCE

To Order Specify

1 Laminate Model #	2 Edge Detail	3 Laminate Selection	3a PVC Edge Color	4 Electrical	5 Metal Color
Laminate (LKT)	See Edge Detail Options	See Laminate Selection	See PVC Edge Color Options	N None CTEC23 Power Center Top CTEC24 Power Center Top (See chart on next page)	See Metal Finish Color Options

Model Number Breakdown

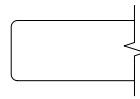
LKT42-36SCX					
LK	T	42	36	SC	X
LOK	Laminate	42" dia.	Height	Squircle Top Shape	X Base

Description

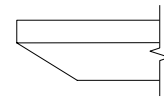
Squirrel Table with X Base at Counter Height (continued)

Veneer Tables "LKV" Models

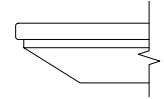
Solid Surface Tables "LKS" Models



Eased Edge (R3)



Reverse Bevel Edge (K9)



Reverse Bevel Edge (K7)

	D	W	H	CTN WT	CU FT	① Model	Veneer Tables "LKV" Models		Solid Surface Tables "LKS" Models		
							Flat Cut	Double Cut	Flat Cut	Double Cut	Standard
VENEER	42	42	36	93	35	LKV42-36SCX	\$2,056	\$2,191	\$2,135	\$2,276	--
	36	36	36	81	33	LKV36-36SCX	\$1,993	\$2,122	\$2,070	\$2,205	--
	30	30	36	62	30	LKV30-36SCX	\$1,921	\$2,048	\$1,997	\$2,127	--
SOLID SURFACE	42	42	36	93	35	LKS42-36SCX	--	--	--	--	\$4,437
	36	36	36	81	33	LKS36-36SCX	--	--	--	--	\$3,582
	30	30	36	62	30	LKS30-36SCX	--	--	--	--	\$3,737

Electrical Options and Upcharges

CTEC23	
EC23 Power Center Top - Black	CTEC23BL - add \$643
EC23 Power Center Top - White	CTEC23WH - add \$643
CTEC24	
EC24 Power Center Top - Black	CTEC43BL - add \$533
EC24 Power Center Top - White	CTEC43WH - add \$533

To Order Specify

① Veneer Model #	② Edge Detail	③ Wood Species	④ Wood Finish	⑤ Electrical	⑥ Metal Color
Veneer (LKV)	See Edge Detail Options	Flat Cut CH1 Cherry MA1 Maple WA1 Walnut BO1 Black Oak	See Flat Cut Wood Finish Options	N None CTEC23 Power Center Top CTEC24 Power Center Top (See chart above)	See Metal Finish Color Options
		Double Cut DC1 Double Cut	④ Wood Finish See Double Cut Wood Finish Options		

① Solid Surface Model #	② Top Surface Selection	③ Electrical Cut Out	④ Metal Color
Solid Surface (LKS)	See Solid Surface Top Surface Selection Options	N None CTEC23 Power Center Top CTEC24 Power Center Top (See chart above)	See Metal Finish Color Options

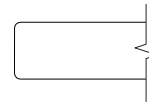
LOK - CONFERENCE

Description

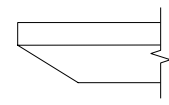
Squircle Table with X4 Base at Counter Height



Laminate Tables "LKT" Models



Eased Edge (R3)



Reverse Bevel Edge (K9)

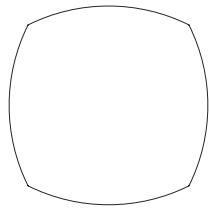
LAMINATE	D	W	H	CTN WT	CU FT	Model	Eased Edge (R3)			Reverse Bevel Edge (K9)		
							Standard	Graded In		Standard	Graded In	
							Tier 1	Tier 2	Tier 3	Tier 1	Tier 2	Tier 3
	60	60	36	163	66	LKT60-36SCZ	\$2,825	\$2,921	\$3,128	\$3,284	\$3,379	\$3,586
	54	54	36	143	63	LKT54-36SCZ	\$2,642	\$2,714	\$2,785	\$3,098	\$3,171	\$3,244
	48	48	36	136	60	LKT48-36SCZ	\$2,511	\$2,629	\$2,760	\$2,966	\$3,086	\$3,218

Features:

- price reflects complete table - top and base
- ships KD in multiple cartons
- one piece top
- model includes adjustable glide
- power cord is routed outside base column
- order vertical wire manager separately; see page 407

Options:

- specify power unit option; None (N), add \$643 for EC23 (CTEC23), add \$533 for EC24 (CTEC24)



top shape

LOK - CONFERENCE

To Order Specify

1 Laminate Model #	2 Edge Detail	3 Laminate Selection	3a PVC Edge Color	4 Electrical	5 Metal Color
Laminate (LKT)	See Edge Detail Options	See Laminate Selection	See PVC Edge Color Options	N None CTEC23 Power Center Top CTEC24 Power Center Top (See chart on next page)	See Metal Finish Color Options

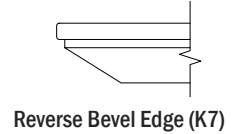
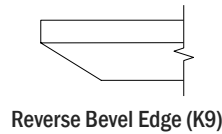
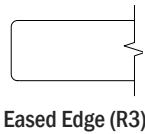
Model Number Breakdown

LKT60-36SCZ					
LK	T	60	36	SC	Z
LOK	Laminate	60" dia.	Height	Squircle Top Shape	X4 Base

Description

Squirrel Table with X4 Base at Counter Height (continued)

Veneer Tables "LKV" Models Solid Surface Tables "LKS" Models



	D	W	H	CTN WT	CU FT	① Model	Eased Edge (R3)		Reverse Bevel Edge (K9)		Standard
							Flat Cut	Double Cut	Flat Cut	Double Cut	
VENEER	60	60	36	163	66	LKV60-36SCZ	\$3,697	\$3,938	\$3,834	\$4,086	--
	54	54	36	143	63	LKV54-36SCZ	\$3,494	\$3,728	\$3,630	\$3,875	--
	48	48	36	136	60	LKV48-36SCZ	\$3,044	\$3,189	\$3,128	\$3,284	--
SOLID SURFACE	60	60	36	163	66	LKS60-36SCZ	--	--	--	--	\$8,042
	54	54	36	143	63	LKS54-36SCZ	--	--	--	--	\$7,551
	48	48	36	136	60	LKS48-36SCZ	--	--	--	--	\$6,004

Electrical Options and Upcharges

CTEC23	
EC23 Power Center Top - Black	CTEC23BL - add \$643
EC23 Power Center Top - White	CTEC23WH - add \$643
CTEC24	
EC24 Power Center Top - Black	CTEC43BL - add \$533
EC24 Power Center Top - White	CTEC43WH - add \$533

To Order Specify

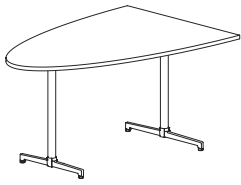
① Veneer Model #	② Edge Detail	③ Wood Species	④ Wood Finish	⑤ Electrical	⑥ Metal Color
Veneer (LKV)	See Edge Detail Options	Flat Cut CH1 Cherry MA1 Maple WA1 Walnut BO1 Black Oak	See Flat Cut Wood Finish Options	N None CTEC23 Power Center Top CTEC24 Power Center Top (See chart above)	See Metal Finish Color Options
		Double Cut DC1 Double Cut	See Double Cut Wood Finish Options		

① Solid Surface Model #	② Top Surface Selection	③ Electrical Cut Out	④ Metal Color
Solid Surface (LKS)	See Solid Surface Top Surface Selection Options	N None CTEC23 Power Center Top CTEC24 Power Center Top (See chart above)	See Metal Finish Color Options

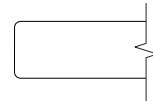
LOK - CONFERENCE

Description

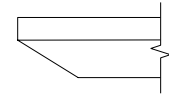
Hive Table with T Base at Counter Height



**Laminate Tables
"LKT" Models**



Eased Edge (R3)



Reverse Bevel Edge (K9)

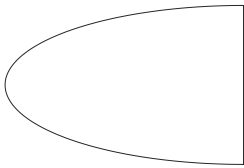
LAM.	D	W	H	CTN WT	CU FT	Model	Standard	Graded In		Standard	Graded In	
							Tier 1	Tier 2	Tier 3	Tier 1	Tier 2	Tier 3
	48	72	36	135	87	LKT4872-36HVT	\$2,209	\$2,253	\$2,516	\$2,705	\$2,749	\$2,935

Features:

- price reflects complete table - top and base
- ships KD in multiple cartons
- model includes adjustable glide

Options:

- specify power/charging option, see below for options and upcharges



top shape

LOK - CONFERENCE

To Order Specify

1 Laminate Model #	2 Edge Detail	3 Laminate Selection	3a PVC Edge Color	4 Electrical
Laminate (LKT)	See Edge Detail Options	See Laminate Selection	See PVC Edge Color Options	N None CT2 Dual Power Center Top (See chart on next page) CU1 Single Power Underside 5 Metal Finish See Metal Finish Color Options

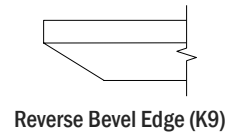
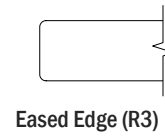
Model Number Breakdown

LKT4872-36HVT					
LK	T	4872	36	HV	T
LOK	Laminate	48" x 72"	Height	Hive Top Shape	T base

Description

Hive Table with T Base at Counter Height
(continued)

Veneer Tables
"LKV" Models



VEN.	D	W	H	CTN WT	CU FT	① Model				
							Flat Cut	Double Cut	Flat Cut	Double Cut
	48	72	36	135	87	LKV4872-36HVT	\$2,784	\$3,007	\$3,033	\$3,231

Electrical Options and Upcharges

CT2	
Dual Power Center Top - Black	CT2BL - add \$1,437
Dual Power Center Top - White	CT2WH - add \$1,437
CU1	
Single Power Underside - Black	CU11C - add \$559
Single Power Underside with Wireless Charging - Black	CU11CW - add \$1,338

Note: Order power infeed that best fits application.

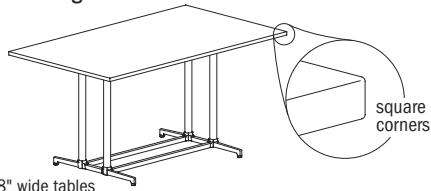
To Order, Specify:

① Veneer Model #	② Edge Detail	③ Wood Species	④ Top Wood Finish	⑤ Electrical	⑥ Metal Color
Veneer (LKV)	See Edge Detail Options	Flat Cut CH1 Cherry MA1 Maple WA1 Walnut BO1 Black Oak	See Flat Cut Wood Finish Options	N None CT2 Dual Power Center Top CU1 Single Power Underside (See chart above)	See Metal Finish Color Options
		Double Cut DC1 Double Cut	④ Top Wood Finish See Double Cut Wood Finish Options		

LOK - CONFERENCE

Description

Rectangular Table with T Base at Bar Height



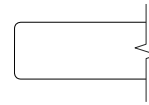
48" wide tables have double column base

D	W	H	CTN WT	CU FT	Model
48	96	42	239	132	LKT4896-42TTT
48	84	42	216	117	LKT4884-42TTT

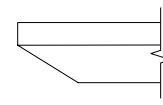
LAMINATE

42	96	42	190	118	LKT4296-42TTT	\$2,961	\$3,006	\$3,285	\$3,420	\$3,464	\$3,664
42	84	42	215	105	LKT4284-42TTT	\$3,039	\$3,078	\$3,321	\$3,489	\$3,529	\$3,703
36	96	42	169	102	LKT3696-42TTT	\$2,513	\$2,550	\$2,790	\$2,959	\$2,997	\$3,168
36	84	42	151	90	LKT3684-42TTT	\$2,268	\$2,303	\$2,513	\$2,709	\$2,740	\$2,890

Laminate Tables "LKT" Models



Eased Edge (R3)



Reverse Bevel Edge (K9)

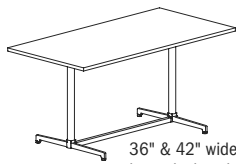
Standard		Graded In		Standard		Graded In	
Tier 1	Tier 2	Tier 3		Tier 1	Tier 2	Tier 3	
\$3,337	\$3,389	\$3,707		\$3,809	\$3,863	\$4,089	
\$3,078	\$3,124	\$3,400		\$3,540	\$3,585	\$3,784	

Features:

- price reflects complete table - top and base
- ships KD in multiple cartons
- one piece top
- model includes adjustable glide

Options:

- specify power/charging option, see below for options and upcharges



36" & 42" wide tables have single column base



top shape

LOK - CONFERENCE

To Order Specify

1 Laminate Model #	2 Edge Detail	3 Laminate Selection	3a PVC Edge Color	4 Electrical	5 Metal Color
Laminate (LKT)	See Edge Detail Options	See Laminate Selection	See PVC Edge Color Options	N None CT2 Dual Power Center Top CU2 Dual Power Underside CT2U1 Dual Power Center Top with Underside (See chart on next page)	See Metal Finish Color Options

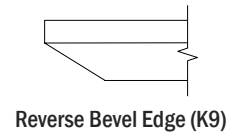
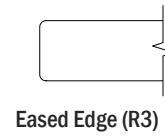
Model Number Breakdown

LKT4896-42TTT					
LK	T	4896	42	TT	T
LOK	Laminate	48" x 96"	Height	Rectangular Top Shape	T base

Description

Rectangular Table with T Base
at Bar Height
(continued)

Veneer Tables
"LKV" Models



D	W	H	CTN WT	CU FT	① Model	Eased Edge (R3)		Reverse Bevel Edge (K9)	
						Flat Cut	Double Cut	Flat Cut	Double Cut
48	96	42	239	132	LKV4896-42TTT	\$4,627	\$4,965	\$4,936	\$5,250
48	84	42	216	117	LKV4884-42TTT	\$4,353	\$4,645	\$4,641	\$4,910
42	96	42	190	118	LKV4296-42TTT	\$4,400	\$4,750	\$4,795	\$5,107
	84	42	215	105	LKV4284-42TTT	\$3,765	\$4,067	\$4,105	\$4,369
36	96	42	169	102	LKV3696-42TTT	\$3,383	\$3,654	\$3,685	\$3,927
36	84	42	151	90	LKV3684-42TTT	\$3,126	\$3,377	\$3,406	\$3,629

Electrical Options and Upcharges

CT2	84 - 96 wide
Dual Power Center Top - Black	CT2BL - add \$1,490
Dual Power Center Top - White	CT2WH - add \$1,490
CU1	
Dual Power Underside - Black	CU1-1C - add \$592
Dual Power Underside with Wireless Charging - Black	CU1-1CW - add \$1,371
CT2U1	
Dual Power Center Top - Black with Underside	CT2U1-BL - add \$1,813
Dual Power Center Top - White with Underside	CT2U1-WH - add \$1,813
Dual Power Center Top - Black with Wireless Charging	CT2U1-BLW2 - add \$2,592
Dual Power Center Top - White with Wireless Charging	CT2U1-WHW2 - add \$2,592

Note: Order power infeed that best fits application

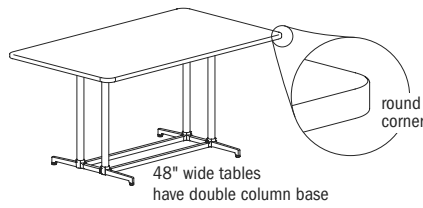
To Order Specify

① Veneer Model #	② Edge Detail	③ Wood Species	④ Wood Finish	⑤ Electrical	⑥ Metal Color
Veneer (LKV)	See Edge Detail Options	Flat Cut CH1 Cherry MA1 Maple WA1 Walnut BO1 Black Oak	See Flat Cut Wood Finish Options	N None CT2 Dual Power Center Top CU2 Dual Power Underside CT2U1 Dual Power Center Top with Underside (See chart above)	See Metal Finish Color Options
		Double Cut DC1 Double Cut	See Double Cut Wood Finish Options		

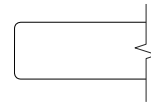
LOK - CONFERENCE

Description

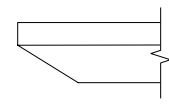
Rounded Rectangular Table with T Base at Bar Height



Laminate Tables "LKT" Models



Eased Edge (R3)



Reverse Bevel Edge (K9)

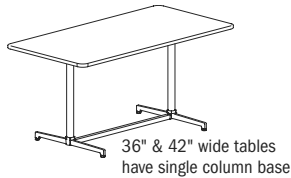
LAMINATE	D	W	H	CTN WT	CU FT	Model	Eased Edge (R3)			Reverse Bevel Edge (K9)		
							Standard	Graded In		Standard	Graded In	
							Tier 1	Tier 2	Tier 3	Tier 1	Tier 2	Tier 3
	48	96	42	239	132	LKT4896-42TTRT	\$3,399	\$3,451	\$3,769	\$3,871	\$3,925	\$4,152
	48	84	42	216	117	LKT4884-42TTRT	\$3,096	\$3,141	\$3,420	\$3,557	\$3,600	\$3,801
	42	96	42	190	118	LKT4296-42TTRT	\$3,017	\$3,062	\$3,341	\$3,478	\$3,523	\$3,721
	42	84	42	215	105	LKT4284-42TTRT	\$3,093	\$3,132	\$3,377	\$3,542	\$3,583	\$3,756
	36	96	42	169	102	LKT3696-42TTRT	\$2,564	\$2,603	\$2,843	\$3,012	\$3,051	\$3,221
	36	84	42	151	90	LKT3684-42TTRT	\$2,317	\$2,351	\$2,561	\$2,756	\$2,790	\$2,940

Features:

- price reflects complete table - top and base
- ships KD in multiple cartons
- one piece top
- model includes adjustable glide

Options:

- specify power/charging option, see below for options and upcharges



top shape

LOK - CONFERENCE

To Order Specify

1 Laminate Model #	2 Edge Detail	3 Laminate Selection	3a PVC Edge Color	4 Electrical	5 Metal Color
Laminate (LKT)	See Edge Detail Options	See Laminate Selection	See PVC Edge Color Options	N None CT2 Dual Power Center Top CU2 Dual Power Underside CT2U1 Dual Power Center Top with Underside (See chart on next page)	See Metal Finish Color Options

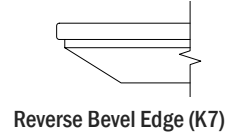
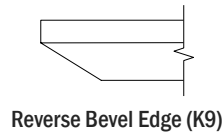
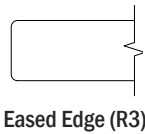
Model Number Breakdown

LKT4896-42TTRT						
LK	T	4896	42	TT	R	T
LOK	Laminate	48" x 96"	Height	Rectangular Top Shape	Rounded Corner	T Base

Description

Rounded Rectangular Table with T Base at Bar Height (continued)

Veneer Tables "LKV" Models	Solid Surface Tables "LKS" Models
----------------------------	-----------------------------------



	D	W	H	CTN WT	CU FT	① Model	Veneer Tables "LKV" Models		Solid Surface Tables "LKS" Models		
							Flat Cut	Double Cut	Flat Cut	Double Cut	Standard
VENEER	48	96	42	239	132	LKV4896-42TTRT	\$4,707	\$5,045	\$5,014	\$5,329	--
	48	84	42	216	117	LKV4884-42TTRT	\$4,375	\$4,666	\$4,663	\$4,935	--
	42	96	42	190	118	LKV4296-42TTRT	\$4,472	\$4,828	\$4,873	\$5,189	--
	42	84	42	215	105	LKV4284-42TTRT	\$4,493	\$4,852	\$4,898	\$5,216	--
	36	96	42	169	102	LKV3696-42TTRT	\$3,447	\$3,721	\$3,756	\$4,000	--
	36	84	42	151	90	LKV3684-42TTRT	\$3,186	\$3,440	\$3,471	\$3,699	--
SOLID SURFACE	48	96	42	239	132	LKS4896-42TTRT	--	--	--	--	\$10,586
	48	84	42	216	117	LKS4884-42TTRT	--	--	--	--	\$9,478
	42	96	42	190	118	LKS4296-42TTRT	--	--	--	--	\$8,550
	42	84	42	215	105	LKS4284-42TTRT	--	--	--	--	\$8,265
	36	96	42	169	102	LKS3696-42TTRT	--	--	--	--	\$7,535
	36	84	42	151	90	LKS3684-42TTRT	--	--	--	--	\$6,809

Electrical Options and Upcharges

CT2	84 - 96 wide
Dual Power Center Top - Black	CT2BL - add \$1,490
Dual Power Center Top - White	CT2WH - add \$1,490
CU1	
Dual Power Underside - Black	CU1-1C - add \$592
Dual Power Underside with Wireless Charging - Black	CU1-1CW - add \$1,371
CT2U1	
Dual Power Center Top - Black with Underside	CT2U1-BL - add \$1,813
Dual Power Center Top - White with Underside	CT2U1-WH - add \$1,813
Dual Power Center Top - Black with Wireless Charging	CT2U1-BLW2 - add \$2,592
Dual Power Center Top - White with Wireless Charging	CT2U1-WHW2 - add \$2,592

Note: Order power infed that best fits application

To Order Specify

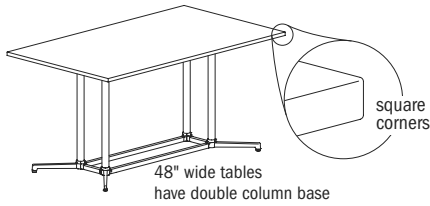
① Veneer Model #	② Edge Detail	③ Wood Species	④ Wood Finish	⑤ Electrical	⑥ Metal Color
Veneer (LKV)	See Edge Detail Options	Flat Cut CH1 Cherry MA1 Maple WA1 Walnut BO1 Black Oak	See Flat Cut Wood Finish Options	N None CT2 Dual Power Center Top CU2 Dual Power Underside CT2U1 Dual Power Center Top with Underside (See chart above)	See Metal Finish Color Options
		Double Cut DC1 Double Cut	④ Wood Finish See Double Cut Wood Finish Options		

① Solid Surface Model #	② Top Surface Selection	③ Electrical	④ Metal Color
Solid Surface (LKS)	See Solid Surface Top Surface Selection Options	N None CT2 Dual Power Center Top CU2 Dual Power Underside CT2U1 Dual Power Center Top with Underside (See chart above)	See Metal Finish Color Options

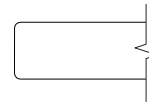
LOK - CONFERENCE

Description

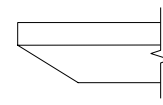
Rectangular Table with Y Base at Bar Height



Laminate Tables "LKT" Models



Eased Edge (R3)



Reverse Bevel Edge (K9)

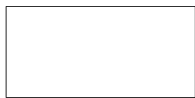
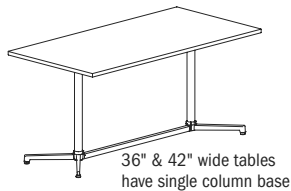
LAMINATE	D	W	H	CTN WT	CU FT	Model	Eased Edge (R3)			Reverse Bevel Edge (K9)		
							Standard	Graded In		Standard	Graded In	
							Tier 1	Tier 2	Tier 3	Tier 1	Tier 2	Tier 3
	48	96	42	229	132	LKT4896-42TTY	\$3,255	\$3,307	\$3,627	\$3,727	\$3,781	\$4,005
	48	84	42	215	117	LKT4884-42TTY	\$2,875	\$2,918	\$3,197	\$3,333	\$3,380	\$3,578
	42	96	42	200	118	LKT4296-42TTY	\$3,698	\$3,742	\$4,022	\$4,157	\$4,203	\$4,402
	42	84	42	160	103	LKT4284-42TTY	\$2,569	\$2,610	\$2,854	\$3,021	\$3,060	\$3,234
	36	96	42	180	102	LKT3696-42TTY	\$2,581	\$2,622	\$2,861	\$3,029	\$3,069	\$3,239
	36	84	42	162	90	LKT3684-42TTY	\$2,300	\$2,332	\$2,541	\$2,738	\$2,773	\$2,922

Features:

- price reflects complete table - top and base
- ships KD in multiple cartons
- one piece top
- model includes adjustable glide

Options:

- specify power/charging option, see below for options and upcharges



top shape

LOK - CONFERENCE

To Order Specify

1 Laminate Model #	2 Edge Detail	3 Laminate Selection	3a PVC Edge Color	4 Electrical	5 Metal Color
Laminate (LKT)	See Edge Detail Options	See Laminate Selection	See PVC Edge Color Options	N None CT2 Dual Power Center Top CU2 Dual Power Underside CT2U1 Dual Power Center Top with Underside (See chart on next page)	See Metal Finish Color Options

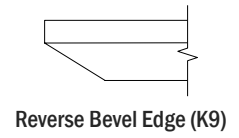
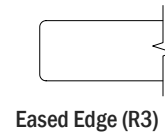
Model Number Breakdown

LKT4896-42TTY					
LK	T	4896	42	TT	Y
LOK	Laminate	48" x 96"	Height	Rectangular Top Shape	Y Base

Description

Rectangular Table with
Y Base at Bar Height
(continued)

Veneer Tables
"LKV" Models



VENEER	D	W	H	CTN WT	CU FT	① Model	Flat Cut	Double Cut	Flat Cut	Double Cut
		48	96	42	229	132	LKV4896-42TTY	\$4,523	\$4,858	\$4,832
	48	84	42	215	117	LKV4884-42TTY	\$4,096	\$4,387	\$4,382	\$4,654
	42	96	42	200	118	LKV4296-42TTY	\$5,321	\$5,748	\$5,800	\$6,178
	42	84	42	160	103	LKV4284-42TTY	\$3,853	\$4,163	\$4,200	\$4,473
	36	96	42	180	102	LKV3696-42TTY	\$3,468	\$3,747	\$3,782	\$4,027
	36	84	42	162	90	LKV3684-42TTY	\$3,164	\$3,418	\$3,449	\$3,673

Electrical Options and Upcharges

CT2	84 - 96 wide
Dual Power Center Top - Black	CT2BL - add \$1,490
Dual Power Center Top - White	CT2WH - add \$1,490
CU1	
Dual Power Underside - Black	CU1-1C - add \$592
Dual Power Underside with Wireless Charging - Black	CU1-1CW - add \$1,371
CT2U1	
Dual Power Center Top - Black with Underside	CT2U1-BL - add \$1,813
Dual Power Center Top - White with Underside	CT2U1-WH - add \$1,813
Dual Power Center Top - Black with Wireless Charging	CT2U1-BLW2 - add \$2,592
Dual Power Center Top - White with Wireless Charging	CT2U1-WHW2 - add \$2,592

Note: Order power infeed that best fits application

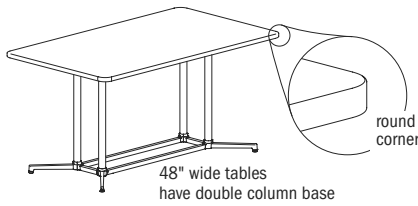
To Order Specify

① Veneer Model #	② Edge Detail	③ Wood Species	④ Wood Finish	⑤ Electrical	⑥ Metal Color
Veneer (LKV)	See Edge Detail Options	Flat Cut CH1 Cherry MA1 Maple WA1 Walnut BO1 Black Oak	See Flat Cut Wood Finish Options	N None CT2 Dual Power Center Top CU2 Dual Power Underside CT2U1 Dual Power Center Top with Underside (See chart above)	See Metal Finish Color Options
		Double Cut DC1 Double Cut	④ Wood Finish See Double Cut Wood Finish Options		

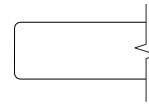
LOK - CONFERENCE

Description

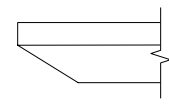
Rounded Rectangular Table with Y Base at Bar Height



Laminate Tables "LKT" Models



Eased Edge (R3)



Reverse Bevel Edge (K9)

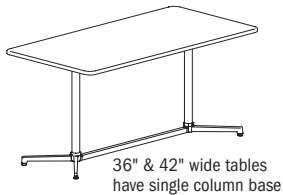
LAMINATE	D	W	H	CTN WT	CU FT	Model	Standard			Graded In		
							Tier 1	Tier 2	Tier 3	Tier 1	Tier 2	Tier 3
	48	96	42	229	132	LKT4896-42TTRY	\$3,318	\$3,369	\$3,686	\$3,790	\$3,842	\$4,069
	48	84	42	215	117	LKT4884-42TTRY	\$2,929	\$2,975	\$3,253	\$3,392	\$3,436	\$3,635
	42	96	42	200	118	LKT4296-42TTRY	\$3,755	\$3,799	\$4,079	\$4,214	\$4,260	\$4,460
	42	84	42	160	103	LKT4284-42TTRY	\$2,624	\$2,663	\$2,908	\$3,074	\$3,113	\$3,288
	36	96	42	180	102	LKT3696-42TTRY	\$2,636	\$2,675	\$2,914	\$3,083	\$3,123	\$3,293
	36	84	42	162	90	LKT3684-42TTRY	\$2,347	\$2,382	\$2,591	\$2,786	\$2,821	\$2,971

Features:

- price reflects complete table - top and base
- ships KD in multiple cartons
- one piece top
- model includes adjustable glide

Options:

- specify power/charging option, see below for options and upcharges



top shape

LOK - CONFERENCE

To Order Specify

1 Laminate Model #	2 Edge Detail	3 Laminate Selection	3a PVC Edge Color	4 Electrical	5 Metal Color
Laminate (LKT)	See Edge Detail Options	See Laminate Selection	See PVC Edge Color Options	N None CT2 Dual Power Center Top CU2 Dual Power Underside CT2U1 Dual Power Center Top with Underside (See chart on next page)	See Metal Finish Color Options

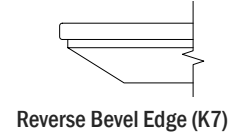
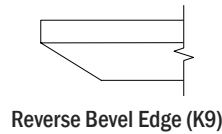
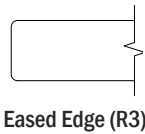
Model Number Breakdown

LKT4896-42TTRY						
LK	T	4896	42	TT	R	Y
LOK	Laminate	48" x 96"	Height	Rectangular Top Shape	Rounded Corner	Y Base

Description

Rounded Rectangular Table with Y Base at Bar Height (continued)

Veneer Tables "LKV" Models Solid Surface Tables "LKS" Models



	D	W	H	CTN WT	CU FT	① Model	Veneer Tables "LKV" Models		Solid Surface Tables "LKS" Models		
							Flat Cut	Double Cut	Flat Cut	Double Cut	Standard
VENEER	48	96	42	229	132	LKV4896-42TTRY	\$4,602	\$4,938	\$4,910	\$5,224	--
	48	84	42	215	117	LKV4884-42TTRY	\$4,168	\$4,460	\$4,455	\$4,727	--
	42	96	42	200	118	LKV4296-42TTRY	\$5,393	\$5,825	\$5,879	\$6,261	--
	42	84	42	160	103	LKV4284-42TTRY	\$3,920	\$4,233	\$4,273	\$4,549	--
	36	96	42	180	102	LKV3696-42TTRY	\$3,534	\$3,818	\$3,852	\$4,103	--
	36	84	42	162	90	LKV3684-42TTRY	\$3,224	\$3,483	\$3,513	\$3,743	--
SOLID SURFACE	48	96	42	229	132	LKS4896-42TTRY	--	--	--	--	\$10,482
	48	84	42	215	117	LKS4884-42TTRY	--	--	--	--	\$9,270
	42	96	36	197	102	LKS4296-42TTRY	--	--	--	--	\$9,471
	42	84	42	160	103	LKS4284-42TTRY	--	--	--	--	\$7,689
	36	96	42	180	102	LKS3696-42TTRY	--	--	--	--	\$7,621
	36	84	42	162	90	LKS3684-42TTRY	--	--	--	--	\$6,850

Electrical Options and Upcharges

CT2	84 - 96 wide
Dual Power Center Top - Black	CT2BL - add \$1,490
Dual Power Center Top - White	CT2WH - add \$1,490
CU1	
Dual Power Underside - Black	CU1-1C - add \$592
Dual Power Underside with Wireless Charging - Black	CU1-1CW - add \$1,371
CT2U1	
Dual Power Center Top - Black with Underside	CT2U1-BL - add \$1,813
Dual Power Center Top - White with Underside	CT2U1-WH - add \$1,813
Dual Power Center Top - Black with Wireless Charging	CT2U1-BLW2 - add \$2,592
Dual Power Center Top - White with Wireless Charging	CT2U1-WHW2 - add \$2,592

Note: Order power infed that best fits application

To Order Specify

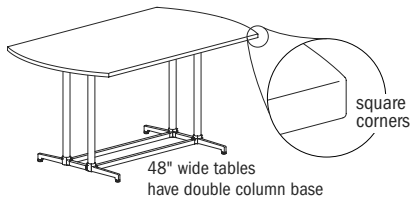
① Veneer Model #	② Edge Detail	③ Wood Species	④ Wood Finish	⑤ Electrical	⑥ Metal Color
Veneer (LKV)	See Edge Detail Options	Flat Cut CH1 Cherry MA1 Maple WA1 Walnut BO1 Black Oak	See Flat Cut Wood Finish Options	N None CT2 Dual Power Center Top CU2 Dual Power Underside CT2U1 Dual Power Center Top with Underside (See chart above)	See Metal Finish Color Options
		Double Cut DC1 Double Cut	See Double Cut Wood Finish Options		

① Solid Surface Model #	② Top Surface Selection	③ Electrical	④ Metal Color
Solid Surface (LKS)	See Solid Surface Top Surface Selection Options	N None CT2 Dual Power Center Top CU2 Dual Power Underside CT2U1 Dual Power Center Top with Underside (See chart above)	See Metal Finish Color Options

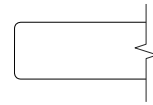
LOK - CONFERENCE

Description

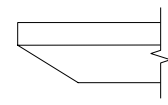
Arc Rectangular Table with T Base at Bar Height



Laminate Tables "LKT" Models



Eased Edge (R3)



Reverse Bevel Edge (K9)

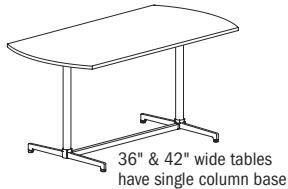
LAMINATE	D	W	H	CTN WT	CU FT	Model	Standard			Graded In		
							Tier 1	Tier 2	Tier 3	Tier 1	Tier 2	Tier 3
							48	96	42	232	132	LKT4896-42ART
48	84	42	208	117	LKT4884-42ART	\$3,096	\$3,141	\$3,420	\$3,557	\$3,600	\$3,801	
42	96	42	186	118	LKT4296-42ART	\$3,017	\$3,062	\$3,341	\$3,478	\$3,523	\$3,721	
42	84	42	207	90	LKT4284-42ART	\$3,093	\$3,132	\$3,377	\$3,542	\$3,583	\$3,756	
36	96	42	166	102	LKT3696-42ART	\$2,564	\$2,603	\$2,843	\$3,012	\$3,051	\$3,221	
36	84	42	147	90	LKT3684-42ART	\$2,317	\$2,351	\$2,561	\$2,756	\$2,790	\$2,940	

Features:

- price reflects complete table - top and base
- ships KD in multiple cartons
- one piece top
- model includes adjustable glide

Options:

- specify power/charging option, see below for options and upcharges



top shape

LOK - CONFERENCE

To Order Specify

1 Laminite Model #	2 Edge Detail	3 Laminite Selection	3a PVC Edge Color	4 Electrical	5 Metal Color
Laminite (LKT)	See Edge Detail Options	See Laminite Selection	See PVC Edge Color Options	N None CT2 Dual Power Center Top CU2 Dual Power Underside CT2U1 Dual Power Center Top with Underside (See chart on next page)	See Metal Finish Color Options

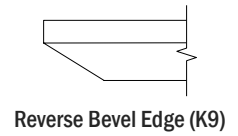
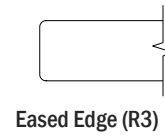
Model Number Breakdown

LKT4896-42ART					
LK	T	4896	42	AR	T
LOK	Laminite	48" x 96"	Height	Arc Rectangular Top Shape	T Base

Description

Arc Rectangular Table with T Base at Bar Height (continued)

Veneer Tables "LKV" Models



D	W	H	CTN WT	CU FT	① Model	Eased Edge (R3)		Reverse Bevel Edge (K9)	
						Flat Cut	Double Cut	Flat Cut	Double Cut
48	96	42	232	132	LKV4896-42ART	\$4,707	\$5,045	\$5,014	\$5,329
48	84	42	208	117	LKV4884-42ART	\$4,375	\$4,666	\$4,663	\$4,935
42	96	42	186	118	LKV4296-42ART	\$4,472	\$4,828	\$4,873	\$5,189
	84	42	207	90	LKV4284-42ART	\$4,493	\$4,852	\$4,898	\$5,216
36	96	42	166	102	LKV3696-42ART	\$3,447	\$3,721	\$3,756	\$4,000
36	84	42	147	90	LKV3684-42ART	\$3,186	\$3,440	\$3,471	\$3,699

Electrical Options and Upcharges

CT2	84 - 96 wide
Dual Power Center Top - Black	CT2BL - add \$1,490
Dual Power Center Top - White	CT2WH - add \$1,490
CU1	
Dual Power Underside - Black	CU1-1C - add \$592
Dual Power Underside with Wireless Charging - Black	CU1-1CW - add \$1,371
CT2U1	
Dual Power Center Top - Black with Underside	CT2U1-BL - add \$1,813
Dual Power Center Top - White with Underside	CT2U1-WH - add \$1,813
Dual Power Center Top - Black with Wireless Charging	CT2U1-BLW2 - add \$2,592
Dual Power Center Top - White with Wireless Charging	CT2U1-WHW2 - add \$2,592

Note: Order power infeed that best fits application

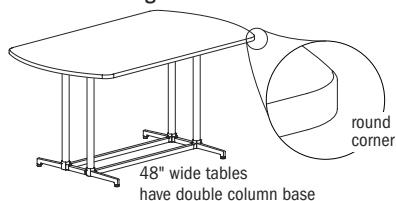
To Order Specify

① Veneer Model #	② Edge Detail	③ Wood Species	④ Wood Finish	⑤ Electrical	⑥ Metal Color
Veneer (LKV)	See Edge Detail Options	Flat Cut CH1 Cherry MA1 Maple WA1 Walnut BO1 Black Oak	See Flat Cut Wood Finish Options	N None CT2 Dual Power Center Top CU2 Dual Power Underside CT2U1 Dual Power Center Top with Underside (See chart above)	See Metal Finish Color Options
		Double Cut DC1 Double Cut	④ Wood Finish See Double Cut Wood Finish Options		

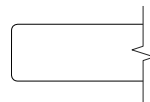
LOK - CONFERENCE

Description

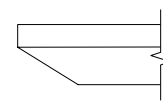
Rounded Arc Rectangular Table with T Base at Bar Height



Laminate Tables "LKT" Models



Eased Edge (R3)



Reverse Bevel Edge (K9)

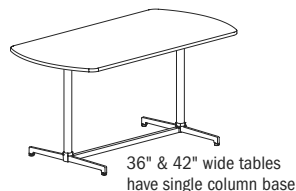
LAMINATE	D	W	H	CTN WT	CU FT	Model	Eased Edge (R3)			Reverse Bevel Edge (K9)		
							Standard	Graded In		Standard	Graded In	
							Tier 1	Tier 2	Tier 3	Tier 1	Tier 2	Tier 3
	48	96	42	232	132	LKT4896-42ARRT	\$3,399	\$3,451	\$3,769	\$3,871	\$3,925	\$4,152
	48	84	42	208	117	LKT4884-42ARRT	\$3,096	\$3,141	\$3,420	\$3,557	\$3,600	\$3,801
	42	96	42	186	118	LKT4296-42ARRT	\$3,017	\$3,062	\$3,341	\$3,478	\$3,523	\$3,721
	42	84	42	207	90	LKT4284-42ARRT	\$3,093	\$3,132	\$3,377	\$3,542	\$3,583	\$3,756
	36	96	42	166	102	LKT3696-42ARRT	\$2,564	\$2,603	\$2,843	\$3,012	\$3,051	\$3,221
	36	84	42	147	90	LKT3684-42ARRT	\$2,317	\$2,351	\$2,561	\$2,756	\$2,790	\$2,940

Features:

- price reflects complete table - top and base
- ships KD in multiple cartons
- one piece top
- model includes adjustable glide

Options:

- specify power/charging option, see below for options and upcharges



top shape

LOK - CONFERENCE

To Order Specify

1 Laminate Model #	2 Edge Detail	3 Laminate Selection	3a PVC Edge Color	4 Electrical	5 Metal Color
Laminate (LKT)	See Edge Detail Options	See Laminate Selection	See PVC Edge Color Options	N None CT2 Dual Power Center Top CU2 Dual Power Underside CT2U1 Dual Power Center Top with Underside (See chart on next page)	See Metal Finish Color Options

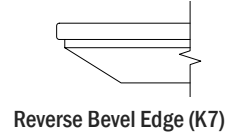
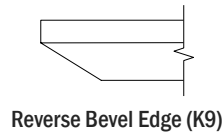
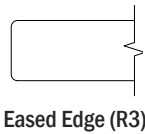
Model Number Breakdown

LKT4896-42ARRT						
LK	T	4896	42	AR	R	T
LOK	Laminate	48" x 96"	Height	Arc Rectangular Top Shape	Rounded Corner	T Base

Description

Rounded Arc Rectangular Table with T Base at Bar Height (continued)

Veneer Tables "LKV" Models Solid Surface Tables "LKS" Models



	D	W	H	CTN WT	CU FT	① Model	Veneer Tables "LKV" Models		Solid Surface Tables "LKS" Models		
							Flat Cut	Double Cut	Flat Cut	Double Cut	Standard
VENEER	48	96	42	232	132	LKV4896-42ARRT	\$4,707	\$5,045	\$5,014	\$5,329	--
	48	84	42	208	117	LKV4884-42ARRT	\$4,375	\$4,666	\$4,663	\$4,935	--
	42	96	42	186	118	LKV4296-42ARRT	\$4,472	\$4,828	\$4,873	\$5,189	--
	42	84	42	207	90	LKV4284-42ARRT	\$4,493	\$4,852	\$4,898	\$5,216	--
	36	96	42	166	102	LKV3696-42ARRT	\$3,447	\$3,721	\$3,756	\$4,000	--
	36	84	42	147	90	LKV3684-42ARRT	\$3,186	\$3,440	\$3,471	\$3,699	--
SOLID SURFACE	48	96	42	232	132	LKS4896-42ARRT	--	--	--	--	\$10,586
	48	84	42	208	117	LKS4884-42ARRT	--	--	--	--	\$9,478
	42	96	42	186	118	LKS4296-42ARRT	--	--	--	--	\$8,550
	42	84	42	207	90	LKS4284-42ARRT	--	--	--	--	\$8,265
	36	96	42	166	102	LKS3696-42ARRT	--	--	--	--	\$7,535
	36	84	42	147	90	LKS3684-42ARRT	--	--	--	--	\$6,809

Electrical Options and Upcharges

CT2	84 - 96 wide
Dual Power Center Top - Black	CT2BL - add \$1,490
Dual Power Center Top - White	CT2WH - add \$1,490
CU1	
Dual Power Underside - Black	CU1-1C - add \$592
Dual Power Underside with Wireless Charging - Black	CU1-1CW - add \$1,371
CT2U1	
Dual Power Center Top - Black with Underside	CT2U1-BL - add \$1,813
Dual Power Center Top - White with Underside	CT2U1-WH - add \$1,813
Dual Power Center Top - Black with Wireless Charging	CT2U1-BLW2 - add \$2,592
Dual Power Center Top - White with Wireless Charging	CT2U1-WHW2 - add \$2,592

Note: Order power infed that best fits application

To Order Specify

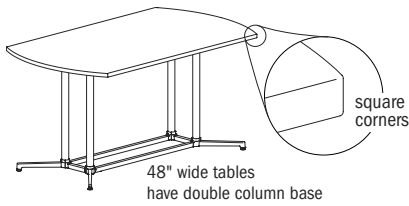
① Veneer Model #	② Edge Detail	③ Wood Species	④ Wood Finish	⑤ Electrical	⑥ Metal Color
Veneer (LKV)	See Edge Detail Options	Flat Cut CH1 Cherry MA1 Maple WA1 Walnut BO1 Black Oak	See Flat Cut Wood Finish Options	N None CT2 Dual Power Center Top CU2 Dual Power Underside CT2U1 Dual Power Center Top with Underside (See chart above)	See Metal Finish Color Options
		Double Cut DC1 Double Cut	See Double Cut Wood Finish Options		

① Solid Surface Model #	② Top Surface Selection	③ Electrical	④ Metal Color
Solid Surface (LKS)	See Solid Surface Top Surface Selection Options	N None CT2 Dual Power Center Top CU2 Dual Power Underside CT2U1 Dual Power Center Top with Underside (See chart above)	See Metal Finish Color Options

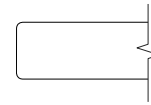
LOK - CONFERENCE

Description

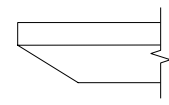
Arc Rectangular Table with Y Base at Bar Height



Laminate Tables "LKT" Models



Eased Edge (R3)



Reverse Bevel Edge (K9)

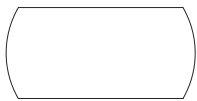
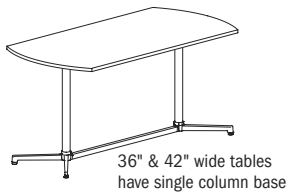
LAMINATE	D	W	H	CTN WT	CU FT	Model	Eased Edge (R3)		Reverse Bevel Edge (K9)			
							Standard	Graded In	Standard	Graded In		
							Tier 1	Tier 2	Tier 3	Tier 1	Tier 2	Tier 3
	48	96	42	231	132	LKT4896-42ARY	\$3,318	\$3,369	\$3,686	\$3,790	\$3,842	\$4,069
	48	84	42	207	117	LKT4884-42ARY	\$2,929	\$2,975	\$3,253	\$3,392	\$3,436	\$3,635
	42	96	42	196	118	LKT4296-42ARY	\$3,755	\$3,799	\$4,079	\$4,214	\$4,260	\$4,460
	42	84	42	160	103	LKT4284-42ARY	\$2,624	\$2,663	\$2,908	\$3,074	\$3,113	\$3,288
	36	96	42	167	102	LKT3696-42ARY	\$2,636	\$2,675	\$2,914	\$3,083	\$3,123	\$3,293
	36	84	42	153	90	LKT3684-42ARY	\$2,347	\$2,382	\$2,591	\$2,786	\$2,821	\$2,971

Features:

- price reflects complete table - top and base
- ships KD in multiple cartons
- one piece top
- model includes adjustable glide

Options:

- specify power/charging option, see below for options and upcharges



top shape

LOK - CONFERENCE

To Order Specify

1 Laminate Model #	2 Edge Detail	3 Laminate Selection	3a PVC Edge Color	4 Electrical	5 Metal Color
Laminate (LKT)	See Edge Detail Options	See Laminate Selection	See PVC Edge Color Options	N None CT2 Dual Power Center Top CU2 Dual Power Underside CT2U1 Dual Power Center Top with Underside (See chart on next page)	See Metal Finish Color Options

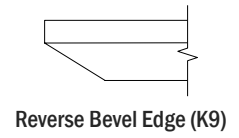
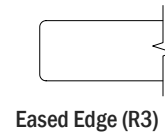
Model Number Breakdown

LKT4896-42ARY					
LK	T	4896	42	AR	Y
LOK	Laminate	48" x 96"	Height	Acr Rectangular Top Shape	Y Base

Description

Arc Rectangular Table with Y Base at Bar Height (continued)

Veneer Tables "LKV" Models



D	W	H	CTN WT	CU FT	① Model	Eased Edge (R3)		Reverse Bevel Edge (K9)	
						Flat Cut	Double Cut	Flat Cut	Double Cut
48	96	42	231	132	LKV4896-42ARY	\$4,602	\$4,938	\$4,910	\$5,224
48	84	42	207	117	LKV4884-42ARY	\$4,168	\$4,460	\$4,455	\$4,727
42	96	42	196	118	LKV4296-42ARY	\$5,393	\$5,825	\$5,879	\$6,261
	84	42	160	103	LKV4284-42ARY	\$3,920	\$4,233	\$4,273	\$4,549
36	96	42	167	102	LKV3696-42ARY	\$3,534	\$3,818	\$3,852	\$4,103
36	84	42	153	90	LKV3684-42ARY	\$3,224	\$3,483	\$3,513	\$3,743

Electrical Options and Upcharges

CT2	84 - 96 wide
Dual Power Center Top - Black	CT2BL - add \$1,490
Dual Power Center Top - White	CT2WH - add \$1,490
CU1	
Dual Power Underside - Black	CU1-1C - add \$592
Dual Power Underside with Wireless Charging - Black	CU1-1CW - add \$1,371
CT2U1	
Dual Power Center Top - Black with Underside	CT2U1-BL - add \$1,813
Dual Power Center Top - White with Underside	CT2U1-WH - add \$1,813
Dual Power Center Top - Black with Wireless Charging	CT2U1-BLW2 - add \$2,592
Dual Power Center Top - White with Wireless Charging	CT2U1-WHW2 - add \$2,592

Note: Order power infeed that best fits application

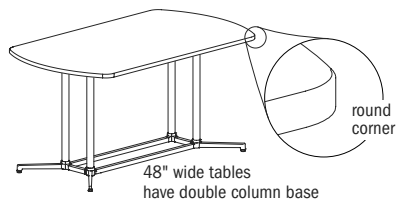
To Order Specify

① Veneer Model #	② Edge Detail	③ Wood Species	④ Wood Finish	⑤ Electrical	⑥ Metal Color
Veneer (LKV)	See Edge Detail Options	Flat Cut CH1 Cherry MA1 Maple WA1 Walnut BO1 Black Oak	See Flat Cut Wood Finish Options	N None CT2 Dual Power Center Top CU2 Dual Power Underside CT2U1 Dual Power Center Top with Underside (See chart above)	See Metal Finish Color Options
		Double Cut DC1 Double Cut	④ Wood Finish See Double Cut Wood Finish Options		

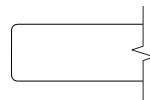
LOK - CONFERENCE

Description

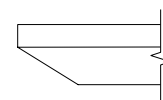
Rounded Arc Rectangular Table with Y Base at Bar Height



Laminate Tables "LKT" Models



Eased Edge (R3)



Reverse Bevel Edge (K9)

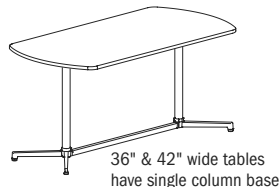
LAMINATE	D	W	H	CTN WT	CU FT	Model	Eased Edge (R3)			Reverse Bevel Edge (K9)		
							Standard	Graded In		Standard	Graded In	
							Tier 1	Tier 2	Tier 3	Tier 1	Tier 2	Tier 3
	48	96	42	231	132	LKT4896-42ARRY	\$3,318	\$3,369	\$3,686	\$3,790	\$3,842	\$4,069
	48	84	42	175	117	LKT4884-42ARRY	\$2,929	\$2,975	\$3,253	\$3,392	\$3,436	\$3,635
	42	96	42	196	118	LKT4296-42ARRY	\$3,755	\$3,799	\$4,079	\$4,214	\$4,260	\$4,460
	42	84	42	180	103	LKT4284-42ARRY	\$2,624	\$2,663	\$2,908	\$3,074	\$3,113	\$3,288
	36	96	42	167	102	LKT3696-42ARRY	\$2,636	\$2,675	\$2,914	\$3,083	\$3,123	\$3,293
	36	84	42	159	90	LKT3684-42ARRY	\$2,347	\$2,382	\$2,591	\$2,786	\$2,821	\$2,971

Features:

- price reflects complete table - top and base
- ships KD in multiple cartons
- one piece top
- model includes adjustable glide

Options:

- specify power/charging option, see below for options and upcharges



top shape

LOK - CONFERENCE

To Order Specify

1 Laminite Model #	2 Edge Detail	3 Laminite Selection	3a PVC Edge Color	4 Electrical	5 Metal Color
Laminite (LKT)	See Edge Detail Options	See Laminite Selection	See PVC Edge Color Options	N None CT2 Dual Power Center Top CU2 Dual Power Underside CT2U1 Dual Power Center Top with Underside (See chart on next page)	See Metal Finish Color Options

Model Number Breakdown

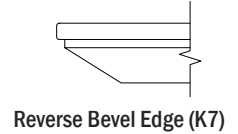
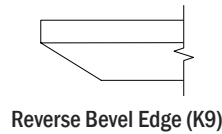
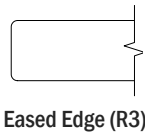
LKT4896-42ARRY						
LK	T	4896	42	AR	R	Y
LOK	Laminite	48" x 96"	Height	Arc Rectangular Top Shape	Rounded Corner	Y Base

Description

Rounded Arc Rectangular Table with Y Base at Bar Height (continued)

Veneer Tables "LKV" Models

Solid Surface Tables "LKS" Models



	D	W	H	CTN WT	CU FT	① Model	Veneer Tables "LKV" Models		Solid Surface Tables "LKS" Models		
							Flat Cut	Double Cut	Flat Cut	Double Cut	Standard
VENEER	48	96	42	231	132	LKV4896-42ARRY	\$4,602	\$4,938	\$4,910	\$5,224	--
	48	84	42	175	117	LKV4884-42ARRY	\$4,168	\$4,460	\$4,455	\$4,727	--
	42	96	42	196	118	LKV4296-42ARRY	\$5,393	\$5,825	\$5,879	\$6,261	--
	42	84	42	180	103	LKV4284-42ARRY	\$3,920	\$4,233	\$4,273	\$4,549	--
	36	96	42	167	102	LKV3696-42ARRY	\$3,534	\$3,818	\$3,852	\$4,103	--
	36	84	42	159	90	LKV3684-42ARRY	\$3,224	\$3,483	\$3,513	\$3,743	--
SOLID SURFACE	48	96	42	231	132	LKS4896-42ARRY	--	--	--	--	\$10,482
	48	84	42	175	117	LKS4884-42ARRY	--	--	--	--	\$9,270
	42	96	42	196	118	LKS4296-42ARRY	--	--	--	--	\$9,471
	42	84	42	180	103	LKS4284-42ARRY	--	--	--	--	\$7,689
	36	96	42	167	102	LKS3696-42ARRY	--	--	--	--	\$7,621
	36	84	42	159	90	LKS3684-42ARRY	--	--	--	--	\$6,850

Electrical Options and Upcharges

CT2	84 - 96 wide
Dual Power Center Top - Black	CT2BL - add \$1,490
Dual Power Center Top - White	CT2WH - add \$1,490
CU1	
Dual Power Underside - Black	CU1-1C - add \$592
Dual Power Underside with Wireless Charging - Black	CU1-1CW - add \$1,371
CT2U1	
Dual Power Center Top - Black with Underside	CT2U1-BL - add \$1,813
Dual Power Center Top - White with Underside	CT2U1-WH - add \$1,813
Dual Power Center Top - Black with Wireless Charging	CT2U1-BLW2 - add \$2,592
Dual Power Center Top - White with Wireless Charging	CT2U1-WHW2 - add \$2,592

Note: Order power infeed that best fits application

To Order Specify

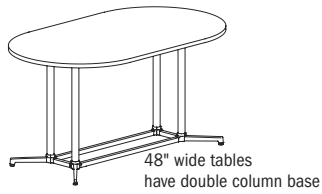
① Veneer Model #	② Edge Detail	③ Wood Species	④ Wood Finish	⑤ Electrical	⑥ Metal Color
Veneer (LKV)	See Edge Detail Options	Flat Cut CH1 Cherry MA1 Maple WA1 Walnut BO1 Black Oak	See Flat Cut Wood Finish Options	N None CT2 Dual Power Center Top CU2 Dual Power Underside CT2U1 Dual Power Center Top with Underside (See chart above)	See Metal Finish Color Options
		Double Cut DC1 Double Cut	See Double Cut Wood Finish Options		

① Solid Surface Model #	② Top Surface Selection	③ Electrical	④ Metal Color
Solid Surface (LKS)	See Solid Surface Top Surface Selection Options	N None CT2 Dual Power Center Top CU2 Dual Power Underside CT2U1 Dual Power Center Top with Underside (See chart above)	See Metal Finish Color Options

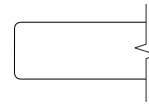
LOK - CONFERENCE

Description

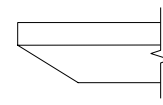
Racetrack Table with Y Base at Bar Height



Laminate Tables "LKT" Models



Eased Edge (R3)



Reverse Bevel Edge (K9)

LAMINATE	D	W	H	CTN WT	CU FT	Model	Eased Edge (R3)			Reverse Bevel Edge (K9)		
							Standard	Graded In		Standard	Graded In	
							Tier 1	Tier 2	Tier 3	Tier 1	Tier 2	Tier 3
	48	96	42	219	132	LKT4896-42RKY	\$3,318	\$3,369	\$3,686	\$3,790	\$3,842	\$4,069
	48	84	42	197	117	LKT4884-42RKY	\$2,929	\$2,975	\$3,253	\$3,392	\$3,436	\$3,635
	42	96	42	188	118	LKT4296-42RKY	\$3,755	\$3,799	\$4,079	\$4,214	\$4,260	\$4,460
	42	84	42	167	103	LKT4284-42RKY	\$2,624	\$2,663	\$2,908	\$3,074	\$3,113	\$3,288
	36	96	42	177	102	LKT3696-42RKY	\$2,636	\$2,675	\$2,914	\$3,083	\$3,123	\$3,293
	36	84	42	152	90	LKT3684-42RKY	\$2,347	\$2,382	\$2,591	\$2,786	\$2,821	\$2,971

Features:

- price reflects complete table - top and base
- ships KD in multiple cartons
- one piece top
- model includes adjustable glide

Options:

- specify power/charging option, see below for options and upcharges



top shape

LOK - CONFERENCE

To Order Specify

1 Laminate Model #	2 Edge Detail	3 Laminate Selection	3a PVC Edge Color	4 Electrical	5 Metal Color
Laminate (LKT)	See Edge Detail Options	See Laminate Selection	See PVC Edge Color Options	N None CT2 Dual Power Center Top CU2 Dual Power Underside CT2U1 Dual Power Center Top with Underside (See chart on next page)	See Metal Finish Color Options

Model Number Breakdown

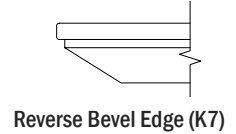
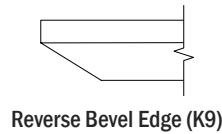
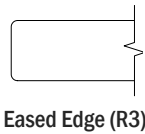
LKT4896-42RKY					
LK	T	4896	42	RK	Y
LOK	Laminate	48" x 96"	Height	Racetrack Top Shape	Y Base

Description

Racetrack Table with Y Base at Bar Height (continued)

Veneer Tables "LKV" Models

Solid Surface Tables "LKS" Models



	D	W	H	CTN WT	CU FT	① Model	Veneer Tables "LKV" Models		Solid Surface Tables "LKS" Models		
							Flat Cut	Double Cut	Flat Cut	Double Cut	Standard
VENEER	48	96	42	219	132	LKV4896-42RKY	\$4,602	\$4,938	\$4,910	\$5,224	--
	48	84	42	197	117	LKV4884-42RKY	\$4,168	\$4,460	\$4,455	\$4,727	--
	42	96	42	188	118	LKV4296-42RKY	\$5,393	\$5,825	\$5,879	\$6,261	--
	42	84	42	167	103	LKV4284-42RKY	\$3,920	\$4,233	\$4,273	\$4,549	--
	36	96	42	177	102	LKV3696-42RKY	\$3,534	\$3,818	\$3,852	\$4,103	--
	36	84	42	152	90	LKV3684-42RKY	\$3,224	\$3,483	\$3,513	\$3,743	--
SOLID SURFACE	48	96	42	219	132	LKS4896-42RKY	--	--	--	--	\$10,482
	48	84	42	197	117	LKS4884-42RKY	--	--	--	--	\$9,270
	42	96	42	188	118	LKS4296-42RKY	--	--	--	--	\$9,471
	42	84	42	167	103	LKS4284-42RKY	--	--	--	--	\$7,689
	36	96	42	177	102	LKS3696-42RKY	--	--	--	--	\$7,621
	36	84	42	152	90	LKS3684-42RKY	--	--	--	--	\$6,850

Electrical Options and Upcharges

CT2	84 - 96 wide
Dual Power Center Top - Black	CT2BL - add \$1,490
Dual Power Center Top - White	CT2WH - add \$1,490
CU1	
Dual Power Underside - Black	CU1-1C - add \$592
Dual Power Underside with Wireless Charging - Black	CU1-1CW - add \$1,371
CT2U1	
Dual Power Center Top - Black with Underside	CT2U1-BL - add \$1,813
Dual Power Center Top - White with Underside	CT2U1-WH - add \$1,813
Dual Power Center Top - Black with Wireless Charging	CT2U1-BLW2 - add \$2,592
Dual Power Center Top - White with Wireless Charging	CT2U1-WHW2 - add \$2,592

Note: Order power infed that best fits application

To Order Specify

① Veneer Model #	② Edge Detail	③ Wood Species	④ Wood Finish	⑤ Electrical	⑥ Metal Color
Veneer (LKV)	See Edge Detail Options	Flat Cut CH1 Cherry MA1 Maple WA1 Walnut BO1 Black Oak	See Flat Cut Wood Finish Options	N None CT2 Dual Power Center Top CU2 Dual Power Underside CT2U1 Dual Power Center Top with Underside (See chart above)	See Metal Finish Color Options
		Double Cut DC1 Double Cut	④ Wood Finish See Double Cut Wood Finish Options		

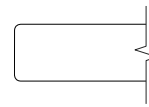
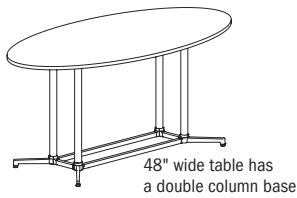
① Solid Surface Model #	② Top Surface Selection	③ Electrical	④ Metal Color
Solid Surface (LKS)	See Solid Surface Top Surface Selection Options	N None CT2 Dual Power Center Top CU2 Dual Power Underside CT2U1 Dual Power Center Top with Underside (See chart above)	See Metal Finish Color Options

LOK - CONFERENCE

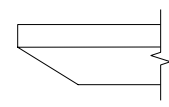
Description

Oval Table with Y Base at Bar Height

Laminate Tables
"LKT" Models



Eased Edge (R3)



Reverse Bevel Edge (K9)

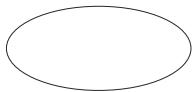
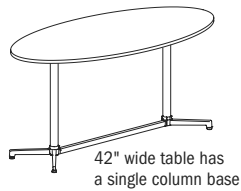
LAMINATE	D	W	H	CTN WT	CU FT	Model	Eased Edge (R3)			Reverse Bevel Edge (K9)		
							Standard	Graded In		Standard	Graded In	
							Tier 1	Tier 2	Tier 3	Tier 1	Tier 2	Tier 3
	48	96	42	198	132	LKT4896-420VY	\$3,078	\$3,128	\$3,448	\$3,549	\$3,600	\$3,829
	42	84	42	153	103	LKT4284-420VY	\$2,624	\$2,663	\$2,908	\$3,074	\$3,113	\$3,288

Features:

- price reflects complete table - top and base
- ships KD in multiple cartons
- one piece top
- model includes adjustable glide

Options:

- specify power/charging option, see below for options and upcharges



top shape

LOK - CONFERENCE

To Order Specify

1 Laminate Model #	2 Edge Detail	3 Laminate Selection	3a PVC Edge Color	4 Electrical	5 Metal Color
Laminate (LKT)	See Edge Detail Options	See Laminate Selection	See PVC Edge Color Options	N None CT2 Dual Power Center Top CU2 Dual Power Underside CT2U1 Dual Power Center Top with Underside (See chart on next page)	See Metal Finish Color Options

Model Number Breakdown

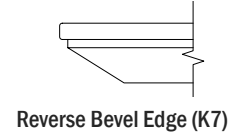
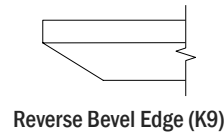
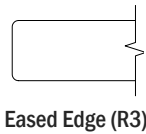
LKT4896-420VY					
LK	T	4896	42	OV	Y
LOK	Laminate	48" x 96"	Height	Oval Top Shape	Y Base

Description

Oval Table with Y Base at Bar Height
(continued)

Veneer Tables
"LKV" Models

Solid Surface Tables
"LKS" Models



	D	W	H	CTN WT	CU FT	① Model	Veneer Tables "LKV" Models		Solid Surface Tables "LKS" Models		
							Flat Cut	Double Cut	Flat Cut	Double Cut	Standard
VENEER	48	96	42	198	132	LKV4896-420VY	\$4,294	\$4,633	\$4,604	\$4,919	--
	42	84	42	153	103	LKV4284-420VY	\$3,920	\$4,233	\$4,273	\$4,549	--
SOL. SURF.	48	96	42	198	132	LKS4896-420VY	--	--	--	--	\$10,175
	42	84	42	153	103	LKS4284-420VY	--	--	--	--	\$7,689

Electrical Options and Upcharges

CT2	84 - 96 wide
Dual Power Center Top - Black	CT2BL - add \$1,490
Dual Power Center Top - White	CT2WH - add \$1,490
CU1	
Dual Power Underside - Black	CU1-1C - add \$592
Dual Power Underside with Wireless Charging - Black	CU1-1CW - add \$1,371
CT2U1	
Dual Power Center Top - Black with Underside	CT2U1-BL - add \$1,813
Dual Power Center Top - White with Underside	CT2U1-WH - add \$1,813
Dual Power Center Top - Black with Wireless Charging	CT2U1-BLW2 - add \$2,592
Dual Power Center Top - White with Wireless Charging	CT2U1-WHW2 - add \$2,592

Note: Order power infeed that best fits application

To Order Specify

① Veneer Model #	② Edge Detail	③ Wood Species	④ Wood Finish	⑤ Electrical	⑥ Metal Color
Veneer (LKV)	See Edge Detail Options	Flat Cut CH1 Cherry MA1 Maple WA1 Walnut BO1 Black Oak	See Flat Cut Wood Finish Options	N None CT2 Dual Power Center Top CU2 Dual Power Underside CT2U1 Dual Power Center Top with Underside (See chart above)	See Metal Finish Color Options
		Double Cut DC1 Double Cut	④ Wood Finish See Double Cut Wood Finish Options		

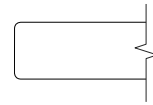
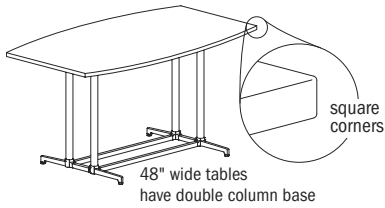
① Solid Surface Model #	② Top Surface Selection	③ Electrical	④ Metal Color
Solid Surface (LKS)	See Solid Surface Top Surface Selection Options	N None CT2 Dual Power Center Top CU2 Dual Power Underside CT2U1 Dual Power Center Top with Underside (See chart above)	See Metal Finish Color Options

LOK - CONFERENCE

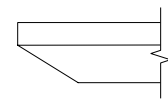
Description

Boat Table with T Base at Bar Height

Laminate Tables
"LKT" Models



Eased Edge (R3)



Reverse Bevel Edge (K9)

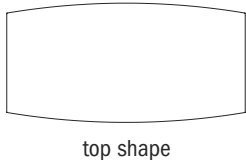
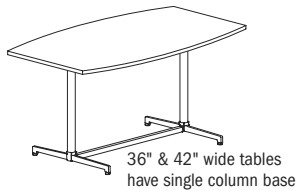
LAMINATE	D	W	H	CTN WT	CU FT	Model	Eased Edge (R3)			Reverse Bevel Edge (K9)		
							Standard	Graded In		Standard	Graded In	
							Tier 1	Tier 2	Tier 3	Tier 1	Tier 2	Tier 3
	48	96	42	216	132	LKT4896-42BTT	\$3,399	\$3,451	\$3,769	\$3,871	\$3,925	\$4,152
	48	84	42	210	117	LKT4884-42BTT	\$3,096	\$3,141	\$3,420	\$3,557	\$3,600	\$3,801
	42	96	42	183	118	LKT4296-42BTT	\$3,017	\$3,062	\$3,341	\$3,478	\$3,523	\$3,721
	42	84	42	209	105	LKT4284-42BTT	\$3,093	\$3,132	\$3,377	\$3,542	\$3,583	\$3,756
	36	96	42	162	102	LKT3696-42BTT	\$2,564	\$2,603	\$2,843	\$3,012	\$3,051	\$3,221
	36	84	42	146	90	LKT3684-42BTT	\$2,317	\$2,351	\$2,561	\$2,756	\$2,790	\$2,940

Features:

- price reflects complete table - top and base
- ships KD in multiple cartons
- one piece top
- model includes adjustable glide

Options:

- specify power/charging option, see below for options and upcharges



LOK - CONFERENCE

To Order Specify

1 Laminate Model #	2 Edge Detail	3 Laminate Selection	3a PVC Edge Color	4 Electrical	5 Metal Color
Laminate (LKT)	See Edge Detail Options	See Laminate Selection	See PVC Edge Color Options	N None CT2 Dual Power Center Top CU2 Dual Power Underside CT2U1 Dual Power Center Top with Underside (See chart on next page)	See Metal Finish Color Options

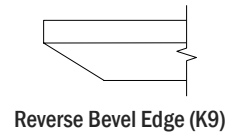
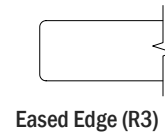
Model Number Breakdown

LKT4896-42BTT					
LK	T	4896	42	BT	T
LOK	Laminate	48" x 96"	Height	Boat Top Shape	T Base

Description

Boat Table with T Base at Bar Height
(continued)

Veneer Tables
"LKV" Models



D	W	H	CTN WT	CU FT	① Model	Eased Edge (R3)		Reverse Bevel Edge (K9)		
						Flat Cut	Double Cut	Flat Cut	Double Cut	
48	96	42	216	132	LKV4896-42BTT	\$4,707	\$5,045	\$5,014	\$5,329	
48	84	42	210	117	LKV4884-42BTT	\$4,375	\$4,666	\$4,663	\$4,935	
VENEER	42	96	42	183	118	LKV4296-42BTT	\$4,472	\$4,828	\$4,873	\$5,189
	42	84	42	209	105	LKV4284-42BTT	\$4,493	\$4,852	\$4,898	\$5,216
36	96	42	162	102	LKV3696-42BTT	\$3,447	\$3,721	\$3,756	\$4,000	
36	84	42	146	90	LKV3684-42BTT	\$3,186	\$3,440	\$3,471	\$3,699	

Electrical Options and Upcharges

CT2	84 - 96 wide
Dual Power Center Top - Black	CT2BL - add \$1,490
Dual Power Center Top - White	CT2WH - add \$1,490
CU1	
Dual Power Underside - Black	CU1-1C - add \$592
Dual Power Underside with Wireless Charging - Black	CU1-1CW - add \$1,371
CT2U1	
Dual Power Center Top - Black with Underside	CT2U1-BL - add \$1,813
Dual Power Center Top - White with Underside	CT2U1-WH - add \$1,813
Dual Power Center Top - Black with Wireless Charging	CT2U1-BLW2 - add \$2,592
Dual Power Center Top - White with Wireless Charging	CT2U1-WHW2 - add \$2,592

Note: Order power infeed that best fits application

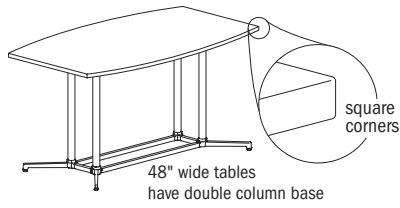
To Order Specify

① Veneer Model #	② Edge Detail	③ Wood Species	④ Wood Finish	⑤ Electrical	⑥ Metal Color
Veneer (LKV)	See Edge Detail Options	Flat Cut CH1 Cherry MA1 Maple WA1 Walnut BO1 Black Oak	See Flat Cut Wood Finish Options	N None CT2 Dual Power Center Top CU2 Dual Power Underside CT2U1 Dual Power Center Top with Underside (See chart above)	See Metal Finish Color Options
		Double Cut DC1 Double Cut	See Double Cut Wood Finish Options		

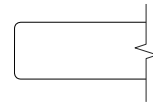
LOK - CONFERENCE

Description

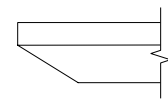
Boat Table with Y Base at Bar Height



Laminate Tables
"LKT" Models



Eased Edge (R3)



Reverse Bevel Edge (K9)

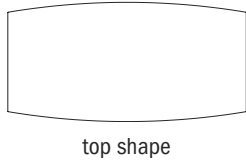
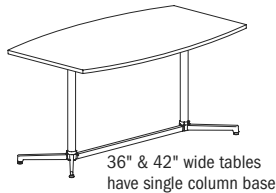
LAMINATE	D	W	H	CTN WT	CU FT	Model	Eased Edge (R3)			Reverse Bevel Edge (K9)		
							Standard	Graded In		Standard	Graded In	
							Tier 1	Tier 2	Tier 3	Tier 1	Tier 2	Tier 3
	48	96	42	231	132	LKT4896-42BTY	\$3,318	\$3,369	\$3,686	\$3,790	\$3,842	\$4,069
	48	84	42	209	117	LKT4884-42BTY	\$2,929	\$2,975	\$3,253	\$3,392	\$3,436	\$3,635
	42	96	42	198	118	LKT4296-42BTY	\$3,755	\$3,799	\$4,079	\$4,214	\$4,260	\$4,460
	42	84	42	175	103	LKT4284-42BTY	\$2,624	\$2,663	\$2,908	\$3,074	\$3,113	\$3,288
	36	96	42	175	102	LKT3696-42BTY	\$2,636	\$2,675	\$2,914	\$3,083	\$3,123	\$3,293
	36	84	42	156	90	LKT3684-42BTY	\$2,347	\$2,382	\$2,591	\$2,786	\$2,821	\$2,971

Features:

- price reflects complete table - top and base
- ships KD in multiple cartons
- one piece top
- model includes adjustable glide

Options:

- specify power/charging option, see below for options and upcharges



top shape

LOK - CONFERENCE

To Order Specify

1 Laminate Model #	2 Edge Detail	3 Laminate Selection	3a PVC Edge Color	4 Electrical	5 Metal Color
Laminate (LKT)	See Edge Detail Options	See Laminate Selection	See PVC Edge Color Options	N None CT2 Dual Power Center Top CU2 Dual Power Underside CT2U1 Dual Power Center Top with Underside (See chart on next page)	See Metal Finish Color Options

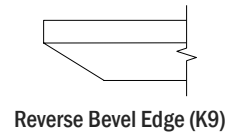
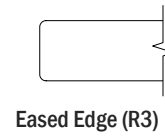
Model Number Breakdown

LKT4896-42BTY					
LK	T	4896	42	BT	Y
LOK	Laminate	48" x 96"	Height	Boat Top Shape	Y Base

Description

Boat Table with Y Base at Bar Height
(continued)

Veneer Tables
"LKV" Models



D	W	H	CTN WT	CU FT	① Model	Eased Edge (R3)		Reverse Bevel Edge (K9)	
						Flat Cut	Double Cut	Flat Cut	Double Cut
48	96	42	231	132	LKV4896-42BTY	\$4,602	\$4,938	\$4,910	\$5,224
48	84	42	209	117	LKV4884-42BTY	\$4,168	\$4,460	\$4,455	\$4,727
42	96	42	198	118	LKV4296-42BTY	\$5,393	\$5,825	\$5,879	\$6,261
	84	42	175	103	LKV4284-42BTY	\$3,920	\$4,233	\$4,273	\$4,549
36	96	42	175	102	LKV3696-42BTY	\$3,534	\$3,818	\$3,852	\$4,103
36	84	42	156	90	LKV3684-42BTY	\$3,224	\$3,483	\$3,513	\$3,743

Electrical Options and Upcharges

CT2	84 - 96 wide
Dual Power Center Top - Black	CT2BL - add \$1,490
Dual Power Center Top - White	CT2WH - add \$1,490
CU1	
Dual Power Underside - Black	CU1-1C - add \$592
Dual Power Underside with Wireless Charging - Black	CU1-1CW - add \$1,371
CT2U1	
Dual Power Center Top - Black with Underside	CT2U1-BL - add \$1,813
Dual Power Center Top - White with Underside	CT2U1-WH - add \$1,813
Dual Power Center Top - Black with Wireless Charging	CT2U1-BLW2 - add \$2,592
Dual Power Center Top - White with Wireless Charging	CT2U1-WHW2 - add \$2,592

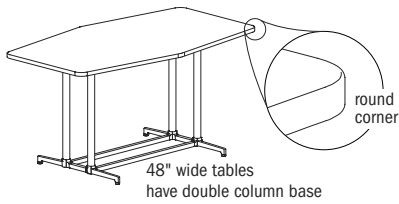
Note: Order power infeed that best fits application

To Order Specify

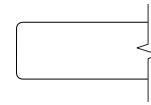
① Veneer Model #	② Edge Detail	③ Wood Species	④ Wood Finish	⑤ Electrical	⑥ Metal Color
Veneer (LKV)	See Edge Detail Options	Flat Cut CH1 Cherry MA1 Maple WA1 Walnut BO1 Black Oak	See Flat Cut Wood Finish Options	N None CT2 Dual Power Center Top CU2 Dual Power Underside CT2U1 Dual Power Center Top with Underside (See chart above)	See Metal Finish Color Options
		Double Cut DC1 Double Cut	See Double Cut Wood Finish Options		

Description

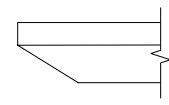
Rounded Double Chevron Table with T Base at Bar Height



Laminate Tables "LKT" Models



Eased Edge (R3)



Reverse Bevel Edge (K9)

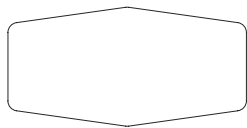
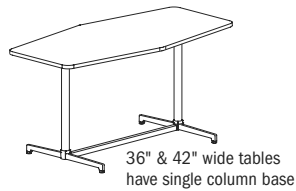
LAMINATE	D	W	H	CTN WT	CU FT	Model	Eased Edge (R3)		Reverse Bevel Edge (K9)			
							Standard	Graded In	Standard	Graded In		
							Tier 1	Tier 2	Tier 3	Tier 1	Tier 2	Tier 3
	48	96	42	216	132	LKT4896-42DCRT	\$3,399	\$3,451	\$3,769	\$3,871	\$3,925	\$4,152
	48	84	42	195	117	LKT4884-42DCRT	\$3,096	\$3,141	\$3,420	\$3,557	\$3,600	\$3,801
	42	96	42	189	118	LKT4296-42DCRT	\$3,017	\$3,062	\$3,341	\$3,478	\$3,523	\$3,721
	42	84	42	195	105	LKT4284-42DCRT	\$3,093	\$3,132	\$3,377	\$3,542	\$3,583	\$3,756
	36	96	42	152	102	LKT3696-42DCRT	\$2,564	\$2,603	\$2,843	\$3,012	\$3,051	\$3,221
	36	84	42	135	90	LKT3684-42DCRT	\$2,317	\$2,351	\$2,561	\$2,756	\$2,790	\$2,940

Features:

- price reflects complete table - top and base
- ships KD in multiple cartons
- one piece top
- model includes adjustable glide

Options:

- specify power/charging option, see below for options and upcharges



top shape

LOK - CONFERENCE

To Order Specify

1 Laminite Model #	2 Edge Detail	3 Laminite Selection	3a PVC Edge Color	4 Electrical	5 Metal Color
Laminite (LKT)	See Edge Detail Options	See Laminite Selection	See PVC Edge Color Options	N None CT2 Dual Power Center Top CU2 Dual Power Underside CT2U1 Dual Power Center Top with Underside (See chart on next page)	See Metal Finish Color Options

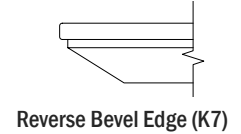
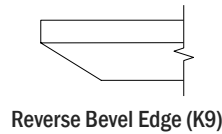
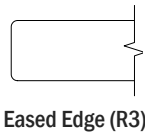
Model Number Breakdown

LKT4896-42DCRT						
LK	T	4896	42	DC	R	T
LOK	Laminite	48" x 96"	Height	Double Chevron Top Shape	Rounded Corner	T Base

Description

Rounded Double Chevron Table with T Base at Bar Height (continued)

Veneer Tables "LKV" Models	Solid Surface Tables "LKS" Models
----------------------------	-----------------------------------



	D	W	H	CTN WT	CU FT	① Model	Veneer Tables "LKV" Models		Solid Surface Tables "LKS" Models		
							Flat Cut	Double Cut	Flat Cut	Double Cut	Standard
VENEER	48	96	42	216	132	LKV4896-42DCRT	\$4,707	\$5,045	\$5,014	\$5,329	--
	48	84	42	195	117	LKV4884-42DCRT	\$4,375	\$4,666	\$4,663	\$4,935	--
	42	96	42	189	118	LKV4296-42DCRT	\$4,472	\$4,828	\$4,873	\$5,189	--
	42	84	42	195	105	LKV4284-42DCRT	\$4,493	\$4,852	\$4,898	\$5,216	--
	36	96	42	152	102	LKV3696-42DCRT	\$3,447	\$3,721	\$3,756	\$4,000	--
	36	84	42	135	90	LKV3684-42DCRT	\$3,186	\$3,440	\$3,471	\$3,699	--
SOLID SURFACE	48	96	42	216	132	LKS4896-42DCRT	--	--	--	--	\$10,586
	48	84	42	195	117	LKS4884-42DCRT	--	--	--	--	\$9,478
	42	96	42	189	118	LKS4296-42DCRT	--	--	--	--	\$8,550
	42	84	42	195	105	LKS4284-42DCRT	--	--	--	--	\$8,265
	36	96	42	152	102	LKS3696-42DCRT	--	--	--	--	\$7,535
	36	84	42	135	90	LKS3684-42DCRT	--	--	--	--	\$6,809

Electrical Options and Upcharges

CT2	84 - 96 wide
Dual Power Center Top - Black	CT2BL - add \$1,490
Dual Power Center Top - White	CT2WH - add \$1,490
CU1	
Dual Power Underside - Black	CU1-1C - add \$592
Dual Power Underside with Wireless Charging - Black	CU1-1CW - add \$1,371
CT2U1	
Dual Power Center Top - Black with Underside	CT2U1-BL - add \$1,813
Dual Power Center Top - White with Underside	CT2U1-WH - add \$1,813
Dual Power Center Top - Black with Wireless Charging	CT2U1-BLW2 - add \$2,592
Dual Power Center Top - White with Wireless Charging	CT2U1-WHW2 - add \$2,592

Note: Order power infed that best fits application

To Order Specify

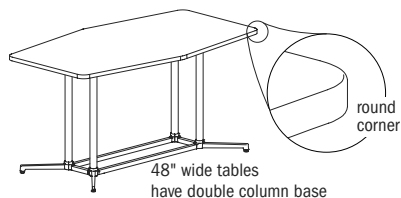
① Veneer Model #	② Edge Detail	③ Wood Species	④ Wood Finish	⑤ Electrical	⑥ Metal Color
Veneer (LKV)	See Edge Detail Options	Flat Cut CH1 Cherry MA1 Maple WA1 Walnut BO1 Black Oak	See Flat Cut Wood Finish Options	N None CT2 Dual Power Center Top CU2 Dual Power Underside CT2U1 Dual Power Center Top with Underside (See chart above)	See Metal Finish Color Options
		Double Cut DC1 Double Cut	See Double Cut Wood Finish Options		

① Solid Surface Model #	② Top Surface Selection	③ Electrical	④ Metal Color
Solid Surface (LKS)	See Solid Surface Top Surface Selection Options	N None CT2 Dual Power Center Top CU2 Dual Power Underside CT2U1 Dual Power Center Top with Underside (See chart above)	See Metal Finish Color Options

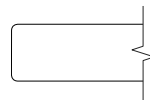
LOK - CONFERENCE

Description

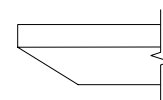
Rounded Double Chevron Table with Y Base at Bar Height



Laminate Tables "LKT" Models



Eased Edge (R3)



Reverse Bevel Edge (K9)

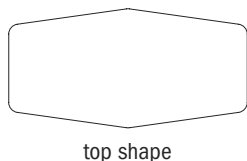
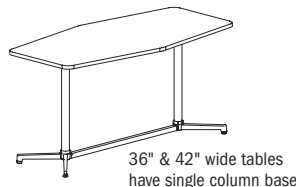
LAMINATE	D	W	H	CTN WT	CU FT	Model	Standard			Graded In		
							Tier 1	Tier 2	Tier 3	Tier 1	Tier 2	Tier 3
	48	96	42	211	132	LKT4896-42DCRY	\$3,318	\$3,369	\$3,686	\$3,790	\$3,842	\$4,069
48	84	42	194	117	LKT4884-42DCRY	\$2,929	\$2,975	\$3,253	\$3,392	\$3,436	\$3,635	
42	96	42	175	118	LKT4296-42DCRY	\$3,755	\$3,799	\$4,079	\$4,214	\$4,260	\$4,460	
42	84	42	159	103	LKT4284-42DCRY	\$2,624	\$2,663	\$2,908	\$3,074	\$3,113	\$3,288	
36	96	42	175	102	LKT3696-42DCRY	\$2,636	\$2,675	\$2,914	\$3,083	\$3,123	\$3,293	
36	84	42	154	90	LKT3684-42DCRY	\$2,347	\$2,382	\$2,591	\$2,786	\$2,821	\$2,971	

Features:

- price reflects complete table - top and base
- ships KD in multiple cartons
- one piece top
- model includes adjustable glide

Options:

- specify power/charging option, see below for options and upcharges



LOK - CONFERENCE

To Order Specify

1 Laminate Model #	2 Edge Detail	3 Laminate Selection	3a PVC Edge Color	4 Electrical	5 Metal Color
Laminate (LKT)	See Edge Detail Options	See Laminate Selection	See PVC Edge Color Options	N None CT2 Dual Power Center Top CU2 Dual Power Underside CT2U1 Dual Power Center Top with Underside (See chart on next page)	See Metal Finish Color Options

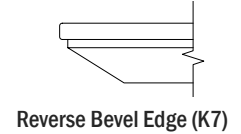
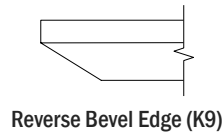
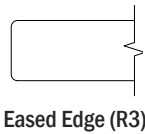
Model Number Breakdown

LKT4896-42DCRY						
LK	T	4896	42	DC	R	Y
LOK	Laminate	48" x 96"	Height	Double Chevron Top Shape	Rounded Corner	Y Base

Description

Rounded Double Chevron Table with Y Base at Bar Height (continued)

Veneer Tables "LKV" Models Solid Surface Tables "LKS" Models



	D	W	H	CTN WT	CU FT	① Model	Veneer Tables "LKV" Models		Solid Surface Tables "LKS" Models		
							Flat Cut	Double Cut	Flat Cut	Double Cut	Standard
VENEER	48	96	42	211	132	LKV4896-42DCRY	\$4,602	\$4,938	\$4,910	\$5,224	--
	48	84	42	194	117	LKV4884-42DCRY	\$4,168	\$4,460	\$4,455	\$4,727	--
	42	96	42	175	118	LKV4296-42DCRY	\$5,393	\$5,825	\$5,879	\$6,261	--
	42	84	42	159	103	LKV4284-42DCRY	\$3,920	\$4,233	\$4,273	\$4,549	--
	36	96	42	175	102	LKV3696-42DCRY	\$3,534	\$3,818	\$3,852	\$4,103	--
	36	84	42	154	90	LKV3684-42DCRY	\$3,224	\$3,483	\$3,513	\$3,743	--
SOLID SURFACE	48	96	42	211	132	LKS4896-42DCRY	--	--	--	--	\$10,482
	48	84	42	194	117	LKS4884-42DCRY	--	--	--	--	\$9,270
	42	96	42	175	118	LKS4296-42DCRY	--	--	--	--	\$9,471
	42	84	42	159	103	LKS4284-42DCRY	--	--	--	--	\$7,689
	36	96	42	175	102	LKS3696-42DCRY	--	--	--	--	\$7,621
	36	84	42	154	90	LKS3684-42DCRY	--	--	--	--	\$6,850

Electrical Options and Upcharges

CT2	84 - 96 wide
Dual Power Center Top - Black	CT2BL - add \$1,490
Dual Power Center Top - White	CT2WH - add \$1,490
CU1	
Dual Power Underside - Black	CU1-1C - add \$592
Dual Power Underside with Wireless Charging - Black	CU1-1CW - add \$1,371
CT2U1	
Dual Power Center Top - Black with Underside	CT2U1-BL - add \$1,813
Dual Power Center Top - White with Underside	CT2U1-WH - add \$1,813
Dual Power Center Top - Black with Wireless Charging	CT2U1-BLW2 - add \$2,592
Dual Power Center Top - White with Wireless Charging	CT2U1-WHW2 - add \$2,592

Note: Order power infed that best fits application

To Order Specify

① Veneer Model #	② Edge Detail	③ Wood Species	④ Wood Finish	⑤ Electrical	⑥ Metal Color
Veneer (LKV)	See Edge Detail Options	Flat Cut CH1 Cherry MA1 Maple WA1 Walnut BO1 Black Oak	See Flat Cut Wood Finish Options	N None CT2 Dual Power Center Top CU2 Dual Power Underside CT2U1 Dual Power Center Top with Underside (See chart above)	See Metal Finish Color Options
		Double Cut DC1 Double Cut	See Double Cut Wood Finish Options		

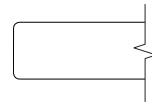
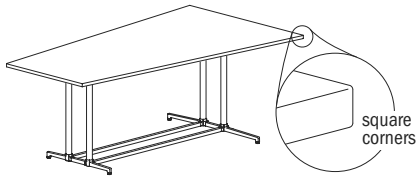
① Solid Surface Model #	② Top Surface Selection	③ Electrical	④ Metal Color
Solid Surface (LKS)	See Solid Surface Top Surface Selection Options	N None CT2 Dual Power Center Top CU2 Dual Power Underside CT2U1 Dual Power Center Top with Underside (See chart above)	See Metal Finish Color Options

LOK - CONFERENCE

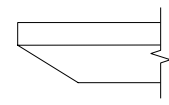
Description

Taper Table with T Base at Bar Height

Laminate Tables
"LKT" Models



Eased Edge (R3)



Reverse Bevel Edge (K9)

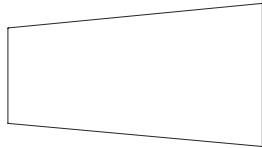
LAM.	D	W	H	CTN WT	CU FT	Model	Standard			Graded In		
	Tier 1	Tier 2	Tier 3	Tier 1	Tier 2	Tier 3	Tier 1	Tier 2	Tier 3	Tier 1	Tier 2	Tier 3
	54	96	42	228	147	LKT5496-42TPT	\$3,635	\$3,694	\$4,050	\$4,120	\$4,177	\$4,434

Features:

- price reflects complete table - top and base
- ships KD in multiple cartons
- one piece top
- model includes adjustable glide

Options:

- specify power/charging option, see below for options and upcharges



top shape

LOK - CONFERENCE

To Order Specify

1 Laminate Model #	2 Edge Detail	3 Laminate Selection	3a PVC Edge Color	4 Electrical	5 Metal Color
Laminate (LKT)	See Edge Detail Options	See Laminate Selection	See PVC Edge Color Options	N None CT2 Dual Power Center Top CU2 Dual Power Underside CT2U1 Dual Power Center Top with Underside (See chart on next page)	See Metal Finish Color Options

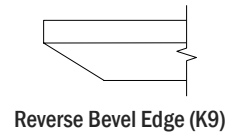
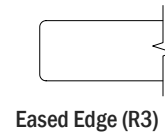
Model Number Breakdown

LKT5496-42TPT					
LK	T	5496	42	TP	T
LOK	Laminate	54" x 96"	Height	Taper Top Shape	T Base

Description

Taper Table with T Base at Bar Height
(continued)

Veneer Tables
"LKV" Models



VEN.	D	W	H	CTN WT	CU FT	① Model	Flat Cut	Double Cut	Flat Cut	Double Cut
		54	96	42	228	147	LKV5496-42TPT	\$4,963	\$5,358	\$5,408

Electrical Options and Upcharges

CT2	84 - 96 wide
Dual Power Center Top - Black	CT2BL - add \$1,490
Dual Power Center Top - White	CT2WH - add \$1,490
CU1	
Dual Power Underside - Black	CU1-1C - add \$592
Dual Power Underside with Wireless Charging - Black	CU1-1CW - add \$1,371
CT2U1	
Dual Power Center Top - Black with Underside	CT2U1-BL - add \$1,813
Dual Power Center Top - White with Underside	CT2U1-WH - add \$1,813
Dual Power Center Top - Black with Wireless Charging	CT2U1-BLW2 - add \$2,592
Dual Power Center Top - White with Wireless Charging	CT2U1-WHW2 - add \$2,592

Note: Order power infeed that best fits application

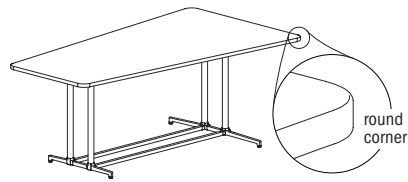
To Order Specify

① Veneer Model #	② Edge Detail	③ Wood Species	④ Wood Finish	⑤ Electrical	⑥ Metal Color
Veneer (LKV)	See Edge Detail Options	Flat Cut CH1 Cherry MA1 Maple WA1 Walnut BO1 Black Oak	See Flat Cut Wood Finish Options	N None CT2 Dual Power Center Top CU2 Dual Power Underside CT2U1 Dual Power Center Top with Underside (See chart above)	See Metal Finish Color Options
		Double Cut DC1 Double Cut	④ Wood Finish See Double Cut Wood Finish Options		

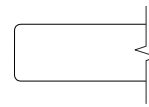
LOK - CONFERENCE

Description

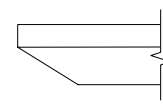
Rounded Taper Table with T Base at Bar Height



Laminate Tables "LKT" Models



Eased Edge (R3)



Reverse Bevel Edge (K9)

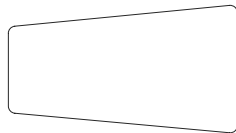
LAM.	D	W	H	CTN WT	CU FT	Model	Standard			Graded In		
	Tier 1	Tier 2	Tier 3	Tier 1	Tier 2	Tier 3	Tier 1	Tier 2	Tier 3	Tier 1	Tier 2	Tier 3
	54	96	42	228	147	LKT5496-42TPRT	\$3,635	\$3,694	\$4,050	\$4,120	\$4,177	\$4,434

Features:

- price reflects complete table - top and base
- ships KD in multiple cartons
- one piece top
- model includes adjustable glide

Options:

- specify power/charging option, see below for options and upcharges



top shape

LOK - CONFERENCE

To Order Specify

1 Laminata Model #	2 Edge Detail	3 Laminata Selection	3a PVC Edge Color	4 Electrical	5 Metal Color
Laminata (LKT)	See Edge Detail Options	See Laminata Selection	See PVC Edge Color Options	N None CT2 Dual Power Center Top CU2 Dual Power Underside CT2U1 Dual Power Center Top with Underside (See chart on next page)	See Metal Finish Color Options

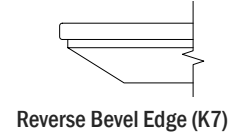
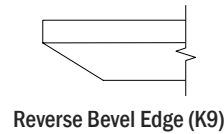
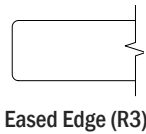
Model Number Breakdown

LKT5496-42TPRT						
LK	T	5496	42	TP	R	T
LOK	Laminata	54" x 96"	Height	Taper Top Shape	Rounded Corner	T Base

Description

Rounded Taper Table with T Base at Bar Height (continued)

Veneer Tables "LKV" Models	Solid Surface Tables "LKS" Models
----------------------------	-----------------------------------



	D	W	H	CTN WT	CU FT	① Model	Flat Cut	Double Cut	Flat Cut	Double Cut	Standard
VEN.	54	96	42	228	147	LKV5496-42TPRT	\$4,963	\$5,358	\$5,408	\$5,759	--
S.S.	54	96	42	228	147	LKS5496-42TPRT	--	--	--	--	\$13,747

Electrical Options and Upcharges

CT2	84 - 96 wide
Dual Power Center Top - Black	CT2BL - add \$1,490
Dual Power Center Top - White	CT2WH - add \$1,490
CU1	
Dual Power Underside - Black	CU1-1C - add \$592
Dual Power Underside with Wireless Charging - Black	CU1-1CW - add \$1,371
CT2U1	
Dual Power Center Top - Black with Underside	CT2U1-BL - add \$1,813
Dual Power Center Top - White with Underside	CT2U1-WH - add \$1,813
Dual Power Center Top - Black with Wireless Charging	CT2U1-BLW2 - add \$2,592
Dual Power Center Top - White with Wireless Charging	CT2U1-WHW2 - add \$2,592

LOK - CONFERENCE

Note: Order power infeed that best fits application

To Order Specify

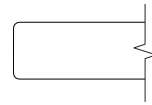
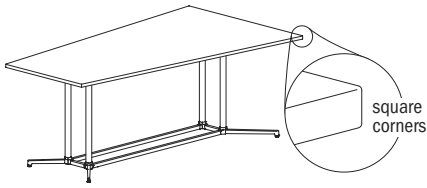
① Veneer Model #	② Edge Detail	③ Wood Species	④ Wood Finish	⑤ Electrical	⑥ Metal Color
Veneer (LKV)	See Edge Detail Options	Flat Cut CH1 Cherry MA1 Maple WA1 Walnut BO1 Black Oak	See Flat Cut Wood Finish Options	N None CT2 Dual Power Center Top CU2 Dual Power Underside CT2U1 Dual Power Center Top with Underside (See chart above)	See Metal Finish Color Options
		Double Cut DC1 Double Cut	④ Wood Finish See Double Cut Wood Finish Options		

① Solid Surface Model #	② Top Surface Selection	③ Electrical	④ Metal Color
Solid Surface (LKS)	See Solid Surface Top Surface Selection Options	N None CT2 Dual Power Center Top CU2 Dual Power Underside CT2U1 Dual Power Center Top with Underside (See chart above)	See Metal Finish Color Options

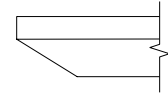
Description

Taper Table with Y Base at Bar Height

**Laminate Tables
"LKT" Models**



Eased Edge (R3)



Reverse Bevel Edge (K9)

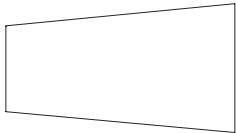
LAM.	D	W	H	CTN WT	CU FT	Model	Standard			Graded In		
	Tier 1	Tier 2	Tier 3	Tier 1	Tier 2	Tier 3	Tier 1	Tier 2	Tier 3	Tier 1	Tier 2	Tier 3
	54	96	42	198	147	LKT5496-42TPY	\$3,519	\$3,575	\$3,933	\$4,003	\$4,063	\$4,316

Features:

- price reflects complete table - top and base
- ships KD in multiple cartons
- one piece top
- model includes adjustable glide

Options:

- specify power/charging option, see below for options and upcharges



top shape

LOK - CONFERENCE

To Order Specify

1 Laminate Model #	2 Edge Detail	3 Laminate Selection	3a PVC Edge Color	4 Electrical	5 Metal Color
Laminate (LKT)	See Edge Detail Options	See Laminate Selection	See PVC Edge Color Options	N None CT2 Dual Power Center Top CU2 Dual Power Underside CT2U1 Dual Power Center Top with Underside (See chart on next page)	See Metal Finish Color Options

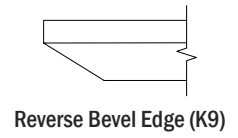
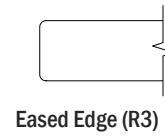
Model Number Breakdown

LKT5496-42TPY					
LK	T	5496	42	TP	Y
LOK	Laminate	54" x 96"	Height	Taper Top Shape	Y Base

Description

Taper Table with Y Base at Bar Height
(continued)

Veneer Tables
"LKV" Models



VEN.	D	W	H	CTN WT	CU FT	① Model	Flat Cut	Double Cut	Flat Cut	Double Cut
		54	96	42	198	147	LKV5496-42TPY	\$4,819	\$5,205	\$5,254

Electrical Options and Upcharges

CT2	84 - 96 wide
Dual Power Center Top - Black	CT2BL - add \$1,490
Dual Power Center Top - White	CT2WH - add \$1,490
CU1	
Dual Power Underside - Black	CU1-1C - add \$592
Dual Power Underside with Wireless Charging - Black	CU1-1CW - add \$1,371
CT2U1	
Dual Power Center Top - Black with Underside	CT2U1-BL - add \$1,813
Dual Power Center Top - White with Underside	CT2U1-WH - add \$1,813
Dual Power Center Top - Black with Wireless Charging	CT2U1-BLW2 - add \$2,592
Dual Power Center Top - White with Wireless Charging	CT2U1-WHW2 - add \$2,592

Note: Order power infeed that best fits application

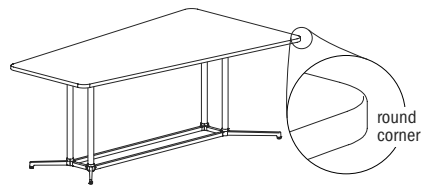
To Order Specify

① Veneer Model #	② Edge Detail	③ Wood Species	④ Wood Finish	⑤ Electrical	⑥ Metal Color
Veneer (LKV)	See Edge Detail Options	Flat Cut CH1 Cherry MA1 Maple WA1 Walnut BO1 Black Oak	See Flat Cut Wood Finish Options	N None CT2 Dual Power Center Top CU2 Dual Power Underside CT2U1 Dual Power Center Top with Underside (See chart above)	See Metal Finish Color Options
		Double Cut DC1 Double Cut	④ Wood Finish See Double Cut Wood Finish Options		

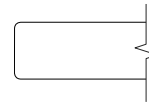
LOK - CONFERENCE

Description

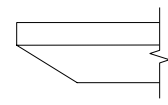
Rounded Taper Table with Y Base at Bar Height



Laminate Tables "LKT" Models



Eased Edge (R3)



Reverse Bevel Edge (K9)

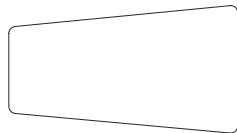
Lam.	D	W	H	CTN WT	CU FT	Model	Standard			Graded In		
	Tier 1	Tier 2	Tier 3	Tier 1	Tier 2	Tier 3	Tier 1	Tier 2	Tier 3	Tier 1	Tier 2	Tier 3
	54	96	42	198	147	LKT5496-42TPRY	\$3,519	\$3,575	\$3,933	\$4,003	\$4,063	\$4,316

Features:

- price reflects complete table - top and base
- ships KD in multiple cartons
- one piece top
- model includes adjustable glide

Options:

- specify power/charging option, see below for options and upcharges



top shape

LOK - CONFERENCE

To Order Specify

1 Laminate Model #	2 Edge Detail	3 Laminate Selection	3a PVC Edge Color	4 Electrical	5 Metal Color
Laminate (LKT)	See Edge Detail Options	See Laminate Selection	See PVC Edge Color Options	N None CT2 Dual Power Center Top CU2 Dual Power Underside CT2U1 Dual Power Center Top with Underside (See chart on next page)	See Metal Finish Color Options

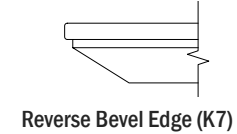
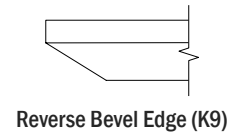
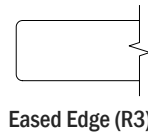
Model Number Breakdown

LKT5496-42TPRY						
LK	T	5496	42	TP	R	Y
LOK	Laminate	54" x 96"	Height	Taper Top Shape	Rounded Corner	Y Base

Description

Rounded Taper Table with Y Base at Bar Height (continued)

Veneer Tables "LKV" Models	Solid Surface Tables "LKS" Models
----------------------------	-----------------------------------



	D	W	H	CTN WT	CU FT	① Model	Flat Cut	Double Cut	Flat Cut	Double Cut	Standard
VEN.	54	96	42	198	147	LKV5496-42TPRY	\$4,819	\$5,205	\$5,254	\$5,593	--
S.S.	54	96	42	198	147	LKS5496-42TPRY	--	--	--	--	\$13,604

Electrical Options and Upcharges

CT2	84 - 96 wide
Dual Power Center Top - Black	CT2BL - add \$1,490
Dual Power Center Top - White	CT2WH - add \$1,490
CU1	
Dual Power Underside - Black	CU1-1C - add \$592
Dual Power Underside with Wireless Charging - Black	CU1-1CW - add \$1,371
CT2U1	
Dual Power Center Top - Black with Underside	CT2U1-BL - add \$1,813
Dual Power Center Top - White with Underside	CT2U1-WH - add \$1,813
Dual Power Center Top - Black with Wireless Charging	CT2U1-BLW2 - add \$2,592
Dual Power Center Top - White with Wireless Charging	CT2U1-WHW2 - add \$2,592

LOK - CONFERENCE

Note: Order power infeed that best fits application

To Order Specify

① Veneer Model #	② Edge Detail	③ Wood Species	④ Wood Finish	⑤ Electrical	⑥ Metal Color
Veneer (LKV)	See Edge Detail Options	Flat Cut CH1 Cherry MA1 Maple WA1 Walnut BO1 Black Oak	See Flat Cut Wood Finish Options	N None CT2 Dual Power Center Top CU2 Dual Power Underside CT2U1 Dual Power Center Top with Underside (See chart above)	See Metal Finish Color Options
		Double Cut DC1 Double Cut	④ Wood Finish See Double Cut Wood Finish Options		

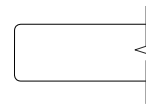
① Solid Surface Model #	② Top Surface Selection	③ Electrical	④ Metal Color
Solid Surface (LKS)	See Solid Surface Top Surface Selection Options	N None CT2 Dual Power Center Top CU2 Dual Power Underside CT2U1 Dual Power Center Top with Underside (See chart above)	See Metal Finish Color Options

Description

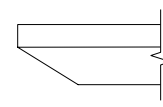
Round Table with X Base at Bar Height



Laminate Tables
"LKT" Models



Eased Edge (R3)



Reverse Bevel Edge (K9)

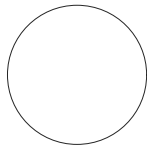
LAMINATE	D	W	H	CTN WT	CU FT	❶ Model	Standard			Graded In		
							Tier 1	Tier 2	Tier 3	Tier 1	Tier 2	Tier 3
		48	48	42	90	69	LKT48-42RDX	\$1,698	\$1,816	\$1,947	\$2,152	\$2,271
	42	42	42	75	54	LKT42-42RDX	\$1,562	\$1,679	\$1,775	\$2,018	\$2,135	\$2,232
	36	36	42	60	41	LKT36-42RDX	\$1,514	\$1,558	\$1,626	\$1,970	\$2,014	\$2,082
	30	30	42	50	30	LKT30-42RDX	\$1,463	\$1,497	\$1,537	\$1,918	\$1,953	\$1,993

Features:

- price reflects complete table - top and base
- ships KD in multiple cartons
- one piece top
- model includes adjustable glide
- when electrical option is selected, power accessible base is shipped; see page 178 for details
- power/charging units have 72" cord
- power cord is routed inside base column

Options:

- specify power access base with power unit option; None (N), add \$643 for EC23 (CTEC23), add \$533 for EC24 (CTEC24)



top shape

LOK - CONFERENCE

To Order Specify

❶ Laminata Model #	❷ Edge Detail	❸ Laminata Selection	❹ PVC Edge Color	❺ Electrical	❻ Metal Color
Laminata (LKT)	See Edge Detail Options	See Laminata Selection	See PVC Edge Color Options	N None CTEC23 Power Center Top CTEC24 Power Center Top (See chart on next page)	See Metal Finish Color Options

Model Number Breakdown

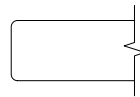
LKT48-42RDX					
LK	T	48	42	RD	X
LOK	Laminata	48"dia.	Height	Round Top Shape	X Base

Description

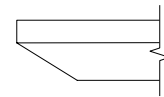
Round Table with X Base at Bar Height
(continued)

Veneer Tables
"LKV" Models

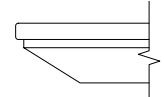
Solid Surface Tables
"LKS" Models



Eased Edge (R3)



Reverse Bevel Edge (K9)



Reverse Bevel Edge (K7)

	D	W	H	CTN WT	CU FT	① Model	Veneer Tables "LKV" Models		Solid Surface Tables "LKS" Models		
							Flat Cut	Double Cut	Flat Cut	Double Cut	Standard
VENEER	48	48	42	90	69	LKV48-42RDX	\$2,232	\$2,378	\$2,315	\$2,470	--
	42	42	42	75	54	LKV42-42RDX	\$2,048	\$2,183	\$2,126	\$2,267	--
	36	36	42	60	41	LKV36-42RDX	\$1,986	\$2,116	\$2,064	\$2,200	--
	30	30	42	50	30	LKV30-42RDX	\$1,917	\$2,043	\$1,990	\$2,120	--
SOLID SURFACE	48	48	42	90	69	LKS48-42RDX	--	--	--	--	\$5,174
	42	42	42	75	54	LKS42-42RDX	--	--	--	--	\$4,412
	36	36	42	60	41	LKS36-42RDX	--	--	--	--	\$3,851
	30	30	42	50	30	LKS30-42RDX	--	--	--	--	\$3,354

Electrical Options and Upcharges

CTEC23	
EC23 Power Center Top - Black	CTEC23BL - add \$643
EC23 Power Center Top - White	CTEC23WH - add \$643
CTEC24	
EC24 Power Center Top - Black	CTEC43BL - add \$533
EC24 Power Center Top - White	CTEC43WH - add \$533

To Order Specify

① Veneer Model #	② Edge Detail	③ Wood Species	④ Wood Finish	⑤ Electrical	⑥ Metal Color
Veneer (LKV)	See Edge Detail Options	Flat Cut CH1 Cherry MA1 Maple WA1 Walnut BO1 Black Oak	See Flat Cut Wood Finish Options	N None CTEC23 Power Center Top CTEC24 Power Center Top (See chart above)	See Metal Finish Color Options
		Double Cut DC1 Double Cut	④ Wood Finish See Double Cut Wood Finish Options		

① Solid Surface Model #	② Top Surface Selection	③ Electrical Cut Out	④ Metal Color
Solid Surface (LKS)	See Solid Surface Top Surface Selection Options	N None CTEC23 Power Center Top CTEC24 Power Center Top (See chart above)	See Metal Finish Color Options

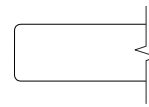
LOK - CONFERENCE

Description

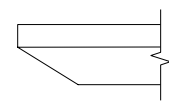
Round Table with X4 Base at Bar Height



Laminate Tables
"LKT" Models



Eased Edge (R3)



Reverse Bevel Edge (K9)

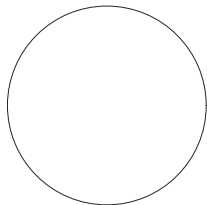
LAMINATE	D	W	H	CTN WT	CU FT	Model	Eased Edge (R3)			Reverse Bevel Edge (K9)		
							Standard	Graded In		Standard	Graded In	
							Tier 1	Tier 2	Tier 3	Tier 1	Tier 2	Tier 3
	60	60	42	207	94	LKT60-42RDZ	\$2,814	\$2,908	\$3,115	\$3,269	\$3,361	\$3,572
	54	54	42	180	86	LKT54-42RDZ	\$2,635	\$2,709	\$2,778	\$3,090	\$3,163	\$3,234

Features:

- price reflects complete table - top and base
- ships KD in multiple cartons
- one piece top
- model includes adjustable glide
- power cord is routed outside base column
- order vertical wire manager separately; see page 407

Options:

- specify power unit option; None (N), add \$643 for EC23 (CTEC23), add \$533 for EC24 (CTEC24)



top shape

LOK - CONFERENCE

To Order Specify

1 Laminata Model #	2 Edge Detail	3 Laminata Selection	3a PVC Edge Color	4 Electrical	5 Metal Color
Laminata (LKT)	See Edge Detail Options	See Laminata Selection	See PVC Edge Color Options	N None CTEC23 Power Center Top CTEC24 Power Center Top (See chart on next page)	See Metal Finish Color Options

Model Number Breakdown

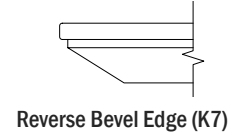
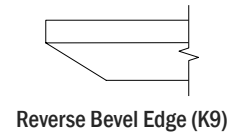
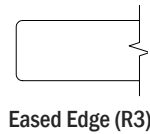
LKT60-42RDZ					
LK	T	60	42	RD	Z
LOK	Laminata	60"dia.	Height	Round Top Shape	X4 Base

Description

Round Table with X4 Base at Bar Height
(continued)

Veneer Tables
"LKV" Models

Solid Surface Tables
"LKS" Models



	D	W	H	CTN WT	CU FT	① Model	Veneer Tables "LKV" Models		Solid Surface Tables "LKS" Models		
							Flat Cut	Double Cut	Flat Cut	Double Cut	Standard
VENEER	60	60	42	207	94	LKV60-42RDZ	\$3,683	\$3,926	\$3,822	\$4,071	--
	54	54	42	180	86	LKV54-42RDZ	\$3,487	\$3,721	\$3,620	\$3,866	--
SOL. SURF.	60	60	42	207	94	LKS60-42RDZ	--	--	--	--	\$8,010
	54	54	42	180	86	LKS54-42RDZ	--	--	--	--	\$7,082

Electrical Options and Upcharges

CTEC23	
EC23 Power Center Top - Black	CTEC23BL - add \$643
EC23 Power Center Top - White	CTEC23WH - add \$643
CTEC24	
EC24 Power Center Top - Black	CTEC24BL - add \$533
EC24 Power Center Top - White	CTEC24WH - add \$533

To Order Specify

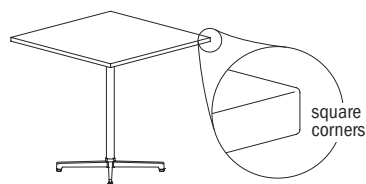
① Veneer Model #	② Edge Detail	③ Wood Species	④ Wood Finish	⑤ Electrical	⑥ Metal Color
Veneer (LKV)	See Edge Detail Options	Flat Cut CH1 Cherry MA1 Maple WA1 Walnut BO1 Black Oak	See Flat Cut Wood Finish Options	N None CTEC23 Power Center Top CTEC24 Power Center Top (See chart above)	See Metal Finish Color Options
		Double Cut DC1 Double Cut	④ Wood Finish See Double Cut Wood Finish Options		

① Solid Surface Model #	② Top Surface Selection	③ Electrical Cut Out	④ Metal Color
Solid Surface (LKS)	See Solid Surface Top Surface Selection Options	N None CTEC23 Power Center Top CTEC24 Power Center Top (See chart above)	See Metal Finish Color Options

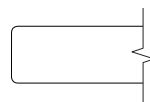
LOK - CONFERENCE

Description

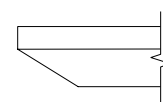
Square Table with X Base
at Bar Height



Laminate Tables
"LKT" Models



Eased Edge (R3)



Reverse Bevel Edge (K9)

LAMINATE	D	W	H	CTN WT	CU FT	Model	Standard Tier 1	Graded In		Standard Tier 1	Graded In	
								Tier 2	Tier 3		Tier 2	Tier 3
	42	42	42	87	54	LKT4242-42SQX	\$1,599	\$1,651	\$1,777	\$2,055	\$2,107	\$2,233
36	36	42	70	41	LKT3636-42SQX	\$1,424	\$1,465	\$1,495	\$1,879	\$1,920	\$1,949	
30	30	42	55	30	LKT3030-42SQX	\$1,282	\$1,316	\$1,333	\$1,738	\$1,772	\$1,787	

Features:

- price reflects complete table - top and base
- ships KD in multiple cartons
- one piece top
- model includes adjustable glide
- when electrical option is selected, power accessible base is shipped; see page 178 for details
- power/charging units have 72" cord
- power cord is routed inside base column

Options:

- specify power access base with power unit option; None (N), add \$643 for EC23 (CTEC23), add \$533 for EC24 (CTEC24)



top shape

LOK - CONFERENCE

To Order Specify

1 Laminate Model #	2 Edge Detail	3 Laminate Selection	3a PVC Edge Color	4 Electrical	5 Metal Color
Laminate (LKT)	See Edge Detail Options	See Laminate Selection	See PVC Edge Color Options	N None CTEC23 Power Center Top CTEC24 Power Center Top (See chart on next page)	See Metal Finish Color Options

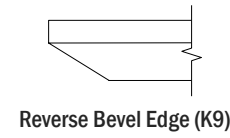
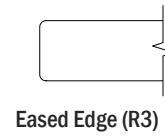
Model Number Breakdown

LKT4242-42SQX					
LK	T	4242	42	SQ	X
LOK	Laminate	42" x 42"	Height	Square Top Shape	X Base

Description

Square Table with X Base at Bar
Height
(continued)

Veneer Tables
"LKV" Models



VENEER	D	W	H	CTN WT	CU FT	① Model	Flat Cut	Double Cut	Flat Cut	Double Cut
		42	42	42	87	54	LKV4242-42SQX	\$2,070	\$2,205	\$2,148
	36	36	42	70	41	LKV3636-42SQX	\$1,839	\$1,959	\$1,907	\$2,032
	30	30	42	55	30	LKV3030-42SQX	\$1,654	\$1,761	\$1,712	\$1,827

LOK - CONFERENCE

Electrical Options and Upcharges

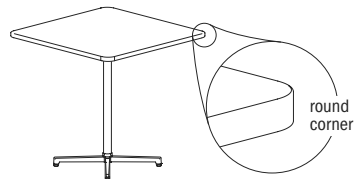
CTEC23	
EC23 Power Center Top - Black	CTEC23BL - add \$643
EC23 Power Center Top - White	CTEC23WH - add \$643
CTEC24	
EC24 Power Center Top - Black	CTEC43BL - add \$533
EC24 Power Center Top - White	CTEC43WH - add \$533

To Order Specify

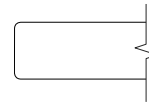
① Veneer Model #	② Edge Detail	③ Wood Species	④ Wood Finish	⑤ Electrical	⑥ Metal Color
Veneer (LKV)	See Edge Detail Options	Flat Cut CH1 Cherry MA1 Maple WA1 Walnut BO1 Black Oak	See Flat Cut Wood Finish Options	N None CTEC23 Power Center Top CTEC24 Power Center Top (See chart above)	See Metal Finish Color Options
		Double Cut DC1 Double Cut	④ Wood Finish See Double Cut Wood Finish Options		

Description

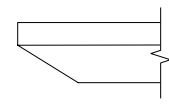
Rounded Square Table with X Base at Bar Height



Laminate Tables
"LKT" Models



Eased Edge (R3)



Reverse Bevel Edge (K9)

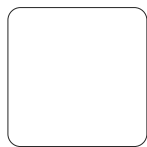
LAMINATE	D	W	H	CTN WT	CU FT	Model	Eased Edge (R3)		Reverse Bevel Edge (K9)			
							Standard	Graded In		Standard	Graded In	
							Tier 1	Tier 2	Tier 3	Tier 1	Tier 2	Tier 3
	42	42	42	87	54	LKT4242-42SQRX	\$1,955	\$2,007	\$2,184	\$2,411	\$2,463	\$2,641
	36	36	42	70	41	LKT3636-42SQRX	\$1,635	\$1,678	\$1,744	\$2,090	\$2,134	\$2,200
	30	30	42	55	30	LKT3030-42SQRX	\$1,465	\$1,504	\$1,544	\$1,921	\$1,959	\$2,000

Features:

- price reflects complete table - top and base
- ships KD in multiple cartons
- one piece top
- model includes adjustable glide
- when electrical option is selected, power accessible base is shipped; see page 178 for details
- power/charging units have 72" cord
- power cord is routed inside base column

Options:

- specify power access base with power unit option; None (N), add \$643 for EC23 (CTEC23), add \$533 for EC24 (CTEC24)



top shape

LOK - CONFERENCE

To Order Specify

1 Laminate Model #	2 Edge Detail	3 Laminate Selection	3a PVC Edge Color	4 Electrical	5 Metal Color
Laminate (LKT)	See Edge Detail Options	See Laminate Selection	See PVC Edge Color Options	N None CTEC23 Power Center Top CTEC24 Power Center Top (See chart on next page)	See Metal Finish Color Options

Model Number Breakdown

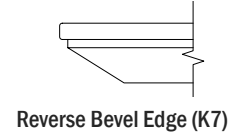
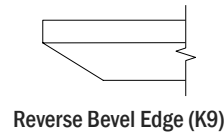
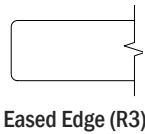
LKT4242-42SQRX						
LK	T	4242	42	SQ	R	X
LOK	Laminate	42" x 42"	Height	Square Top Shape	Rounded Corner	X Base

Description

Rounded Square Table with X Base at Bar Height (continued)

Veneer Tables "LKV" Models

Solid Surface Tables "LKS" Models



	D	W	H	CTN WT	CU FT	① Model	Veneer Tables "LKV" Models		Solid Surface Tables "LKS" Models		
							Flat Cut	Double Cut	Flat Cut	Double Cut	Standard
VENEER	42	42	42	87	54	LKV4242-42SQRX	\$2,550	\$2,718	\$2,647	\$2,823	--
	36	36	42	70	41	LKV3636-42SQRX	\$2,116	\$2,257	\$2,199	\$2,344	--
	30	30	42	55	30	LKV3030-42SQRX	\$1,896	\$2,021	\$1,967	\$2,097	--
SOLID SURFACE	42	42	42	87	54	LKS4242-42SQRX	--	--	--	--	\$4,911
	36	36	42	70	41	LKS3636-42SQRX	--	--	--	--	\$3,980
	30	30	42	55	30	LKS3030-42SQRX	--	--	--	--	\$3,333

Electrical Options and Upcharges

CTEC23	
EC23 Power Center Top - Black	CTEC23BL - add \$643
EC23 Power Center Top - White	CTEC23WH - add \$643
CTEC24	
EC24 Power Center Top - Black	CTEC43BL - add \$533
EC24 Power Center Top - White	CTEC43WH - add \$533

To Order Specify

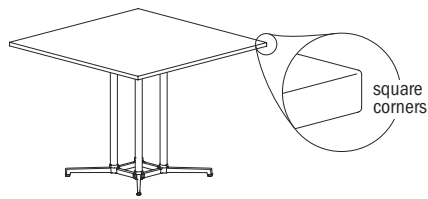
① Veneer Model #	② Edge Detail	③ Wood Species	④ Wood Finish	⑤ Electrical	⑥ Metal Color
Veneer (LKV)	See Edge Detail Options	Flat Cut CH1 Cherry MA1 Maple WA1 Walnut BO1 Black Oak	See Flat Cut Wood Finish Options	N None CTEC23 Power Center Top CTEC24 Power Center Top (See chart above)	See Metal Finish Color Options
		Double Cut DC1 Double Cut	④ Wood Finish See Double Cut Wood Finish Options		

① Solid Surface Model #	② Top Surface Selection	③ Electrical Cut Out	④ Metal Color
Solid Surface (LKS)	See Solid Surface Top Surface Selection Options	N None CTEC23 Power Center Top CTEC24 Power Center Top (See chart above)	See Metal Finish Color Options

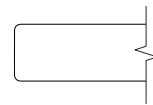
LOK - CONFERENCE

Description

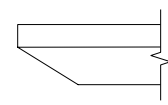
Square Table with X4 Base at Bar Height



Laminate Tables
"LKT" Models



Eased Edge (R3)



Reverse Bevel Edge (K9)

LAMINATE	D	W	H	CTN WT	CU FT	Model	Eased Edge (R3)			Reverse Bevel Edge (K9)		
							Standard	Graded In		Standard	Graded In	
							Tier 1	Tier 2	Tier 3	Tier 1	Tier 2	Tier 3
	60	60	42	207	94	LKT6060-42SQZ	\$3,193	\$3,287	\$3,497	\$3,649	\$3,742	\$3,953
	54	54	42	180	86	LKT5454-42SQZ	\$3,042	\$3,124	\$3,288	\$3,498	\$3,579	\$3,743
	48	48	42	124	69	LKT4848-42SQZ	\$2,538	\$2,593	\$2,731	\$2,993	\$3,049	\$3,186

Features:

- price reflects complete table - top and base
- ships KD in multiple cartons
- one piece top
- model includes adjustable glide
- power cord is routed outside base column
- order vertical wire manager separately; see page 407

Options:

- specify power unit option; None (N), add \$643 for EC23 (CTEC23), add \$533 for EC24 (CTEC24)



top shape

LOK - CONFERENCE

To Order Specify

1 Laminate Model #	2 Edge Detail	3 Laminate Selection	3a PVC Edge Color	4 Electrical	5 Metal Color
Laminate (LKT)	See Edge Detail Options	See Laminate Selection	See PVC Edge Color Options	N None CTEC23 Power Center Top CTEC24 Power Center Top (See chart on next page)	See Metal Finish Color Options

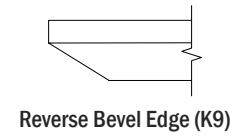
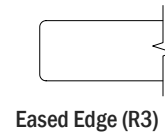
Model Number Breakdown

LKT6060-42SQZ					
LK	T	6060	42	SQ	Z
LOK	Laminate	60" x 60"	Height	Square Top Shape	X4 Base

Description

Square Table with X4 Base
at Bar Height
(continued)

Veneer Tables
"LKV" Models



VENEER	D	W	H	CTN WT	CU FT	① Model	Flat Cut	Double Cut	Flat Cut	Double Cut
		60	60	42	207	94	LKV6060-42SQZ	\$4,133	\$4,405	\$4,290
	54	54	42	180	86	LKV5454-42SQZ	\$3,934	\$4,192	\$4,081	\$4,351
	48	48	42	124	69	LKV4848-42SQZ	\$3,053	\$3,201	\$3,137	\$3,293

LOK - CONFERENCE

Electrical Options and Upcharges

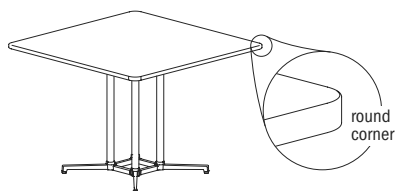
CTEC23	
EC23 Power Center Top - Black	CTEC23BL - add \$643
EC23 Power Center Top - White	CTEC23WH - add \$643
CTEC24	
EC24 Power Center Top - Black	CTEC43BL - add \$533
EC24 Power Center Top - White	CTEC43WH - add \$533

To Order Specify

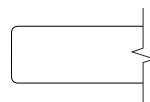
① Veneer Model #	② Edge Detail	③ Wood Species	④ Wood Finish	⑤ Electrical	⑥ Metal Color
Veneer (LKV)	See Edge Detail Options	Flat Cut CH1 Cherry MA1 Maple WA1 Walnut BO1 Black Oak	See Flat Cut Wood Finish Options	N None CTEC23 Power Center Top CTEC24 Power Center Top (See chart above)	See Metal Finish Color Options
		Double Cut DC1 Double Cut	④ Wood Finish See Double Cut Wood Finish Options		

Description

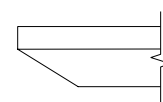
Rounded Square Table with X4 Base at Bar Height



Laminate Tables "LKT" Models



Eased Edge (R3)



Reverse Bevel Edge (K9)

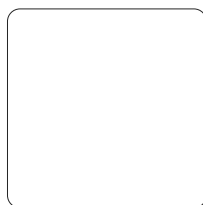
LAMINATE	D	W	H	CTN WT	CU FT	Model	Eased Edge (R3)			Reverse Bevel Edge (K9)		
							Standard	Graded In		Standard	Graded In	
							Tier 1	Tier 2	Tier 3	Tier 1	Tier 2	Tier 3
	60	60	42	207	94	LKT6060-42SQRZ	\$3,426	\$3,510	\$3,731	\$3,884	\$3,965	\$4,187
	54	54	42	180	86	LKT5454-42SQRZ	\$2,846	\$2,927	\$3,090	\$3,300	\$3,383	\$3,546
	48	48	42	124	69	LKT4848-42SQRZ	\$2,908	\$2,964	\$3,127	\$3,361	\$3,420	\$3,583

Features:

- price reflects complete table - top and base
- ships KD in multiple cartons
- one piece top
- model includes adjustable glide
- power cord is routed outside base column
- order vertical wire manager separately; see page 407

Options:

- specify power unit option; None (N), add \$643 for EC23 (CTEC23), add \$533 for EC24 (CTEC24)



top shape

LOK - CONFERENCE

To Order Specify

1 Laminate Model #	2 Edge Detail	3 Laminate Selection	3a PVC Edge Color	4 Electrical	5 Metal Color
Laminate (LKT)	See Edge Detail Options	See Laminate Selection	See PVC Edge Color Options	N None CTEC23 Power Center Top CTEC24 Power Center Top (See chart on next page)	See Metal Finish Color Options

Model Number Breakdown

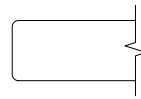
LKT6060-42SQRZ						
LK	T	6060	42	SQ	R	Z
LOK	Laminate	60" x 60"	Height	Square Top Shape	Rounded Corner	X4 Base

Description

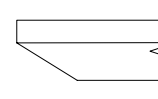
Rounded Square Table with X4 Base at Bar Height (continued)

Veneer Tables "LKV" Models

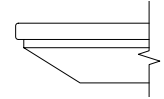
Solid Surface Tables "LKS" Models



Eased Edge (R3)



Reverse Bevel Edge (K9)



Reverse Bevel Edge (K7)

	D	W	H	CTN WT	CU FT	① Model	Veneer Tables "LKV" Models		Solid Surface Tables "LKS" Models		
							Flat Cut	Double Cut	Flat Cut	Double Cut	Standard
VENEER	60	60	42	207	94	LKV6060-42SQRZ	\$4,443	\$4,737	\$4,612	\$4,916	--
	54	54	42	180	86	LKV5454-42SQRZ	\$3,673	\$3,914	\$3,810	\$4,062	--
	48	48	42	124	69	LKV4848-42SQRZ	\$3,540	\$3,722	\$3,643	\$3,834	--
SOLID SURFACE	60	60	42	207	94	LKS6060-42SQRZ	--	--	--	--	\$8,769
	54	54	42	180	86	LKS5454-42SQRZ	--	--	--	--	\$7,270
	48	48	42	124	69	LKS4848-42SQRZ	--	--	--	--	\$5,676

Electrical Options and Upcharges

CTEC23	
EC23 Power Center Top - Black	CTEC23BL - add \$643
EC23 Power Center Top - White	CTEC23WH - add \$643
CTEC24	
EC24 Power Center Top - Black	CTEC24BL - add \$533
EC24 Power Center Top - White	CTEC24WH - add \$533

To Order Specify

① Veneer Model #	② Edge Detail	③ Wood Species	④ Wood Finish	⑤ Electrical	⑥ Metal Color
Veneer (LKV)	See Edge Detail Options	Flat Cut CH1 Cherry MA1 Maple WA1 Walnut BO1 Black Oak	See Flat Cut Wood Finish Options	N None CTEC23 Power Center Top CTEC24 Power Center Top (See chart above)	See Metal Finish Color Options
		Double Cut DC1 Double Cut	④ Wood Finish See Double Cut Wood Finish Options		

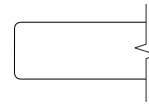
① Solid Surface Model #	② Top Surface Selection	③ Electrical Cut Out	④ Metal Color
Solid Surface (LKS)	See Solid Surface Top Surface Selection Options	N None CTEC23 Power Center Top CTEC24 Power Center Top (See chart above)	See Metal Finish Color Options

Description

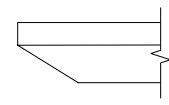
Squircle Table with X Base at Bar Height



Laminate Tables
"LKT" Models



Eased Edge (R3)



Reverse Bevel Edge (K9)

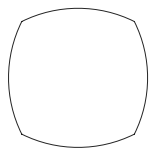
LAMINATE	D	W	H	CTN WT	CU FT	Model	Eased Edge (R3)		Reverse Bevel Edge (K9)			
							Standard	Graded In		Standard	Graded In	
							Tier 1	Tier 2	Tier 3	Tier 1	Tier 2	Tier 3
	42	42	42	104	54	LKT42-42SCX	\$1,582	\$1,700	\$1,797	\$2,039	\$2,156	\$2,253
	36	36	42	82	41	LKT36-42SCX	\$1,534	\$1,576	\$1,646	\$1,989	\$2,032	\$2,103
	30	30	42	64	30	LKT30-42SCX	\$1,483	\$1,517	\$1,558	\$1,940	\$1,976	\$2,015

Features:

- price reflects complete table - top and base
- ships KD in multiple cartons
- one piece top
- model includes adjustable glide
- when electrical option is selected, power accessible base is shipped; see page 178 for details
- power/charging units have 72" cord
- power cord is routed inside base column

Options:

- specify power access base with power unit option; None (N), add \$643 for EC23 (CTEC23), add \$533 for EC24 (CTEC24)



top shape

LOK - CONFERENCE

To Order Specify

1 Laminate Model #	2 Edge Detail	3 Laminate Selection	3a PVC Edge Color	4 Electrical	5 Metal Color
Laminate (LKT)	See Edge Detail Options	See Laminate Selection	See PVC Edge Color Options	N None CTEC23 Power Center Top CTEC24 Power Center Top (See chart on next page)	See Metal Finish Color Options

Model Number Breakdown

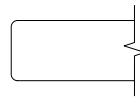
LKT42-42SCX					
LK	T	42	42	SC	X
LOK	Laminate	42" dia.	Height	Squircle Top Shape	X Base

Description

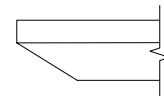
Squirrel Table with X Base
at Bar Height
(continued)

Veneer Tables
"LKV" Models

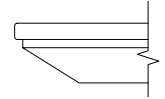
Solid Surface Tables
"LKS" Models



Eased Edge (R3)



Reverse Bevel Edge (K9)



Reverse Bevel Edge (K7)

	D	W	H	CTN WT	CU FT	① Model	Veneer Tables "LKV" Models		Solid Surface Tables "LKS" Models		
							Flat Cut	Double Cut	Flat Cut	Double Cut	Standard
VENEER	42	42	42	104	54	LKV42-42SCX	\$2,070	\$2,204	\$2,148	\$2,288	--
	36	36	42	82	41	LKV36-42SCX	\$2,006	\$2,138	\$2,084	\$2,219	--
	30	30	42	64	30	LKV30-42SCX	\$1,937	\$2,064	\$2,011	\$2,141	--
SOLID SURFACE	42	42	42	104	54	LKS42-42SCX	--	--	--	--	\$4,451
	36	36	42	82	41	LKS36-42SCX	--	--	--	--	\$3,890
	30	30	42	64	30	LKS30-42SCX	--	--	--	--	\$3,751

Electrical Options and Upcharges

CTEC23	
EC23 Power Center Top - Black	CTEC23BL - add \$643
EC23 Power Center Top - White	CTEC23WH - add \$643
CTEC24	
EC24 Power Center Top - Black	CTEC43BL - add \$533
EC24 Power Center Top - White	CTEC43WH - add \$533

To Order Specify

① Veneer Model #	② Edge Detail	③ Wood Species	④ Wood Finish	⑤ Electrical	⑥ Metal Color
Veneer (LKV)	See Edge Detail Options	Flat Cut CH1 Cherry MA1 Maple WA1 Walnut BO1 Black Oak	See Flat Cut Wood Finish Options	N None CTEC23 Power Center Top CTEC24 Power Center Top (See chart above)	See Metal Finish Color Options
		Double Cut DC1 Double Cut	④ Wood Finish See Double Cut Wood Finish Options		

① Solid Surface Model #	② Top Surface Selection	③ Electrical Cut Out	④ Metal Color
Solid Surface (LKS)	See Solid Surface Top Surface Selection Options	N None CTEC23 Power Center Top CTEC24 Power Center Top (See chart above)	See Metal Finish Color Options

Description

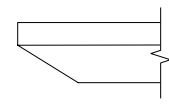
Squircle Table with X4 Base at Bar Height



Laminate Tables "LKT" Models



Eased Edge (R3)



Reverse Bevel Edge (K9)

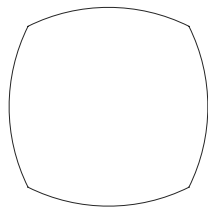
LAMINATE	D	W	H	CTN WT	CU FT	Model	Eased Edge (R3)			Reverse Bevel Edge (K9)		
							Standard	Graded In		Standard	Graded In	
							Tier 1	Tier 2	Tier 3	Tier 1	Tier 2	Tier 3
	60	60	42	207	94	LKT60-42SCZ	\$2,836	\$2,928	\$3,137	\$3,292	\$3,385	\$3,594
	54	54	42	180	86	LKT54-42SCZ	\$2,655	\$2,729	\$2,800	\$3,112	\$3,185	\$3,256
	48	48	42	129	69	LKT48-42SCZ	\$2,524	\$2,643	\$2,775	\$2,982	\$3,099	\$3,231

Features:

- price reflects complete table - top and base
- ships KD in multiple cartons
- one piece top
- model includes adjustable glide
- power cord is routed outside base column
- order vertical wire manager separately; see page 407

Options:

- specify power unit option; None (N), add \$643 for EC23 (CTEC23), add \$533 for EC24 (CTEC24)



top shape

LOK - CONFERENCE

To Order Specify

1 Laminate Model #	2 Edge Detail	3 Laminate Selection	3a PVC Edge Color	4 Electrical	5 Metal Color
Laminate (LKT)	See Edge Detail Options	See Laminate Selection	See PVC Edge Color Options	N None CTEC23 Power Center Top CTEC24 Power Center Top (See chart on next page)	See Metal Finish Color Options

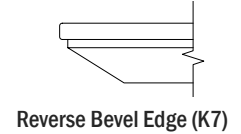
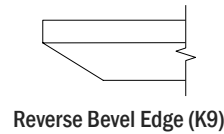
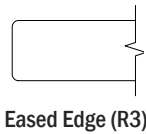
Model Number Breakdown

LKT60-42SCZ					
LK	T	60	42	SC	Z
LOK	Laminate	60" dia.	Height	Squircle Top Shape	X4 Base

Description

Squirrel Table with X4
Base at Bar Height
(continued)

Veneer Tables "LKV" Models	Solid Surface Tables "LKS" Models
-------------------------------	--------------------------------------



	D	W	H	CTN WT	CU FT	① Model	Eased Edge (R3)		Reverse Bevel Edge (K9)		Standard
							Flat Cut	Double Cut	Flat Cut	Double Cut	
VENEER	60	60	42	207	94	LKV60-42SCZ	\$3,705	\$3,944	\$3,844	\$4,095	--
	54	54	42	180	86	LKV54-42SCZ	\$3,507	\$3,743	\$3,642	\$3,889	--
	48	48	42	129	69	LKV48-42SCZ	\$3,058	\$3,205	\$3,144	\$3,296	--
SOLID SURFACE	60	60	42	207	94	LKS60-42SCZ	--	--	--	--	\$8,049
	54	54	42	180	86	LKS54-42SCZ	--	--	--	--	\$7,122
	48	48	42	129	69	LKS48-42SCZ	--	--	--	--	\$6,017

Electrical Options and Upcharges

CTEC23	
EC23 Power Center Top - Black	CTEC23BL - add \$643
EC23 Power Center Top - White	CTEC23WH - add \$643
CTEC24	
EC24 Power Center Top - Black	CTEC43BL - add \$533
EC24 Power Center Top - White	CTEC43WH - add \$533

To Order Specify

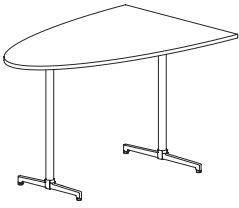
① Veneer Model #	② Edge Detail	③ Wood Species	④ Wood Finish	⑤ Electrical	⑥ Metal Color
Veneer (LKV)	See Edge Detail Options	Flat Cut CH1 Cherry MA1 Maple WA1 Walnut BO1 Black Oak	See Flat Cut Wood Finish Options	N None CTEC23 Power Center Top CTEC24 Power Center Top (See chart above)	See Metal Finish Color Options
		Double Cut DC1 Double Cut	See Double Cut Wood Finish Options		

① Solid Surface Model #	② Top Surface Selection	③ Electrical Cut Out	④ Metal Color
Solid Surface (LKS)	See Solid Surface Top Surface Selection Options	N None CTEC23 Power Center Top CTEC24 Power Center Top (See chart above)	See Metal Finish Color Options

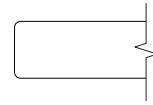
LOK - CONFERENCE

Description

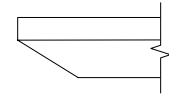
Hive Table with T Base
at Bar Height



**Laminate Tables
"LKT" Models**



Eased Edge (R3)



Reverse Bevel Edge (K9)

Standard	Graded In		Standard	Graded In	
	Tier 1	Tier 2		Tier 3	Tier 1
\$2,228	\$2,271	\$2,534	\$2,722	\$2,765	\$2,954

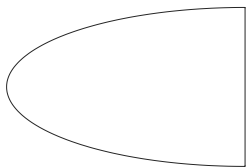
LAM.	D	W	H	CTN WT	CU FT	Model
		48	72	42	138	101

Features:

- price reflects complete table - top and base
- ships KD in multiple cartons
- model includes adjustable glide

Options:

- specify power/charging option, see below for options and upcharges



top shape

LOK - CONFERENCE

To Order Specify

1 Laminate Model #	2 Edge Detail	3 Laminate Selection	3a PVC Edge Color	4 Electrical
Laminate (LKT)	See Edge Detail Options	See Laminate Selection	See PVC Edge Color Options	N None CT2 Dual Power Center Top (See chart on next page) CU1 Single Power Underside 5 Metal Finish See Metal Finish Color Options

Model Number Breakdown

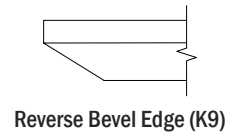
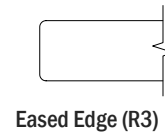
LKT4872-42HVT					
LK	T	4872	42	HV	T
LOK	Laminate	48" x 72"	Height	Hive Top Shape	T base

402 Lok

Description

Hive Table with T Base
at Bar Height
(continued)

Veneer Tables
"LKV" Models



VEN.	D	W	H	CTN WT	CU FT	① Model	Veneer Tables "LKV" Models			
							Flat Cut	Double Cut	Flat Cut	Double Cut
	48	72	42	138	101	LKV4872-42HVT	\$2,803	\$3,026	\$3,054	\$3,252

Electrical Options and Upcharges

CT2	
Dual Power Center Top - Black	CT2BL - add \$1,437
Dual Power Center Top - White	CT2WH - add \$1,437
CU1	
Single Power Underside - Black	CU11C - add \$559
Single Power Underside with Wireless Charging - Black	CU11CW - add \$1,338

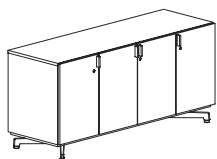
Note: Order power infed that best fits application.

To Order, Specify:

① Veneer Model #	② Edge Detail	③ Wood Species	④ Top Wood Finish	⑤ Electrical	⑥ Metal Color
Veneer (LKV)	See Edge Detail Options	Flat Cut CH1 Cherry MA1 Maple WA1 Walnut BO1 Black Oak	See Flat Cut Wood Finish Options	N None CT2 Dual Power Center Top CU1 Single Power Underside (See chart above)	See Metal Finish Color Options
		Double Cut DC1 Double Cut	④ Top Wood Finish See Double Cut Wood Finish Options		

LOK - CONFERENCE

Description	D	W	H	CTN WT	CU FT	① Model	Laminate	Flat Cut Veneer	Double Cut Veneer
Closed Storage Credenza	20	72	29	343	32	LKT2072-29L777	\$3,274		
	20	72	29	343	32	LKV2072-29L777		\$4,186	\$4,603
	20	60	29	237	28	LKT2060-29L777	\$3,103		
	20	60	29	237	28	LKV2060-29L777		\$3,952	\$4,344



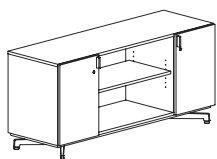
Features:

- model comes with finished top, profiled top available to order separately, see page 444-445
- each compartment has one adjustable shelf
- back access grommet standard at top of each compartment
- door pulls match metal finish selected for column

Options:

- locking doors available, specify and add \$426

Closed/Open Storage Credenza	20	72	29	339	32	LKT2072-29L707	\$3,137		
	20	72	29	339	32	LKV2072-29L707		\$4,013	\$4,414
	20	60	29	230	28	LKT2060-29L707	\$2,974		
	20	60	29	230	28	LKV2060-29L707		\$3,785	\$4,164



Features:

- model comes with finished top, profiled top available to order separately, see page 444-445
- each compartment has one adjustable shelf
- back access grommet standard at top of each compartment
- door pulls match metal finish selected for column

Options:

- locking doors available, specify and add \$284

LOK - CONFERENCE

To Order Specify

Laminate Model #	② Laminate Selection	③ PVC Edge Color
Laminate (LKT)	See Laminate Selection	See PVC Edge Color Options

Model Number Breakdown

LKT2060-29L777				
LK	T	2060	29	L777
LOK	Laminate	20"x60"	Height	Door Configuration

Description	D	W	H	CTN WT	CU FT	① Model	Laminate	Flat Cut Veneer	Double Cut Veneer
Closed Storage Credenza at Counter Height	20	72	36	362	38	LKT2072-36L777	\$3,571		
	20	72	36	362	38	LKV2072-36L777		\$4,562	\$5,018
	20	60	36	303	34	LKT2060-36L777	\$3,384		
	20	60	36	303	34	LKV2060-36L777		\$4,305	\$4,736



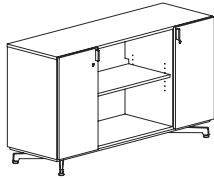
Features:

- model comes with finished top, profiled top available to order separately, see page 444-445
- each compartment has one adjustable shelf
- back access grommet standard at top of each compartment
- door pulls match metal finish selected for column

Options:

- locking doors available, specify and add \$426

Description	D	W	H	CTN WT	CU FT	① Model	Laminate	Flat Cut Veneer	Double Cut Veneer
Closed/Open Storage Credenza at Counter Height	20	72	36	355	38	LKT2072-36L707	\$3,425		
	20	72	36	355	38	LKV2072-36L707		\$4,375	\$4,813
	20	60	36	296	34	LKT2060-36L707	\$3,244		
	20	60	36	296	34	LKV2060-36L707		\$4,127	\$4,538



Features:

- model comes with finished top, profiled top available to order separately, see page 444-445
- each compartment has one adjustable shelf
- back access grommet standard at top of each compartment
- door pulls match metal finish selected for column

Options:

- locking doors available, specify and add \$284

To Order Specify

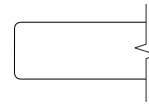
① Veneer Model #	② Wood Species	③ Wood Finish
Veneer (LKV)	Flat Cut CH1 Cherry MA1 Maple WA1 Walnut B01 Black Oak	See Flat Cut Wood Finish Options
	Double Cut DC1 Double Cut	See Double Cut Wood Finish Options

Description

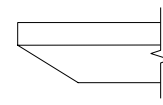
Credenza Cabinet Top



Laminate Tables
"LKT" Models



Eased Edge (R3)

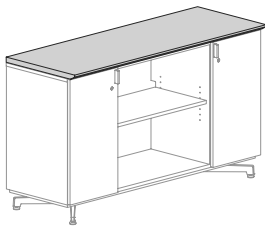


Reverse Bevel Edge (K9)

LAMINATE	D	W	H	CTN WT	CU FT	❶ Model	Standard			Graded In		
							Tier 1	Tier 2	Tier 3	Tier 1	Tier 2	Tier 3
	20	72	1 3/16	55	8	LKT2072TT	\$533	\$554	\$671	\$1,006	\$1,025	\$1,109
20	60	1 3/16	47	7	LKT2060TT	\$470	\$487	\$586	\$938	\$954	\$1,023	

Features:

- edge profile on approach side
- placed on top of storage credenza



LOK - CONFERENCE

To Order Specify

❶ Laminata Model #	❷ Edge Detail	❸ Laminata Selection	❹ PVC Edge Color
Laminata (LKT)	See Edge Detail Options	See Laminata Selection	See PVC Edge Color Options N None CT2 Dual Power Center Top CU2 Dual Power Underside CT2U1 Dual Power Center Top with Underside (See chart on next page)
			See Metal Finish Color Options

Model Number Breakdown

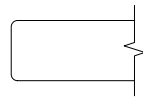
LKT2072TT			
LK	T	2072	TT
LOK	Laminata	20" x 72"	Rectangular Top Shape

Description

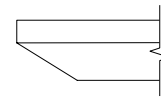
Credenza Cabinet Top
(continued)

Veneer Tables
"LKV" Models

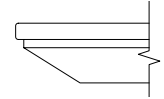
Solid Surface Tables
"LKS" Models



Eased Edge (R3)



Reverse Bevel Edge (K9)



Reverse Bevel Edge (K7)

	D	W	H	CTN WT	CU FT	① Model	Veneer Tables "LKV" Models		Solid Surface Tables "LKS" Models		
							Flat Cut	Double Cut	Flat Cut	Double Cut	Standard
VENEER	20	72	1 3/16	55	8	LKV2072TT	\$822	\$928	\$1,023	\$1,118	--
	20	60	1 3/16	47	7	LKV2060TT	\$754	\$843	\$952	\$1,028	--
SOL SURF	20	72	1 3/16	55	8	LKS2072TT	--	--	--	--	\$2,259
	20	60	1 3/16	47	7	LKS2060TT	--	--	--	--	\$2,052

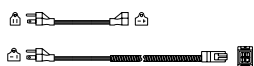
To Order Specify

① Veneer Model #	② Edge Detail	③ Wood Species	④ Wood Finish
Veneer (LKV)	See Edge Detail Options	Flat Cut CH1 Cherry MA1 Maple WA1 Walnut	See Flat Cut Wood Finish Options
		Double Cut DC1 Double Cut	④ Wood Finish See Double Cut Wood Finish Options

① Solid Surface Model #	② Top Surface Selection
Solid Surface (LKS)	See Solid Surface Top Surface Selection Options

Description	D	W	H	CTN WT	CU FT	① Model	List Price
-------------	---	---	---	-----------	----------	---------	------------

3 Prong Plug - 110 Power Infeed				1	1	AP72	\$322
--	--	--	--	---	---	------	-------



Features:

- 72" plug power infeed
- 20 amps/110 volts max
- 3 prong plug - 15 amp adapter plug included
- single circuit use only

Hardwire Power Infeed				1	1	HP72	\$262
------------------------------	--	--	--	---	---	------	-------



Features:

- 72" hardwire power infeed
- 20 amps/120 volts max
- single or double circuit
- electrical contractor responsible for connection to building power source

Quick Disconnect Power Infeed				1	1	MP72	\$241
--------------------------------------	--	--	--	---	---	------	-------



Features:

- must be used with QD1
- 72" modular power infeed
- 20 amps/120 volts max
- single or double circuit

Quick Disconnect Wall Outlet				1	1	QD1	\$123
-------------------------------------	--	--	--	---	---	-----	-------



Features:

- must be used with MP72
- works for both single or double circuit
- 20 amps/120 volts max
- electrical contractor responsible for connection to building power source

Vertical Wire Manager	½	2 ¼	33	1	1	AVL33	\$138
------------------------------	---	-----	----	---	---	-------	-------



½	2 ¼	25	1	1	AVL25	\$104
½	2 ¼	22	1	1	AVL20	\$85
½	2 ¼	17	1	1	AVL17	\$80

Features:

- field installed
- use AVL33 for 42"h tables with disk base
- use AVL25 for 42"h tables
- use AVL20 for 36"h tables
- use AVL17 for 29"h tables

Options:

- specify plastic color, Black (B) or Silver (S)

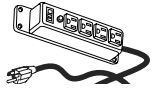
Flexible Vertical Wire Manager	1 ½	1 ½	45	4	1	45VWM	\$131
---------------------------------------	-----	-----	----	---	---	-------	-------



Features:

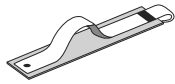
- black plastic
- field installed to bottom of table top, with screws provided
- wire manager is 1 ½" diameter
- weighted base is 4" diameter
- length can be adjusted by removing individual discs as required

Description	D	W	H	CTN WT	CU FT	Model	List Price
Power Strip	1 1/2	1 7/8	8	3	1	GP9ACP1-0212	\$93



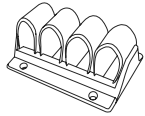
- Features:**
- power surge with 10" cord
 - four electrical outlets
 - includes switch
 - field installed

Wire Management Velcro Straps	1 3/4	3 1/2	1/4	1	1	04WVS	\$56
--------------------------------------	-------	-------	-----	---	---	-------	------



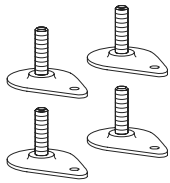
- Features:**
- black, set of 4
 - field installed to bottom of table top, with adhesive tape provided

Cable Management Clips	2 5/8	3 3/4	1 5/8	1	1	0304CMC	\$54
-------------------------------	-------	-------	-------	---	---	---------	------



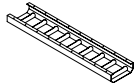
- Features:**
- black plastic
 - installed to bottom of table top
 - four retention loops

Floor Mount Glide	3	2 1/4	1/2	1	1	LKB516-18ANCHOR	\$41
--------------------------	---	-------	-----	---	---	-----------------	------



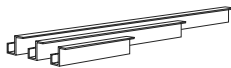
- Features:**
- field installed glides for mounting table base to floor
 - 1/4" diameter hole in the glide for mounting
 - set of 4
 - table can be leveled before attached to floor
 - floor attachment hardware provided by installer
 - glide threads 3/8"-16

Wire Management Tray	7 1/2	45	3	8	2	GP9WMT1-0845	\$270
	7 1/2	35	3	6	1	GP9WMT1-0835	\$228
	7 1/2	25	3	4	1	GP9WMT1-0825	\$185



- Features:**
- silver powder-coated finish
 - four hanging brackets (CI2C00)

Wire Manager Trough	2 1/2	36	2 1/2	4	1	36WCT	\$152
	2 1/2	24	2 1/2	3	1	24WCT	\$138
	2 1/2	12	2 1/2	2	1	12WCT	\$119

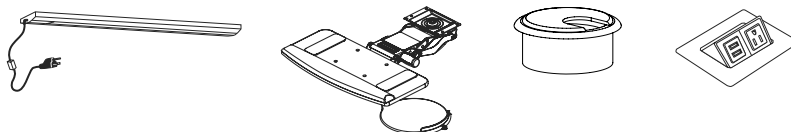


- Features:**
- black plastic
 - field installed to bottom of table top, with screws provided

Accessories/ Keyboard/ Tasklights

For an additional list of electrical units, grommets, keyboards, wire management, monitor arms & telecom jacks, please see our [accessories price list](#)

Contact your customer service representative for specific questions regarding which units can be used with Lok Conferencing.



Page left intentionally blank

Lounge - Table of Contents



Lok - Lounge

Product Information

Lounge Overview 410
 Tables Shapes & Sizes 415-416
 Laminate Specifications 413
 Veneer Specifications 414
 Solid Surface Specifications 414
 Base Styles - Features 417
 Electrical Planning - Options 417

Pricing Pages

Lounge Tables at 16" Height 418-435
 Lounge Tables at 26" Height 436-453
 Electrical 454

Lounge - Overview



rectangular
16 "H - Page 448
26""H - Page 464



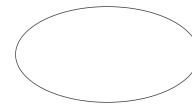
rounded rectangular
16 "H - Page 450



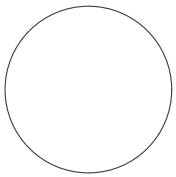
arc rectangular
16 "H - Page 452



rounded arc
rectangular
16 "H - Page 454



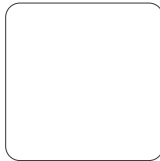
oval
16 "H - Page 456
26""H - Page 466



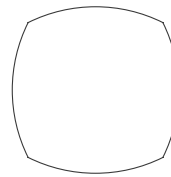
round
16 "H - Page 458
26""H - Page 468



square
26""H - Page 470



rounded square
16 "H - Page 460
26""H - Page 472

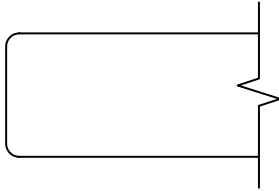


squircle
16 "H - Page 462
26""H - Page 474

Lounge - Materials

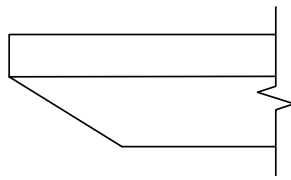
Laminate Tops

Lok training table worksurfaces are offered in HPL (High Pressure Laminate) The tops are 1 3/16" thick, 3 ply balanced construction. Particle board core and a phenolic backer sheet complete the balanced construction.



Eased Edge (R3)

PVC



Reverse Bevel (K9)

PVC on painted top of painted MDF

Standard PVC Edge Colors

JSI supports 24 standard PVC edge colors listed below. These coordinate with our Standard (Tier1) Laminates.

When selecting a Standard (Tier 1) Laminate, the coordinating PVC edge color is automatically applied. When selecting a Graded-In Laminate (Tier 2 or 3), you will be prompted to choose one these 24 PVC edge colors to be applied to the edge.

ALB Alabaster	GRH Graphite
ALL Ale Light	MIN Mineral
BLK Black	OAT Oatmeal Cookie
BOL Bourbon Light	PIN Pinnacle Walnut
BZW Brazilwood	PLT Platinum
BBL Bridal Blanco	SHD Shadow
BGL Brighton Light	SLG Slate Grey
CLL Collectors	STU Studio Teak
DWH Designer White	UMB Umber
DOV Dove Grey	VAL Valley
FAW Fawn	VIN Vintage
FLO Florence Walnut	WEA Weathered Ash

Standard Laminates

JSI Standard Laminate program consists of 22 solid and wood grain patterns, and establish our Tier 1 laminate pricing. Each has a coordinating PVC edge color that is automatically used with the Standard Laminates.

Wood Grain Laminate

ALL Ale Light	MIN Mineral
BOL Bourbon Light	OAT Oatmeal Cookie
BZW Brazilwood	PIN Pinnacle Walnut
BGL Brighton Light	STU Studio Teak
CLL Collectors	UMB Umber
FAW Fawn	VAL Valley
FLO Florence Walnut	VIN Vintage
GRH Graphite	WEA Weathered Ash

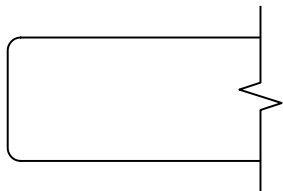
Solid Laminate

ALB Alabaster
BLK Black
BBL Bridal Blanco
DWH Designer White
SHD Shadow
SLG Slate Grey

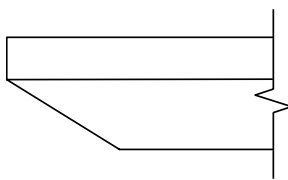
Lounge - Materials

Veneer Tops

Tops are 1 3/8" thick, 5 ply balanced construction with particle board core. Standard Tier 1 veneer is flat cut, book matched for cherry, maple and walnut veneer. Standard Tier 2 veneer is double cut.



Eased Edge (R3)
Internal Lumber Band



Reverse Bevel (K9)
Veneer Band on Stained MDF

Finish - Stain/Colors

CH1 Cherry	<i>Flat Cut Veneer</i>		
BBM Bourbon Medium	CLL Collectors		
BRM Brighton Medium	HRV Harvest		
CLA Classic	PRL Praline		

MA1 Maple	<i>Flat Cut Veneer</i>		
ALM Ale Medium	FLX Flax		
BUT Butterscotch	VEN Venetian		

WA1 Walnut	<i>Flat Cut Veneer</i>		
ESP Espresso	TRF Truffle		
MCH Mocha	UMB Umber		
SIE Sienna			

B01 Black Oak	<i>Flat Cut Veneer</i>		
RAV Raven			

DC1 Double Cut Veneer			
BAR Barrel - Oak Pattern	KHK Khaki		
BUF Buff - Oak Pattern	MIN Mineral - Oak Pattern		
CND Cinder - Oak Pattern	RYE Rye - Oak Pattern		
COF Coffee	SAB Sable - Oak Pattern		
EGR Egret	SAD Saddle - Oak Pattern		
FAW Fawn	STU Studio Teak		
GRH Graphite	VAL Valley		

Protective Top Coat

DuraTex™ offers exceptional hardness along with abrasion and impact resistance, it has been formulated to eliminate hazardous and harmful gases that are normally associated with wood finish.

DuraTex™ Features

Safety - Significantly reduces hazardous formaldehyde emissions which help improve the quality of the of the indoor air we breathe.

Quality - Developed to be tough and durable with special attention to appearance. The DuraTex™ finish preserves the natural beauty of wood.

Durability - Designed to meet a wide range of demanding performance and environmental standards to withstand even the highest wear and tear.

Special Finishes

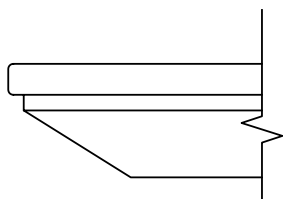
Special finishes can be requested by contacting customer service. There is a one time charge of \$372 list per order.

Finish Sheen

All veneer finishes are standard in 35-sheen, with the exception of Raven. Raven is only offered in 15 sheen. All other finishes can have their sheen modified with a 15% upcharge added to the list price of each item.

Solid Surface Tops

Tops are 1 3/8" thick constructed of 1/2" thick Solid Surface on top of a 1/8" MDF sub top. Sub top has an under cut bevel profile and is painted in a coordinated color to match the Solid Surface.







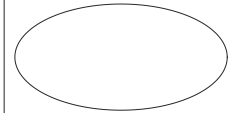
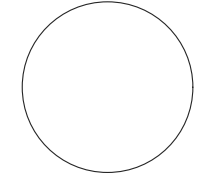
Standard Solid Surface

ARM	Armadillo
BLP	Black Pearl
PEB	Pebble Pearl
PUR	Pure White

Reverse Bevel Edge (K7)
Solid Surface over painted MDF

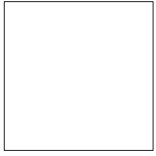
Lounge -Top Shapes

Lok offers 9 lounge table top shapes. Tables are available in 16", 20" or 26" high and in laminate, veneer or solid surface. Compatible bases are: X Base or Y Base.

					
rectangular	rounded rectangular	arc rectangular	rounded arc rectangular	oval	round
16"h	16"h	16"h	16"h	16"h	16"h
24" x 48" 30" x 48"	24" x 48" 30" x 48"	24" x 48" 30" x 48"	24" x 48" 30" x 48"	30" x 48"	24" 30" 36" 42"
26"h	26"h	26"h	26"h	26"h	26"h
24" x 48" 30" x 48"	24" x 48" 30" x 48"	24" x 48" 30" x 48"	24" x 48" 30" x 48"	30" x 48"	24" 30" 36" 42"

Lounge - Top Shapes

Lok offers 9 lounge table top shapes. Tables are available in 16", 20" or 26" high and in laminate, veneer or solid surface. Compatible bases are: X Base, or Y Base.



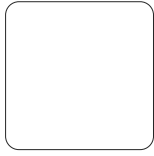
square

16"h

24" x 24"
30" x 30"
36" x 36"

26"h

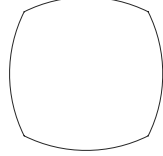
24" x 24"
30" x 30"
36" x 36"



rounded square

26"h

24" x 24"
30" x 30"
36" x 36"



squircle

16"h

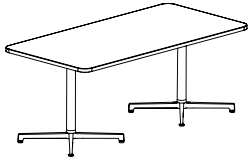
24" x 24"
30" x 30"
36" x 36"

26"h

24" x 24"
30" x 30"
36" x 36"

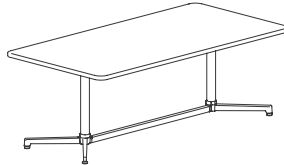
Lounge- Base Styles

Lok provides a choice selection of bases in both function and aesthetics to serve a variety of needs. The conferencing offering includes: X-base and Y-Base.



X-Base

- available 16"h, 20"h or 26"h only in glides.
- compatible with the following top shapes: round, square, squircle
- base finish aged bronze, arctic silver, gold, pewter, matte black, soft bronze, soft nickel
- two-tone base aesthetics are achieved when selecting polished aluminum foot, and then any of the other finishes on the column
- power access version, with integrated wire management available with an upcharge

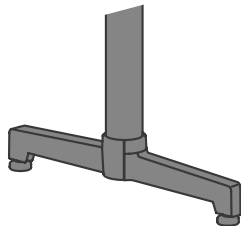


Y Base

- available in 16"h or 26"h only in glides
- compatible with the following top shapes: : arc rectangular, oval
- base finish aged bronze, arctic silver, gold, pewter, matte black, soft bronze, soft nickel
- two-tone base aesthetics are achieved when selecting polished aluminum foot, and then any of the other finishes on the column

Single Metal Finish

- ABZ** Aged Bronze Feet & Post
- ASL** Arctic Silver Feet & Post
- GLD** Gold Feet & Post
- PEW** Pewter Feet & Post
- MBK** Matte Black Feet & Post
- SBZ** Soft Bronze Feet & Post
- SNK** Soft Nickel Feet & Post

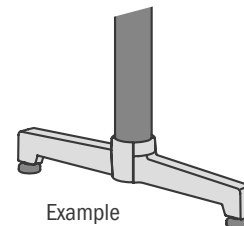


Two - Tone Metal Finish

Two-Tone Aesthetics can be achieved by specifying Polished Aluminum on the foot and a contrasting finish on the post

Polished Aluminum Feet

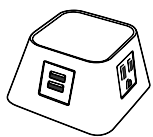
- ABZ** - Aged Bronze Post
- ASL** - Arctic Silver Post
- GLD** - Gold Post
- PEW** - Pewter Post
- MBK** - Matte Black Post
- SBZ** - Soft Bronze Post
- SNK** - Soft Nickel Post



Example

Power/Charging Options

Lok offers the ability to place power and charging options in the center of select tables. Select your choice of EC23 or EC24, available in black and white.



Moire - EC23

- Three 110 outlets
- Dual USB port with 72" power cord
- Black (B) or White (W)

select CTEC23 for cutout in worksurfaces

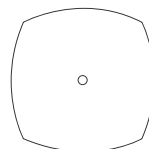
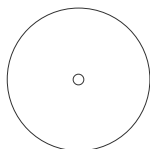
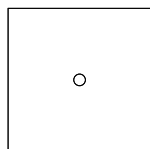
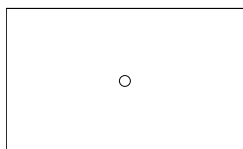


Node - EC24

- One 110 outlet
- Dual USB port with 72" power cord
- Black (B) or White (W)

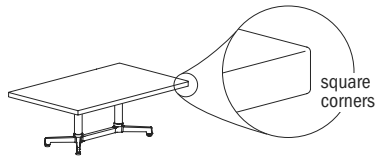
select CTEC24 for cutout in worksurfaces

Cut outs are located in the center of each table. See below for representation or location.

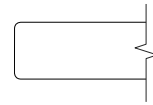


Description

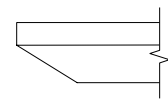
Rectangular Table with Y
Base at 16" Lounge Height



**Laminate Tables
"LKT" Models**



Eased Edge (R3)



Reverse Bevel Edge (K9)

LAMINATE	D	W	H	CTN WT	CU FT	❶ Model	Standard			Graded In		
							Tier 1	Tier 2	Tier 3	Tier 1	Tier 2	Tier 3
	30	48	16	79	18	LKT3048-16TTY	\$1,628	\$1,646	\$1,754	\$2,078	\$2,098	\$2,177
24	48	16	74	16	LKT2448-16TTY	\$1,562	\$1,575	\$1,666	\$2,006	\$2,022	\$2,085	

Features:

- price reflects complete table - top and base
- ships KD in multiple cartons
- model includes adjustable glide
- power cord is routed outside base column
- order vertical wire manager separately; see page 454

Options:

- specify power unit option; None (N), add \$643 for EC23 (CTEC23), add \$533 for EC24 (CTEC24)



top shape

To Order Specify

❶ Laminate Model #	❷ Edge Detail	❸ Laminate Selection	❹ PVC Edge Color	❺ Electrical	❻ Metal Color
Laminate (LKT)	See Edge Detail Options	See Laminate Selection	See PVC Edge Color Options	N None CTEC23 Power Center Top CTEC24 Power Center Top (See chart on next page)	See Metal Finish Color Options

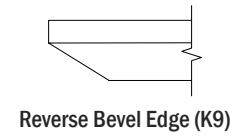
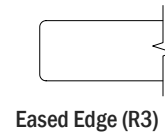
Model Number Breakdown

LKT3048-16TTY					
LK	T	3048	16	TT	Y
LOK	Laminate	30" x 48"	Height	Rectangular Top Shape	Y base

Description

Rectangular Table with Y
Base at 16" Lounge Height
(continued)

Veneer Tables
"LKV" Models



VENEER	D	W	H	CTN WT	CU FT	1 Model	Flat Cut	Double Cut	Flat Cut	Double Cut
	30	48	16	79	18	LKV3048-16TTY	\$1,900	\$2,001	\$2,096	\$2,182
24	48	16	74	16	LKV2448-16TTY	\$1,832	\$1,914	\$2,019	\$2,089	

Electrical Options and Upcharges

CTEC23	
EC23 Power Center Top - Black	CTEC23BL - add \$643
EC23 Power Center Top - White	CTEC23WH - add \$643
CTEC24	
EC24 Power Center Top - Black	CTEC43BL - add \$533
EC24 Power Center Top - White	CTEC43WH - add \$533

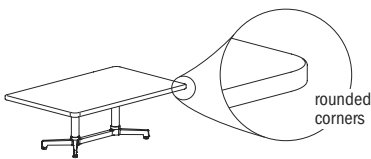
To Order Specify

1 Veneer Model #	2 Edge Detail	3 Wood Species	4 Wood Finish	5 Electrical	6 Metal Color
Veneer (LKV)	R3 Eased K9 Reverse Bevel	Flat Cut CH1 Cherry MA1 Maple WA1 Walnut BO1 Black Oak	See Flat Cut Wood Finish Options	N None CTEC23 Power Center Top CTEC24 Power Center Top (See chart above)	See Metal Finish Color Options
	Double Cut DC1 Double Cut	See Double Cut Wood Finish Options			

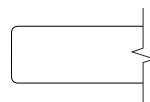
LOK - LOUNGE

Description

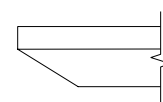
Rounded Rectangular Table with Y Base at 16" Lounge Height



Laminate Tables "LKT" Models



Eased Edge (R3)



Reverse Bevel Edge (K9)

LAMINATE	D	W	H	CTN WT	CU FT	Model	Eased Edge (R3)		Reverse Bevel Edge (K9)			
							Standard	Graded In	Standard	Graded In		
							Tier 1	Tier 2	Tier 3	Tier 1	Tier 2	Tier 3
	30	48	16	79	18	LKT3048-16TTRY	\$1,691	\$1,708	\$1,833	\$2,144	\$2,165	\$2,253
	24	48	16	69	16	LKT2448-16TTRY	\$1,598	\$1,613	\$1,701	\$2,044	\$2,058	\$2,121

Features:

- price reflects complete table - top and base
- ships KD in multiple cartons
- model includes adjustable glide
- power cord is routed outside base column
- order vertical wire manager separately; see page 454

Options:

- specify power unit option; None (N), add \$643 for EC23 (CTEC23), add \$533 for EC24 (CTEC24)



top shape

To Order Specify

1 Laminate Model #	2 Edge Detail	3 Laminate Selection	3a PVC Edge Color	4 Electrical	5 Metal Color
Laminate (LKT)	See Edge Detail Options	See Laminate Selection	See PVC Edge Color Options	N None CTEC23 Power Center Top CTEC24 Power Center Top (See chart on next page)	See Metal Finish Color Options

Model Number Breakdown

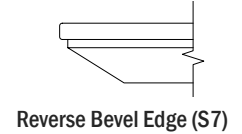
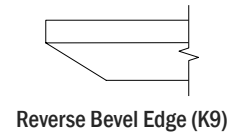
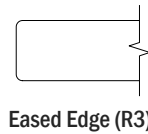
LKT3048-16TTRY						
LK	T	3048	16	TT	R	Y
LOK	Laminate	30" x 48"	Height	Rectangular Top Shape	Rounded Corner	Y Base

Description

Rounded Rectangular Table with Y Base at 16" Lounge Height (continued)

Veneer Tables "LKV" Models

Solid Surface Tables "LKS" Models



	D	W	H	CTN WT	CU FT	① Model	Veneer Tables "LKV" Models		Solid Surface Tables "LKS" Models		
							Flat Cut	Double Cut	Flat Cut	Double Cut	Standard
VENEER	30	48	16	79	18	LKV3048-16TTRY	\$1,956	\$2,067	\$2,154	\$2,251	--
	24	48	16	69	16	LKV2448-16TTRY	\$1,870	\$1,949	\$2,055	\$2,127	--
SOL. SURF.	30	48	16	79	18	LKS3048-16TTRY	--	--	--	--	\$3,965
	24	48	16	69	16	LKS2448-16TTRY	--	--	--	--	\$2,947

Electrical Options and Upcharges

CTEC23	
EC23 Power Center Top - Black	CTEC23BL - add \$643
EC23 Power Center Top - White	CTEC23WH - add \$643
CTEC24	
EC24 Power Center Top - Black	CTEC24BL - add \$533
EC24 Power Center Top - White	CTEC24WH - add \$533

To Order Specify

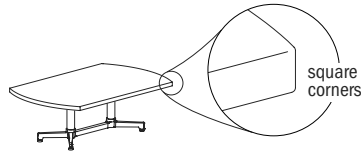
① Veneer Model #	② Edge Detail	③ Wood Species	④ Wood Finish	⑤ Electrical	⑥ Metal Color
Veneer (LKV)	See Edge Detail Options	Flat Cut CH1 Cherry MA1 Maple WA1 Walnut BO1 Black Oak	See Flat Cut Wood Finish Options	N None CTEC23 Power Center Top CTEC24 Power Center Top (See chart above)	See Metal Finish Color Options
		Double Cut DC1 Double Cut	See Double Cut Wood Finish Options		

① Solid Surface Model #	② Top Surface Selection	③ Electrical Cut Out	④ Metal Color
Solid Surface (LKS)	See Solid Surface Top Surface Selection Options	N None CTEC23 Power Center Top CTEC24 Power Center Top (See chart above)	See Metal Finish Color Options

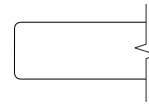
LOK - LOUNGE

Description

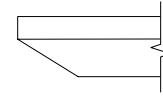
Arc Rectangular Table with Y
Base at 16" Lounge Height



Laminate Tables
"LKT" Models



Eased Edge (R3)



Reverse Bevel Edge (K9)

LAMINATE	D	W	H	CTN WT	CU FT	❶ Model	Standard			Graded In		
							Tier 1	Tier 2	Tier 3	Tier 1	Tier 2	Tier 3
	30	48	16	75	18	LKT3048-16ARY	\$1,691	\$1,708	\$1,833	\$2,144	\$2,165	\$2,253
24	48	16	67	16	LKT2448-16ARY	\$1,598	\$1,613	\$1,701	\$2,044	\$2,058	\$2,121	

Features:

- price reflects complete table - top and base
- ships KD in multiple cartons
- model includes adjustable glide
- power cord is routed outside base column
- order vertical wire manager separately; see page 454

Options:

specify power unit option; None (N), add \$643 for EC23 (CTEC23), add \$533 for EC24 (CTEC24)



top shape

To Order Specify

❶ Laminate Model #	❷ Edge Detail	❸ Laminate Selection	❹ PVC Edge Color	❺ Electrical	❻ Metal Color
Laminate (LKT)	See Edge Detail Options	See Laminate Selection	See PVC Edge Color Options	N None CTEC23 Power Center Top CTEC24 Power Center Top (See chart on next page)	See Metal Finish Color Options

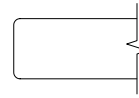
Model Number Breakdown

LKT3048-16ARY					
LK	T	3048	16	AR	Y
LOK	Laminate	30" x 48"	Height	Arc Rectangular Top Shape	Y base

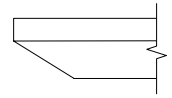
Description

Arc Rectangular Table with Y Base
at 16" Lounge Height
(continued)

Veneer Tables
"LKV" Models



Eased Edge (R3)



Reverse Bevel Edge (K9)

VENEER	D	W	H	CTN WT	CU FT	① Model	Flat Cut	Double Cut	Flat Cut	Double Cut
	30	48	16	75	18	LKV3048-16ARY	\$1,956	\$2,067	\$2,154	\$2,251
24	48	16	67	16	LKV2448-16ARY	\$1,870	\$1,949	\$2,055	\$2,127	

Electrical Options and Upcharges

CTEC23	
EC23 Power Center Top - Black	CTEC23BL - add \$643
EC23 Power Center Top - White	CTEC23WH - add \$643
CTEC24	
EC24 Power Center Top - Black	CTEC43BL - add \$533
EC24 Power Center Top - White	CTEC43WH - add \$533

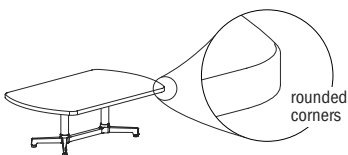
To Order Specify

① Veneer Model #	② Edge Detail	③ Wood Species	④ Wood Finish	⑤ Electrical	⑥ Metal Color
Veneer (LKV)	R3 Eased K9 Reverse Bevel	Flat Cut CH1 Cherry MA1 Maple WA1 Walnut BO1 Black Oak	See Flat Cut Wood Finish Options	N None CTEC23 Power Center Top CTEC24 Power Center Top (See chart above)	See Metal Finish Color Options
	Double Cut DC1 Double Cut	④ Wood Finish See Double Cut Wood Finish Options			

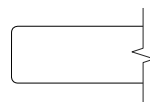
LOK - LOUNGE

Description

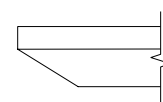
Rounded Arc Rectangular Table with Y Base at 16" Lounge Height



Laminate Tables "LKT" Models



Eased Edge (R3)



Reverse Bevel Edge (K9)

LAMINATE	D	W	H	CTN WT	CU FT	Model	Standard Tier 1	Graded In Tier 2	Graded In Tier 3	Standard Tier 1	Graded In Tier 2	Graded In Tier 3
	30	48	16	75	18	LKT3048-16ARRY	\$1,691	\$1,708	\$1,833	\$2,144	\$2,165	\$2,253
	24	48	16	67	16	LKT2448-16ARRY	\$1,598	\$1,613	\$1,701	\$2,044	\$2,058	\$2,121

Features:

- price reflects complete table - top and base
- ships KD in multiple cartons
- model includes adjustable glide
- power cord is routed outside base column
- order vertical wire manager separately; see page 454

Options:

- specify power unit option; None (N), add \$643 for EC23 (CTEC23), add \$533 for EC24 (CTEC24)



top shape

To Order Specify

1 Laminate Model #	2 Edge Detail	3 Laminate Selection	3a PVC Edge Color	4 Electrical	5 Metal Color
Laminate (LKT)	See Edge Detail Options	See Laminate Selection	See PVC Edge Color Options	N None CTEC23 Power Center Top CTEC24 Power Center Top (See chart on next page)	See Metal Finish Color Options

Model Number Breakdown

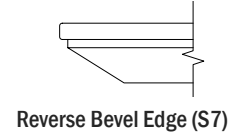
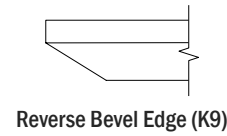
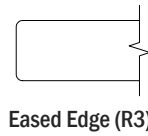
LKT3048-16ARRY						
LK	T	3048	16	AR	R	Y
LOK	Laminate	30" x 48"	Height	Arc Rectangular Top Shape	Rounded Corner	Y Base

Description

Rounded Arc Rectangular Table with Y Base at 16" Lounge Height (continued)

Veneer Tables "LKV" Models

Solid Surface Tables "LKS" Models



	D	W	H	CTN WT	CU FT	① Model	Veneer Tables "LKV" Models		Solid Surface Tables "LKS" Models		
							Flat Cut	Double Cut	Flat Cut	Double Cut	Standard
VENEER	30	48	16	75	18	LKV3048-16ARRY	\$1,956	\$2,067	\$2,154	\$2,251	--
	24	48	16	67	16	LKV2448-16ARRY	\$1,870	\$1,949	\$2,055	\$2,127	--
SOLID SURF.	30	48	16	75	18	LKS3048-16ARRY	--	--	--	--	\$3,965
	24	48	16	67	16	LKS2448-16ARRY	--	--	--	--	\$2,947

Electrical Options and Upcharges

CTEC23	
EC23 Power Center Top - Black	CTEC23BL - add \$643
EC23 Power Center Top - White	CTEC23WH - add \$643
CTEC24	
EC24 Power Center Top - Black	CTEC24BL - add \$533
EC24 Power Center Top - White	CTEC24WH - add \$533

To Order Specify

① Veneer Model #	② Edge Detail	③ Wood Species	④ Wood Finish	⑤ Electrical	⑥ Metal Color
Veneer (LKV)	See Edge Detail Options	Flat Cut CH1 Cherry MA1 Maple WA1 Walnut BO1 Black Oak	See Flat Cut Wood Finish Options	N None CTEC23 Power Center Top CTEC24 Power Center Top (See chart above)	See Metal Finish Color Options
		Double Cut DC1 Double Cut	④ Wood Finish See Double Cut Wood Finish Options		

① Solid Surface Model #	② Top Surface Selection	③ Electrical Cut Out	④ Metal Color
Solid Surface (LKS)	See Solid Surface Top Surface Selection Options	N None CTEC23 Power Center Top CTEC24 Power Center Top (See chart above)	See Metal Finish Color Options

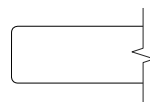
LOK - LOUNGE

Description

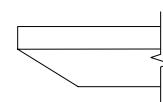
Oval Table with Y Base at 16" Lounge Height



Laminate Tables
"LKT" Models



Eased Edge (R3)



Reverse Bevel Edge (K9)

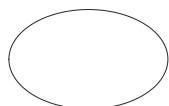
LAM.	D	W	H	CTN WT	CU FT	① Model	Standard			Graded In		
							Tier 1	Tier 2	Tier 3	Tier 1	Tier 2	Tier 3
	30	48	16	68	18	LKT3048-160VY	\$1,672	\$1,696	\$1,818	\$2,129	\$2,150	\$2,239

Features:

- price reflects complete table - top and base
- ships KD in multiple cartons
- model includes adjustable glide
- power cord is routed outside base column
- order vertical wire manager separately; see page 454

Options:

- specify power unit option; None (N), add \$643 for EC23 (CTEC23), add \$533 for EC24 (CTEC24)



top shape

To Order Specify

① Laminate Model #	② Edge Detail	③ Laminate Selection	④ PVC Edge Color	⑤ Electrical	⑥ Metal Color
Laminate (LKT)	See Edge Detail Options	See Laminate Selection	See PVC Edge Color Options	N None CTEC23 Power Center Top CTEC24 Power Center Top (See chart on next page)	See Metal Finish Color Options

Model Number Breakdown

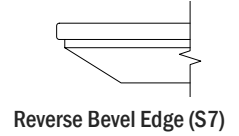
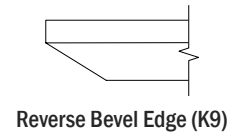
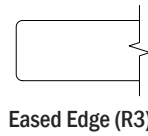
LKT3048-160VY					
LK	T	3048	16	OV	Y
LOK	Laminate	30" x 48"	Height	Oval Top Shape	Y base

Description

Oval Table with Y Base at 16"
Lounge Height
(continued)

Veneer Tables
"LKV" Models

Solid Surface Tables
"LKS" Models



	D	W	H	CTN WT	CU FT	① Model	Eased Edge (R3)		Reverse Bevel Edge (K9)		Reverse Bevel Edge (S7)
							Flat Cut	Double Cut	Flat Cut	Double Cut	
VEN.	30	48	16	68	18	LKV3048-160VY	\$1,942	\$2,052	\$2,139	\$2,238	--
S.S.	30	48	16	68	18	LKS3048-160VY	--	--	--	--	\$3,952

Electrical Options and Upcharges

CTEC23	
EC23 Power Center Top - Black	CTEC23BL - add \$643
EC23 Power Center Top - White	CTEC23WH - add \$643
CTEC24	
EC24 Power Center Top - Black	CTEC43BL - add \$533
EC24 Power Center Top - White	CTEC43WH - add \$533

To Order Specify

① Veneer Model #	② Edge Detail	③ Wood Species	④ Wood Finish	⑤ Electrical	⑥ Metal Color
Veneer (LKV)	See Edge Detail Options	Flat Cut CH1 Cherry MA1 Maple WA1 Walnut BO1 Black Oak	See Flat Cut Wood Finish Options	N None CTEC23 Power Center Top CTEC24 Power Center Top (See chart above)	See Metal Finish Color Options
		Double Cut DC1 Double Cut	④ Wood Finish See Double Cut Wood Finish Options		

① Solid Surface Model #	② Top Surface Selection	③ Electrical Cut Out	④ Metal Color
Solid Surface (LKS)	See Solid Surface Top Surface Selection Options	N None CTEC23 Power Center Top CTEC24 Power Center Top (See chart above)	See Metal Finish Color Options

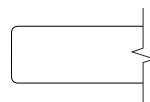
LOK - LOUNGE

Description

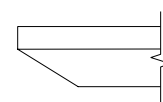
Round Table with X Base at 16" Lounge Height



Laminate Tables "LKT" Models



Eased Edge (R3)



Reverse Bevel Edge (K9)

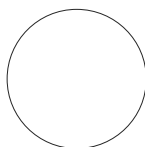
LAMINATE	D	W	H	CTN WT	CU FT	Model	Eased Edge (R3)			Reverse Bevel Edge (K9)		
							Standard	Graded In		Standard	Graded In	
							Tier 1	Tier 2	Tier 3	Tier 1	Tier 2	Tier 3
	42	42	16	68	18	LKT42-16RDX	\$1,315	\$1,422	\$1,510	\$1,732	\$1,839	\$1,926
	36	36	16	55	17	LKT36-16RDX	\$1,213	\$1,229	\$1,332	\$1,665	\$1,680	\$1,750
	30	30	16	43	13	LKT30-16RDX	\$1,213	\$1,248	\$1,285	\$1,626	\$1,661	\$1,698
	24	24	16	35	12	LKT24-16RDX	\$977	\$989	\$1,046	\$1,419	\$1,427	\$1,469

Features:

- price reflects complete table - top and base
- ships KD in multiple cartons
- model includes adjustable glide
- when electrical option is selected, power accessible base is shipped; see page 417 for details
- power/charging units have 72" cord
- power cord is routed inside base column

Options:

- specify power access base with power unit option; None (N), add \$643 for EC23 (CTEC23), add \$533 for EC24 (CTEC24)



top shape

To Order Specify

1 Laminate Model #	2 Edge Detail	3 Laminate Selection	3a PVC Edge Color	4 Electrical	5 Metal Color
Laminate (LKT)	See Edge Detail Options	See Laminate Selection	See PVC Edge Color Options	N None CTEC23 Power Center Top CTEC24 Power Center Top (See chart on next page)	See Metal Finish Color Options

Model Number Breakdown

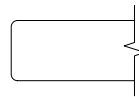
LKT42-16RDX					
LK	T	42	16	RD	X
LOK	Laminate	42" dia.	Height	Round Top Shape	X base

Description

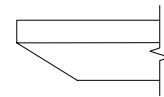
Round Table with X Base at
16" Lounge Height
(continued)

Veneer Tables
"LKV" Models

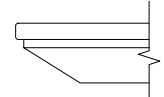
Solid Surface Tables
"LKS" Models



Eased Edge (R3)



Reverse Bevel Edge (K9)



Reverse Bevel Edge (S7)

	D	W	H	CTN WT	CU FT	① Model	Veneer Tables "LKV" Models		Solid Surface Tables "LKS" Models		
							Flat Cut	Double Cut	Flat Cut	Double Cut	Standard
VENEER	42	42	16	68	18	LKV42-16RDX	\$1,672	\$1,798	\$1,883	\$1,996	--
	36	36	16	55	17	LKV36-16RDX	\$1,511	\$1,605	\$1,709	\$1,793	--
	30	30	16	43	13	LKV30-16RDX	\$1,490	\$1,563	\$1,698	\$1,760	--
	24	24	16	35	12	LKV24-16RDX	\$1,234	\$1,289	\$1,412	\$1,460	--
SOLID SURFACE	42	42	16	91	18	LKS42-16RDX	--	--	--	--	\$3,965
	36	36	16	71	17	LKS36-16RDX	--	--	--	--	\$3,307
	30	30	16	54	13	LKS30-16RDX	--	--	--	--	\$2,872
	24	24	16	41	12	LKS24-16RDX	--	--	--	--	\$2,354

Electrical Options and Upcharges

CTEC23	
EC23 Power Center Top - Black	CTEC23BL - add \$738
EC23 Power Center Top - White	CTEC23WH - add \$738
CTEC24	
EC24 Power Center Top - Black	CTEC43BL - add \$632
EC24 Power Center Top - White	CTEC43WH - add \$632

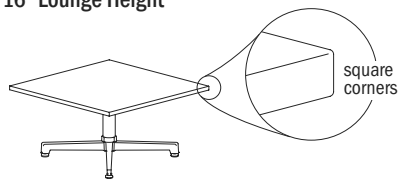
To Order Specify

① Veneer Model #	② Edge Detail	③ Wood Species	④ Wood Finish	⑤ Electrical	⑥ Metal Color
Veneer (LKV)	R3 Eased K9 Reverse Bevel	Flat Cut CH1 Cherry MA1 Maple WA1 Walnut BO1 Black Oak	See Flat Cut Wood Finish Options	N None CTEC23 Power Center Top CTEC24 Power Center Top (See chart above)	See Metal Finish Color Options
	Double Cut DC1 Double Cut	See Double Cut Wood Finish Options			

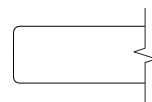
LOK - LOUNGE

Description

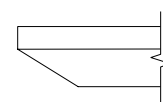
Square Table with X Base at 16" Lounge Height



Laminate Tables "LKT" Models



Eased Edge (R3)



Reverse Bevel Edge (K9)

LAMINATE	D	W	H	CTN WT	CU FT	Model	Eased Edge (R3)			Reverse Bevel Edge (K9)		
							Standard	Graded In		Standard	Graded In	
							Tier 1	Tier 2	Tier 3	Tier 1	Tier 2	Tier 3
	36	36	16	65	17	LKT3636-16SQX	\$1,174	\$1,192	\$1,291	\$1,626	\$1,643	\$1,712
	30	30	16	50	13	LKT3030-16SQX	\$1,179	\$1,195	\$1,274	\$1,684	\$1,698	\$1,752
	24	24	16	38	9	LKT2424-16SQX	\$913	\$918	\$963	\$1,339	\$1,345	\$1,377

Features:

- price reflects complete table - top and base
- ships KD in multiple cartons
- model includes adjustable glide
- when electrical option is selected, power accessible base is shipped; see page 417 for details
- power/charging units have 72" cord
- power cord is routed inside base column

Options:

- specify power access base with power unit option; None (N), add \$738 for EC23 (CTEC23), add \$632 for EC24 (CTEC24)



top shape

To Order Specify

1 Laminate Model #	2 Edge Detail	3 Laminate Selection	3a PVC Edge Color	4 Electrical	5 Metal Color
Laminate (LKT)	See Edge Detail Options	See Laminate Selection	See PVC Edge Color Options	N None CTEC23 Power Center Top CTEC24 Power Center Top (See chart on next page)	See Metal Finish Color Options

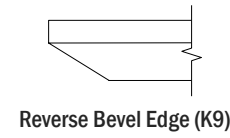
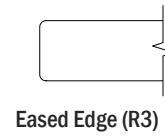
Model Number Breakdown

LKT3636-16SQX					
LK	T	3636	16	SQ	X
LOK	Laminate	36" x 36"	Height	Square Top Shape	X Base

Description

Square Table with X Base at 16"
Lounge Height
(continued)

Veneer Tables
"LKV" Models



VENEER	D	W	H	CTN WT	CU FT	① Model	Flat Cut	Double Cut	Flat Cut	Double Cut
		36	36	16	65	17	LKV3636-16SQX	\$1,507	\$1,601	\$1,707
	30	30	16	50	13	LKV3030-16SQX	\$1,486	\$1,560	\$1,693	\$1,754
	24	24	16	38	9	LKV2424-16SQX	\$1,194	\$1,238	\$1,369	\$1,406

Electrical Options and Upcharges

CTEC23	
EC23 Power Center Top - Black	CTEC23BL - add \$738
EC23 Power Center Top - White	CTEC23WH - add \$738
CTEC24	
EC24 Power Center Top - Black	CTEC43BL - add \$632
EC24 Power Center Top - White	CTEC43WH - add \$632

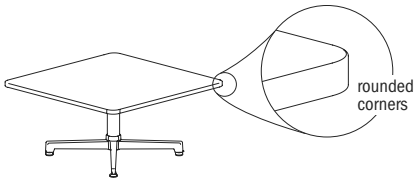
To Order Specify

① Veneer Model #	② Edge Detail	③ Wood Species	④ Wood Finish	⑤ Electrical	⑥ Metal Color
Veneer (LKV)	R3 Eased K9 Reverse Bevel	Flat Cut CH1 Cherry MA1 Maple WA1 Walnut BO1 Black Oak	See Flat Cut Wood Finish Options	N None CTEC23 Power Center Top CTEC24 Power Center Top (See chart above)	See Metal Finish Color Options
	Double Cut DC1 Double Cut	See Double Cut Wood Finish Options			

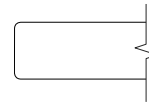
LOK - LOUNGE

Description

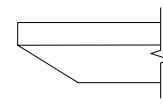
Rounded Square Table with X Base at 16" Lounge Height



Laminate Tables
"LKT" Models



Eased Edge (R3)



Reverse Bevel Edge (K9)

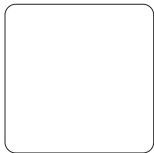
LAMINATE	D	W	H	CTN WT	CU FT	Model	Eased Edge (R3)		Reverse Bevel Edge (K9)			
							Standard	Graded In	Standard	Graded In		
							Tier 1	Tier 2	Tier 3	Tier 1	Tier 2	Tier 3
	36	36	16	65	17	LKT3636-16SQRX	\$1,213	\$1,229	\$1,332	\$1,665	\$1,680	\$1,750
	30	30	16	50	13	LKT3030-16SQRX	\$1,201	\$1,248	\$1,285	\$1,626	\$1,661	\$1,698
	24	24	16	38	9	LKT2424-16SQRX	\$959	\$967	\$1,025	\$1,390	\$1,399	\$1,443

Features:

- price reflects complete table - top and base
- ships KD in multiple cartons
- model includes adjustable glide
- when electrical option is selected, power accessible base is shipped; see page 417 for details
- power/charging units have 72" cord
- power cord is routed inside base column

Options:

- specify power access base with power unit option; None (N), add \$738 for EC23 (CTEC23), add \$632 for EC24 (CTEC24)



top shape

To Order Specify

1 Laminate Model #	2 Edge Detail	3 Laminate Selection	3a PVC Edge Color	4 Electrical	5 Metal Color
Laminate (LKT)	See Edge Detail Options	See Laminate Selection	See PVC Edge Color Options	N None CTEC23 Power Center Top CTEC24 Power Center Top (See chart on next page)	See Metal Finish Color Options

Model Number Breakdown

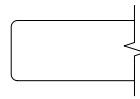
LKT3636-16SQRX						
LK	T	3636	16	SQ	R	X
LOK	Laminate	36" x 36"	Height	Square Top Shape	Rounded Corner	X Base

Description

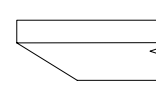
Rounded Square Table with X Base at 16" Lounge Height (continued)

Veneer Tables "LKV" Models

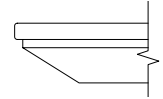
Solid Surface Tables "LKS" Models



Eased Edge (R3)



Reverse Bevel Edge (K9)



Reverse Bevel Edge (S7)

	D	W	H	CTN WT	CU FT	① Model	Veneer Tables "LKV" Models		Solid Surface Tables "LKS" Models		
							Flat Cut	Double Cut	Flat Cut	Double Cut	Standard
VENEER	36	36	16	65	17	LKV3636-16SQRX	\$1,548	\$1,642	\$1,747	\$1,830	--
	30	30	16	50	13	LKV3030-16SQRX	\$1,525	\$1,597	\$1,732	\$1,796	--
	24	24	16	38	9	LKV2424-16SQRX	\$1,234	\$1,289	\$1,412	\$1,460	--
SOLID SURFACE	36	36	16	86	17	LKS3636-16SQRX	--	--	--	--	\$3,344
	30	30	16	72	13	LKS3030-16SQRX	--	--	--	--	\$2,872
	24	24	16	47	9	LKS2424-16SQRX	--	--	--	--	\$2,354

Electrical Options and Upcharges

CTEC23	
EC23 Power Center Top - Black	CTEC23BL - add \$738
EC23 Power Center Top - White	CTEC23WH - add \$738
CTEC24	
EC24 Power Center Top - Black	CTEC43BL - add \$632
EC24 Power Center Top - White	CTEC43WH - add \$632

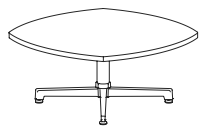
To Order Specify

① Veneer Model #	② Edge Detail	③ Wood Species	④ Wood Finish	⑤ Electrical	⑥ Metal Color
Veneer (LKV)	R3 Eased K9 Reverse Bevel	Flat Cut CH1 Cherry MA1 Maple WA1 Walnut BO1 Black Oak	See Flat Cut Wood Finish Options	N None CTEC23 Power Center Top CTEC24 Power Center Top (See chart above)	See Metal Finish Color Options
	Double Cut DC1 Double Cut	See Double Cut Wood Finish Options			

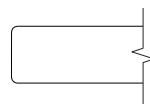
LOK - LOUNGE

Description

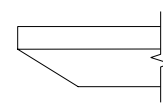
Squircle Table with X Base at 16" Lounge Height



Laminate Tables "LKT" Models



Eased Edge (R3)



Reverse Bevel Edge (K9)

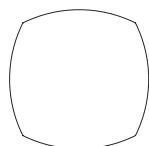
LAMINATE	D	W	H	CTN WT	CU FT	Model	Eased Edge (R3)		Reverse Bevel Edge (K9)			
							Standard	Graded In	Standard	Graded In		
							Tier 1	Tier 2	Tier 3	Tier 1	Tier 2	Tier 3
	36	36	16	65	17	LKT36-16SCX	\$1,213	\$1,229	\$1,332	\$1,665	\$1,680	\$1,750
	30	30	16	50	13	LKT30-16SCX	\$1,213	\$1,248	\$1,285	\$1,626	\$1,661	\$1,698
	24	24	16	38	9	LKT24-16SCX	\$967	\$977	\$1,036	\$1,405	\$1,413	\$1,456

Features:

- price reflects complete table - top and base
- ships KD in multiple cartons
- model includes adjustable glide
- when electrical option is selected, power accessible base is shipped; see page 417 for details
- power/charging units have 72" cord
- power cord is routed inside base column

Options:

- specify power access base with power unit option; None (N), add \$738 for EC23 (CTEC23), add \$632 for EC24 (CTEC24)



top shape

To Order Specify

1 Laminate Model #	2 Edge Detail	3 Laminate Selection	3a PVC Edge Color	4 Electrical	5 Metal Color
Laminate (LKT)	See Edge Detail Options	See Laminate Selection	See PVC Edge Color Options	N None CTEC23 Power Center Top CTEC24 Power Center Top (See chart on next page)	See Metal Finish Color Options

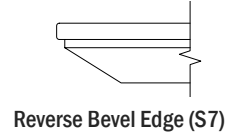
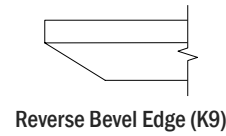
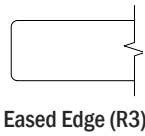
Model Number Breakdown

LKT36-16SCX					
LK	T	36	16	SC	X
LOK	Laminate	36" dia.	Height	Squircle Top Shape	X Base

Description

Squirle Table with X Base at 16" Lounge Height (continued)

Veneer Tables "LKV" Models Solid Surface Tables "LKS" Models



	D	W	H	CTN WT	CU FT	① Model	Eased Edge (R3)		Reverse Bevel Edge (K9)		Reverse Bevel Edge (S7)
							Flat Cut	Double Cut	Flat Cut	Double Cut	
VENEER	36	36	16	65	17	LKV36-16SCX	\$1,548	\$1,642	\$1,747	\$1,830	--
	30	30	16	50	13	LKV30-16SCX	\$1,525	\$1,597	\$1,732	\$1,796	--
	24	24	16	38	9	LKV24-16SCX	\$1,234	\$1,289	\$1,412	\$1,460	--
SOLID SURFACE	36	36	16	86	17	LKS36-16SCX	--	--	--	--	\$3,344
	30	30	16	72	13	LKS30-16SCX	--	--	--	--	\$2,842
	24	24	16	47	9	LKS24-16SCX	--	--	--	--	\$2,354

Electrical Options and Upcharges

CTEC23	
EC23 Power Center Top - Black	CTEC23BL - add \$738
EC23 Power Center Top - White	CTEC23WH - add \$738
CTEC24	
EC24 Power Center Top - Black	CTEC43BL - add \$632
EC24 Power Center Top - White	CTEC43WH - add \$632

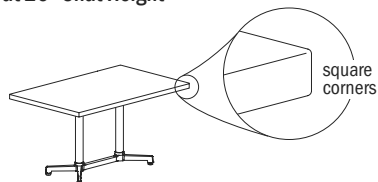
To Order Specify

① Veneer Model #	② Edge Detail	③ Wood Species	④ Wood Finish	⑤ Electrical	⑥ Metal Color
Veneer (LKV)	R3 Eased K9 Reverse Bevel	Flat Cut CH1 Cherry MA1 Maple WA1 Walnut BO1 Black Oak	See Flat Cut Wood Finish Options	N None CTEC23 Power Center Top CTEC24 Power Center Top (See chart above)	See Metal Finish Color Options
	Double Cut DC1 Double Cut	See Double Cut Wood Finish Options			

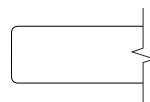
LOK - LOUNGE

Description

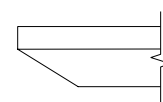
Rectangular Table with Y Base
at 26" Chat Height



Laminate Tables
"LKT" Models



Eased Edge (R3)



Reverse Bevel Edge (K9)

LAMINATE	D	W	H	CTN WT	CU FT	❶ Model	Standard			Graded In		
							Tier 1	Tier 2	Tier 3	Tier 1	Tier 2	Tier 3
	30	48	26	83	29	LKT3048-26TTY	\$1,628	\$1,646	\$1,756	\$2,079	\$2,098	\$2,178
24	48	26	74	24	LKT2448-26TTY	\$1,562	\$1,575	\$1,666	\$2,007	\$2,023	\$2,085	

Features:

- price reflects complete table - top and base
- ships KD in multiple cartons
- model includes adjustable glide
- power cord is routed outside base column
- order vertical wire manager separately; see page 454

Options:

- specify power unit option; None (N), add \$643 for EC23 (CTEC23), add \$533 for EC24 (CTEC24)



top shape

To Order Specify

❶ Laminate Model #	❷ Edge Detail	❸ Laminate Selection	❹ PVC Edge Color	❺ Electrical	❻ Metal Color
Laminate (LKT)	See Edge Detail Options	See Laminate Selection	See PVC Edge Color Options	N None CTEC23 Power Center Top CTEC24 Power Center Top (See chart on next page)	See Metal Finish Color Options

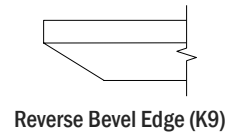
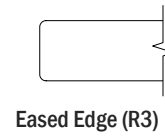
Model Number Breakdown

LKT3048-26TTY					
LK	T	3048	26	TT	Y
LOK	Laminate	30" x 48"	Height	Rectangular Top Shape	Y Base

Description

Rectangular Table with Y Base
at 26" Chat Height
(continued)

Veneer Tables
"LKV" Models



VENEER	D	W	H	CTN WT	CU FT	1 Model	Flat Cut	Double Cut	Flat Cut	Double Cut
	30	48	26	83	29	LKV3048-26TTY	\$1,903	\$2,001	\$2,097	\$2,182
24	48	26	74	24	LKV2448-26TTY	\$1,833	\$1,914	\$2,020	\$2,090	

Electrical Options and Upcharges

CTEC23	
EC23 Power Center Top - Black	CTEC23BL - add \$643
EC23 Power Center Top - White	CTEC23WH - add \$643
CTEC24	
EC24 Power Center Top - Black	CTEC43BL - add \$533
EC24 Power Center Top - White	CTEC43WH - add \$533

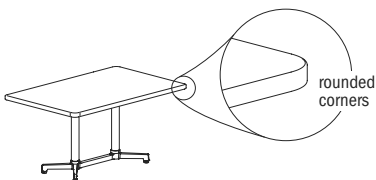
To Order Specify

1 Veneer Model #	2 Edge Detail	3 Wood Species	4 Wood Finish	5 Electrical	6 Metal Color
Veneer (LKV)	R3 Eased K9 Reverse Bevel	Flat Cut CH1 Cherry MA1 Maple WA1 Walnut BO1 Black Oak	See Flat Cut Wood Finish Options	N None CTEC23 Power Center Top CTEC24 Power Center Top (See chart above)	See Metal Finish Color Options
	Double Cut DC1 Double Cut	4 Wood Finish	See Double Cut Wood Finish Options		

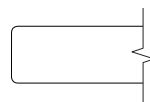
LOK - LOUNGE

Description

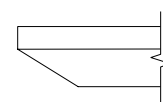
Rounded Rectangular Table with Y Base at 26" Chat Height



Laminate Tables "LKT" Models



Eased Edge (R3)



Reverse Bevel Edge (K9)

LAMINATE	D	W	H	CTN WT	CU FT	Model	Eased Edge (R3)			Reverse Bevel Edge (K9)		
							Standard	Graded In		Standard	Graded In	
							Tier 1	Tier 2	Tier 3	Tier 1	Tier 2	Tier 3
	30	48	26	83	29	LKT3048-26TTRY	\$1,691	\$1,709	\$1,834	\$2,146	\$2,165	\$2,253
	24	48	26	79	24	LKT2448-26TTRY	\$1,598	\$1,613	\$1,703	\$2,044	\$2,058	\$2,122

Features:

- price reflects complete table - top and base
- ships KD in multiple cartons
- model includes adjustable glide
- power cord is routed outside base column
- order vertical wire manager separately; see page 454

Options:

- specify power unit option; None (N), add \$643 for EC23 (CTEC23), add \$533 for EC24 (CTEC24)



top shape

To Order Specify

1 Laminate Model #	2 Edge Detail	3 Laminate Selection	3a PVC Edge Color	4 Electrical	5 Metal Color
Laminate (LKT)	See Edge Detail Options	See Laminate Selection	See PVC Edge Color Options	N None CTEC23 Power Center Top CTEC24 Power Center Top (See chart on next page)	See Metal Finish Color Options

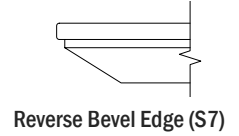
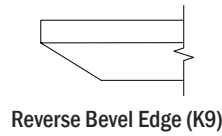
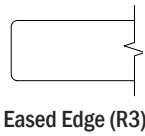
Model Number Breakdown

LKT3048-26TTRY						
LK	T	3048	26	TT	R	Y
LOK	Laminate	30" x 48"	Height	Rectangular Top Shape	Rounded Corner	Y Base

Description

Rounded Rectangular Table with Y Base at 26" Chat Height (continued)

Veneer Tables "LKV" Models Solid Surface Tables "LKS" Models



	D	W	H	CTN WT	CU FT	① Model	Veneer Tables "LKV" Models		Solid Surface Tables "LKS" Models		
							Flat Cut	Double Cut	Flat Cut	Double Cut	Standard
VENEER	30	48	26	83	29	LKV3048-26TTRY	\$1,956	\$2,067	\$2,155	\$2,253	--
	24	48	26	79	24	LKV2448-26TTRY	\$1,870	\$1,949	\$2,056	\$2,127	--
SOL. SURF.	30	48	26	83	29	LKS3048-26TTRY	--	--	--	--	\$3,967
	24	48	26	79	24	LKS2448-26TTRY	--	--	--	--	\$3,095

Electrical Options and Upcharges

CTEC23	
EC23 Power Center Top - Black	CTEC23BL - add \$643
EC23 Power Center Top - White	CTEC23WH - add \$643
CTEC24	
EC24 Power Center Top - Black	CTEC24BL - add \$533
EC24 Power Center Top - White	CTEC24WH - add \$533

To Order Specify

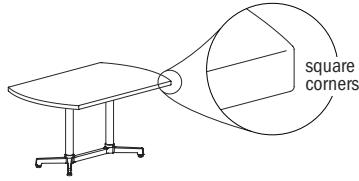
① Veneer Model #	② Edge Detail	③ Wood Species	④ Wood Finish	⑤ Electrical	⑥ Metal Color
Veneer (LKV)	See Edge Detail Options	Flat Cut CH1 Cherry MA1 Maple WA1 Walnut BO1 Black Oak	See Flat Cut Wood Finish Options	N None CTEC23 Power Center Top CTEC24 Power Center Top (See chart above)	See Metal Finish Color Options
		Double Cut DC1 Double Cut	④ Wood Finish See Double Cut Wood Finish Options		

① Solid Surface Model #	② Top Surface Selection	③ Electrical Cut Out	④ Metal Color
Solid Surface (LKS)	See Solid Surface Top Surface Selection Options	N None CTEC23 Power Center Top CTEC24 Power Center Top (See chart above)	See Metal Finish Color Options

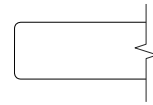
LOK - LOUNGE

Description

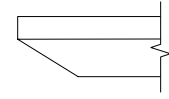
Arc Rectangular Table with Y Base at 26" Chat Height



Laminate Tables "LKT" Models



Eased Edge (R3)



Reverse Bevel Edge (K9)

LAMINATE	D	W	H	CTN WT	CU FT	Model	Standard			Graded In		
							Tier 1	Tier 2	Tier 3	Tier 1	Tier 2	Tier 3
	30	48	26	80	29	LKT3048-26ARY	\$1,691	\$1,709	\$1,834	\$2,146	\$2,165	\$2,253
24	48	26	72	24	LKT2448-26ARY	\$1,598	\$1,613	\$1,703	\$2,044	\$2,058	\$2,122	

Features:

- price reflects complete table - top and base
- ships KD in multiple cartons
- model includes adjustable glide
- power cord is routed outside base column
- order vertical wire manager separately; see page 454

Options:

- specify power unit option; None (N), add \$643 for EC23 (CTEC23), add \$533 for EC24 (CTEC24)



top shape

To Order Specify

1 Laminate Model #	2 Edge Detail	3 Laminate Selection	3a PVC Edge Color	4 Electrical	5 Metal Color
Laminate (LKT)	See Edge Detail Options	See Laminate Selection	See PVC Edge Color Options	N None CTEC23 Power Center Top CTEC24 Power Center Top (See chart on next page)	See Metal Finish Color Options

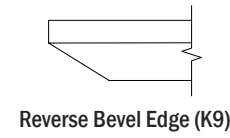
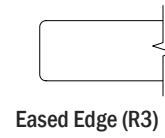
Model Number Breakdown

LKT3048-26ARY					
LK	T	3048	26	AR	Y
LOK	Laminate	30" x 48"	Height	Arc Rectangular Top Shape	Y Base

Description

Arc Rectangular Table with Y Base at 26" Chat Height (continued)

Veneer Tables "LKV" Models



VENEER	D	W	H	CTN WT	CU FT	1 Model	Flat Cut	Double Cut	Flat Cut	Double Cut
	30	48	26	80	29	LKV3048-26ARY	\$1,956	\$2,067	\$2,155	\$2,253
24	48	26	72	24	LKV2448-26ARY	\$1,870	\$1,949	\$2,056	\$2,127	

Electrical Options and Upcharges

CTEC23	
EC23 Power Center Top - Black	CTEC23BL - add \$643
EC23 Power Center Top - White	CTEC23WH - add \$643
CTEC24	
EC24 Power Center Top - Black	CTEC43BL - add \$533
EC24 Power Center Top - White	CTEC43WH - add \$533

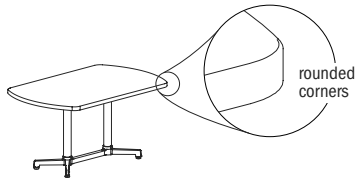
To Order Specify

1 Veneer Model #	2 Edge Detail	3 Wood Species	4 Wood Finish	5 Electrical	6 Metal Color
Veneer (LKV)	R3 Eased K9 Reverse Bevel	Flat Cut CH1 Cherry MA1 Maple WA1 Walnut BO1 Black Oak	See Flat Cut Wood Finish Options	N None CTEC23 Power Center Top CTEC24 Power Center Top (See chart above)	See Metal Finish Color Options
	Double Cut DC1 Double Cut	See Double Cut Wood Finish Options			

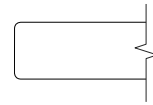
LOK - LOUNGE

Description

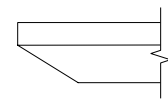
Rounded Arc Rectangular Table with Y Base at 26" Chat Height



Laminate Tables "LKT" Models



Eased Edge (R3)



Reverse Bevel Edge (K9)

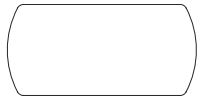
LAMINATE	D	W	H	CTN WT	CU FT	Model	Standard			Graded In		
							Tier 1	Tier 2	Tier 3	Tier 1	Tier 2	Tier 3
	30	48	26	80	29	LKT3048-26ARRY	\$1,691	\$1,709	\$1,834	\$2,146	\$2,165	\$2,253
24	48	26	77	24	LKT2448-26ARRY	\$1,598	\$1,613	\$1,703	\$2,044	\$2,058	\$2,122	

Features:

- price reflects complete table - top and base
- ships KD in multiple cartons
- model includes adjustable glide
- power cord is routed outside base column
- order vertical wire manager separately; see page 454

Options:

- specify power unit option; None (N), add \$643 for EC23 (CTEC23), add \$533 for EC24 (CTEC24)



top shape

LOK-LOUNGE

To Order Specify

1 Laminate Model #	2 Edge Detail	3 Laminate Selection	3a PVC Edge Color	4 Electrical	5 Metal Color
Laminate (LKT)	See Edge Detail Options	See Laminate Selection	See PVC Edge Color Options	N None CTEC23 Power Center Top CTEC24 Power Center Top (See chart on next page)	See Metal Finish Color Options

Model Number Breakdown

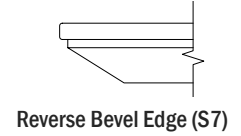
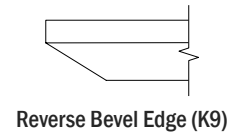
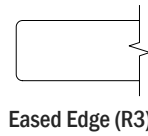
LKT3048-26ARRY						
LK	T	3048	26	AR	R	Y
LOK	Laminate	30" x 48"	Height	Arc Rectangular Top Shape	Rounded Corner	Y Base

Description

Rounded Arc Rectangular Table with Y Base at 26" Chat Height (continued)

Veneer Tables "LKV" Models

Solid Surface Tables "LKS" Models



	D	W	H	CTN WT	CU FT	① Model	Veneer Tables "LKV" Models		Solid Surface Tables "LKS" Models		
							Flat Cut	Double Cut	Flat Cut	Double Cut	Standard
VENEER	30	48	26	80	29	LKV3048-26ARRY	\$1,956	\$2,067	\$2,155	\$2,253	--
	24	48	26	77	24	LKV2448-26ARRY	\$1,870	\$1,949	\$2,056	\$2,127	--
SOL. SURF.	30	48	26	80	29	LKS3048-26ARRY	--	--	--	--	\$3,967
	24	48	26	77	24	LKS2448-26ARRY	--	--	--	--	\$3,095

Electrical Options and Upcharges

CTEC23	
EC23 Power Center Top - Black	CTEC23BL - add \$643
EC23 Power Center Top - White	CTEC23WH - add \$643
CTEC24	
EC24 Power Center Top - Black	CTEC24BL - add \$533
EC24 Power Center Top - White	CTEC24WH - add \$533

To Order Specify

① Veneer Model #	② Edge Detail	③ Wood Species	④ Wood Finish	⑤ Electrical	⑥ Metal Color
Veneer (LKV)	See Edge Detail Options	Flat Cut CH1 Cherry MA1 Maple WA1 Walnut BO1 Black Oak	See Flat Cut Wood Finish Options	N None CTEC23 Power Center Top CTEC24 Power Center Top (See chart above)	See Metal Finish Color Options
		Double Cut DC1 Double Cut	④ Wood Finish See Double Cut Wood Finish Options		

① Solid Surface Model #	② Top Surface Selection	③ Electrical Cut Out	④ Metal Color
Solid Surface (LKS)	See Solid Surface Top Surface Selection Options	N None CTEC23 Power Center Top CTEC24 Power Center Top (See chart above)	See Metal Finish Color Options

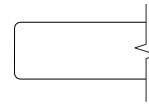
LOK - LOUNGE

Description

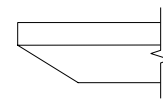
Oval Table with Y Base at
26" Chat Height



Laminate Tables
"LKT" Models



Eased Edge (R3)



Reverse Bevel Edge (K9)

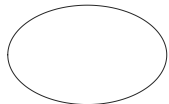
LAM.	D	W	H	CTN WT	CU FT	① Model	Eased Edge (R3)		Reverse Bevel Edge (K9)			
							Standard	Graded In	Standard	Graded In		
							Tier 1	Tier 2	Tier 3	Tier 1	Tier 2	Tier 3
	30	48	26	74	29	LKT3048-260VY	\$1,674	\$1,696	\$1,818	\$2,130	\$2,151	\$2,239

Features:

- price reflects complete table - top and base
- ships KD in multiple cartons
- model includes adjustable glide
- power cord is routed outside base column
- order vertical wire manager separately; see page 454

Options:

- specify power unit option; None (N), add \$643 for EC23 (CTEC23), add \$533 for EC24 (CTEC24)



top shape

To Order Specify

① Laminate Model #	② Edge Detail	③ Laminate Selection	④ PVC Edge Color	⑤ Electrical	⑥ Metal Color
Laminate (LKT)	See Edge Detail Options	See Laminate Selection	See PVC Edge Color Options	N None CTEC23 Power Center Top CTEC24 Power Center Top (See chart on next page)	See Metal Finish Color Options

Model Number Breakdown

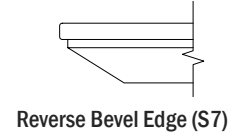
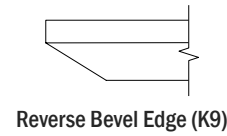
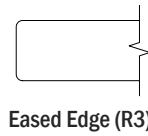
LKT3048-260VY					
LK	T	3048	26	OV	Y
LOK	Laminate	30" x 48"	Height	Oval Top Shape	Y Base

Description

Oval Table with Y Base at 26"
 Chat Height
 (continued)

Veneer Tables
 "LKV" Models

Solid Surface Tables
 "LKS" Models



	D	W	H	CTN WT	CU FT	① Model	Eased Edge (R3)		Reverse Bevel Edge (K9)		Reverse Bevel Edge (S7)
							Flat Cut	Double Cut	Flat Cut	Double Cut	
VEN.	30	48	26	74	29	LKV3048-260VY	\$1,943	\$2,052	\$2,140	\$2,238	--
S.S.	30	48	26	74	29	LKS3048-260VY	--	--	--	--	\$3,953

Electrical Options and Upcharges

CTEC23	
EC23 Power Center Top - Black	CTEC23BL - add \$643
EC23 Power Center Top - White	CTEC23WH - add \$643
CTEC24	
EC24 Power Center Top - Black	CTEC43BL - add \$533
EC24 Power Center Top - White	CTEC43WH - add \$533

To Order Specify

① Veneer Model #	② Edge Detail	③ Wood Species	④ Wood Finish	⑤ Electrical	⑥ Metal Color
Veneer (LKV)	See Edge Detail Options	Flat Cut CH1 Cherry MA1 Maple WA1 Walnut BO1 Black Oak	See Flat Cut Wood Finish Options	N None CTEC23 Power Center Top CTEC24 Power Center Top (See chart above)	See Metal Finish Color Options
		Double Cut DC1 Double Cut	④ Wood Finish See Double Cut Wood Finish Options		

① Solid Surface Model #	② Top Surface Selection	③ Electrical Cut Out	④ Metal Color
Solid Surface (LKS)	See Solid Surface Top Surface Selection Options	N None CTEC23 Power Center Top CTEC24 Power Center Top (See chart above)	See Metal Finish Color Options

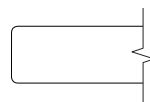
LOK - LOUNGE

Description

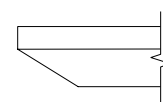
Round Table with X Base at
26" Chat Height



Laminate Tables
"LKT" Models



Eased Edge (R3)



Reverse Bevel Edge (K9)

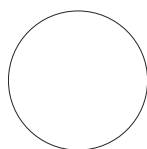
LAMINATE	D	W	H	CTN WT	CU FT	Model	Eased Edge (R3)			Reverse Bevel Edge (K9)		
							Standard	Graded In		Standard	Graded In	
							Tier 1	Tier 2	Tier 3	Tier 1	Tier 2	Tier 3
	42	42	26	77	35	LKT42-26RDX	\$1,341	\$1,450	\$1,539	\$1,768	\$1,876	\$1,965
	36	36	26	63	26	LKT36-26RDX	\$1,263	\$1,279	\$1,384	\$1,733	\$1,748	\$1,822
	30	30	26	51	19	LKT30-26RDX	\$1,252	\$1,286	\$1,324	\$1,676	\$1,710	\$1,747
	24	24	26	41	13	LKT24-26RDX	\$997	\$1,006	\$1,065	\$1,447	\$1,457	\$1,498

Features:

- price reflects complete table - top and base
- ships KD in multiple cartons
- model includes adjustable glide
- when electrical option is selected, power accessible base is shipped; see page 417 for details
- power/charging units have 72" cord
- power cord is routed inside base column

Options:

- specify power access base with power unit option; None (N), add \$738 for EC23 (CTEC23), add \$632 for EC24 (CTEC24)



top shape

To Order Specify

1 Laminate Model #	2 Edge Detail	3 Laminate Selection	3a PVC Edge Color	4 Electrical	5 Metal Color
Laminate (LKT)	See Edge Detail Options	See Laminate Selection	See PVC Edge Color Options	N None CTEC23 Power Center Top CTEC24 Power Center Top (See chart on next page)	See Metal Finish Color Options

Model Number Breakdown

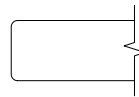
LKT42-26RDX					
LK	T	42	26	RD	X
LOK	Laminate	42" dia.	Height	Round Top Shape	X Base

Description

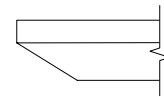
Round Table with X Base at
26" Chat Height
(continued)

Veneer Tables
"LKV" Models

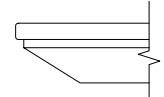
Solid Surface Tables
"LKS" Models



Eased Edge (R3)



Reverse Bevel Edge (K9)



Reverse Bevel Edge (S7)

	D	W	H	CTN WT	CU FT	① Model	Veneer Tables "LKV" Models		Solid Surface Tables "LKS" Models		
							Flat Cut	Double Cut	Flat Cut	Double Cut	Standard
VENEER	42	42	26	77	35	LKV42-26RDX	\$1,792	\$1,916	\$2,001	\$2,113	--
	36	36	26	63	26	LKV36-26RDX	\$1,548	\$1,642	\$1,747	\$1,830	--
	30	30	26	51	19	LKV30-26RDX	\$1,525	\$1,597	\$1,732	\$1,796	--
	24	24	26	41	13	LKV24-26RDX	\$1,234	\$1,289	\$1,412	\$1,460	--
SOLID SURFACE	42	42	26	99	35	LKS42-26RDX	--	--	--	--	\$4,083
	36	36	26	79	26	LKS36-26RDX	--	--	--	--	\$3,344
	30	30	26	62	19	LKS30-26RDX	--	--	--	--	\$3,020
	24	24	26	48	13	LKS24-26RDX	--	--	--	--	\$2,723

Electrical Options and Upcharges

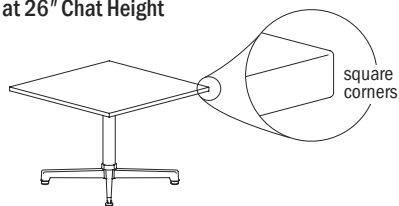
CTEC23	
EC23 Power Center Top - Black	CTEC23BL - add \$738
EC23 Power Center Top - White	CTEC23WH - add \$738
CTEC24	
EC24 Power Center Top - Black	CTEC43BL - add \$632
EC24 Power Center Top - White	CTEC43WH - add \$632

To Order Specify

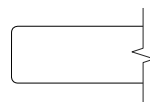
① Veneer Model #	② Edge Detail	③ Wood Species	④ Wood Finish	⑤ Electrical	⑥ Metal Color
Veneer (LKV)	R3 Eased K9 Reverse Bevel	Flat Cut CH1 Cherry MA1 Maple WA1 Walnut BO1 Black Oak	See Flat Cut Wood Finish Options	N None CTEC23 Power Center Top CTEC24 Power Center Top (See chart above)	See Metal Finish Color Options
	Double Cut DC1 Double Cut	See Double Cut Wood Finish Options			

Description

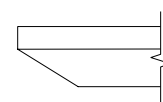
Square Table with X Base
at 26" Chat Height



Laminate Tables
"LKT" Models



Eased Edge (R3)



Reverse Bevel Edge (K9)

LAMINATE	D	W	H	CTN WT	CU FT	Model	Eased Edge (R3)			Reverse Bevel Edge (K9)		
							Standard	Graded In		Standard	Graded In	
							Tier 1	Tier 2	Tier 3	Tier 1	Tier 2	Tier 3
	36	36	26	73	26	LKT3636-26SQX	\$1,224	\$1,240	\$1,343	\$1,694	\$1,709	\$1,784
	30	30	26	57	19	LKT3030-26SQX	\$1,179	\$1,195	\$1,274	\$1,684	\$1,698	\$1,752
	24	24	26	45	13	LKT2424-26SQX	\$950	\$958	\$1,001	\$1,393	\$1,402	\$1,432

Features:

- price reflects complete table - top and base
- ships KD in multiple cartons
- model includes adjustable glide
- when electrical option is selected, power accessible base is shipped; see page 417 for details
- power/charging units have 72" cord
- power cord is routed inside base column

Options:

- specify power access base with power unit option; None (N), add \$738 for EC23 (CTEC23), add \$632 for EC24 (CTEC24)



top shape

To Order Specify

1 Laminate Model #	2 Edge Detail	3 Laminate Selection	3a PVC Edge Color	4 Electrical	5 Metal Color
Laminate (LKT)	See Edge Detail Options	See Laminate Selection	See PVC Edge Color Options	N None CTEC23 Power Center Top CTEC24 Power Center Top (See chart on next page)	See Metal Finish Color Options

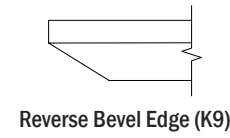
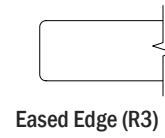
Model Number Breakdown

LKT3636-26SQX					
LK	T	3636	26	SQ	X
LOK	Laminate	36" x 36"	Height	Square Top Shape	X Base

Description

Square Table with X Base
at 26" Chat Height
(continued)

Veneer Tables
"LKV" Models



VENEER	D	W	H	CTN WT	CU FT	① Model	Flat Cut	Double Cut	Flat Cut	Double Cut
		36	36	26	73	26	LKV3636-26SQX	\$1,507	\$1,601	\$1,707
	30	30	26	57	19	LKV3030-26SQX	\$1,486	\$1,560	\$1,693	\$1,754
	24	24	26	45	13	LKV2424-26SQX	\$1,194	\$1,238	\$1,369	\$1,406

Electrical Options and Upcharges

CTEC23	
EC23 Power Center Top - Black	CTEC23BL - add \$738
EC23 Power Center Top - White	CTEC23WH - add \$738
CTEC24	
EC24 Power Center Top - Black	CTEC43BL - add \$632
EC24 Power Center Top - White	CTEC43WH - add \$632

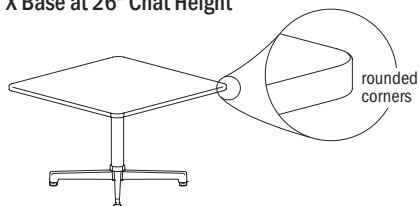
LOK - LOUNGE

To Order Specify

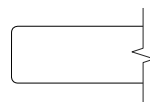
① Veneer Model #	② Edge Detail	③ Wood Species	④ Wood Finish	⑤ Electrical	⑥ Metal Color
Veneer (LKV)	R3 Eased K9 Reverse Bevel	Flat Cut CH1 Cherry MA1 Maple WA1 Walnut BO1 Black Oak	See Flat Cut Wood Finish Options	N None CTEC23 Power Center Top CTEC24 Power Center Top (See chart above)	See Metal Finish Color Options
	Double Cut DC1 Double Cut	④ Wood Finish See Double Cut Wood Finish Options			

Description

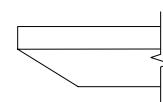
Rounded Square Table with X Base at 26" Chat Height



Laminate Tables "LKT" Models



Eased Edge (R3)



Reverse Bevel Edge (K9)

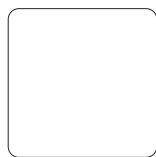
LAMINATE	D	W	H	CTN WT	CU FT	Model	Eased Edge (R3)		Reverse Bevel Edge (K9)			
							Standard	Graded In		Standard	Graded In	
							Tier 1	Tier 2	Tier 3	Tier 1	Tier 2	Tier 3
	36	36	26	73	26	LKT3636-26SQRX	\$1,263	\$1,279	\$1,384	\$1,733	\$1,748	\$1,822
	30	30	26	57	19	LKT3030-26SQRX	\$1,252	\$1,286	\$1,324	\$1,676	\$1,710	\$1,747
	24	24	26	45	13	LKT2424-26SQRX	\$997	\$1,006	\$1,065	\$1,447	\$1,457	\$1,498

Features:

- price reflects complete table - top and base
- ships KD in multiple cartons
- model includes adjustable glide
- when electrical option is selected, power accessible base is shipped; see page 417 for details
- power/charging units have 72" cord
- power cord is routed inside base column

Options:

- specify power access base with power unit option; None (N), add \$738 for EC23 (CTEC23), add \$632 for EC24 (CTEC24)



top shape

To Order Specify

1 Laminate Model #	2 Edge Detail	3 Laminate Selection	3a PVC Edge Color	4 Electrical	5 Metal Color
Laminate (LKT)	See Edge Detail Options	See Laminate Selection	See PVC Edge Color Options	N None CTEC23 Power Center Top CTEC24 Power Center Top (See chart on next page)	See Metal Finish Color Options

Model Number Breakdown

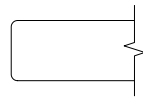
LKT3636-26SQRX						
LK	T	3636	26	SQ	R	X
LOK	Laminate	36" x 36"	Height	Square Top Shape	Rounded Corner	X Base

Description

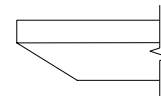
Rounded Square Table with X Base at 26" Chat Height (continued)

Veneer Tables "LKV" Models

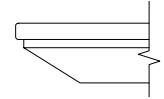
Solid Surface Tables "LKS" Models



Eased Edge (R3)



Reverse Bevel Edge (K9)



Reverse Bevel Edge (S7)

	D	W	H	CTN WT	CU FT	① Model	Veneer Tables "LKV" Models		Solid Surface Tables "LKS" Models		
							Flat Cut	Double Cut	Flat Cut	Double Cut	Standard
VENEER	36	36	26	73	26	LKV3636-26SQRX	\$1,548	\$1,642	\$1,747	\$1,830	--
	30	30	26	57	19	LKV3030-26SQRX	\$1,525	\$1,597	\$1,732	\$1,796	--
	24	24	26	45	13	LKV2424-26SQRX	\$1,234	\$1,289	\$1,412	\$1,460	--
SOLID SURFACE	36	36	26	94	26	LKS3636-26SQRX	--	--	--	--	\$3,344
	30	30	26	72	19	LKS3030-26SQRX	--	--	--	--	\$3,020
	24	24	26	54	13	LKS2424-26SQRX	--	--	--	--	\$2,723

Electrical Options and Upcharges

CTEC23	
EC23 Power Center Top - Black	CTEC23BL - add \$738
EC23 Power Center Top - White	CTEC23WH - add \$738
CTEC24	
EC24 Power Center Top - Black	CTEC43BL - add \$632
EC24 Power Center Top - White	CTEC43WH - add \$632

To Order Specify

① Veneer Model #	② Edge Detail	③ Wood Species	④ Wood Finish	⑤ Electrical	⑥ Metal Color
Veneer (LKV)	R3 Eased K9 Reverse Bevel	Flat Cut CH1 Cherry MA1 Maple WA1 Walnut BO1 Black Oak	See Flat Cut Wood Finish Options	N None CTEC23 Power Center Top CTEC24 Power Center Top (See chart above)	See Metal Finish Color Options
	Double Cut DC1 Double Cut	See Double Cut Wood Finish Options			

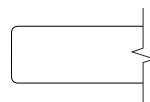
LOK - LOUNGE

Description

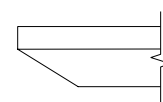
Squircle Table with X Base at 26" Chat Height



Laminate Tables "LKT" Models



Eased Edge (R3)



Reverse Bevel Edge (K9)

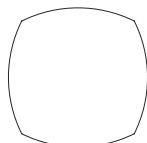
LAMINATE	D	W	H	CTN WT	CU FT	Model	Eased Edge (R3)		Reverse Bevel Edge (K9)			
							Standard	Graded In	Standard	Graded In		
							Tier 1	Tier 2	Tier 3	Tier 1	Tier 2	Tier 3
	36	36	26	73	26	LKT36-26SCX	\$1,263	\$1,279	\$1,384	\$1,733	\$1,748	\$1,822
	30	30	26	57	19	LKT30-26SCX	\$1,252	\$1,286	\$1,324	\$1,676	\$1,710	\$1,747
	24	24	26	45	13	LKT24-26SCX	\$997	\$1,006	\$1,065	\$1,447	\$1,457	\$1,498

Features:

- price reflects complete table - top and base
- ships KD in multiple cartons
- model includes adjustable glide
- when electrical option is selected, power accessible base is shipped; see page 417 for details
- power/charging units have 72" cord
- power cord is routed inside base column

Options:

- specify power access base with power unit option; None (N), add \$738 for EC23 (CTEC23), add \$632 for EC24 (CTEC24)



top shape

To Order Specify

1 Laminate Model #	2 Edge Detail	3 Laminate Selection	3a PVC Edge Color	4 Electrical	5 Metal Color
Laminate (LKT)	See Edge Detail Options	See Laminate Selection	See PVC Edge Color Options	N None CTEC23 Power Center Top CTEC24 Power Center Top (See chart on next page)	See Metal Finish Color Options

Model Number Breakdown

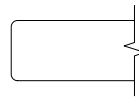
LKT36-26SCX					
LK	T	36	26	SC	X
LOK	Laminate	36"	Height	Squircle Top Shape	X Base

Description

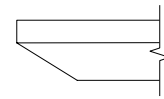
Squirle Table with X Base
at 26" Chat Height
(continued)

Veneer Tables
"LKV" Models

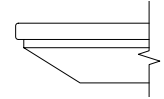
Solid Surface Tables
"LKS" Models



Eased Edge (R3)



Reverse Bevel Edge (K9)



Reverse Bevel Edge (S7)

	D	W	H	CTN WT	CU FT	① Model	Veneer Tables "LKV" Models		Solid Surface Tables "LKS" Models		
							Flat Cut	Double Cut	Flat Cut	Double Cut	Standard
VENEER	36	36	26	73	26	LKV36-26SCX	\$1,548	\$1,642	\$1,747	\$1,830	--
	30	30	26	57	19	LKV30-26SCX	\$1,525	\$1,597	\$1,732	\$1,796	--
	24	24	26	45	13	LKV24-26SCX	\$1,234	\$1,289	\$1,412	\$1,460	--
SOLID SURFACE	36	36	26	94	26	LKS36-26SCX	--	--	--	--	\$3,344
	30	30	26	72	19	LKS30-26SCX	--	--	--	--	\$3,020
	24	24	26	54	13	LKS24-26SCX	--	--	--	--	\$2,723

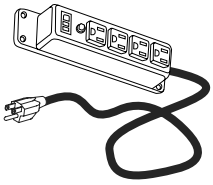
Electrical Options and Upcharges

CTEC23	
EC23 Power Center Top - Black	CTEC23BL - add \$738
EC23 Power Center Top - White	CTEC23WH - add \$738
CTEC24	
EC24 Power Center Top - Black	CTEC43BL - add \$632
EC24 Power Center Top - White	CTEC43WH - add \$632

To Order Specify

① Veneer Model #	② Edge Detail	③ Wood Species	④ Wood Finish	⑤ Electrical	⑥ Metal Color
Veneer (LKV)	R3 Eased K9 Reverse Bevel	Flat Cut CH1 Cherry MA1 Maple WA1 Walnut BO1 Black Oak	See Flat Cut Wood Finish Options	N None CTEC23 Power Center Top CTEC24 Power Center Top (See chart above)	See Metal Finish Color Options
	Double Cut DC1 Double Cut	See Double Cut Wood Finish Options			

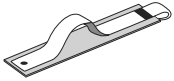
Description	D	W	H	CTN WT	CU FT	① Model	List Price
Power Strip	1 1/2	1 7/8	8	3	1	GP9ACP1-0212	\$93



Features:

- power surge with 10" cord
- four electrical outlets
- includes switch
- field installed

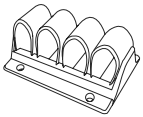
Wire Management Velcro Straps	1 3/4	3 1/2	1/4	1	1	04WVS	\$56
-------------------------------	-------	-------	-----	---	---	-------	------



Features:

- black, set of 4
- field installed to bottom of table top, with adhesive tape provided

Cable Management Clips	2 5/8	3 3/4	1 5/8	1	1	0304CMC	\$54
------------------------	-------	-------	-------	---	---	---------	------



Features:

- black plastic
- installed to bottom of table top
- four retention loops

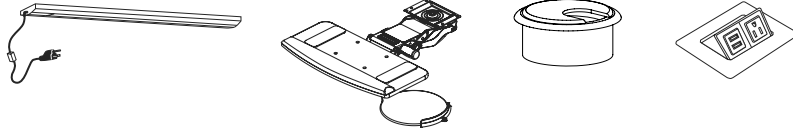
To Order, Specify:

① Model Number	
----------------	--

Accessories/ Keyboard/ Tasklights

For an additional list of electrical units, grommets, keyboards, wire management, monitor arms & telecom jacks, please see our [accessories price list](#)

Contact your customer service representative for specific questions regarding which units can be used with Lok Lounge.





Formica Laminate

JSI offers an extensive program for laminates beyond our Standard Program. Always reference our website for the most current listing when using a Graded-In Laminate, on page 5 select the color of the PVC edge color.

Laminate	Pattern #	HPL	Laminate	Pattern #	HPL	Laminate	Pattern #	HPL
Acajou Mahogany	7008-43	2	Folkstone Grafix	507-58	2	Planked Deluxe Pear	6206-43	2
African Limba	7011-43	2	Fossil	5349-PX	3	Planked Raw Oak	7412-PG	3
Algae	8796-PG	3	Fox Teakwood	8907-NG	3	Planked Urban Oak	9312-NG	3
Almond	920-58	2	Ginger Root Maple	7288-58	2	Portico Marble	7735-58	2
Amber Maple	7012-58	2	Glamour Cherry	6208-43	2	Prestige Walnut	6209-43	2
Antique White	932-58	2	Graphite	837-58	2	Pumice	858-58	2
Ashen Ribbonwood	8839-58	2	Graphite Grafix	515-58	2	Rattan Cane	3699-58	2
Autumn Indian Slate	3687-58	2	Graphite Twill	8829-58	2	Raw Birchply	8910-NG	3
Basalt Slate	3690-34	3	Graystone	464-58	2	Raw Cedar	1545-PG	3
Beluga Beige	3698-58	2	Green Felt	4974-PA	3	Reclaimed Denim Fiber	9271-PX	3
Black	909-58	2	Green Slate	8793-58	2	Rolled Steel	8917-58	2
Black Birchply	8552-NG	3	Green Slate Birchply	8911-NG	3	Sail White	463-PX	3
Black Recycled Kraft	9685-58	2	Greige Softwood	4924-NG	3	Salvage Planked Elm	9480-58	2
Black Riftwood	6414-NG	3	Hard Rock Maple	86992-58	2	Sand Crystall	3517-58	2
Black Walnut	3485-58	2	Infinity Duotex	6448-58	2	Sarum Grey	2770-58	2
Blackened Fiberwood	8916-NG	3	Ivory Kashmir	6226-58	2	Sarum Twill	8827-58	2
Blackened Legno	8848-58	2	Jamocho Granite	7734-46	3	Seasoned Planked Elm	6477-NG	3
Blackened Steel	8918-58	2	Jarraah Legno	8847-58	2	Select Cherry	7759-43	2
Bleached Legno	8845-58	2	Just Rose	8858-PX	3	Silver Oak Herringbone	9311-58	2
Blond Cedar	8576-PG	3	Labrador Granite	3692-46	3	Silver Riftwood	6413-NG	3
Blossom Cherrywood	758-58	2	Layered Black Sand	9510-34	3	Smoky Brown Pear	5488-NT	2
Blue Felt	9320-PA	3	Layered Sand	9511-34	3	Smoky Walnut Woodline	6926-NT	2
Blush	8238-PX	3	Layered White Sand	9512-34	3	Solar Orange	8235-PX	3
Brite White	459-58	2	Lime Stone	7264-58	2	Sorrel Cherry	5886-43	2
Bronzed Steel	8919-58	2	Macchiato Walnut	6932-NT	2	Spectrum Blue	851-58	2
Bubble Art	8958-58	2	Maple Woodline	6925-NT	2	Spectrum Green	7897-58	2
Bubble Organic	8957-58	2	Marine Blue	914-58	2	Spectrum Red	845-58	2
Bubble Science	8956-58	2	Matrix Blue	8795-58	2	Stone Grafix	503-58	2
Burnt Strand	6307-58	2	MDF Solidz	7812-58	2	Stop Red	839-58	2
Butcherblock Maple	204-58	2	Millennium Oak	5887-NT	2	Storm	912-58	2
Cardboard Solidz	7813-58	2	Mineral Spa	6920-58	2	Storm Solidz	3505-SP	3
Carrara Envision	7494-58	2	Mission White	933-58	2	Storm Teakwood	8908-NG	3
Cascara Teakwood	8909-NG	3	Mojave	8751-58	2	Surf	923-58	2
Cassis	6903-58	2	Moonstone	7872-PX	3	Terril	2297-PX	3
Charcoal Boomerang	6942-58	2	Mouse	928-58	2	Thermo Walnut	6402-43	2
Charred Formwood	6416-NT	2	Natural Ash	8843-WR	3	Tinted Paper Terrazzo	8812-PA	3
Cherry Birch	7484-58	2	Natural Birch	7481-58	2	Tonal Paper Terrazzo	8813-PA	3
Cherry Riftwood	6411-NG	3	Natural Cane	6930-NT	2	Travertine	3526-58	2
Chestnut Woodline	5884-58	2	Natural Canvas	7022-58	2	Vibrant Green	6901-58	2
Chocolate Warp	5881-58	2	Natural Cherry	7737-58	2	Victorian Mahogany	7583-58	2
Chrome Yellow	1485-58	2	Natural Gray Felt	4971-PA	3	Violin Figured Annigre	7285-58	2
Citadel	1097-MC	3	Natural Maple	756-58	2	Walnut Fiberwood	8915-NG	3
Citadel Warp	5882-58	2	Natural Oak	346-58	2	Walnut Riftwood	9283-NG	3
Cocoa Maple	7739-58	2	Natural Recycled Kraft	9684-58	2	Walnut Softwood	4925-NG	3
Cognac Maple	7738-58	2	Natural Teak	8849-58	2	Washed Knotty Ash	6438-58	2
Concrete Formwood	6362-NT	2	Natural Walnut	6401-43	2	Waxed Maple	8905-58	2
Concrete Stone	7267-58	2	Navy Blue	969-58	2	Weathered Beamwood	6410-NG	3
Cream Softwood	4923-NG	3	Navy Grafix	7018-58	2	Weathered Fiberwood	8914-NG	3
Danish Maple	8906-58	2	Neutral Twill	8826-58	2	Wenge Strand	6306-58	2
Dark Chocolate	2200-SP	3	Neutral Weft	5875-58	2	Wheat Strand	6212-58	2
Denim Twill	8814-58	2	Neutral White	918-58	2	White	949-58	2
Desert Beige	899-58	2	New Burgundy	7966-58	2	White	949-MC	3
Dogbone White	5281-58	2	Night Forest	8244-58	2	White	949-SP	3
Dover White	7197-58	2	Night Shade	8243-58	2	White Ash	8841-WR	3
Earth	5342-SP	3	Nocturne	5323-58	2	White Drops	8824-58	2
Earth Wash	7213-58	2	Noir Cedar	1547-PG	3	White Ice Granite	9476-43	2
Earthen Twill	8828-58	2	Oak Fiberwood	8913-NG	3	White Painted Wood	8902-NG	3
Earthen Warp	5880-58	2	Oiled Legno	8846-58	2	White Twill	9285-58	2
Earthenware	8241-58	2	Oiled Olivewood	5481-43	2	White Washed Birchply	6372-NG	3
Ebony	9012-NT	2	Oiled Walnut	5487-NT	2	Wild Cherry	5904-43	2
Ebony Oxide	299-58	2	Orange Felt	4973-PA	3	Winter Sky	8792-58	2
Elemental Concrete	8830-58	2	Otter	3202-58	2	Winter Sky Birchply	8912-NG	3
Elemental Stone	8831-58	2	Oxidized Beamwood	9484-NG	3	Yellow Felt	4972-PA	3
Enamel	8794-58	2	Oyster Gray	929-58	2	Zebrano	9011-NT	2
Espresso Pear	5489-NT	2	Paint Scrape Sky	8995-PX	3			
Figured Annigre	7284-58	2	Paint Scrape Steel	8994-PX	3			
Finnish Oak	118-58	2	Paloma Polar	6698-58	2			
Flax Gauze	7708-58	2	Pearl	934-58	2			
Fog	961-58	2	Pecan Woodline	5883-58	2			
Folkstone	927-SP	3	Pencil Wood	7747-58	2			
Folkstone Celesta	692-58	2	Planked Coffee Oak	7413-PG	3			

Nevamar Laminate

JSI offers an extensive program for laminates beyond our Standard Program. Always reference our website for the most current listing when using a Graded-In Laminate, on page 5 select the color of the PVC edge color.

Laminate	Pattern #	HPL	Laminate	Pattern #	HPL	Laminate	Pattern #	HPL
Adaptable Muse	VU6001 T	3	Crema-ARP	WZ0049 T	3	Legendary Teak	WT0004 T	3
Aged Elements	EM6001 T	3	Crema-Timberline	WZ0049 TL	3	Liberty Red-ARP	S1027 T	3
Almond-ARP	S2037 T	3	Crème Tranquility	TQ2001 T	3	Liberty Red-Linez	S1027 LZ	3
Aluminite	AM6001 T	3	Crest Mahogany	W8343 PV	3	Limeade-ARP	SV7410 T	3
Amber Pearwood	WM8342 T	3	Crown Cherry	W8294 T	3	Limeade-Fineline	SV7410 FL	3
Antique White	S7005 T	3	Cutting Edge	WZ2009 T	3	Lino Frieze	FZ2001 T	3
Antoccino	WK0022 T	3	Decadent Allusion	ALN002 T	3	Luminary Teak	WT0005T	3
Aqua Lagoon	S5059 T	3	Deep Blue	S3022 T	3	Lunaria Shadow	LU6001 T	3
Babbling Brook	WW7800 T	3	Dove Gray	S6003 T	3	Macchiato-Aged Bark	WF0011 AB	3
Bailey-ARP	WK0027 T	3	Dragonfly	WZ0062 T	3	Macchiato-ARP	WF0011 T	3
Bailey-Fineline	WK0027 FL	3	Dry Creek Plum	WZ6001 T	3	Madura Gold Granite	GR4001 T	3
Basic Black Hautelink	HLT001 T	3	Easy Elegance	VA5002 T	3	Maize Shibori	SH2002 T	3
Basic	S2110 T	3	Edenwood	WF0001 T	3	Mallow White	S7038 T	3
Beige	S2019 T	3	Eiskaffe	WZ0056 T	3	Manhattan Glamour	MH6001 T	3
Beige Renaissance	WM8258 T	3	Endless Journey	WW0900 VE	3	Manhattan Gleam	MH8001 T	3
Bethany Beige	S2069 T	3	English Lace	S2085 T	3	Manhattan Glitz	MH4001 T	3
Birch Matrix	MR6008 T	3	Extreme Green Bamboo	WZ5001 T	3	Maritime Gray	S6027 T	3
Black Lodestone	LD6001 T	3	Fiji-ARP	SB0300 T	3	Marocchino	WK0023 PV	3
Black Pearl	S6014 T	3	Fiji-Fineline	SB0300 FL	3	Marrakesh Express	KH2001 T	3
Black-ARP	S6001 T	3	Fine Sycamore	W8351 T	3	Mazagran	WZ0052 T	3
Blissful Path	AT8000 T	3	Fossil Gray	S6031 T	3	Mikado Woodprint	WZ0002 T	3
Blossom Cherry	WC5581 MG	3	Foundry	S2084 T	3	Modern Edge	WZ6004 T	3
Blue Lunaria	LU3001 T	3	Frappe	LN6001 T	3	Natural Bamboo	WZ0018 T	3
Blue Shimmer Hautelink	HLB001 T	3	French Blue matrix	MR3003 T	3	Natural Beige	S2063 T	3
Bohemian Edge	W01400 WE	3	Fresh Papaya	S8001 T	3	Navy Matrix II	MR3008 T	3
Bone White	S7032 T	3	Galao	WX0075 AB	3	Neutra Matrix	MR2003 T	3
Botanical Allusion	AL5002 T	3	Galloway Burl	WZ0017 T	3	Neutra	S7025 T	3
Brave Spirit	WU0060 T	3	Garden Mist	SG0004 T	3	Neutral Gray	S6012 T	3
Breve	WZ0054 T	3	Giant Gray Bamboo	WX1150 PV	3	Ochre Tempura	TM2001 T	3
Burgundy	S1015 T	3	Glistening Trail	WH1000 WE	3	Outer Limits	WU0010 WE	3
Café Allusion	AL2004 T	3	Golden Allusion	AL2002 T	3	Painted Woodlands	PDG002 T	3
Café Sienna	S03300 T	3	Golden Anigre	WA0001 SD	3	Palazzo	WK0024 T	3
Calcutta Marble	MW5800 SD	3	Golden Ash	WM8110 T	3	Papier Au Lait	PR2002 T	3
Calm Distinction	VA6001 T	3	Golden Years	AY1300 SD	3	Paris White Potteryware	PO7001 T	3
Caluna Cherry	WC2001 T	3	Grand Isle Maple	W8371 T	3	Passionfruit-ARP	SR5240 T	3
Calypso	WZ0057 T	3	Graphite Blue	S3023 T	3	Passionfruit-Fineline	SR5240 FL	3
Canyon Fissure	FS2001 T	3	Gray Matrix	MR6001 T	3	Patriot Blue	S3048 T	3
Carajillo	WZ0055 T	3	Gray Tranquility	TQ6001 T	3	Penny Lane-Textured Suede	AT7500 SD	3
Caribbean Blue	S3070 T	3	Green Matrix II	MR5007 T	3	Penny Lane-Timberline	AT7500 TL	3
Carmel Sagawood	WM8350 T	3	Greige Matrix	MR2002 T	3	Phantom Gray Matrix	MR6007 T	3
Carmen Red	S1049 T	3	Gunmetal	S6020 T	3	Porcelain	S2050 T	3
Casa Piedra	CK2002 T	3	Herbal Allusion	AL5001 T	3	Precision White	S7036 T	3
Chai	WK0025 T	3	Honey Maple-ARP	WM8322 T	3	Pure Spun Yarn	YSN002 T	3
Chalk White-ARP	S7024 T	3	Honey Plantain	S4025 T	3	Rare Earth Slate	SL6003 T	3
Chalk White-Barnboard	S7024 BB	3	House Rock	RK4001 T	3	Raven	S6033 T	3
Chalk White-Groovy	S7024 GV	3	Hybrid Slate	SL6002 T	3	Recon Oak	WZ0005 MG	3
Champagne Sagawood	WM8349 T	3	Iconic Maple-Aged Bark	WM0047 AB	3	Red Dragon Bamboo	WZ1001 T	3
Charcoal Essence	ES6002 T	3	Iconic Maple-ARP	WM0047 T	3	Red Hot Allusion	ALR003 T	3
Charcoal Fusion	FN6001 T	3	Illustrious Maple	WM0046 T	3	Regency Mahogany	W8352 VE	3
Charcoal Matrix	MR6002 T	3	Ivory Essence	ES2001 T	3	Regimental Blue	S3016 T	3
Cinder Gray Matrix	MR6006 T	3	Jett Black-ARP	S6053 T	3	Roaring Wind	WX8500 VE	3
Classic Rock	RK2001 T	3	Jett Black-Groovy	S6053 GV	3	Rollin' Rock	RK2002 T	3
Clear Maple	WM8340 T	3	Jett Black-Super Matte	S6053 SM	3	Royal Mahogany	WS9450 MG	3
Cocoa Bean-ARP	S2115 T	3	Jute	S2086 T	3	Rugged Trail	WH0050 PV	3
Cocoa Bean-Groovy	S2115 GV	3	Kendo	WZ2004 T	3	Rush	FS6001 T	3
Cognac Birdseye	W8348 VE	3	Kindred Spirit	WU0030 WE	3	Rustic Quartered Oak	WM8164 T	3
Cool Chic	VA7002 T	3	Kona Blend	WZ0028 PV	3	Sandcastle	S2093 T	3
Copper Fusion 2	FN1002 T	3	Kool Kiwi	S5057 T	3	Sandpiper	S6047 T	3
Cordial Gray	S6024 T	3	Kopi Susu	LN6002 T	3			

LOK

Nevamar Laminate (Continued)

JSI offers an extensive program for laminates beyond our Standard Program. Always reference our website for the most current listing when using a Graded-In Laminate, on page 5 select the color of the PVC edge color.

Laminate	Pattern #	HPL	Laminate	Pattern #	HPL
Santa Rosa Plum	WZ2001 T	3	Vous Metal	VS6001 T	3
Scandia Maple	WM5577 SD	3	Vous Serene	VS5002 T	3
Serene Stardom	VA5001 T	3	Vous Tempest	VS6002 T	3
Shibui Woodprint	WZ0001 T	3	Wall Street Allusion	ALT005 T	3
Sienna Essence	ES2003 T	3	Washington Apple	WF0002 SD	3
Silver Alu Metalx	MXT003 T	3	Weathered Storm	WP3000 AB	3
Silver Dollar-Linez	AG8000 LZ	3	Whispering Wind	WX4600 VE	3
Silver Dollar-Textured Suede	AG8000 SD	3	White Essence	ES7001 T	3
Silver Wings	AG6300 SD	3	White Phantasy	PH7001 T	3
Silverline Hautelink	HLT004 T	3	Wild Oats Matrix	MR7002 T	3
Simplicity	W07100 WE	3	Winter Gray Matrix	MR6005 T	3
Siren Maple	WM0005 T	3	Woodstock Granite	GR2004 T	3
Smoky White	S7027 T	3	Wrought Iron	S6054 T	3
Solid White	S7004 T	3	Xanadu Blue Bamboo	WZ3001 T	3
Sovereign Cherry	W8325 T	3	Yunnan	WZ0063 T	3
Spa White	S7040 T	3	Zebrano White	WZ0080 TL	3
Spicy Flavors	S8002 T	3	Zulu	WZ0053 T	3
Stainless Metalx	MXT002 T	3			
Stepping Stone	AE0500 SD	3			
Storm Gray Matrix	MR6004 T	3			
Stout Walnut	WW3100 T	3			
Straightaway Oak	W00040 T	3			
Straw Matrix	MR2006 T	3			
String	S6052 T	3			
Studio Gray	S6037 T	3			
Studio White Matrix	MR7001 T	3			
Summer Night Glow	S8003 T	3			
Sunbeam	WW9000 WE	3			
Sunken Treasure	S3068 T	3			
Sunray	S4022 T	3			
Tangier Anigre	WA0002 SD	3			
Tawny Satinwood	WZ003 T	3			
Tea Stain Spun Yarn	YSN001 T	3			
Tendu	WZ2007 PV	3			
Topaz Khayawood	W8369 T	3			
Tranquility	WA3000 VE	3			
Tropical Allusion	ALB001 T	3			
Tyrian Purple	SP4170 T	3			
Umber Tempera	TM2002 T	3			
Untold Journey	WW4400 VE	3			
Urban Garden	AV2100 T	3			
Urban Life	AG1900 T	3			
Valencia Teak	WT0003 PV	3			
Validate We Do	WZ0045 T	3			
Vanilla Bean	VS2002 T	3			
Vantage Point Walnut	WW0013 MG	3			
Varnish	VS2003 T	3			
Venerable Old Oak-ARP	WK0017 T	3			
Venerable Old Oak-Barnboard	WK0017 BB	3			
Verdict's In	RK6003 T	3			
Vermont Maple	WM5528 SD	3			
Veta Shadows	VE6001 T	3			
Veto Proof	RK7002 T	3			
Violine	S3055 T	3			
Visible Vava	VA2001 T	3			
Vision Vava	VA2002 T	3			
Vous Fawn	VS2001 T	3			

Lok

Pionite Laminate

JSI offers an extensive program for laminates beyond our Standard Program. Always reference our website for the most current listing when using a Graded-In Laminate, on page 5 select the color of the PVC edge color.

Laminate	Pattern #	HPL	Laminate	Pattern #	HPL	Laminate	Pattern #	HPL
A Good Book	WW120-WE	3	Dolphin Gray	SG246-SD	3	Mellow Marron	AT965-SD	3
Abraham	MG130-SX	3	Earle Gray Sorbe	WZ160-WE	3	Mercury	SG204-SD	3
Absolute Acajou -Textured Suede	WY160-SD	3	Eggshell White-Suede	CW803-SD	3	Meteoritic Metallo	AG180-SD	3
Absolute Acajou - Timberline	WY160-TL	3	Eggshell White -Textured Suede	SW803-SD	3	Millwork Cherry	WC431-PV	3
Afternoon Nap	WA120-SD	3	Estella	AG011-SD	3	Mineral Talc	AG381-SD	3
Afternoon Showers	HP360-SD	3	Faded Memories	ME100-SD	3	Mocha Almond Fudge	WX600-SD	3
Agatha	AT181-SD	3	Fine Oak	WO951-SD	3	Molten Lava	WP130-SD	3
Aimtoo Savatre	WC115-SD	3	First Kiss -Fineline	SR537-FL	3	Moon Dust	MG115-SX	3
Almond -Textured Suede	ST655-SD	3	First Kiss -Textured Suede	SR537-SD	3	Moonlighting Papel	AV971-SD	3
Amber Curly Maple	WM221-SD	3	First N Main	AG031-SD	3	Moss Gray	SG240-SD	3
America's Pastime	WE360-SD	3	Folkstone Gray	SG241-SD	3	Mud Pie	AT970-LR	3
Angel White -Textured Suede	CW826-SD	3	Formal Mahogany	WY031-SD	3	Navajo Red	SR505-SD	3
Anigre	WX041-SD	3	Forsythia	SY913-SD	3	Navy Blue	SB007-SD	3
Appears Likatre	WP115-SD	3	Frederick	MT310-GR	3	Negotiating in Geneva	PFA60-SD	3
Arctic Flash	ME051-SD	3	Fresh Cut Grass -Textured Suede	SV750-SD	3	Nubian Brown	ST604-SD	3
Ash Gray	SG254-SD	3	Galactic Dust	MG180-SD	3	Oiled Cherry	WC421-SD	3
Azzurra	AB081-SD	3	Ginger Snap	AY120-SD	3	Old Friend	AG415-SD	3
Backwoods Sycamore	HP689-SD	3	Gold Pannin	AT710-SD	3	Olive Organix	AV674-SD	3
Bankers Gray -Textured Suede	SG214-SD	3	Grandiose Grid	AT106-SD	3	Opti Gray	SG213-SD	3
Beachcomber	AT988-SD	3	Graphite Spektrum	AE021-SD	3	Opto Printatre	WX230-SD	3
Beige Linen	AT301-SD	3	Graphite Talc	AG361-SD	3	Ornate Oak	WO095-SD	3
Bernard	MG071-GR	3	Graveyard of the Atlantic	AG611-SD	3	Passin Through	AV250-SD	3
Bittersweet	SO312-SD	3	Greige -Textured Suede	SG210-SD	3	Peach Cobbler	WT850-SD	3
Black Forest Cake	WX440-SD	3	Gridlock in L.A.	PFA51-SD	3	Peanut Brittle	WZ150-SD	3
Black -Textured Suede	SE101-SD	3	Gunstock Savoy Walnut	WW971-SD	3	Pearl of the Orient	AG601-SD	3
Blueberry Hill	SB040-SD	3	Happy Hour	AB400-SD	3	Pearwood	WX031-SD	3
Butter Toffee	WC230-PV	3	Hardrock Maple	WM791-SD	3	Pepperdust	HP451-SD	3
Cake Batter	AG500-LR	3	Harold	MG120-SX	3	Picnic In The Park -Super Matte	WA030-SM	3
Cardamom Fiber	AG371-SD	3	Hazel	MT390-SX	3	Picnic In The Park - Textured Suede	WA030-SD	3
Carnation White -Ashwood	SW806-AW	3	Head Over Heels -Fineline	AB300-FL	3	Polar Cap	MW570-SL	3
Carnation White -Textured Suede	SW806-SD	3	Head Over Heels -Textured Suede	AB300-SD	3	Pralines & Cream -Fineline	WW160-FL	3
Catching Fireflies	WA110-SD	3	Hearth Oak	WO862-SD	3	Pralines & Cream - Textured Suede	WW160-SD	3
Cavalcade South	AT650-SD	3	Hedgerow	MG170-SL	3	Primary Red	SR520-SD	3
Celery Fiber	AV751-SD	3	Honey Maple -Textured Suede	WM951-SD	3	Primary Yellow	SY914-SD	3
Chamomile Fiber	AT291-SD	3	Ice Fishin	WF181-SD	3	Pumice	SG203-SD	3
Charcoal Chromatix	AE011-CR	3	Ice White	SW813-SD	3	Pyrenees Marble	ME011-GL	3
Chocolate Malt	WC210-PV	3	IL Palio Papel	AV981-SD	3	Rock Around the Clock	MT340-SD	3
Cinder Gray Concrete	AG471-SD	3	Indigo Blue	SB006-SD	3	Rock Around the Clock II	MT500-SD	3
Cinnamon Noce	WW601-SD	3	Ingot Gray	SG211-SD	3	Rock of Ages	AW141-SD	3
City of Lights	MT330-SD	3	Jewel Mahogany-Textured Suede	WY351-SD	3	Rocky Mountain High	AT161-SD	3
Clear Ash	WA001-SD	3	Jumping In Puddles	AG801-SD	3	Royal Blue	SB009-SD	3
Coastal Cottage	WC652-WE	3	Kingsley-Aged Bark	WW011-AB	3	Royal Burgundy	SP401-SD	3
Connected Cubes	AT440-SD	3	Kingsley -Textured Suede	WW011-SD	3	Sable	AG021-SD	3
Cookies & Cream	AG130-SM	3	Leave Likatre	WP120-SD	3	Sage Coral	AV781-SD	3
Cool Autumn Night	WT880-SD	3	Licorice Stick	WP140-SD	3	Seems Likatre	WP125-SD	3
Coriander Fiber	AT981-SD	3	Limestone	SG208-SD	3	Shaker Cherry	WC521-SD	3
Cornwall	MT440-SD	3	Little Black Dress	AE100-PV	3	Sherwood Oak	WO891-SD	3
Crackle Crunch	WO680-LZ	3	Looks Likatre	WP110-SD	3	Shooting Star	AG041-SX	3
Cradle of Liberty	AB221-SD	3	Louise	MR120-SX	3	Silvio	WY131-SD	3
Cressida	AT371-SD	3	Love Letters	AW300-SD	3	Sipping Seattle Java	PFA48-SD	3
Crisscross	AT660-SD	3	Lunar Legno	WX800-SD	3	Slate	SG228-SD	3
Cubicle Papel	AG561-SD	3	Macadamia Nut	AG071-SD	3	Sleeping In -Textured Suede	WT870-SD	3
Daydreaming	AG750-SD	3	Man On The Moon	MT250-SD	3	Sleeping In -Timberline	WT870-TL	3
Dining By Candle Light	WA090-SD	3	Manila Linen	AT231-SD	3	Smooth Paddlin	WX110-SD	3

LOK

Pionite Laminate (Continued)

JSI offers an extensive program for laminates beyond our Standard Program. Always reference our website for the most current listing when using a Graded-In Laminate, on page 5 select the color of the PVC edge color.

Laminate	Pattern #	HPL
S'mores	WP500-LZ	3
Spice Walnut	WW561-SD	3
Springtime	SV709-SD	3
Stargazing	AE060-SD	3
Stonedust	SG224-SD	3
Storm Gray	HP565-SD	3
Sugar Maple II	WM115-SD	3
Sugar Pie	AG081-SM	3
Summer Vacation - Textured Suede	SB027-SD	3
Sunset	HP336-SD	3
Sweet 16 -Fineline	SR525-FL	3
Sweet 16 -Textured Suede	SR525-SD	3
Tailgating	WT860-SD	3
Taj Teak	WT741-SD	3
Taupe	ST606-SD	3
Tea Party in Boston	PFA42-SD	3
Theodore	MR125-SX	3
Thunderstorm	HP359-PV	3
Tiramisu	WX170-SD	3
Toasted Coconut	WZ460-WE	3
Travelin Light	AT680-SD	3
Upland Stone	MG160-SL	3
Vana	WF131-SD	3
Vanilla Fiber	AW871-SD	3
Victorian Cherry	WC331-PV	3
Viola	AT191-SD	3
Walnut Grove -Textured Suede	WW050-SD	3
Walnut Grove -Timberline	WW050-TL	3
Wedding Cake -Barnboard	WT790-BB	3
Wedding Cake -Textured Suede	WT790-SD	3
Wheat Fiber	AT991-SD	3
White Elm -Super Matte	WE261-SM	3
White Elm -Textured Suede	WE261-SD	3
White Fiesta	MW550-SD	3
White	SW811-SD	3
White Spektrum	AW785-SD	3
Winter White -Textured Suede	SW836-SD	3
Wisconsin Oak	W0581-SD	3
Witchcraft -Polished Velvet	WX421-PV	3
Yorkshire Cherry	WC411-SD	3

Wilsonart Laminate

JSI offers an extensive program for laminates beyond our Standard Program. Always reference our website for the most current listing when using a Graded-In Laminate, on page 5 select the color of the PVC edge color.

Laminate	Pattern #	HPL	Laminate	Pattern #	HPL	Laminate	Pattern #	HPL
Almond Leather	2932-60	2	Hampton Walnut	7959K-78	3	Polished Concrete	5022K-22	3
Amaretto Pine	8224K-16	3	Harvest Maple	7953-38	2	Port	D14-60	2
Amber Cherry	7919K-78	3	High Rise	4996-38	2	Portico Teak	8210K-28	3
Antique Bourbon Pine	8215K-12	3	Hollyberry	D307-60	2	Potter's Clay	5011K-22	3
Antique Marula Pine	8216K-28	3	Huntington Maple	7929-38	2	Pressed Linen	4991-38	2
Antique White-Matte	1572-60	2	Indigo	D379-60	2	Putty	1503-60	2
Asian Night	7949K-18	3	Irish Linen	4993-38	2	Raw Chestnut	7975K-12	3
Asian Sand	7952K-18	3	Island	D498K-18	3	Raw Cotton	4947-38	2
Asian Sun	7951K-18	3	Italian Silver Ash	8217K-16	3	Regimental Red	D12K-18	3
Astro Strandz	4940K-18	3	Khaki Brown	D50-60	2	Rio	7947K-18	3
Atlantis	D25-60	2	Kingswood Walnut	8218-38	2	River Cherry	7937-38	2
Bannister Oak	7806-60	2	Landmark Wood	7981K-12	3	Rugged Linen	4989-38	2
Battleship	5014K-19	3	Lapis Blue	D417-60	2	Rustic Slate	4888-38	2
Beige	1530-60	2	Light Beige	1531-60	2	Sable Soapstone	4883-38	2
Beige Pampus	4170-60	2	Light Oak Ply	8202K-28	3	Saddle Oak	8206K-16	3
Beigewood	7850-60	2	Limber Maple	10734-60	2	Sap Walnut	8221-38	2
Biltmore Cherry	7924K-07	3	Linen	D427-60	2	Satin Stainless	4830K-18	3
Black	1595-60	2	Loden Zephyr	4844-60	2	Shadow Zephyr	4857-60	2
Black Alicante	4926K-07	3	Loft Oak	7968K-12	3	Shaker Cherry	7935K-07	3
Blackbird	5024K-19	3	Low Line	7998K-18	3	Sheer Mesh	4876-38	2
Blackened Chestnut	8223K-12	3	Lowell Ash	7994-38	2	Sierra Cascade	5005-38	2
Blue Agave	4919-60	2	Madagascar	7944K-07	3	Silicon EV	4811-60	2
Boardwalk Oak	7983-38	2	Magnolia	5012K-19	3	Silver Alchemy	4860K-07	3
Branded Oak	8207K-16	3	Mambo	7948K-07	3	Silver Oak Ply	8203K-28	3
Brittany Blue	D321-60	2	Mangalore Mango	7984-38	2	Skyline Walnut	7964K-12	3
Bronze Legacy	4656-60	2	Manitoba Maple	7911-60	2	Soft Gold Mesh	4911-38	2
Buka Bark	7982-38	2	Marmo Bianco	1885K-07	3	Solar Oak	7816-60	2
Burnished Chestnut	4796-60	2	Maroochy Brush	4745-60	2	Sprout	4918-60	2
Calcutta Marble	4925K-07	3	Midnight	D505-60	2	Steel Mesh	4879-38	2
Canyon Zephyr	4842-60	2	Mission Maple	7990-38	2	Sterling Ash	7995-38	2
Carbon EV	4820-60	2	Misted Zephyr	4843-60	2	Tailored Linen	4992-38	2
Carbon Mesh	4880-38	2	Montana Walnut	7110K-78	3	Tan Echo	7941K-18	3
Castle Oak	7928-38	2	Monticello Maple	7925-38	2	Tan Soapstone	4887-38	2
Casual Linen	4944-38	2	Morelia Mango	7985-38	2	Tangerine	4915-60	2
Cement	D503-60	2	Morro Zephyr	4846-60	2	Tawny Legacy	4663-60	2
Classic Linen	4943-38	2	Mushroom	5013K-19	3	Titanium EV	4810-60	2
Cloud Nebula	4630-60	2	Natural Almond	D30-60	2	Tungsten EV	4814-60	2
Cloud Zephyr	4856-60	2	Natural Cotton	4946-38	2	Tuscan Walnut	7921-38	2
Cocobala	7942K-07	3	Natural Nebula	4633-60	2	Twilight Zephyr	4845-60	2
Coffee Bean	D495-60	2	Natural Pear	7061-60	2	Uptown Walnut	7971K-12	3
Colombian Walnut	7943K-07	3	Natural Recon	7996-38	2	Vapor Strandz	4939K-18	3
Cosmic Strandz	4941K-18	3	Natural Rift	7954-38	2	Veranda Teak	8209K-28	3
Crisp Linen	4942-38	2	Natural Tigris	4669-60	2	Versailles Anigre	7923K-07	3
Crystal	D388-60	2	Navy Legacy	4651-60	2	Wallaby	D439-60	2
Desert Zephyr	4841-60	2	NeoWalnut	7991-38	2	Warehouse Oak	7969K-12	3
Ebony Char	8205K-16	3	Nepal Teak	7209K-78	3	Washed Char	8222K-16	3
Ebony Recon	7997-38	2	Neutral Glace	4143-60	2	Washi Crystal	5017-38	2
Eggplant	4913-60	2	New Age Oak	7938-38	2	Washi Gold	5019-38	2
Evening Tigris	4674-60	2	Nickel EV	4813-60	2	Washi Pewter	5018-38	2
Fashion Grey	D381-60	2	Nightfall	5023K-19	3	Weathered Char	8204K-16	3
Fawn Cypress	8208K-16	3	Nordic Linen	5015-38	2	White Barn	7977K-12	3
Field Elm	7999K-12	3	North Sea	D90-60	2	White Carrara	4924-38	2
Figured Mahogany	7040K-78	3	Ocean	D502K-18	3	White Cascade	5003-38	2
Fired Steel	4994-60	2	Oiled Soapstone	4882-38	2	White Cypress	7976K-12	3
Flax Linen	4990-38	2	Old Mill Oak	7973K-12	3	White Driftwood	8200K-16	3
Fonthill Pear	10745-60	2	Orange Grove	D501-60	2	White Nebula	4621-60	2
Forged Steel	4995-60	2	Organic Cotton	4945-38	2	White Sand	D403-60	2
Fossil Shale	D504-60	2	Oxide	1787-60	2	White Tigris	4783-60	2
French Linen	5016-38	2	Palisades Oak	7987-38	2	White-Matte	1570-60	2
French Pear	8220-38	2	Pampus	4166-60	2	Wild Cherry	7054-60	2
Fusion Maple	7909-60	2	Park Elm	7967K-12	3	Windsor Mahogany	7039K-78	3
Gesso Tracery	4962-38	2	Pasadena Oak	7986-38	2	Windswept Bronze	4794-38	2
Glided Mesh	4912-38	2	Pearl Soapstone	4886-38	2	Windswept Pewter	4795-60	2
Graphite Nebula	4623-60	2	Pepperdust	D327-60	2	Woolamai Brush	4746-60	2
Green Soapstone	4885-38	2	Pewter	D73-60	2	Xanadu	7945K-18	3
Green Tigris	4667-60	2	Pewter Brush	4779-60	2	Zanzibar	7957K-78	3
Grey	1500-60	2	Pewter Mesh	4878-38	2	Zebrawood	7980K-18	3
Grey Elm	8201K-12	3	Phantom Charcoal	8214K-28	3			
Grey Glace	4142-60	2	Phantom Cocoa	8213K-28	3			
Grey Mesh	4877-38	2	Phantom Ecru	8212K-28	3			
Grey Nebula	4622-60	2	Phantom Pearl	8211K-28	3			
Grey Pampus	4168-60	2	Pinball	4937-38	2			

LOK

price list

effective April 3, 2023

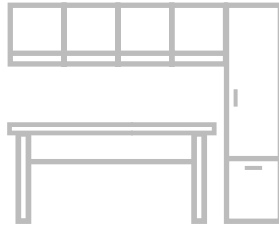
SEATING



JSI Price Lists

Tables + Casegoods

[Apogee](#)
[Bourne Tables](#)
[Brogan](#)
[Collective Conference](#)
[Finale](#)
[Lincoln](#)
[Native](#)
[Nosh](#)
[Privacy Program](#)
[Prost](#)
[Reef](#)
[Romy](#)
[Strata](#)
[Traditional](#)
[Trail](#)
[Walden](#)
[Wellington](#)
[Accessories](#)



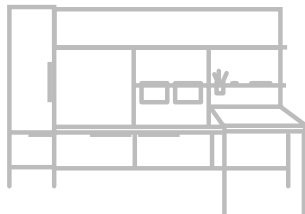
Lok

[Training Tables](#)
[Teamwork Tables](#)
[Conference Tables](#)
[Occasional Tables](#)



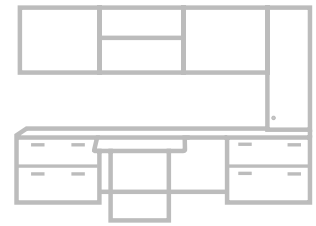
Flux

[Private Office](#)



Vision

[Casegoods](#)
[Tables](#)



Seating

Addison	Madison
Americana	Melrose
Ansen	Millie
Arwyn	Moto
Avalon	Murphy
Avini	Newton
BeSpace	Oxley
Boston	Pillow
Bourne Seating	Poet
Bryn	Protocol
Caav	Proxy
Cabaret	Ramona
Class Act	Ria
Collective Motion	Sosa
Connect	Tara
Encore	Teekan
Esque	Totem
Finn	Trinity
Finn Nu	Tyler
Garvey R5	Wink
Gatsby	Ziva
Harbor	
Hoopz	
Indie	
Jude	
Knox	
Kyla	
Laurel	
Mackey	



Environmental Mission

Our vision and goal is a sustaining supplier, manufacturer and customer for the long term protection and preservation of our environment for future generations.

MISSION

To achieve this vision, we are dedicated to ensuring the health and wellbeing of all of our partners, reducing negative impact on the environment, and maintaining price structure by increasing efficiencies and reducing consumption.

JSI, and it's parent company, is an internal manufacturer and has been an environmentally conscious organization for more than 80 years.

We are proud to use wood as our primary sustainable material resource and all corporate policies and procedures support the efforts to "recover, recycle, reuse, repurpose, reduce, refuse, and re-engineer". In doing this, we are committed to the conservation of the environment and its natural resources as well as encouraging our suppliers and customers to do the same. A goal of a "Sustainable Partnership", supplier, manufacturer and customer, is essential for the long term protection preservation and sustainability of our environment for future generations.

LOCATION

Our manufacturing facilities are located in the center of Southern Indiana. With our diverse product offering and manufacturing capabilities, we provide a single source for all of your project needs allowing you to conserve our fossil fuels and reduce greenhouse gases.

PACKAGING

We place emphasis on the minimal use of disposable packaging while still providing adequate protection to the finished product. Our corrugated packaging is recyclable, reusable, and up to 100% recycled content. We reuse or recycle more than 175 tons of corrugated material annually.

REGULATORY

All of our manufacturing facilities are in compliance with applicable OSHA regulations and meet or exceed all applicable DEM and EPA regulations for air emissions, storm water and hazardous waste disposal.

MANUFACTURING FACILITIES

Our manufacturing facilities are geared toward eco-efficiency and are encouraged to continually improve and conserve. Solid wood not used in the direct manufacturing process is recovered for the operation of our dry kilns, thus reducing greenhouse gases, the use of fossil fuels, and the burden of waste placed on landfills. Composite panels not used in the direct manufacturing process are ground and sold for use as animal bedding and boiler fuel. In addition to other energy savings techniques, our manufacturing facilities use high efficient lighting, make use of power factor capacitors, and encourage all to conserve and reduce energy consumption and water usage. Condensation pumps are used to aid in water conservation as well as extending boiler life.

MANUFACTURING PROCESSES

Our finish processes utilize efficient spray guns and proper spray techniques to reduce wasted material. Excess finish material, solvents, and waste are recycled. Many of the assembly processes use water based glues that contain no hazardous ingredients.

TEXTILES

Many of our fabric options utilize up to 100% recycled content. Our leather alternative program includes selections that contain no toxic materials, plasticizers, heavy metals, or formaldehyde and have a 100% biodegradable back cloth. Some of the available panel fabric used, if discarded is a biological nutrient for the soil. Most of the components (foam, batting, and polycord) used in upholstered products are recyclable. Excess fabrics and leathers not utilized in the upholstery process go to recyclers and local charities for additional use.

WOOD

Wood is the most diverse, most process friendly, and most widely utilized natural resource in mankind's history. No other natural resource can match the environmental advantages of wood, including being renewable, recyclable, natural, carbon negative, and biodegradable. Utilizing the sun's energy, trees grow and remove carbon dioxide from the air while giving off oxygen to benefit the entire planet. Approximately 49% of wood's dry weight is carbon and harvesting mature trees in a sustainable forest, which has slowed in the absorption of carbon dioxide, allows the photosynthetic cycle to continue at full optimization and allow for the carbon to remain sequestered. We are proud to use wood as our primary "sustainable" renewable resource.

WOOD OPTIONS

Many environmentally friendly solid wood and engineered wood options are available for quote, including: Lyptus®, Plyboo®, reclaimed woods, agricultural and post-consumer waste fiber products, etc.

INDOOR AIR QUALITY

Our goal is to reduce the impact our products will have on the indoor air quality. We practice the latest technologies and utilize a third party to assure we meet this goal. GreenGuard, one of the leaders in IAQ certification, continues to certify our product offering with UL2818 - GreenGuard Indoor Air Quality certification.

PARTNERSHIPS

BIFMA
Business and Institutional Furniture Manufacturer Association

USGBC

United States Green Building Council

IIDA

International Interior Design Association

FSC

Forest Stewardship Council - Forestland

UL GreenGuard

Indiana Department of Natural/Resources - Division of Forestry - Classified Forest, Wildlands Program

Lifetime Warranty

JSI warrants to the original purchaser that each piece of furniture will be free from defects in workmanship, given normal use and care for as long as the original customer owns and uses the product. Normal use is defined as the equivalent of a single shift, 40-hour work week.

JSI will, at its option, repair or replace with comparable product within the terms of the warranty.

Exceptions to Warranty:

12 Years (from date of purchase)

- Wood Seating
- Seating Controls
- Veneer Surfaces
- Laminate Surfaces
- Pneumatic Cylinders

5 Years (from date of purchase)

- Glides · Casters · Task Lights
- Mesh/Knit Material · Foam
- Florette Plastic Frame Chairs
- Electrical Components
- Electric Height Adjustable Bases

This Warranty Does Not Cover:

- Natural variations in color, grain or texture of wood and other covering materials over which JSI has no control.
- Normal wear, color fastness, shrinkage, puddling, wrinkling and stretching of upholsteries including fabric, vinyl, leather and other textiles. This warranty does not cover any defects that may arise in the use of COM or COL upholstery materials. Textile manufacturer's warranty will apply.
- Damages resulting from transportation, improper assembly, installation, handling, accident, user modification attachments, misuse, or neglect of product care.
- Damage resulting from extreme climate conditions.
- Finish damages resulting from normal wear and tear, improper maintenance, water damage, exposure to sunlight, extreme high or low humidity or temperature, or other acts of nature.
- Damage created by loading file drawers with anything other than hanging folders.

JSI makes no expressed or implied warranties to any product and, in particular, makes no warranty of merchantability or fitness for any particular purpose. JSI will not be liable for any consequential or incidental damages under this warranty.

Unique Characteristic of Natural Woods and Veneers

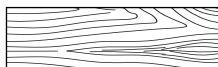
JSI uses high quality wood and veneer harvested from sustainably managed forests. Every tree has unique and defining characteristics, like fingerprints. These characteristics can be defined by differences in color, grain configuration, and textures. These characteristics will be more noticeable if the product has a clear or lighter finish.

Maple and Cherry species have a higher degree of uneven distribution of grain, small color streaks, and pin knots.

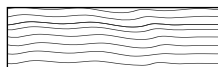
At JSI, we take care of selecting woods and veneers that are used in our products. With this in mind, we hope you appreciate the beauty of each tree's fingerprints. Products will not be replaced due to these natural characteristics.

Veneers can be sliced in a variety of ways to create unique patterns. JSI uses several different patterns, as shown below.

Flat (Plain) Cut as shown in diagram



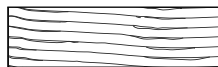
Quarter Sliced as shown in diagram



Double Cut as shown in diagram



Rift Cut as shown in diagram



Double Cut

The Double Cut veneer is a processed product that has at least two cuttings to create the final veneers. These cuts of veneer strands are dyed and layered into a block to create variation of patterns from a very tight grain pattern to an exotic figure grain pattern.

JSI uses select beech, cherry, maple, oak and walnut cut wood products to produce the desired look of our furniture products.

Laminates (Veneer Series)

An alternative HPL (Higher Pressure Laminate) laminate work surface can be specified on most of our casegood product lines. The specification pages will also list the available coordinating finishes.

Laminate Series

JSI laminate series offer a full laminated product with imprinted grain to hide finger prints and provide durability. The worksurface tops are HPL (High Pressure Laminate) or TFL (Thermal Fused Laminate). TFL is used on the product's chassis.

Please reference the featured highlights of each product line to identify the species, grain patterns, finishes for that product series

Finish - Top Coat

To reduce hazardous formaldehyde emissions, we use our proprietary specially designed top coat, DuraTex™. It significantly reduces hazardous formaldehyde emissions and helps improve indoor air quality.

Finish - Color/Stains

A wide range of stains are available to bring out the beautiful characteristics of each wood species. We coordinate finish color between our veneer stains and solid lumber stains; however, not all may be a perfect match. The stains are continually reviewed for accuracy of color, as well as a constant monitoring of the latest color trends in the furniture market.

Finish - Matching

Due to the natural characteristics of wood, environmental effects, and material upgrades, JSI cannot guarantee exact finish matches on existing furniture previously ordered.

If an exact match is required to accompany existing furniture, it must be specified at the time of order placement, so specific internal procedures can be followed to ensure a proper and acceptable finish match. We reserve the right to change our finish formula at any time to improve safety, quality, and appearance. Unless a finish match for existing furniture is requested at the time of ordering, we accept no liability for finish that may not match the existing furniture from prior orders.

Solid lumber may inherently have mineral streaks, pits, and various other natural occurrences. Care is taken in selecting the solid lumber to coordinate with the requested finish on our veneer products. This internal selection process is subject to availability of solid lumber parts.

Finish Sheen

All casegood veneer finishes are standard in 35-sheen, with the exception of Raven, which is only offered in 15 sheen. All other finishes are available in 15 sheen, with a 5% upcharge, per model

Custom/Special Finishes

JSI, upon request, will accommodate special finishes. A written request is required to proceed with custom finish orders. A sample reference is required for first time matches and must be included with the written request.

There is a one time charge of **\$372 list per order** for any non-standard wood finish.

Orders will be entered noting the special finish. A sample match will be provided to the customer. Written approval is needed before the finish process can be started. Delays in approval may have an impact on lead times.

Every effort will be made to create the requested match; however, an acceptable match may not be possible because of natural variations of wood. These natural variations can also cause minor differences in the final finish product.

Samples

Samples of standard wood finishes, paints colors, metal colors, and standard laminate are available upon request. The fastest way for requests to be filled is by using our website. See below for options to request samples.

Website – jsifurniture.com (click the resource tab)
JSI Sales representatives
Phone – 800.457.4511 – Customer Service
Email – customerservice@jaspergroup.us.com

Pricing

Prices found in this document or on our website are list prices in U.S. dollars for standard product delivery to one destination. Prices do not include storage, installation, or taxes. Possession of this price list does not constitute an offer to sell. Orders can only be received from approved authorized JSI dealers.

Prices and product information in this document, as well as our website, are subject to change without notice. Reference website for most up to date product offering and pricing.

Orders

Detailed specification pages are available in the price list at the beginning of each series.

Additional information may be obtained by consulting the Customer Service Department or our website.

Indicate shipping address if different from billing address.

Send Orders To:

US Mail – JSI
225 Clay Street
Jasper, IN 47546
Fax – 812-482-1548
Email – orders@jaspergroup.us.com

JSI reserves the right to make changes in dimensions, styles, or specifications if we believe these changes will improve the safety, quality, or appearance of the product.

Acceptance of orders will be subject to credit approval, barring any acts of governments, or any other causes beyond our control (e.g. strikes, fire, embargo of materials, etc).

Product Modifications

While we offer a wide range of products to accommodate many possible solutions, we also recognize the needs for our products to be modified from our standard offering.

In the series introduction section of each product, we address modification options for that series.

To see if the desired modification is possible, please contact our Customer Service Department for a quote. Note that order quantities and material availability can affect the quote. Additional information may be requested to fully quote modifications.

Order Acknowledgments

All orders will be acknowledged promptly upon entry of a clean order. The acknowledgment will show how the order was entered, ship date and any other information pertinent to the order. It is the purchaser's responsibility to verify all the information on the acknowledgment carefully and notify us immediately, in writing, of any discrepancies.

Every reasonable effort is made to ship as acknowledged; however, the acknowledged ship date is approximate. Company will generally ship within five (5) working days of the acknowledged ship date. If a firm ship date is necessary, customer must inform company at time of order and company will make all reasonable efforts to meet each customer's request. Acknowledged shipping dates are contingent upon the force majeure conditions contained in these terms and conditions.

Quickship

JSI offers select Vision models, with select options, in our Quickship program. These items ship within 10 business days after receipt of a clean, credit approved purchase order. Items should be placed on order separate from standard lead time models.

Product for up to 10 offices or 10 tables can be included on a single Quickship order. Available capacity is filled by orders as they are received. If normal 10 day Quickship is not available because capacity has been filled, you will be immediately notified by JSI customer service. Changes and cancellations to Quickship orders are not allowed under any circumstances, nor are modifications to the predetermined Quickship offering. Limit one order per project.

Delivery

Our freight policy consists of prepaid freight to the 48 contiguous states; all other shipments are prepaid to port of exit ONLY. JSI reserves the right to select the appropriate carrier and shipment routes, most shipments are on freight carriers that are dedicated furniture specialists. Standard deliveries require a DOCK that can accommodate **75 foot trucks**. Ownership and inspection of product is the responsibility of the buyer upon pickup by the freight carrier. Pricing in this book is for standard delivery only. Standard delivery does **not** include non-dock delivery, inside delivery, residential delivery or installation of product. Fees and changes for non-standard deliveries are listed below.

Standard Delivery Time

Between 8AM and 3PM Monday through Friday. Special delivery requests can be subject to additional fees to accommodate requests.

Cancellations and Changes

All orders are considered firm and are not subject to cancellation or change without approval from JSI. All approved changes are subject to additional charges and revised lead times

No Touch Freight

Our freight is considered "no touch". Therefore, customers are to be prepared to unload freight from inside the truck prior to arrival. In the instance that a driver must unload the shipment, driver assists fees will apply (see fees below).

On-Site Deliveries

Shipments to the installation site, and time deliveries are available on full truckloads or slightly less, at no additional charge. Shipments or timed deliveries for smaller shipments may not be available, or if available may require an additional charge.



Detention Fees

- Carriers are given two-hour maximum time allotment to unload for one-stop truckloads.
- Carriers are given one hour maximum time allotment to unload for multi-stop truckloads
- *Detention fees apply after allotted unloading time and will be at buyer's expense.

Fees

Orders of less than \$1,000 net \$90 net per order
 (If order is UPS shippable, the handling fee is waived and customer is invoiced for exact shipping charges.)
 Weekday deliveries outside of standard delivery times \$300
 Weekend deliveries (Saturday or Sunday) \$600
 Liftgate Deliveries. \$500 minimum 7% of net price
 Driver Assist \$90
 Jobsite Non-Dock Delivery \$150 per truck
 Inside Delivery (first floor inside only) - no installation or carton removal. \$250 minimum 7% of net price
 NO RESIDENTIAL DELIVERIES

Warehouse/Storage Fees

Additional storage time with a provided two-week approved notice is calculated at 3% per month of the product amount or per day.

Please be Advised

- Reconsignment fees are the responsibility of the buyer.
- Any charges arising from failure to meet shipment, re-routing while in transit or carrier storage charges are the responsibility of the buyer.
- Contact Customer Service to inquire about skidding of products, special crating of products and product installation. These requests must be approved by JSI and made at the time of order.
- Carriers have the right to refuse delivery to a specified location if it conflicts with their liability policy.

Freight Damage

JSI products are packed in cartons and meet or exceed existing codes for furniture and seating products. All shipments are delivered to the carrier in good condition and our liability ceases thereafter. If delivery arrives short or damaged, contact the carrier immediately to file a claim. In the event of concealed damage, notify the carrier and request immediate inspection. Failure to file a claim within 15 days after receipt of merchandise constitutes acceptance and a waiver of any such claims. Please inspect merchandise immediately upon receipt, otherwise there is no recourse. Keep all cartons and packing material, discarding these materials may negate your claim.

Storage of product in areas of uncontrolled humidity and temperature may cause damage to the product and void the JSI warranty.

Repairs

JSI will not issue credit allowance for any type of repairs without prior written consent.

Sales order, product model numbers, and reason for repair will be expected in order to process the repair request. A digital photo will help to expedite the request. JSI reserves the right to recommend solutions for repair.

Replacement Parts

Obtain information and pricing on replacement parts by contacting Customer Service. Please have the model number available when requesting replacement parts. Additional information may be required to ensure proper replacement parts.

Returns

JSI products are made to order and may not be returned for credit. No merchandise may be returned to JSI without a signed Return Good Authorization (RGA) form issued by our Customer Service Department. RGA's will be considered for the following reasons:

1. Manufacturing defect (validated by JSI representative).
2. JSI order processing error.
3. Shipping error.
4. Mis-marked cartons.
5. Duplicate shipments.

Liability for defective merchandise shall be limited to replacement or repair.

If you have questions as to whether your reason for return qualifies for consideration, please contact Customer Service. At the discretion of JSI, returns on stocked items may be considered with the following stipulations:

1. 60% restocking fee.
2. All return freight charges must be prepaid by dealer.
3. Product was never removed from the original carton.
4. Product must be returned within 30 days of RGA issue date.
5. Credit will not be issued if product returned is damaged.
6. Under no circumstances can we accept COD (Cash on Delivery) returns. Any such shipment will be refused.

Please note most models on Quickship are produced on demand and cannot be returned. Modified, special or custom-built product is not eligible for return.

Fire Retardancy

All JSI upholstered components comply with California Bureau of Home Furnishings and Thermal Insulation-Technical Bulletin 117-2013 issued by State of California Department of Consumer Affairs. This standard requires upholstered furniture to be safer from the hazards associated with smolder ignition in all four (4) categories of materials, as applicable.

Compliance with more stringent codes may require special manufacturing considerations and upcharges.

California Technical Bulletin 133 (CAL 133)

JSI uses a barrier material between the foam cushioning and the upholstery cover in order to comply with CAL 133. The standard upcharge on products specified to comply with CAL 133 is **\$78 list per yard** of textile.

JSI has performed a series of full scale fire tests on samples - representing worst case scenarios of upholstered units - to comply with the requirements of the state of California Technical Bulletin 133 (CAL 133). Products in compliance are labeled in accordance of the standards.

Some product designs and fabric cannot be combined to comply with CAL 133. Because of this, we reserve the right to reject any request for an upholstery cover, including COM, textile may not contain olefin or product style that we feel may compromise the integrity or safety of a product specified to comply with CAL 133.

Contact Customer Service for a quote if you require laboratory certification that a specific product and upholstery combination WILL PASS CAL 133. The quotation will include testing, video, and transportation charges plus the list cost of the sample.

Our standard lead time will apply to products that do not require certification. Allow an additional six weeks over the standard lead time for products that need actual laboratory certification.

The end user, specifier and/or dealer have the responsibility to make sure all products specified will meet the flammability and safety codes of the jurisdiction where the products will be located and used.

Flame Spread

All JSI may be required to comply with the requirements of Flame Spread based on ASTM standards/NFPA Life Safety Codes and general public knowledge are as follows:

Solid Wood - Class C
 Topcoats - Class A
 Carded Fabric - Class A
 Composite Panels - Class C
 Laminate - Class B

Plastics - According to the NFPA, the lack of stability of plastics under high temperature conditions and inherit combustibility have eliminated the use of plastics for applications requiring a flame spread rating.

Also be advised that improvements may be attained in certain instances with the addition of chemicals which may add additional costs, chemical exposure and/or compromise the integrity of the product.

Textile Carded Programs

JSI is proud to partner with Maharam, Momentum, Spradling, Stinson, Ultrafabrics, Camira and Cortina Leather. Please refer to our website for our standard patterns, along with the current grade.

<https://www.jsifurniture.com/finishes-and-materials/textiles>

Textile Grade-In Programs

For the convenience of our specifiers, we offer an extensive graded in program. Please reference our website for the most up to date information on our graded in program.

<https://www.jsifurniture.com/resources/textile-partner-info/overview/>

For additional specifications on the pattern or to order memo samples, please contact the textile suppliers directly:

Arc Com www.arc-com.com
 Camira www.camirafabrics.com
 Designtex www.designtex.com
 Maharam www.maharam.com
 Mayer www.mayerfabrics.com
 Momentum www.themomgroup.com
 Spradling www.spradlingvinyl.com
 Stinson www.cfstinson.com
 Ultrafabrics www.ultrafabricsllc.com
 Cortina Leather www.cortinaleathers.com

Any textile not graded in or pre-approved for COM/COL will require application test approval prior to order entry and shipment of fabric or leather to JSI. For current JSI grades and application status by series visit jsifurniture.com Resources > Graded-In + COM; jsifurniture.com Resources > Graded-In + COM.

Indicate on purchase order if JSI is to order the fabric.

Grades and availability of fabric are subject to change without notice. Changes could include but are not limited to price increase, discontinued patterns, discontinued colors, etc. See jsifurniture.com for up to date information.

Many textiles have repeats and the additional yardage required has been factored in for textiles ordered through the JSI Carded and Grade-In Programs. We reserve the right not to match textiles with a horizontal or vertical repeat greater than 17". Additional charges may apply for textile being applied with special instructions.

Some fabric thickness or stiffness may cause issue with proper upholstering of tackable wall panels or upholstery privacy screens. Please contact customer service with concerns on the fabric thickness for these items.

COM/COL Address

JSI
 Attn: COM/COL Department
 Receiving B
 Dock 71
 201 East Martin St.
 Orleans, IN 47452

Tag: Dealer Name / Purchase Order #

General COM Fabric/COL Hide Policy

Refer to the COM/COL Price Columns for list prices.

All yardage requirements listed in the price list are based upon 54" plain non-directional material. Additional yardage may be required based on fabric repeat and matching.

All square footage requirements for COL are based on an average hide size of 50 square feet.

Contact Customer Service for any of the following conditions:

- + approval of COM/COL to be used (see policy on the next page)
- + fabric repeats greater than 3"
- + fabric less than 54" wide
- + leather hides smaller than 50 square feet
- + special application requirements request

When requesting information from Customer Service on COM/COL please supply the following information:

- + model number and quantity of the product the COM/COL will be applied
- + COM/COL textile supplier's name
- + name of pattern and color of the textile
- + any special application request

Visit jsifurniture.com Resources > Graded-In + COM to see if the textile has already been approved. If there is no record for this particular textile then a Memo Sample will be required.

JSI takes no responsibility when additional materials must be ordered.

COM Fabric Repeat Guide

Roll Width	Plain Fabric	1" - 5" Repeat	6" - 10" Repeat	11" - 15" Repeat	16" - 20" Repeat	21" - 30" Repeat	31" - 40" Repeat	41" - 50" Repeat
54"	0%	10%	15%	20%	25%	30%	40%	50%
53" to 51"	15%	20%	25%	30%	35%	40%	50%	60%
50" to 48"	30%	35%	40%	45%	50%	55%	70%	90%
47" to 36"	60%	65%	70%	75%	80%	85%	100%	120%

The percentage represents the additional fabric yardage that needs to be added to the COM yardage. Contact Customer Service for repeats greater than 50".

All COM/COL must meet applicable codes and regulations, including TB117-2013. By selecting COM/COL, customer certifies that the material meets such codes. JSI assumes no responsibility for the applicable codes and regulation regarding flammability rating and safety rating of any COM/COL.

JSI cannot be held responsible for receipt of defective fabrics, as we apply all COM as first quality goods.

We can take no responsibility for tailoring, wear-ability or application of COM/COL textiles. Any warranty claims for the COM/COL Textile materials will fall to the original vendor of the textile, not JSI.



COM Fabric/COL Hide Process for JSI Seating

General COM Fabric and COL Hide Policy also apply.

JSI will approve or disapprove COM/COL on all products. An approval of a textile from JSI makes no claim that performance, durability or tailoring of COM/COL will result in satisfactory upholstery. Every effort will be made to meet customer's expectation, but fabrics/leathers have unforeseen inherent characteristics that may limit JSI's ability to deliver a well tailored product.

Approval COM Textile/COL Hide Process for Seating

Follow the Steps Below:

1. Send a Memo Sample of the COM/COL (recommended memo be at least 4" x 4")

JSI

Attn: COM/COL Approval Department

201 East Martin Street

Receiving B, Dock 71

Orleans, IN 47452

2. Call our Customer Service Department at 812-482-3204 to request an electronic version of approval form.

Guide Order Form for COM and COL

Please send sample to:
JSI
Attn: COM/COL Approval Depart.
201 East Martin St.
Receiving B, Dock 71
Orleans, IN 47452

① **Order Information:**

Quote #: _____ Purchase Order #: _____

Customer Service: _____

Dealer Name/Project Name: _____

Contact: _____

Address: _____

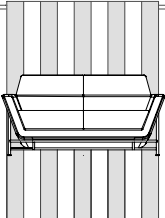
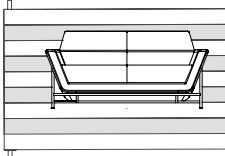
Phone: _____ Email: _____

Model Number(s) Receiving COM / COL: _____

Please forward a copy of this form to your JSI CSR for record keeping

② **Select off the bolt application:** *(Check one of the boxes)*

Up the roll (standard on most seating) Railroaded

③ **Additional information:**

④

Attach sample here.

JSI will review and test as needed all requests. You will be notified as soon as results are documented by our review personnel. JSI reserves the right to reject any COM/COL on our products. We will provide COM/COL explanation of any unapproved textile whenever possible.

Custom Options

Wood Laser Engraved Back

Many of our seating models are available with a custom wood laser engraved back. University seals, logos, unique designs, or any type of graphic can be designed into the seating back for a custom creation. Copyright approval may be required. Consult JSI Customer Service for pricing and artwork specifications. Artwork must be submitted as a JPG or PDF file.



Wood Laser Engraved Back General Pricing

* must order plain back when choosing these options

For Artwork 4" x 4" or Less	\$56 list per chair
For Artwork Less than 6" x 6"	\$99 list per chair
For Artwork Larger than 6" x 6"	Call For Pricing

For orders fewer than 50 pieces, add \$153 list per design, per order. This pricing reflects etching (leaving the wood dark). If additional painted colors are added to artwork please call customer service for pricing.

A \$134 list set-up fee applies.

Care and Maintenance

Care and Maintenance

Care of Upholstery Surfaces

Cleanability will vary based on the fabric type. For best results, a professional service is recommended. Dirt and crumbs may be gently brushed or vacuumed off. Spills should be wiped up immediately with a cloth. Vinyl textiles can be cleaned with warm soapy water and then wiped down with a warm damp cloth. For more details on any JSI carded fabric and vinyl, please visit our website at jsifurniture.com or consult the back of the appropriate swatch card for cleaning codes and any specific instructions. For COM materials, consult with the individual textile manufacturer for cleaning codes and any specific instructions pertaining to your particular fabric.

Maintenance of Mechanical Parts

Clean any lint or debris from the moving parts of the base mechanisms. Mechanisms have been designed and tested to not require lubrication under normal conditions; however, lubricant can be used if needed.

Care of Wood Edges and Veneer Surfaces

Clean all surfaces frequently with water dampened soft cloth, moving the cloth with the grain direction. Immediately remove any liquids that come in contact with wood surfaces with a blotting action to absorb liquid. Buff dry. Lift objects to move them, never pull them across the finished surface. For an additional safeguard, use a protective surface pad. This will ensure a lasting finish by protecting your furniture from possible damage caused by pens, cups and sharp objects. Avoid exposure of furniture to extremes of heat and cold, or to wide humidity variances. Avoid exposure of furniture to strong sunlight. Avoid exposure of furniture to harsh solvents such as nail polish remover, acetates, etc., as it will cause finish deterioration. If using a protective glass top, place spacer pads under the glass top to allow the wood to breath.

Care of Metal Finishes

Wash you powder-coated item at least one every six months. Use soft rags only - No abrasives. For stubborn stains and grease marks, use soap and water mixture. Combine 1 gallon of water and 1 cup of the neutral detergent in the bucket. Mix it up by swirling one of the rags around in it. Wipe down the powder coat with a rag that has been dampened with the cleaning solution. Do not scrub, but use gentle, repetitive pressure to remove any built-up grime. Rinse the powder coat off with a rag dampened with clear, clean water. Do not spray it down, but rather wipe it off with the rag. You may need to do this several times to get all the soap off. Wipe the powder coat down with a clean dry rag. This will prevent streaking and spotting.

Care of Frosted Glass

Use a clean, dry lint free cloth to wipe the surface. Follow with warm water and a clean rag; no soap or chemicals. Wipe dry with a clean, dry lint free cloth. Cleaning the frosted side is not recommended, if desired to clean use the above method but do not spray the water on the frosted side, use a clean rag. Please allow 48 hours for the frosted side to dry and not to show cloudiness.

Tempered Glass Information

JSI is aware of occasional occurrences of spontaneous glass breakage in various furniture products. Tempered glass makes it stronger and if it breaks, will cause it to break into many small pieces of "cubes" rather than sharp and potentially dangerous shards.

Glass breakage in furniture may occur for a variety of reasons. Tempered glass is particularly prone to breakage from damage (scratches, nicks, etc.) that may occur during shipping, handling, installation, use or maintenance. Exposure to rapid changes in temperature or concentrated temperature zones may also cause breakage.

Tempered glass may also break due to a specific type of imperfection or "inclusion" that occurs within the glass when manufactured. When this condition exists glass breakage may occur without any obvious cause. This is often referred to as "spontaneous" breakage but is a very isolated occurrence in the glass industry.

Care of Dry Erase Boards

Erase after every use to eliminate ghosting. Clean weekly with a Dry Erase Cleaner. Avoid the use of orange and red Dry Erase Markers. Follow manufacturers cleaning instructions for the eraser. If ghosting or staining remains use a small amount of rubbing alcohol on a clean, soft towel to remove.

Care of Solid Surface

Although liquids cannot penetrate Solid Surface, it is best to wipe up spills as they occur. Generally, a damp microfiber cloth used with a standard household kitchen spray should remove most stains.

For most residues, all you need to clean your Solid Surface countertops is a warm soapy water, ammonia-based household cleaner or a dedicated countertop cleaner. Do avoid window cleaners; however, as they can leave a waxy build-up that dulls the surface. Always clean using a circular motion.

Film will build up on countertops if water is left to dry on the surface. This film will dull the countertop surface, making the finish appear blotchy and uneven. To prevent film build-up, it is very important to wipe the countertop completely dry immediately after spills and cleaning.

Some color of Solid Surface may require more frequent cleaning to maintain a uniform finish. Darker colors tend to require more attention than lighter colors. Over time, even with proper care, your countertop will acquire a sheen. Dark colors may show light scratches more readily.

Specification Tools

JSI products are manufactured to order and provide a multitude of options to address your individual customer needs. As you process your order do not forget to include all the necessary information to allow the order entry process to be completed. Please see the order checklist at the beginning of every series.

JSI Customer Service edits every order for complete information. If details are not included with the purchase order, Customer Service will contact you to answer these questions. If information is not completed in a timely manner it will delay the entry process and could affect your product delivery date. To avoid delay in order entry and potential delay in delivery of your order, please double check the line items to ensure all selections have been completed.

To ensure completion of details on your purchase order, electronic catalogs and specification tools have been developed to aid in the process. These electronic tools include:

20-20 GIZA Studio and 20-20 CAP Studio software offers state-of-the-art design, specification, photo-realistic rendering and three-dimensional visualization capabilities for configurable products in the commercial interior design markets. 20-20 GIZA Studio and 20-20 CAP Studio are available for all JSI Casegood and Seating products, in 2D and 3D graphics and the Specifier Catalog. Updates are made monthly reflecting any changes that occurred. To be sure the most up to date information is provided on orders, users of this software program are responsible to update their catalogs.

CET Designer, by Configura is an all-in-one software solution for space planning and configuration of products. The intuitive workflow guides you through entire process from idea to reality - supporting every step of the sales process

ProjectMatrix, Inc. offers a full software solution for the contract furniture industry. Their software can help you create space plans to specifications for ease of specifying our JSI Casegood and Seating product lines. Updates are made monthly reflecting any changes that occurred. To be sure the most up to date information is provided on orders, users of this software program are responsible to update their catalogs.

GSAdvantage is a Federal Government electronic catalog site offered to assist GSA customers in specifying and pricing JSI product. Listed at this site are all contract items and prices under GSA Contract # GS-28F-0030U.

Our JSI website jsifurniture.com provides many tools to assist in the design and order selection. Included in the site are downloadable images, typicals, product symbols, brochures, contact information, price lists, sales representative locations, warranty and environmental information.

GSA Terms and Conditions



Contract Holder
Contract # GS-28F-0030U

In addition to the standard terms and conditions, the following terms and conditions apply to GSA contract.

Contract Number
GS-28F-0030U

Contract Period
June 24, 2013 - June 24, 2028

Statement of Intended Use
The furniture covered by special item number 33721 Office Furniture shall comply with the requirements defined in purchase description 3QSAB 09-608. All furniture offered under this SIN shall be GSA Chassis Grade 1, 2, 3 or NA, GSA Drawer Grade 1, 2, 3, 4 or NA, Design A B or C, as defined in 3QSAB 09-608.

Description of Special Item Number SIN #33721

Cooperative Purchasing
No

Set Aside
No

FSC/PSC Code
7125

NAICS 337211 Wood Office Furniture Manufacturing 1000 employees

Includes all furniture placed in an office, such as chairs, desks, etc. In addition, ancillary services are included, however services performed shall not be the primary purpose of the work ordered.

Lowest Price Model

SIN #	Model Number	Net Price
33721	VS-LBRKT-20	\$28.03

Maximum Order
\$250,000 net

Geographic Coverage
48 contiguous states and Washington D.C.

Point of Production
Jasper, Dubois County, Indiana
Orleans, Orange County, Indiana

Discount
Discount 61.6%* off list.

*Discount for Walden and Wellington is 61.71% off list.

Discount Quantity
Walden and Wellington only
\$300,000 to \$350,000 Net = 0.5%
\$350,001 to \$400,000 Net = 1%
\$400,001 to \$450,000 Net = 1.5%

Prompt Payment Terms
1% 15 - net 30 days from date of invoice.

Government purchase cards are accepted at or below the micro-purchase threshold

Government purchase cards are accepted above the micro-purchase threshold

Foreign Terms
Not applicable.

Time of Delivery
30-75 days after receipt of order, 90 days maximum.

Expedited Delivery
Contact Customer Service 800-457-4511

Overnight and 2-day Delivery
Not applicable.

Urgent Requirements
Contact Customer Service 800-457-4511

F.O.B. Points
F.O.B. destination, freight prepaid and allowed to 48 contiguous states and Washington D.C. excludes special delivery requirements.

GSA Terms and Conditions

Ordering Address

Jasper Seating Company, Inc. d/b/a JSI
Attn: Participating Dealer
225 Clay Street
Jasper, IN 47546
Fax: 812-482-1548
Phone: 800-457-4511
Email: orders@jaspergroup.us.com

Order Procedures:

Per contract

Payment Address

JSI
225 Clay Street
Jasper, IN 47546

Warranty Provision

Limited Lifetime

Export Package Charges

Quoted on project-by-project basis.

Terms of Government Commercial Credit Card Acceptance

Accepted.

Rental, Maintenance, and Repair

Not applicable.

Terms and Conditions of installation

12% of net purchase order for installation services up to \$250,000.00 of net purchase price.

Terms and conditions of repair parts, etc.

See warranty.

List of service and distribution points

Contact Customer Service 800-457-4511.

List of participating dealers

Contact Customer Service 800-457-4511.

Preventive Maintenance

N/A

Environmental Attributes

GreenGuard Certified and recycled wood waste and fabric remnants

Section 508 Compliance.

N/A

DUNS

00-636-7767

CCR and SAMS Registration

Jasper Seating Company, Inc. is registered
Cage Code #31881
Federal ID #35-0420370
UEI #DDJ2GKQM7M84

Product Modifications

We willingly accept customers' modifications to standard products. See product modification information by series at the start of each series under the "Product Modification" sections. If there is a modification you desire that is not listed in this section, please call Customer Service for a modification quote/price

Acceptance, Modification, Assignment

By placing this order for furniture, material or other products (sometimes collectively referred to as "goods"), customer agrees to these terms and conditions which shall prevail over inconsistent provisions in any other form or document of customer. No change or modification shall be applicable unless set forth in writing and signed by company. Neither this order nor any interest therein shall be assigned by customer except with the prior written consent of company.

Payment

Customer agrees to pay to company the amount indicated on the invoice, 1% 15 days, net 30 days from date of invoice (U.S. funds only), for goods ordered. Interest will be charged after 30 days from the date of invoice at the rate of one and a half percent (1.5%) per month. International sales will require additional payment arrangements. No goods shall be sold on consignment or conditional sales basis. Payment for the goods delivered hereunder shall constitute acceptance thereof.

Attorneys' Fees

Customer shall be responsible for all expenses and cost in connection with the enforcement by company of these terms and conditions and the cost of collection (including the fees of any collection agencies to whom the customer's account may be referred), plus reasonable attorneys' fees (which attorneys' fees shall not be less than 25% of the amount due, unless a lower amount is specified by applicable law).

Remedies

The remedies herein reserved shall be cumulative, and additional to any other or further remedies provided in law or equity. No waiver of a breach of any provision of these terms and conditions shall constitute waiver of any other breach or of such provision.

Insolvency

Company may forthwith cancel this order in the event of the happening of any of the following or any other comparable event: insolvency of the customer, the filing of a voluntary petition in bankruptcy, the filing of any involuntary petition to have customer declared bankrupt provided it is not vacated within thirty (30) days from the date of filing, the appointment of a receiver or trustee for customer provided such appointment is not vacated within thirty (30) days from the date of such appointment, or the execution by customer of an assignment for the benefit of creditors.

GSA Terms and Conditions

Limitation of Liability

The Company shall not under any circumstances be liable to the customer, owner of the goods or any third party for special, indirect, incidental, or consequential damages, including, without limitation, loss of profits or revenues, loss or damage to other property or equipment, cost of capital or of purchased or replacement goods, or expense, delay, or inconvenience cause by or arising from the purchase, sale, use, repair or inability to use the goods or by any performance or non-performance under, or breach of, these terms and conditions. The Company's sole liability for any defective goods shall be its repair or its replacement pursuant to the express warranties set forth above, or if amended, as applicable at the time of manufacture or repair of the goods. Some states do not allow the exclusion or limitation of incidental or consequential damages, so the above limitations or exclusion may not apply to all customers. Any action resulting from any breach on the part of company as to the goods or services delivered here under must be commenced within one year after the cause of action has occurred.

Returns and Allowances

Reasonable touch-up and deluxing is the dealer's responsibility. The Company will not make allowances for trip or delivery charges, but will only make allowance for actual work performed to correct manufacturing defects. Allowances maybe authorized only by a company officer. It is the responsibility of the field sales representative to inspect any defective merchandise and make suggestions and recommendations as to the proper disposition. Field personnel cannot obligate or bind the company by definite agreement, without final authorization by a company officer. Company will not accept automatic charge backs which do not have prior authorization. All defects must be called to the company's attention upon arrival at the customer's "ship to" destination. To initiate any type of claim or request for parts, it is imperative to have the model number or fabric number, which may be located on the tag attached to the frame of the unit. Authorization for return to the company via a return goods authorization. Company will not issue credit allowances for any repairs without company's prior consent. Under no circumstances shall the company accept COD (cash on delivery) returns, and any such shipment will be refused.

Security Agreement

The Company may require and customer shall grant a security interest in goods sold pursuant to any credit the company may extend to the customer.

Governing Law

All disputes between the parties, whether or not arising out of these terms and conditions, will be governed by the laws of the state of Indiana. Customer agrees to submit to the jurisdiction of and agrees all lawsuits relating to any disputes between the customer and the company will be brought only in a state court located in Dubois County, Indiana or the United States District Court for the Southern District of Indiana. The customer hereby waives the right to a trial by jury in any action, proceeding, claim, or counterclaim whether in contract or tort, at law or in equity, arising out of or relating in any way to these terms and conditions and all other disputes between the parties.

Mitigation

If the company repossesses the goods prior to payment by the customer of all amounts due hereunder, the company may sell the goods, as is, where is, free and clear of all rights of the customer at either public or private sales, and apply the net proceeds (after deducting expenses of repossession and sale) to the obligation of customer hereunder. The customer may dispose of the goods in any commercially reasonable place and manner and the customer waives any notice of time, place and manner of sale.

Integration

This order for goods, including these terms and conditions, along with any credit application, invoice, statement, dealer contract, acknowledgment, bill of lading (and any exhibits, addenda or amendments thereto) of which this order may be a part, constitutes the sole and complete agreement between the company and the customer with respect to the purchase of the goods.

Dimensions/Specifications/Finishes

All dimensions are approximate and may vary due to the upholstery technique of each craftsman. If exact dimensions are required, it is necessary for the customer to state such specifications with the order. Detailed specifications sheets are available for each series of goods, and customer should consult the company's customer service department for these specification sheets. Company reserves the right to make changes in dimensions, style, or specifications if company believes these changes will improve the goods' quality or appearance. Company reserves the right to substitute hardwoods due to availability at production. Due to the natural characteristics of wood, environmental effects, and material upgrades, the company cannot guarantee exact finish matches on existing goods previously ordered from company. If an exact match to customer's existing goods is required, it must be specified so that the proper procedures can be followed to ensure an acceptable finish. Company will accept no liability for the finish if this procedure isn't followed. Company reserves the right to make changes in a finish formula if company believes the change will improve the quality or appearance of company's goods.

Company's Performance of Its Obligation

The production and delivery of the goods to the extent delayed or hindered or prevented from the performance by reason of natural disasters, acts of god, strikes, lockouts, labor troubles, inability to procure materials, casualties, failure of power, restrictive governmental laws or regulations, riots, insurrections, acts of terrorism, war or other reason of a like nature not the fault of the company shall excuse for the period of the delay the company's performance and the period for the performance shall be extended for a period equivalent to the period of such delay.

Seating Price List

General Information

Environmental Mission	II
WarrantyIII
Laminate and Veneer CharacteristicsIII
SamplesIV
Order ProceduresIV

Quickship ProgramIV
DeliveryIV
Freight DamageV
Repairs and ReturnsV
Fire Retardancy / CAL 133V
Textile Information / COM and COL PolicyVI

Custom Options	VII
Care and MaintenanceIX
Specification ToolsX
GSA Terms and ConditionsXI

A

Addison	AD2
Guest	AD3
Stools	AD3

Americana	AM1
Guest	AM2-AM4
Swivel	AM2
Stools	AM4-AM5
Benches	AM6-AM7

Ansen	AS2
Stools	AS4

Arwyn	AW1
Lounge	AW8-AW15
Guest + Crossover	AW16-AW23
Swivel	AW24
Occasional Tables	AW25-AW31

Avalon	A01
Guest	A02-A010
Stools	A02-A04, A06-A08, A010-A012

Avini	AV1
Guest	AV2
Stools	AV3-AV4

B

BeSpace	BS2
Guest	BS14
Lounge	BS14-BS28
Casegoods	BS30-BS43
Occasional Tables	BS29

Boston	B02
Guest	B03-B04
Swivel	B03
Benches	B04-B05

Bourne	BUS2
Guest	BUS6
Lounge	BUS6
Stools	BUS7
Occasional Tables	BUS8-BUS9

Bryn	BY2
Guest	BY4-BY6
Stools	BY6-BY8

C

Caav	CV1
Lounge	CV8-CV33
Casegoods	CV34-CV39

Cabaret	CR2
Guest	CR5
Swivel	CR3

Class Act	CA1
GuestCA2-CA11-

Collective Motion	CC2
Guest	CC6
LoungeCC7-CC9
Tables	CC10-CC14
Meeting Tables	CC14
Casegoods	CC15-CC17

Connect	CT2
LoungeCT10-CT53
Occasional TablesCT56-CT58
CasegoodsCT62-CT65

E

Encore	EN2
Lounge	EN4-EN7, EN11-EN16
Benches	EN12-EN13
Occasional Tables	EN8-EN10

Esque	ES2
Lounge	ES2

F

FinnFI2
LoungeFI3
BenchesFI5
Occasional TablesFI6-FI7

Finn NuFI8
LoungeFI9
BenchesFI10
Occasional Tables	FI11-FI12

G

Garvey R5	GV2
Swivel	GV3

Gatsby	GT2
Guest	GT3

H

Harbor	HB2
Guest	HB5
Lounge	HB7
Swivel	HB3

Hoopz	HZ2
Guest	HZ3
Stools	HZ5

I

Indie	IN2
Lounge	IN8
Occasional Tables	IN24
Tiles, Screens, Accessories	IN36

J

Jude	JU1
Guest	JU2
Stools	JU3
Lounge	JU5

K

Knox	KN2
Guest	KN10-KN45
Occasional Tables	KN47
Stools	KN48-KN59
Swivel	KN60-KN61

Kyla	KY2
Stools	KY3-KY4

L

Laurel	LA1
Guest	LA2-LA5
Occasional Tables	LA6

M

Mackey	MY1
Stools	MY3

Madison	MA2
Swivel	MA3-MA5
Guest	MA6-MA11

Melrose	MR2
Guest	MR3-MR6
Stools	MR3-MR6

Seating Price List

M (continued)

Millie MI2
 Guest MI3
 Stools MI4-MI5

Moto MT2
 Lounge MT16-MT33
 Occasional Tables MT36-MT37
 Casegoods MT38-MT63

Murphy MU1
 Guest MU2
 Stools MU2

N

Newton NW1
 Swivel NW2-NW3

O

Oxley OX2
 Benches OX4-OX5

P

Pillows PW2

Poet PL2
 Peb PL10
 Cube PL42
 Tables PL74

Protocol PT2
 Swivel PT4-PT19

Proxy PX2
 Swivel PX4-PX29

R

Ramona RA2
 Guest RA3-RA4

Ria RI1
 Guest RI2

S

Sosa SA1
 Guest SA2-SA4

T

Tara TA1
 Swivel TA2-TA7
 Guest TA8-TA9

Teekan TK2
 Lounge TK4-TK14

Totem TM2
 Guest TM3

Trinity TR2
 Guest TR4

Tyler TY1
 Swivel TY2-TY3

W

Wink WK1
 Guest WK3-WK6
 Stools WK7-WK10

Z

Ziva ZV1
 Lounge ZV8-ZV37
 Occasional Tables ZV38-Z V39

Addison Order Check List:



ADDISON

Specify:

- 1. Model Number
- 2. Wood Species - Red Oak (RO) or Maple (M)
- 3. Wood Finish/Color
- 4. Fabric Selection - vendor, pattern and color
- 5. Optional FRONT LEG casters - add \$66 list; specify seat height
NOT AVAILABLE on BARSTOOLS
- 6. Optional Rubber Cushion Nylon Glides - no upcharge

Example:

353C <small>(model #)</small>	RO <small>(wood species)</small>	HEN <small>(finish)</small>	MOMENTUM <small>(fabric vendor)</small>	VOX <small>(pattern name)</small>	MYSTIC <small>(pattern color)</small>
----------------------------------	-------------------------------------	--------------------------------	--	--------------------------------------	--

1. Model Number

2. Wood Species - Red Oak (RO) or Maple (M)

3. Wood Base/Color Options:

Red Oak

BRW Brownie	ECU Ecru
CAN Canyon	HEN Henna
CIT Citron	HNY Honey
DES Desert	NUT Nut Brown

Maple

ALM Ale Medium	HRV Harvest
CAL Ale Light Coordinate	CKC Khaki Coordinate
BBM Bourbon Medium	MINC Mineral Coordinate
CBZ Brazilwood Coordinate	MCH Mocha
BARC Barrel Coordinate	CPI Pinnacle Walnut Coordinate
CBO Bourbon Light Coordinate	PRL Praline
CBG Brighton Light Coordinate	RAVC Raven Coordinate
BRM Brighton Medium	SABC Sable Coordinate
BUT Butterscotch	SIE Sienna
CNDC Cinder Coordinate	CST Studio Teak Coordinate
CLA Classic	TRF Truffle
CLL Collectors	UMB Umber
EGRC Egret Coordinate	VALC Valley Coordinate
ESP Espresso	VEN Venetian
FAWC Fawn Coordinate	CWE Weathered Ash Coordinate
FLX Flax	
CGR Graphite Coordinate	

Color - Add \$45 list per item

BKD Backdrop	GRV Greek Villa
BFX Black Fox	GLF Gulf Stream
BWH Bright White	HTB Heartthrob
CGP Cargo Pants	NET Network Gray
CHT Chatroom	NWH Nonchalant White
DSY Daisy	PAR Paradise
DRG Daring	QXP Quixotic Plum
DYN Dynamo	RBZ Relic Bronze
ENG Enigma	SND Sandbank
FRR French Roast	STM Storm
GBY Georgian Bay	TRC Tricorn Black

**4. Fabric Selection - Please supply the following:
Fabric vendor/Pattern name/Pattern color**

For a complete list of JSI Standard and Graded-In Textiles click here

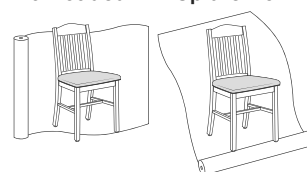
All COM orders must include the following:

- Vendor's name, pattern name and color
- Sample of the fabric attached to order
- Model numbers of items for fabric application
- Special application instructions (e.g., all stripes will be applied front to back unless specified otherwise)
- Customer and purchase order number

Ship prepaid COM material to:

JSI
Attn: COM Department
201 East Martin Street
Receiving B, Dock 71
Orleans, IN 47452

Application of fabric:
Railroaded Up the Roll



All COM orders will ship at standard lead time from receipt of COM except for orders requiring special custom matched finishes.

Description

Armless



353A
all wood



353C
uph. seat

1 Model

353A All Wood
353C Uph. Seat

- optional front leg casters available - add \$66 list for set of 2 casters
- coordinating Children's collection

Specifications

Dimensions	D	W	H
Overall	20 1/2	18	34 1/2
Seat	15 1/2	18	18 1/2
Upholstery		Shipping	
COM Ydg	3/4	Ctn Wt	20
COL Sq Ft	9	Cu Ft	9

List Price Per Grade

All Wood	\$431
COM	\$490
A	\$511
B	\$528
COL/C	\$562
D	\$605
E	\$648
F	\$697
G	\$763
H	\$831
I	\$938
J	\$1,073
L1	\$773
L2	\$844

46 3/4" h Barstool



358A
all wood



358C
uph. seat

358A All Wood
358C Uph. Seat

- casters not available
- standard with brass scuff plate, also available in polished aluminum or matte black

Dimensions	D	W	H
Overall	20 3/8	18	46 3/4
Seat	15 1/2	18	30
Upholstery		Shipping	
COM Ydg	3/4	Ctn Wt	25
COL Sq Ft	9	Cu Ft	13

All Wood	\$522
COM	\$580
A	\$598
B	\$620
COL/C	\$653
D	\$697
E	\$740
F	\$786
G	\$855
H	\$922
I	\$1,029
J	\$1,162
L1	\$865
L2	\$935

To Order, Specify:

- 1 Model Number
- 2 Wood Species - Red Oak (RO) or Maple (M)
- 3 Wood Finish/Color [See Wood Finish/Color Options](#)
- 4 Fabric Selection - vendor, pattern and color
Visit www.jsifurniture.com/finishes-and-materials/textiles for our textiles program. See selection of standard and graded in manufacturers and patterns.
- 5 Optional FRONT LEG Casters - add \$66 list; specify seat height. **NOT AVAILABLE on BARSTOOLS**
- 6 Optional Rubber Cushion Nylon Glides - no upcharge

Specifications

- Wood species - Red Oak or Maple.
- Seat is upholstered with 1 1/2" polyurethane foam and synthetic sheet webbing for added comfort.
- Mortise and tenon construction with corner blocks, glue and screws.
- Standard with rubber cushion metal glides.

Addison Children's Order Check List:



ADDISON

Specify:

- 1. Model Number
- 2. Wood Species - Red Oak (RO) or Maple (M)
- 3. Wood Finish/Color
- 4. Fabric Selection - vendor, pattern and color
- 5. Optional Rubber Cushion Nylon Glides - no upcharge

Example:

356C <small>(model #)</small>	RO <small>(wood species)</small>	HEN <small>(finish)</small>	MOMENTUM <small>(fabric vendor)</small>	VOX <small>(pattern name)</small>	MYSTIC <small>(pattern color)</small>
----------------------------------	-------------------------------------	--------------------------------	--	--------------------------------------	--

1. Model Number

2. Wood Species - Red Oak (RO) or Maple (M)

3. Wood Base/Color Options:

Red Oak

BRW Brownie	ECU Ecru
CAN Canyon	HEN Henna
CIT Citron	HNY Honey
DES Desert	NUT Nut Brown

Maple

ALM Ale Medium	HRV Harvest
CAL Ale Light Coordinate	CKC Khaki Coordinate
BBM Bourbon Medium	MINC Mineral Coordinate
CBZ Brazilwood Coordinate	MCH Mocha
BARC Barrel Coordinate	CPI Pinnacle Walnut Coordinate
CBO Bourbon Light Coordinate	PRL Praline
CBG Brighton Light Coordinate	RAVC Raven Coordinate
BRM Brighton Medium	SABC Sable Coordinate
BUT Butterscotch	SIE Sienna
CNDC Cinder Coordinate	CST Studio Teak Coordinate
CLA Classic	TRF Truffle
CLL Collectors	UMB Umber
EGRC Egret Coordinate	VALC Valley Coordinate
ESP Espresso	VEN Venetian
FAWC Fawn Coordinate	CWE Weathered Ash Coordinate
FLX Flax	
CGR Graphite Coordinate	

Color - Add \$45 list per item

BKD Backdrop	GRV Greek Villa
BFX Black Fox	GLF Gulf Stream
BWH Bright White	HTB Heartthrob
CGP Cargo Pants	NET Network Gray
CHT Chatroom	NWH Nonchalant White
DSY Daisy	PAR Paradise
DRG Daring	QXP Quixotic Plum
DYN Dynamo	RBZ Relic Bronze
ENG Enigma	SND Sandbank
FRR French Roast	STM Storm
GBY Georgian Bay	TRC Tricorn Black

4. Fabric Selection - Please supply the following:

Fabric vendor/ Pattern name/ Pattern color

For a complete list of JSI Standard and Graded-In Textiles click [here](#)

All COM orders must include the following:

- Vendor's name, pattern name and color
- Sample of the fabric attached to order
- Model numbers of items for fabric application
- Special application instructions (e.g., all stripes will be applied front to back unless specified otherwise)
- Customer and purchase order number

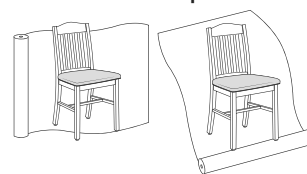
Ship prepaid COM

material to:

JSI
Attn: COM Department
201 East Martin Street
Receiving B, Docks 71-73
Orleans, IN 47452



Application of fabric:

Railroaded Up the Roll



All C.O.M. orders will ship at standard lead time from receipt of C.O.M. except for orders requiring special custom matched finishes.

5. Optional Rubber Cushion Nylon Glides - no upcharge

Description		① Model	Specifications				List Price Per Grade	
Armless		356A All Wood 356C Uph. Seat	Dimensions	D	W	H	All Wood	\$424
			Overall	15	15	29	COM	\$518
			Seat	13	15	16	A	\$535
			Upholstery	Shipping			B	\$556
			COM Ydg	¾	Ctn Wt	13	COL/C	\$590
			COL Sq Ft	9	Cu Ft	6	D	\$634
							E	\$678
							F	\$723
							G	\$790
							H	\$859
							I	\$966
							J	\$1,098
							L1	\$802
							L2	\$870

To Order, Specify:

- ① Model Number
- ② Wood Species - Red Oak (RO) or Maple (M)
- ③ Wood Finish/Color [See Wood Finish/Color Options](#)
- ④ Fabric Selection - vendor, pattern and color
Visit www.jsifurniture.com/finishes-and-materials/textiles for our textiles program. See selection of standard and graded in manufacturers and patterns.
- ⑤ Optional FRONT LEG Casters - add \$66 list; specify seat height. **NOT AVAILABLE on BARSTOOLS**
- ⑥ Optional Rubber Cushion Nylon Glides - no upcharge

Specifications

- Wood species - Red Oak or Maple.
- Seat is upholstered with 1½" polyurethane foam and synthetic sheet webbing for added comfort.
- Mortise and tenon construction with corner blocks, glue and screws.
- Standard with rubber cushion metal glides.

ADDISON

Americana Order Check List:



Specify:

- 1. Model Number
- 2. Wood Species - Red Oak (RO) or Maple (M)
- 3. Wood Finish/Color
- 4. Upholstered seat style - horseshoe style available; add \$27 list per chair/barstool; add \$34 list per bench
- 5. Fabric Selection - vendor, pattern and color
- 6. Optional FRONT LEG casters - add \$66 list; specify seat height NOT AVAILABLE on BARSTOOLS
- 7. Optional Trim Nails; add \$128 list per chair/barstool; add \$161 list per bench. Standard trim nail color is Antique Brass. Optional Black trim nails available.
- 8. Optional 1 3/4" Circle Back Cut Out - add \$21 list per chair (select models)
- 9. Optional Rubber Cushion Nylon Glides - no upcharge

Example:

301C (model #)	RO (wood species)	HEN (finish)	MOMENTUM (fabric vendor)	VOX (pattern name)	MYSTIC (pattern color)
--------------------------	-----------------------------	------------------------	------------------------------------	------------------------------	----------------------------------

1. Model Number

2. Wood Species - Red Oak (RO) or Maple (M)

3. Wood Base/Color Options:

Red Oak

BRW Brownie	ECU Ecu
CAN Canyon	HEN Henna
CIT Citron	HNY Honey
DES Desert	NUT Nut Brown

Maple

ALM Ale Medium	HRV Harvest
CAL Ale Light Coordinate	CKC Khaki Coordinate
BBM Bourbon Medium	MINC Mineral Coordinate
CBZ Brazilwood Coordinate	MCH Mocha
BARC Barrel Coordinate	CPI Pinnacle Walnut Coordinate
CBO Bourbon Light Coordinate	PRL Praline
CBG Brighton Light Coordinate	RAVC Raven Coordinate
BRM Brighton Medium	SABC Sable Coordinate
BUT Butterscotch	SIE Sienna
CNDC Cinder Coordinate	CST Studio Teak Coordinate
CLA Classic	TRF Truffle
CLL Collectors	UMB Umber
EGRC Egret Coordinate	VALC Valley Coordinate
ESP Espresso	VEN Venetian
FAWC Fawn Coordinate	CWE Weathered Ash Coordinate
FLX Flax	
CGR Graphite Coordinate	

Color - Add \$45 list per item

BKD Backdrop	GRV Greek Villa
BFX Black Fox	GLF Gulf Stream
BWH Bright White	HTB Heartthrob
CGP Cargo Pants	NET Network Gray
CHT Chatroom	NWH Nonchalant White
DSY Daisy	PAR Paradise
DRG Daring	QXP Quixotic Plum
DYN Dynamo	RBZ Relic Bronze
ENG Enigma	SND Sandbank
FRR French Roast	STM Storm
GBY Georgian Bay	TRC Tricorn Black

4. Upholstered Seat Style - standard with fully upholstered seat. Optional horseshoe style with welt cord available; add \$27 list per chair/barstool; add \$34 list per bench.

5. Fabric Selection - Please supply the following: Fabric vendor/ Pattern name/ Pattern color

[For a complete list of JSI Standard and Graded-In Textiles click here](#)

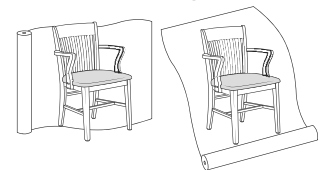
All COM orders must include the following:

- Vendor's name, pattern name and color
- Sample of the fabric attached to order
- Model numbers of items for fabric application
- Special application instructions (e.g., all stripes will be applied front to back unless specified otherwise)
- Customer and purchase order number

Ship prepaid COM material to:

JSI
Attn: COM Department
201 East Martin Street
Receiving B, Dock 71
Orleans, IN 47452

Application of fabric:
Railroaded Up the Roll



All COM orders will ship at standard lead time from receipt of COM except for orders requiring special custom matched finishes.

7. Optional Trim Nails - add \$128 per chair/barstool; add \$161 list per bench. Standard trim nail color is Antique Brass. Optional Black trim nails are available. Optional Black trim nails must be specified when ordering.

8. Optional Back Cut Out - 1 3/4" circle; add \$21 list per chair, on select models.



AMERICANA

Description

Model

Specifications

List Price Per Grade

Swivel



300A
all wood

300C
uph. seat



optional jury
base

- 300A All Wood**
300C Uph. Seat
- optional five star base with pneumatic lift - add \$80 list
 - dual black casters available, no upcharge - specify when ordering
 - optional jury base available, revolves, tilts - add \$203 list
 - optional jury base does not include site installation hardware

Dimensions	D	W	H
Overall	21 ½	23 ½	33-35 ¾
Seat	17 ½	19 ½	16 ¼-19
Arm			25 ½-28 ¾
Upholstery		Shipping	
COM Ydg	¾	Ctn Wt	40
COL Sq Ft	9	Cu Ft	12

All Wood	\$758
COM	\$826
A	\$848
B	\$867
COL/C	\$898
D	\$940
E	\$982
F	\$1,028
G	\$1,090
H	\$1,159
I	\$1,261
J	\$1,388
L1	\$1,103
L2	\$1,168

Arm



301A
all wood

301C
uph. seat

- 301A All Wood**
301C Uph. Seat
- optional front leg casters available - add \$66 list for set of 2 casters
 - coordinating Children's Collegian collection

Dimensions	D	W	H
Overall	23 ¾	23	34 ½
Seat	17 ¾	19 ¼	18 ¼
Arm			27 ½
Upholstery		Shipping	
COM Ydg	¾	Ctn Wt	28
COL Sq Ft	9	Cu Ft	12

All Wood	\$597
COM	\$651
A	\$672
B	\$689
COL/C	\$722
D	\$764
E	\$806
F	\$852
G	\$914
H	\$980
I	\$1,084
J	\$1,212
L1	\$926
L2	\$991

Armless



302A
all wood

302C
uph. seat







optional jury
base

- 302A All Wood**
302C Uph. Seat
- optional five star base with pneumatic lift - add \$80 list
 - dual black casters available, no upcharge - specify when ordering
 - optional jury base available, revolves, tilts- add \$203 list

Dimensions	D	W	H
Overall	29	28	33-36 ¾
Seat	16 ¾	18 ¼	16 ¼-20
Upholstery		Shipping	
COM Ydg	¾	Ctn Wt	38
COL Sq Ft	9	Cu Ft	10

All Wood	\$714
COM	\$784
A	\$806
B	\$826
COL/C	\$858
D	\$899
E	\$940
F	\$986
G	\$1,049
H	\$1,119
I	\$1,218
J	\$1,346
L1	\$1,060
L2	\$1,129

Description	Model	Specifications				List Price Per Grade	
		Dimensions	D	W	H	All Wood	COM
Armless  303A all wood	303A All Wood 303C Uph. Seat · optional front leg casters available - add \$66 list for set of 2 casters	Overall	21 1/2	18 1/2	34 1/2	A	\$523
		Seat	16 1/4	18 1/4	18	B	\$541
 303C uph. seat		Upholstery		Shipping		COL/C	\$572
		COM Ydg	3/4	Ctn Wt	20	D	\$617
		COL Sq Ft	9	Cu Ft	9	E	\$656
						F	\$702
						G	\$764
						H	\$831
						I	\$937
						J	\$1,060
						L1	\$776
						L2	\$843

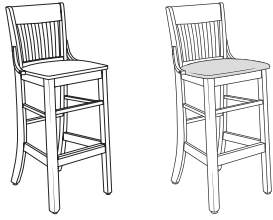
Description	Model	Specifications				List Price Per Grade	
		Dimensions	D	W	H	All Wood	COM
Armless  313A all wood	313A All Wood 313C Uph. Seat · optional front leg casters available - add \$66 list for set of 2 casters · optional 1 3/4" circle back cut out - add \$21 list per chair · coordinating Children's Collegian collection	Overall	22	18 1/2	35 1/4	A	\$525
		Seat	16 1/4	18 1/2	18 3/4	B	\$543
 313C uph. seat		Upholstery		Shipping		COL/C	\$578
		COM Ydg	3/4	Ctn Wt	20	D	\$619
		COL Sq Ft	9	Cu Ft	9	E	\$660
						F	\$705
						G	\$768
						H	\$833
						I	\$939
						J	\$1,065
						L1	\$778
						L2	\$847

To Order, Specify:

- 1 Model Number
- 2 Wood Species - Red Oak (RO) or Maple (M)
- 3 Wood Finish/Color [See Seating Finish/Color Options](#)
- 4 Upholstered Seat Style - horseshoe style; add \$27 list per chair/barstool; add \$34 list per bench
- 5 Fabric Selection - vendor, pattern and color
Visit www.jsifurniture.com/finishes-and-materials/textiles for our textiles program. See selection of standard and graded in manufacturers and patterns.
- 6 Optional FRONT LEG Casters - add \$66 list; specify seat height.
NOT AVAILABLE on BARSTOOLS
- 7 Optional Trim Nails - add \$128 list per chair/barstool; add \$161 list per bench Antique Brass standard; optional Black trim nails available, specify when ordering
- 8 Optional Circle Cut Out - add \$21 list per chair (select)
- 9 Optional Rubber Cushion Nylon Glides - no upcharge

Specifications

- Wood species - Red Oak or Maple.
- Seat is upholstered with 1" high density polyurethane foam.
- Mortise and tenon construction with corner blocks, glue and screws.
- Standard with rubber cushion metal glides.

Description
Model
Specifications
List Price Per Grade
43½" h Barstool

307A
all wood

307C
uph. seat

- 307A All Wood**
307C Uph. Seat
- 43 ½" back height
 - casters not available
 - standard with brass scuff plate, also available in polished aluminum or matte black

Dimensions	D	W	H
Overall	21	18 ¾	43 ½
Seat	17	18 ¾	30 ¾
Upholstery		Shipping	
COM Ydg	¾	Ctn Wt	30
COL Sq Ft	9	Cu Ft	13

All Wood	\$632
COM	\$684
A	\$705
B	\$723
COL/C	\$758
D	\$800
E	\$839
F	\$885
G	\$947
H	\$1,013
I	\$1,120
J	\$1,245
L1	\$961
L2	\$1,028

46" h Barstool

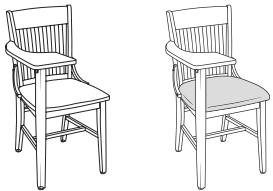
308A
all wood

308C
uph. seat

- 308A All Wood**
308C Uph. Seat
- 46" back height
 - casters not available
 - standard with brass scuff plate, also available in polished aluminum or matte black

Dimensions	D	W	H
Overall	21	18 ¾	46
Seat	17	18 ¾	30 ¾
Upholstery		Shipping	
COM Ydg	¾	Ctn Wt	30
COL Sq Ft	9	Cu Ft	13

All Wood	\$601
COM	\$652
A	\$673
B	\$693
COL/C	\$723
D	\$765
E	\$807
F	\$853
G	\$917
H	\$981
I	\$1,088
J	\$1,213
L1	\$927
L2	\$993



Tablet

309A
all wood



309C
uph. seat

- 309A All Wood**
309C Uph. Seat
- 11 x 11 ½ standard size tablet
 - optional 11 x 17 tablet arm available - add \$43 upcharge
 - tablet standard on right
 - available with left tablet - please specify when ordering
 - optional front leg casters available - add \$66 list for set of 2 casters

Dimensions	D	W	H
Overall	28 ¼	24 ½	34 ½
Seat	14	20	18 ¼
Arm			29 ½
Upholstery		Shipping	
COM Ydg	¾	Ctn Wt	33
COL Sq Ft	9	Cu Ft	14

All Wood	\$604
COM	\$678
A	\$697
B	\$714
COL/C	\$750
D	\$789
E	\$831
F	\$878
G	\$939
H	\$1,006
I	\$1,111
J	\$1,238
L1	\$950
L2	\$1,018

Description	Model	Specifications			List Price Per Grade	
46¾" h Swivel Barstool	319A All Wood	Dimensions	D	W	H	All Wood \$728
	319C Uph. Seat	Overall	20 ½	18 ¾	46 ¾	COM \$777
 319A all wood	 319C uph. seat	Seat	16	18 ½	30	A \$800
		Upholstery	Shipping			
		COM Ydg	¾	Ctn Wt	42	COL/C \$852
		COL Sq Ft	9	Cu Ft	13	D \$891
						E \$933
						F \$979
						G \$1,041
						H \$1,106
						I \$1,213
						J \$1,340
						L1 \$1,053
						L2 \$1,122



Description	Model	Specifications			List Price Per Grade	
43½" h Barstool	317A All Wood	Dimensions	D	W	H	All Wood \$632
	317C Uph. Seat	Overall	21	18 ¾	43 ½	COM \$684
 317A all wood	 317C uph. seat	Seat	17	18 ¾	30 ¾	A \$705
		Upholstery	Shipping			
		COM Ydg	¾	Ctn Wt	30	COL/C \$758
		COL Sq Ft	9	Cu Ft	13	D \$800
						E \$839
						F \$885
						G \$947
						H \$1,013
						I \$1,120
						J \$1,245
						L1 \$961
						L2 \$1,028

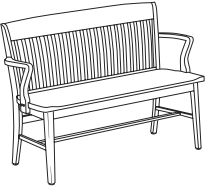
To Order, Specify:

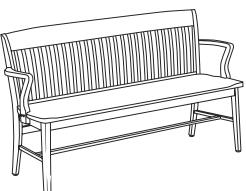
- 1 Model Number
- 2 Wood Species - Red Oak (RO) or Maple (M)
- 3 Wood Finish/Color [See Seating Finish/Color Options](#)
- 4 Upholstered Seat Style - horseshoe style; add \$27 list per chair/barstool; add \$34 list per bench
- 5 Fabric Selection - vendor, pattern and color
Visit www.jsifurniture.com/finishes-and-materials/textiles for our textiles program. See selection of standard and graded in manufacturers and patterns.
- 6 Optional FRONT LEG Casters - add \$66 list; specify seat height.
NOT AVAILABLE on BARSTOOLS
- 7 Optional Trim Nails - add \$128 list per chair/barstool; add \$161 list per bench Antique Brass standard; optional Black trim nails available, specify when ordering
- 8 Optional Circle Cut Out - add \$21 list per chair (select)
- 9 Optional Rubber Cushion Nylon Glides - no upcharge

Specifications

- Wood species - Red Oak or Maple.
- Seat is upholstered with 1" high density polyurethane foam.
- Mortise and tenon construction with corner blocks, glue and screws.
- Standard with rubber cushion metal glides.

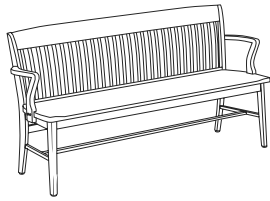
Description	Model	Specifications	List Price Per Grade
46" h Barstool	318A All Wood	Dimensions	All Wood \$601
	318C Uph. Seat	D W H	COM \$652
	· 46" back height	Overall 21 18 ¾ 46	A \$673
	· optional 1 ¾" circle back cut out - add \$21 list per chair	Seat 17 18 ¾ 30 ¾	B \$693
	· casters not available	Upholstery	COL/C \$723
	· standard with brass scuff plate, also available in polished aluminum or matte black	COM Ydg ¾ Ctn Wt 30	D \$765
		COL Sq Ft 9 Cu Ft 13	E \$807
			F \$853
			G \$917
			H \$981
			I \$1,088
			J \$1,213
			L1 \$927
			L2 \$993

Description	Model	Specifications	List Price Per Grade
52 ¼" w Bench	321A All Wood	Dimensions	All Wood \$2,485
	321C Uph. Seat	D W H	COM \$2,638
	· casters not available	Overall 20 ¾ 52 ¼ 34 ¾	A \$2,699
		Seat 17 48 ¼ 18	B \$2,744
		Arm 27 ¼	COL/C \$2,820
		Upholstery	D \$2,918
		COM Ydg 1 ¾ Ctn Wt 70	E \$3,015
		COL Sq Ft 23 Cu Ft 31	F \$3,118
			G \$3,266
			H \$3,422
			I \$3,666
			J \$3,959
			L1 \$3,296
			L2 \$3,450

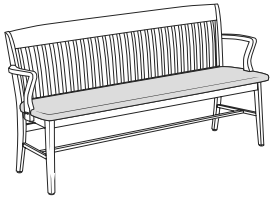
Description	Model	Specifications	List Price Per Grade
63" w Bench	322A All Wood	Dimensions	All Wood \$2,809
	322C Uph. Seat	D W H	COM \$2,992
	· casters not available	Overall 21 ½ 63 34 ¾	A \$3,061
		Seat 17 59 18	B \$3,104
		Arm 27 ¼	COL/C \$3,179
		Upholstery	D \$3,276
		COM Ydg 1 ¾ Ctn Wt 90	E \$3,376
		COL Sq Ft 23 Cu Ft 40	F \$3,477
			G \$3,625
			H \$3,783
			I \$4,023
			J \$4,318
			L1 \$3,654
			L2 \$3,809

Description

71 3/4" w Bench



323A
all wood



323C
uph. seat

1 Model

323A All Wood

323C Uph. Seat

· casters not available

Specifications

Dimensions	D	W	H
Overall	21 1/2	71 3/4	34 3/4
Seat	17	67 3/4	18
Arm			27 1/4
Upholstery		Shipping	
COM Ydg	2 1/4	Ctn Wt	110
COL Sq Ft	23	Cu Ft	41

List Price Per Grade

All Wood	\$3,109
COM	\$3,306
A	\$3,383
B	\$3,439
COL/C	\$3,539
D	\$3,661
E	\$3,790
F	\$3,921
G	\$4,110
H	\$4,312
I	\$4,626
J	\$5,004
L1	\$4,148
L2	\$4,349

AMERICANA

To Order, Specify:

- 1 Model Number
- 2 Wood Species - Red Oak (RO) or Maple (M)
- 3 Wood Finish/Color [See Seating Finish/Color Options](#)
- 4 Upholstered Seat Style - horseshoe style; add \$27 list per chair/barstool; add \$34 list per bench
- 5 Fabric Selection - vendor, pattern and color
Visit www.jsifurniture.com/finishes-and-materials/textiles for our textiles program. See selection of standard and graded in manufacturers and patterns.
- 6 Optional FRONT LEG Casters - add \$66 list; specify seat height.
NOT AVAILABLE on BARSTOOLS
- 7 Optional Trim Nails - add \$128 list per chair/barstool; add \$161 list per bench Antique Brass standard; optional Black trim nails available, specify when ordering
- 8 Optional Circle Cut Out - add \$21 list per chair (select)
- 9 Optional Rubber Cushion Nylon Glides - no upcharge

Specifications

- Wood species - Red Oak or Maple.
- Seat is upholstered with 1" high density polyurethane foam.
- Mortise and tenon construction with corner blocks, glue and screws.
- Standard with rubber cushion metal glides.

Ansen Order Check List:



ANSEN

Specify:

- 1. Model Number
- 2. Wood Species - Maple (M)
- 3. Wood Finish/Color
- 4. Fabric Selection - vendor, pattern and color
- 5. Optional Scuff Plate - Brass (BRASS), Matte Black (BLACK) or Polished Aluminum (PAM) - add \$23 list
- 6. Optional Rubber Cushion Nylon Glides - no upcharge

Example:

AS1414D (model #)	M (wood species)	HRV (finish)	MOMENTUM (fabric vendor)	VOX (pattern name)	MYSTIC (pattern color)	PAM (scuff plate)
-----------------------------	----------------------------	------------------------	------------------------------------	------------------------------	----------------------------------	-----------------------------

1. Model Number

2. Wood Species - Maple (M)

3. Finish Options:

Maple Finish

ALM Ale Medium	HRV Harvest
CAL Ale Light Coordinate	CKC Khaki Coordinate
BBM Bourbon Medium	MINC Mineral Coordinate
CBZ Brazilwood Coordinate	MCH Mocha
BARC Barrel Coordinate	CPI Pinnacle Walnut Coordinate
CBO Bourbon Light Coordinate	PRL Praline
CBG Brighton Light Coordinate	RAVC Raven Coordinate
BRM Brighton Medium	SABC Sable Coordinate
BUT Butterscotch	SIE Sienna
CNDC Cinder Coordinate	CST Studio Teak Coordinate
CLA Classic	TRF Truffle
CLL Collectors	UMB Umber
EGRC Egret Coordinate	VALC Valley Coordinate
ESP Espresso	VEN Venetian
FAWC Fawn Coordinate	CWE Weathered Ash Coordinate
FLX Flax	
CGR Graphite Coordinate	

4. Fabric Selection - Please supply the following:

Fabric vendor/ Pattern name/ Pattern color

[For a complete list of JSI Standard and Graded-In Textiles click here](#)

- Indicate direction of fabric - Railroaded or Up the Roll
- Please provide illustration, if available

All COM orders must include the following:

- Vendor's name, pattern name and color
- Sample of the fabric attached to the order
- Model numbers of items for fabric application
- Special application instructions (e.g., all stripes will be applied front to back unless specified otherwise)
- Customer and purchase order number

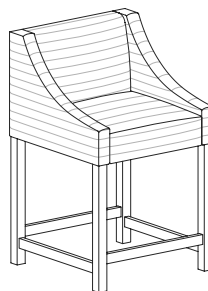
Ship prepaid COM material to:

JSI
Attn: COM Department
201 East Martin Street
Receiving B, Dock 71
Orleans, IN 47452

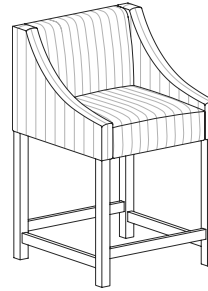
Application of fabrics:

Color: Add \$45 list per item

BKD Backdrop	GRV Greek Villa
BFX Black Fox	NET Network Gray
BWH Bright White	NWH Nonchalant White
CGP Cargo Pants	STM Storm
CHT Chatroom	TRC Tricorn Black
FRR French Roast	



Railroaded

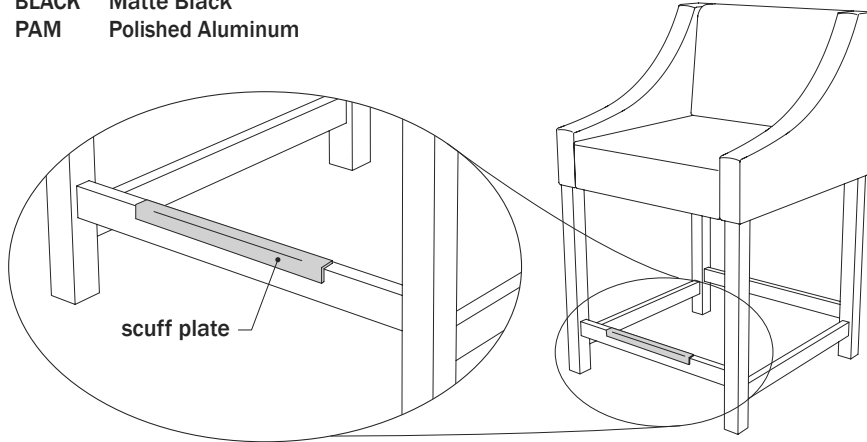


Up the Roll

All COM orders will ship at standard lead time from receipt of COM except for orders requiring special custom matched finishes.

5. Optional Scuff Plate - add \$23 list; specify color

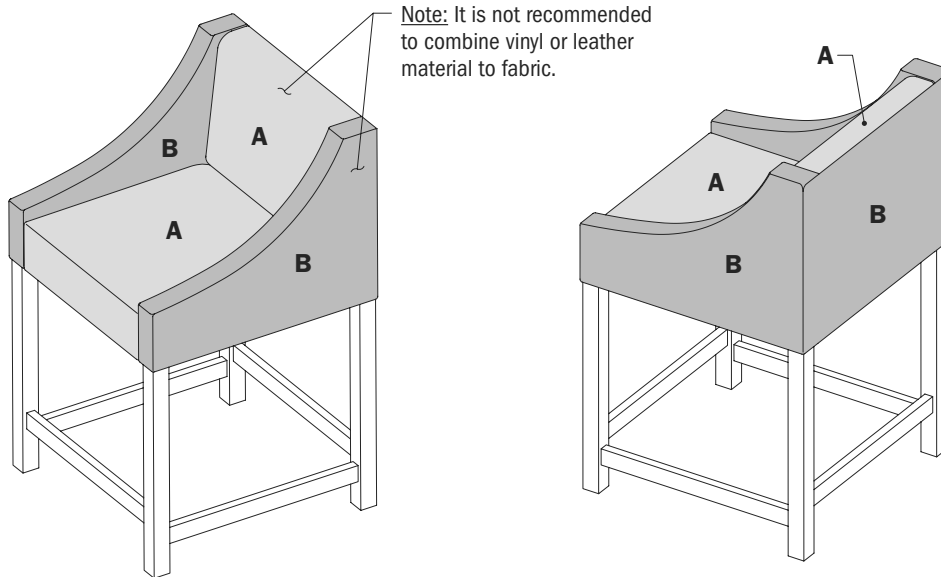
- BRASS Brass
- BLACK Matte Black
- PAM Polished Aluminum



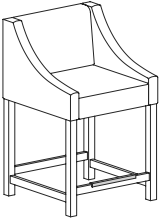
6. Optional Rubber Cushion Nylon Glides - no upcharge

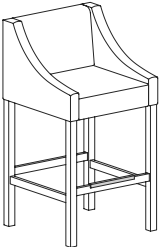
Contrasting Upholstery

Ansen stools can be specified with contrasting upholstery. When specified, the unit will be priced based on the highest grade fabric selected. Specify seat/interior back fabric (A), and arms/exterior back fabric (B) on your order. See below:



ANSEN

Description	① Model	Specifications				List Price Per Grade	
35¾" h Counter Height Stool 	AS1414D · upholstered seat and back · optional matte black, polished aluminum or brass scuff plate available; specify color and add \$23 list each	Dimensions		D	W	H	COM \$994
		Overall	21 ¾	22	35 ¾		
		Seat	18	17 ½	24		B \$1,086
		Upholstery		Shipping			COL/C \$1,193
		COM Ydg	2 ¾	Ctn Wt	22		D \$1,332
		COL Sq Ft	49	Cu Ft	12		E \$1,469
							F \$1,685
							G \$1,917
							H \$2,161
							I \$2,547
							J \$3,007
							L1 \$2,331
							L2 \$2,700

Description	① Model	Specifications				List Price Per Grade	
41¾" h Barstool 	AS1418D · upholstered seat and back · optional matte black, polished aluminum or brass scuff plate available; specify color and add \$23 list each	Dimensions		D	W	H	COM \$994
		Overall	21 ¾	22	41 ¾		
		Seat	18	17 ½	30		B \$1,086
		Upholstery		Shipping			COL/C \$1,193
		COM Ydg	2 ¾	Ctn Wt	25		D \$1,332
		COL Sq Ft	49	Cu Ft	12		E \$1,469
							F \$1,685
							G \$1,917
							H \$2,161
							I \$2,547
							J \$3,007
							L1 \$2,331
							L2 \$2,700

To Order, Specify:

- ① Model Number
- ② Wood Species - Maple (M)
- ③ Wood Frame Finish [See Wood Frame Finish Options](#)
 - a.) Maple Finish
 - b.) Paint Color - upcharge applies
- ④ Fabric Selection - vendor, pattern and color
 Visit www.jsifurniture.com/finishes-and-materials/textiles for our textiles program. See selection of standard and graded in manufacturers and patterns.
- ⑤ Optional Scuff Plate - Matte Black (BLK), Brass (BRASS), Polished Aluminum (PAM) - add \$23 list
- ⑥ Optional Rubber Cushion Nylon Glides - no upcharge

Specifications

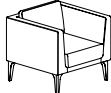
- Wood Species - Maple.
- Seat is upholstered with 2" high density polyurethane foam and synthetic sheet webbing for added comfort.
- Seat has single needle top stitch detail for added style and durability.
- Back is upholstered with 1 ½" polyurethane foam.
- Mortise and tenon construction with corner blocks, glue and screws.
- Standard with rubber cushion metal glides.

Arwyn - Overview

Lounge - Cushion Back



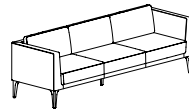
Single Seat,
Small Scale



Single Seat



Two Seat



Three Seat

Lounge - Quilted Wrap



Single Seat

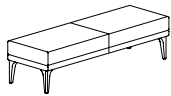


Two Seat

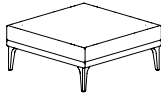


Three Seat

Lounge - Benches/Ottomans



Rectangular Benches



Square Ottomans

Guest + Crossover with Wood Leg



Guest



High Back



Ottoman

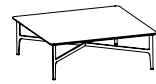
Tables with Wood Legs



19" h



21" h



16" h

Guest + Crossover with Metal Leg



Guest



High Back



Ottoman

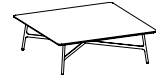
Tables with Metal Legs



19" h



21" h



16" h

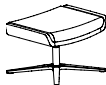
Swivel Guest + Crossover with 4 Star Base



Swivel Guest



High Back



Ottoman

Swivel Guest with 5 Star Base



Swivel Guest

Arwyn Lounge Order Check List:



Specify:

- 1. Model Number
- 2. Fabric Selection
 - A. Frame/Apron - Vendor, Pattern and Color
 - B. Back Cushion/Quilt Wrap - Vendor, Pattern and Color
 - C. Seat Cushion - Vendor, Pattern and Color
- 3. Back Cushion - Plain (PBC) or Quilted (QBC), specify and upcharge applies
- 4. Seat Cushion - Plain (PSC) or Quilted (QSC), specify and upcharge applies
- 5. Foot Option
 - A. Wood (WF)
 - B. Metal Finish (MF)
- 6. Arm Caps - Wood (W) add \$195, Solid Surface (S) add \$314 or 3D Black Laminate (B3L), add \$195 list per set
- 7. Optional Power in the Side Arm - Black (B) or White (W); add \$385 list each, specify location (as seated)

Example:

AW6011 (model #)	Maharam (fabric vendor)	Mode (pattern name)	Sycamore (pattern color)	QBC (back cushion)	WF (foot option)	TOF (finish)	No (power)
fabric specified per zone							

1. Model Number

2. Fabric Selection - Please supply the following:
Fabric vendor/ Pattern name/ Pattern color

For a complete list of JSI Standard and Graded-In Textiles click [here](#)

- Indicate direction of fabric - Railroaded or Up the Roll
- Please provide illustration, if available

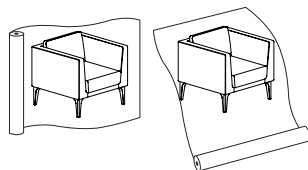
All COM orders must include the following:

- Vendor's name, pattern name and color
- Sample of the fabric attached to the order
- Model numbers of items for fabric application
- Special application instructions
- Customer and purchase order number

Ship prepaid COM material to:

JSI
Attn: COM Department
201 East Martin Street
Receiving B, Dock 71
Orleans, IN 47452

Application of fabric:
Railroaded Up the Roll



All COM orders will ship at standard lead time from receipt of COM except for orders requiring special custom matched finishes.

3. Back Cushion:

Available in Plain (PBC) or Quilted (QBC).

4. Seat Cushion:

Available in Plain (PSC) or Quilted (QSC).

5. Foot Options:

A. Wood Maple Foot (WF)

ALM	Ale Medium	HRV	Harvest
CAL	Ale Light Coordinate	CKC	Khaki Coordinate
BBM	Bourbon Medium	MINC	Mineral Coordinate
CBZ	Brazilwood Coordinate	MCH	Mocha
BARC	Barrel Coordinate	CPI	Pinnacle Walnut Coordinate
CBO	Bourbon Light Coordinate	PRL	Praline
CBG	Brighton Light Coordinate	RAVC	Raven Coordinate
BRM	Brighton Medium	SABC	Sable Coordinate
BUT	Butterscotch	SIE	Sienna
CNDC	Cinder Coordinate	CST	Studio Teak Coordinate
CLA	Classic	TRF	Truffle
CLL	Collectors	UMB	Umber
EGRC	Egret Coordinate	VALC	Valley Coordinate
ESP	Espresso	VEN	Venetian
FAWC	Fawn Coordinate	CWE	Weathered Ash Coordinate
FLX	Flax		
CGR	Graphite Coordinate		

B. Metal Foot (MF)

ABZ	Aged Bronze	PEW	Pewter
ASL	Arctic Silver	PAM	Polished Aluminum
GLD	Gold	SBZ	Soft Bronze
MBK	Matte Black	SNK	Soft Nickel

6. Arm Cap

A. Wood (WAC)

ALM	Ale Medium	CGR	Graphite Coordinate
CAL	Ale Light Coordinate	HRV	Harvest
BBM	Bourbon Medium	CKC	Khaki Coordinate
CBZ	Brazilwood Coordinate	MINC	Mineral Coordinate
BARC	Barrel Coordinate	MCH	Mocha
CBO	Bourbon Light Coordinate	CPI	Pinnacle Walnut Coordinate
CBG	Brighton Light Coordinate	PRL	Praline
BRM	Brighton Medium	RAVC	Raven Coordinate
BUT	Butterscotch	SABC	Sable Coordinate
CNDC	Cinder Coordinate	SIE	Sienna
CLA	Classic	CST	Studio Teak Coordinate
CLL	Collectors	TRF	Truffle
EGRC	Egret Coordinate	UMB	Umber
ESP	Espresso	VALC	Valley Coordinate
FAWC	Fawn Coordinate	VEN	Venetian
FLX	Flax	CWE	Weathered Ash Coordinate

B. Solid Surface (SAC)

ARM	Armadillo	PEB	Pebble Pearl
BLP	Black Pearl	PUR	Pure White

C. Black 3D Laminate (B3LAC)

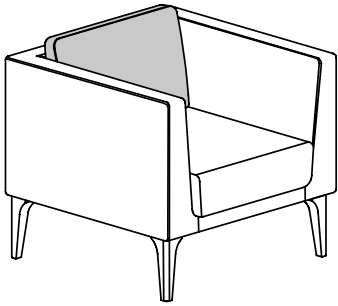
7. Optional Power in the Side Arm

Available in Black (B) or White (W), add \$385 list each, specify location (as seated)

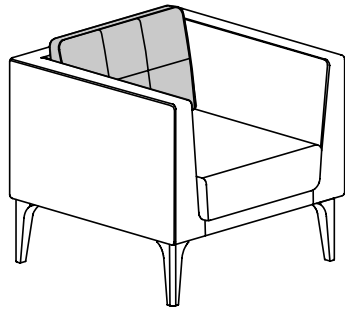
Arwyn Lounge

Lounge Single, Two and Three seat models offer two back styles for aesthetic appeal. Models can be selected with fixed cushion back or quilted wrap. In addition the cushion back models can be specified with plain or quilted back. All cushions are fixed.

Cushion Back

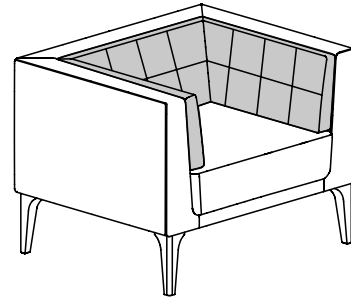


Plain Back



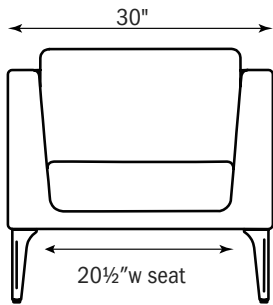
Quilted Back

Quilted Wrap

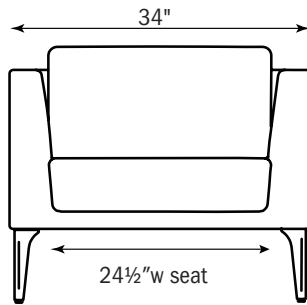


Seat Width

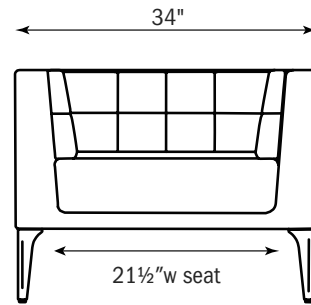
Arwyn Single Seat with Cushion Back offers a small scale option, which also reduces the seating space.



**Small Scale
Cushion Back**



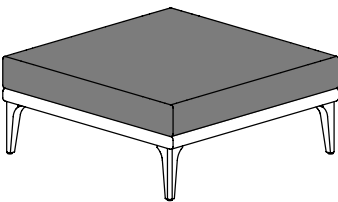
Cushion Back



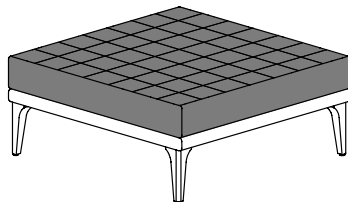
Quilted Wrap

Seat Cushion

Ottoman and benches offer a choice of plain or quilted seat fixed cushion..



Plain Seat

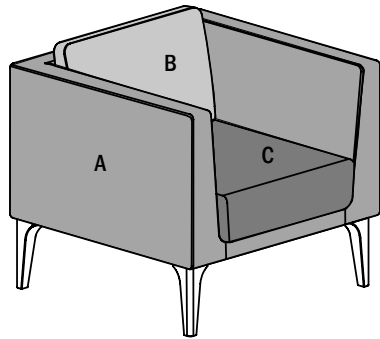


Quilted Seat

ARWYN

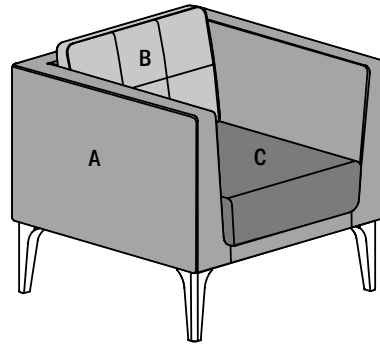
Fabric Application

Arwyn affords the ability to be specified with multiply upholsteries to create a unique look. Upholstery zones are defined by the style of the unit.



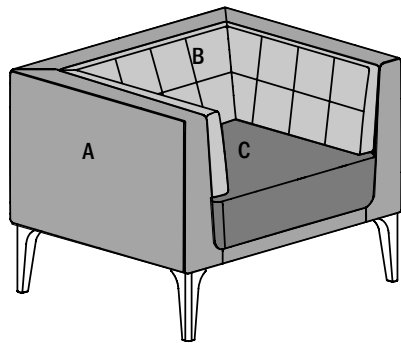
Plain Back Cushion

- A = Frame
- B = Back Cushion
- C = Seat Cushion



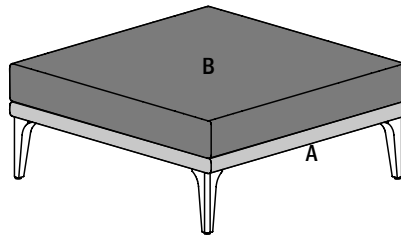
Quilted Back Cushion

- A = Frame
- B = Quilted Back Cushion
- C = Seat Cushion



Quilted Wrap

- A = Frame
- B = Quilt Wrap
- C = Seat Cushion

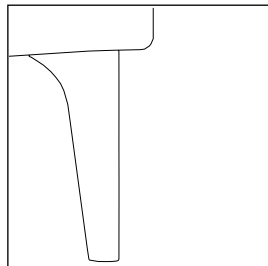


Ottoman

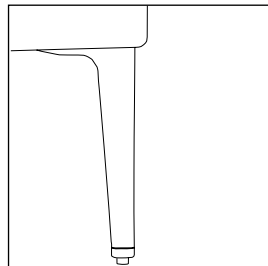
- A = Apron
- B = Seat Cushion

Foot Option

Lounge, benches and ottoman models are available with options of wood or metal feet.



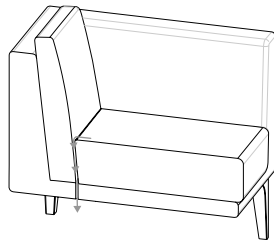
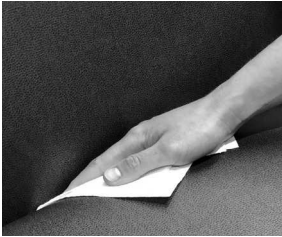
Wood



Metal

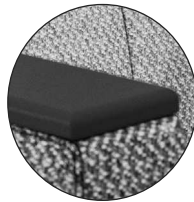
Discreet Cleanout

Single seat with cushion back models (AW6010-CO and AW6011-CO) offer a discreet cleanout for ease in cleaning. Cleanout is incorporated in such a way as to not be noticeable from the approach, as well as provide sufficient pass through to an opening in the bottom of the chair.



Arm Caps

Available in wood, solid surface and 3D Black Laminate. 3D Black laminate is fully sealed to prevent water, bacteria and dirt from penetrating through surface.



Wood - add \$195

ALM Ale Medium
 CAL Ale Light Coordinate
 BBM Bourbon Medium
 CBZ Brazilwood Coordinate
 BARC Barrel Coordinate
 CBO Bourbon Light Coordinate
 CBG Brighton Light Coordinate
 BRM Brighton Medium
 BUT Butterscotch
 CNDC Cinder Coordinate
 CLA Classic
 CLL Collectors
 EGRC Egret Coordinate
 ESP Espresso
 FAWC Fawn Coordinate
 FLX Flax
 CGR Graphite Coordinate
 HRV Harvest

CKC Khaki Coordinate
 MINC Mineral Coordinate
 MCH Mocha
 CPI Pinnacle Walnut Coordinate
 PRL Praline
 RAVC Raven Coordinate
 SABC Sable Coordinate
 SIE Sienna
 CST Studio Teak Coordinate
 TRF Truffle
 UMB Umber
 VALC Valley Coordinate
 VEN Venetian
 CWE Weathered Ash Coordinate

Solid Surface - add \$314

ARM Armadillo
 BLP Black Pearl
 PEB Pebble Pearl
 PUR Pure White

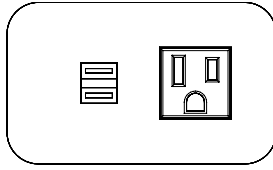
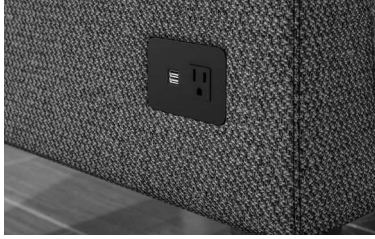
3D Black Laminate - add \$195

"available in Black ONLY"

ARWYN

Optional Power in the Side Arm

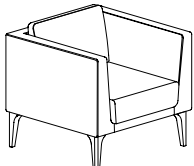
Specify optional power in the left or right side arm of lounge models or in both arms of two and three seaters; add \$385 list per powered arm.

**EC48**

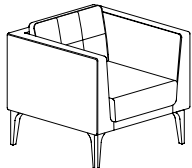
- One 12A, 120 VAC spill resistant receptacles
- Two 2.1A (11W) USB charging ports
- Cord Length 108"
- 90" Flat Plug with 45 degree rotation
- Specify Black (B) or White (W)
- Factory Installed
- ETL Listed

Description

Single Seat Lounge, Small Scale - Cushion Back



plain back shown



quilted back shown

Model

AW6010

- select maple wood feet or metal feet, JSI standard finishes
- specify upholstery on frame separately from upholstery on back cushion and separately from upholstery on seat cushion
- quilted back cushion available, specify and add \$117 list
- arm caps available: wood, solid surface or 3D black laminate - upcharges apply
- power available in the side arm - upcharge applies

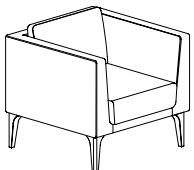
Specifications

Dimensions	D	W	H
Overall	29 ½	30	29 ½
Seat	20	20 ½	16 ¼
Arm			26 ¼
Overall Upholstery		Shipping	
COM Ydg	4 ¼	Ctn Wt	60
COL Sq Ft	85	Cu Ft	18
Frame			
COM Ydg	3 ¼		
COL Sq Ft	64		
Back Cushion			
COM Ydg	¾		
COL Sq Ft	13		
Seat Cushion			
COM Ydg	1		
COL Sq Ft	20		

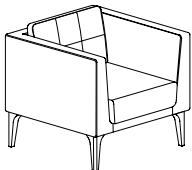
List Price Per Grade

COM	\$2,086
A	\$2,134
B	\$2,226
COL/C	\$2,386
D	\$2,593
E	\$2,800
F	\$3,122
G	\$3,466
H	\$3,834
I	\$4,409
J	\$5,098
L1	\$3,718
L2	\$4,178

Single Seat Lounge, Small Scale - Cushion Back with Discreet Cleanout



plain back shown



quilted back shown

AW6010-CO

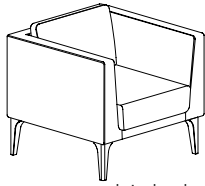
- select maple wood feet or metal feet, JSI standard finishes
- discreet cleanout feature allows for easier clean between the back and the seat
- specify upholstery on frame separately from upholstery on back cushion and separately from upholstery on seat cushion
- quilted back cushion available, specify and add \$117 list
- arm caps available: wood, solid surface or 3D black laminate - upcharges apply
- power available in the side arm - upcharge applies

Dimensions	D	W	H
Overall	29 ½	30	29 ¼
Seat	20	20 ½	16 ¼
Arm			26 ¼
Overall Upholstery		Shipping	
COM Ydg	4 ¼	Ctn Wt	62
COL Sq Ft	85	Cu Ft	18
Frame			
COM Ydg	3 ¼		
COL Sq Ft	64		
Back Cushion			
COM Ydg	¾		
COL Sq Ft	13		
Seat Cushion			
COM Ydg	1		
COL Sq Ft	20		

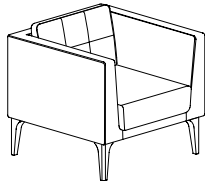
COM	\$2,186
A	\$2,233
B	\$2,325
COL/C	\$2,485
D	\$2,693
E	\$2,900
F	\$3,221
G	\$3,566
H	\$3,934
I	\$4,509
J	\$5,197
L1	\$3,819
L2	\$4,278

Description

Single Seat Lounge - Cushion Back



plain back shown



quilted back shown

Model

AW6011

- select maple wood feet or metal feet, JSI standard finishes
- specify upholstery on frame separately from upholstery on back cushion and separately from upholstery on seat cushion
- quilted back cushion available, specify and add \$117 list
- arm caps available: wood, solid surface or 3D black laminate - upcharges apply
- power available in the side arm - upcharge applies

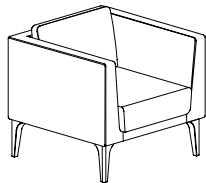
Specifications

Dimensions	D	W	H
Overall	29 ½	34	29 ¼
Seat	20	24 ½	16 ¼
Arm			26 ¼
Overall Upholstery		Shipping	
COM Ydg	5	Ctn Wt	69
COL Sq Ft	100	Cu Ft	21
Frame			
COM Ydg	3 ¾		
COL Sq Ft	75		
Back Cushion			
COM Ydg	¾		
COL Sq Ft	13		
Seat Cushion			
COM Ydg	1 ⅙		
COL Sq Ft	26		

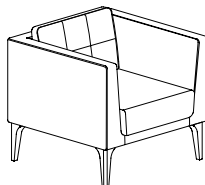
List Price Per Grade

COM	\$2,224
A	\$2,278
B	\$2,386
COL/C	\$2,575
D	\$2,818
E	\$3,062
F	\$3,441
G	\$3,846
H	\$4,279
I	\$4,954
J	\$5,766
L1	\$4,144
L2	\$4,685

Single Seat Lounge - Cushion Back with Discreet Cleanout



plain back shown



quilted back shown

AW6011-CO

- select maple wood feet or metal feet, JSI standard finishes
- discreet cleanout feature allows for easier clean between the back and the seat
- specify upholstery on frame separately from upholstery on back cushion and separately from upholstery on seat cushion
- quilted back cushion available, specify and add \$117 list
- arm caps available: wood, solid surface or 3D black laminate - upcharges apply
- power available in the side arm - upcharge applies

Dimensions	D	W	H
Overall	29 ½	34	29 ¼
Seat	20	24 ½	16 ¼
Arm			26 ¼
Overall Upholstery		Shipping	
COM Ydg	5	Ctn Wt	71
COL Sq Ft	100	Cu Ft	21
Frame			
COM Ydg	3 ¾		
COL Sq Ft	75		
Back Cushion			
COM Ydg	¾		
COL Sq Ft	13		
Seat Cushion			
COM Ydg	1 ⅙		
COL Sq Ft	26		

COM	\$2,333
A	\$2,385
B	\$2,487
COL/C	\$2,668
D	\$2,899
E	\$3,130
F	\$3,489
G	\$3,875
H	\$4,286
I	\$4,928
J	\$5,698
L1	\$4,157
L2	\$4,671

To Order, Specify:

- Model Number
- Fabric Selection - vendor, pattern and color
 - Frame
 - Back Cushion
 - Seat Cushion

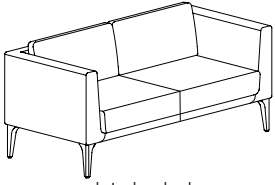
Visit www.jsifurniture.com/finishes-and-materials/textiles for our textiles program. See selection of standard and graded in manufacturers and patterns.
- Back Cushion
 - Plain (PBC)
 - Quilted (QBC) - upcharge applies
- Foot Option
 - Wood - See [Wood Foot Option](#)
 - Metal Finish - See [Metal Foot Option](#)
- Arm Caps - Wood (W) add \$195, Solid Surface (S) add \$314 or 3D Black Laminate (B3L) add \$195 list per set
- Optional Power in the Side Arm - Black (B) or White (W) - indicate left or right (as seated) add \$385 each

Specifications

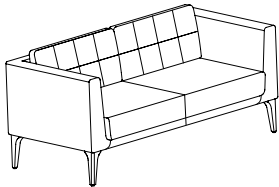
- Frame constructed of hardwood solids and plywood. Joinery includes puzzle joints and lap joints with metal fasteners.
- Wood legs include metal mounting plate and fixed metal glides.
- Metal legs feature adjustable foot with nylon glide and ½" adjustment range.
- Upholstery is tailor sewn over multi-density high resilience polyurethane foam.
- Seat cushion thickness 3 ½".
- Back cushion tapered thickness - 2 ½ at top - 4 ¾ at bottom.

Description

Two Seat - Cushion Back



plain back shown



quilted back shown

Model

AW6012

- select maple wood feet or metal feet, JSI standard finishes
- specify upholstery on frame separately from upholstery on back cushion and separately from upholstery on seat cushion
- quilted back cushion available, specify and add \$176 list
- arm caps available: wood, solid surface or 3D black laminate - upcharges apply
- power available in the side arm - upcharge applies

Specifications

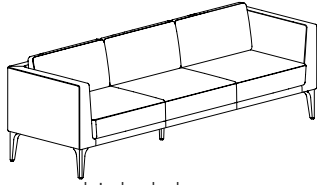
Dimensions	D	W	H
Overall	29 ½	63	29 ¼
Seat	20	56 ½	16 ¼
Arm			26 ¼
Overall Upholstery		Shipping	
COM Ydg	8 ¾	Ctn Wt	110
COL Sq Ft	193	Cu Ft	37
Frame			
COM Ydg	4 ⅝		
COL Sq Ft	101		
Back Cushion			
COM Ydg	2		
COL Sq Ft	44		
Seat Cushion			
COM Ydg	2 ½		
COL Sq Ft	55		

List Price Per Grade

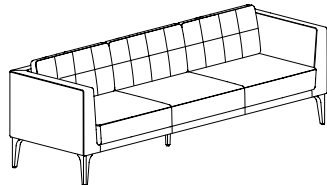
COM	\$3,149
A	\$3,247
B	\$3,442
COL/C	\$3,783
D	\$4,220
E	\$4,659
F	\$5,340
G	\$6,071
H	\$6,849
I	\$8,065
J	\$9,526
L1	\$6,996
L2	\$8,065

Description

Three Seat - Cushion Back



plain back shown



quilted back shown

1 Model

AW6013

- select maple wood feet or metal feet, JSI standard finishes
- specify upholstery on frame separately from upholstery on back cushion and separately from upholstery on seat cushion
- quilted back cushion available, specify and add \$234 list
- arm caps available: wood, solid surface or 3D black laminate - upcharges apply
- power available in the side arm - upcharge applies

Specifications

Dimensions	D	W	H
Overall	29 ½	90	29 ¼
Seat	20	80 ½	16 ¼
Arm			26 ¼
Overall Upholstery		Shipping	
COM Ydg	12 ¼	Ctn Wt	140
COL Sq Ft	294	Cu Ft	52
Frame Upholstery			
COM Ydg	5 ½		
COL Sq Ft	132		
Back Cushion			
COM Ydg	3		
COL Sq Ft	72		
Seat Cushion			
COM Ydg	3 ¾		
COL Sq Ft	90		

List Price Per Grade

COM	\$4,056
A	\$4,192
B	\$4,455
COL/C	\$4,920
D	\$5,516
E	\$6,113
F	\$7,039
G	\$8,033
H	\$9,093
I	\$10,749
J	\$12,737
L1	\$9,822
L2	\$11,413

To Order, Specify:

- 1 Model Number
- 2 Fabric Selection - vendor, pattern and color
 - a.) Frame
 - b.) Back Cushion
 - c.) Seat Cushion

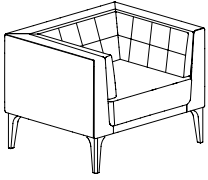
Visit www.jsifurniture.com/finishes-and-materials/textiles for our textiles program. See selection of standard and graded in manufacturers and patterns.
- 3 Back Cushion
 - a.) Plain (PBC)
 - b.) Quilted (QBC) - upcharge applies
- 4 Foot Option
 - a.) Wood - [See Wood Foot Option](#)
 - b.) Metal Finish - [See Metal Foot Option](#)
- 5 Arm Caps - Wood (W) add \$195, Solid Surface (S) add \$314 or 3D Black Laminate (B3L) add \$195 list per set
- 6 Optional Power in the Side Arm - Black (B) or White (W) - indicate left or right (as seated) add \$385 each

Specifications

- Frame constructed of hardwood solids and plywood. Joinery includes puzzle joints and lap joints with metal fasteners.
- Wood legs include metal mounting plate and fixed metal glides.
- Metal legs feature adjustable foot with nylon glide and ½" adjustment range.
- Upholstery is tailor sewn over multi-density high resilience polyurethane foam.
- Seat cushion thickness 3 ½".
- Back cushion tapered thickness - 2 ½ at top - 4 ¾ at bottom.

Description

Single Seat - Quilted Wrap



Model

AW6021

- select maple wood feet or metal feet, JSI standard finishes
- specify upholstery on frame separately from upholstery on quilted wrap and separately from upholstery on seat cushion
- arm caps available: wood, solid surface or 3D black laminate - upcharges apply
- power available in the side arm - upcharge applies

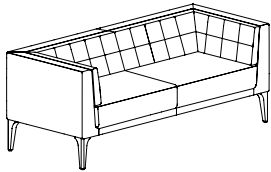
Specifications

Dimensions	D	W	H
Overall	29 ½	34	26 ½
Seat	20	21	16 ¼
Arm			26 ¼
Overall Upholstery		Shipping	
COM Ydg	7 ½	Ctn Wt	79
COL Sq Ft	150	Cu Ft	19
Frame			
COM Ydg	3 ¾		
COL Sq Ft	75		
Quit Wrap			
COM Ydg	1 ¾		
COL Sq Ft	35		
Seat Cushion			
COM Ydg	1 ⅝		
COL Sq Ft	26		

List Price Per Grade

COM	\$2,711
A	\$2,767
B	\$2,875
COL/C	\$3,063
D	\$3,307
E	\$3,551
F	\$3,929
G	\$4,335
H	\$4,768
I	\$5,442
J	\$6,254
L1	\$4,631
L2	\$5,173

Two Seat - Quilted Wrap



AW6022

- select maple wood feet or metal feet, JSI standard finishes
- specify upholstery on frame separately from upholstery on quilted wrap and separately from upholstery on seat cushion
- arm caps available: wood, solid surface or 3D black laminate - upcharges apply
- power available in the side arm - upcharge applies

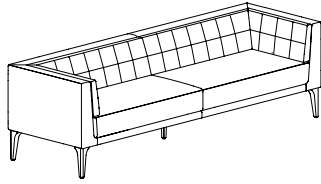
Dimensions	D	W	H
Overall	29 ½	63	26 ½
Seat	20	51	16 ¼
Arm			26 ¼
Overall Upholstery		Shipping	
COM Ydg	10	Ctn Wt	125
COL Sq Ft	220	Cu Ft	34
Frame			
COM Ydg	4 ⅝		
COL Sq Ft	101		
Quit Wrap			
COM Ydg	2		
COL Sq Ft	42		
Seat Cushion			
COM Ydg	2 ½		
COL Sq Ft	55		

COM	\$3,462
A	\$3,550
B	\$3,721
COL/C	\$4,026
D	\$4,414
E	\$4,805
F	\$5,410
G	\$6,058
H	\$6,751
I	\$7,833
J	\$9,130
L1	\$6,880
L2	\$7,833

ARWYN

Description

Three Seat - Quilted Wrap



1 Model

AW6023

- select maple wood feet or metal feet, JSI standard finishes
- specify upholstery on frame separately from upholstery on quilted wrap and separately from upholstery on seat cushion
- arm caps available: wood, solid surface or 3D black laminate - upcharges apply
- power available in the side arm - upcharge applies

Specifications

Dimensions	D	W	H
Overall	29 ½	90	26 ½
Seat	20	78	16 ¼
Arm			26 ½
Overall Upholstery		Shipping	
COM Ydg	12 ½	Ctn Wt	160
COL Sq Ft	300	Cu Ft	48
Frame			
COM Ydg	5 ½		
COL Sq Ft	132		
Quit Wrap			
COM Ydg	3		
COL Sq Ft	72		
Seat Cushion			
COM Ydg	3 ¾		
COL Sq Ft	90		

List Price Per Grade

COM	\$4,536
A	\$4,628
B	\$4,813
COL/C	\$5,136
D	\$5,548
E	\$5,962
F	\$6,606
G	\$7,294
H	\$8,031
I	\$9,179
J	\$10,557
L1	\$8,536
L2	\$9,639

To Order, Specify:

- 1 Model Number
- 2 Fabric Selection - vendor, pattern and color
 - a.) Frame
 - b.) Quilt Wrap
 - c.) Seat Cushion

Visit www.jsifurniture.com/finishes-and-materials/textiles for our textiles program. See selection of standard and graded in manufacturers and patterns.
- 3 Foot Option
 - a.) Wood - [See Wood Foot Option](#)
 - b.) Metal Finish - [See Metal Foot Option](#)
- 4 Arm Caps - Wood (W) add \$195, Solid Surface (S) add \$314 or 3D Black Laminate (B3L) add \$195 list per set
- 5 Optional Power in the Side Arm - Black (B) or White (W) - indicate left or right (as seated) add \$385 each

Specifications

- Frame constructed of hardwood solids and plywood. Joinery includes puzzle joints and lap joints with metal fasteners.
- Wood legs include metal mounting plate and fixed metal glides.
- Metal legs feature adjustable foot with nylon glide and ½" adjustment range.
- Upholstery is tailor sewn over multi-density high resilience polyurethane foam.
- Seat cushion thickness 3 ½".
- Back cushion tapered thickness - 2 ½ at top - 4 ¾ at bottom.

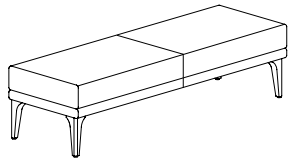
Description

Model

Specifications

List Price Per Grade

19 x 60" Rectangular Bench"



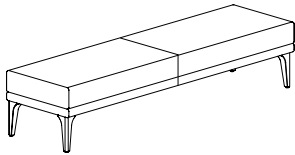
AW1960

- select maple wood feet or metal feet, JSI standard finishes
- specify upholstery on apron separately from upholstery on seat
- quilted bench seat cushion available, specify and add \$147 list

Dimensions	D	W	H
Overall	19	60	15 ¼
Overall Upholstery		Shipping	
COM Ydg	2 ½	Ctn Wt	63
COL Sq Ft	50	Cu Ft	13
Apron			
COM Ydg	1 ¾		
COL Sq Ft	35		
Seat Cushion			
COM Ydg	1 ¾		
COL Sq Ft	35		

COM	\$1,890
A	\$1,911
B	\$1,955
COL/C	\$2,031
D	\$2,127
E	\$2,226
F	\$2,375
G	\$2,539
H	\$2,711
I	\$2,982
J	\$3,307
L1	\$2,657
L2	\$2,875

19 x 72" Rectangular Bench"

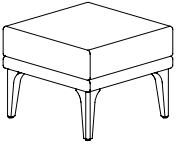
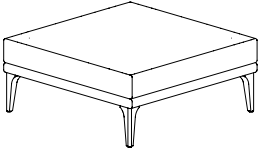
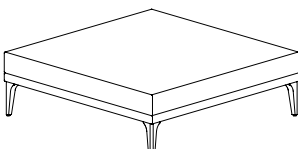


AW1972

- select maple wood feet or metal feet, JSI standard finishes
- specify upholstery on apron separately from upholstery on seat
- quilted bench seat cushion available, specify and add \$234 list

Dimensions	D	W	H
Overall	19	72	15 ¼
Overall Upholstery		Shipping	
COM Ydg	2 ¾	Ctn Wt	67
COL Sq Ft	55	Cu Ft	16
Apron			
COM Ydg	2 ½		
COL Sq Ft	50		
Seat Cushion			
COM Ydg	2 ½		
COL Sq Ft	50		

COM	\$2,033
A	\$2,058
B	\$2,107
COL/C	\$2,192
D	\$2,302
E	\$2,411
F	\$2,582
G	\$2,765
H	\$2,959
I	\$3,262
J	\$3,628
L1	\$2,898
L2	\$3,142

Description	Model	Specifications	List Price Per Grade																																												
19½ Square Ottoman" 	AW2020 • select maple wood feet or metal feet, JSI standard finishes • specify upholstery on apron separately from upholstery on seat • quilted ottoman seat cushion available, specify and add \$117 list	<table border="1"> <thead> <tr> <th>Dimensions</th> <th>D</th> <th>W</th> <th>H</th> </tr> </thead> <tbody> <tr> <td>Overall</td> <td>19 ½</td> <td>19 ½</td> <td>15 ¼</td> </tr> <tr> <th colspan="2">Overall Upholstery</th> <th colspan="2">Shipping</th> </tr> <tr> <td>COM Ydg</td> <td>1</td> <td>Ctn Wt</td> <td>50</td> </tr> <tr> <td>COL Sq Ft</td> <td>20</td> <td>Cu Ft</td> <td>7</td> </tr> <tr> <th colspan="4">Apron</th> </tr> <tr> <td>COM Ydg</td> <td>½</td> <td></td> <td></td> </tr> <tr> <td>COL Sq Ft</td> <td>10</td> <td></td> <td></td> </tr> <tr> <th colspan="4">Seat Cushion</th> </tr> <tr> <td>COM Ydg</td> <td>¾</td> <td></td> <td></td> </tr> <tr> <td>COL Sq Ft</td> <td>15</td> <td></td> <td></td> </tr> </tbody> </table>	Dimensions	D	W	H	Overall	19 ½	19 ½	15 ¼	Overall Upholstery		Shipping		COM Ydg	1	Ctn Wt	50	COL Sq Ft	20	Cu Ft	7	Apron				COM Ydg	½			COL Sq Ft	10			Seat Cushion				COM Ydg	¾			COL Sq Ft	15			COM \$946 A \$956 B \$978 COL/C \$1,016 D \$1,064 E \$1,114 F \$1,188 G \$1,270 H \$1,357 I \$1,492 J \$1,653 L1 \$1,330 L2 \$1,439
		Dimensions	D	W	H																																										
Overall	19 ½	19 ½	15 ¼																																												
Overall Upholstery		Shipping																																													
COM Ydg	1	Ctn Wt	50																																												
COL Sq Ft	20	Cu Ft	7																																												
Apron																																															
COM Ydg	½																																														
COL Sq Ft	10																																														
Seat Cushion																																															
COM Ydg	¾																																														
COL Sq Ft	15																																														
36 Square Ottoman" 	AW3636 • select maple wood feet or metal feet, JSI standard finishes • specify upholstery on apron separately from upholstery on seat • quilted ottoman seat cushion available, specify and add \$176 list	<table border="1"> <thead> <tr> <th>Dimensions</th> <th>D</th> <th>W</th> <th>H</th> </tr> </thead> <tbody> <tr> <td>Overall</td> <td>36</td> <td>36</td> <td>15 ¼</td> </tr> <tr> <th colspan="2">Overall Upholstery</th> <th colspan="2">Shipping</th> </tr> <tr> <td>COM Ydg</td> <td>2 ¼</td> <td>Ctn Wt</td> <td>72</td> </tr> <tr> <td>COL Sq Ft</td> <td>45</td> <td>Cu Ft</td> <td>14</td> </tr> <tr> <th colspan="4">Apron</th> </tr> <tr> <td>COM Ydg</td> <td>½</td> <td></td> <td></td> </tr> <tr> <td>COL Sq Ft</td> <td>10</td> <td></td> <td></td> </tr> <tr> <th colspan="4">Seat Cushion</th> </tr> <tr> <td>COM Ydg</td> <td>1 ¾</td> <td></td> <td></td> </tr> <tr> <td>COL Sq Ft</td> <td>35</td> <td></td> <td></td> </tr> </tbody> </table>	Dimensions	D	W	H	Overall	36	36	15 ¼	Overall Upholstery		Shipping		COM Ydg	2 ¼	Ctn Wt	72	COL Sq Ft	45	Cu Ft	14	Apron				COM Ydg	½			COL Sq Ft	10			Seat Cushion				COM Ydg	1 ¾			COL Sq Ft	35			COM \$1,911 A \$1,936 B \$1,985 COL/C \$2,070 D \$2,181 E \$2,290 F \$2,459 G \$2,642 H \$2,837 I \$3,141 J \$3,506 L1 \$2,775 L2 \$3,019
		Dimensions	D	W	H																																										
Overall	36	36	15 ¼																																												
Overall Upholstery		Shipping																																													
COM Ydg	2 ¼	Ctn Wt	72																																												
COL Sq Ft	45	Cu Ft	14																																												
Apron																																															
COM Ydg	½																																														
COL Sq Ft	10																																														
Seat Cushion																																															
COM Ydg	1 ¾																																														
COL Sq Ft	35																																														
48 Square Ottoman" 	AW4848 • select maple wood feet or metal feet, JSI standard finishes • specify upholstery on apron separately from upholstery on seat • quilted ottoman seat cushion available, specify and add \$205 list	<table border="1"> <thead> <tr> <th>Dimensions</th> <th>D</th> <th>W</th> <th>H</th> </tr> </thead> <tbody> <tr> <td>Overall</td> <td>48</td> <td>48</td> <td>15 ¼</td> </tr> <tr> <th colspan="2">Overall Upholstery</th> <th colspan="2">Shipping</th> </tr> <tr> <td>COM Ydg</td> <td>3</td> <td>Ctn Wt</td> <td>101</td> </tr> <tr> <td>COL Sq Ft</td> <td>60</td> <td>Cu Ft</td> <td>25</td> </tr> <tr> <th colspan="4">Apron</th> </tr> <tr> <td>COM Ydg</td> <td>½</td> <td></td> <td></td> </tr> <tr> <td>COL Sq Ft</td> <td>10</td> <td></td> <td></td> </tr> <tr> <th colspan="4">Seat Cushion</th> </tr> <tr> <td>COM Ydg</td> <td>2 ½</td> <td></td> <td></td> </tr> <tr> <td>COL Sq Ft</td> <td>50</td> <td></td> <td></td> </tr> </tbody> </table>	Dimensions	D	W	H	Overall	48	48	15 ¼	Overall Upholstery		Shipping		COM Ydg	3	Ctn Wt	101	COL Sq Ft	60	Cu Ft	25	Apron				COM Ydg	½			COL Sq Ft	10			Seat Cushion				COM Ydg	2 ½			COL Sq Ft	50			COM \$2,135 A \$2,165 B \$2,225 COL/C \$2,327 D \$2,462 E \$2,596 F \$2,804 G \$3,026 H \$3,265 I \$3,637 J \$4,084 L1 \$3,191 L2 \$3,488
		Dimensions	D	W	H																																										
Overall	48	48	15 ¼																																												
Overall Upholstery		Shipping																																													
COM Ydg	3	Ctn Wt	101																																												
COL Sq Ft	60	Cu Ft	25																																												
Apron																																															
COM Ydg	½																																														
COL Sq Ft	10																																														
Seat Cushion																																															
COM Ydg	2 ½																																														
COL Sq Ft	50																																														

To Order, Specify:

- 1 Model Number
- 2 Fabric Selection - vendor, pattern and color
 - a.) Apron
 - b.) Seat Cushion

Visit www.jsifurniture.com/finishes-and-materials/textiles for our textiles program. See selection of standard and graded in manufacturers and patterns.
- 3 Seat Cushion
 - a.) Plain (PSC)
 - b.) Quilted (QSC) - upcharge applies
- 4 Foot Option
 - a.) Wood - [See Wood Foot Option](#)
 - b.) Metal Finish - [See Metal Foot Option](#)

Specifications

- Frame constructed of hardwood plywood with metal fasteners.
- Wood legs include metal mounting plate and fixed metal glides.
- Metal legs feature adjustable foot with nylon glide and ½" adjustment range.
- Upholstery grade plywood with 5" of foam creates the seat suspension box.
- Upholstery is tailor sewn over multi-density high resilience polyurethane foam.
- Seat cushion thickness 4 ¼".

Arwyn Guest + Crossover Order Check List:



Specify:

- 1. Model Number
- 2. Fabric Selection
 - A. Extreme Back & Arm - Vendor, Pattern and Color
 - B. Interior Back & Arm - Vendor, Pattern and Color
 - C. Apron (Ottoman) - Vendor, Pattern and Color
 - D. Seat Cushion - Vendor, Pattern and Color
- 3. Leg Finish
 - A. Wood
 - B. Metal - see below
 - * Star Bases are always Polished Aluminum (PAM)
- 4. Optional Premium Polished Trim Grey Dual Wheel Soft Urethane Casters - add \$366 list

Example:

AW6011 (model #)	Maharam (fabric vendor)	Kvadrat Molly (pattern name)	170 (pattern color)	TOF (leg option)
	fabric specified per zone			

1. Model Number

2. Fabric Selection - Please supply the following:
Fabric vendor/ Pattern name/ Pattern color

For a complete list of JSI Standard and Graded-In Textiles click [here](#)

- Indicate direction of fabric - Railroaded or Up the Roll
- Please provide illustration, if available

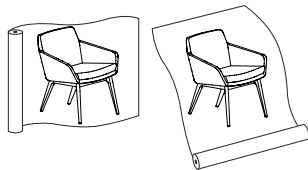
All COM orders must include the following:

- Vendor's name, pattern name and color
- Sample of the fabric attached to the order
- Model numbers of items for fabric application
- Special application instructions
- Customer and purchase order number

Ship prepaid COM material to:

JSI
Attn: COM Department
201 East Martin Street
Receiving B, Dock 71
Orleans, IN 47452

Application of fabric:
Railroaded Up the Roll



3. Leg Finish:

A. Wood Maple Leg

ALM	Ale Medium	HRV	Harvest
CAL	Ale Light Coordinate	CKC	Khaki Coordinate
BBM	Bourbon Medium	MINC	Mineral Coordinate
CBZ	Brazilwood Coordinate	MCH	Mocha
BARC	Barrel Coordinate	CPI	Pinnacle Walnut Coordinate
CBO	Bourbon Light Coordinate	PRL	Praline
CBG	Brighton Light Coordinate	RAVC	Raven Coordinate
BRM	Brighton Medium	SABC	Sable Coordinate
BUT	Butterscotch	SIE	Sienna
CNDC	Cinder Coordinate	CST	Studio Teak Coordinate
CLA	Classic	TRF	Truffle
CLL	Collectors	UMB	Umber
EGRC	Egret Coordinate	VALC	Valley Coordinate
ESP	Espresso	VEN	Venetian
FAWC	Fawn Coordinate	CWE	Weathered Ash Coordinate
FLX	Flax		
CGR	Graphite Coordinate		

B. Metal Leg

ABZ	Aged Bronze	MBK	Matte Black
ASL	Arctic Silver	PEW	Pewter
CHR	Chrome (upcharge applies)	SBZ	Soft Bronze
GLD	Gold	SNK	Soft Nickel

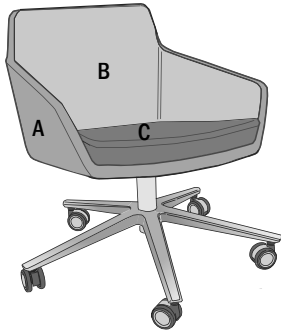
4. Optional Premium Polished Trim Grey Dual Wheel Soft Urethane Casters - add \$366 list

All COM orders will ship at standard lead time from receipt of COM except for orders requiring special custom matched finishes.

Fabric Application

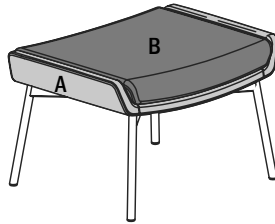
Arwyn affords the ability to be specified with multiple upholsteries to create a unique look. Upholstery zones are defined by the style of the unit.

Please note that the same pattern must be specified for the Extreme and Interior Back/Arm. Different colorways from the same pattern may be selected to create contrast. The seat cushion may be different pattern.



**Guest and Crossover
(all legs/base styles)**

- A = Extreme Back & Arm**
- B = Interior Back & Arm**
- C = Seat Cushion**



Crossover Ottoman
A = Apron
B = Seat Cushion

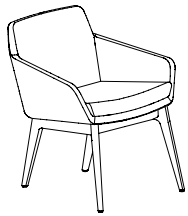
Description

Model

Specifications

List Price Per Grade

Guest Chair - Wood Leg



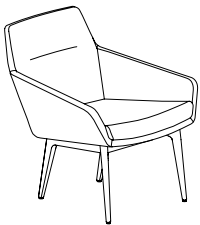
AW6000WL

- maple wood leg
- specify upholstery on extreme back/arm separately from upholstery on interior back/arm and separately from seat cushions
- upholstery pattern selected for the extreme outside of the chair and the interior must be the same, different colorways can be specified; seat upholstery can be different pattern.

Dimensions	D	W	H
Overall	28	26	32
Seat	18	19	18½
Arm			26½
Overall Upholstery		Shipping	
COM Ydg	2¼	Ctn Wt	39
COL Sq Ft	45	Cu Ft	17
Extreme Back & Arm			
COM Ydg	1¼		
COL Sq Ft	25		
Interior Back & Arm			
COM Ydg	1		
COL Sq Ft	20		
Seat Cushion			
COM Ydg	¾		
COL Sq Ft	15		

COM	\$1,633
A	\$1,658
B	\$1,708
COL/C	\$1,792
D	\$1,902
E	\$2,012
F	\$2,183
G	\$2,365
H	\$2,560
I	\$2,862
J	\$3,228
L1	\$2,498
L2	\$2,742

Mid Back Crossover Lounge - Wood Leg



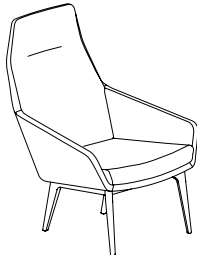
AW6001WL

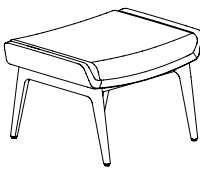
- maple wood leg
- specify upholstery on extreme back/arm separately from upholstery on interior back/arm and separately from seat cushions
- upholstery pattern selected for the extreme outside of the chair and the interior must be the same, different colorways can be specified; seat upholstery can be different pattern

Dimensions	D	W	H
Overall	30½	28	33
Seat	19½	21	17
Arm			25
Overall Upholstery		Shipping	
COM Ydg	2¾	Ctn Wt	42
COL Sq Ft	55	Cu Ft	20
Extreme Back & Arm			
COM Ydg	1¾		
COL Sq Ft	35		
Interior Back & Arm			
COM Ydg	1		
COL Sq Ft	20		
Seat Cushion			
COM Ydg	¾		
COL Sq Ft	15		

COM	\$1,784
A	\$1,815
B	\$1,874
COL/C	\$1,978
D	\$2,112
E	\$2,247
F	\$2,453
G	\$2,677
H	\$2,915
I	\$3,287
J	\$3,734
L1	\$2,841
L2	\$3,137

ARWYN

Description	Model	Specifications				List Price Per Grade	
High Back Crossover Lounge - Wood Leg 	AW6005WL · maple wood leg · specify upholstery on extreme back/arm separately from upholstery on interior back/arm and separately from seat cushions · upholstery pattern selected for the extreme outside of the chair and the interior must be the same, different colorways can be specified; seat upholstery can be different pattern	Dimensions	D	W	H	COM	\$1,816
		Overall	30 ½	28	41	A	\$1,850
		Seat	19 ½	21	17	B	\$1,915
		Arm			25	COL/C	\$2,028
		Overall Upholstery	Shipping			D	\$2,173
		COM Ydg	3	Ctn Wt	47	E	\$2,320
		COL Sq Ft	60	Cu Ft	24	F	\$2,548
		Extreme Back & Arm				G	\$2,791
		COM Ydg	1 ¾			H	\$3,051
		COL Sq Ft	35			I	\$3,456
		Interior Back & Arm				J	\$3,943
		COM Ydg	1			L1	\$2,969
COL Sq Ft	20			L2	\$3,293		
Seat Cushion							
COM Ydg	¾						
COL Sq Ft	15						

Description	Model	Specifications				List Price Per Grade	
Ottoman Crossover Lounge - Wood Leg 	AW6004WL · maple wood leg · specify upholstery on apron separately from upholstery on seat	Dimensions	D	W	H	COM	\$1,213
		Overall	19	26 ½	17 ¼	A	\$1,229
		Seat	19 ½	26 ½	17	B	\$1,262
		Overall Upholstery	Shipping			COL/C	\$1,318
		COM Ydg	1 ½	Ctn Wt	26	D	\$1,390
		COL Sq Ft	27	Cu Ft	7	E	\$1,465
		Apron Upholstery				F	\$1,578
		COM Ydg	1			G	\$1,699
		COL Sq Ft	18			H	\$1,830
		Seat Cushion Upholstery				I	\$2,032
		COM Ydg	1			J	\$2,276
		COL Sq Ft	18			L1	\$1,724
				L2	\$1,870		

To Order, Specify:

- ① Model Number
- ② Fabric Selection - vendor, pattern and color
 - a.) Extreme Back & Arm
 - b.) Interior Back & Arm
 - c.) Apron (Ottoman)
 - d.) Seat Cushion

Visit www.jsifurniture.com/finishes-and-materials/textiles for our textiles program. See selection of standard and graded in manufacturers and patterns.

- ③ Wood Leg Finish - see [Wood Leg Finish](#)

Specifications

Crossover

- Compound curved plywood shell construction, arms attached with custom hardwood supports.
- Wood leg frame made of high grade exterior solid lumber using mortise and tenon and dowel construction. Nail in metal glides standard.
- Leg frame fasten to the shell with pre-bored fastening wood screws.
- Seat cushion thickness 2 ½".
- Back cushion tapered thickness - 1" tapered to 2" (top to bottom).

Ottoman

- Seat has curved plywood shell construction.
- Wood leg frame made of high grade exterior solid lumber using mortise and tenon and dowel construction. Nail in metal glides standard.
- Upholstery is tailor sewn over multi-density high resilience polyurethane foam.
- Seat cushion thickness 3 ½"

ARWYN

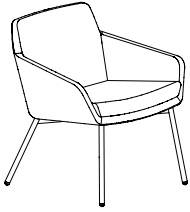
Description

Model

Specifications

List Price Per Grade

Guest Chair - Metal Leg



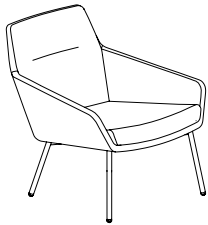
AW6000ML

- metal legs available in JSI standard finishes, chrome (CHR) available; specify and add \$489 list
- specify upholstery on extreme back/arm separately from upholstery on interior back/arm and separately from seat cushions
- upholstery pattern selected for the extreme outside of the chair and the interior must be the same, different colorways can be specified; seat upholstery can be different pattern

Dimensions	D	W	H
Overall	28	26	32
Seat	18	19	18½
Arm			26½
Overall Upholstery		Shipping	
COM Ydg	2¼	Ctn Wt	39
COL Sq Ft	45	Cu Ft	17
Extreme Back & Arm			
COM Ydg	1¼		
COL Sq Ft	25		
Interior Back & Arm			
COM Ydg	1		
COL Sq Ft	20		
Seat Cushion			
COM Ydg	¾		
COL Sq Ft	15		

COM	\$1,697
A	\$1,721
B	\$1,770
COL/C	\$1,856
D	\$1,965
E	\$2,075
F	\$2,245
G	\$2,428
H	\$2,622
I	\$2,926
J	\$3,292
L1	\$2,561
L2	\$2,805

Mid Back Crossover Lounge - Metal Leg



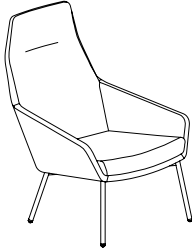
AW6001ML

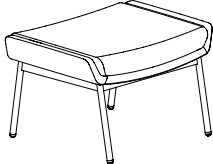
- metal legs available in JSI standard finishes, chrome (CHR) available; specify and add \$539 list
- specify upholstery on extreme back/arm separately from upholstery on interior back/arm and separately from seat cushions
- upholstery pattern selected for the extreme outside of the chair and the interior must be the same, different colorways can be specified; seat upholstery can be different pattern

Dimensions	D	W	H
Overall	30½	28	33
Seat	19½	21	17
Arm			26½
Overall Upholstery		Shipping	
COM Ydg	2¾	Ctn Wt	42
COL Sq Ft	55	Cu Ft	20
Extreme Back & Arm			
COM Ydg	1¾		
COL Sq Ft	35		
Interior Back & Arm			
COM Ydg	1		
COL Sq Ft	20		
Seat Cushion			
COM Ydg	¾		
COL Sq Ft	15		

COM	\$1,881
A	\$1,913
B	\$1,972
COL/C	\$2,075
D	\$2,209
E	\$2,344
F	\$2,551
G	\$2,774
H	\$3,012
I	\$3,384
J	\$3,830
L1	\$2,938
L2	\$3,235

ARWYN

Description	Model	Specifications	List Price Per Grade																																										
High Back Crossover Lounge - Metal Leg 	AW6005ML • metal legs available in JSI standard finishes, chrome (CHR) available; specify and add \$539 list • specify upholstery on extreme back/arm separately from upholstery on interior back/arm and separately from seat cushions • upholstery pattern selected for the extreme outside of the chair and the interior must be the same, different colorways can be specified; seat upholstery can be different pattern	<table border="1"> <thead> <tr> <th>Dimensions</th> <th>D</th> <th>W</th> <th>H</th> </tr> </thead> <tbody> <tr> <td>Overall</td> <td>30½</td> <td>28</td> <td>41</td> </tr> <tr> <td>Seat</td> <td>19½</td> <td>21</td> <td>17</td> </tr> <tr> <td>Arm</td> <td></td> <td></td> <td>25</td> </tr> </tbody> </table>	Dimensions	D	W	H	Overall	30½	28	41	Seat	19½	21	17	Arm			25	<table border="1"> <tbody> <tr> <td>COM</td> <td>\$1,915</td> </tr> <tr> <td>A</td> <td>\$1,948</td> </tr> <tr> <td>B</td> <td>\$2,014</td> </tr> <tr> <td>COL/C</td> <td>\$2,126</td> </tr> <tr> <td>D</td> <td>\$2,273</td> </tr> <tr> <td>E</td> <td>\$2,418</td> </tr> <tr> <td>F</td> <td>\$2,645</td> </tr> <tr> <td>G</td> <td>\$2,888</td> </tr> <tr> <td>H</td> <td>\$3,149</td> </tr> <tr> <td>I</td> <td>\$3,554</td> </tr> <tr> <td>J</td> <td>\$4,042</td> </tr> <tr> <td>L1</td> <td>\$3,067</td> </tr> <tr> <td>L2</td> <td>\$3,392</td> </tr> </tbody> </table>	COM	\$1,915	A	\$1,948	B	\$2,014	COL/C	\$2,126	D	\$2,273	E	\$2,418	F	\$2,645	G	\$2,888	H	\$3,149	I	\$3,554	J	\$4,042	L1	\$3,067	L2	\$3,392
		Dimensions	D	W	H																																								
		Overall	30½	28	41																																								
		Seat	19½	21	17																																								
		Arm			25																																								
		COM	\$1,915																																										
		A	\$1,948																																										
		B	\$2,014																																										
		COL/C	\$2,126																																										
		D	\$2,273																																										
		E	\$2,418																																										
		F	\$2,645																																										
		G	\$2,888																																										
		H	\$3,149																																										
		I	\$3,554																																										
J	\$4,042																																												
L1	\$3,067																																												
L2	\$3,392																																												
<table border="1"> <thead> <tr> <th>Overall Upholstery</th> <th>Shipping</th> </tr> </thead> <tbody> <tr> <td>COM Ydg</td> <td>3</td> </tr> <tr> <td>Ctn Wt</td> <td>47</td> </tr> <tr> <td>COL Sq Ft</td> <td>60</td> </tr> <tr> <td>Cu Ft</td> <td>24</td> </tr> </tbody> </table>	Overall Upholstery	Shipping	COM Ydg	3	Ctn Wt	47	COL Sq Ft	60	Cu Ft	24																																			
Overall Upholstery	Shipping																																												
COM Ydg	3																																												
Ctn Wt	47																																												
COL Sq Ft	60																																												
Cu Ft	24																																												
<table border="1"> <thead> <tr> <th>Extreme Back & Arm</th> <th></th> </tr> </thead> <tbody> <tr> <td>COM Ydg</td> <td>1¾</td> </tr> <tr> <td>COL Sq Ft</td> <td>35</td> </tr> </tbody> </table>	Extreme Back & Arm		COM Ydg	1¾	COL Sq Ft	35																																							
Extreme Back & Arm																																													
COM Ydg	1¾																																												
COL Sq Ft	35																																												
<table border="1"> <thead> <tr> <th>Interior Back & Arm</th> <th></th> </tr> </thead> <tbody> <tr> <td>COM Ydg</td> <td>1</td> </tr> <tr> <td>COL Sq Ft</td> <td>20</td> </tr> </tbody> </table>	Interior Back & Arm		COM Ydg	1	COL Sq Ft	20																																							
Interior Back & Arm																																													
COM Ydg	1																																												
COL Sq Ft	20																																												
<table border="1"> <thead> <tr> <th>Seat Cushion</th> <th></th> </tr> </thead> <tbody> <tr> <td>COM Ydg</td> <td>¾</td> </tr> <tr> <td>COL Sq Ft</td> <td>15</td> </tr> </tbody> </table>	Seat Cushion		COM Ydg	¾	COL Sq Ft	15																																							
Seat Cushion																																													
COM Ydg	¾																																												
COL Sq Ft	15																																												

Description	Model	Specifications	List Price Per Grade																																						
Ottoman Crossover Lounge - Metal Leg 	AW6004ML • metal legs available in JSI standard finishes, chrome (CHR) available; specify and add \$512 list • specify upholstery on apron separately from upholstery on seat	<table border="1"> <thead> <tr> <th>Dimensions</th> <th>D</th> <th>W</th> <th>H</th> </tr> </thead> <tbody> <tr> <td>Overall</td> <td>19</td> <td>26½</td> <td>17¼</td> </tr> <tr> <td>Seat</td> <td>19½</td> <td>26½</td> <td>17</td> </tr> </tbody> </table>	Dimensions	D	W	H	Overall	19	26½	17¼	Seat	19½	26½	17	<table border="1"> <tbody> <tr> <td>COM</td> <td>\$1,329</td> </tr> <tr> <td>A</td> <td>\$1,344</td> </tr> <tr> <td>B</td> <td>\$1,377</td> </tr> <tr> <td>COL/C</td> <td>\$1,433</td> </tr> <tr> <td>D</td> <td>\$1,507</td> </tr> <tr> <td>E</td> <td>\$1,581</td> </tr> <tr> <td>F</td> <td>\$1,694</td> </tr> <tr> <td>G</td> <td>\$1,815</td> </tr> <tr> <td>H</td> <td>\$1,945</td> </tr> <tr> <td>I</td> <td>\$2,148</td> </tr> <tr> <td>J</td> <td>\$2,392</td> </tr> <tr> <td>L1</td> <td>\$1,840</td> </tr> <tr> <td>L2</td> <td>\$1,986</td> </tr> </tbody> </table>	COM	\$1,329	A	\$1,344	B	\$1,377	COL/C	\$1,433	D	\$1,507	E	\$1,581	F	\$1,694	G	\$1,815	H	\$1,945	I	\$2,148	J	\$2,392	L1	\$1,840	L2	\$1,986
		Dimensions	D	W	H																																				
		Overall	19	26½	17¼																																				
		Seat	19½	26½	17																																				
		COM	\$1,329																																						
		A	\$1,344																																						
		B	\$1,377																																						
		COL/C	\$1,433																																						
		D	\$1,507																																						
		E	\$1,581																																						
		F	\$1,694																																						
		G	\$1,815																																						
		H	\$1,945																																						
		I	\$2,148																																						
		J	\$2,392																																						
L1	\$1,840																																								
L2	\$1,986																																								
<table border="1"> <thead> <tr> <th>Overall Upholstery</th> <th>Shipping</th> </tr> </thead> <tbody> <tr> <td>COM Ydg</td> <td>1½</td> </tr> <tr> <td>Ctn Wt</td> <td>26</td> </tr> <tr> <td>COL Sq Ft</td> <td>27</td> </tr> <tr> <td>Cu Ft</td> <td>7</td> </tr> </tbody> </table>	Overall Upholstery	Shipping	COM Ydg	1½	Ctn Wt	26	COL Sq Ft	27	Cu Ft	7																															
Overall Upholstery	Shipping																																								
COM Ydg	1½																																								
Ctn Wt	26																																								
COL Sq Ft	27																																								
Cu Ft	7																																								
<table border="1"> <thead> <tr> <th>Apron</th> <th></th> </tr> </thead> <tbody> <tr> <td>COM Ydg</td> <td>1</td> </tr> <tr> <td>COL Sq Ft</td> <td>18</td> </tr> </tbody> </table>	Apron		COM Ydg	1	COL Sq Ft	18																																			
Apron																																									
COM Ydg	1																																								
COL Sq Ft	18																																								
<table border="1"> <thead> <tr> <th>Seat Cushion</th> <th></th> </tr> </thead> <tbody> <tr> <td>COM Ydg</td> <td>1</td> </tr> <tr> <td>COL Sq Ft</td> <td>18</td> </tr> </tbody> </table>	Seat Cushion		COM Ydg	1	COL Sq Ft	18																																			
Seat Cushion																																									
COM Ydg	1																																								
COL Sq Ft	18																																								

To Order, Specify:

- 1 Model Number
 - 2 Fabric Selection - vendor, pattern and color
 - a.) Extreme Back & Arm
 - b.) Interior Back & Arm
 - c.) Apron (Ottoman)
 - d.) Seat Cushion
- Visit www.jsifurniture.com/finishes-and-materials/textiles for our textiles program. See selection of standard and graded in manufacturers and patterns.
- 3 Metal Leg Option
 - a.) Metal Finish - [See Metal Leg Option](#)


Specifications


Crossover

- Compound curved plywood shell construction, arms attached with custom hardwood supports.
- Metal leg frame with 7/8" dia. legs. Legs have metal foot with domed nylon glide and ½" adjustment range.
- Upholstery is tailor sewn over multi-density high resilience polyurethane foam.
- Seat cushion thickness 2½".
- Back cushion tapered thickness - 1" tapered to 2" (top to bottom).

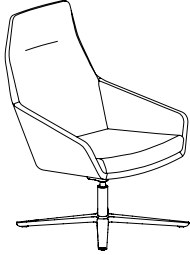
Ottoman

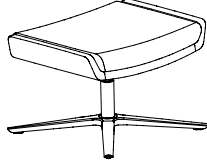
- Seat has curved plywood shell construction.
- Metal leg frame with 7/8" diameter legs. Legs have metal foot with domed nylon glide and ½" adjustment range.
- Upholstery is tailor sewn over multi-density high resilience polyurethane foam.
- Seat cushion thickness 3½"

Description	Model	Specifications	List Price Per Grade																
Swivel Guest Chair with 4 Star Base 	AW6000B · four star 28" diameter base, always polished aluminum · swivel base offers limited tilt, stationary height with self-returning mechanism · specify upholstery on extreme back/arm separately from upholstery on interior back/arm and separately from seat cushions · upholstery pattern selected for the extreme outside of the chair and the interior must be the same, different colorways can be specified; seat upholstery can be different pattern	<table border="1"> <thead> <tr> <th>Dimensions</th> <th>D</th> <th>W</th> <th>H</th> </tr> </thead> <tbody> <tr> <td>Overall</td> <td>28</td> <td>26</td> <td>32</td> </tr> <tr> <td>Seat</td> <td>18</td> <td>19</td> <td>17</td> </tr> <tr> <td>Arm</td> <td></td> <td></td> <td>26½</td> </tr> </tbody> </table>	Dimensions	D	W	H	Overall	28	26	32	Seat	18	19	17	Arm			26½	COM \$1,603 A \$1,627 B \$1,676 COL/C \$1,761 D \$1,872 E \$1,982 F \$2,151 G \$2,334 H \$2,528 I \$2,833 J \$3,198 L1 \$2,467 L2 \$2,711
		Dimensions	D	W	H														
		Overall	28	26	32														
		Seat	18	19	17														
		Arm			26½														
		<table border="1"> <thead> <tr> <th>Overall Upholstery</th> <th colspan="3">Shipping</th> </tr> </thead> <tbody> <tr> <td>COM Ydg</td> <td>2 ¼</td> <td>Ctn Wt</td> <td>39</td> </tr> <tr> <td>COL Sq Ft</td> <td>45</td> <td>Cu Ft</td> <td>17</td> </tr> </tbody> </table>	Overall Upholstery	Shipping			COM Ydg	2 ¼	Ctn Wt	39	COL Sq Ft	45	Cu Ft	17					
		Overall Upholstery	Shipping																
		COM Ydg	2 ¼	Ctn Wt	39														
		COL Sq Ft	45	Cu Ft	17														
		<table border="1"> <thead> <tr> <th colspan="4">Extreme Back & Arm</th> </tr> </thead> <tbody> <tr> <td>COM Ydg</td> <td>1 ¼</td> <td></td> <td></td> </tr> <tr> <td>COL Sq Ft</td> <td>25</td> <td></td> <td></td> </tr> </tbody> </table>	Extreme Back & Arm				COM Ydg	1 ¼			COL Sq Ft	25							
Extreme Back & Arm																			
COM Ydg	1 ¼																		
COL Sq Ft	25																		
<table border="1"> <thead> <tr> <th colspan="4">Interior Back & Arm</th> </tr> </thead> <tbody> <tr> <td>COM Ydg</td> <td>1</td> <td></td> <td></td> </tr> <tr> <td>COL Sq Ft</td> <td>20</td> <td></td> <td></td> </tr> </tbody> </table>	Interior Back & Arm				COM Ydg	1			COL Sq Ft	20									
Interior Back & Arm																			
COM Ydg	1																		
COL Sq Ft	20																		
<table border="1"> <thead> <tr> <th colspan="4">Seat Cushion</th> </tr> </thead> <tbody> <tr> <td>COM Ydg</td> <td>¾</td> <td></td> <td></td> </tr> <tr> <td>COL Sq Ft</td> <td>15</td> <td></td> <td></td> </tr> </tbody> </table>	Seat Cushion				COM Ydg	¾			COL Sq Ft	15									
Seat Cushion																			
COM Ydg	¾																		
COL Sq Ft	15																		

Mid Back Crossover Lounge with 4 Star Base 	AW6001B · four star 32" diameter base, always polished aluminum · swivel base offers limited tilt, stationary height with self-returning mechanism · specify upholstery on extreme back/arm separately from upholstery on interior back/arm and separately from seat cushions · upholstery pattern selected for the extreme outside of the chair and the interior must be the same, different colorways can be specified; seat upholstery can be different pattern	<table border="1"> <thead> <tr> <th>Dimensions</th> <th>D</th> <th>W</th> <th>H</th> </tr> </thead> <tbody> <tr> <td>Overall</td> <td>30 ½</td> <td>28</td> <td>33</td> </tr> <tr> <td>Seat</td> <td>19 ½</td> <td>21</td> <td>17</td> </tr> <tr> <td>Arm</td> <td></td> <td></td> <td>25</td> </tr> </tbody> </table>	Dimensions	D	W	H	Overall	30 ½	28	33	Seat	19 ½	21	17	Arm			25	COM \$1,772 A \$1,802 B \$1,861 COL/C \$1,965 D \$2,100 E \$2,234 F \$2,441 G \$2,664 H \$2,902 I \$3,275 J \$3,720 L1 \$2,828 L2 \$3,126
		Dimensions	D	W	H														
		Overall	30 ½	28	33														
		Seat	19 ½	21	17														
		Arm			25														
		<table border="1"> <thead> <tr> <th>Overall Upholstery</th> <th colspan="3">Shipping</th> </tr> </thead> <tbody> <tr> <td>COM Ydg</td> <td>2 ¾</td> <td>Ctn Wt</td> <td>42</td> </tr> <tr> <td>COL Sq Ft</td> <td>55</td> <td>Cu Ft</td> <td>20</td> </tr> </tbody> </table>	Overall Upholstery	Shipping			COM Ydg	2 ¾	Ctn Wt	42	COL Sq Ft	55	Cu Ft	20					
		Overall Upholstery	Shipping																
		COM Ydg	2 ¾	Ctn Wt	42														
		COL Sq Ft	55	Cu Ft	20														
		<table border="1"> <thead> <tr> <th colspan="4">Extreme Back & Arm</th> </tr> </thead> <tbody> <tr> <td>COM Ydg</td> <td>1 ¾</td> <td></td> <td></td> </tr> <tr> <td>COL Sq Ft</td> <td>35</td> <td></td> <td></td> </tr> </tbody> </table>	Extreme Back & Arm				COM Ydg	1 ¾			COL Sq Ft	35							
Extreme Back & Arm																			
COM Ydg	1 ¾																		
COL Sq Ft	35																		
<table border="1"> <thead> <tr> <th colspan="4">Interior Back & Arm</th> </tr> </thead> <tbody> <tr> <td>COM Ydg</td> <td>1</td> <td></td> <td></td> </tr> <tr> <td>COL Sq Ft</td> <td>20</td> <td></td> <td></td> </tr> </tbody> </table>	Interior Back & Arm				COM Ydg	1			COL Sq Ft	20									
Interior Back & Arm																			
COM Ydg	1																		
COL Sq Ft	20																		
<table border="1"> <thead> <tr> <th colspan="4">Seat Cushion</th> </tr> </thead> <tbody> <tr> <td>COM Ydg</td> <td>¾</td> <td></td> <td></td> </tr> <tr> <td>COL Sq Ft</td> <td>15</td> <td></td> <td></td> </tr> </tbody> </table>	Seat Cushion				COM Ydg	¾			COL Sq Ft	15									
Seat Cushion																			
COM Ydg	¾																		
COL Sq Ft	15																		

ARWYN

Description	Model	Specifications	List Price Per Grade																																																																																										
High Back Crossover Lounge with 4 Star Base 	AW6005B · four star 32" diameter base, always polished aluminum · swivel base offers limited tilt, stationary height with self-returning mechanism · specify upholstery on extreme back/arm separately from upholstery on interior back/arm and separately from seat cushions · upholstery pattern selected for the extreme outside of the chair and the interior must be the same, different colorways can be specified; seat upholstery can be different pattern	<table border="1"> <thead> <tr> <th>Dimensions</th> <th>D</th> <th>W</th> <th>H</th> </tr> </thead> <tbody> <tr> <td>Overall</td> <td>30 ½</td> <td>28</td> <td>41</td> </tr> <tr> <td>Seat</td> <td>19 ½</td> <td>21</td> <td>17</td> </tr> <tr> <td>Arm</td> <td></td> <td></td> <td>25</td> </tr> <tr> <th colspan="2">Overall Upholstery</th> <th colspan="2">Shipping</th> </tr> <tr> <td>COM Ydg</td> <td>3</td> <td>Ctn Wt</td> <td>47</td> </tr> <tr> <td>COL Sq Ft</td> <td>60</td> <td>Cu Ft</td> <td>24</td> </tr> <tr> <th colspan="4">Extreme Back & Arm</th> </tr> <tr> <td>COM Ydg</td> <td>1 ¾</td> <td></td> <td></td> </tr> <tr> <td>COL Sq Ft</td> <td>35</td> <td></td> <td></td> </tr> <tr> <th colspan="4">Interior Back & Arm</th> </tr> <tr> <td>COM Ydg</td> <td>1</td> <td></td> <td></td> </tr> <tr> <td>COL Sq Ft</td> <td>20</td> <td></td> <td></td> </tr> <tr> <th colspan="4">Seat Cushion</th> </tr> <tr> <td>COM Ydg</td> <td>¾</td> <td></td> <td></td> </tr> <tr> <td>COL Sq Ft</td> <td>15</td> <td></td> <td></td> </tr> </tbody> </table>	Dimensions	D	W	H	Overall	30 ½	28	41	Seat	19 ½	21	17	Arm			25	Overall Upholstery		Shipping		COM Ydg	3	Ctn Wt	47	COL Sq Ft	60	Cu Ft	24	Extreme Back & Arm				COM Ydg	1 ¾			COL Sq Ft	35			Interior Back & Arm				COM Ydg	1			COL Sq Ft	20			Seat Cushion				COM Ydg	¾			COL Sq Ft	15			<table> <tr><td>COM</td><td>\$1,848</td></tr> <tr><td>A</td><td>\$1,880</td></tr> <tr><td>B</td><td>\$1,945</td></tr> <tr><td>COL/C</td><td>\$2,059</td></tr> <tr><td>D</td><td>\$2,205</td></tr> <tr><td>E</td><td>\$2,351</td></tr> <tr><td>F</td><td>\$2,577</td></tr> <tr><td>G</td><td>\$2,820</td></tr> <tr><td>H</td><td>\$3,082</td></tr> <tr><td>I</td><td>\$3,487</td></tr> <tr><td>J</td><td>\$3,973</td></tr> <tr><td>L1</td><td>\$3,000</td></tr> <tr><td>L2</td><td>\$3,325</td></tr> </table>	COM	\$1,848	A	\$1,880	B	\$1,945	COL/C	\$2,059	D	\$2,205	E	\$2,351	F	\$2,577	G	\$2,820	H	\$3,082	I	\$3,487	J	\$3,973	L1	\$3,000	L2	\$3,325
		Dimensions	D	W	H																																																																																								
		Overall	30 ½	28	41																																																																																								
		Seat	19 ½	21	17																																																																																								
		Arm			25																																																																																								
		Overall Upholstery		Shipping																																																																																									
		COM Ydg	3	Ctn Wt	47																																																																																								
		COL Sq Ft	60	Cu Ft	24																																																																																								
		Extreme Back & Arm																																																																																											
		COM Ydg	1 ¾																																																																																										
COL Sq Ft	35																																																																																												
Interior Back & Arm																																																																																													
COM Ydg	1																																																																																												
COL Sq Ft	20																																																																																												
Seat Cushion																																																																																													
COM Ydg	¾																																																																																												
COL Sq Ft	15																																																																																												
COM	\$1,848																																																																																												
A	\$1,880																																																																																												
B	\$1,945																																																																																												
COL/C	\$2,059																																																																																												
D	\$2,205																																																																																												
E	\$2,351																																																																																												
F	\$2,577																																																																																												
G	\$2,820																																																																																												
H	\$3,082																																																																																												
I	\$3,487																																																																																												
J	\$3,973																																																																																												
L1	\$3,000																																																																																												
L2	\$3,325																																																																																												

Ottoman Crossover Lounge - 4 Star Base 	AW6004B · four star 28" diameter base, always polished aluminum · specify upholstery on apron separately from upholstery on seat	<table border="1"> <thead> <tr> <th>Dimensions</th> <th>D</th> <th>W</th> <th>H</th> </tr> </thead> <tbody> <tr> <td>Overall</td> <td>19</td> <td>26 ½</td> <td>17 ¼</td> </tr> <tr> <td>Seat</td> <td>19 ½</td> <td>26 ½</td> <td>17</td> </tr> <tr> <th colspan="2">Overall Upholstery</th> <th colspan="2">Shipping</th> </tr> <tr> <td>COM Ydg</td> <td>1 ½</td> <td>Ctn Wt</td> <td>26</td> </tr> <tr> <td>COL Sq Ft</td> <td>27</td> <td>Cu Ft</td> <td>7</td> </tr> <tr> <th colspan="4">Apron</th> </tr> <tr> <td>COM Ydg</td> <td>1</td> <td></td> <td></td> </tr> <tr> <td>COL Sq Ft</td> <td>18</td> <td></td> <td></td> </tr> <tr> <th colspan="4">Seat Cushion</th> </tr> <tr> <td>COM Ydg</td> <td>1</td> <td></td> <td></td> </tr> <tr> <td>COL Sq Ft</td> <td>18</td> <td></td> <td></td> </tr> </tbody> </table>	Dimensions	D	W	H	Overall	19	26 ½	17 ¼	Seat	19 ½	26 ½	17	Overall Upholstery		Shipping		COM Ydg	1 ½	Ctn Wt	26	COL Sq Ft	27	Cu Ft	7	Apron				COM Ydg	1			COL Sq Ft	18			Seat Cushion				COM Ydg	1			COL Sq Ft	18			<table> <tr><td>COM</td><td>\$1,188</td></tr> <tr><td>A</td><td>\$1,206</td></tr> <tr><td>B</td><td>\$1,239</td></tr> <tr><td>COL/C</td><td>\$1,294</td></tr> <tr><td>D</td><td>\$1,367</td></tr> <tr><td>E</td><td>\$1,442</td></tr> <tr><td>F</td><td>\$1,555</td></tr> <tr><td>G</td><td>\$1,675</td></tr> <tr><td>H</td><td>\$1,807</td></tr> <tr><td>I</td><td>\$2,008</td></tr> <tr><td>J</td><td>\$2,252</td></tr> <tr><td>L1</td><td>\$1,700</td></tr> <tr><td>L2</td><td>\$1,848</td></tr> </table>	COM	\$1,188	A	\$1,206	B	\$1,239	COL/C	\$1,294	D	\$1,367	E	\$1,442	F	\$1,555	G	\$1,675	H	\$1,807	I	\$2,008	J	\$2,252	L1	\$1,700	L2	\$1,848
		Dimensions	D	W	H																																																																								
		Overall	19	26 ½	17 ¼																																																																								
		Seat	19 ½	26 ½	17																																																																								
		Overall Upholstery		Shipping																																																																									
		COM Ydg	1 ½	Ctn Wt	26																																																																								
		COL Sq Ft	27	Cu Ft	7																																																																								
		Apron																																																																											
		COM Ydg	1																																																																										
		COL Sq Ft	18																																																																										
Seat Cushion																																																																													
COM Ydg	1																																																																												
COL Sq Ft	18																																																																												
COM	\$1,188																																																																												
A	\$1,206																																																																												
B	\$1,239																																																																												
COL/C	\$1,294																																																																												
D	\$1,367																																																																												
E	\$1,442																																																																												
F	\$1,555																																																																												
G	\$1,675																																																																												
H	\$1,807																																																																												
I	\$2,008																																																																												
J	\$2,252																																																																												
L1	\$1,700																																																																												
L2	\$1,848																																																																												

To Order, Specify:

- 1 Model Number
- 2 Fabric Selection - vendor, pattern and color
 - a.) Extreme Back & Arm
 - b.) Interior Back & Arm
 - c.) Apron (Ottoman)
 - d.) Seat Cushion

Visit www.jsifurniture.com/finishes-and-materials/textiles for our textiles program. See selection of standard and graded in manufacturers and patterns.


Specifications

Crossover

- Compound curved plywood shell construction, arms attached with custom hardwood supports.
- Control mechanism features forward and back limited tilt with fixed height cylinder with auto return.
- 4 Star aluminum base with fixed nylon glides.
- Upholstery is tailor sewn over multi-density high resilience polyurethane foam.
- Seat cushion thickness 2 ½".
- Back cushion tapered thickness - 1" tapered to 2" (top to bottom).

Ottoman

- Seat has curved plywood shell construction.
- Ottoman has fixed height control and cylinder with auto return.
- 4 Star aluminum base with fixed nylon glides.
- Upholstery is tailor sewn over multi-density high resilience polyurethane foam.
- Seat cushion thickness 3 ½"

Description	① Model	Specifications			List Price Per Grade																
Swivel Guest Chair with 5 Star Base 	AW6000C · specify upholstery on extreme back/arm separately from upholstery on interior back/arm and separately from seat cushions · upholstery pattern selected for the extreme outside of the chair and the interior must be the same, different colorways can be specified; seat upholstery can be different pattern · five star 26" diameter base with casters, always polished aluminum · standard black (BLK) casters, specify optional premium polished trim grey dual wheel soft urethane (PPG) and add \$366 list · swivel base offers limited tilt, height adjustment · overall height range is 32 - 35 ½ · seat height range is 17 - 18 ½ - 22 · arm height range is 17 - 26 ½ - 30	<table border="1"> <thead> <tr> <th>Dimensions</th> <th>D</th> <th>W</th> <th>H</th> </tr> </thead> <tbody> <tr> <td>Overall</td> <td>28</td> <td>26</td> <td>32</td> </tr> <tr> <td>Seat</td> <td>18</td> <td>19</td> <td>18 ½</td> </tr> <tr> <td>Arm</td> <td></td> <td></td> <td>26 ½</td> </tr> </tbody> </table>			Dimensions	D	W	H	Overall	28	26	32	Seat	18	19	18 ½	Arm			26 ½	COM \$1,578 A \$1,603 B \$1,652 COL/C \$1,738 D \$1,848 E \$1,957 F \$2,126 G \$2,309 H \$2,504 I \$2,808 J \$3,174 L1 \$2,442 L2 \$2,686
		Dimensions	D	W	H																
		Overall	28	26	32																
		Seat	18	19	18 ½																
		Arm			26 ½																
		<table border="1"> <thead> <tr> <th>Overall Upholstery</th> <th colspan="2">Shipping</th> </tr> </thead> <tbody> <tr> <td>COM Ydg</td> <td>2 ¼</td> <td>Ctn Wt 42</td> </tr> <tr> <td>COL Sq Ft</td> <td>45</td> <td>Cu Ft 17</td> </tr> </tbody> </table>		Overall Upholstery	Shipping		COM Ydg	2 ¼	Ctn Wt 42	COL Sq Ft	45	Cu Ft 17									
		Overall Upholstery	Shipping																		
		COM Ydg	2 ¼	Ctn Wt 42																	
		COL Sq Ft	45	Cu Ft 17																	
		<table border="1"> <thead> <tr> <th colspan="2">Extreme Back & Arm</th> </tr> </thead> <tbody> <tr> <td>COM Ydg</td> <td>1 ¼</td> </tr> <tr> <td>COL Sq Ft</td> <td>25</td> </tr> </tbody> </table>		Extreme Back & Arm		COM Ydg	1 ¼	COL Sq Ft	25												
Extreme Back & Arm																					
COM Ydg	1 ¼																				
COL Sq Ft	25																				
<table border="1"> <thead> <tr> <th colspan="2">Interior Back & Arm</th> </tr> </thead> <tbody> <tr> <td>COM Ydg</td> <td>1</td> </tr> <tr> <td>COL Sq Ft</td> <td>20</td> </tr> </tbody> </table>		Interior Back & Arm		COM Ydg	1	COL Sq Ft	20														
Interior Back & Arm																					
COM Ydg	1																				
COL Sq Ft	20																				
<table border="1"> <thead> <tr> <th colspan="2">Seat Cushion</th> </tr> </thead> <tbody> <tr> <td>COM Ydg</td> <td>¾</td> </tr> <tr> <td>COL Sq Ft</td> <td>15</td> </tr> </tbody> </table>		Seat Cushion		COM Ydg	¾	COL Sq Ft	15														
Seat Cushion																					
COM Ydg	¾																				
COL Sq Ft	15																				

ARWYN

To Order, Specify:

- ① Model Number
- ② Fabric Selection - vendor, pattern and color
 - a.) Extreme Back & Arm
 - b.) Interior Back & Arm
 - c.) Seat Cushion
 Visit www.jsifurniture.com/finishes-and-materials/textiles for our textiles program. See selection of standard and graded in manufacturers and patterns.
- ③ Optional Premium Polished Trim Grey Dual Wheel Soft Urethane Casters - add \$366

Specifications

- Compound curved plywood shell construction, arms attached with custom hardwood supports.
- Control mechanism features forward and back limited with height adjustable cylinder.
- 5 Star aluminum base with casters.
- Upholstery is tailor sewn over multi-density high resilience polyurethane foam.
- Seat cushion thickness 2 ½".
- Back cushion tapered thickness - 1" tapered to 2" (top to bottom).

Arwyn Occasional Tables Order Check List:



Specify:

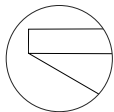
- 1. Model Number**
- 2. Top Material**
 - a.) **Veneer**
 - 1.) **Wood Species - Cherry (CH1), Maple (MA1), Walnut (WA1), Black Oak (BO1) or Double Cut (DC1)**
 - 2.) **Wood Finish**
 - b.) **Laminate**
 - 1.) **Laminate Color**
 - c.) **Solid Surface**
 - 1.) **Solid Surface Color - Armadillo (ARM), Black Pearl (BLP), Pebble Pearl (PEB) or Pure White (PUR)**
 - d.) **Glass**
 - 1.) **Glass Color - Black Back Painted Matte (MBB) or White Back Painted (WBP)**
- 3. Leg Finish**
 - a.) **Wood** Note: when wood top is selected, leg finish defaults to match
 - b.) **Metal**

Example:

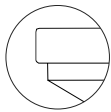
AMV1616-19SQML | **WA1** | **MCH** | **SNK**
 (model #) | (veneer species) | (wood finish) | (metal leg color)

1. Model Number

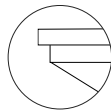
2. Top Material Selection:



Veneer



Solid Surface



Glass

Veneer

CH1 Cherry <i>Flat Cut Veneer</i>	
BBM Bourbon Medium	CLL Collectors
BRM Brighton Medium	HRV Harvest
CLA Classic	PRL Praline
MA1 Maple <i>Flat Cut Veneer</i>	
ALM Ale Medium	FLX Flax
BUT Butterscotch	VEN Venetian
WA1 Walnut <i>Flat Cut Veneer</i>	
ESP Espresso	TRF Truffle
MCH Mocha	UMB Umber
SIE Sienna	
BO1 Black Oak <i>Flat Cut Veneer</i>	
RAV Raven	
DC1 Double Cut Veneer <i>Eased Edge Only</i>	
BAR Barrel - Oak Pattern	KHK Khaki
BUF Buff - Oak Pattern	MIN Mineral - Oak Pattern
CND Cinder - Oak Pattern	RYE Rye - Oak Pattern
COF Coffee	SAB Sable - Oak Pattern
EGR Egret - Oak Pattern	SAD Saddle - Oak Pattern
FAW Fawn	STU Studio Teak
GRH Graphite	VAL Valley

Laminate

TFL - HPL Wood Grain Pattern Laminates

ALL Ale Light	MIN Mineral
BOL Bourbon Light	OAT Oatmeal Cookie
BZW Brazilwood	PIN Pinnacle Walnut
BGL Brighton Light	STU Studio Teak
CLL Collectors	UMB Umber
FAW Fawn	VAL Valley
FLO Florence Walnut	VIN Vintage
GRH Graphite	WEA Weathered Ash

TFL - HPL Solid Laminates

ALB Alabaster	DWH Designer White
BLK Black	SHD Shadow
BBL Bridal Blanco	SLG Slate Grey

Solid Surface

ARM Armadillo	PEB Pebble Pearl
BLP Black Pearl	PUR Pure White

Glass

MBB Black Back Painted Matte	WBP White Back Painted
------------------------------	------------------------

3. Leg Finish:

Wood Finish:

ALM Ale Medium	CGR Graphite Coordinate
CAL Ale Light Coordinate	HRV Harvest
BBM Bourbon Medium	CKC Khaki Coordinate
CBZ Brazilwood Coordinate	MINC Mineral Coordinate
BARC Barrel Coordinate	MCH Mocha
CBO Bourbon Light Coordinate	CPI Pinnacle Walnut Coordinate
CBG Brighton Light Coordinate	PRL Praline
BRM Brighton Medium	RAVC Raven Coordinate
BUT Butterscotch	SABC Sable Coordinate
CNDC Cinder Coordinate	SIE Sienna
CLA Classic	CST Studio Teak Coordinate
CLL Collectors	TRF Truffle
EGRC Egret Coordinate	UMB Umber
ESP Espresso	VALC Valley Coordinate
FAWC Fawn Coordinate	VEN Venetian
FLX Flax	CWE Weathered Ash Coordinate

Metal:

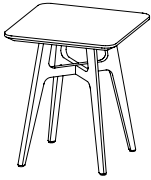
ABZ Aged Bronze	MBK Matte Black	SNK Soft Nickel
ASL Arctic Silver	PEW Pewter	CHR Chrome (upcharge applies)
GLD Gold	SBZ Soft Bronze	

Description	D	W	H	CTN WT	CU FT	① Model	HPL Laminate			
							Flat Cut List Price	Double Cut List Price	Solid Surface List Price	Glass List Price
Round Side Table - Wood Legs	18	18	19	20	5	AWV0018-19RDWL	\$1,350	\$1,375	\$1,671	\$1,752



- maple wood legs
- solid surface top available in JSI standard colors
- glass surface available in white back painted (WBP) or black back painted matte (MBB)

Square Side Table - Wood Legs	16	16	19	20	4	AWV1616-19SQWL	\$1,352	\$1,377	\$1,611	\$1,685
----------------------------------	----	----	----	----	---	----------------	---------	---------	---------	---------



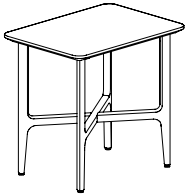
- maple wood legs
- solid surface top available in JSI standard colors
- glass surface available in white back painted (WBP) or black back painted matte (MBB)

Description	D	W	H	CTN WT	CU FT	① Model	HPL Laminate			
							Flat Cut List Price	Double Cut List Price	Solid Surface List Price	Glass List Price
Round End Table - Wood Legs	22	22	21	25	8	AWV0022-21RDWL	\$1,400	\$1,424	\$1,868	\$1,972



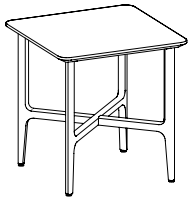
- maple wood legs
- solid surface top available in JSI standard colors
- glass surface available in white back painted (WBP) or black back painted matte (MBB)

Rectangular End Table - Wood Legs	22	16	21	25	6	AWV1622-21TTWL	\$1,408	\$1,432	\$1,753	\$1,840
--------------------------------------	----	----	----	----	---	----------------	---------	---------	---------	---------



- maple wood legs
- solid surface top available in JSI standard colors
- glass surface available in white back painted (WBP) or black back painted matte (MBB)

Square End Table - Wood Legs	20	20	21	26	6	AWV2020-21SQWL	\$1,446	\$1,507	\$1,840	\$1,917
---------------------------------	----	----	----	----	---	----------------	---------	---------	---------	---------



- maple wood legs
- solid surface top available in JSI standard colors
- glass surface available in white back painted (WBP) or black back painted matte (MBB)

To Order, Specify:

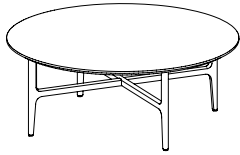
- ① Model Number
- ② Top Material
 - a.) Veneer
 - 1.) Wood Species - Cherry (CH1), Maple (MA1), Walnut (WA1), Black Oak (BO1) or Double Cut (DC1)
 - a.) Wood Finish
 - b.) Laminate
 - c.) Solid Surface
 - 1.) Armadillo (ARM), Black Pearl (BLP), Pebble Pearl (PEB) or Pure White (PUR)
 - d.) Glass
 - 1.) Black Back Painted Matte (MBB) or White Back Painted (WBP)
- ③ Leg Finish
 - a.) Wood Finish - [see Wood Leg Finish](#)

Note: when wood top is selected, leg finish defaults to match

Specifications

- Solid Maple hardwood table base with tenon and lap joint construction. Concealed metal X-brace for joint reinforcement.
- Nail in metal glides standard.

Description	D	W	H	CTN WT	CU FT	① Model	HPL Laminate	Double Cut	Solid Surface	Glass
							Flat Cut List Price	List Price	List Price	List Price
Round Coffee Table - Wood Legs	42	42	16	55	20	AWV0042-16RDWL	\$1,743	\$1,806	\$3,408	\$3,804
	36	36	16	44	15	AWV0036-16RDWL	\$1,667	\$1,703	\$2,887	\$3,249



- maple wood legs
- solid surface top available in JSI standard colors
- glass surface available in white back painted (WBP) or black back painted matte (MBB)

Rectangular Coffee Table - Wood Legs	24	48	16	50	14	AWV2448-16TTWL	\$1,717	\$1,755	\$2,815	\$2,815
---	----	----	----	----	----	----------------	---------	---------	---------	---------



- maple wood legs
- solid surface top available in JSI standard colors
- glass surface available in white back painted (WBP) or black back painted matte (MBB)

Square Coffee Table - Wood Legs	42	42	16	68	20	AWV4242-16SQWL	\$1,880	\$1,942	\$3,519	\$3,946
	36	36	16	54	15	AWV3636-16SQWL	\$1,765	\$1,808	\$2,997	\$3,255



- maple wood legs
- solid surface top available in JSI standard colors
- glass surface available in white back painted (WBP) or black back painted matte (MBB)

ARWYN

To Order, Specify:

- ① Model Number
- ② Top Material
 - a.) Veneer
 - 1.) Wood Species - Cherry (CH1), Maple (MA1), Walnut (WA1), Black Oak (BO1) or Double Cut (DC1)
 - a.) Wood Finish
 - b.) Laminate
 - c.) Solid Surface
 - 1.) Armadillo (ARM), Black Pearl (BLP), Pebble Pearl (PEB) or Pure White (PUR)
 - d.) Glass
 - 1.) Black Back Painted Matte (MBB) or White Back Painted (WBP)
- ③ Leg Finish
 - a.) Wood Finish - [see Wood Leg Finish](#)

Specifications

- Solid Maple hardwood table base with tenon and lap joint construction. Concealed metal X-brace for joint reinforcement.
- Nail in metal glides standard.

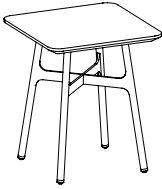
Note: when wood top is selected, leg finish defaults to match

Description	D	W	H	CTN WT	CU FT	① Model	HPL Laminate			
							Flat Cut List Price	Double Cut List Price	Solid Surface List Price	Glass List Price
Round Side Table - Metal Legs	18	18	19	20	5	AWV0018-19RDML	\$1,382	\$1,407	\$1,702	\$1,784



- metal legs available in JSI standard finishes, chrome (CHR) available; specify and add \$217 list
- solid surface top available in JSI standard colors
- glass surface available in white back painted (WBP) or black back painted matte (MBB)

Square Side Table - Metal Legs	16	16	19	21	4	AWV1616-19SQML	\$1,583	\$1,608	\$1,842	\$1,915
-----------------------------------	----	----	----	----	---	----------------	---------	---------	---------	---------



- metal legs available in JSI standard finishes, chrome (CHR) available; specify and add \$264 list
- solid surface top available in JSI standard colors
- glass surface available in white back painted (WBP) or black back painted matte (MBB)

To Order, Specify:

- ① Model Number
- ② Material
 - a.) Veneer
 - 1.) Wood Species - Cherry (CH1), Maple (MA1), Walnut (WA1), Black Oak (BO1) or Double Cut (DC1)
 - a.) Wood Finish
 - b.) Laminate
 - c.) Solid Surface
 - 1.) Armadillo (ARM), Black Pearl (BLP), Pebble Pearl (PEB) or Pure White (PUR)
 - d.) Glass
 - 1.) Black Back Painted Matte (MBB) or White Back Painted (WBP)
- ③ Metal Leg Option
 - a.) Metal Finish - [See Metal Leg Option](#)

Specifications

- Metal leg frame with 7/8" dia. legs with fabricated metal stretchers.
- Legs have metal foot with nylon glide and 1/2" adjustment range.

Description	D	W	H	CTN WT	CU FT	① Model	HPL Laminate			
							Flat Cut List Price	Double Cut List Price	Solid Surface List Price	Glass List Price
Round End Table - Metal Legs	22	22	21	18	8	AWV0022-21RDML	\$1,615	\$1,640	\$2,083	\$2,187



- metal legs available in JSI standard finishes, chrome (CHR) available; specify and add \$264 list
- solid surface top available in JSI standard colors
- glass surface available in white back painted (WBP) or black back painted matte (MBB)

Rectangular End Table - Metal Legs	22	26	21	18	9	AWV1622-21TTML	\$1,617	\$1,642	\$1,961	\$2,048
---------------------------------------	----	----	----	----	---	----------------	---------	---------	---------	---------



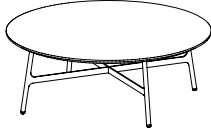
- metal legs available in JSI standard finishes, chrome (CHR) available; specify and add \$264 list
- solid surface top available in JSI standard colors
- glass surface available in white back painted (WBP) or black back painted matte (MBB)

Square End Table - Metal Legs	20	20	21	18	6	AWV2020-21SQML	\$1,588	\$1,650	\$1,983	\$2,060
----------------------------------	----	----	----	----	---	----------------	---------	---------	---------	---------



- metal legs available in JSI standard finishes, chrome (CHR) available; specify and add \$264 list
- solid surface top available in JSI standard colors
- glass surface available in white back painted (WBP) or black back painted matte (MBB)

Description	D	W	H	CTN WT	CU FT	① Model	HPL Laminate			
							Flat Cut List Price	Double Cut List Price	Solid Surface List Price	Glass List Price
Round Coffee Table - Metal Legs	42	42	16	29	20	AWV0042-16RDML	\$1,970	\$2,032	\$3,635	\$4,031
	36	36	16	26	15	AWV0036-16RDML	\$1,770	\$1,808	\$2,991	\$3,352



- metal legs available in JSI standard finishes, chrome (CHR) available; specify and add \$322 list
- solid surface top available in JSI standard colors
- glass surface available in white back painted (WBP) or black back painted matte (MBB)

Rectangular Coffee Table - Metal Legs	24	48	16	29	14	AWV2448-16TTML	\$1,895	\$1,933	\$2,992	\$2,992
--	----	----	----	----	----	----------------	---------	---------	---------	---------



- metal legs available in JSI standard finishes, chrome (CHR) available; specify and add \$322 list
- solid surface top available in JSI standard colors
- glass surface available in white back painted (WBP) or black back painted matte (MBB)

Square Coffee Table - Metal Legs	42	42	16	37	20	AWV4242-16SQML	\$1,978	\$2,039	\$3,618	\$4,572
	36	36	16	30	15	AWV3636-16SQML	\$1,913	\$1,956	\$3,145	\$3,503



- metal legs available in JSI standard finishes, chrome (CHR) available; specify and add \$322 list
- solid surface top available in JSI standard colors
- glass surface available in white back painted (WBP) or black back painted matte (MBB)

To Order, Specify:

- ① Model Number
- ② Material
 - a.) Veneer
 - 1.) Wood Species - Cherry (CH1), Maple (MA1), Walnut (WA1), Black Oak (BO1) or Double Cut (DC1)
 - a.) Wood Finish
 - b.) Laminate
 - c.) Solid Surface
 - 1.) Armadillo (ARM), Black Pearl (BLP), Pebble Pearl (PEB) or Pure White (PUR)
 - d.) Glass
 - 1.) Black Back Painted Matte (MBB) or White Back Painted (WBP)
- ③ Metal Leg Option
 - a.) Metal Finish - [See Metal Leg Option](#)

Specifications

- Metal leg frame with 7/8" dia. legs with fabricated metal stretchers.
- Legs have metal foot with nylon glide and 1/2" adjustment range.

Avalon Order Check List:



Specify:

- 1. Model Number
- 2. Wood Species - Beech (B)
- 3. Wood Seat Finish/Color
- 4. Metal Frame Color
- 5. Fabric Selection - vendor, pattern and color
- 6. Optional Clear Leg Protectors - add \$26 list per chair for set of 4

Example:

163C | B | HRV | MBK | MOMENTUM | VOX | MYSTIC
 (model #) | (wood species) | (finish) | (metal frame) | (fabric vendor) | (pattern name) | (pattern color)

1. Model Number

2. Wood Species - Beech (B)

3. Wood Seat Finish/Color Options:

ALM Ale Medium	HRV Harvest
CAL Ale Light Coordinate	CKC Khaki Coordinate
BBM Bourbon Medium	MINC Mineral Coordinate
CBZ Brazilwood Coordinate	MCH Mocha
BARC Barrel Coordinate	CPI Pinnacle Walnut Coordinate
CBO Bourbon Light Coordinate	PRL Praline
CBG Brighton Light Coordinate	RAVC Raven Coordinate
BRM Brighton Medium	SABC Sable Coordinate
BUT Butterscotch	SIE Sienna
CNDC Cinder Coordinate	CST Studio Teak Coordinate
CLA Classic	TRF Truffle
CLL Collectors	UMB Umber
EGRC Egret Coordinate	VALC Valley Coordinate
ESP Espresso	VEN Venetian
FAWC Fawn Coordinate	CWE Weathered Ash Coordinate
FLX Flax	
CGR Graphite Coordinate	

Color - Add \$45 list per item

BKD Backdrop	GRV Greek Villa
BFX Black Fox	GLF Gulf Stream
BWH Bright White	HTB Heartthrob
CGP Cargo Pants	NET Network Gray
CHT Chatroom	NWH Nonchalant White
DSY Daisy	PAR Paradise
DRG Daring	QXP Quixotic Plum
DYN Dynamo	RBZ Relic Bronze
ENG Enigma	SND Sandbank
FRR French Roast	STM Storm
GBY Georgian Bay	TRC Tricorn Black

4. Metal Frame Tier/Color:

Tier 1:
 MBK Matte Black

Tier 2: add \$150 list

ABZ Aged Bronze	PEW Pewter
ASL Arctic Silver	SBZ Soft Bronze
BWH Bright White	SNK Soft Nickel
GLD Gold	

Tier 3: add \$170 list

BRD Beige Red (RAL3012)	SAL Salmon Orange (RAL2012)
CAR Carmine Red (RAL3002)	SPB Sapphire Blue (RAL4007)
COP Copper Brown (RAL8004)	SGR Signal Green (RAL6032)
HYL Honey Yellow (RAL1005)	SIG Signal Orange (RAL2010)
LGR Leaf Green (RAL6002)	SGY Silk Grey (RAL7044)
MHB Mahogany Brown (RAL8016)	SKY Sky Blue (RAL5015)
MTQ Mint Turquoise (RAL6033)	TBL Traffic Blue (RAL5017)
OGR Olive Green (RAL6003)	TRD Traffic Red (RAL3020)
PPV Purple Violet (RAL4007)	TQP Turquoise Pastel (RAL6034)
QZG Quartz Grey (RAL7039)	ZYL Zinc Yellow (RAL1018)

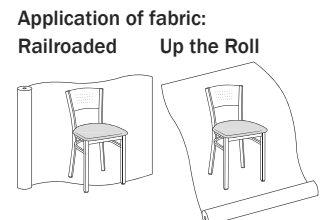
5. Fabric Selection - Please supply the following:
 Fabric vendor/ Pattern name/ Pattern color

[For a complete list of JSI Standard and Graded-In Textiles click here](#)

All COM orders must include the following:

- Vendor's name, pattern name and color
- Sample of the fabric attached to order
- Model numbers of items for fabric application
- Special application instructions (e.g., all stripes will be applied front to back unless specified otherwise)
- Customer and purchase order number

Ship prepaid COM material to:
 JSI
 Attn: COM Department
 201 East Martin Street
 Receiving B, Dock 71
 Orleans, IN 47452



All COM orders will ship at standard lead time from receipt of COM except for orders requiring special custom matched finishes.

Description

Model

Specifications

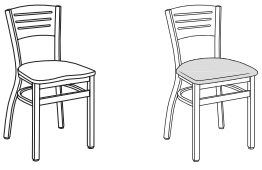
List Price Per Grade

Armless Stacker

162A Wood Seat
162C Uph. Seat
 · upholstered seat models not recommended for stacking
 · stacks five high

Dimensions	D	W	H
Overall	17	17	31 ½
Seat	15 ½	17	18 ½
Upholstery		Shipping	
COM Ydg	¾	Ctn Wt	21
COL Sq Ft	9	Cu Ft	9

Wood Seat	\$493
COM	\$507
A	\$527
B	\$546
COL/C	\$583
D	\$630
E	\$675
F	\$747
G	\$824
H	\$907
I	\$1,034
J	\$1,188
L1	\$839
L2	\$920



162A wood seat
162C uph. seat



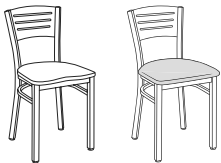
stacking frame

Armless

163A Wood Seat
163C Uph. Seat

Dimensions	D	W	H
Overall	17	17	31 ½
Seat	15 ½	17	18 ½
Upholstery		Shipping	
COM Ydg	¾	Ctn Wt	21
COL Sq Ft	9	Cu Ft	9

Wood Seat	\$493
COM	\$507
A	\$527
B	\$546
COL/C	\$583
D	\$630
E	\$675
F	\$747
G	\$824
H	\$907
I	\$1,034
J	\$1,188
L1	\$839
L2	\$920



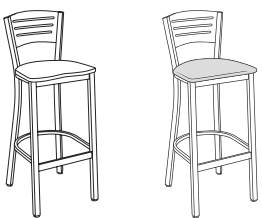
163A wood seat
163C uph. seat

Barstool

168A Wood Seat
168C Uph. Seat

Dimensions	D	W	H
Overall	16 ½	17	41 ½
Seat	15 ½	17	31
Upholstery		Shipping	
COM Ydg	¾	Ctn Wt	28
COL Sq Ft	9	Cu Ft	13

Wood Seat	\$573
COM	\$585
A	\$605
B	\$626
COL/C	\$662
D	\$708
E	\$756
F	\$825
G	\$905
H	\$986
I	\$1,113
J	\$1,268
L1	\$918
L2	\$1,000



168A wood seat
168C uph. seat

Description

44" h Swivel Barstool



169A
wood seat

169C
uph. seat

1 Model

- 169A Wood Seat**
169C Uph. Seat
 · 360° swivel
 · optional self-centering swivel plate - no upcharge, please specify when ordering

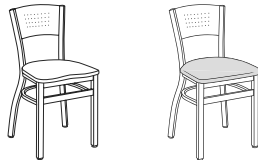
Specifications

Dimensions	D	W	H
Overall	20	18	44
Seat	15 1/2	17	31
Upholstery		Shipping	
COM Ydg	3/4	Ctn Wt	31
COL Sq Ft	9	Cu Ft	13

List Price Per Grade

Wood Seat	\$734
COM	\$743
A	\$763
B	\$785
COL/C	\$817
D	\$867
E	\$912
F	\$984
G	\$1,060
H	\$1,142
I	\$1,273
J	\$1,425
L1	\$1,075
L2	\$1,160

Armless Stacker



172A
wood seat

172C
uph. seat

- 172A Wood Seat**
172C Uph. Seat
 · upholstered seat models not recommended for stacking
 · stacks five high

Dimensions	D	W	H
Overall	17	17	31 1/2
Seat	15 1/2	17	18 1/2
Upholstery		Shipping	
COM Ydg	3/4	Ctn Wt	21
COL Sq Ft	9	Cu Ft	9

Wood Seat	\$493
COM	\$507
A	\$527
B	\$546
COL/C	\$583
D	\$630
E	\$675
F	\$747
G	\$824
H	\$907
I	\$1,034
J	\$1,188
L1	\$839
L2	\$920





stacking
frame



To Order, Specify:



- 1 Model Number
- 2 Wood Species - Beech (B)
- 3 Wood Seat Finish/Color [See Wood Seat Finish/Color Options](#)
- 4 Metal Frame Color [See Metal Frame Color Options](#)
- 5 Fabric Selection - vendor, pattern and color
 Visit www.jsifurniture.com/finishes-and-materials/textiles for our textiles program. See selection of standard and graded in manufacturers and patterns.
- 6 Optional Clear Leg Protectors - add \$26 list per chair for set of 4

Specifications

- Wood species - Beech.
- 18 gauge metal frame.
- Seat is upholstered with 1 1/2" polyurethane foam and synthetic sheet webbing for added comfort.
- Standard with 1 1/4" clear K-resin rocker glides.
- Legs 1 1/4" square tube.
- Stretcher rim and seat rim 3/4" square tube.

Description	Model	Specifications	List Price Per Grade
Armless  173A wood seat	173A Wood Seat 173C Uph. Seat	Dimensions	Wood Seat \$493 COM \$507 A \$527 B \$546 COL/C \$583 D \$630 E \$675 F \$747 G \$824 H \$907 I \$1,034 J \$1,188 L1 \$839 L2 \$920
		Overall	
 173C uph. seat		Seat	D 15 1/2 W 17 H 18 1/2
		Upholstery	Shipping
		COM Ydg 3/4	Ctn Wt 21
		COL Sq Ft 9	Cu Ft 9

Description	Model	Specifications	List Price Per Grade
41 1/2" h Barstool  178A wood seat	178A Wood Seat 178C Uph. Seat	Dimensions	Wood Seat \$573 COM \$585 A \$605 B \$626 COL/C \$662 D \$708 E \$756 F \$825 G \$905 H \$986 I \$1,113 J \$1,268 L1 \$918 L2 \$1,000
		Overall	
 178C uph. seat		Seat	D 15 1/2 W 17 H 31
		Upholstery	Shipping
		COM Ydg 3/4	Ctn Wt 28
		COL Sq Ft 9	Cu Ft 13

Description	Model	Specifications	List Price Per Grade
44" h Swivel Barstool  179A wood seat	179A Wood Seat 179C Uph. Seat · 360° swivel · optional self-centering swivel plate - no upcharge, please specify when ordering	Dimensions	Wood Seat \$734 COM \$743 A \$763 B \$785 COL/C \$817 D \$867 E \$912 F \$984 G \$1,060 H \$1,142 I \$1,273 J \$1,425 L1 \$1,075 L2 \$1,160
		Overall	
 179C uph. seat		Seat	D 15 1/2 W 17 H 31
		Upholstery	Shipping
		COM Ydg 3/4	Ctn Wt 31
		COL Sq Ft 9	Cu Ft 13

Description

Armless Stacker



182A
wood seat



182C
uph. seat



stacking
frame

Model

182A Wood Seat

182C Uph. Seat

- upholstered seat models not recommended for stacking
- stacks five high

Specifications

Dimensions	D	W	H
Overall	17	17	31 ½
Seat	15 ½	17	18 ½
Upholstery		Shipping	
COM Ydg	¾	Ctn Wt	21
COL Sq Ft	9	Cu Ft	9

List Price Per Grade

Wood Seat	\$493
COM	\$507
A	\$527
B	\$546
COL/C	\$583
D	\$630
E	\$675
F	\$747
G	\$824
H	\$907
I	\$1,034
J	\$1,188
L1	\$839
L2	\$920

Armless



183A
wood seat



183C
uph. seat

183A Wood Seat

183C Uph. Seat

Dimensions	D	W	H
Overall	17	17	31 ½
Seat	15 ½	17	18 ½
Upholstery		Shipping	
COM Ydg	¾	Ctn Wt	21
COL Sq Ft	9	Cu Ft	9

Wood Seat	\$493
COM	\$507
A	\$527
B	\$546
COL/C	\$583
D	\$630
E	\$675
F	\$747
G	\$824
H	\$907
I	\$1,034
J	\$1,188
L1	\$839
L2	\$920

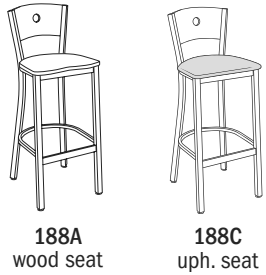
To Order, Specify:

- 1 Model Number
- 2 Wood Species - Beech (B)
- 3 Wood Seat Finish/Color [See Wood Seat Finish/Color Options](#)
- 4 Metal Frame Color [See Metal Frame Color Options](#)
- 5 Fabric Selection - vendor, pattern and color
Visit www.jsifurniture.com/finishes-and-materials/textiles for our textiles program. See selection of standard and graded in manufacturers and patterns.
- 6 Optional Clear Leg Protectors - add \$26 list per chair for set of 4

Specifications

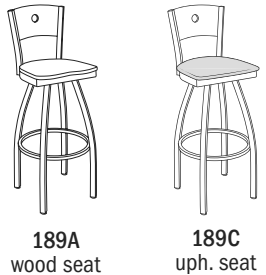
- Wood species - Beech.
- 18 gauge metal frame.
- Seat is upholstered with 1 ½" polyurethane foam and synthetic sheet webbing for added comfort.
- Standard with 1 ¼" clear K-resin rocker glides.
- Legs 1 ¼" square tube.
- Stretcher rim and seat rim ¾" square tube.

Description	Model	Specifications	List Price Per Grade																								
41½" h Barstool	188A Wood Seat 188C Uph. Seat	<table border="1"> <thead> <tr> <th>Dimensions</th> <th>D</th> <th>W</th> <th>H</th> </tr> </thead> <tbody> <tr> <td>Overall</td> <td>16½</td> <td>17</td> <td>41½</td> </tr> <tr> <td>Seat</td> <td>15½</td> <td>17</td> <td>31</td> </tr> <tr> <th colspan="2">Upholstery</th> <th colspan="2">Shipping</th> </tr> <tr> <td>COM Ydg</td> <td>¾</td> <td>Ctn Wt</td> <td>28</td> </tr> <tr> <td>COL Sq Ft</td> <td>9</td> <td>Cu Ft</td> <td>13</td> </tr> </tbody> </table>	Dimensions	D	W	H	Overall	16½	17	41½	Seat	15½	17	31	Upholstery		Shipping		COM Ydg	¾	Ctn Wt	28	COL Sq Ft	9	Cu Ft	13	Wood Seat \$573 COM \$585 A \$605 B \$626 COL/C \$662 D \$708 E \$756 F \$825 G \$905 H \$986 I \$1,113 J \$1,268 L1 \$918 L2 \$1,000
Dimensions	D	W	H																								
Overall	16½	17	41½																								
Seat	15½	17	31																								
Upholstery		Shipping																									
COM Ydg	¾	Ctn Wt	28																								
COL Sq Ft	9	Cu Ft	13																								



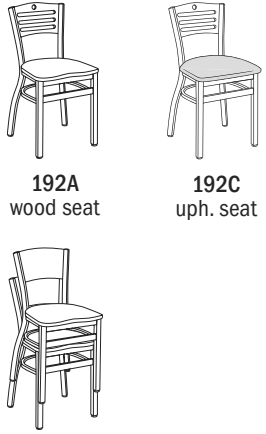
188A wood seat
188C uph. seat

Description	Model	Specifications	List Price Per Grade																								
44" h Swivel Barstool	189A Wood Seat 189C Uph. Seat	<ul style="list-style-type: none"> · 360° swivel · optional self-centering swivel plate - no upcharge, please specify when ordering <table border="1"> <thead> <tr> <th>Dimensions</th> <th>D</th> <th>W</th> <th>H</th> </tr> </thead> <tbody> <tr> <td>Overall</td> <td>20</td> <td>18</td> <td>44</td> </tr> <tr> <td>Seat</td> <td>15½</td> <td>17</td> <td>31</td> </tr> <tr> <th colspan="2">Upholstery</th> <th colspan="2">Shipping</th> </tr> <tr> <td>COM Ydg</td> <td>¾</td> <td>Ctn Wt</td> <td>31</td> </tr> <tr> <td>COL Sq Ft</td> <td>9</td> <td>Cu Ft</td> <td>13</td> </tr> </tbody> </table>	Dimensions	D	W	H	Overall	20	18	44	Seat	15½	17	31	Upholstery		Shipping		COM Ydg	¾	Ctn Wt	31	COL Sq Ft	9	Cu Ft	13	Wood Seat \$734 COM \$743 A \$763 B \$785 COL/C \$817 D \$867 E \$912 F \$984 G \$1,060 H \$1,142 I \$1,273 J \$1,425 L1 \$1,075 L2 \$1,160
Dimensions	D	W	H																								
Overall	20	18	44																								
Seat	15½	17	31																								
Upholstery		Shipping																									
COM Ydg	¾	Ctn Wt	31																								
COL Sq Ft	9	Cu Ft	13																								



189A wood seat
189C uph. seat

Description	Model	Specifications	List Price Per Grade																								
Armless Stacker	192A Wood Seat 192C Uph. Seat	<ul style="list-style-type: none"> · upholstered seat models not recommended for stacking · stacks five high <table border="1"> <thead> <tr> <th>Dimensions</th> <th>D</th> <th>W</th> <th>H</th> </tr> </thead> <tbody> <tr> <td>Overall</td> <td>17</td> <td>17</td> <td>31½</td> </tr> <tr> <td>Seat</td> <td>15½</td> <td>17</td> <td>18½</td> </tr> <tr> <th colspan="2">Upholstery</th> <th colspan="2">Shipping</th> </tr> <tr> <td>COM Ydg</td> <td>¾</td> <td>Ctn Wt</td> <td>21</td> </tr> <tr> <td>COL Sq Ft</td> <td>9</td> <td>Cu Ft</td> <td>9</td> </tr> </tbody> </table>	Dimensions	D	W	H	Overall	17	17	31½	Seat	15½	17	18½	Upholstery		Shipping		COM Ydg	¾	Ctn Wt	21	COL Sq Ft	9	Cu Ft	9	Wood Seat \$493 COM \$507 A \$527 B \$546 COL/C \$583 D \$630 E \$675 F \$747 G \$824 H \$907 I \$1,034 J \$1,188 L1 \$839 L2 \$920
Dimensions	D	W	H																								
Overall	17	17	31½																								
Seat	15½	17	18½																								
Upholstery		Shipping																									
COM Ydg	¾	Ctn Wt	21																								
COL Sq Ft	9	Cu Ft	9																								



192A wood seat
192C uph. seat

stacking frame

Description

1 Model

Specifications

List Price Per Grade

Armless



193A
wood seat



193C
uph. seat

193A Wood Seat
193C Uph. Seat

Dimensions	D	W	H
Overall	17	17	31 1/2
Seat	15 1/2	17	18 1/2
Upholstery		Shipping	
COM Ydg	3/4	Ctn Wt	21
COL Sq Ft	9	Cu Ft	9

Wood Seat	\$493
COM	\$507
A	\$527
B	\$546
COL/C	\$583
D	\$630
E	\$675
F	\$747
G	\$824
H	\$907
I	\$1,034
J	\$1,188
L1	\$839
L2	\$920

41 1/2" h Barstool



198A
wood seat



198C
uph. seat

198A Wood Seat
198C Uph. Seat

Dimensions	D	W	H
Overall	16 1/2	17	41 1/2
Seat	15 1/2	17	31
Upholstery		Shipping	
COM Ydg	3/4	Ctn Wt	28
COL Sq Ft	9	Cu Ft	13


Wood Seat	\$573
COM	\$585
A	\$605
B	\$626
COL/C	\$662
D	\$708
E	\$756
F	\$825
G	\$905
H	\$986
I	\$1,113
J	\$1,268
L1	\$918
L2	\$1,000


To Order, Specify:


- 1 Model Number
- 2 Wood Species - Beech (B)
- 3 Wood Seat Finish/Color [See Wood Seat Finish/Color Options](#)
- 4 Metal Frame Color [See Metal Frame Color Options](#)
- 5 Fabric Selection - vendor, pattern and color
Visit www.jsifurniture.com/finishes-and-materials/textiles for our textiles program. See selection of standard and graded in manufacturers and patterns.
- 6 Optional Clear Leg Protectors - add \$26 list per chair for set of 4


Specifications

- Wood species - Beech.
- 18 gauge metal frame.
- Seat is upholstered with 1 1/2" polyurethane foam and synthetic sheet webbing for added comfort.
- Standard with 1 1/4" clear K-resin rocker glides.
- Legs 1 1/4" square tube.
- Stretcher rim and seat rim 3/4" square tube.

Description	Model	Specifications	List Price Per Grade												
44" h Swivel Barstool  199A wood seat	199A Wood Seat 199C Uph. Seat · 360° swivel · optional self-centering swivel plate - no upcharge, please specify when ordering	<table border="1"> <thead> <tr> <th>Dimensions</th> <th>D</th> <th>W</th> <th>H</th> </tr> </thead> <tbody> <tr> <td>Overall</td> <td>20</td> <td>18</td> <td>44</td> </tr> <tr> <td>Seat</td> <td>15 ½</td> <td>17</td> <td>31</td> </tr> </tbody> </table>	Dimensions	D	W	H	Overall	20	18	44	Seat	15 ½	17	31	Wood Seat \$734 COM \$743 A \$763 B \$785 COL/C \$817 D \$867 E \$912 F \$984 G \$1,060 H \$1,142 I \$1,273 J \$1,425 L1 \$1,075 L2 \$1,160
		Dimensions	D	W	H										
Overall	20	18	44												
Seat	15 ½	17	31												
<table border="1"> <thead> <tr> <th>Upholstery</th> <th colspan="3">Shipping</th> </tr> </thead> <tbody> <tr> <td>COM Ydg</td> <td>¾</td> <td>Ctn Wt</td> <td>31</td> </tr> <tr> <td>COL Sq Ft</td> <td>9</td> <td>Cu Ft</td> <td>13</td> </tr> </tbody> </table>	Upholstery	Shipping			COM Ydg	¾	Ctn Wt	31	COL Sq Ft	9	Cu Ft	13			
Upholstery	Shipping														
COM Ydg	¾	Ctn Wt	31												
COL Sq Ft	9	Cu Ft	13												

Armless Stacker  202A wood seat	202A Wood Seat 202B Uph. Back · optional laser engraved back, specify location and size - see page VIII for details. (A model only) · upholstered seat models not recommended for stacking · stacks five high	<table border="1"> <thead> <tr> <th>Dimensions</th> <th>D</th> <th>W</th> <th>H</th> </tr> </thead> <tbody> <tr> <td>Overall</td> <td>17</td> <td>17</td> <td>31 ½</td> </tr> <tr> <td>Seat</td> <td>15 ½</td> <td>17</td> <td>18 ½</td> </tr> </tbody> </table>	Dimensions	D	W	H	Overall	17	17	31 ½	Seat	15 ½	17	18 ½	Wood Seat \$481 COM \$527 A \$541 B \$557 COL/C \$581 D \$609 E \$641 F \$690 G \$739 H \$794 I \$880 J \$984 L1 \$749 L2 \$807
		Dimensions	D	W	H										
Overall	17	17	31 ½												
Seat	15 ½	17	18 ½												
<table border="1"> <thead> <tr> <th>Upholstery</th> <th colspan="3">Shipping</th> </tr> </thead> <tbody> <tr> <td>COM Ydg</td> <td>¾</td> <td>Ctn Wt</td> <td>21</td> </tr> <tr> <td>COL Sq Ft</td> <td>9</td> <td>Cu Ft</td> <td>9</td> </tr> </tbody> </table>	Upholstery	Shipping			COM Ydg	¾	Ctn Wt	21	COL Sq Ft	9	Cu Ft	9			
Upholstery	Shipping														
COM Ydg	¾	Ctn Wt	21												
COL Sq Ft	9	Cu Ft	9												

Armless Stacker 	202C Uph. Seat · optional laser engraved back, specify location and size - see page VIII for details. · upholstered seat models not recommended for stacking · stacks five high	<table border="1"> <thead> <tr> <th>Dimensions</th> <th>D</th> <th>W</th> <th>H</th> </tr> </thead> <tbody> <tr> <td>Overall</td> <td>17</td> <td>17</td> <td>31 ½</td> </tr> <tr> <td>Seat</td> <td>15 ½</td> <td>17</td> <td>18 ½</td> </tr> </tbody> </table>	Dimensions	D	W	H	Overall	17	17	31 ½	Seat	15 ½	17	18 ½	COM \$494 A \$513 B \$532 COL/C \$570 D \$615 E \$662 F \$734 G \$811 H \$894 I \$1,020 J \$1,174 L1 \$825 L2 \$908
		Dimensions	D	W	H										
Overall	17	17	31 ½												
Seat	15 ½	17	18 ½												
<table border="1"> <thead> <tr> <th>Upholstery</th> <th colspan="3">Shipping</th> </tr> </thead> <tbody> <tr> <td>COM Ydg</td> <td>¾</td> <td>Ctn Wt</td> <td>21</td> </tr> <tr> <td>COL Sq Ft</td> <td>9</td> <td>Cu Ft</td> <td>9</td> </tr> </tbody> </table>	Upholstery	Shipping			COM Ydg	¾	Ctn Wt	21	COL Sq Ft	9	Cu Ft	9			
Upholstery	Shipping														
COM Ydg	¾	Ctn Wt	21												
COL Sq Ft	9	Cu Ft	9												

Armless Stacker 	202D Uph. Seat/Back · when using contrasting upholstery, indicate application and use higher grade pricing · upholstered seat models not recommended for stacking · stacks five high	<table border="1"> <thead> <tr> <th>Dimensions</th> <th>D</th> <th>W</th> <th>H</th> </tr> </thead> <tbody> <tr> <td>Overall</td> <td>17</td> <td>17</td> <td>31 ½</td> </tr> <tr> <td>Seat</td> <td>15 ½</td> <td>17</td> <td>18 ½</td> </tr> </tbody> </table>	Dimensions	D	W	H	Overall	17	17	31 ½	Seat	15 ½	17	18 ½	COM \$606 A \$632 B \$658 COL/C \$704 D \$766 E \$828 F \$922 G \$1,025 H \$1,137 I \$1,308 J \$1,512 L1 \$1,047 L2 \$1,158
		Dimensions	D	W	H										
Overall	17	17	31 ½												
Seat	15 ½	17	18 ½												
<table border="1"> <thead> <tr> <th>Upholstery</th> <th colspan="3">Shipping</th> </tr> </thead> <tbody> <tr> <td>COM Ydg</td> <td>¾</td> <td>Ctn Wt</td> <td>21</td> </tr> <tr> <td>COL Sq Ft</td> <td>9</td> <td>Cu Ft</td> <td>9</td> </tr> </tbody> </table>	Upholstery	Shipping			COM Ydg	¾	Ctn Wt	21	COL Sq Ft	9	Cu Ft	9			
Upholstery	Shipping														
COM Ydg	¾	Ctn Wt	21												
COL Sq Ft	9	Cu Ft	9												

Description

Armless



203A
wood seat



203B
uph. back

1 Model

203A Wood Seat
203B Uph. Back

· optional laser engraved back, specify location and size - see page VIII for details. (A model only)

Specifications

Dimensions	D	W	H
Overall	17	17	31 1/2
Seat	15 1/2	17	18 1/2
Upholstery		Shipping	
COM Ydg	3/4	Ctn Wt	21
COL Sq Ft	9	Cu Ft	9

List Price Per Grade

Wood Seat	\$481
COM	\$527
A	\$541
B	\$557
COL/C	\$581
D	\$609
E	\$641
F	\$690
G	\$739
H	\$794
I	\$880
J	\$984
L1	\$749
L2	\$807

Armless



203C Uph. Seat

· optional laser engraved back, specify location and size - see page VIII for details.

Dimensions	D	W	H
Overall	17	17	31 1/2
Seat	15 1/2	17	18 1/2
Upholstery		Shipping	
COM Ydg	3/4	Ctn Wt	21
COL Sq Ft	9	Cu Ft	9






COM	\$494
A	\$513
B	\$532
COL/C	\$570
D	\$615
E	\$662
F	\$734
G	\$811
H	\$894
I	\$1,020
J	\$1,174
L1	\$825
L2	\$908

To Order, Specify:

- 1 Model Number
- 2 Wood Species - Beech (B)
- 3 Wood Seat Finish/Color [See Wood Seat Finish/Color Options](#)
- 4 Metal Frame Color [See Metal Frame Color Options](#)
- 5 Fabric Selection - vendor, pattern and color
Visit www.jsifurniture.com/finishes-and-materials/textiles for our textiles program. See selection of standard and graded in manufacturers and patterns.
- 6 Optional Clear Leg Protectors - add \$26 list per chair for set of 4

Specifications

- Wood species - Beech.
- 18 gauge metal frame.
- Seat is upholstered with 1 1/2" polyurethane foam and synthetic sheet webbing for added comfort.
- Standard with 1 1/4" clear K-resin rocker glides.
- Legs 1 1/4" square tube.
- Stretcher rim and seat rim 3/4" square tube.

Description	Model	Specifications	List Price Per Grade												
Armless 	203D Uph. Seat/Back	<table border="1"> <thead> <tr> <th>Dimensions</th> <th>D</th> <th>W</th> <th>H</th> </tr> </thead> <tbody> <tr> <td>Overall</td> <td>17</td> <td>17</td> <td>31 1/2</td> </tr> <tr> <td>Seat</td> <td>15 1/2</td> <td>17</td> <td>18 1/2</td> </tr> </tbody> </table>	Dimensions	D	W	H	Overall	17	17	31 1/2	Seat	15 1/2	17	18 1/2	COM \$606 A \$632 B \$658 COL/C \$704 D \$766 E \$828 F \$922 G \$1,025 H \$1,137 I \$1,308 J \$1,512 L1 \$1,047 L2 \$1,158
		Dimensions	D	W	H										
Overall	17	17	31 1/2												
Seat	15 1/2	17	18 1/2												
<table border="1"> <thead> <tr> <th>Upholstery</th> <th colspan="3">Shipping</th> </tr> </thead> <tbody> <tr> <td>COM Ydg</td> <td>3/4</td> <td>Ctn Wt</td> <td>21</td> </tr> <tr> <td>COL Sq Ft</td> <td>9</td> <td>Cu Ft</td> <td>9</td> </tr> </tbody> </table>	Upholstery	Shipping			COM Ydg	3/4	Ctn Wt	21	COL Sq Ft	9	Cu Ft	9			
Upholstery	Shipping														
COM Ydg	3/4	Ctn Wt	21												
COL Sq Ft	9	Cu Ft	9												
41 1/2" h Barstool  	208A Wood Seat 208B Uph. Back · optional laser engraved back, specify location and size - see page VIII for details. (A model only)	<table border="1"> <thead> <tr> <th>Dimensions</th> <th>D</th> <th>W</th> <th>H</th> </tr> </thead> <tbody> <tr> <td>Overall</td> <td>16 1/2</td> <td>17</td> <td>41 1/2</td> </tr> <tr> <td>Seat</td> <td>15 1/2</td> <td>17</td> <td>31</td> </tr> </tbody> </table>	Dimensions	D	W	H	Overall	16 1/2	17	41 1/2	Seat	15 1/2	17	31	Wood Seat \$560 COM \$606 A \$620 B \$638 COL/C \$661 D \$691 E \$722 F \$768 G \$819 H \$874 I \$962 J \$1,062 L1 \$831 L2 \$884
Dimensions	D	W	H												
Overall	16 1/2	17	41 1/2												
Seat	15 1/2	17	31												
41 1/2" h Barstool 	208C Uph. Seat · optional laser engraved back, specify location and size - see page VIII for details.	<table border="1"> <thead> <tr> <th>Dimensions</th> <th>D</th> <th>W</th> <th>H</th> </tr> </thead> <tbody> <tr> <td>Overall</td> <td>16 1/2</td> <td>17</td> <td>41 1/2</td> </tr> <tr> <td>Seat</td> <td>15 1/2</td> <td>17</td> <td>31</td> </tr> </tbody> </table>	Dimensions	D	W	H	Overall	16 1/2	17	41 1/2	Seat	15 1/2	17	31	COM \$573 A \$593 B \$613 COL/C \$649 D \$696 E \$743 F \$813 G \$893 H \$971 I \$1,103 J \$1,256 L1 \$907 L2 \$989
Dimensions	D	W	H												
Overall	16 1/2	17	41 1/2												
Seat	15 1/2	17	31												
41 1/2" h Barstool 	208D Uph. Seat/Back	<table border="1"> <thead> <tr> <th>Dimensions</th> <th>D</th> <th>W</th> <th>H</th> </tr> </thead> <tbody> <tr> <td>Overall</td> <td>16 1/2</td> <td>17</td> <td>41 1/2</td> </tr> <tr> <td>Seat</td> <td>15 1/2</td> <td>17</td> <td>31</td> </tr> </tbody> </table>	Dimensions	D	W	H	Overall	16 1/2	17	41 1/2	Seat	15 1/2	17	31	COM \$685 A \$709 B \$735 COL/C \$785 D \$847 E \$908 F \$1,003 G \$1,106 H \$1,215 I \$1,384 J \$1,589 L1 \$1,127 L2 \$1,234
Dimensions	D	W	H												
Overall	16 1/2	17	41 1/2												
Seat	15 1/2	17	31												

Description

44" h Swivel Barstool



209A
wood seat



209B
uph. back

1 Model

209A Wood Seat
209B Uph. Back

- optional laser engraved back, specify location and size - see page VIII for details. (A model only)
- 360° swivel
- optional self-centering swivel plate - no upcharge, please specify when ordering

Specifications

Dimensions	D	W	H
Overall	20	18	44
Seat	15 1/2	17	31
Upholstery		Shipping	
COM Ydg	3/4	Ctn Wt	31
COL Sq Ft	9	Cu Ft	13

List Price Per Grade

Wood Seat	\$722
COM	\$762
A	\$782
B	\$793
COL/C	\$816
D	\$849
E	\$878
F	\$928
G	\$980
H	\$1,034
I	\$1,118
J	\$1,223
L1	\$991
L2	\$1,045

44" h Swivel Barstool



209C Uph. Seat

- optional laser engraved back, specify location and size - see page VIII for details.
- 360° swivel
- optional self-centering swivel plate - no upcharge, please specify when ordering

Dimensions	D	W	H
Overall	20	18	44
Seat	15 1/2	17	31
Upholstery		Shipping	
COM Ydg	3/4	Ctn Wt	31
COL Sq Ft	9	Cu Ft	13

COM	\$728
A	\$753
B	\$771
COL/C	\$808
D	\$854
E	\$900
F	\$970
G	\$1,048
H	\$1,132
I	\$1,258
J	\$1,414
L1	\$1,066
L2	\$1,147

To Order, Specify:

- 1 Model Number
- 2 Wood Species - Beech (B)
- 3 Wood Seat Finish/Color [See Wood Seat Finish/Color Options](#)
- 4 Metal Frame Color [See Metal Frame Color Options](#)
- 5 Fabric Selection - vendor, pattern and color
Visit www.jsifurniture.com/finishes-and-materials/textiles for our textiles program. See selection of standard and graded in manufacturers and patterns.
- 6 Optional Clear Leg Protectors - add \$26 list per chair for set of 4

Specifications

- Wood species - Beech.
- 18 gauge metal frame.
- Seat is upholstered with 1 1/2" polyurethane foam and synthetic sheet webbing for added comfort.
- Standard with 1 1/4" clear K-resin rocker glides.
- Legs 1 1/4" square tube.
- Stretcher rim and seat rim 3/4" square tube.

Description

44" h Swivel Barstool



1 Model

209D Uph. Seat/Back

- 360° swivel
- optional self-centering swivel plate - no upcharge, please specify when ordering

Specifications

Dimensions	D	W	H
Overall	20	18	44
Seat	15 ½	17	31
Upholstery		Shipping	
COM Ydg	¾	Ctn Wt	31
COL Sq Ft	9	Cu Ft	13

List Price Per Grade

- COM \$839
- A \$867
- B \$895
- COL/C \$943
- D \$1,003
- E \$1,066
- F \$1,161
- G \$1,263
- H \$1,373
- I \$1,543
- J \$1,749
- L1 \$1,283
- L2 \$1,393

AVALON

To Order, Specify:

- 1 Model Number
- 2 Wood Species - Beech (B)
- 3 Wood Seat Finish/Color [See Wood Seat Finish/Color Options](#)
- 4 Metal Frame Color [See Metal Frame Color Options](#)
- 5 Fabric Selection - vendor, pattern and color
Visit www.jsifurniture.com/finishes-and-materials/textiles for our textiles program. See selection of standard and graded in manufacturers and patterns.
- 6 Optional Clear Leg Protectors - add \$26 list per chair for set of 4

Specifications

- Wood species - Beech.
- 18 gauge metal frame.
- Seat is upholstered with 1 ½" polyurethane foam and synthetic sheet webbing for added comfort.
- Standard with 1 ¼" clear K-resin rocker glides.
- Legs 1 ¼" square tube.
- Stretcher rim and seat rim ¾" square tube.

Avini Lounge Order Check List:



Specify:

- 1. Model Number
- 2. Wood Species - Maple (M)
- 3. Wood Finish/Color
- 4. Fabric Selection - vendor, pattern and color
- 5. Optional Rubber Cushion Nylon Glides - no upcharge

Example:

AV1021W | **M** | **HRV** | **MOMENTUM** | **VOX** | **MYSTIC**
 (model #) | (wood species) | (finish) | (fabric vendor) | (pattern name) | (pattern color)

1. Model Number

2. Wood Species - Maple (M)

3. Wood Seat Finish/Color Options:

ALM Ale Medium	HRV Harvest
CAL Ale Light Coordinate	CKC Khaki Coordinate
BBM Bourbon Medium	MINC Mineral Coordinate
CBZ Brazilwood Coordinate	MCH Mocha
BARC Barrel Coordinate	CPI Pinnacle Walnut Coordinate
CBO Bourbon Light Coordinate	PRL Praline
CBG Brighton Light Coordinate	RAVC Raven Coordinate
BRM Brighton Medium	SABC Sable Coordinate
BUT Butterscotch	SIE Sienna
CNDC Cinder Coordinate	CST Studio Teak Coordinate
CLA Classic	TRF Truffle
CLL Collectors	UMB Umber
EGRC Egret Coordinate	VALC Valley Coordinate
ESP Espresso	VEN Venetian
FAWC Fawn Coordinate	CWE Weathered Ash Coordinate
FLX Flax	
CGR Graphite Coordinate	
Color - Add \$45 list per item	
BKD Backdrop	GRV Greek Villa
BFX Black Fox	GLF Gulf Stream
BWH Bright White	HTB Heartthrob
CGP Cargo Pants	NET Network Gray
CHT Chatroom	NWH Nonchalant White
DSY Daisy	PAR Paradise
DRG Daring	QXP Quixotic Plum
DYN Dynamo	RBZ Relic Bronze
ENG Enigma	SND Sandbank
FRR French Roast	STM Storm
GBY Georgian Bay	TRC Tricorn Black

4. Fabric Selection - Please supply the following:
 Fabric vendor/ Pattern name/ Pattern color

For a complete list of JSI Standard and Graded-In Textiles click [here](#)

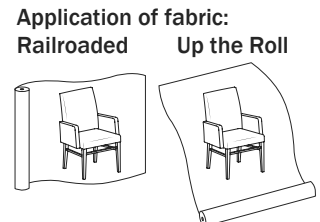
When specifying contrasting upholstery, indicate clearly which upholstery is to be applied to the seat, back and arms. Use higher grade pricing.

- Indicate direction of fabric - Railroaded or Up the Roll
- Please provide illustration, if available





All COM orders must include the following:


- Vendor's name, pattern name and color
- Sample of the fabric attached to order
- Model numbers of items for fabric application
- Special application instructions (e.g., all stripes will be applied front to back unless specified otherwise)
- Customer and purchase order number


Ship prepaid COM material to:
 JSI
 Attn: COM Department
 201 East Martin Street
 Receiving B, Dock 71
 Orleans, IN 47452



All COM orders will ship at standard lead time from receipt of COM except for orders requiring special custom matched finishes.

Description	Model	Specifications	List Price Per Grade																
Armless 	AV1023D · upholstered seat and back	<table border="1"> <thead> <tr> <th>Dimensions</th> <th>D</th> <th>W</th> <th>H</th> </tr> </thead> <tbody> <tr> <td>Overall</td> <td>23 ½</td> <td>21 ½</td> <td>37</td> </tr> <tr> <td>Seat</td> <td>18</td> <td>21 ½</td> <td>18 ½</td> </tr> </tbody> </table>	Dimensions	D	W	H	Overall	23 ½	21 ½	37	Seat	18	21 ½	18 ½	COM \$1,140 A \$1,184 B \$1,241 COL/C \$1,342 D \$1,469 E \$1,597 F \$1,797 G \$2,009 H \$2,239 I \$2,592 J \$3,018 L1 \$2,053 L2 \$2,278				
		Dimensions	D	W	H														
Overall	23 ½	21 ½	37																
Seat	18	21 ½	18 ½																
<table border="1"> <thead> <tr> <th>Upholstery</th> <th colspan="3">Shipping</th> </tr> </thead> <tbody> <tr> <td>COM Ydg</td> <td>2</td> <td>Ctn Wt</td> <td>22</td> </tr> <tr> <td>COL Sq Ft</td> <td>40</td> <td>Cu Ft</td> <td>14</td> </tr> </tbody> </table>	Upholstery	Shipping			COM Ydg	2	Ctn Wt	22	COL Sq Ft	40	Cu Ft	14							
Upholstery	Shipping																		
COM Ydg	2	Ctn Wt	22																
COL Sq Ft	40	Cu Ft	14																
Armless 	AV1023E · upholstered seat and back · solid maple crown	<table border="1"> <thead> <tr> <th>Dimensions</th> <th>D</th> <th>W</th> <th>H</th> </tr> </thead> <tbody> <tr> <td>Overall</td> <td>23 ½</td> <td>21 ½</td> <td>37</td> </tr> <tr> <td>Seat</td> <td>18</td> <td>21 ½</td> <td>18 ½</td> </tr> </tbody> </table>	Dimensions	D	W	H	Overall	23 ½	21 ½	37	Seat	18	21 ½	18 ½	COM \$1,240 A \$1,287 B \$1,345 COL/C \$1,444 D \$1,572 E \$1,703 F \$1,902 G \$2,113 H \$2,342 I \$2,694 J \$3,122 L1 \$2,157 L2 \$2,384				
		Dimensions	D	W	H														
Overall	23 ½	21 ½	37																
Seat	18	21 ½	18 ½																
<table border="1"> <thead> <tr> <th>Upholstery</th> <th colspan="3">Shipping</th> </tr> </thead> <tbody> <tr> <td>COM Ydg</td> <td>2</td> <td>Ctn Wt</td> <td>22</td> </tr> <tr> <td>COL Sq Ft</td> <td>40</td> <td>Cu Ft</td> <td>14</td> </tr> </tbody> </table>	Upholstery	Shipping			COM Ydg	2	Ctn Wt	22	COL Sq Ft	40	Cu Ft	14							
Upholstery	Shipping																		
COM Ydg	2	Ctn Wt	22																
COL Sq Ft	40	Cu Ft	14																
Wood Arm 	AV1021W · upholstered seat and back	<table border="1"> <thead> <tr> <th>Dimensions</th> <th>D</th> <th>W</th> <th>H</th> </tr> </thead> <tbody> <tr> <td>Overall</td> <td>23 ½</td> <td>23 ½</td> <td>37</td> </tr> <tr> <td>Seat</td> <td>18</td> <td>21 ½</td> <td>18 ½</td> </tr> <tr> <td>Arm</td> <td></td> <td></td> <td>26</td> </tr> </tbody> </table>	Dimensions	D	W	H	Overall	23 ½	23 ½	37	Seat	18	21 ½	18 ½	Arm			26	COM \$1,170 A \$1,217 B \$1,275 COL/C \$1,372 D \$1,500 E \$1,629 F \$1,827 G \$2,038 H \$2,268 I \$2,622 J \$3,048 L1 \$2,083 L2 \$2,311
		Dimensions	D	W	H														
Overall	23 ½	23 ½	37																
Seat	18	21 ½	18 ½																
Arm			26																
<table border="1"> <thead> <tr> <th>Upholstery</th> <th colspan="3">Shipping</th> </tr> </thead> <tbody> <tr> <td>COM Ydg</td> <td>2</td> <td>Ctn Wt</td> <td>23</td> </tr> <tr> <td>COL Sq Ft</td> <td>40</td> <td>Cu Ft</td> <td>14</td> </tr> </tbody> </table>	Upholstery	Shipping			COM Ydg	2	Ctn Wt	23	COL Sq Ft	40	Cu Ft	14							
Upholstery	Shipping																		
COM Ydg	2	Ctn Wt	23																
COL Sq Ft	40	Cu Ft	14																
Upholstered Arm 	AV1021U · upholstered seat, back and arms	<table border="1"> <thead> <tr> <th>Dimensions</th> <th>D</th> <th>W</th> <th>H</th> </tr> </thead> <tbody> <tr> <td>Overall</td> <td>23 ½</td> <td>24</td> <td>37</td> </tr> <tr> <td>Seat</td> <td>18</td> <td>21 ½</td> <td>18 ½</td> </tr> <tr> <td>Arm</td> <td></td> <td></td> <td>26</td> </tr> </tbody> </table>	Dimensions	D	W	H	Overall	23 ½	24	37	Seat	18	21 ½	18 ½	Arm			26	COM \$1,485 A \$1,549 B \$1,635 COL/C \$1,785 D \$1,975 E \$2,168 F \$2,467 G \$2,788 H \$3,127 I \$3,660 J \$4,298 L1 \$2,849 L2 \$3,192
		Dimensions	D	W	H														
Overall	23 ½	24	37																
Seat	18	21 ½	18 ½																
Arm			26																
<table border="1"> <thead> <tr> <th>Upholstery</th> <th colspan="3">Shipping</th> </tr> </thead> <tbody> <tr> <td>COM Ydg</td> <td>3</td> <td>Ctn Wt</td> <td>25</td> </tr> <tr> <td>COL Sq Ft</td> <td>60</td> <td>Cu Ft</td> <td>14</td> </tr> </tbody> </table>	Upholstery	Shipping			COM Ydg	3	Ctn Wt	25	COL Sq Ft	60	Cu Ft	14							
Upholstery	Shipping																		
COM Ydg	3	Ctn Wt	25																
COL Sq Ft	60	Cu Ft	14																

Description	① Model	Specifications				List Price Per Grade			
40" Counter Height Stool 	AV1024D · upholstered seat and back · stainless steel foot rest	Dimensions			D	W	H	COM	\$1,338
		Overall	22	17½				40	A
		Seat	16½	17½	24½		B	\$1,443	
		Upholstery		Shipping			COL/C	\$1,544	
		COM Ydg	2	Ctn Wt	25		D	\$1,670	
		COL Sq Ft	40	Cu Ft	11		E	\$1,799	
							F	\$1,996	
							G	\$2,211	
							H	\$2,438	
							I	\$2,794	
							J	\$3,220	
							L1	\$2,252	
							L2	\$2,481	

Description	① Model	Specifications				List Price Per Grade			
40" Counter Height Stool 	AV1024E · upholstered seat and back · solid maple crown · stainless steel foot rest	Dimensions			D	W	H	COM	\$1,439
		Overall	22	17½				40	A
		Seat	16½	17½	24½		B	\$1,547	
		Upholstery		Shipping			COL/C	\$1,647	
		COM Ydg	2	Ctn Wt	25		D	\$1,773	
		COL Sq Ft	40	Cu Ft	11		E	\$1,904	
							F	\$2,101	
							G	\$2,314	
							H	\$2,542	
							I	\$2,896	
							J	\$3,325	
							L1	\$2,358	
							L2	\$2,586	

To Order, Specify:

- ① Model Number
- ② Wood Species - Maple (M)
- ③ Wood Finish/Color [See Wood Finish/Color Options](#)
- ④ Fabric Selection - vendor, pattern and color
Visit www.jsifurniture.com/finishes-and-materials/textiles for our textiles program. See selection of standard and graded in manufacturers and patterns.
- ⑤ Optional Rubber Cushion Nylon Glides - no upcharge

Specifications

- Wood species - Maple.
- Seat is upholstered with 2½" high density polyurethane foam and synthetic sheet webbing for added comfort.
- Seat has single needle top stitch detail for added style and durability.
- Back is upholstered with 1" polyurethane foam.
- Arms are upholstered with polyurethane foam.
- Mortise and tenon construction with corner blocks, glue and screws.
- Standard with rubber cushion metal glides.

Description

1 Model

Specifications

List Price Per Grade

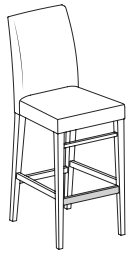
46" h Barstool

AV1028D

- upholstered seat and back
- stainless steel foot rest

Dimensions	D	W	H
Overall	22	17 ½	46
Seat	16 ½	17 ½	30 ½
Upholstery		Shipping	
COM Ydg	2	Ctn Wt	25
COL Sq Ft	40	Cu Ft	12

- COM \$1,338
- A \$1,387
- B \$1,443
- COL/C \$1,544
- D \$1,670
- E \$1,799
- F \$1,996
- G \$2,211
- H \$2,438
- I \$2,794
- J \$3,220
- L1 \$2,252
- L2 \$2,481



46" h Barstool

AV1028E

- upholstered seat and back
- solid maple crown
- stainless steel foot rest

Dimensions	D	W	H
Overall	22	17 ½	46
Seat	16 ½	17 ½	30 ½
Upholstery		Shipping	
COM Ydg	2	Ctn Wt	25
COL Sq Ft	40	Cu Ft	12

- COM \$1,439
- A \$1,489
- B \$1,547
- COL/C \$1,647
- D \$1,773
- E \$1,904
- F \$2,101
- G \$2,314
- H \$2,542
- I \$2,896
- J \$3,325
- L1 \$2,358
- L2 \$2,586



To Order, Specify:

- 1 Model Number
- 2 Wood Species - Maple (M)
- 3 Wood Finish/Color [See Wood Finish/Color Options](#)
- 4 Fabric Selection - vendor, pattern and color
Visit www.jsifurniture.com/finishes-and-materials/textiles for our textiles program. See selection of standard and graded in manufacturers and patterns.
- 5 Optional Rubber Cushion Nylon Glides - no upcharge

Specifications

- Wood species - Maple.
- Seat is upholstered with 2 ½" high density polyurethane foam and synthetic sheet webbing for added comfort.
- Seat has single needle top stitch detail for added style and durability.
- Back is upholstered with 1" polyurethane foam.
- Arms are upholstered with polyurethane foam.
- Mortise and tenon construction with corner blocks, glue and screws.
- Standard with rubber cushion metal glides.

BeSPACE Order Check List:



Specify:

- 1. Model Number
- 2. Wood Species - Rift Cut White Oak (WK4) or Flat Cut Walnut (WA1)
- 3. Finish Option - CLK (Clear on Rift Cut White Oak) or CLW (Clear on Flat Cut Walnut)
- 4. Door or Drawer Front Optional Paint Color (see below for paint color options); add \$45 list per item
- 5. Metal Leg Color - See Below
- 6. Fabric Selection
 - A. Seat - Vendor, Pattern and Color
 - B. Back - Vendor, Pattern and Color
 - C. Deck or Deck and Arm (s) - Vendor, Pattern and Color
- 7. Glass Color - Clear (GTC01) or Smoke (GTC04)
- 8. Optional Power Center - Flush Mount (EC22) - Black (B) or White (W); add \$583 list each
- 9. Optional Black Grommet; add \$105 list each

Example:

BS2 (model #)	WA1 (wood species)	CLW (finish)	SNK (metal leg color)	MOMENTUM (fabric vendor)	INSIGHT (pattern name)	FOSSIL (pattern color)
------------------	-----------------------	-----------------	--------------------------	-----------------------------	---------------------------	---------------------------

1. Model Number

2. Wood Species - Rift Cut White Oak (WK4) or Flat Cut Walnut (WA1)

3. Wood Finish Options:

- CLK Clear on Rift Cut White Oak
- CLW Clear on Flat Cut Walnut

4. Door or Drawer Front Optional Paint Color - Add \$45 list per item

- | | |
|------------------|----------------------|
| BKD Backdrop | GRV Greek Villa |
| BFX Black Fox | NET Network Gray |
| BWH Bright White | NWH Nonchalant White |
| CGP Cargo Pants | STM Storm |
| CHT Chatroom | TRC Tricorn Black |
| FRR French Roast | |

5. Metal Leg Color:

- | | |
|-------------------|---------------------|
| ABZ Aged Bronze** | SBZ Soft Bronze** |
| GLD Gold ** | SNK Soft Nickel ** |
| MBK Matte Black | STS Stardust Silver |
| PEW Pewter ** | |

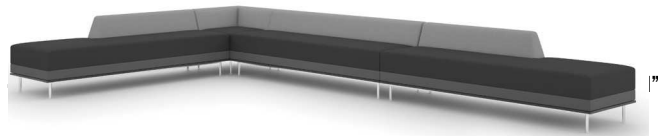
**** Add \$150 list per item for select metal finishes**

**6. Fabric Selection - Please supply the following:
Fabric vendor/ Pattern name/ Pattern color**

[For a complete list of JSI Standard and Graded-In Textiles click here](#)

Contrasting Upholstery - Units can be specified with a contrasting upholstery feature. When this feature is desired the unit **will be priced based on the higher grade fabric** selected for the seat, back, deck or deck and arm(s).

When specifying contrasting upholstery, indicate clearly the upholstery to be applied to the seat, back, deck or deck and arm(s).



All COM orders must include the following:

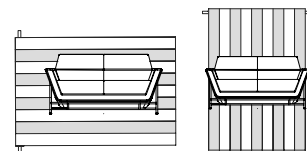
- Fabric vendor's name, pattern name and color
- Sample of the fabric attached to order
- Model numbers of items for fabric application
- Special application instructions (e.g., all stripes will be applied front to back unless specified otherwise)
- Customer and purchase order number

Ship prepaid COM

material to:
JSI
Attn: COM Department
201 East Martin Street
Receiving B, Dock 71
Orleans, IN 47452

Application of fabric:

Railroaded Up the Roll



7. Glass Color:

- | | | | |
|-------|-------|-------|-------|
| GTC01 | Clear | GTC04 | Smoke |
|-------|-------|-------|-------|

8. Optional Power Center (EC22) - add \$583 list, specify color and location

9. Optional Black Grommet - add \$105 list each

Seating

Wood Materials

Exterior surfaces are laminated veneers either in plain sliced walnut or rift cut white oak.

Seating exterior components are made up of layers of hardwood veneer molded to shape and RF cured. Outer veneers are matched for a uniform grain pattern. Exterior plywood is 5/8" thick.

Interior seating frame and support components are made from 3/4" interior grade plywood.

Metal Materials

Exterior feet and leg frames are fabricated from 14 gauge steel tubing and welded to pre-set standards.

Construction

Seating interior frames are constructed with upholstery grade plywood with precisely cut interlocking joints. All joints are glued and reinforced with staples. Critical joints are fastened with screws to reinforce the joint. Frame components are assembled using t-nuts for metal to metal connection.

Upholstery Details

Seating suspension for modular units has a 3-1/2" high-resilience seat foam placed onto sheet webbing for comfort and durability. Back and arm foam is a high density foam for comfort and durability.

Freestanding upholstered units have 6" thick high-resilience seat foam for durability. The bottom of the seat plywood is ventilated to allow the seat foam to breathe. Back and arm foam is a high density foam for comfort and durability.

Single needle top stitch is used on all BeSPACE models.

Exterior Metal Components

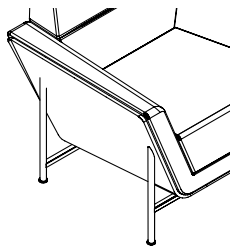
Leg frame is welded to pre-set standards and then the outer surfaces are prepared for powder coating. Leg frame and glide will be same color.

Powder coat finishes available:

ABZ	Aged Bronze**	SBZ	Soft Bronze**
GLD	Gold **	SNK	Soft Nickel
MBK	Matte Black	STS	Stardust Silver
PEW	Pewter		

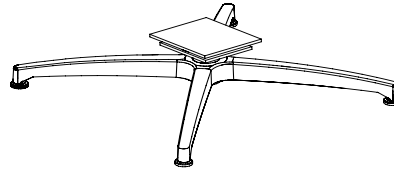
** Select metal finishes - Add \$150 list per item

Legs with adjustable glides are mounted with internal connections which are embedded into the plywood exterior. The angular cut matches up with the plywood exterior for a floating appearance.



Special Features

Model BS-1 Lounge Chair with the swivel mechanism and four prong base with non-adjustable push-in glides features a 360° swivel. The standard 3.5° rearward tilt is welded in to the spindle of the mechanism plate, the spindle sits into a passive hub of the prong base.



Finish

To accentuate the beauty of the walnut or white oak veneers a clear finish coat is applied to the exposed plywood shells and platforms.

Exterior Seating Plywood Shell and Platforms are available in two finishes:
 Clear Coat on Walnut CLW
 Clear Coat on Rift Cut White Oak CLK

To reduce hazardous formaldehyde emission we use our proprietary special-ly design top coat, DuraTex™. We are proud that our finish is GreenGuard certified.

DuraTex™, offers exceptional hardness along with abrasion and impact resistance, but has been formulated to eliminate hazardous and harmful gases that are normally associated with wood finish.

DuraTex™ Features

- Safety - Significantly reduces hazardous formaldehyde emissions which help improve the quality of the indoor air we breathe.
- Quality - Developed to be tough and durable with special attention to appearance. The DuraTex™ finish provides a safe solution and still preserves the natural beauty of wood.
- Durability - Designed to meet a wide range of demanding performance and environmental standards to withstand even the highest wear and tear.

Care and Maintenance

Care of Upholstery Surfaces

Cleanability will vary based on the fabric type. For best results, a professional service is recommended. Dirt and crumbs may be gently brushed or vacuumed off. Spills should be wiped up immediately with a cloth. Vinyl textiles can be cleaned with warm soapy water and wiped down with a warm damp cloth. For more details on any JSI carded fabric and vinyl, please visit our website at www.jsifurniture.com or consult the back of the appropriate swatch card for cleaning codes and any specific instructions. For COM materials, consult with the individual textile manufacturer for cleaning codes and any specific instructions pertaining to your particular fabric.

Maintenance of Mechanical Parts

Clean any lint or debris from the moving parts of the base mechanisms. Mechanisms have been designed and tested to not require lubrication under normal conditions however lubricant can be used if needed.

Metal Components

Wipe smooth powder coat finishes and textured metals with a damp cloth. For stubborn stains and grease marks, use soap and water. Lightly brush textured metals with a soft, dry brush to remove dirt.

Casegoods

Wood Materials

Exterior surfaces are laminated veneers either in plain sliced walnut or rift cut white oak.

Casegood tops are made up of layers of hardwood veneers molded to shape and RF cured. Outer veneers are matched for uniform grain patterns. All casegood tops are 3/4" thick plywood.

Casegood chassis, doors and drawer fronts consist of veneer over composite wood core; all wood core components are 3/4" thick.

Metal Materials

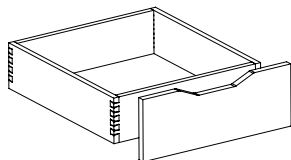
Exterior feet are fabricated using 14 gauge steel tubing and 14 gauge flat stock.

Construction

Casegoods are constructed with a series of glued wood dowels and metal-to-wood fastening hardware to reinforce critical joints.

Feet are field installed to prevent shipping damage, pre-bored holes make installation easy. Instructions, feet, and other hardware will be packed inside the carton.

Drawer boxes are constructed from plywood components with dovetail joinery, providing superior tensile strength to the box. Under-mount drawer suspensions are "full extension" which allows the drawers to open fully. The "soft-close" mechanism allows the drawers to close with a slight push. Drawer and door fronts feature a finger pull and are non-locking. Drawers in the BeSPACE product line are not intended for filing.



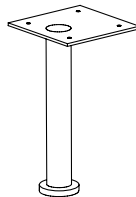
5-sided drawer box

Casegood Feet

Feet are fabricated with a flat plate which is screwed to the bottom of the casegoods. The feet have an adjustable glide for ease of leveling.

Powder coat finishes available:

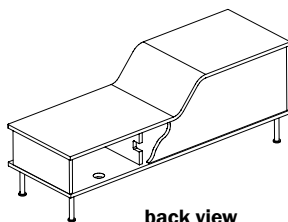
ABZ	Aged Bronze**	SBZ	Soft Bronze**
GLD	Gold **	SNK	Soft Nickel **
MBK	Matte Black	STS	Stardust Silver
PEW	Pewter **		



** Select metal finishes - Add \$150 list per item

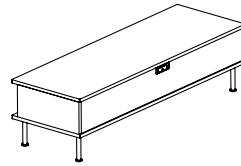
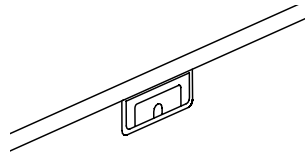
Glide matches powder coat finish selected on feet.

Credenza units have wire pass through incorporated into the interior dividers and bottom panels to allow for wiring to pass easily through the unit. A metal stress-bar runs the full length on the bottom side of the credenzas providing additional support.

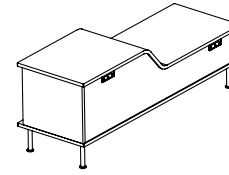


back view

Optional matte black grommets are available in the back panel but must be specified. Grommets are located as shown, center on single height units and two locations on transition height units.



single height



transition height

Finish

To accentuate the beauty of the walnut or white oak veneer a clear finish coat is applied to the chassis of the BeSPACE products. Drawer and door fronts can be matched with the same clear coat finish on the veneer or may be specified with a painted finish.

Chassis and Drawer or Door Fronts

Clear Coat on Rift Cut White Oak - CLW

Clear Coat on Walnut - CLK

Drawer/Door Fronts (optional Paint on Maple Veneer) - Add \$45 list per item

Backdrop	BKD	Greek Villa	GRV
Black Fox	BFX	Network Gray	NET
Bright White	BWH	Nonchalant White	NWH
Cargo Pants	CGP	Storm	STM
Chatroom	CHT	Tricorn Black	TRC
French Roast	FRR		

To reduce hazardous formaldehyde emission we use our proprietary specially designed top coat, DuraTex™. We are proud that our finish is GreenGuard certified.

DuraTex™ offers exceptional hardness along with abrasion and impact resistance, but has been formulated to eliminate hazardous and harmful gases that are normally associated with wood finish.

DuraTex™ Features

Safety - Significantly reduces hazardous formaldehyde emissions which help improve the quality of the of the indoor air we breathe.

Quality - Developed to be tough and durable with special attention to appearance. The DuraTex™ finish provides a safe solution and still preserves the natural beauty of wood.

Durability - Designed to meet a wide range of demanding performance and environmental standards to withstand even the highest wear and tear.

Glass Tables

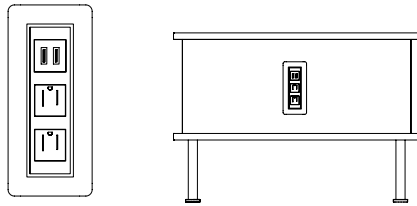
Glass Tops are 1/2" thick tempered and are available in Clear (low iron) or Smoke. Pliable polyurethane bumpers, along with the weight of the top, keeps the glass in place.

- Clear GTC01
- Smoke GTC04

Optional Data/Electrical Components

EC22 Power Center- Flush Mount

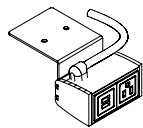
EC22 unit provides electric for two 110 devices and one USB 2-Port Simplex for charging. This factory installed unit is mounted in the front or back panel(s) of modular closed tables. When ordering specify color and location, see below. Power is connected to the building supply with 10' standard three prong cord. Access and storage of excess power cord is provided in the cavity of the tables.



Note: Power Center color, Black (B) or White (W) must be specified.

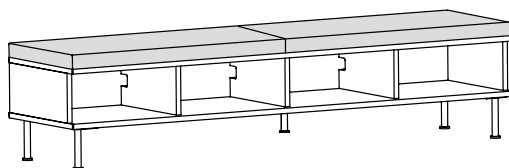
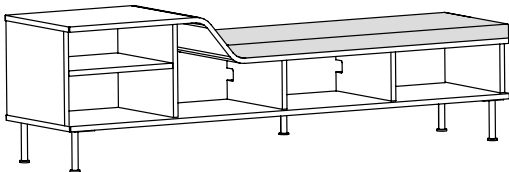
EC21 Power Center - Under Mount

This accessory item features one 110 device and one USB 2-Port Simplex for charging. The EC21 unit is ordered separately and can be mounted on the bottom platform of casegoods and lounge seating, see "Power Center Under Mount".



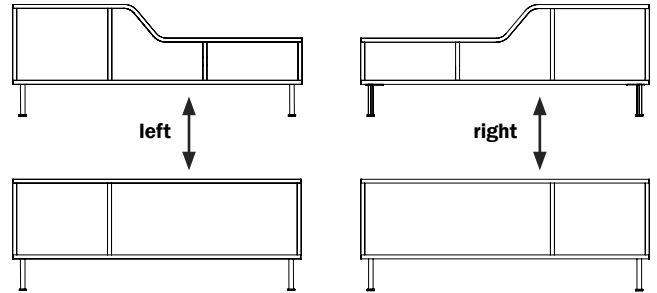
Credenza with Optional Cushions

Bench Height and Transitional Height credenza units can be ordered with an optional factory installed cushion. (Select appropriate fabric grade when pricing the unit). Cushion should not be removed due to permanent attachment.



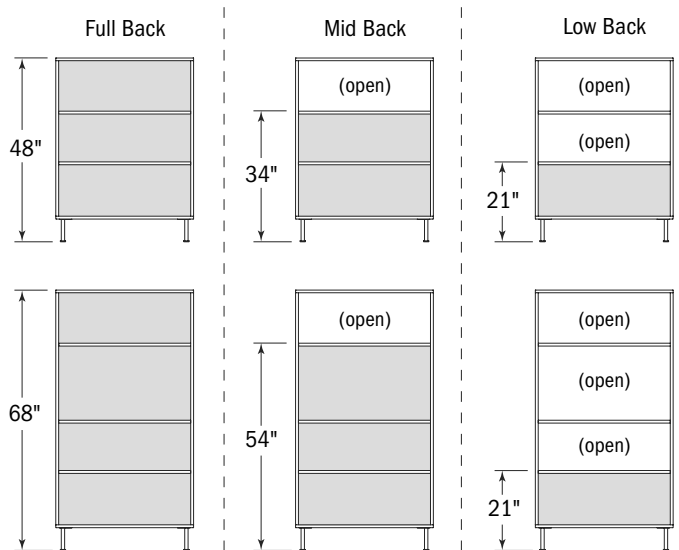
How to determine Left and Right

Left and right is determined by facing the unit; the transitional height unit determines the left or right orientation.



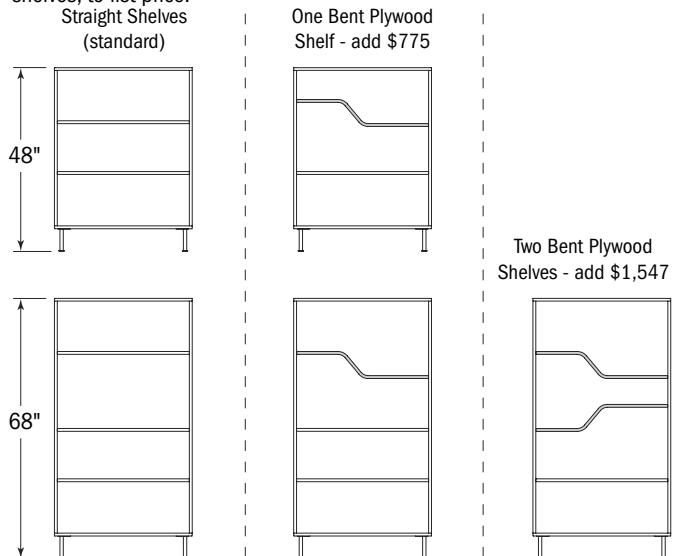
Bookcase Back Heights

Bookcases are available in two heights, 48 and 68 inches tall. When ordering, please specify one of the three back height options; Full Back, Mid Back or Low Back.



Bookcase Shelving

All bookcase shelves are offered straight as standard. The lowest shelf is always fixed and straight. Upper shelves are adjustable and available with optional bent plywood. The bent plywood shelves are reversible, they can slope in either direction. When ordering bookcases with bent plywood shelves, please specify and add \$775 for one shelf, and \$1,547 for two shelves, to list price.

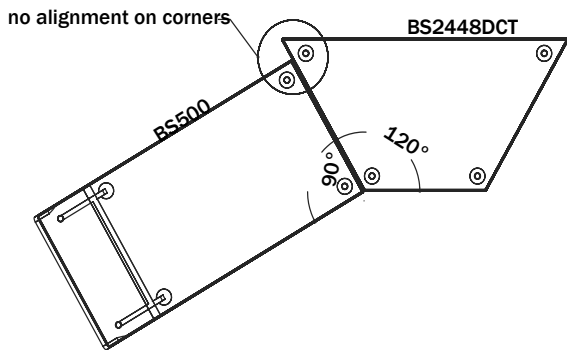
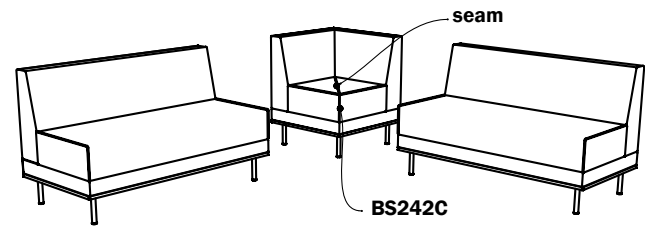
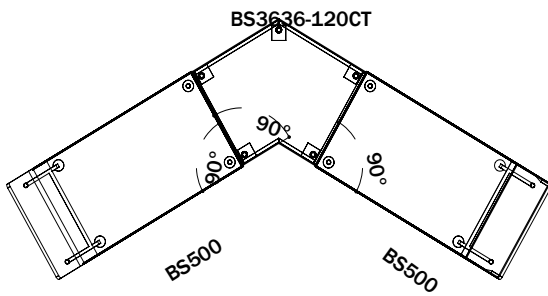
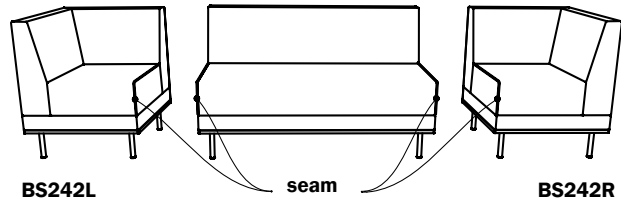
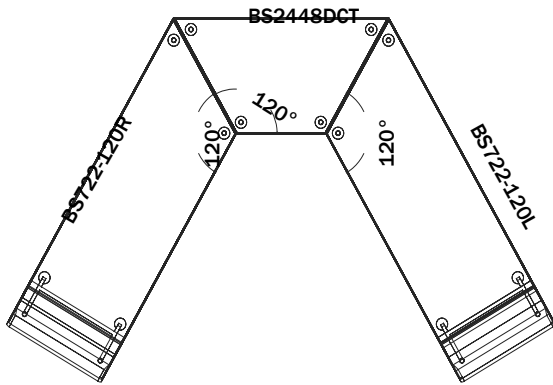


BeSPACE

Modular Tables and Modular Lounge - Connecting

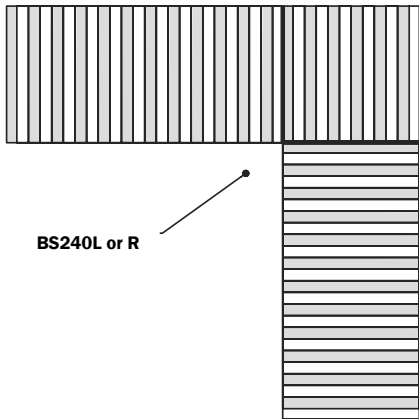
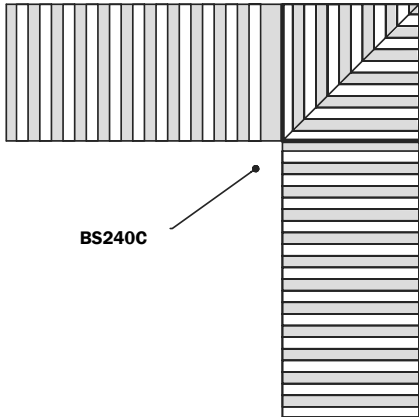
1. To create turns with in a product run, connect 120° units with other 120° units or 90° (square end) units with other 90° (square end) units to create turns.

2. For a flat tailored surface corner units will have a seam on the linking side.

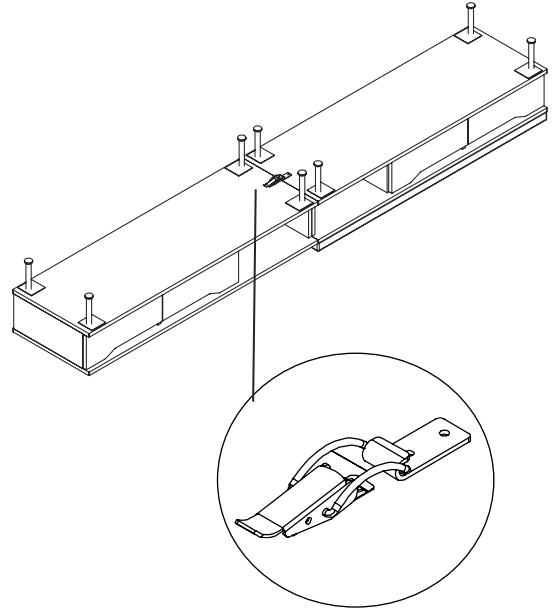


Note: 120° and 90° (square end) units cannot be connected to one another

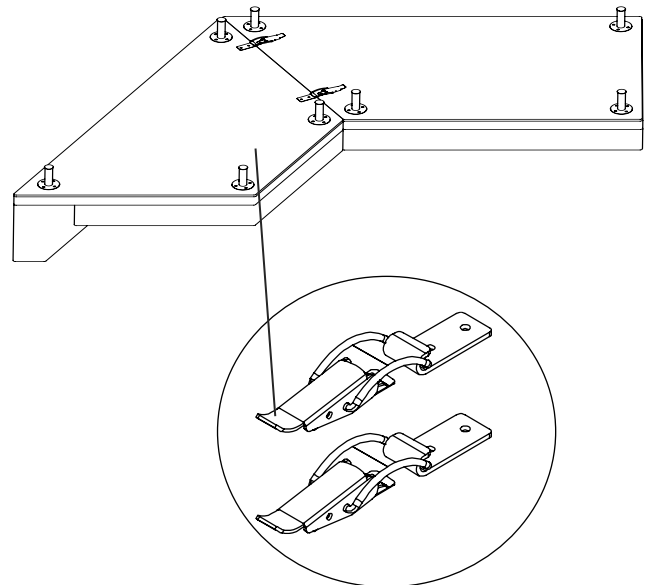
- When using textiles with a pattern or large repeats we recommend specifying the corner units with "C" at the end of the model number. Note there will be a diagonal seam allowing for a textile match. If the upholstery cover is non-directional the diagonal seam will be eliminate



- Modular tables are shipped with connecting hardware to secure units together. The draw catch style hardware makes connection easy. Pre-bore holes are standard.



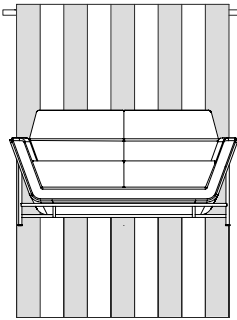
- Modular lounge units are shipped with two sets of connecting hardware to secure them together. The draw catch style hardware makes connection easy. Pre-bore holes are standard.



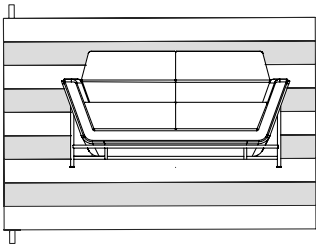
Upholstery Application

Unless the customer specifies the fabric to be “railroaded”, the fabric will be “cut up the roll”. Additional seaming may be needed pending fabric width and textile repeat match, contact Customer Service with questions.

“Nap” or “Up the Roll” (standard)

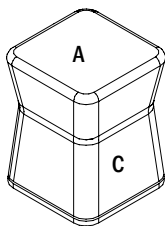
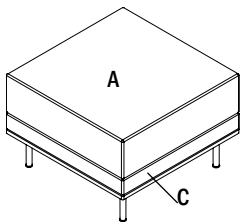
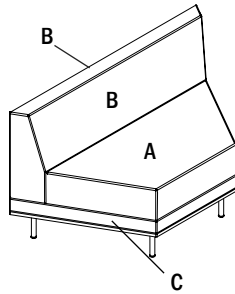
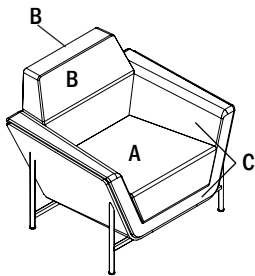


Railroaded (upon request)



Contrasting Upholstery

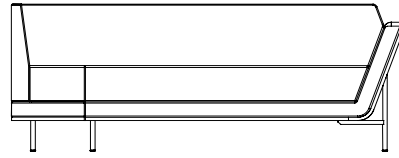
Units can be specified with a contrasting upholstery feature. When this feature is desired the unit **will be priced based on the highest grade fabric**. At the time of ordering identify the location of each textile according to the following code.



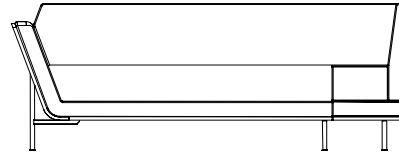
- A = Seat
- B = Front Back/Extreme Back
- C = Deck or Deck and Arm (s)

How to Determine Left and Rights

Left and right is determined as you are seated in the chair.



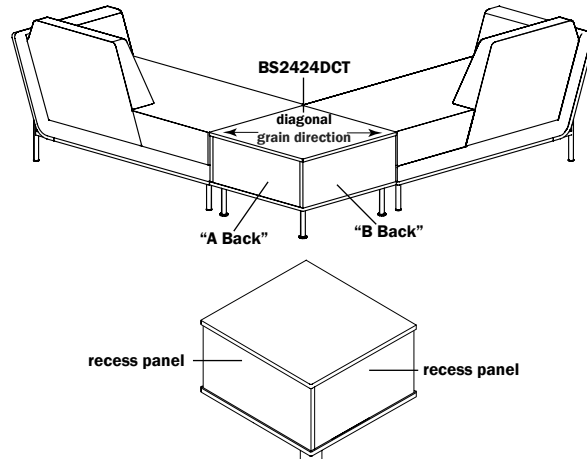
left shown



right shown

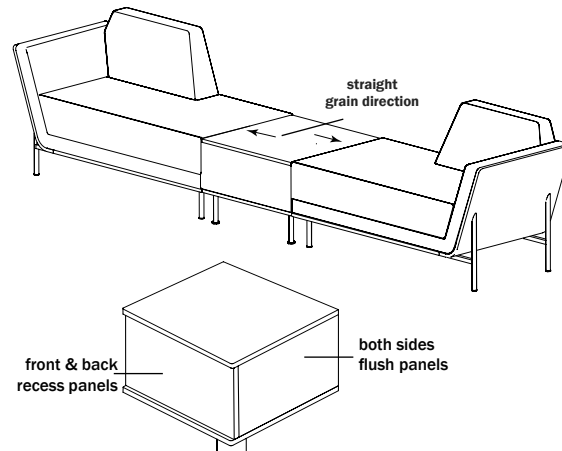
BS2424DCT Table

This corner table is designed to create a 90° (square end) turn with two modular components as shown in the example below. The “A” or “B” back panels are identified to help specify the location of the EC22 power data unit. When ordering an EC22 specify “A” and/or “B” location. The two back panels are slightly recessed. The grain runs diagonal on the table top.



BS2424SCT Table

This table is designed to create a straight run of modular components as shown in the example below. The EC22 can be installed in the front or back panel. The front and back panel are slight recessed. The grain on this top runs side to side.



Model	Description	Seat Only COM Ydg	Back Only COM Ydg	Deck and Arm(s) Only COM Ydg	Deck Only COM Ydg
BS1	Lounge Chair	1.25	1	1.5	0
BS1-S	Swivel Lounge Chair	1.25	1	1.5	0
BS140	Upholstered Pod	0.75	0	0	0.75
BS140W	Upholstered Table	0.75	0	0	0.75
BS2	Sette Lounge	2.5	2	1.5	0
BS230	Ottoman	1	0	0	0
BS240	24" Straight Bench	1.25	0	0	0.5
BS240-122	120° Connecting Bench	2	0	0	0.5
BS240C	24" Corner Bench	1.25	0	0	0.5
BS242-122	120° Connecting Bench with Back	2	2	0	0.5
BS242C	Corner Bench with Back, Center	0.75	2	0	0.5
BS242L	Corner Bench with Back, Left	0.75	2	0	0.5
BS242R	Corner Bench with Back, Right	0.75	2	0	0.5
BS3	Sofa Lounge	3.75	3	1.5	0
BS480	48" Straight Bench	1.5	0	0	0.5
BS480-120L	48" Angled Bench, Left	1.5	0	0	0.5
BS480-120R	48" Angled Bench, Right	1.5	0	0	0.5
BS480-122	48" Dual Angled Bench	1.5	0	0	0.5
BS481L	48" Partial Back Bench, Left	1.5	1.5	0	0.5
BS481R	48" Partial Back Bench, Right	1.5	1.5	0	0.5
BS482	48" Straight Bench with Back	1.5	1.5	0	0.5
BS482-120L	48" Angled Bench with Back, Left	1.5	1.5	0	0.5
BS482-120R	48" Angled Bench with Back, Right	1.5	1.5	0	0.5
BS482-122	48" Dual Angled Bench with Back	1.5	1.5	0	0.5
BS500	50" Open Side Bench	1.5	0	1.25	0
BS500-120L	50" Angled Open Side Bench, Left	1.5	0	1.25	0
BS500-120R	50" Angled Open Side Bench, Right	1.5	0	1.25	0
BS501L	50" Chaise Bench with Partial Back, Left	1.5	1.75	1.25	0
BS501R	50" Chaise Bench with Partial Back, Right	1.5	1.75	1.25	0
BS502-120L	50" Angled Open Side Bench with Back, Left	1.5	1.75	1.25	0
BS502-120R	50" Angled Open Side Bench with Back, Right	1.5	1.75	1.25	0
BS502L	50" Open Side Bench with Back, Left	1.5	1.75	1.25	0
BS502R	50" Open Side Bench with Back, Right	1.5	1.75	1.25	0
BS720	72" Straight Bench	3	0	0	0.75
BS720-120L	72" Angled Bench, Left	3	0	0	0.75
BS720-120R	72" Angled Bench, Right	3	0	0	0.75
BS720-122	72" Dual Angled Bench	3	0	0	0.75
BS721L	72" Partial Back Bench, Left	3	2.25	0	0.75
BS721R	72" Partial Back Bench, Right	3	2.25	0	0.75
BS722	72" Straight Bench with Back	3	3	0	0.75
BS722-120L	72" Angled Bench with Back, Left	3	3	0	0.75
BS722-120R	72" Angled Bench with Back, Right	3	3	0	0.75
BS722-122	72" Dual Angled Bench with Back	3	3	0	0.75
BS740	74" Open Side Bench	3	0	1.5	0
BS740-120L	74" Angled Open Side Bench, Left	3	0	1.5	0
BS740-120R	74" Angled Open Side Bench, Right	3	0	1.5	0
BS741L	74" Chaise Bench with Partial Back, Left	3	2.25	1.5	0
BS741R	74" Chaise Bench with Partial Back, Right	3	2.25	1.5	0
BS742-120L	74" Angled Open Side Bench with Back, Left	2.75	3.5	1.5	0
BS742-120R	74" Angled Open Side Bench with Back, Right	2.75	3.5	1.5	0
BS742L	74" Open Side Bench with Back, Left	2.75	3.5	1.5	0
BS742R	74" Open Side Bench with Back, Right	2.75	3.5	1.5	0
BS750	Freestanding Bench	2.75	0	0	1

BeSPACE – Compartment - Drawer Sizes

All sizes are rounded down to the nearest 1/4" - sizes for drawers are interior dimensions of drawer boxes.

Unless noted sizes listed are dimensions for the interior compartments – compartment shelves are fixed, shelves are non-adjustable.

	Models	A	B	C	D	E	F
	BS24240CT	9 H 22 W 22 1/4 D					
	BS24480CT	9 H 22 3/4 W 22 3/8 D					
	BS1854-16SOS	7 H 17 W 15 1/2 D					
	BS1872-16SOS	7 H 17 W 15 1/2 D					
	BS1854-16SDWR BS1854-16SDWL	4 1/4 H 15 1/4 W 10 3/4 D Drawer Interior	7 H 17 W 15 1/2 D				
	BS1872-16SDWR BS1872-16SDWL	4 1/4 H 15 1/4 W 10 3/4 D Drawer Interior	7 H 17 W 15 1/2 D				
	BS1872-16SFS	4 1/4 H 15 1/4 W 10 3/4 D Drawer Interior					
	BS1854-20SOSR BS1854-20SOSL	13 1/4 H 34 3/4 W 15 1/2 D	13 1/4 H 17 W 15 1/2 D				
	BS1872-20SOS	5 1/2 H 34 3/4 W 15 1/2 D	7 H 34 3/4 W 15 1/2 D				
	BS1854-20SDWR BS1854-20SDWL	8 1/2 H 33 W 10 3/4 D Drawer Interior	13 1/4 H 17 W 15 1/2 D				
	BS1872-20SDWR BS1872-20SDWL	8 1/2 H 33 W 10 3/4 D Drawer Interior	5 1/2 H 34 3/4 W 15 1/2 D	7 H 34 3/4 W 15 1/2 D			
	BS1872-20SFS	8 1/2 H 33 W 10 3/4 D Drawer Interior					
	BS1854-27SOSR BS1854-27SOSL	5 1/2 H 34 3/4 W 15 1/2 D	13 1/4 H 34 3/4 W 15 1/2 D	5 1/2 H 17 W 15 1/2 D	13 1/4 H 17 W 15 1/2 D		

BeSPACE

BeSPACE – Compartment - Drawer Sizes (continued)

	Models	A	B	C	D	E	F
	BS1872-27SOS	5 1/2 H 17 W 15 1/2 D	13 1/4 H 17 W 15 1/2 D	5 1/2 H 34 3/4 W 15 1/2 D	13 1/4 H 34 3/4 W 15 1/2 D		
	BS1854-27SDWR BS1854-27SDWL	5 1/2 H 34 3/4 W 15 1/2 D	8 1/2 H 33 W 10 3/4 D Drawer Interior	5 1/2 H 17 W 15 1/2 D	13 1/4 H 17 W 15 1/2 D		
	BS1854-27SFSR BS1854-27SFSL	5 1/2 H 34 3/4 W 15 1/2 D	8 1/2 H 33 W 10 3/4 D Drawer Interior	5 1/2 H 13 1/4 H 17 W 14 3/4 D Hinge Door			
	BS1872-27SSR BS1872-27SSL	5 1/2 H 17 W 15 1/2 D	13 1/4 H 17 W 15 1/2 D	5 1/2 H 34 3/4 W 15 1/2 D	8 1/2 H 33 W 10 3/4 D Drawer Interior	5 1/2 H Top Section 13 1/4 H Bottom Section 17 W 14 3/4 D Hinge Door	
	BS1872-27SFS	5 1/2 H Top Section 13 1/4 H Bottom Section 17 W 14 3/4 D Hinge Door	5 1/2 H 34 3/4 W 15 1/2 D	8 1/2 H 33 W 10 3/4 D Drawer Interior			
	BS1854-33SOSR BS1854-33SOSL	5 1/2 H 34 3/4 W 15 1/2 D	5 1/2 H 34 3/4 W 15 1/2 D	13 1/4 H 34 3/4 W 15 1/2 D	5 1/4 H 17 W 15 1/2 D	5 1/2 H 17 W 15 1/2 D	13 1/4 H 17 W 15 1/2 D
	BS1872-33SOS	5 1/4 H 17 W 15 1/2 D	5 1/2 H 17 W 15 1/2 D	13 1/2 H 17 W 15 1/2 D	5 1/4 H 34 3/4 W 15 1/2 D	5 1/2 H 34 3/4 W 15 1/2 D	13 1/2 H 34 3/4 W 15 1/2 D
	BS1854-33SFSR BS1854-33SFSL	5 1/4 H 34 3/4 W 15 1/2 D	5 1/2 H 34 3/4 W 15 1/2 D	8 1/2 H 33 W 10 3/4 D Drawer Interior	5 1/4 H Top Section 5 1/2 H Middle Section 13 1/4 H Bottom Section 17 W 14 3/4 D Hinge Door		
	BS1872-33SSR BS1872-33SSL	5 1/4 H 17 W 15 1/2 D	5 1/2 H 17 W 15 1/2 D	13 1/4 H 17 W 15 1/2 D	5 1/4 H 34 3/4 W 15 1/2 D	5 1/2 H 34 3/4 W 15 1/2 D	8 1/2 H 33 W 10 3/4 D Drawer Interior G 5 1/4 H Top Section 5 1/2 H Middle Section 13 1/4 H Bottom Section 17 W 14 3/4 D Hinge Door

BeSPACE
BeSPACE – Compartment - Drawer Sizes (continued)



	Models	A	B	C	D	E	F
	BS1872-33SFS	5 1/4 H Top Section 5 1/2 H Middle Section 13 1/4 H Bottom Section 17 W 14 3/4 D Hinge Door	5 1/4 H 34 3/4 W 15 1/2 D	5 1/2 H 34 3/4 W 15 1/2 D	8 1/2 H 33 W 10 3/4 D Drawer Interior		
	BS1854-20TOSR BS1854-20TOSL	7 H 17 W 15 1/2 D	7 H 13 1/4 H Transition 17 W 15 1/2 D	13 1/4 H 17 W 15 1/2 D			
	BS1872-20TOSR BS1872-20TOSL	7 H 17 W 15 1/2 D	7 H 13 1/4 H Transition 17 W 15 1/2 D	5 1/2 H 17 W 15 1/2 D	7 H 17 W 15 1/2 D		
	BS1872-20TSR BS1872-20TSL	7 H 17 W 15 1/2 D	4 1/4 H 15 1/4 W 10 3/4 D Drawer Interior	8 1/2 H 15 1/4 W 10 3/4 D Drawer Interior			
	BS1854-20TFSR BS1854-20TFSL	4 1/4 H 15 1/4 W 10 3/4 D Drawer Interior	4 1/4 H 15 1/4 W 10 3/4 D Drawer Interior	8 1/2 H 15 1/4 W 10 3/4 D Drawer Interior			
	BS1872-20TFSR BS1872-20TFSL	4 1/4 H 15 1/4 W 10 3/4 D Drawer Interior	4 1/4 H 15 1/4 W 10 3/4 D Drawer Interior	8 1/2 H 15 1/4 W 10 3/4 D Drawer Interior			
	BS1854-20TDSR BS1854-20TDSL	4 1/4 H 15 1/4 W 10 3/4 D Drawer Interior	4 1/4 H 15 1/4 W 10 3/4 D Drawer Interior	13 1/4 H 17 W 14 3/4 D Hinge Door			
	BS1854-27TOSR BS1854-27TOSL	5 1/2 H 17 W 15 1/2 D	7 H 17 W 15 1/2 D	5 1/2 H 12 H Transition 17 W 15 1/2 D	5 1/2 H 17 W 15 1/2 D	5 1/2 H 17 W 15 1/2 D	
	BS1872-27TOSR BS1872-27TOSL	5 1/2 H 17 W 15 1/2 D	7 H 17 W 15 1/2 D	5 1/2 H 12 H Transition 17 W 15 1/2 D	5 1/2 H 17 W 15 1/2 D	5 1/2 H 17 W 15 1/2 D	
	BS1854-27THDR BS1854-27THDL	5 1/2 H 17 W 15 1/2 D	7 H 17 W 15 1/2 D	15 1/2 H 12 H Transition 17 W 15 1/2 D	5 1/2 H Top Section 5 1/2 H Middle Section 7 H Bottom Section 17 W 14 3/4 D Hinge Door		


BeSPACE


BeSPACE – Compartment - Drawer Sizes (continued)

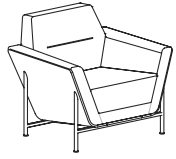
	Models	A	B	C	D	E	F
	BS1872-27TSR BS1872-27TSL	5 1/2 H 17 W 15 1/2 D	7 H 17 W 15 1/2 D	5 1/2 H 12 H Transition 17 W 15 1/2 D	5 1/2 H Top Section 5 1/2 H Middle Section 7 H Bottom Section 17 W 14 3/4 D Hinge Door		
	BS1854-27FSR BS1854-27FSL	8 1/2 H 15 1/4 W 10 3/4 D Drawer Interior	8 1/2 H 15 1/4 W 10 3/4 D Drawer Interior	5 1/2 H Top Section 5 1/2 H Middle Section 7 H Bottom Section 17 W 14 3/4 D Hinge Door			
	BS1872-27FSR BS1872-27FSL	8 1/2 H 15 1/4 W 10 3/4 D Drawer Interior	8 1/2 H 15 1/4 W 10 3/4 D Drawer Interior	5 1/2 H Top Section 5 1/2 H Middle Section 7 H Bottom Section 17 W 14 3/4 D Hinge Door			
	BS1854-33TOSR BS1854-33TOSL	5 1/2 H 17 W 15 1/2 D	13 1/2 H 17 W 15 1/2 D	5 1/2 H 11 3/4 H Transition 17 W 15 1/2 D	5 1/2 H 17 W 15 1/2 D	5 1/2 H 17 W 15 1/2 D	
	BS1872-33TOSR BS1872-33TOSL	5 1/2 H 17 W 15 1/2 D	13 1/2 H 17 W 15 1/2 D	5 1/2 H 11 3/4 H Transition 17 W 15 1/2 D	5 1/2 H 17 W 15 1/2 D	5 1/2 H 17 W 15 1/2 D	
	BS1872-33TSR BS1872-33TSL	5 1/2 H 17 W 15 1/2 D	13 1/2 H 17 W 15 1/2 D	5 1/2 H 11 3/4 H Transition 17 W 15 1/2 D	5 1/2 H Top Section 5 1/2 H Middle Section 13 1/2 H Bottom Section 17 W 14 3/4 D Hinge Door		
	BS1854-33FSR BS1854-33FSL	5 1/2 H 17 W 15 1/2 D	8 1/2 H 15 1/4 W 10 3/4 D Drawer Interior	5 1/2 H 11 3/4 H Transition 17 W 15 1/2 D	5 1/2 H Top Section 5 1/2 H Middle Section 13 1/2 H Bottom Section 17 W 14 3/4 D Hinge Door		
	BS1872-33FSR BS1872-33FSL	5 1/2 H 17 W 15 1/2 D	8 1/2 H 15 1/4 W 10 3/4 D Drawer Interior	5 1/2 H 11 3/4 H Transition 17 W 15 1/2 D	5 1/2 H Top Section 5 1/2 H Middle Section 13 1/2 H Bottom Section 17 W 14 3/4 D Hinge Door		

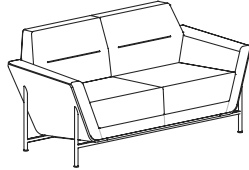
BeSPACE Freestanding

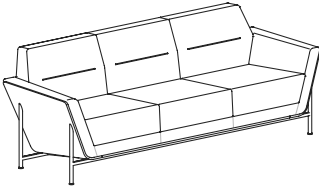


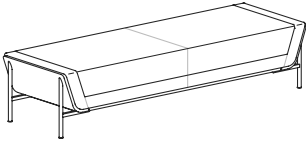
Description	Model	Specifications			List Price Per Grade
Swivel Lounge Chair 	BS1-S · single seat lounge · four prong swivel base with self-returning mechanism · bent ply shell · COM based on single fabric · multiple fabrics, see BS9 for yardage requirements	Dimensions	D	W	H
		Overall	29 1/2	33 1/4	29 3/4
		Seat	20 1/2	21 1/2	17
		Arm	22 3/4		
		Upholstery	Shipping		
		COM Ydg	3 3/4	Ctn Wt	115
		COL Sq Ft	75	Cu Ft	21
					COM \$3,652
					A \$3,702
					B \$3,799
					COL/C \$3,974
					D \$4,198
					E \$4,418
					F \$4,764
					G \$5,136
					H \$5,528
					I \$6,145
					J \$6,890
					L1 \$5,406
					L2 \$5,851

Description	Model	Specifications			List Price Per Grade
Ottoman 	BS230 · four prong swivel base · bent ply shell	Dimensions	D	W	H
		Overall	23	23 1/4	14
		Upholstery	Shipping		
		COM Ydg	1	Ctn Wt	45
		COL Sq Ft	20	Cu Ft	5
					COM \$1,852
					A \$1,864
					B \$1,890
					COL/C \$1,937
					D \$1,997
					E \$2,055
					F \$2,147
					G \$2,245
					H \$2,351
					I \$2,517
					J \$2,714
					L1 \$2,318
					L2 \$2,438

Description	Model	Specifications			List Price Per Grade
Lounge Chair 	BS1 · single seat lounge · bent ply shell · COM based on single fabric · multiple fabrics, see BS9 for yardage requirements	Dimensions	D	W	H
		Overall	29 1/2	33 1/4	29 3/4
		Seat	20 1/2	21 1/2	17
		Arm	22 3/4		
		Upholstery	Shipping		
		COM Ydg	3 3/4	Ctn Wt	115
		COL Sq Ft	75	Cu Ft	21
					COM \$3,652
					A \$3,702
					B \$3,799
					COL/C \$3,974
					D \$4,198
					E \$4,418
					F \$4,764
					G \$5,136
					H \$5,528
					I \$6,145
					J \$6,890
					L1 \$5,406
					L2 \$5,851

Description	Model	Specifications			List Price Per Grade
Settee Lounge 	BS2 · two seat lounge · bent ply shell · COM based on single fabric · multiple fabrics, see BS9 for yardage requirements	Dimensions	D	W	H
		Overall	29 1/2	58 1/4	29 3/4
		Seat	20 1/2	46 1/2	17
		Arm	22 3/4		
		Upholstery	Shipping		
		COM Ydg	6	Ctn Wt	178
		COL Sq Ft	120	Cu Ft	36
					COM \$5,082
					A \$5,160
					B \$5,320
					COL/C \$5,597
					D \$5,954
					E \$6,306
					F \$6,862
					G \$7,453
					H \$8,087
					I \$9,075
					J \$10,262
					L1 \$7,887
					L2 \$8,599

Description	① Model	Specifications				List Price Per Grade	
		Dimensions	D	W	H	COM	
Sofa Lounge 	BS3 • three seat lounge • bent ply shell • COM based on single fabric • multiple fabrics, see BS9 for yardage requirements	Overall	29 1/2	82 1/4	29 3/4	COM	\$6,080
		Seat	20 1/2	70 1/2	17	COL/C	\$6,787
		Arm			22 3/4	D	\$7,275
		Upholstery		Shipping		E	\$7,766
		COM Ydg	8 1/4	Ctn Wt	244	F	\$8,525
		COL Sq Ft	165	Cu Ft	50	G	\$9,340
						H	\$10,211
						I	\$11,570
						J	\$13,200
						L1	\$9,939
				L2	\$10,917		

Description	① Model	Specifications				List Price Per Grade	
		Dimensions	D	W	H	COM	
Freestanding Bench 	BS750 • bent ply shell • COM based on single fabric • multiple fabrics, see BS9 for yardage requirements	Overall	24	74 1/2	17	COM	\$3,132
		Seat	24	66 3/4	17	B	\$3,250
		Upholstery		Shipping		COL/C	\$3,389
		COM Ydg	3 3/4	Ctn Wt	78	D	\$3,567
		COL Sq Ft	75	Cu Ft	22	E	\$3,745
						F	\$4,022
						G	\$4,317
						H	\$4,636
						I	\$5,131
						J	\$5,720
				L1	\$4,693		
				L2	\$5,089		

To Order, Specify:

- ① Model Number
- ② Wood Species - Rift Cut White Oak (WK4) or Flat Cut Walnut (WA1)
- ③ Wood Finish [See Wood Finish Options](#)
- ④ Metal Leg Color [See Metal Leg Color Options](#)
- ⑤ Fabric Selection - Vendor, Pattern and Color
 - A. Seat
 - B. Back
 - C. Deck or Deck and Arm(s)

Visit www.jsifurniture.com/finishes-and-materials/textiles for our textiles program.
See selection of standard and graded in manufacturers and patterns.

Specifications:

- Wood species - Rift Cut White Oak or Flat Cut Walnut.
- 5/8" thick exterior plywood.
- Interior seating frame and support components are made from 3/4" interior grade plywood.
- Exterior feet and leg frames are fabricated from 14 gauge steel tubing.
- Freestanding units have 6" thick high-resilience seat foam for durability.
- Freestanding back and arm foam is high density for comfort and durability.
- Ottoman and bench unit have a high-resilience seat foam placed onto sheet webbing for comfort and durability.

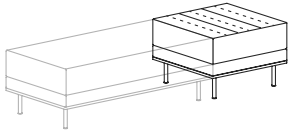
Description

1 Model

Specifications

List Price Per Grade

24" Straight Bench



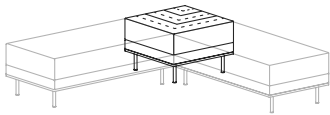
BS240

- plywood platform
- linking hardware
- COM based on single fabric
- multiple fabrics, see [BS9](#) for yardage requirements
- links only to other units with a square end, (cannot link to a 120° angled end)

Dimensions	D	W	H
Overall	24	24	16 1/2
Seat	24	24	16 1/2
Upholstery		Shipping	
COM Ydg	1 3/4	Ctn Wt	48
COL Sq Ft	35	Cu Ft	6

COM	\$1,334
A	\$1,359
B	\$1,405
COL/C	\$1,484
D	\$1,589
E	\$1,693
F	\$1,854
G	\$2,026
H	\$2,212
I	\$2,499
J	\$2,845
L1	\$2,152
L2	\$2,361

24" Corner Bench



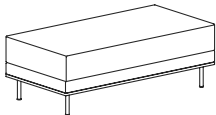
BS240C

- diagonal seam
- plywood platform
- linking hardware
- COM based on single fabric
- multiple fabrics, see [BS9](#) for yardage requirements
- links only to other units with a square end, (cannot link to a 120° angled end)

Dimensions	D	W	H
Overall	24	24	16 1/2
Seat	24	24	16 1/2
Upholstery		Shipping	
COM Ydg	1 3/4	Ctn Wt	48
COL Sq Ft	35	Cu Ft	6

COM	\$1,334
A	\$1,359
B	\$1,405
COL/C	\$1,484
D	\$1,589
E	\$1,693
F	\$1,854
G	\$2,026
H	\$2,212
I	\$2,499
J	\$2,845
L1	\$2,152
L2	\$2,361

48" Straight Bench



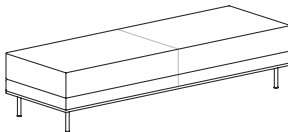
BS480

- plywood platform
- linking hardware
- COM based on single fabric
- multiple fabrics, see [BS9](#) for yardage requirements
- links only to other units with a square end, (cannot link to a 120° angled end)

Dimensions	D	W	H
Overall	24	48	16 1/2
Seat	24	48	16 1/2
Upholstery		Shipping	
COM Ydg	2	Ctn Wt	61
COL Sq Ft	44	Cu Ft	11

COM	\$1,915
A	\$1,942
B	\$1,995
COL/C	\$2,087
D	\$2,203
E	\$2,323
F	\$2,506
G	\$2,706
H	\$2,915
I	\$3,247
J	\$3,640
L1	\$2,850
L2	\$3,087

72" Straight Bench



BS720

- plywood platform
- linking hardware
- COM based on single fabric
- multiple fabrics, see [BS9](#) for yardage requirements
- links only to other units with a square end, (cannot link to a 120° angled end)

Dimensions	D	W	H
Overall	24	72	16 1/2
Seat	24	72	16 1/2
Upholstery		Shipping	
COM Ydg	3 3/4	Ctn Wt	86
COL Sq Ft	83	Cu Ft	17

COM	\$2,561
A	\$2,612
B	\$2,711
COL/C	\$2,885
D	\$3,106
E	\$3,327
F	\$3,673
G	\$4,043
H	\$4,439
I	\$5,056
J	\$5,796
L1	\$4,513
L2	\$5,007

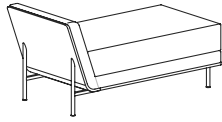
Description

1 Model

Specifications

List Price Per Grade

50" Open Side Bench



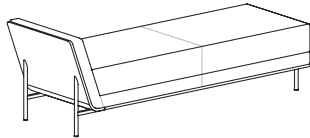
BS500

- bent ply shell
- linking hardware
- COM based on single fabric
- multiple fabrics, see [BS9](#) for yardage requirements
- links only to other units with a square end, (cannot link to a 120° angled end)

Dimensions	D	W	H
Overall	24	49 ³ / ₄	24 ³ / ₄
Seat	24	42 ³ / ₄	16 ¹ / ₂
Arm			24 ³ / ₄
Upholstery		Shipping	
COM Ydg	2 ³ / ₄	Ctn Wt	89
COL Sq Ft	60 ¹ / ₂	Cu Ft	20

COM	\$2,721
A	\$2,759
B	\$2,828
COL/C	\$2,959
D	\$3,123
E	\$3,284
F	\$3,537
G	\$3,809
H	\$4,100
I	\$4,551
J	\$5,097
L1	\$4,155
L2	\$4,516

74" Open Side Bench



BS740

- bent ply shell
- linking hardware
- COM based on single fabric
- multiple fabrics, see [BS9](#) for yardage requirements
- links only to other units with a square end, (cannot link to a 120° angled end)

Dimensions	D	W	H
Overall	24	73 ³ / ₄	24 ³ / ₄
Seat	24	66 ³ / ₄	16 ¹ / ₂
Arm			24 ³ / ₄
Upholstery		Shipping	
COM Ydg	4 ¹ / ₂	Ctn Wt	145
COL Sq Ft	99	Cu Ft	31

COM	\$3,384
A	\$3,446
B	\$3,562
COL/C	\$3,768
D	\$4,035
E	\$4,301
F	\$4,718
G	\$5,160
H	\$5,636
I	\$6,378
J	\$7,268
L1	\$5,727
L2	\$6,319

To Order, Specify:

- 1 Model Number
- 2 Wood Species - Rift Cut White Oak (WK4) or Flat Cut Walnut (WA1)
- 3 Wood Finish See [Wood Finish Options](#)
- 4 Metal Leg Color See [Metal Leg Color Options](#)
- 5 Fabric Selection - Vendor, Pattern and Color
 - A. Seat
 - B. Back
 - C. Deck or Deck and Arm(s)

Visit www.jsifurniture.com/finishes-and-materials/textiles for our textiles program.
See selection of standard and graded in manufacturers and patterns.

Specifications:

- Wood species - Rift Cut White Oak or Flat Cut Walnut.
- ⁵/₈" thick exterior plywood.
- Interior seating frame and support components are made from ³/₄" interior grade plywood.
- Exterior feet and leg frames are fabricated from 14 gauge steel tubing.
- Modular seating units have a 3 ¹/₂" high-resilience seat foam placed onto sheet webbing for comfort and durability.
- Modular back and arm foam is high density for comfort and durability.

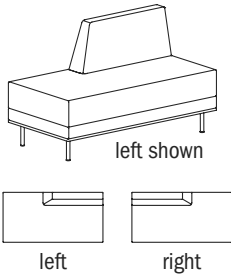
Description

Model

Specifications

List Price Per Grade

48" Partial Back Bench



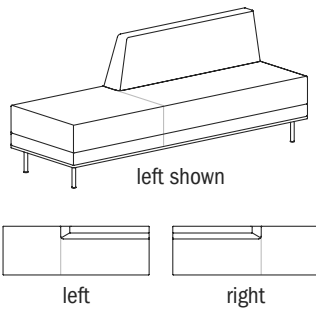
BS481R
BS481L

- plywood platform
- linking hardware
- COM based on single fabric
- multiple fabrics, see [BS9](#) for yardage requirements
- links only to other units with a square end, (cannot link to a 120° angled end)

Dimensions	D	W	H
Overall	24	48	28 1/2
Seat	17	48	16 1/2
Upholstery		Shipping	
COM Ydg	3 1/2	Ctn Wt	92
COL Sq Ft	77	Cu Ft	18

COM	\$2,442
A	\$2,487
B	\$2,578
COL/C	\$2,740
D	\$2,948
E	\$3,159
F	\$3,480
G	\$3,826
H	\$4,194
I	\$4,772
J	\$5,460
L1	\$4,261
L2	\$4,725

72" Partial Back Bench



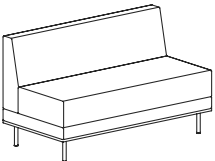
BS721R
BS721L

- plywood platform
- linking hardware
- COM based on single fabric
- multiple fabrics, see [BS9](#) for yardage requirements
- links only to other units with a square end, (cannot link to a 120° angled end)

Dimensions	D	W	H
Overall	24	72	28 1/2
Seat	17	72	16 1/2
Upholstery		Shipping	
COM Ydg	6	Ctn Wt	120
COL Sq Ft	132	Cu Ft	34

COM	\$3,528
A	\$3,607
B	\$3,763
COL/C	\$4,040
D	\$4,398
E	\$4,750
F	\$5,305
G	\$5,899
H	\$6,532
I	\$7,519
J	\$8,706
L1	\$6,650
L2	\$7,440

48" Straight Bench with Back



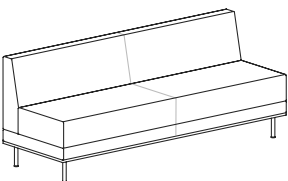
BS482

- plywood platform
- linking hardware
- COM based on single fabric
- multiple fabrics, see [BS9z](#) for yardage requirements
- links only to other units with a square end, (cannot link to a 120° angled end)

Dimensions	D	W	H
Overall	24	48	28 1/2
Seat	17	48	16 1/2
Upholstery		Shipping	
COM Ydg	3 1/2	Ctn Wt	102
COL Sq Ft	77	Cu Ft	18

COM	\$2,315
A	\$2,364
B	\$2,454
COL/C	\$2,615
D	\$2,823
E	\$3,031
F	\$3,355
G	\$3,700
H	\$4,069
I	\$4,646
J	\$5,336
L1	\$4,136
L2	\$4,600

72" Straight Bench with Back



BS722

- plywood platform
- linking hardware
- COM based on single fabric
- multiple fabrics, see [BS9](#) for yardage requirements
- links only to other units with a square end, (cannot link to a 120° angled end)

Dimensions	D	W	H
Overall	24	72	28 1/2
Seat	17	72	16 1/2
Upholstery		Shipping	
COM Ydg	6 3/4	Ctn Wt	137
COL Sq Ft	149	Cu Ft	34

COM	\$3,451
A	\$3,541
B	\$3,719
COL/C	\$4,030
D	\$4,431
E	\$4,832
F	\$5,453
G	\$6,122
H	\$6,831
I	\$7,943
J	\$9,278
L1	\$6,964
L2	\$7,852

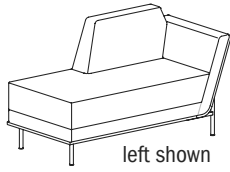
Description

1 Model

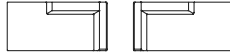
Specifications

List Price Per Grade

50" Chaise Bench with Partial Back



left shown



left

right

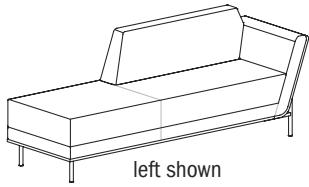
BS501R
BS501L

- bent ply shell
- linking hardware
- COM based on single fabric
- multiple fabrics, see [BS9](#) for yardage requirements
- links only to other units with a square end, (cannot link to a 120° angled end)

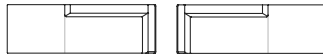
Dimensions	D	W	H
Overall	24	49 ³ / ₄	28 ¹ / ₂
Seat	17	42 ³ / ₄	16 ¹ / ₂
Arm			24 ³ / ₄
Upholstery		Shipping	
COM Ydg	4 ¹ / ₂	Ctn Wt	111
COL Sq Ft	99	Cu Ft	24

COM	\$3,124
A	\$3,184
B	\$3,301
COL/C	\$3,507
D	\$3,776
E	\$4,042
F	\$4,460
G	\$4,900
H	\$5,375
I	\$6,118
J	\$7,006
L1	\$5,465
L2	\$6,056

74" Chaise Bench with Partial Back



left shown



left

right

BS741R
BS741L

- bent ply shell
- linking hardware
- COM based on single fabric
- multiple fabrics, see [BS9](#) for yardage requirements
- links only to other units with a square end, (cannot link to a 120° angled end)

Dimensions	D	W	H
Overall	24	73 ³ / ₄	28 ¹ / ₂
Seat	17	66 ³ / ₄	16 ¹ / ₂
Arm			24 ³ / ₄
Upholstery		Shipping	
COM Ydg	6 ³ / ₄	Ctn Wt	173
COL Sq Ft	149	Cu Ft	34

COM	\$4,186
A	\$4,276
B	\$4,451
COL/C	\$4,764
D	\$5,164
E	\$5,564
F	\$6,186
G	\$6,855
H	\$7,566
I	\$8,677
J	\$10,011
L1	\$7,699
L2	\$8,587

To Order, Specify:

- 1 Model Number
- 2 Wood Species - Rift Cut White Oak (WK4) or Flat Cut Walnut (WA1)
- 3 Wood Finish See [Wood Finish Options](#)
- 4 Metal Leg Color See [Metal Leg Color Options](#)
- 5 Fabric Selection - Vendor, Pattern and Color
 - A. Seat
 - B. Back
 - C. Deck or Deck and Arm(s)

Visit www.jsifurniture.com/finishes-and-materials/textiles for our textiles program.
See selection of standard and graded in manufacturers and patterns.

Specifications:

- Wood species - Rift Cut White Oak or Flat Cut Walnut.
- ⁵/₈" thick exterior plywood.
- Interior seating frame and support components are made from ³/₄" interior grade plywood.
- Exterior feet and leg frames are fabricated from 14 gauge steel tubing.
- Modular seating units have a 3 ¹/₂" high-resilience seat foam placed onto sheet webbing for comfort and durability.
- Modular back and arm foam is high density for comfort and durability.

BeSPACE Modular



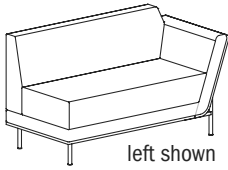
Description

Model

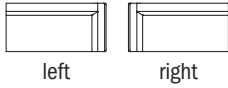
Specifications

List Price Per Grade

50" Open Side Bench
with Back



left shown



left

right

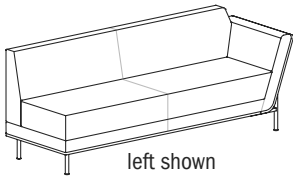
BS502R
BS502L

- bent ply shell
- linking hardware
- COM based on single fabric
- multiple fabrics, see [BS9](#) for yardage requirements
- links only to other units with a square end, (cannot link to a 120° angled end)

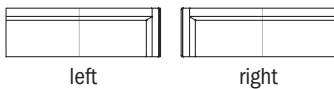
Dimensions	D	W	H
Overall	24	49 ³ / ₄	28 ¹ / ₂
Seat	17	42 ³ / ₄	16 ¹ / ₂
Arm			24 ³ / ₄
Upholstery		Shipping	
COM Ydg	4 ¹ / ₂	Ctn Wt	122
COL Sq Ft	99	Cu Ft	24

COM	\$3,386
A	\$3,448
B	\$3,565
COL/C	\$3,771
D	\$4,038
E	\$4,305
F	\$4,721
G	\$5,168
H	\$5,641
I	\$6,380
J	\$7,270
L1	\$5,729
L2	\$6,322

74" Open Side Bench
with Back



left shown



left

right

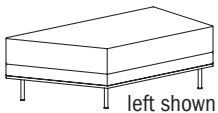
BS742R
BS742L

- bent ply shell
- linking hardware
- COM based on single fabric
- multiple fabrics, see [BS9](#) for yardage requirements
- links only to other units with a square end, (cannot link to a 120° angled end)

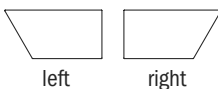
Dimensions	D	W	H
Overall	24	73 ³ / ₄	28 ¹ / ₂
Seat	17	66 ³ / ₄	16 ¹ / ₂
Arm			24 ³ / ₄
Upholstery		Shipping	
COM Ydg	7 ³ / ₄	Ctn Wt	188
COL Sq Ft	171	Cu Ft	34

COM	\$4,317
A	\$4,422
B	\$4,624
COL/C	\$4,982
D	\$5,442
E	\$5,901
F	\$6,616
G	\$7,382
H	\$8,199
I	\$9,476
J	\$11,006
L1	\$8,350
L2	\$9,371

48" Angled Bench



left shown



left

right

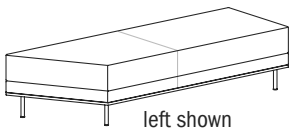
BS480-120R
BS480-120L

- plywood platform
- linking hardware
- COM based on single fabric
- multiple fabrics, see [BS9](#) for yardage requirements
- square end links only to other units with a square end
- 120° angled end links only to other units with a 120° angled end

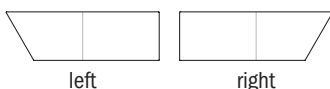
Dimensions	D	W	H
Overall	24	48	16 ¹ / ₂
Seat	24	48	16 ¹ / ₂
Upholstery		Shipping	
COM Ydg	2	Ctn Wt	59
COL Sq Ft	44	Cu Ft	11

COM	\$2,011
A	\$2,039
B	\$2,090
COL/C	\$2,183
D	\$2,304
E	\$2,419
F	\$2,604
G	\$2,803
H	\$3,014
I	\$3,344
J	\$3,739
L1	\$2,947
L2	\$3,185

72" Angled Bench



left shown



left

right

BS720-120R
BS720-120L

- plywood platform
- linking hardware
- COM based on single fabric
- multiple fabrics, see [BS9](#) for yardage requirements
- square end links only to other units with a square end
- 120° angled end links only to other units with a 120° angled end

Dimensions	D	W	H
Overall	24	72	16 ¹ / ₂
Seat	24	72	16 ¹ / ₂
Upholstery		Shipping	
COM Ydg	3 ³ / ₄	Ctn Wt	82
COL Sq Ft	83	Cu Ft	17

COM	\$2,664
A	\$2,715
B	\$2,814
COL/C	\$2,987
D	\$3,210
E	\$3,432
F	\$3,777
G	\$4,147
H	\$4,542
I	\$5,158
J	\$5,901
L1	\$4,615
L2	\$5,110

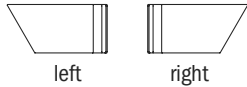
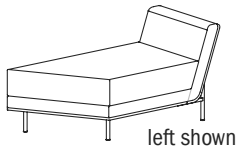
Description

1 Model

Specifications

List Price Per Grade

50" Angled Open Side Bench



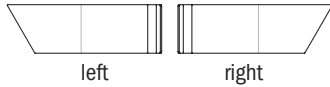
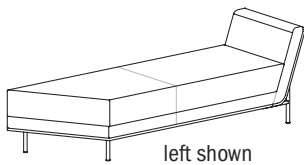
BS500-120R
BS500-120L

- bent ply shell
- linking hardware
- COM based on single fabric
- multiple fabrics, see [BS9](#) for yardage requirements
- links only to other units with a 120° angled end, (cannot link to a square end)

Dimensions	D	W	H
Overall	24	49 ³ / ₄	24 ³ / ₄
Seat	24	42 ³ / ₄	16 ¹ / ₂
Arm			24 ³ / ₄
Upholstery		Shipping	
COM Ydg	2 ³ / ₄	Ctn Wt	84
COL Sq Ft	60 ¹ / ₂	Cu Ft	20

COM	\$2,782
A	\$2,818
B	\$2,890
COL/C	\$3,019
D	\$3,181
E	\$3,344
F	\$3,597
G	\$3,870
H	\$4,158
I	\$4,612
J	\$5,154
L1	\$4,213
L2	\$4,576

74" Angled Open Side Bench



BS740-120R
BS740-120L

- bent ply shell
- linking hardware
- COM based on single fabric
- multiple fabrics, see [BS9](#) for yardage requirements
- links only to other units with a 120° angled end, (cannot link to a square end)

Dimensions	D	W	H
Overall	24	73 ³ / ₄	24 ³ / ₄
Seat	24	66 ³ / ₄	16 ¹ / ₂
Arm			24 ³ / ₄
Upholstery		Shipping	
COM Ydg	4 ¹ / ₂	Ctn Wt	141
COL Sq Ft	99	Cu Ft	31

COM	\$3,458
A	\$3,521
B	\$3,636
COL/C	\$3,844
D	\$4,111
E	\$4,379
F	\$4,794
G	\$5,237
H	\$5,713
I	\$6,453
J	\$7,343
L1	\$5,800
L2	\$6,393

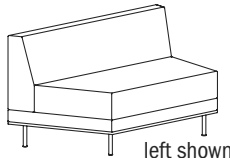
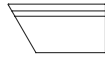

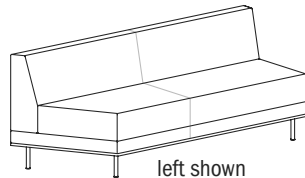


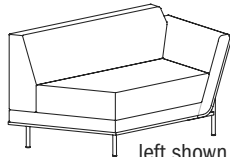


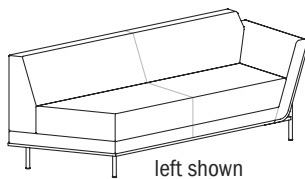

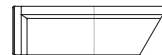
To Order, Specify:

- 1 Model Number
- 2 Wood Species - Rift Cut White Oak (WK4) or Flat Cut Walnut (WA1)
- 3 Wood Finish See [Wood Finish Options](#)
- 4 Metal Leg Color See [Metal Leg Color Options](#)
- 5 Fabric Selection - Vendor, Pattern and Color
 - A. Seat
 - B. Back
 - C. Deck or Deck and Arm(s)

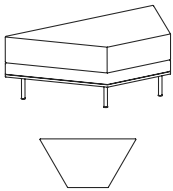
Visit www.jsifurniture.com/finishes-and-materials/textiles for our textiles program.
See selection of standard and graded in manufacturers and patterns.

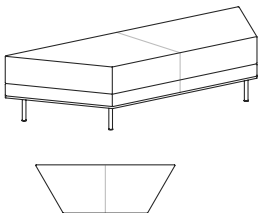
Specifications:

- Wood species - Rift Cut White Oak or Flat Cut Walnut.
- ⁵/₈" thick exterior plywood.
- Interior seating frame and support components are made from ³/₄" interior grade plywood.
- Exterior feet and leg frames are fabricated from 14 gauge steel tubing.
- Modular seating units have a 3 ¹/₂" high-resilience seat foam placed onto sheet webbing for comfort and durability.
- Modular back and arm foam is high density for comfort and durability.

Description	Model	Specifications	List Price Per Grade																									
 <p>left shown</p>  <p>left</p>  <p>right</p>	BS482-120R BS482-120L <ul style="list-style-type: none"> plywood platform linking hardware COM based on single fabric multiple fabrics, see BS9 for yardage requirements square end links only to other units with a square end 120° angled end links only to other units with a 120° angled end 	<table border="1"> <thead> <tr> <th>Dimensions</th> <th>D</th> <th>W</th> <th>H</th> </tr> </thead> <tbody> <tr> <td>Overall</td> <td>24</td> <td>48</td> <td>28 1/2</td> </tr> <tr> <td>Seat</td> <td>17</td> <td>44</td> <td>16 1/2</td> </tr> </tbody> </table> <table border="1"> <thead> <tr> <th>Upholstery</th> <th colspan="2">Shipping</th> </tr> </thead> <tbody> <tr> <td>COM Ydg</td> <td>3 1/2</td> <td>Ctn Wt 99</td> </tr> <tr> <td>COL Sq Ft</td> <td>77</td> <td>Cu Ft 18</td> </tr> </tbody> </table>	Dimensions	D	W	H	Overall	24	48	28 1/2	Seat	17	44	16 1/2	Upholstery	Shipping		COM Ydg	3 1/2	Ctn Wt 99	COL Sq Ft	77	Cu Ft 18	COM \$2,408 A \$2,454 B \$2,547 COL/C \$2,710 D \$2,915 E \$3,125 F \$3,448 G \$3,792 H \$4,163 I \$4,739 J \$5,429 L1 \$4,231 L2 \$4,691				
		Dimensions	D	W	H																							
Overall	24	48	28 1/2																									
Seat	17	44	16 1/2																									
Upholstery	Shipping																											
COM Ydg	3 1/2	Ctn Wt 99																										
COL Sq Ft	77	Cu Ft 18																										
 <p>left shown</p>  <p>left</p>  <p>right</p>	BS722-120R BS722-120L <ul style="list-style-type: none"> plywood platform linking hardware COM based on single fabric multiple fabrics, see BS9 for yardage requirements square end links only to other units with a square end 120° angled end links only to other units with a 120° angled end 	<table border="1"> <thead> <tr> <th>Dimensions</th> <th>D</th> <th>W</th> <th>H</th> </tr> </thead> <tbody> <tr> <td>Overall</td> <td>24</td> <td>72</td> <td>28 1/2</td> </tr> <tr> <td>Seat</td> <td>17</td> <td>68</td> <td>16 1/2</td> </tr> </tbody> </table> <table border="1"> <thead> <tr> <th>Upholstery</th> <th colspan="2">Shipping</th> </tr> </thead> <tbody> <tr> <td>COM Ydg</td> <td>6 3/4</td> <td>Ctn Wt 133</td> </tr> <tr> <td>COL Sq Ft</td> <td>149</td> <td>Cu Ft 34</td> </tr> </tbody> </table>	Dimensions	D	W	H	Overall	24	72	28 1/2	Seat	17	68	16 1/2	Upholstery	Shipping		COM Ydg	6 3/4	Ctn Wt 133	COL Sq Ft	149	Cu Ft 34	COM \$3,566 A \$3,656 B \$3,833 COL/C \$4,145 D \$4,546 E \$4,945 F \$5,566 G \$6,235 H \$6,946 I \$8,057 J \$9,392 L1 \$7,080 L2 \$7,969				
		Dimensions	D	W	H																							
Overall	24	72	28 1/2																									
Seat	17	68	16 1/2																									
Upholstery	Shipping																											
COM Ydg	6 3/4	Ctn Wt 133																										
COL Sq Ft	149	Cu Ft 34																										
 <p>left shown</p>  <p>left</p>  <p>right</p>	BS502-120R BS502-120L <ul style="list-style-type: none"> bent ply shell linking hardware COM based on single fabric multiple fabrics, see BS9 for yardage requirements links only to other units with a 120° angled end, (cannot link to a square end) 	<table border="1"> <thead> <tr> <th>Dimensions</th> <th>D</th> <th>W</th> <th>H</th> </tr> </thead> <tbody> <tr> <td>Overall</td> <td>24</td> <td>49 3/4</td> <td>28 1/2</td> </tr> <tr> <td>Seat</td> <td>17</td> <td>39</td> <td>16 1/2</td> </tr> <tr> <td>Arm</td> <td></td> <td></td> <td>24 3/4</td> </tr> </tbody> </table> <table border="1"> <thead> <tr> <th>Upholstery</th> <th colspan="2">Shipping</th> </tr> </thead> <tbody> <tr> <td>COM Ydg</td> <td>4 1/2</td> <td>Ctn Wt 119</td> </tr> <tr> <td>COL Sq Ft</td> <td>99</td> <td>Cu Ft 24</td> </tr> </tbody> </table>	Dimensions	D	W	H	Overall	24	49 3/4	28 1/2	Seat	17	39	16 1/2	Arm			24 3/4	Upholstery	Shipping		COM Ydg	4 1/2	Ctn Wt 119	COL Sq Ft	99	Cu Ft 24	COM \$3,203 A \$3,265 B \$3,383 COL/C \$3,590 D \$3,857 E \$4,124 F \$4,538 G \$4,982 H \$5,457 I \$6,198 J \$7,087 L1 \$5,546 L2 \$6,139
		Dimensions	D	W	H																							
Overall	24	49 3/4	28 1/2																									
Seat	17	39	16 1/2																									
Arm			24 3/4																									
Upholstery	Shipping																											
COM Ydg	4 1/2	Ctn Wt 119																										
COL Sq Ft	99	Cu Ft 24																										
 <p>left shown</p>  <p>left</p>  <p>right</p>	BS742-120R BS742-120L <ul style="list-style-type: none"> bent ply shell linking hardware COM based on single fabric multiple fabrics, see BS9 for yardage requirements links only to other units with a 120° angled end, (cannot link to a square end) 	<table border="1"> <thead> <tr> <th>Dimensions</th> <th>D</th> <th>W</th> <th>H</th> </tr> </thead> <tbody> <tr> <td>Overall</td> <td>24</td> <td>73 3/4</td> <td>28 1/2</td> </tr> <tr> <td>Seat</td> <td>17</td> <td>63</td> <td>16 1/2</td> </tr> <tr> <td>Arm</td> <td></td> <td></td> <td>24 3/4</td> </tr> </tbody> </table> <table border="1"> <thead> <tr> <th>Upholstery</th> <th colspan="2">Shipping</th> </tr> </thead> <tbody> <tr> <td>COM Ydg</td> <td>7 3/4</td> <td>Ctn Wt 184</td> </tr> <tr> <td>COL Sq Ft</td> <td>171</td> <td>Cu Ft 34</td> </tr> </tbody> </table>	Dimensions	D	W	H	Overall	24	73 3/4	28 1/2	Seat	17	63	16 1/2	Arm			24 3/4	Upholstery	Shipping		COM Ydg	7 3/4	Ctn Wt 184	COL Sq Ft	171	Cu Ft 34	COM \$4,366 A \$4,468 B \$4,671 COL/C \$5,031 D \$5,490 E \$5,950 F \$6,664 G \$7,431 H \$8,248 I \$9,524 J \$11,054 L1 \$8,398 L2 \$9,419
		Dimensions	D	W	H																							
Overall	24	73 3/4	28 1/2																									
Seat	17	63	16 1/2																									
Arm			24 3/4																									
Upholstery	Shipping																											
COM Ydg	7 3/4	Ctn Wt 184																										
COL Sq Ft	171	Cu Ft 34																										

BeSPACE

Description	① Model	Specifications			List Price Per Grade	
48" Dual Angled Bench 	BS480-122 <ul style="list-style-type: none"> plywood platform linking hardware COM based on single fabric multiple fabrics, see BS9 for yardage requirements links only to other units with a 120° angled end, (cannot link to a square end) 	Dimensions	D	W	H	COM \$2,020
		Overall	24	48	16 1/2	A \$2,047
		Seat	24	48	16 1/2	B \$2,100
		Upholstery	Shipping			COL/C \$2,193
		COM Ydg	2	Ctn Wt	56	D \$2,311
		COL Sq Ft	44	Cu Ft	11	E \$2,428
						F \$2,613
						G \$2,813
						H \$3,022
						I \$3,352
						J \$3,748
						L1 \$3,061
						L2 \$3,332

72" Dual Angled Bench 	BS720-122 <ul style="list-style-type: none"> plywood platform linking hardware COM based on single fabric multiple fabrics, see BS9 for yardage requirements links only to other units with a 120° angled end, (cannot link to a square end) 	Dimensions	D	W	H	COM \$2,674
		Overall	24	72	16 1/2	A \$2,723
		Seat	24	72	16 1/2	B \$2,821
		Upholstery	Shipping			COL/C \$2,996
		COM Ydg	3 3/4	Ctn Wt	78	D \$3,218
		COL Sq Ft	83	Cu Ft	17	E \$3,438
						F \$3,786
						G \$4,156
						H \$4,550
						I \$5,170
						J \$5,909
						L1 \$4,624
						L2 \$5,117

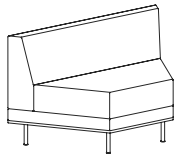

To Order, Specify:

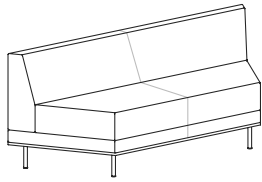
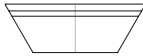
- ① Model Number
- ② Wood Species - Rift Cut White Oak (WK4) or Flat Cut Walnut (WA1)
- ③ Wood Finish See [Wood Finish Options](#)
- ④ Metal Leg Color See [Metal Leg Color Options](#)
- ⑤ Fabric Selection - Vendor, Pattern and Color
 - A. Seat
 - B. Back
 - C. Deck or Deck and Arm(s)

Visit www.jsifurniture.com/finishes-and-materials/textiles for our textiles program.
See selection of standard and graded in manufacturers and patterns.

Specifications:

- Wood species - Rift Cut White Oak or Flat Cut Walnut.
- 5/8" thick exterior plywood.
- Interior seating frame and support components are made from 3/4" interior grade plywood.
- Exterior feet and leg frames are fabricated from 14 gauge steel tubing.
- Modular seating units have a 3 1/2" high-resilience seat foam placed onto sheet webbing for comfort and durability.
- Modular back and arm foam is high density for comfort and durability.

Description	① Model	Specifications				List Price Per Grade	
48" Dual Angled Bench with Back  	BS482-122 · plywood platform · linking hardware · COM based on single fabric · multiple fabrics, see BS9 for yardage requirements · links only to other units with a 120° angled end, (cannot link to a square end)	Dimensions		D	W	H	COM \$2,408
		Overall	24	48	28 1/2		
		Seat	17	40	16 1/2		B \$2,547
		Upholstery		Shipping			COL/C \$2,710
		COM Ydg	3 1/2	Ctn Wt	96		D \$2,915
		COL Sq Ft	77	Cu Ft	18		E \$3,125
							F \$3,448
							G \$3,792
							H \$4,163
							I \$4,739
							J \$5,429
							L1 \$4,231
							L2 \$4,691

72" Dual Angled Bench with Back  	BS722-122 · plywood platform · linking hardware · COM based on single fabric · multiple fabrics, see BS9 for yardage requirements · links only to other units with a 120° angled end, (cannot link to a square end)	Dimensions		D	W	H	COM \$3,534
		Overall	24	72	28 1/2		
		Seat	17	64	16 1/2		B \$3,803
		Upholstery		Shipping			COL/C \$4,113
		COM Ydg	6 3/4	Ctn Wt	129		D \$4,514
		COL Sq Ft	149	Cu Ft	34		E \$4,915
							F \$5,537
							G \$6,202
							H \$6,913
							I \$8,026
							J \$9,362
							L1 \$7,047
							L2 \$7,938

BeSPACE

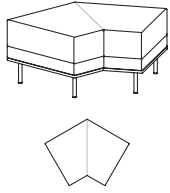
Description

1 Model

Specifications

List Price Per Grade

120° Connecting Bench



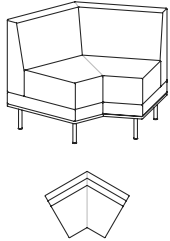
BS240-122

- plywood platform
- linking hardware
- COM based on single fabric
- multiple fabrics, see [BS9](#) for yardage requirements
- links only to other units with a square end, (cannot link to a 120° angled end)
- allows flat end modular units to complete 120° turn

Dimensions	D	W	H
Overall	32 1/2	41 1/4	16 1/2
Seat	24	41 1/4	16 1/2
Upholstery		Shipping	
COM Ydg	2 1/2	Ctn Wt	65
COL Sq Ft	50	Cu Ft	12

COM	\$1,953
A	\$1,986
B	\$2,052
COL/C	\$2,168
D	\$2,315
E	\$2,462
F	\$2,692
G	\$2,942
H	\$3,206
I	\$3,617
J	\$4,111
L1	\$3,124
L2	\$3,419

120° Connecting Bench with Back



BS242-122

- plywood platform
- linking hardware
- COM based on single fabric
- multiple fabrics, see [BS9](#) for yardage requirements
- links only to other units with a square end, (cannot link to a 120° angled end)
- allows flat end modular units to complete 120° turn

Dimensions	D	W	H
Overall	32 1/2	41 1/4	28 1/2
Seat	17	35	16 1/2
Upholstery		Shipping	
COM Ydg	4 1/2	Ctn Wt	102
COL Sq Ft	90	Cu Ft	20

COM	\$2,588
A	\$2,647
B	\$2,764
COL/C	\$2,973
D	\$3,238
E	\$3,505
F	\$3,921
G	\$4,366
H	\$4,838
I	\$5,582
J	\$6,469
L1	\$4,692
L2	\$5,224

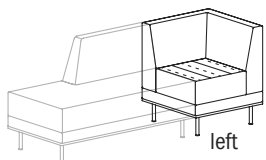
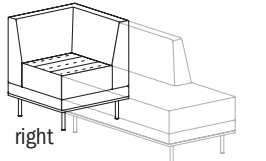
To Order, Specify:

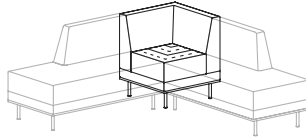
- 1 Model Number
- 2 Wood Species - Rift Cut White Oak (WK4) or Flat Cut Walnut (WA1)
- 3 Wood Finish See [Wood Finish Options](#)
- 4 Metal Leg Color See [Metal Leg Color Options](#)
- 5 Fabric Selection - Vendor, Pattern and Color
 - A. Seat
 - B. Back
 - C. Deck or Deck and Arm(s)

Visit www.jsifurniture.com/finishes-and-materials/textiles for our textiles program.
See selection of standard and graded in manufacturers and patterns.


Specifications:


- Wood species - Rift Cut White Oak or Flat Cut Walnut.
- 5/8" thick exterior plywood.
- Interior seating frame and support components are made from 3/4" interior grade plywood.
- Exterior feet and leg frames are fabricated from 14 gauge steel tubing.
- Modular seating units have a 3 1/2" high-resilience seat foam placed onto sheet webbing for comfort and durability.
- Modular back and arm foam is high density for comfort and durability.

Description	Model	Specifications			List Price Per Grade												
Corner Bench with Back  left  right	BS242R BS242L <ul style="list-style-type: none"> · plywood platform · linking hardware · COM based on single fabric · multiple fabrics, see BS9 for yardage requirements · links only to other units with a square end, (cannot link to a 120° angled end) 	<table border="1"> <thead> <tr> <th>Dimensions</th> <th>D</th> <th>W</th> <th>H</th> </tr> </thead> <tbody> <tr> <td>Overall</td> <td>24</td> <td>24</td> <td>28 1/2</td> </tr> <tr> <td>Seat</td> <td>17</td> <td>17</td> <td>16 1/2</td> </tr> </tbody> </table>			Dimensions	D	W	H	Overall	24	24	28 1/2	Seat	17	17	16 1/2	COM \$2,068 A \$2,112 B \$2,197 COL/C \$2,347 D \$2,539 E \$2,734 F \$3,031 G \$3,354 H \$3,697 I \$4,233 J \$4,873 L1 \$3,590 L2 \$3,975
		Dimensions	D	W	H												
Overall	24	24	28 1/2														
Seat	17	17	16 1/2														
<table border="1"> <thead> <tr> <th>Upholstery</th> <th colspan="2">Shipping</th> </tr> </thead> <tbody> <tr> <td>COM Ydg</td> <td>3 1/4</td> <td>Ctn Wt 75</td> </tr> <tr> <td>COL Sq Ft</td> <td>65</td> <td>Cu Ft 11</td> </tr> </tbody> </table>			Upholstery	Shipping		COM Ydg	3 1/4	Ctn Wt 75	COL Sq Ft	65	Cu Ft 11						
Upholstery	Shipping																
COM Ydg	3 1/4	Ctn Wt 75															
COL Sq Ft	65	Cu Ft 11															

Description	Model	Specifications			List Price Per Grade												
Corner Bench with Back 	BS242C <ul style="list-style-type: none"> · plywood platform · linking hardware · diagonal seam · COM based on single fabric · multiple fabrics, see BS9 for yardage requirements · links only to other units with a square end, (cannot link to a 120° angled end) 	<table border="1"> <thead> <tr> <th>Dimensions</th> <th>D</th> <th>W</th> <th>H</th> </tr> </thead> <tbody> <tr> <td>Overall</td> <td>24</td> <td>24</td> <td>28 1/2</td> </tr> <tr> <td>Seat</td> <td>17</td> <td>17</td> <td>16 1/2</td> </tr> </tbody> </table>			Dimensions	D	W	H	Overall	24	24	28 1/2	Seat	17	17	16 1/2	COM \$2,068 A \$2,112 B \$2,197 COL/C \$2,347 D \$2,539 E \$2,734 F \$3,031 G \$3,354 H \$3,697 I \$4,233 J \$4,873 L1 \$3,590 L2 \$3,975
		Dimensions	D	W	H												
Overall	24	24	28 1/2														
Seat	17	17	16 1/2														
<table border="1"> <thead> <tr> <th>Upholstery</th> <th colspan="2">Shipping</th> </tr> </thead> <tbody> <tr> <td>COM Ydg</td> <td>3 1/4</td> <td>Ctn Wt 75</td> </tr> <tr> <td>COL Sq Ft</td> <td>65</td> <td>Cu Ft 11</td> </tr> </tbody> </table>			Upholstery	Shipping		COM Ydg	3 1/4	Ctn Wt 75	COL Sq Ft	65	Cu Ft 11						
Upholstery	Shipping																
COM Ydg	3 1/4	Ctn Wt 75															
COL Sq Ft	65	Cu Ft 11															

BeSPACE

Description	① Model	Specifications			List Price Per Grade	
Upholstered Pod 	BS140 <ul style="list-style-type: none"> plywood platform nylon glides COM based on single fabric multiple fabrics, see BS9 for yardage requirements casters not available 	Dimensions	D	W	H	COM \$886
		Overall	13 1/2	13 1/2	18	A \$907
		Seat	13 1/2	13 1/2	18	B \$943
		Upholstery	Shipping			COL/C \$1,014
		COM Ydg	1 1/2	Ctn Wt	22	D \$1,102
		COL Sq Ft	27	Cu Ft	3	E \$1,192
						F \$1,332
						G \$1,478
						H \$1,636
						I \$1,883
						J \$2,180
						L1 \$1,586
						L2 \$1,768

Description	① Model	Specifications			List Price Per Grade	
Upholstered Table 	BS140W <ul style="list-style-type: none"> plywood top plywood platform nylon glides COM based on single fabric multiple fabrics, see BS9 for yardage requirements casters not available 	Dimensions	D	W	H	COM \$974
		Overall	13 1/2	13 1/2	21 1/4	A \$996
		Upholstery	Shipping			B \$1,034
		COM Ydg	1 1/2	Ctn Wt	25	COL/C \$1,102
		COL Sq Ft	27	Cu Ft	3	D \$1,192
						E \$1,282
						F \$1,419
						G \$1,568
						H \$1,728
						I \$1,972
						J \$2,269
						L1 \$1,676
						L2 \$1,855

To Order, Specify:

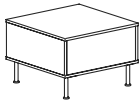
- ① Model Number
 - ② Wood Species - Rift Cut White Oak (WK4) or Flat Cut Walnut (WA1)
 - ③ Wood Finish [See Wood Finish Options](#)
 - ④ Metal Leg Color [See Metal Leg Color Options](#)
 - ⑤ Fabric Selection - Vendor, Pattern and Color
 - A. Seat
 - B. Back
 - C. Deck or Deck and Arm(s)
- Visit www.jsifurniture.com/finishes-and-materials/textiles for our textiles program.
See selection of standard and graded in manufacturers and patterns.

Specifications:

- Wood species - Rift Cut White Oak or Flat Cut Walnut.
- 5/8" thick exterior plywood.
- Interior seating frame and support components are made from 3/4" interior grade plywood.
- Exterior feet and leg frames are fabricated from 14 gauge steel tubing.
- Modular seating units have a 3 1/2" high-resilience seat foam placed onto sheet webbing for comfort and durability.
- Modular back and arm foam is high density for comfort and durability.

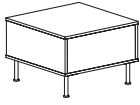
Modular

Description	D	W	H	CTN WT	CU FT	Model	List Price
Square Table	24	24	16 1/4	40	5	BS2424SCT	\$1,227



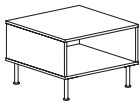
- straight grain top
- no opening
- linking hardware
- power center (EC22) available on front and/or back panel, specify and add \$583 list each

Square Corner Table	24	24	16 1/4	40	5	BS2424DCT	\$1,303
---------------------	----	----	--------	----	---	-----------	---------



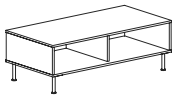
- diagonal grain top
- no opening
- for corner installation
- linking hardware
- power center (EC22) available on back panel(s), specify and add \$583 list each

Open Square Table	24	24	16 1/4	40	5	BS2424OCT	\$1,173
-------------------	----	----	--------	----	---	-----------	---------



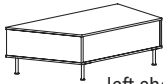
- straight grain top
- open front
- linking hardware

Coffee Table	24	48	16 1/4	60	9	BS2448OCT	\$1,455
--------------	----	----	--------	----	---	-----------	---------

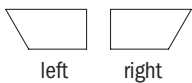


- straight grain top
- open front
- linking hardware

48" Single Angled Table	24	48	16 1/4	60	9	BS2448SCTR	\$1,570
-------------------------	----	----	--------	----	---	------------	---------



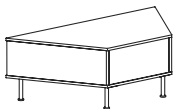
left shown



left right

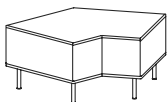
- one square end, one 120° angled end
- no opening
- linking hardware
- power center (EC22) available on front and/or back panel, specify and add \$583 list each
- square end links only to other square end units
- 120° angled end links only to other 120° angled end units

48" Dual Angled Corner Table	24	48	16 1/4	60	9	BS2448DCT	\$1,500
------------------------------	----	----	--------	----	---	-----------	---------





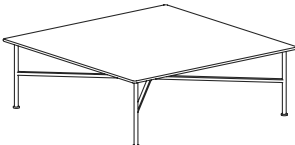

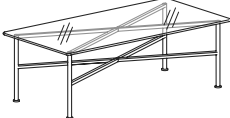
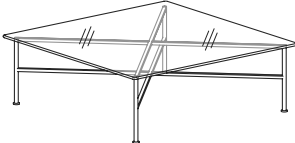
- two 120° angled ends
- no opening
- linking hardware
- power center (EC22) available on front and/or back panel, specify and add \$583 list each
- 120° angled ends link only to other 120° angled end units

120° Connecting Table	36	36	16 1/4	50	9	BS3636-12OCT	\$1,686
-----------------------	----	----	--------	----	---	--------------	---------



- diagonal grain top
- no opening
- linking hardware
- power center (EC22) available on front and back panel(s), specify and add \$583 list each
- optional EC22 on non-linking sides
- square ends link only to other square end units (cannot link to 120° angled ends)

Freestanding

Description	D	W	H	CTN WT	CU FT	① Model	List Price
Side Wood Table  <ul style="list-style-type: none"> • 5/8" thick plywood top • metal frame 	20	20	16 1/4	25	5	BS2020WTT	\$3,394
Rectangular Wood Coffee Table  <ul style="list-style-type: none"> • 5/8" thick plywood top • metal frame 	24	48	16 1/4	35	14	BS2448WTT	\$3,571
Square Wood Coffee Table  <ul style="list-style-type: none"> • 5/8" thick plywood top • metal frame 	48	48	16 1/4	55	26	BS4848WTT	\$3,726
Glass Side Table  <ul style="list-style-type: none"> • 1/2" thick tempered glass top • metal frame 	20	20	16 1/4	30	5	BS2020GTT	\$3,438
Rectangular Glass Coffee Table  <ul style="list-style-type: none"> • 1/2" thick tempered glass top • metal frame 	24	48	16 1/4	40	14	BS2448GTT	\$3,686
Square Glass Coffee Table  <ul style="list-style-type: none"> • 1/2" thick tempered glass top • metal frame 	48	48	16 1/4	60	26	BS4848GTT	\$3,997

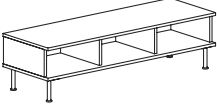
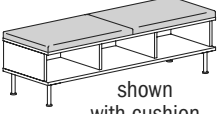
To Order, Specify:

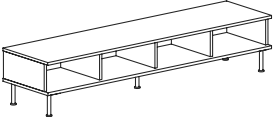
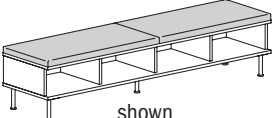
- ① Model Number
- ② Wood Species - Rift Cut White Oak (WK4) or Flat Cut Walnut (WA1)
- ③ Wood Finish [See Wood Finish Options](#)
- ④ Glass Color - Clear (GTC01) or Smoke (GTC04)
- ⑤ Metal Leg Color [See Metal Leg Color Options](#)
- ⑥ Optional Power Center ([see page BS5](#))

Specifications:

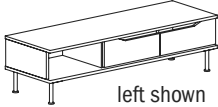
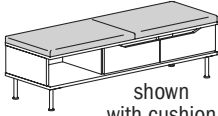
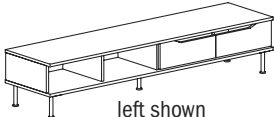
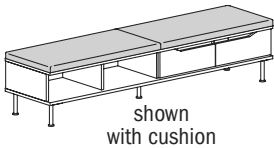
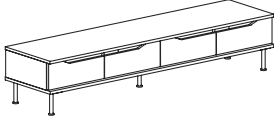
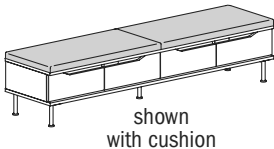
- Wood species - Rift Cut White Oak or Flat Cut Walnut.
- Linking Tables have 3/4" thick plywood tops
- Exterior feet and leg frames are fabricated from 14 gauge steel tubing and 14 gauge flat stock.

Modular

Description	D	W	H	CTN WT	CU FT	① Model	List Price No Cushion	List Price With Cushion
Bench Height Credenza Open Storage	18	54	14 1/2	80	7	BS1854-16SOS	\$1,769	COM \$2,308
  shown with cushion	<ul style="list-style-type: none"> · three open sections · linking hardware · optional attached 1 1/2" thick cushion · interior dividers have a wire pass thru · rectangular back center grommet available, specify and add \$105 list · 24" wire manager included for field installation · com ydg: 1 1/2 							A \$2,328 B \$2,367 COL/C \$2,437 D \$2,526 E \$2,614 F \$2,754 G \$2,900 H \$3,058 I \$3,307 J \$3,604 L1 \$3,010 L2 \$3,187

Bench Height Credenza Open Storage	18	72	14 1/2	90	9	BS1872-16SOS	\$2,109	COM \$2,792
  shown with cushion	<ul style="list-style-type: none"> · four open sections · linking hardware · optional attached 1 1/2" thick cushion · interior dividers have a wire pass thru · rectangular back center grommet available, specify and add \$105 list · 24" wire manager included for field installation · com ydg: 1 3/4 							A \$2,816 B \$2,860 COL/C \$2,942 D \$3,047 E \$3,150 F \$3,311 G \$3,484 H \$3,670 I \$3,956 J \$4,300 L1 \$3,612 L2 \$3,818

BeSPACE

Description	D	W	H	CTN WT	CU FT	① Model	List Price No Cushion	List Price With Cushion
Bench Height Credenza with Drawers	18	54	14 1/2	100	7	BS1854-16SDWR	\$2,095	COM \$2,636
	18	54	14 1/2	100	7	BS1854-16SDWL	\$2,095	A \$2,656 B \$2,694 COL/C \$2,764 D \$2,854 E \$2,944 F \$3,082 G \$3,227 H \$3,388 I \$3,635 J \$3,931 L1 \$3,338 L2 \$3,518
 left shown  shown with cushion	<ul style="list-style-type: none"> • one open section, two drawers • linking hardware • optional attached 1 1/2" thick cushion • interior dividers have a wire pass thru • rectangular back center grommet available, specify and add \$105 list • 24" wire manager included for field installation • com ydg: 1 1/2 							
Bench Height Credenza with Drawers	18	72	14 1/2	100	9	BS1872-16SDWR	\$2,414	COM \$3,096
	18	72	14 1/2	100	9	BS1872-16SDWL	\$2,414	A \$3,122 B \$3,165 COL/C \$3,247 D \$3,351 E \$3,455 F \$3,616 G \$3,789 H \$3,974 I \$4,260 J \$4,606 L1 \$3,917 L2 \$4,123
 left shown  shown with cushion	<ul style="list-style-type: none"> • two open sections, two drawers • linking hardware • optional attached 1 1/2" thick cushion • interior dividers have a wire pass thru • rectangular back center grommet available, specify and add \$105 list • 24" wire manager included for field installation • com ydg: 1 3/4 							
Bench Height Credenza with Drawers	18	72	14 1/2	120	9	BS1872-16SFS	\$2,739	COM \$3,422
								A \$3,447 B \$3,492 COL/C \$3,571 D \$3,676 E \$3,782 F \$3,941 G \$4,113 H \$4,298 I \$4,584 J \$4,933 L1 \$4,241 L2 \$4,446
 left shown  shown with cushion	<ul style="list-style-type: none"> • four drawers • linking hardware • optional attached 1 1/2" thick cushion • interior dividers have a wire pass thru • rectangular back center grommet available, specify and add \$105 list • 24" wire manager included for field installation • com ydg: 1 3/4 							

To Order, Specify:

- ① Model Number
- ② Wood Species - Rift Cut White Oak (WK4) or Flat Cut Walnut (WA1)
- ③ Wood Finish [See Wood Finish Options](#)
- ④ Drawer Front Optional Paint Color [See Paint Color Options](#)
- ⑤ Metal Leg Color [See Metal Leg Color Options](#)
- ⑥ Fabric Selection - Vendor, Pattern and Color

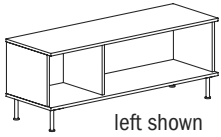
Visit www.jsifurniture.com/finishes-and-materials/textiles for our textiles program.
See selection of standard and graded in manufacturers and patterns.

Specifications:

- Wood species - Rift Cut White Oak or Flat Cut Walnut.
- 3/4" thick plywood tops
- Exterior feet and leg frames are fabricated from 14 gauge steel tubing and 14 gauge flat stock.

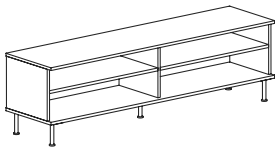
Modular

Description	D	W	H	CTN WT	CU FT	Model	List Price
Low Height Credenza Open Storage	18	54	20	120	11	BS1854-20SOSR	\$1,840
	18	54	20	120	11	BS1854-20SOSL	\$1,840



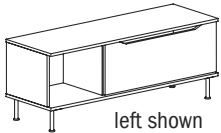
- open cabinet
- linking hardware
- interior dividers have a wire pass thru
- rectangular back center grommet available, specify and add \$105 list
- 24" wire manager included for field installation

Low Height Credenza Open Storage	18	72	20	110	15	BS1872-20SOS	\$2,382
-------------------------------------	----	----	----	-----	----	--------------	---------



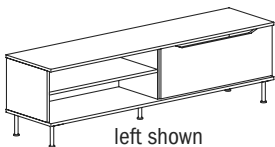
- two fixed shelves
- linking hardware
- interior dividers have a wire pass thru
- rectangular back center grommet available, specify and add \$105 list
- 24" wire manager included for field installation

Low Height Credenza with Drawer	18	54	20	140	11	BS1854-20SDWR	\$2,121
	18	54	20	140	11	BS1854-20SDWL	\$2,121



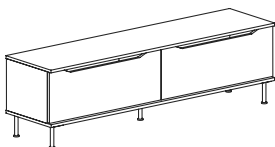
- one open cabinet, one storage drawer
- linking hardware
- interior dividers have a wire pass thru
- rectangular back center grommet available, specify and add \$105 list
- 24" wire manager included for field installation

Low Height Credenza with Drawer	18	72	20	130	15	BS1872-20SDWR	\$2,549
	18	72	20	130	15	BS1872-20SDWL	\$2,549



- one open cabinet with one fixed shelf, one storage drawer
- linking hardware
- interior dividers have a wire pass thru
- rectangular back center grommet available, specify and add \$105 list
- 24" wire manager included for field installation

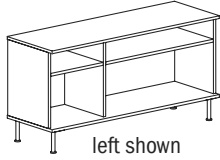
Low Height Credenza with Two Drawers	18	72	20	150	15	BS1872-20SFS	\$2,706
---	----	----	----	-----	----	--------------	---------



- two storage drawers
- linking hardware
- interior dividers have a wire pass thru
- rectangular back center grommet available, specify and add \$105 list
- 24" wire manager included for field installation

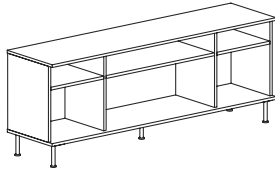
Modular

Description	D	W	H	CTN WT	CU FT	① Model	List Price
Standard Height Credenza	18	54	27	130	15	BS1854-27SOSR	\$2,167
Open Storage	18	54	27	130	15	BS1854-27SOSL	\$2,167



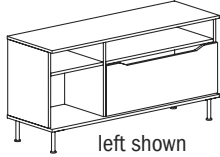
- open cabinet, two fixed shelves
- linking hardware
- interior dividers have a wire pass thru
- rectangular back center grommet available, specify and add \$105 list
- 24" wire manager included for field installation

Standard Height Credenza	18	72	27	130	20	BS1872-27SOS	\$2,648
Open Storage							



- open cabinet, three fixed shelves
- linking hardware
- interior dividers have a wire pass thru
- rectangular back center grommet available, specify and add \$105 list
- 24" wire manager included for field installation

Standard Height Credenza	18	54	27	140	15	BS1854-27SDWR	\$2,452
with Drawer	18	54	27	140	15	BS1854-27SDWL	\$2,452



- open cabinet with fixed shelf, storage drawer with open compartment
- linking hardware
- interior dividers have a wire pass thru
- rectangular back center grommet available, specify and add \$105 list
- 24" wire manager included for field installation

To Order, Specify:

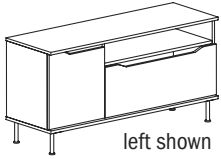
- ① Model Number
- ② Wood Species - Rift Cut White Oak (WK4) or Flat Cut Walnut (WA1)
- ③ Wood Finish [See Wood Finish Options](#)
- ④ Drawer Front Optional Paint Color [See Paint Color Options](#)
- ⑤ Metal Leg Color [See Metal Leg Color Options](#)

Specifications:

- Wood species - Rift Cut White Oak or Flat Cut Walnut.
- 3/4" thick plywood tops
- Exterior feet and leg frames are fabricated from 14 gauge steel tubing and 14 gauge flat stock.

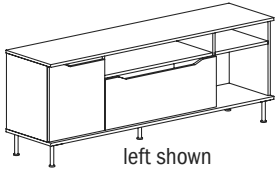
Modular

Description	D	W	H	CTN WT	CU FT	Model	List Price
Standard Height Storage Credenza	18	54	27	150	15	BS1854-27SFSR	\$2,564
	18	54	27	150	15	BS1854-27SFSL	\$2,564



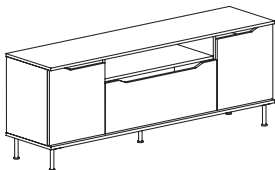
- one door with fixed shelf, storage drawer with open compartment
- linking hardware
- interior dividers have a wire pass thru
- rectangular back center grommet available, specify and add \$105 list
- 24" wire manager included for field installation

Standard Height Storage Credenza	18	72	27	160	20	BS1872-27SSR	\$3,129
	18	72	27	160	20	BS1872-27SSL	\$3,129



- one door with fixed shelf, storage drawer with open compartment
- open storage one fixed shelf
- linking hardware
- interior dividers have a wire pass thru
- rectangular back center grommet available, specify and add \$105 list
- 24" wire manager included for field installation

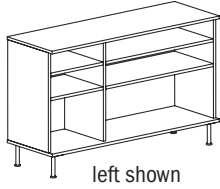
Standard Height Storage Credenza	18	72	27	170	20	BS1872-27SFS	\$3,226
-------------------------------------	----	----	----	-----	----	---------------------	----------------



- one door with fixed shelf, one drawer with open compartment, one door with fixed shelf
- linking hardware
- interior dividers have a wire pass thru
- rectangular back center grommet available, specify and add \$105 list
- 24" wire manager included for field installation

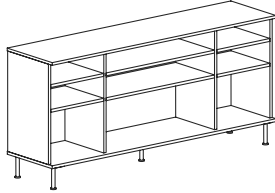
BeSPACE

Description	D	W	H	CTN WT	CU FT	① Model	List Price
Tall Credenza Open Storage	18	54	33	140	19	BS1854-33S0SR	\$2,497
	18	54	33	140	19	BS1854-33S0SL	\$2,497



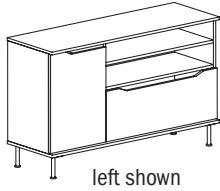
- open cabinet, four fixed shelves
- linking hardware
- interior dividers have a wire pass thru
- rectangular back center grommet available, specify and add \$105 list
- 24" wire manager included for field installation

Tall Credenza Open Storage	18	72	33	140	25	BS1872-33S0S	\$2,898
----------------------------	----	----	----	-----	----	---------------------	---------



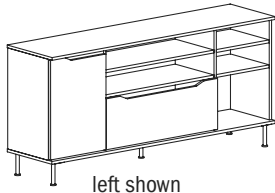
- open cabinet, six fixed shelves
- linking hardware
- interior dividers have a wire pass thru
- rectangular back center grommet available, specify and add \$105 list
- 24" wire manager included for field installation

Tall Storage Credenza	18	54	33	160	19	BS1854-33SFSR	\$2,917
	18	54	33	160	19	BS1854-33SFL	\$2,917



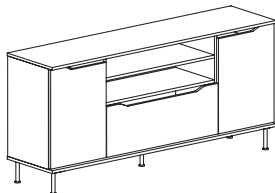
- one door with two fixed shelves, one storage drawer with two open compartments
- linking hardware
- interior dividers have a wire pass thru
- rectangular back center grommet available, specify and add \$105 list
- 24" wire manager included for field installation

Tall Storage Credenza	18	72	33	170	25	BS1872-33SSR	\$3,311
	18	72	33	170	25	BS1872-33SSL	\$3,311



- one door with two fixed shelves, one storage drawer with two open compartments, one cabinet with two fixed shelves
- linking hardware
- interior dividers have a wire pass thru
- rectangular back center grommet available, specify and add \$105 list
- 24" wire manager included for field installation

Tall Storage Credenza	18	72	33	180	25	BS1872-33SFS	\$3,441
-----------------------	----	----	----	-----	----	---------------------	---------



- one door with two fixed shelves, one storage drawer with two open compartments, one door with two fixed shelves
- linking hardware
- interior dividers have a wire pass thru
- rectangular back center grommet available, specify and add \$105 list
- 24" wire manager included for field installation

To Order, Specify:

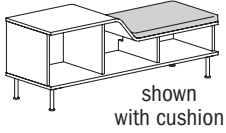
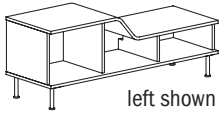
- ① Model Number
- ② Wood Species - Rift Cut White Oak (WK4) or Flat Cut Walnut (WA1)
- ③ Wood Finish [See Wood Finish Options](#)
- ④ Drawer Front Optional Paint Color [See Paint Color Options](#)
- ⑤ Metal Leg Color [See Metal Leg Color Options](#)

Specifications:

- Wood species - Rift Cut White Oak or Flat Cut Walnut.
- 3/4" thick plywood tops
- Exterior feet and leg frames are fabricated from 14 gauge steel tubing and 14 gauge flat stock.

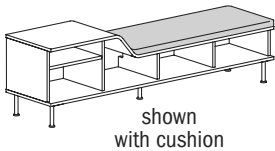
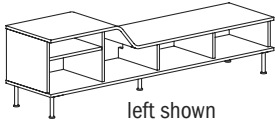
Modular

Description	D	W	H	CTN WT	CU FT	Model	List Price No Cushion	List Price With Cushion
Low Height Transition Credenza Open Storage	18	54	14 1/2 / 20	110	11	BS1854-20TOSR	\$2,736	COM \$3,185
	18	54	14 1/2 / 20	110	11	BS1854-20TOSL	\$2,736	A \$3,197
								B \$3,214
								COL/C \$3,250
								D \$3,295
								E \$3,339
								F \$3,411
								G \$3,483
								H \$3,562
								I \$3,683
								J \$3,833
								L1 \$3,535
								L2 \$3,625



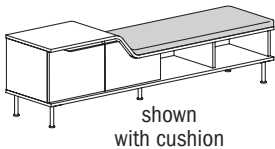
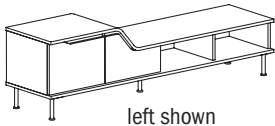
- open cabinet
- bent ply top
- linking hardware
- optional attached 1 1/2" thick cushion
- interior dividers have a wire pass thru
- two rectangular back center grommets available, specify and add \$204 list
- 24" wire manager included for field installation
- com ydg: 3/4

Low Height Transition Credenza Open Storage	18	72	14 1/2 / 20	120	15	BS1872-20TOSR	\$3,014	COM \$3,679
	18	72	14 1/2 / 20	120	15	BS1872-20TOSL	\$3,014	A \$3,697
								B \$3,727
								COL/C \$3,788
								D \$3,863
								E \$3,934
								F \$4,050
								G \$4,174
								H \$4,305
								I \$4,512
								J \$4,759
								L1 \$4,263
								L2 \$4,412

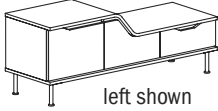
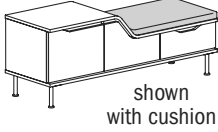
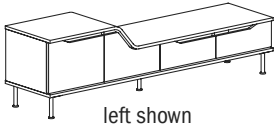
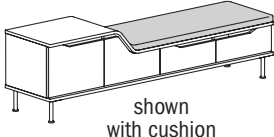
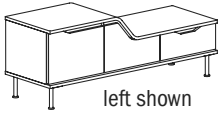
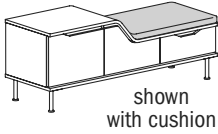


- open cabinet, one fixed shelf
- bent ply top
- linking hardware
- optional attached 1 1/2" thick cushion
- interior dividers have a wire pass thru
- two rectangular back center grommets available, specify and add \$204 list
- 24" wire manager included for field installation
- com ydg: 1 1/4

Low Height Transition Storage Credenza	18	72	14 1/2 / 20	110	15	BS1872-20TSR	\$3,355	COM \$4,021
	18	72	14 1/2 / 20	110	15	BS1872-20TSL	\$3,355	A \$4,037
								B \$4,069
								COL/C \$4,128
								D \$4,204
								E \$4,277
								F \$4,391
								G \$4,515
								H \$4,647
								I \$4,852
								J \$5,100
								L1 \$4,606
								L2 \$4,752



- two drawers, open cabinet
- bent ply top
- linking hardware
- optional attached 1 1/2" thick cushion
- interior dividers have a wire pass thru
- two rectangular back center grommets available, specify and add \$204 list
- 24" wire manager included for field installation
- com ydg: 1 1/4

Description	D	W	H	CTN WT	CU FT	① Model	List Price No Cushion	List Price With Cushion	
Low Height Transition Storage Credenza	18	54	14 1/2 / 20	120	11	BS1854-20TFSR	\$3,275	COM \$3,724	
	18	54	14 1/2 / 20	120	11	BS1854-20TFSL	\$3,275	A \$3,737	
 left shown	<ul style="list-style-type: none"> • three drawers • bent ply top • linking hardware • optional attached 1 1/2" thick cushion • interior dividers have a wire pass thru • two rectangular back center grommets available, specify and add \$204 list • 24" wire manager included for field installation • com ydg: 3/4 								B \$3,756
									COL/C \$3,791
 shown with cushion									D \$3,834
									E \$3,879
								F \$3,951	
								G \$4,023	
								H \$4,103	
								I \$4,226	
								J \$4,373	
								L1 \$4,076	
								L2 \$4,166	
								Low Height Transition Storage Credenza	
18	72	14 1/2 / 20	130	15	BS1872-20TFSR	\$3,574	A \$4,256		
 left shown	<ul style="list-style-type: none"> • four drawers • bent ply top • linking hardware • optional attached 1 1/2" thick cushion • interior dividers have a wire pass thru • two rectangular back center grommets available, specify and add \$204 list • 24" wire manager included for field installation • com ydg: 1 1/4 								B \$4,290
									COL/C \$4,348
 shown with cushion									D \$4,424
									E \$4,496
								F \$4,611	
								G \$4,736	
								H \$4,868	
								I \$5,071	
								J \$5,320	
								L1 \$4,826	
								L2 \$4,972	
								Low Height Transition Storage Credenza	
18	54	14 1/2 / 20	130	11	BS1854-20TDSR	\$3,321	A \$3,785		
 left shown	<ul style="list-style-type: none"> • one door with fixed shelf, two drawers • bent ply top • linking hardware • optional attached 1 1/2" thick cushion • interior dividers have a wire pass thru • two rectangular back center grommets available, specify and add \$204 list • 24" wire manager included for field installation • com ydg: 3/4 								B \$3,803
									COL/C \$3,836
 shown with cushion									D \$3,882
									E \$3,927
								F \$3,995	
								G \$4,069	
								H \$4,149	
								I \$4,273	
								J \$4,422	
								L1 \$4,124	
								L2 \$4,212	

To Order, Specify:

- ① Model Number
- ② Wood Species - Rift Cut White Oak (WK4) or Flat Cut Walnut (WA1)
- ③ Wood Finish [See Wood Finish Options](#)
- ④ Door and Drawer Front Optional Paint Color [See Paint Color Options](#)
- ⑤ Metal Leg Color [See Metal Leg Color Options](#)
- ⑥ Fabric Selection - Vendor, Pattern and Color

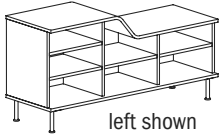
Visit www.jsifurniture.com/finishes-and-materials/textiles for our textiles program.
See selection of standard and graded in manufacturers and patterns.

Specifications:

- Wood species - Rift Cut White Oak or Flat Cut Walnut.
- 3/4" thick plywood tops
- Exterior feet and leg frames are fabricated from 14 gauge steel tubing and 14 gauge flat stock.

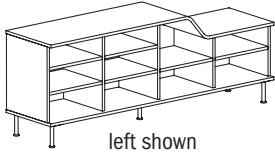
Modular

Description	D	W	H	CTN WT	CU FT	Model	List Price
Standard Height Transition Credenza Open Storage	18	54	20 / 27	120	15	BS1854-27TOSR	\$3,298
	18	54	20 / 27	120	15	BS1854-27TOSL	\$3,298



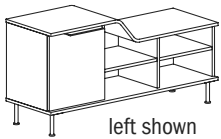
- open cabinet, four fixed shelves
- bent ply top
- linking hardware
- interior dividers have a wire pass thru
- two rectangular back center grommets available, specify and add \$204 list
- 24" wire manager included for field installation

Standard Height Transition Credenza Open Storage	18	72	20 / 27	130	20	BS1872-27TOSR	\$3,491
	18	72	20 / 27	130	20	BS1872-27TOSL	\$3,491



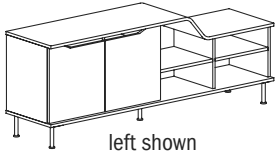
- open cabinet, six fixed shelves
- bent ply top
- linking hardware
- interior dividers have a wire pass thru
- two rectangular back center grommets available, specify and add \$204 list
- 24" wire manager included for field installation

Standard Height Transition Credenza	18	54	20 / 27	130	15	BS1854-27THDR	\$3,405
	18	54	20 / 27	130	15	BS1854-27THDL	\$3,405



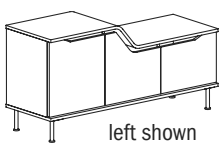
- one door with two fixed shelves, open cabinet with two fixed shelves
- bent ply top
- linking hardware
- interior dividers have a wire pass thru
- two rectangular back center grommets available, specify and add \$204 list
- 24" wire manager included for field installation

Standard Height Transition Credenza Open Storage	18	72	20 / 27	140	20	BS1872-27TSR	\$3,707
	18	72	20 / 27	140	20	BS1872-27TSL	\$3,707



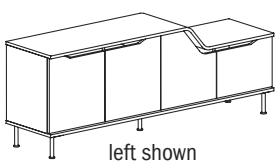
- two doors with two fixed shelves, open cabinets with two fixed shelves
- bent ply top
- linking hardware
- interior dividers have a wire pass thru
- two rectangular back center grommets available, specify and add \$204 list
- 24" wire manager included for field installation

Standard Height Transition Credenza Full Storage	18	54	20 / 27	140	15	BS1854-27TFSR	\$3,654
	18	54	20 / 27	140	15	BS1854-27TFSL	\$3,654



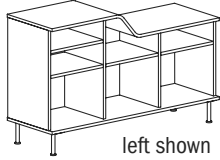
- one door with two fixed shelves, two drawers
- bent ply top
- linking hardware
- interior dividers have a wire pass thru
- two rectangular back center grommets available, specify and add \$204 list
- 24" wire manager included for field installation

Standard Height Transition Credenza Full Storage	18	72	20 / 27	160	20	BS1872-27TFSR	\$4,132
	18	72	20 / 27	160	20	BS1872-27TFSL	\$4,132



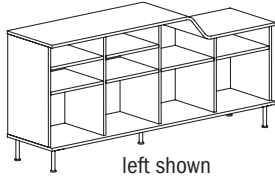
- two doors with two fixed shelves, two drawers
- bent ply top
- linking hardware
- interior dividers have a wire pass thru
- two rectangular back center grommets available, specify and add \$204 list
- 24" wire manager included for field installation

Description	D	W	H	CTN WT	CU FT	① Model	List Price
Tall Transition Credenza	18	54	27 / 33	130	19	BS1854-33TOSR	\$3,416
Open Storage	18	54	27 / 33	130	19	BS1854-33TOSL	\$3,416



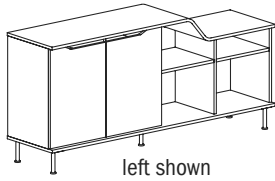
- open cabinet, four fixed shelves
- bent ply top
- linking hardware
- interior dividers have a wire pass thru
- two rectangular back center grommets available, specify and add \$204 list
- 24" wire manager included for field installation

Tall Transition Credenza	18	72	27 / 33	140	25	BS1872-33TOSR	\$3,722
Open Storage	18	72	27 / 33	140	25	BS1872-33TOSL	\$3,722



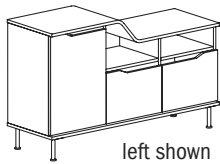
- open cabinet, six fixed shelves
- bent ply top
- linking hardware
- interior dividers have a wire pass thru
- two rectangular back center grommets available, specify and add \$204 list
- 24" wire manager included for field installation

Tall Transition Storage Credenza	18	72	27 / 33	150	25	BS1872-33TSR	\$3,984
	18	72	27 / 33	150	25	BS1872-33TSL	\$3,984



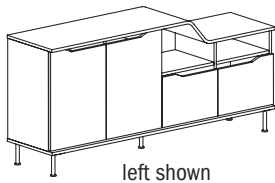
- two doors with two fixed shelves,
- open cabinet with two fixed shelves
- bent ply top
- linking hardware
- interior dividers have a wire pass thru
- two rectangular back center grommets available, specify and add \$204 list
- 24" wire manager included for field installation

Tall Transition Storage Credenza	18	54	27 / 33	150	19	BS1854-33TFSR	\$3,850
	18	54	27 / 33	150	19	BS1854-33TFSL	\$3,850



- one door with two fixed shelves,
- two drawers with open compartments
- bent ply top
- linking hardware
- interior dividers have a wire pass thru
- two rectangular back center grommets available, specify and add \$204 list
- 24" wire manager included for field installation

Tall Transition Storage Credenza	18	72	27 / 33	170	25	BS1872-33TFSR	\$4,390
	18	72	27 / 33	170	25	BS1872-33TFSL	\$4,390



- two doors with two fixed shelves,
- two drawers with open compartments
- bent ply top
- linking hardware
- interior dividers have a wire pass thru
- two rectangular back center grommets available, specify and add \$204 list
- 24" wire manager included for field installation

To Order, Specify:

- ① Model Number
- ② Wood Species - Rift Cut White Oak (WK4) or Flat Cut Walnut (WA1)
- ③ Wood Finish See [Wood Finish Options](#)
- ④ Door/Drawer Front Optional Paint Color See [Paint Color Options](#)
- ⑤ Metal Leg Color See [Metal Leg Color Options](#)

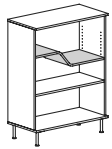
Specifications:

- Wood species - Rift Cut White Oak or Flat Cut Walnut.
- 3/4" thick plywood tops
- Exterior feet and leg frames are fabricated from 14 gauge steel tubing and 14 gauge flat stock.

Description	D	W	H	CTN WT	CU FT	Model	List Price
Open Bookcase	18	36	48	99	22	BS1836-480BC	\$2,300



straight shelf



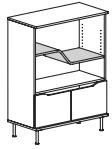
optional bent plywood

- open cabinet, two shelves
- lower shelf fixed, always straight
- upper shelf adjustable, straight standard; bent plywood available, specify and add \$775 to list
- specify back height: full back, mid back or low back
- linking hardware

Open Bookcase with Lower Doors	18	36	48	115	22	BS1836-48SBC	\$2,467
---------------------------------------	----	----	----	-----	----	---------------------	----------------



straight shelf



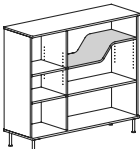
optional bent plywood

- two doors, open cabinet with two shelves
- lower shelf fixed, always straight
- upper shelf adjustable, straight standard; bent plywood available, specify and add \$775 to list
- specify back height: full back, mid back or low back
- linking hardware

Open Storage Bookcase with Tower	18	54	48	165	33	BS1854-480BCR	\$2,793
---	----	----	----	-----	----	----------------------	----------------



straight shelf



optional bent plywood

- open cabinet, four shelves
- two lower shelves fixed, always straight
- two upper shelves adjustable, straight standard; bent plywood available on wide shelf, specify and add \$775 to list
- specify back height: full back, mid back or low back
- linking hardware

lefts shown

Storage Bookcase with Lower Doors and Tower	18	54	48	181	33	BS1854-48DBCR	\$2,976
	18	54	48	181	33	BS1854-48DBCL	\$2,976



straight shelf

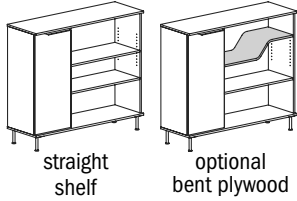


optional bent plywood

- two doors, open cabinet
- two lower shelves fixed, always straight
- two upper shelves adjustable, straight standard; bent plywood available on wide shelf, specify and add \$775 to list
- specify back height: full back, mid back or low backs
- linking hardware

lefts shown

Description	D	W	H	CTN WT	CU FT	① Model	List Price
Storage Bookcase with Tower Door	18	54	48	185	33	BS1854-48TBCR	\$2,976
	18	54	48	185	33	BS1854-48TBCL	\$2,976

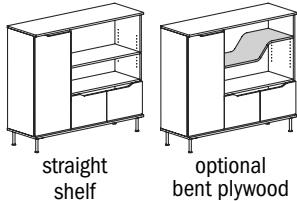


straight shelf optional bent plywood

lefts shown

- tower door with two shelves, lower shelf fixed
- open cabinet with two shelves
- lower shelf fixed, always straight
- upper shelf adjustable, straight standard; bent plywood available on upper shelf, specify and add \$775 to list
- specify back height: full back, mid back or low backs
- linking hardware

Storage Bookcase with Full Door Set and Tower	18	54	48	201	33	BS1854-48SBCR	\$3,119
	18	54	48	201	33	BS1854-48SBCL	\$3,119



straight shelf optional bent plywood

lefts shown

- tower door with two shelves, lower shelf fixed
- open cabinet with two shelves
- lower shelf fixed, always straight
- upper shelf adjustable, straight standard; bent plywood available on adjustable shelf, specify and add \$775 to list
- specify back height: full back, mid back or low backs
- linking hardware

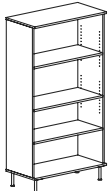
To Order, Specify:

- ① Model Number
- ② Wood Species - Rift Cut White Oak (WK4) or Flat Cut Walnut (WA1)
- ③ Wood Finish [See Wood Finish Options](#)
- ④ Door Front Optional Paint Color [See Paint Color Options](#)
- ⑤ Back Height - Full Back, Mid Back, Low Back
- ⑥ Metal Leg Color [See Metal Leg Color Options](#)

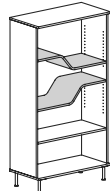
Specifications:

- Wood species - Rift Cut White Oak or Flat Cut Walnut.
- 3/4" thick plywood tops
- Exterior feet and leg frames are fabricated from 14 gauge steel tubing and 14 gauge flat stock.

Description	D	W	H	CTN WT	CU FT	Model	List Price
Open Bookcase	18	36	68	114	31	BS1836-680BC	\$2,692



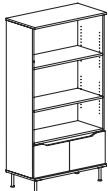
straight shelves



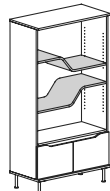
optional bent plywood

- open cabinet, three shelves
- lower shelf fixed, always straight
- two upper shelves adjustable, straight standard; bent plywood available, specify and add \$775 per shelf to list
- specify back height: full back, mid back or low backs
- linking hardware

Open Bookcase with Lower Doors	18	36	68	130	31	BS1836-68SBC	\$2,862
---------------------------------------	----	----	----	-----	----	---------------------	----------------



straight shelves



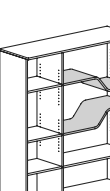
optional bent plywood

- two doors, open cabinet with three shelves
- lower shelf fixed, always straight
- two upper shelves adjustable, straight standard; bent plywood available, specify and add \$775 per shelf to list
- specify back height: full back, mid back or low backs
- linking hardware

Open Storage Bookcase with Tower	18	54	68	209	46	BS1854-680BCR	\$3,203
---	----	----	----	-----	----	----------------------	----------------



straight shelves



optional bent plywood

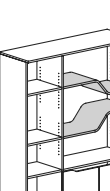
- open cabinet, six shelves
- two lower shelves fixed, always straight
- four upper shelves adjustable, straight standard; bent plywood available on wide shelves, specify and add \$775 per shelf to list
- specify back height: full back, mid back or low backs
- linking hardware

lefts shown

Storage Bookcase with Lower Doors and Tower	18	54	68	225	46	BS1854-68DBCR	\$3,364
--	----	----	----	-----	----	----------------------	----------------



straight shelves

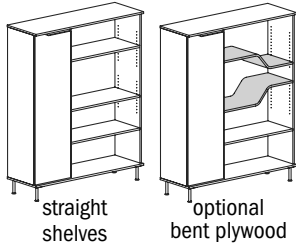


optional bent plywood

- two doors, open cabinet with six shelves
- two lower shelves fixed, always straight
- four upper shelves adjustable, straight standard; bent plywood available on wide shelves, specify and add \$775 per shelf to list
- specify back height: full back, mid back or low backs
- linking hardware

lefts shown

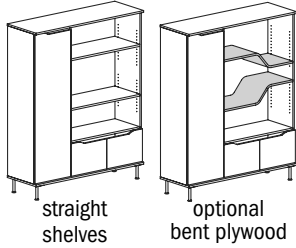
Description	D	W	H	CTN WT	CU FT	① Model	List Price
Storage Bookcase with Tower Door	18	54	68	234	46	BS1854-68TBCR	\$3,364
	18	54	68	234	46	BS1854-68TBCL	\$3,364



lefts shown

- tower door with three shelves, lower shelf fixed
- open cabinet with three shelves
- lower shelf fixed, always straight
- two upper shelves adjustable, straight standard; bent plywood available on adjustable shelves, specify and add \$775 per shelf to list
- specify back height: full back, mid back or low backs
- linking hardware

Storage Bookcase with Full Door Set and Tower	18	54	68	250	46	BS1854-68SBCR	\$3,506
	18	54	68	250	46	BS1854-68SBCL	\$3,506



lefts shown

- tower door with three shelves, lower shelf fixed
- open cabinet with three shelves
- lower shelf fixed, always straight;
- two upper shelves adjustable, straight standard; bent plywood available on adjustable shelves, specify and add \$775 per shelf to list
- specify back height: full back, mid back or low backs
- linking hardware

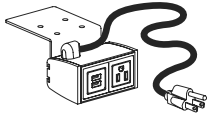
To Order, Specify:

- ① Model Number
- ② Wood Species - Rift Cut White Oak (WK4) or Flat Cut Walnut (WA1)
- ③ Wood Finish [See Wood Finish Options](#)
- ④ Door Front Optional Paint Color [See Paint Color Options](#)
- ⑤ Back Height - Full Back, Mid Back, Low Back
- ⑥ Metal Leg Color [See Metal Leg Color Options](#)

Specifications:

- Wood species - Rift Cut White Oak or Flat Cut Walnut.
- 3/4" thick plywood tops
- Exterior feet and leg frames are fabricated from 14 gauge steel tubing and 14 gauge flat stock.

Description	D	W	H	CTN WT	CU FT	① Model	List Price
Power Center Under Mount	6	3 5/8	2 1/2	4	1	EC21	\$525



- mounts under platform or surface
- field installable
- one power receptacle - 110 volt, one dual USB port
- 10' power cord with molded plug
- specify Black (B) or White (W) finish

To Order, Specify:

- ① Model Number

Boston Order Check List:



Specify:

- 1. Model Number
- 2. Wood Species - Red Oak (RO) or Maple (M)
- 3. Wood Finish/Color
- 4. Fabric Selection - vendor, pattern and color
- 5. Optional FRONT LEG Casters - add \$66 list; specify seat height - NOT AVAILABLE on BENCHES
- 6. Optional Trim Nails - add \$134 list per chair; add \$170 list per bench
- 7. Optional Rubber Cushion Nylon Glides - no upcharge

Example:

981C (model #)	RO (wood species)	HEN (finish)	MOMENTUM (fabric vendor)	VOX (pattern name)	MYSTIC (pattern color)
--------------------------	-----------------------------	------------------------	------------------------------------	------------------------------	----------------------------------

1. Model Number

2. Wood Species - Red Oak (RO) or Maple (M)

3. Wood Finish/Color Options:

Red Oak

BRW	Brownie	ECU	Ecru
CAN	Canyon	HEN	Henna
CIT	Citron	HNY	Honey
DES	Desert	NUT	Nut Brown

Maple

ALM	Ale Medium	HRV	Harvest
CAL	Ale Light Coordinate	CKC	Khaki Coordinate
BBM	Bourbon Medium	MINC	Mineral Coordinate
CBZ	Brazilwood Coordinate	MCH	Mocha
BARC	Barrel Coordinate	CPI	Pinnacle Walnut Coordinate
CBO	Bourbon Light Coordinate	PRL	Praline
CBG	Brighton Light Coordinate	RAVC	Raven Coordinate
BRM	Brighton Medium	SABC	Sable Coordinate
BUT	Butterscotch	SIE	Sienna
CNDC	Cinder Coordinate	CST	Studio Teak Coordinate
CLA	Classic	TRF	Truffle
CLL	Collectors	UMB	Umber
EGRC	Egret Coordinate	VALC	Valley Coordinate
ESP	Espresso	VEN	Venetian
FAWC	Fawn Coordinate	CWE	Weathered Ash Coordinate
FLX	Flax		
CGR	Graphite Coordinate		

Color - Add \$45 list per item

BKD	Backdrop	GRV	Greek Villa
BFX	Black Fox	GLF	Gulf Stream
BWH	Bright White	HTB	Heartthrob
CGP	Cargo Pants	NET	Network Gray
CHT	Chatroom	NWH	Nonchalant White
DSY	Daisy	PAR	Paradise
DRG	Daring	QXP	Quixotic Plum
DYN	Dynamo	RBZ	Relic Bronze
ENG	Enigma	SND	Sandbank
FRR	French Roast	STM	Storm
GBY	Georgian Bay	TRC	Tricorn Black

4. Fabric Selection - Please supply the following:
Fabric vendor/ Pattern name/ Pattern color

For a complete list of JSI Standard and Graded-In Textiles click [here](#)

All COM orders must include the following:

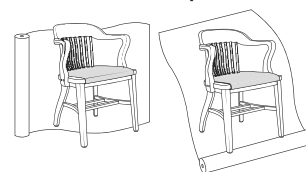
- Vendor's name, pattern name and color
- Sample of the fabric attached to order
- Model numbers of items for fabric application
- Special application instructions (e.g., all stripes will be applied front to back unless specified otherwise)
- Customer and purchase order number

Ship prepaid COM material to:

JSI
Attn: COM Department
201 East Martin Street
Receiving B, Dock 71
Orleans, IN 47452

Application of fabric:

Railroaded Up the Roll



All COM orders will ship at standard lead time from receipt of COM except for orders requiring special custom matched finishes.

5. Optional trim nails - add \$134 list per chair; add \$170 list per bench

BOSTON

Description

Swivel Chair with Arms, Wood Back and Seat



980A
all wood



980C
uph. seat

Model

980A All Wood
980C Uph. Seat

- optional five star base with pneumatic lift - add \$91 list
- dual black casters available, no upcharge - specify when ordering
- optional jury base available, revolves, tilts- add \$203 list
- optional jury base does not include site installation hardware

Specifications

Dimensions	D	W	H
Overall	22	23 ¼	32 -36
Seat	17 ½	19 ¾	14 ⅝ - 18 ⅝
Arm	26-30		
Upholstery		Shipping	
COM Ydg	1	Ctn Wt	45
COL Sq Ft	12	Cu Ft	12

List Price Per Grade

All Wood	\$1,650
COM	\$1,752
A	\$1,790
B	\$1,817
COL/C	\$1,866
D	\$1,922
E	\$1,981
F	\$2,045
G	\$2,134
H	\$2,228
I	\$2,380
J	\$2,559
L1	\$2,152
L2	\$2,249

Guest Chair with Arms, Wood Back and Seat



981A
all wood



981C
uph. seat

981A All Wood
981C Uph. Seat

- optional front leg casters available - add \$66 list for set of 2 casters

Dimensions	D	W	H
Overall	23 ½	24	32 ¼
Seat	17 ¾	19 ¾	18 ½
Arm	28 ¾		
Upholstery		Shipping	
COM Ydg	1	Ctn Wt	39
COL Sq Ft	12	Cu Ft	13

All Wood	\$1,282
COM	\$1,392
A	\$1,424
B	\$1,453
COL/C	\$1,499
D	\$1,556
E	\$1,618
F	\$1,678
G	\$1,769
H	\$1,866
I	\$2,015
J	\$2,192
L1	\$1,788
L2	\$1,881

To Order, Specify:

- Model Number
- Wood Species - Red Oak (RO) or Maple (M)
- Wood Finish/Color [See Wood Finish/Color Options](#)
- Fabric Selection - vendor, pattern and color
Visit www.jsifurniture.com/finishes-and-materials/textiles for our textiles program. See selection of standard and graded in manufacturers and patterns.
- Optional FRONT LEG Casters - add \$66 list; specify seat height.
NOT AVAILABLE on BENCHES
- Optional Trim Nails - add \$134 list per chair; add \$170 list per bench
- Optional Rubber Cushion Nylon Glides - no upcharge

Specifications

- Wood species - Red Oak or Maple.
- Seat is upholstered with 1 ½" high density polyurethane foam and features horseshoe style upholstery.
- Spiral grooved hardwood dowels with corner blocks, glue and screws.
- Standard with rubber cushion metal glides.

Description

Model

Specifications

List Price Per Grade

Guest Chair Armless, Wood Back and Seat

983A All Wood
983C Uph. Seat
 · optional front leg casters available
 - add \$66 list for set of 2 casters

Dimensions	D	W	H
Overall	23 ½	20	32 ¼
Seat	18 ¼	20 ¾	19 ¼
Upholstery		Shipping	
COM Ydg	1	Ctn Wt	37
COL Sq Ft	12	Cu Ft	13

All Wood	\$1,178
COM	\$1,293
A	\$1,326
B	\$1,351
COL/C	\$1,397
D	\$1,458
E	\$1,515
F	\$1,582
G	\$1,669
H	\$1,762
I	\$1,914
J	\$2,091
L1	\$1,686
L2	\$1,784

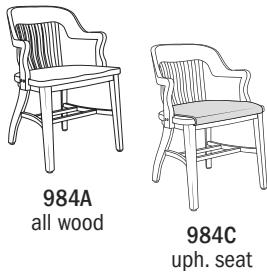


Guest Chair with Low Arms, Wood Back and Seat

984A All Wood
984C Uph. Seat
 · low arm - 26" arm height
 · optional front leg casters available
 - add \$66 list for set of 2 casters

Dimensions	D	W	H
Overall	22 ½	22 ¼	33
Seat	17 ¾	19 ½	18 ¼
Arm			26
Upholstery		Shipping	
COM Ydg	1	Ctn Wt	38
COL Sq Ft	12	Cu Ft	13

All Wood	\$1,409
COM	\$1,514
A	\$1,552
B	\$1,577
COL/C	\$1,624
D	\$1,685
E	\$1,746
F	\$1,806
G	\$1,897
H	\$1,994
I	\$2,142
J	\$2,318
L1	\$1,914
L2	\$2,009



Bench 49 ½" w, Wood Back and Seat

991A All Wood
991C Uph. Seat
 · casters not available

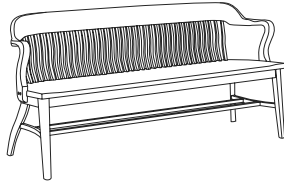
Dimensions	D	W	H
Overall	23	49 ½	33
Seat	17 ¾	45 ¼	18 ¼
Arm			28 ½
Upholstery		Shipping	
COM Ydg	7/8	Ctn Wt	76
COL Sq Ft	23	Cu Ft	31

All Wood	\$4,561
COM	\$4,624
A	\$4,705
B	\$4,730
COL/C	\$4,768
D	\$4,821
E	\$4,873
F	\$4,929
G	\$5,008
H	\$5,091
I	\$5,222
J	\$5,376
L1	\$5,021
L2	\$5,104

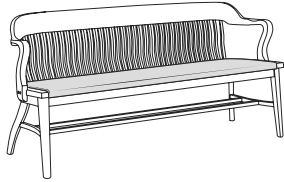


BOSTON

Description
Bench 69 1/2" w, Wood Back and Seat



993A
all wood



993C
uph. seat

Model
993A All Wood
993C Uph. Seat
· casters not available

Specifications

Dimensions	D	W	H
Overall	23	69 1/2	33 1/2
Seat	18	66 1/4	18
Arm			28 1/2
Upholstery		Shipping	
COM Ydg	2 1/4	Ctn Wt	109
COL Sq Ft	23	Cu Ft	47

List Price Per Grade

All Wood	\$5,116
COM	\$5,305
A	\$5,417
B	\$5,474
COL/C	\$5,579
D	\$5,714
E	\$5,848
F	\$5,989
G	\$6,188
H	\$6,405
I	\$6,740
J	\$7,142
L1	\$6,229
L2	\$6,445

To Order, Specify:

- 1 Model Number
- 2 Wood Species - Red Oak (RO) or Maple (M)
- 3 Wood Finish/Color [See Wood Finish/Color Options](#)
- 4 Fabric Selection - vendor, pattern and color
Visit www.jsifurniture.com/finishes-and-materials/textiles for our textiles program. See selection of standard and graded in manufacturers and patterns.
- 5 Optional FRONT LEG Casters - add \$66 list; specify seat height.
NOT AVAILABLE on BENCHES
- 6 Optional Trim Nails - add \$134 list per chair; add \$170 list per bench
- 7 Optional Rubber Cushion Nylon Glides - no upcharge

Specifications

- Wood species - Red Oak or Maple.
- Seat is upholstered with 1 1/2" high density polyurethane foam and features horseshoe style upholstery.
- Spiral grooved hardwood dowels with corner blocks, glue and screws.
- Standard with rubber cushion metal glides.

Bourne Seating Order Check List:



Specify:

- 1. Model Number
- 2. Wood Species - Maple (M) or Walnut (W) upcharge applies when Walnut is specified
- 3. Wood Finish
- 4. Fabric Selection - vendor, pattern and color
- 5. Metal Foot Rail Color -
- 6. Optional Rubber Cushion Nylon Glides - no upcharge

Example:

BU7511D | **M** | **HRV** | **MOMENTUM** | **VOX** | **MYSTIC**
 (model #) | (wood species) | (finish) | (fabric vendor) | (pattern name) | (pattern color)

1. Model Number

2. Wood Species - Maple (M) or Walnut (W); upcharge applies

3. Wood Finish Options:

Maple Frame

CAL	Ale Light Coordinate	CGR	Graphite Coordinate
ALM	Ale Medium	HRV	Harvest
BARC	Barrel Coordinate	CKC	Khaki Coordinate
CBO	Bourbon Light Coordinate	MINC	Mineral Coordinate
BBM	Bourbon Medium	MCH	Mocha
CBZ	Brazilwood Coordinate	CPI	Pinnacle Walnut Coordinate
CBG	Brighton Light Coordinate	PRL	Praline
BRM	Brighton Medium	RAVC	Raven Coordinate
BUT	Butterscotch	SABC	Sable Coordinate
CNDC	Cinder Coordinate	SIE	Sienna
CLA	Classic	CST	Studio Teak Coordinate
CLL	Collectors	TRF	Truffle
EGRC	Egret Coordinate	UMB	Umber
ESP	Espresso	VALC	Valley Coordinate
FAWC	Fawn Coordinate	VEN	Venetian
FLX	Flax	CWE	Weathered Ash Coordinate

Walnut Frame (optional, upcharge applies)

ESP	Espresso	TRF	Truffle
MCH	Mocha	UMB	Umber
SIE	Sienna		

4. Fabric Selection - Please supply the following:
 Fabric vendor/ Pattern name/ Pattern color

For a complete list of JSI Standard and Graded-In Textiles click [here](#)

When specifying dual upholstery, indicate clearly which upholstery is to be applied to the seat/lower back and the upper back.

- Indicate direction of fabric - Railroaded or Up the Roll
- Please provide illustration, if available

All COM orders must include the following:

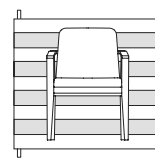
- Vendor's name, pattern name and color
- Sample of the fabric attached to the order
- Model numbers of items for fabric application
- Special application instructions (e.g., all stripes will be applied front to back unless specified otherwise)
- Customer and purchase order number

Ship prepaid COM material to:

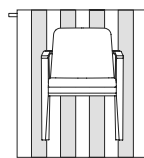
JSI
 Attn: COM Department
 201 East Martin Street
 Receiving B, Docks 71-73
 Orleans, IN 47452

Application of fabric:

Railroaded



Up the Roll



All COM orders will ship at standard lead time from receipt of COM except for orders requiring special custom matched finishes.

5. Metal Foot Rail Color - specify color:

ABZ	Aged Bronze	PEW	Pewter
ASL	Arctic Silver	SBZ	Soft Bronze
GLD	Gold	SNK	Soft Nickel
MBK	Matte Black		

6. Optional Rubber Cushion Nylon Glides - no upcharge

Single Textile Seating

a. frame species

(choose one)

- maple
- walnut (*upcharge applies*)

finish color:

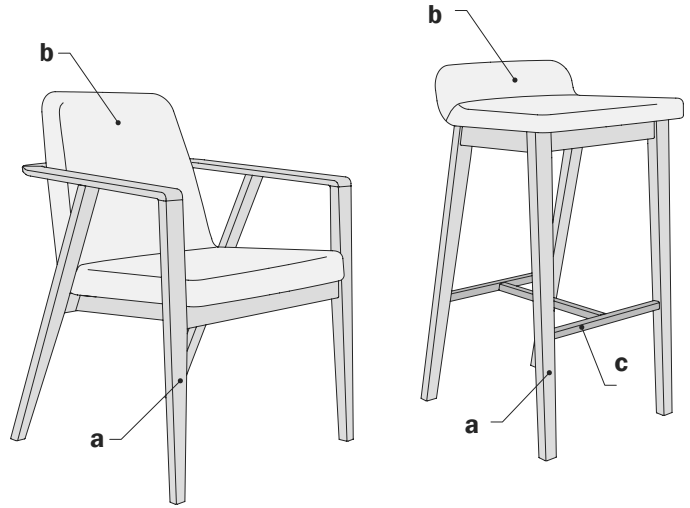
(see previous page for finish choices) _____

b. fabric selection

- vendor
- pattern
- color

c. metal color (if applicable)

(choose one)



Dual Textile Seating

a. frame species

(choose one)

- maple
- walnut (*upcharge applies*)

finish color:

(see previous page for finish choices) _____

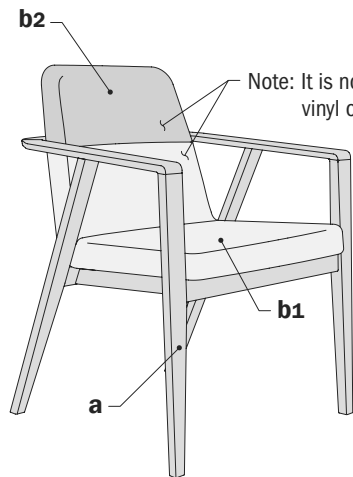
b. fabric selection;

b1.) seat and lower back

- vendor
- pattern
- color

b2.) upper back

- vendor
- pattern
- color



Note: It is not recommended to combine vinyl or leather material to fabric.

BOURNE

Bourne Tables Order Check List:



Specify:

- 1. Model Number**
- 2. Top Material**
 - a.) **Veneer**
 - 1.) **Wood Species - Cherry (CH1), Maple (MA1), Walnut (WA1), Black Oak (B01) or Double Cut (DC1)**
 - 2.) **Wood Finish**
 - b.) **Laminate**
 - 1.) **Laminate Color**
 - c.) **Solid Surface**
 - 1.) **Solid Surface Color - Armadillo (ARM), Black Pearl (BLP), Pebble Pearl (PEB), or Pure White (PUR)**
- 3. Legs/Apron Wood Species**
 - a.) **Maple (M)**
 - 1.) **Wood or Paint Color**
 - b.) **Walnut (W) (upcharge applies)**
 - 1.) **Wood Finish**

Example:

BU2448-17TTWL (model #)	WA1 (veneer species)	MCH (wood finish)	W (legs/apron species)	ESP (wood finish)
-----------------------------------	--------------------------------	-----------------------------	----------------------------------	-----------------------------

1. Model Number

2. Top Material Selection:

Veneer

CH1 Cherry	<i>Flat Cut Veneer</i>
BBM Bourbon Medium	CLL Collectors
BRM Brighton Medium	HRV Harvest
CLA Classic	PRL Praline

MA1 Maple	<i>Flat Cut Veneer</i>
ALM Ale Medium	FLX Flax
BUT Butterscotch	VEN Venetian

WA1 Walnut	<i>Flat Cut Veneer</i>
ESP Espresso	TRF Truffle
MCH Mocha	UMB Umber
SIE Sienna	

B01 Black Oak	<i>Flat Cut Veneer</i>
RAV Raven	

DC1 Double Cut Veneer	
BAR Barrel - Oak Pattern	KHK Khaki
BUF Buff - Oak Pattern	MIN Mineral - Oak Pattern
CND Cinder - Oak Pattern	RYE Rye - Oak Pattern
COF Coffee	SAB Sable - Oak Pattern
EGR Egret - Oak Pattern	SAD Saddle - Oak Pattern
FAW Fawn	STU Studio Teak
GRH Graphite	VAL Valley

Top Material Selection (continued):

Laminate

Veneer Grain Pattern Laminates

TFL - HPL Wood Grain Pattern Laminates

ALL Ale Light	MIN Mineral
BOL Bourbon Light	OAT Oatmeal Cookie
BZW Brazilwood	PIN Pinnacle Walnut
BGL Brighton Light	STU Studio Teak
CLL Collectors	UMB Umber
FAW Fawn	VAL Valley
FLO Florence Walnut	VIN Vintage
GRH Graphite	WEA Weathered Ash

TFL - HPL Solid Laminates

ALB Alabaster	DWH Designer White
BLK Black	SHD Shadow
BBL Bridal Blanco	SLG Slate Grey

Solid Surface

ARM Armadillo	PEB Pebble Pearl
BLP Black Pearl	PUR Pure White

3. Legs/Apron Selection:

Maple (MA1)

Wood Finish:

ALM	Ale Medium	CGR	Graphite Coordinate
CAL	Ale Light Coordinate	HRV	Harvest
BBM	Bourbon Medium	CKC	Khaki Coordinate
CBZ	Brazilwood Coordinate	MINC	Mineral Coordinate
BARC	Barrel Coordinate	MCH	Mocha
CBO	Bourbon Light Coordinate	CPI	Pinnacle Walnut Coordinate
CBG	Brighton Light Coordinate	PRL	Praline
BRM	Brighton Medium	RAVC	Raven Coordinate
BUT	Butterscotch	SABC	Sable Coordinate
CNDC	Cinder Coordinate	SIE	Sienna
CLA	Classic	CST	Studio Teak Coordinate
CLL	Collectors	TRF	Truffle
EGRC	Egret Coordinate	UMB	Umber
ESP	Espresso	VALC	Valley Coordinate
FAWC	Fawn Coordinate	VEN	Venetian
FLX	Flax	CWE	Weathered Ash Coordinate

Paint Color:

BKD	Blackdrop	GRV	Greek Villa
BFX	Black Fox	NET	Nework Grey
BWH	Bright White	NWH	Nonchalant White
CGP	Cargo Pants	STM	Storm
CHT	Chatroom	TRC	Tricorn Black
FRR	French Roast		

Walnut (WA1) (upcharge applies)

Wood Finish:

ESP	Espresso	TRF	Truffle
MCH	Mocha	UMB	Umber
SIE	Sienna		

BOURNE

Table Order Check List

a. worksurface - veneer, laminate, or solid surface choice
(choose one)

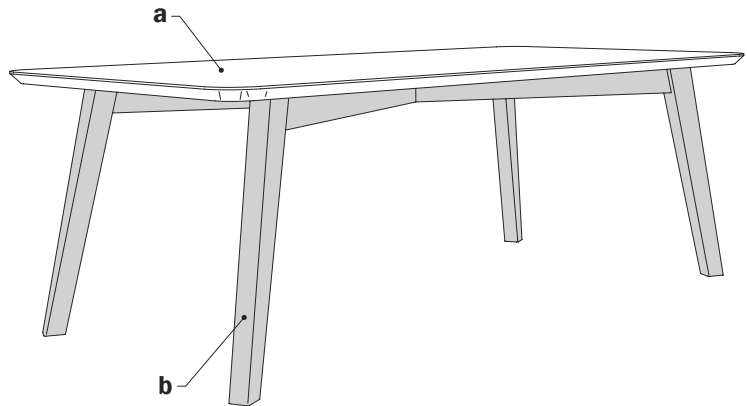
- | | |
|------------------------------------|--|
| <input type="checkbox"/> cherry | <input type="checkbox"/> double cut |
| <input type="checkbox"/> maple | <input type="checkbox"/> laminate |
| <input type="checkbox"/> walnut | <input type="checkbox"/> solid surface |
| <input type="checkbox"/> black oak | |

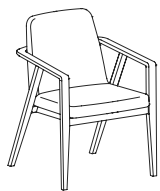
finish, laminate or solid surface color:
(see previous page for choices) _____

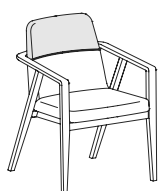
b. legs/apron
(choose one)

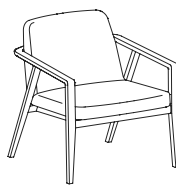
- | |
|--|
| <input type="checkbox"/> maple |
| <input type="checkbox"/> walnut (upcharge applies) |

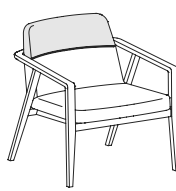
legs/apron finish/paint color:
(see above for choices) _____





Description	① Model	Specifications	List Price Per Grade																
Guest Chair - Single Textile 	BU7511D · wall saver · maple frame standard · walnut frame available, specify and add \$240 list	<table border="1"> <thead> <tr> <th>Dimensions</th> <th>D</th> <th>W</th> <th>H</th> </tr> </thead> <tbody> <tr> <td>Overall</td> <td>26</td> <td>24 ¼</td> <td>33</td> </tr> <tr> <td>Seat</td> <td>18</td> <td>20 ¼</td> <td>18</td> </tr> <tr> <td>Arm</td> <td></td> <td></td> <td>25</td> </tr> </tbody> </table>	Dimensions	D	W	H	Overall	26	24 ¼	33	Seat	18	20 ¼	18	Arm			25	COM \$1,482 A \$1,495 B \$1,520 COL/C \$1,565 D \$1,623 E \$1,683 F \$1,772 G \$1,870 H \$1,972 I \$2,134 J \$2,328 L1 \$1,941 L2 \$2,070
		Dimensions	D	W	H														
Overall	26	24 ¼	33																
Seat	18	20 ¼	18																
Arm			25																
<table border="1"> <thead> <tr> <th>Upholstery</th> <th colspan="3">Shipping</th> </tr> </thead> <tbody> <tr> <td>COM Ydg</td> <td>1 ¼</td> <td>Ctn Wt</td> <td>25</td> </tr> <tr> <td>COL Sq Ft</td> <td>23</td> <td>Cu Ft</td> <td>14</td> </tr> </tbody> </table>	Upholstery	Shipping			COM Ydg	1 ¼	Ctn Wt	25	COL Sq Ft	23	Cu Ft	14							
Upholstery	Shipping																		
COM Ydg	1 ¼	Ctn Wt	25																
COL Sq Ft	23	Cu Ft	14																


Description	① Model	Specifications	List Price Per Grade																
Guest Chair - Dual Textile 	BU7511E · wall saver · dual textile back; specify two textiles when ordering, see page BUS3 · maple frame standard · walnut frame available, specify and add \$240 list	<table border="1"> <thead> <tr> <th>Dimensions</th> <th>D</th> <th>W</th> <th>H</th> </tr> </thead> <tbody> <tr> <td>Overall</td> <td>26</td> <td>24 ¼</td> <td>33</td> </tr> <tr> <td>Seat</td> <td>18</td> <td>20 ¼</td> <td>18</td> </tr> <tr> <td>Arm</td> <td></td> <td></td> <td>25</td> </tr> </tbody> </table>	Dimensions	D	W	H	Overall	26	24 ¼	33	Seat	18	20 ¼	18	Arm			25	COM \$1,549 A \$1,565 B \$1,596 COL/C \$1,650 D \$1,720 E \$1,791 F \$1,899 G \$2,015 H \$2,140 I \$2,332 J \$2,566 L1 \$2,101 L2 \$2,255
		Dimensions	D	W	H														
Overall	26	24 ¼	33																
Seat	18	20 ¼	18																
Arm			25																
<table border="1"> <thead> <tr> <th>Upholstery</th> <th colspan="3">Shipping</th> </tr> </thead> <tbody> <tr> <td>COM Ydg</td> <td>1 ½</td> <td>Ctn Wt</td> <td>25</td> </tr> <tr> <td>COL Sq Ft</td> <td>27</td> <td>Cu Ft</td> <td>14</td> </tr> </tbody> </table>	Upholstery	Shipping			COM Ydg	1 ½	Ctn Wt	25	COL Sq Ft	27	Cu Ft	14							
Upholstery	Shipping																		
COM Ydg	1 ½	Ctn Wt	25																
COL Sq Ft	27	Cu Ft	14																

Description	① Model	Specifications	List Price Per Grade																
Lounge Chair - Single Textile 	BU7521D · maple frame standard · walnut frame available, specify and add \$297 list	<table border="1"> <thead> <tr> <th>Dimensions</th> <th>D</th> <th>W</th> <th>H</th> </tr> </thead> <tbody> <tr> <td>Overall</td> <td>29 ¼</td> <td>28 ¾</td> <td>30</td> </tr> <tr> <td>Seat</td> <td>21</td> <td>24 ½</td> <td>17 ¼</td> </tr> <tr> <td>Arm</td> <td></td> <td></td> <td>23</td> </tr> </tbody> </table>	Dimensions	D	W	H	Overall	29 ¼	28 ¾	30	Seat	21	24 ½	17 ¼	Arm			23	COM \$1,745 A \$1,761 B \$1,792 COL/C \$1,847 D \$1,916 E \$1,986 F \$2,095 G \$2,211 H \$2,335 I \$2,528 J \$2,762 L1 \$2,296 L2 \$2,451
		Dimensions	D	W	H														
Overall	29 ¼	28 ¾	30																
Seat	21	24 ½	17 ¼																
Arm			23																
<table border="1"> <thead> <tr> <th>Upholstery</th> <th colspan="3">Shipping</th> </tr> </thead> <tbody> <tr> <td>COM Ydg</td> <td>1 ½</td> <td>Ctn Wt</td> <td>30</td> </tr> <tr> <td>COL Sq Ft</td> <td>30</td> <td>Cu Ft</td> <td>17</td> </tr> </tbody> </table>	Upholstery	Shipping			COM Ydg	1 ½	Ctn Wt	30	COL Sq Ft	30	Cu Ft	17							
Upholstery	Shipping																		
COM Ydg	1 ½	Ctn Wt	30																
COL Sq Ft	30	Cu Ft	17																

Description	① Model	Specifications	List Price Per Grade																
Lounge Chair - Dual Textile 	BU7521E · dual textile back; specify two textiles when ordering, see page BUS3 · maple frame standard · walnut frame available, specify and add \$297 list	<table border="1"> <thead> <tr> <th>Dimensions</th> <th>D</th> <th>W</th> <th>H</th> </tr> </thead> <tbody> <tr> <td>Overall</td> <td>29 ¼</td> <td>28 ¾</td> <td>30</td> </tr> <tr> <td>Seat</td> <td>21</td> <td>24 ½</td> <td>17 ¼</td> </tr> <tr> <td>Arm</td> <td></td> <td></td> <td>23</td> </tr> </tbody> </table>	Dimensions	D	W	H	Overall	29 ¼	28 ¾	30	Seat	21	24 ½	17 ¼	Arm			23	COM \$1,817 A \$1,835 B \$1,872 COL/C \$1,935 D \$2,016 E \$2,098 F \$2,225 G \$2,361 H \$2,505 I \$2,731 J \$3,003 L1 \$2,460 L2 \$2,641
		Dimensions	D	W	H														
Overall	29 ¼	28 ¾	30																
Seat	21	24 ½	17 ¼																
Arm			23																
<table border="1"> <thead> <tr> <th>Upholstery</th> <th colspan="3">Shipping</th> </tr> </thead> <tbody> <tr> <td>COM Ydg</td> <td>1 ¾</td> <td>Ctn Wt</td> <td>30</td> </tr> <tr> <td>COL Sq Ft</td> <td>35</td> <td>Cu Ft</td> <td>17</td> </tr> </tbody> </table>	Upholstery	Shipping			COM Ydg	1 ¾	Ctn Wt	30	COL Sq Ft	35	Cu Ft	17							
Upholstery	Shipping																		
COM Ydg	1 ¾	Ctn Wt	30																
COL Sq Ft	35	Cu Ft	17																

Description	① Model	Specifications				List Price Per Grade	
Ottoman 	BU7504C • maple frame standard • walnut frame available, specify and add \$101 list	Dimensions		D	W	H	COM \$987
		Overall		18	22	13 ¼	A \$996
		Upholstery		Shipping			B \$1,011
		COM Ydg	¾	Ctn Wt	10	COL/C \$1,038	
		COL Sq Ft	14	Cu Ft	5	D \$1,073	
					E \$1,109		
					F \$1,163		
					G \$1,220		
					H \$1,283		
					I \$1,380		
					J \$1,496		
					L1 \$1,262		
					L2 \$1,340		

Description	① Model	Specifications				List Price Per Grade	
27½" Counter Height Stool 	BU7514D • coordinates with counter height tables • metal foot rail • maple frame standard • walnut frame available, specify and add \$180 list	Dimensions		D	W	H	COM \$1,285
		Overall		18 ¼	18	27 ½	A \$1,294
		Seat		14 ½	18	24	B \$1,308
		Upholstery		Shipping			COL/C \$1,336
		COM Ydg	¾	Ctn Wt	18	D \$1,371	
COL Sq Ft	14	Cu Ft	7	E \$1,407			
				F \$1,461			
				G \$1,519			
				H \$1,581			
				I \$1,678			
				J \$1,794			
				L1 \$1,561			
				L2 \$1,638			

Description	① Model	Specifications				List Price Per Grade	
33½" Bar Stool 	BU7518D • coordinates with bar height tables • metal foot rail • maple frame standard • walnut frame available, specify and add \$180 list	Dimensions		D	W	H	COM \$1,285
		Overall		19 ½	18	33 ½	A \$1,294
		Seat		14 ½	18	30	B \$1,308
		Upholstery		Shipping			COL/C \$1,336
		COM Ydg	¾	Ctn Wt	20	D \$1,371	
COL Sq Ft	14	Cu Ft	8	E \$1,407			
				F \$1,461			
				G \$1,519			
				H \$1,581			
				I \$1,678			
				J \$1,794			
				L1 \$1,561			
				L2 \$1,638			

To Order, Specify:

- ① Model Number
- ② Wood Species:
 - a.) Maple (M)
 - b.) Walnut (W) - upcharge applies
- ③ Finish [See Finish Options](#)
 - a.) Maple Finish
 - b.) Walnut Finish
- ④ Fabric Selection - vendor, pattern and color
 - a.) Seat and Lower Back
 - b.) Upper Back (only available on Dual Textile chairs)
 Visit www.jsifurniture.com/finishes-and-materials/textiles for our textiles program. See selection of standard and graded in manufacturers and patterns.
- ⑤ Metal Foot Rail Color - [See Metal Foot Rail Color Options](#)
- ⑥ Optional Rubber Cushion Nylon Glides - no upcharge

Specifications

- Wood Species - Maple or Walnut.
- Seats are upholstered with high density polyurethane foam.
- Backs are tapered and upholstered with polyurethane foam.
- Mortise and tenon construction with corner blocks, glue and screws.
- Standard with rubber cushion metal glides.

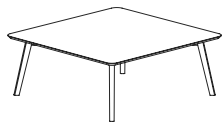
Description	D	W	H	CTN WT	CU FT	① Model	Flat Cut or HPL Laminate Top	Double Cut Top	Solid Surface Top
-------------	---	---	---	-----------	----------	---------	------------------------------------	-------------------	----------------------

Rectangular Coffee Table	24	48	17	39	11	BU2448-17TTWL	\$1,633	\$1,700	\$2,617
---------------------------------	----	----	----	----	----	----------------------	----------------	----------------	----------------



- ships KD
- knife edge
- maple legs/apron standard
- walnut legs/apron available, specify and add \$172 list

Square Coffee Table	42	42	17	54	16	BU4242-17TTWL	\$1,701	\$1,770	\$3,811
----------------------------	----	----	----	----	----	----------------------	----------------	----------------	----------------



- ships KD
- knife edge
- maple legs/apron standard
- walnut legs/apron available, specify and add \$172 list

Round Coffee Table	42	42	17	45	16	BU42-17RDWL	\$1,613	\$1,680	\$3,724
---------------------------	----	----	----	----	----	--------------------	----------------	----------------	----------------



- | | | | | | | | | | |
|--|----|----|----|----|----|--------------------|----------------|----------------|----------------|
| | 36 | 36 | 17 | 36 | 12 | BU36-17RDWL | \$1,558 | \$1,626 | \$3,099 |
|--|----|----|----|----|----|--------------------|----------------|----------------|----------------|
- ships KD
 - three legs
 - knife edge
 - maple legs/apron standard
 - walnut legs/apron available, specify and add \$172 list

Triangular Coffee Table	36	48	17	42	16	BU3648-17PKWL	\$1,618	\$1,684	\$3,728
--------------------------------	----	----	----	----	----	----------------------	----------------	----------------	----------------



- ships KD
- three legs
- knife edge
- maple legs/apron standard
- walnut legs/apron available, specify and add \$172 list



BOURNE

Description	D	W	H	CTN WT	CU FT	❶ Model	Flat Cut or HPL Laminate Top	Double Cut Top	Solid Surface Top
Square Side Table	20	20	21	22	4	BU2020-21TTWL	\$1,542	\$1,608	\$2,154



- ships KD
- knife edge
- maple legs/apron standard
- walnut legs/apron available, specify and add \$172 list

Round Side Table	24	24	21	23	6	BU24-21RDWL	\$1,480	\$1,548	\$2,169
------------------	----	----	----	----	---	-------------	---------	---------	---------



- ships KD
- three legs
- knife edge
- maple legs/apron standard
- walnut legs/apron available, specify and add \$172 list

BOURNE

To Order, Specify:

- ❶ Model Number
- ❷ Top Material:
 - a.) Veneer [See Veneer Top Finish Options](#)
 - 1.) Wood Species - Cherry (CH1), Maple (MA1), Walnut (WA1) or Double Cut (DC1)
 - a.) Finish Color
 - b.) Laminate [See Laminate Top Finish Options](#)
 - 1.) Laminate Color
 - c.) Solid Surface [See Solid Surface Top Finish Options](#)
- ❸ Legs/Apron Species:
 - a.) Maple (M) [See Maple Legs/Apron Finish Options](#)
 - 1.) Finish Color or Paint Color on maple legs/apron
 - b.) Walnut (W) - [See Walnut Legs/Apron Finish Options](#); upcharge applies
 - 1.) Finish Color - walnut finishes only on walnut legs/apron

Bryn Order Check List:



Specify:

- 1. Model Number
- 2. Wood Species - Rift Cut White Oak (WK4)
- 3. Wood Finish/Color
- 4. Plastic Color - Extra White (EWM), Gray Screen (GRS), Kiwi Green (KGR), Toile Red (TRD), or Tricorn Black (TBM)
- 5. Metal Frame Tier/ Color:
 - A. Tier 1 - no upcharge
 - B. Tier 2 - add \$150 list
 - C. Tier 3 - add \$170 list
- 6. Fabric Selection - vendor, pattern and color

Example:

BY2103WU (model #)	WK4 (wood species)	HRV (finish)	MBK (metal color)	MOMENTUM (fabric vendor)	VOX (pattern name)	MYSTIC (pattern color)
------------------------------	------------------------------	------------------------	-----------------------------	------------------------------------	------------------------------	----------------------------------

1. Model Number

2. Wood Species - Rift Cut White Oak

3. Wood Finish/Color Options:

ALM Ale Medium	HRV Harvest
CAL Ale Light Coordinate	CKC Khaki Coordinate
BBM Bourbon Medium	MIN Mineral
CBZ Brazilwood Coordinate	MCH Mocha
BAR Barrel	CPI Pinnacle Walnut Coordinate
CBO Bourbon Light Coordinate	PRL Praline
CBG Brighton Light Coordinate	RAV Raven
BRM Brighton Medium	SAB Sable
BUT Butterscotch	SIE Sienna
CND Cinder	CST Studio Teak Coordinate
CLA Classic	TRF Truffle
CLL Collectors	UMB Umber
EGR Egret	VALC Valley Coordinate
ESP Espresso	VEN Venetian
FAWC Fawn Coordinate	CWE Weathered Ash Coordinate
FLX Flax	
CGR Graphite Coordinate	

4. Plastic Color:

EWM Extra White	TRD Toile Red
GRS Gray Screen	TBM Tricorn Black
KGR Kiwi Green	

5. Metal Frame Tier/Color:

Tier 1:

MBK Matte Black	CHR Chrome
-----------------	------------

Tier 2: add \$150 list

ABZ Aged Bronze	PEW Pewter
ASL Arctic Silver	SBZ Soft Bronze
BWH Bright White	SNK Soft Nickel
GLD Gold	

Tier 3: add \$170 list

BRD Beige Red (RAL3012)	SAL Salmon Orange (RAL2012)
CAR Carmine Red (RAL3002)	SPB Sapphire Blue (RAL4007)
COP Copper Brown (RAL8004)	SGR Signal Green (RAL6032)
HYL Honey Yellow (RAL1005)	SIG Signal Orange (RAL2010)
LGR Leaf Green (RAL6002)	SGY Silk Grey (RAL7044)
MHB Mahogany Brown (RAL8016)	SKY Sky Blue (RAL5015)
MTQ Mint Turquoise (RAL6033)	TBL Traffic Blue (RAL5017)
OGR Olive Green (RAL6003)	TRD Traffic Red (RAL3020)
PPV Purple Violet (RAL4007)	TQP Turquoise Pastel (RAL6034)
QZG Quartz Grey (RAL7039)	ZYL Zinc Yellow (RAL1018)

Chrome Frame dictate chrome glides/ back support bracketry.
 Matte Black Frame dictate black glides/ back support bracketry.
 All other Frame color dictates chrome glides/back support bracketry.

6. Fabric Selection - Please supply the following:
Fabric vendor/Pattern name/Pattern color

[For a complete list of JSI Standard and Graded-In Textiles click here](#)

When specifying contrasting upholstery, indicate clearly which upholstery is to be applied to the seat and back. Use higher grade pricing.

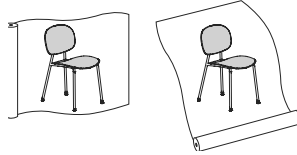
- Indicate direction of fabric - Railroaded or Up the Roll
- Please provide illustration, if available

All COM orders must include the following:

- Fabric vendor's name, pattern name and color
- Sample of the fabric attached to order
- Model numbers of items for fabric application
- Special application instructions (e.g., all stripes will be applied front to back unless specified otherwise)
- Customer and purchase order number

Ship prepaid COM material to:
JSI
Attn: COM Department
201 East Martin Street
Receiving B, Dock 71
Orleans, IN 47452

Application of fabric:
Railroaded Up the Roll



All COM orders will ship at standard lead time from receipt of COM except for orders requiring special custom matched finishes.

Description	Model	Specifications	List Price Per Grade																			
Armless Guest Chair	BY2103PP - All Plastic	<table border="1"> <thead> <tr> <th>Dimensions</th> <th>D</th> <th>W</th> <th>H</th> </tr> </thead> <tbody> <tr> <td>Overall</td> <td>22 ¾</td> <td>17 ¼</td> <td>31 ¼</td> </tr> <tr> <td>Seat</td> <td>18</td> <td>17 ¼</td> <td>17 ½</td> </tr> </tbody> </table>	Dimensions	D	W	H	Overall	22 ¾	17 ¼	31 ¼	Seat	18	17 ¼	17 ½	<table border="1"> <thead> <tr> <th>Upholstery</th> <th>Shipping</th> </tr> </thead> <tbody> <tr> <td>COM Ydg</td> <td>¾ Ctn Wt 17</td> </tr> <tr> <td>COL Sq Ft</td> <td>14 Cu Ft 12</td> </tr> </tbody> </table>	Upholstery	Shipping	COM Ydg	¾ Ctn Wt 17	COL Sq Ft	14 Cu Ft 12	All Plastic \$702
	Dimensions		D	W	H																	
Overall	22 ¾	17 ¼	31 ¼																			
Seat	18	17 ¼	17 ½																			
Upholstery	Shipping																					
COM Ydg	¾ Ctn Wt 17																					
COL Sq Ft	14 Cu Ft 12																					
	BY2103PU - Uph. Seat		COM \$848																			
	· seated height		A \$858																			
	· armless		B \$877																			
			COL/C \$910																			
			D \$949																			
			E \$990																			
			F \$1,055																			
			G \$1,123																			
			H \$1,197																			
			I \$1,311																			
			J \$1,451																			
			L1 \$1,174																			
			L2 \$1,265																			

Description	Model	Specifications	List Price Per Grade																			
Armless Guest Chair	BY2103WW - All Wood	<table border="1"> <thead> <tr> <th>Dimensions</th> <th>D</th> <th>W</th> <th>H</th> </tr> </thead> <tbody> <tr> <td>Overall</td> <td>22 ¾</td> <td>17 ¼</td> <td>31 ¼</td> </tr> <tr> <td>Seat</td> <td>18</td> <td>17 ¼</td> <td>17 ½</td> </tr> </tbody> </table>	Dimensions	D	W	H	Overall	22 ¾	17 ¼	31 ¼	Seat	18	17 ¼	17 ½	<table border="1"> <thead> <tr> <th>Upholstery</th> <th>Shipping</th> </tr> </thead> <tbody> <tr> <td>COM Ydg</td> <td>¾ Ctn Wt 17</td> </tr> <tr> <td>COL Sq Ft</td> <td>14 Cu Ft 12</td> </tr> </tbody> </table>	Upholstery	Shipping	COM Ydg	¾ Ctn Wt 17	COL Sq Ft	14 Cu Ft 12	All Wood \$1,037
	Dimensions		D	W	H																	
Overall	22 ¾	17 ¼	31 ¼																			
Seat	18	17 ¼	17 ½																			
Upholstery	Shipping																					
COM Ydg	¾ Ctn Wt 17																					
COL Sq Ft	14 Cu Ft 12																					
	BY2103WU - Uph. Seat		COM \$1,041																			
	· seated height		A \$1,049																			
	· armless		B \$1,068																			
			COL/C \$1,099																			
			D \$1,139																			
			E \$1,182																			
			F \$1,245																			
			G \$1,315																			
			H \$1,388																			
			I \$1,503																			
			J \$1,640																			
			L1 \$1,365																			
			L2 \$1,458																			

Description	Model	Specifications	List Price Per Grade																			
Armless Guest Chair - Upholstered	BY2103UU	<table border="1"> <thead> <tr> <th>Dimensions</th> <th>D</th> <th>W</th> <th>H</th> </tr> </thead> <tbody> <tr> <td>Overall</td> <td>22 ¾</td> <td>17 ¼</td> <td>31 ¼</td> </tr> <tr> <td>Seat</td> <td>18</td> <td>17 ¼</td> <td>17 ½</td> </tr> </tbody> </table>	Dimensions	D	W	H	Overall	22 ¾	17 ¼	31 ¼	Seat	18	17 ¼	17 ½	<table border="1"> <thead> <tr> <th>Upholstery</th> <th>Shipping</th> </tr> </thead> <tbody> <tr> <td>COM Ydg</td> <td>1 Ctn Wt 17</td> </tr> <tr> <td>COL Sq Ft</td> <td>18 Cu Ft 12</td> </tr> </tbody> </table>	Upholstery	Shipping	COM Ydg	1 Ctn Wt 17	COL Sq Ft	18 Cu Ft 12	COM \$1,040
	Dimensions		D	W	H																	
Overall	22 ¾	17 ¼	31 ¼																			
Seat	18	17 ¼	17 ½																			
Upholstery	Shipping																					
COM Ydg	1 Ctn Wt 17																					
COL Sq Ft	18 Cu Ft 12																					
	· seated height		A \$1,053																			
	· armless		B \$1,079																			
	· upholstered seat and upholstered back		COL/C \$1,121																			
			D \$1,176																			
			E \$1,232																			
			F \$1,317																			
			G \$1,409																			
			H \$1,505																			
			I \$1,658																			
			J \$1,842																			
			L1 \$1,475																			
			L2 \$1,598																			

Description

1 Model

Specifications

List Price Per Grade

Guest Chair



BY2101PP
plastic seat

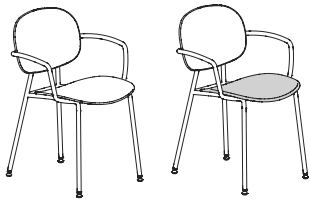
BY2101PU
uph. seat

BY2101PP - All Plastic
BY2101PU - Uph. Seat
 · seated height
 · arms

Dimensions	D	W	H
Overall	22 ¾	21 ¾	31 ¼
Seat	18	17 ¼	17 ½
Arm			25 ½
Upholstery		Shipping	
COM Ydg	¾	Ctn Wt	19
COL Sq Ft	14	Cu Ft	14

All Plastic	\$829
COM	\$976
A	\$984
B	\$1,003
COL/C	\$1,035
D	\$1,077
E	\$1,119
F	\$1,183
G	\$1,250
H	\$1,324
I	\$1,439
J	\$1,576
L1	\$1,301
L2	\$1,393

Guest Chair



BY2101WW
wood seat

BY2101WU
uph. seat

BY2101WW - All Wood
BY2101WU - Uph. Seat
 · seated height
 · arms

Dimensions	D	W	H
Overall	22 ¾	21 ¾	31 ¼
Seat	18	17 ¼	17 ½
Arm			25 ½
Upholstery		Shipping	
COM Ydg	¾	Ctn Wt	19
COL Sq Ft	14	Cu Ft	14

All Wood	\$1,162
COM	\$1,168
A	\$1,178
B	\$1,195
COL/C	\$1,229
D	\$1,267
E	\$1,309
F	\$1,373
G	\$1,443
H	\$1,515
I	\$1,631
J	\$1,771
L1	\$1,493
L2	\$1,586

BRYN


To Order, Specify:

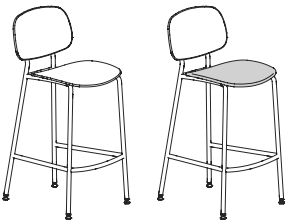
- 1 Model Number
- 2 Wood Species - Rift Cut White Oak (WK4)
- 3 Wood Finish/Color See [Wood Finish/Color Options](#)
- 4 Plastic Color See [Plastic Color Options](#)
- 5 Metal Frame Color See [Metal Frame Color Options](#)
- 6 Fabric Selection - vendor, pattern and color

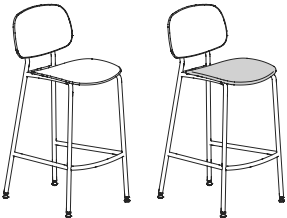
Visit www.jsifurniture.com/finishes-and-materials/textiles for our textiles program. See selection of standard and graded in manufacturers and patterns.


Specifications

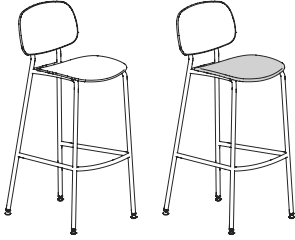
- Wood species - Rift Cut White Oak.
- Wall saver feature.
- Standard with felt glides.

Description	Model	Specifications	List Price Per Grade																
Guest Chair 	BY2101UU · seated height · arms · upholstered seat and upholstered back	<table border="1"> <thead> <tr> <th>Dimensions</th> <th>D</th> <th>W</th> <th>H</th> </tr> </thead> <tbody> <tr> <td>Overall</td> <td>22 ¾</td> <td>21 ¾</td> <td>31 ¼</td> </tr> <tr> <td>Seat</td> <td>18</td> <td>17 ¼</td> <td>17 ½</td> </tr> <tr> <td>Arm</td> <td></td> <td></td> <td>25 ½</td> </tr> </tbody> </table>	Dimensions	D	W	H	Overall	22 ¾	21 ¾	31 ¼	Seat	18	17 ¼	17 ½	Arm			25 ½	COM \$1,167 A \$1,181 B \$1,205 COL/C \$1,247 D \$1,301 E \$1,357 F \$1,443 G \$1,535 H \$1,632 I \$1,784 J \$1,971 L1 \$1,602 L2 \$1,725
		Dimensions	D	W	H														
Overall	22 ¾	21 ¾	31 ¼																
Seat	18	17 ¼	17 ½																
Arm			25 ½																
<table border="1"> <thead> <tr> <th>Upholstery</th> <th colspan="3">Shipping</th> </tr> </thead> <tbody> <tr> <td>COM Ydg</td> <td>1</td> <td>Ctn Wt</td> <td>19</td> </tr> <tr> <td>COL Sq Ft</td> <td>18</td> <td>Cu Ft</td> <td>14</td> </tr> </tbody> </table>	Upholstery	Shipping			COM Ydg	1	Ctn Wt	19	COL Sq Ft	18	Cu Ft	14							
Upholstery	Shipping																		
COM Ydg	1	Ctn Wt	19																
COL Sq Ft	18	Cu Ft	14																

37" h Counter Height Stool		Model	Specifications	List Price Per Grade											
	BY2104PP - All Plastic BY2104PU - Uph. Seat · armless	<table border="1"> <thead> <tr> <th>Dimensions</th> <th>D</th> <th>W</th> <th>H</th> </tr> </thead> <tbody> <tr> <td>Overall</td> <td>19 ¼</td> <td>17</td> <td>37</td> </tr> <tr> <td>Seat</td> <td>16</td> <td>15 ¼</td> <td>25 ⅞</td> </tr> </tbody> </table>	Dimensions	D	W	H	Overall	19 ¼	17	37	Seat	16	15 ¼	25 ⅞	All Plastic \$1,066 COM \$1,212 A \$1,220 B \$1,239 COL/C \$1,270 D \$1,311 E \$1,355 F \$1,418 G \$1,486 H \$1,561 I \$1,673 J \$1,814 L1 \$1,537 L2 \$1,627
			Dimensions	D	W	H									
Overall	19 ¼	17	37												
Seat	16	15 ¼	25 ⅞												
<table border="1"> <thead> <tr> <th>Upholstery</th> <th colspan="3">Shipping</th> </tr> </thead> <tbody> <tr> <td>COM Ydg</td> <td>¾</td> <td>Ctn Wt</td> <td>21</td> </tr> <tr> <td>COL Sq Ft</td> <td>14</td> <td>Cu Ft</td> <td>13</td> </tr> </tbody> </table>	Upholstery	Shipping			COM Ydg	¾	Ctn Wt	21	COL Sq Ft	14	Cu Ft	13			
Upholstery	Shipping														
COM Ydg	¾	Ctn Wt	21												
COL Sq Ft	14	Cu Ft	13												

37" h Counter Height Stool with Wood Seat and Wood Back		Model	Specifications	List Price Per Grade											
	BY2104WW - All Wood BY2104WU - Uph. Seat · counter height · armless	<table border="1"> <thead> <tr> <th>Dimensions</th> <th>D</th> <th>W</th> <th>H</th> </tr> </thead> <tbody> <tr> <td>Overall</td> <td>19 ¼</td> <td>17</td> <td>37</td> </tr> <tr> <td>Seat</td> <td>16</td> <td>15 ¼</td> <td>25 ⅞</td> </tr> </tbody> </table>	Dimensions	D	W	H	Overall	19 ¼	17	37	Seat	16	15 ¼	25 ⅞	All Wood \$1,389 COM \$1,406 A \$1,414 B \$1,432 COL/C \$1,464 D \$1,505 E \$1,547 F \$1,613 G \$1,679 H \$1,752 I \$1,869 J \$2,004 L1 \$1,731 L2 \$1,822
			Dimensions	D	W	H									
Overall	19 ¼	17	37												
Seat	16	15 ¼	25 ⅞												
<table border="1"> <thead> <tr> <th>Upholstery</th> <th colspan="3">Shipping</th> </tr> </thead> <tbody> <tr> <td>COM Ydg</td> <td>¾</td> <td>Ctn Wt</td> <td>21</td> </tr> <tr> <td>COL Sq Ft</td> <td>14</td> <td>Cu Ft</td> <td>13</td> </tr> </tbody> </table>	Upholstery	Shipping			COM Ydg	¾	Ctn Wt	21	COL Sq Ft	14	Cu Ft	13			
Upholstery	Shipping														
COM Ydg	¾	Ctn Wt	21												
COL Sq Ft	14	Cu Ft	13												

Description	1 Model	Specifications				List Price Per Grade	
37" Counter Height Stool 	BY2104UU · armless · upholstered seat and upholstered back	Dimensions	D	W	H	COM	\$1,402
		Overall	19 ¼	17	37	A	\$1,414
		Seat	16	15 ¼	25 ⅞	B	\$1,439
		Upholstery	Shipping		COL/C	\$1,482	
		COM Ydg	1	Ctn Wt	21	D	\$1,536
		COL Sq Ft	18	Cu Ft	13	E	\$1,591
						F	\$1,677
						G	\$1,769
						H	\$1,867
						I	\$2,022
						J	\$2,203
						L1	\$1,836
						L2	\$1,957

40 ¾" Bar Height Barstool		Specifications				List Price Per Grade	
	BY2108PP - All Plastic BY2108PU - Uph. Seat · bar height · armless	Dimensions	D	W	H	All Plastic	\$1,097
		Overall	19 ¼	17	40 ¾	COM	\$1,244
		Seat	16	15 ¼	29 ¾	A	\$1,253
		Upholstery	Shipping		B	\$1,270	
		COM Ydg	¾	Ctn Wt	22	COL/C	\$1,303
		COL Sq Ft	14	Cu Ft	13	D	\$1,344
						E	\$1,387
						F	\$1,451
						G	\$1,520
						H	\$1,592
						I	\$1,707
						J	\$1,844
						L1	\$1,570
						L2	\$1,662



To Order, Specify:


- 1 Model Number
- 2 Wood Species - Rift Cut White Oak (WK4)
- 3 Wood Finish/Color See [Wood Finish/Color Options](#)
- 4 Plastic Color See [Plastic Color Options](#)
- 5 Metal Frame Color See [Metal Frame Color Options](#)
- 6 Fabric Selection - vendor, pattern and color

Visit www.jsifurniture.com/finishes-and-materials/textiles for our textiles program. See selection of standard and graded in manufacturers and patterns.

Specifications

- Wood species - Rift Cut White Oak.
- Wall saver feature.
- Standard with felt glides.

Description	Model	Specifications	List Price Per Grade
40¾" Bar Height Barstool	BY2108WW - All Wood	Dimensions	All Wood \$1,420
	BY2108WU - Uph. Seat	Overall	COM \$1,438
 BY2108WW wood seat	<ul style="list-style-type: none"> · bar height · armless 	Seat	A \$1,446
		Upholstery	B \$1,464
 BY2108WU uph. seat		Shipping	COL/C \$1,497
	COM Ydg	Ctn Wt	D \$1,537
	COL Sq Ft	Cu Ft	E \$1,578
			F \$1,643
			G \$1,712
			H \$1,784
			I \$1,900
			J \$2,038
			L1 \$1,763
			L2 \$1,853

Description	Model	Specifications	List Price Per Grade
40¾" Bar Height Barstool	BY2108UU	Dimensions	COM \$1,433
		Overall	A \$1,446
	<ul style="list-style-type: none"> · bar height · armless · upholstered seat and upholstered back 	Seat	B \$1,469
		Upholstery	COL/C \$1,513
		Shipping	D \$1,569
	COM Ydg	Ctn Wt	E \$1,623
	COL Sq Ft	Cu Ft	F \$1,709
			G \$1,799
			H \$1,898
			I \$2,050
			J \$2,235
			L1 \$1,869
			L2 \$1,991

To Order, Specify:

- 1 Model Number
- 2 Wood Species - Rift Cut White Oak (WK4)
- 3 Wood Finish/Color See [Wood Finish/Color Options](#)
- 4 Plastic Color See [Plastic Color Options](#)
- 5 Metal Frame Color See [Metal Frame Color Options](#)
- 6 Fabric Selection - vendor, pattern and color

Visit www.jsifurniture.com/finishes-and-materials/textiles for our textiles program. See selection of standard and graded in manufacturers and patterns.

Specifications

- Wood species - Rift Cut White Oak.
- Wall saver feature.
- Standard with felt glides.



Table of Contents

Freestanding Seating.....CV8
 Modular Seating.....CV16
 Modular Seating with 52" Screen.....CV20
 Modular Seating with 44" Screen.....CV24
 Modular Seating with 44" Screen and Stand up Surface.....CV28
 Sectional Seating.....CV32
 Media Panel and Runoff Table.....CV34
 Desk Pods.....CV36
 Media Credenza and Work Table.....CV38
 Accessories.....CV40

CĀAV Seating Order Check List:



- Specify:**
- 1. Model Number
 - 2. Wood Species - STANDARD Maple (M) - no upcharge, Walnut (W) or White Oak (WK1) - upcharge applies
 - 3. Wood Finish
 - 4. Fabric Selection - vendor, pattern and color
 - Specify Fabric for Seating
 - Specify Fabric for Surround/Wing/Hood
 - 5. Metal Color
 - 6. Optional Tablet Arm - Indicate tablet (TBT), left (TBL) or right (TBR); Laminate or Veneer - add \$733 list per arm
 - 7. Optional Power - Specify location and add \$408 list; specify color Black (B) or White (W)
 - Chairs - Indicate as seated Right (PUR) or Left (PUL)
 - Ottomans - Indicate Front (PUFR), Back (PUBK) or Both (PUB)

Example:

CVF3440-31 | M | HRV | MOMENTUM | VOX | MYSTIC
 (model #) | (wood species) | (finish) | (fabric vendor) | (pattern name) | (pattern color)

1. Model Number

Wood Finish (cont.)

2. Wood Species - STANDARD Maple (M), Walnut (W) or White Oak (WK1); upcharge applies

***Walnut Frame (upcharge applies)**

ESP	Espresso	TRF	Truffle
MCH	Mocha	UMB	Umber
SIE	Sienna		

3. Wood Finish/Color Options:

Maple Frame

ALM	Ale Medium	HRV	Harvest
CAL	Ale Light Coordinate	CKC	Khaki Coordinate
BBM	Bourbon Medium	MINC	Mineral Coordinate
CBZ	Brazilwood Coordinate	MCH	Mocha
BARC	Barrel Coordinate	CPI	Pinnacle Walnut Coordinate
CBO	Bourbon Light Coordinate	PRL	Praline
CBG	Brighton Light Coordinate	RAVC	Raven Coordinate
BRM	Brighton Medium	SABC	Sable Coordinate
BUT	Butterscotch	SIE	Sienna
CNDC	Cinder Coordinate	CST	Studio Teak Coordinate
CLA	Classic	TRF	Truffle
CLL	Collectors	UMB	Umber
EGRC	Egret Coordinate	VALC	Valley Coordinate
ESP	Espresso	VEN	Venetian
FAWC	Fawn Coordinate	CWE	Weathered Ash Coordinate
FLX	Flax		
CGR	Graphite Coordinate		

***White Oak Frame (upcharge applies)**

ACR	Acorn	MIN	Mineral
BAR	Barrel	POR	Porter
BUF	Buff	RAV	Raven
BUR	Burlap	RYE	Rye
CHE	Chestnut	SAB	Sable
CND	Cinder	SAD	Saddle
EGR	Egret	WWO	Whitewash

4. Fabric Selection - Please supply the following: Fabric vendor/ Pattern name/ Pattern color

For a complete list of JSI Standard and Graded-In Textiles click [here](#)

- Indicate direction of fabric - Railroaded or Up the Roll
- Please provide illustration, if available

Paint Color - Add \$45 list per item

BKD	Backdrop	GRV	Greek Villa
BFX	Black Fox	GLF	Gulf Stream
BWH	Bright White	HTB	Heartthrob
CGP	Cargo Pants	NET	Network Gray
CHT	Chatroom	NWH	Nonchalant White
DSY	Daisy	PAR	Paradise
DRG	Daring	QXP	Quixotic Plum
DYN	Dynamo	RBZ	Relic Bronze
ENG	Enigma	SND	Sandbank
FRR	French Roast	STM	Storm
GBY	Georgian Bay	TRC	Tricorn Black

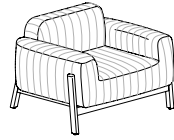
All COM orders must include the following:

- Vendor's name, pattern name and color
- Sample of the fabric attached to the order
- Model numbers of items for fabric application
- Special application instructions
- Customer and purchase order number

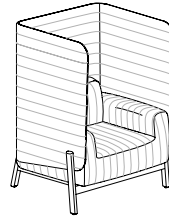
***Note:** Associated upcharges for Walnut and White Oak Solid Hardwoods are located in the bullet points under units where applicable.

Ship prepaid COM material to:

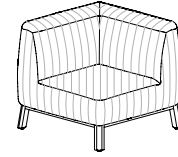
JSI
 Attn: COM Department
 201 East Martin Street
 Receiving B, Dock 71
 Orleans, IN 47452



Seating: Up the Roll



Privacy Screens: Railroad
 *Leather unavailable



Corner Units:
 Seat surfaces run diagonal

All COM orders will ship at standard lead time from receipt of COM except for orders requiring special custom matched finishes.

5. Metal Color

ABZ Aged Bronze	PEW Pewter
ASL Arctic Silver	SBZ Soft Bronze
GLD Gold	SNK Soft Nickel
MBK Matte Black	

JSI's extended powdercoat program of bright colors is available, upon request. Contact Customer Service for a specific quote based on qty of units.

6. Optional Tablet Arm

- Specify Tablet Arm Left (TBL), Right (TBR), or (TBT) and add \$733 list for laminate or veneer

7. Optional Power

- Specify location as seated in right (PUR) or left (PUL), and select color choice of Black (B) or White (W); add \$408 list per location. In ottomans, specify Back (PUBK), Front (PUFR) or Both (PUB).

Optional Laminate for tablet arms and counter surfaces

HPL Wood Grain Pattern Laminates

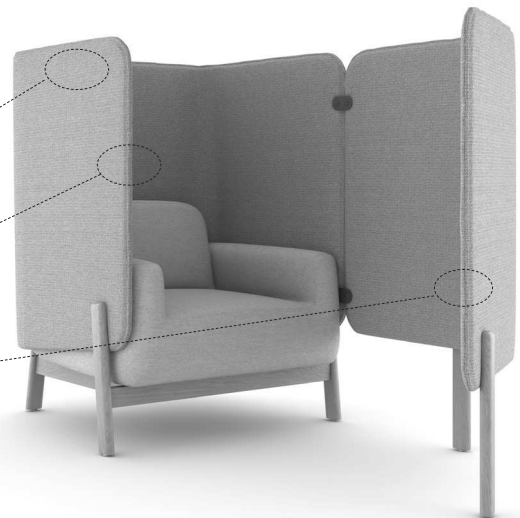
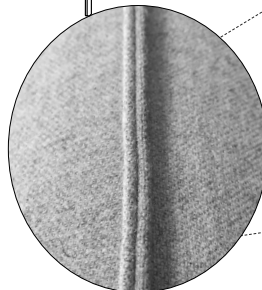
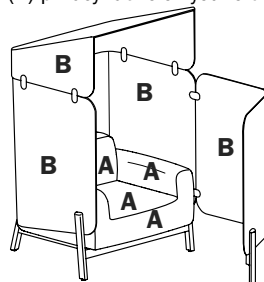
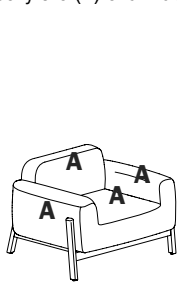
ALL Ale Light	MIN Mineral
BOL Bourbon Light	OAT Oatmeal Cookie
BZW Brazilwood	PIN Pinnacle Walnut
BGL Brighton Light	STU Studio Teak
CLL Collectors	UMB Umber
FAW Fawn	VAL Valley
FLO Florence Walnut	VIN Vintage
GRH Graphite	WEA Weathered Ash

HPL Solid Laminates

ALB Alabaster	DWH Designer White
BLK Black	SHD Shadow
BBL Bridal Blanco	SLG Slate Grey

Contrasting Upholstery

Units with privacy elements can be specified with contrasting upholstery. When specified, the unit will be priced based on the highest grade fabric selected. Specify the (A) chair fabric and (B) privacy fabric on your order.



Upholstery Detail - False Welt

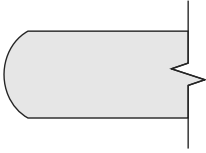
False Welt - Double fold upholstery seam detail is present on Caav privacy screens. An integral part of the upholstery application, the false welt creates a defined line while maintaining flexibility for ultimate casual comfort.

Note: Large scale and geometric patterns applied over Caav's soft contours and false welt details will impact the pattern visual. Solid colors are recommended, particularly on the seating.

CĀAV

Edge profile

All veneer desks, tables, stand-up surfaces and tablet arms have a bullnose edge detail. The edge is solid lumber and finished to match the top surface. Maple is standard, Walnut and White Oak are available for an upcharge. All laminate desks, tables, stand-up surfaces and tablet arms had a matching PVC eased edge.



Bullnose Edge

Standard on veneer worksurface tops



Eased Edge (R3)

Standard on laminate worksurface tops

Power



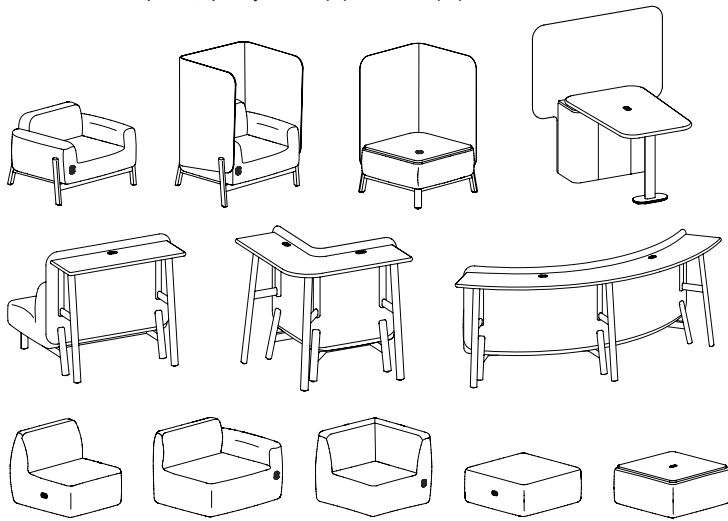
EC46 - FlushMount

- Integrated simplex receptacle and two USB-A/9' - three prong Graphite fabric power cord/factory installed.
- Order as option, specify Black (B) or White (W).



EC47 - Under/Side Mount

- Simplex receptacle and two USB-A/9' - three prong Graphite fabric power cord/field installed.
- Mounts under table surface or to side of armless modular seat.
- Order separately, specify Black (B) or White (W).



Lighting

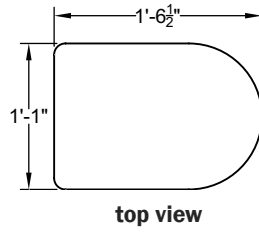


Sconce Lamp

- Accessory sconce
- Cord-mounted rocker switch
- 15' - three prong Graphite fabric power cord
- Field installed
- Maximum 60 watt light bulb, NOT included/LED bulb recommended

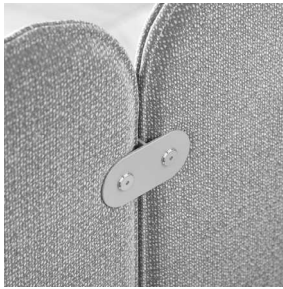
Tablet Arm

All arms on Freestanding, Modular and Sectional units are available with an optional tablet. The double-pivot mechanism allows the surface to be placed closer to the user. The recommended weight limit for the tablet is 75lbs. Available in Maple, Cherry, Walnut or White Oak veneer or JSI standard laminate.



H-brackets

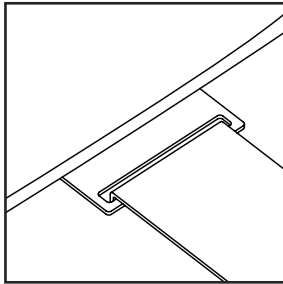
Privacy Hoods and Privacy Wings attach in the field with H-Brackets. The metal color selected on each seating unit will apply to these brackets.



Aged Bronze, Matte Black & Pewter Brackets will have black bolts
Arctic Silver, Soft Bronze, Gold & Soft Nickel Brackets will have nickel bolts

Modular linking bracket

Linking brackets are installed on Modular and Sectional units. These brackets are gravity-engaged and are intended to help link and align adjacent units. Brackets can be removed on exposed ends.



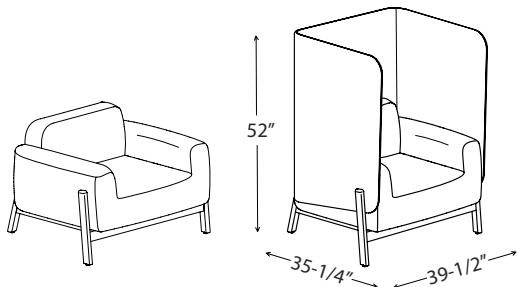
Leg-based Modular units connect with other Leg-based Modular units on ends without arms.



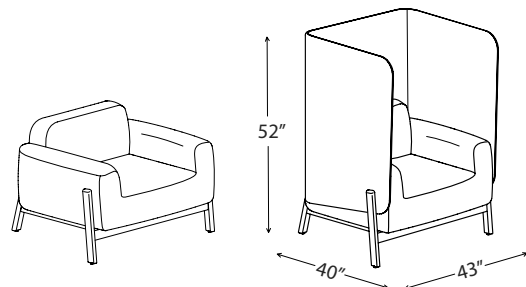
Sectional units connect with other Sectional units on ends without arms.

Lounge Scale

Freestanding, single seat lounge units are available in two sizes. Grand scale units offer generous comfort and accommodate a variety of lounge postures. Standard scale units offer the same comfort level in a smaller footprint and are more manageable to handle & install.



Standard Scale



Grand Scale

Note: Units with Privacy Surrounds may not fit through standard building doorways.

CĀAV

CĀAV Desk Pod Order Check List:



Specify:

- 1. Model Number
- 2. Fabric Selection - Vendor, pattern and color
- 3. Desk Surface Material
 - Laminate - Specify laminate with PVC edge
 - Veneer - Specify - Cherry, Maple, Walnut with Maple Rim, Walnut with Walnut Rim or White Oak - upcharge applies for non maple rims
- 3a. Leg Species and Finish - Maple, Paint on Maple, Walnut or White Oak
- 4. Metal Color
- 5. Optional Power - specify color Black (B) or White (W) - add \$408 list

Example:

CVD3439-52 | Momentum | VOX | MYSTIC | L | ALB | ML | HRV | SNK
 (model #) | (fabric vendor) | (pattern name) | (pattern color) | (Laminate) | (alabaster) | (maple) | (harvest) | (soft nickel)

1. Model Number

2. Fabric Selection - Please supply the following:
 Fabric vendor/ Pattern name/ Pattern color

For a complete list of JSI Standard and Graded-In Textiles click [here](#)

- Indicate direction of fabric - Railroaded or Up the Roll
- Please provide illustration, if available

All COM orders must include the following:

- Vendor's name, pattern name and color
- Sample of the fabric attached to the order
- Model numbers of items for fabric application
- Special application instructions
- Customer and purchase order number

Ship prepaid COM

material to:

JSI
 Attn: COM Department
 201 East Martin Street
 Receiving B, Dock 71
 Orleans, IN 47452

All COM orders will ship at standard lead time from receipt of COM except for orders requiring special custom matched finishes.

3. Desk Material - Laminate (L) or Veneer (V)

Laminate with PVC Edge

HPL Wood Grain Pattern Laminates

ALL Ale Light	MIN Mineral
BOL Bourbon Light	OAT Oatmeal Cookie
BZW Brazilwood	PIN Pinnacle Walnut
BGL Brighton Light	STU Studio Teak
CLL Collectors	UMB Umber
FAW Fawn	VAL Valley
FLO Florence Walnut	VIN Vintage
GRH Graphite	WEA Weathered Ash

HPL Solid Laminates

ALB Alabaster	DWH Designer White
BLK Black	SHD Shadow
BBL Bridal Blanco	SLG Slate Grey

Veneer - with Bullnose Edge

with Maple Rim

Cherry (CH1)

BBM Bourbon Medium
BRM Brighton Medium
CLA Classic
CLL Collectors
HRV Harvest
PRL Praline

Maple (MA1)

ALM Ale Medium
BUT Butterscotch
FLX Flax
VEN Venetian

Walnut (WA1)

ESP Espresso
MCH Mocha
SIE Sienna
TRF Truffle
UMB Umber

with Walnut Rim

Walnut (WW1)

ESP Espresso
MCH Mocha
SIE Sienna
TRF Truffle
UMB Umber

with White Oak Rim

White Oak (W0)

ACR Acorn	MIN Mineral
BAR Barrel	POR Porter
BUF Buff	RAV Raven
BUR Burlap	RYE Rye
CHE Chestnut	SAB Sable
CND Cinder	SAD Saddle
EGR Egret	WVO Whitewash

3a. Leg Species and Finish:

Maple Frame

ALM	Ale Medium	HRV	Harvest
CAL	Ale Light Coordinate	CKC	Khaki Coordinate
BBM	Bourbon Medium	MINC	Mineral Coordinate
CBZ	Brazilwood Coordinate	MCH	Mocha
BARC	Barrel Coordinate	CPI	Pinnacle Walnut Coordinate
CBO	Bourbon Light Coordinate		
CBG	Brighton Light Coordinate	PRL	Praline
BRM	Brighton Medium	RAVC	Raven Coordinate
BUT	Butterscotch	SABC	Sable Coordinate
CNDC	Cinder Coordinate	SIE	Sienna
CLA	Classic	CST	Studio Teak Coordinate
CLL	Collectors	TRF	Truffle
EGRC	Egret Coordinate	UMB	Umber
ESP	Espresso	VALC	Valley Coordinate
FAWC	Fawn Coordinate	VEN	Venetian
FLX	Flax	CWE	Weathered Ash Coordinate
CGR	Graphite Coordinate		

Paint Color - Add \$45 list per item

BKD	Backdrop	GRV	Greek Villa
BFX	Black Fox	GLF	Gulf Stream
BWH	Bright White	HTB	Heartthrob
CGP	Cargo Pants	NET	Network Gray
CHT	Chatroom	NWH	Nonchalant White
DSY	Daisy	PAR	Paradise
DRG	Daring	QXP	Quixotic Plum
DYN	Dynamo	RBZ	Relic Bronze
ENG	Enlgma	SND	Sandbank
FRR	French Roast	STM	Storm
GBY	Georgian Bay	TRC	Tricorn Black

***Walnut Frame (upcharge applies)**

ESP	Espresso	TRF	Truffle
MCH	Mocha	UMB	Umber
SIE	Sienna		

***White Oak Frame (upcharge applies)**

ACR	Acorn	MIN	Mineral
BAR	Barrel	POR	Porter
BUF	Buff	RAV	Raven
BUR	Burlap	RYE	Rye
CHE	Chestnut	SAB	Sable
CND	Cinder	SAD	Saddle
EGR	Egret	WVO	Whitewash

4. Metal Color

ABZ	Aged Bronze	PEW	Pewter
ASL	Arctic Silver	SBZ	Soft Bronze
GLD	Gold	SNK	Soft Nickel
MBK	Matte Black		

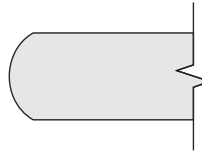
JSI's extended powdercoat program of bright colors is available, upon request. Contact Customer Service for a specific quote based on qty of units.

5. Optional Power

- Specify color choice of Black (B) or White (W) and add \$408 list

Edge Profile

All veneer desks, tables, stand-up surfaces and tablet arms have a bullnose edge detail. The edge is solid lumber and finished to match the top surface. Maple is standard, Walnut and White Oak are available for an upcharge. All laminate desks, tables, stand-up surfaces and tablet arms have a matching PVC eased edge.



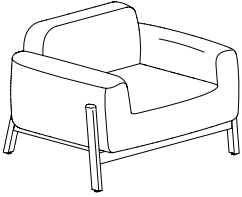
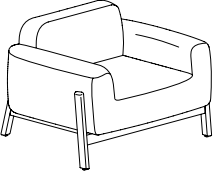
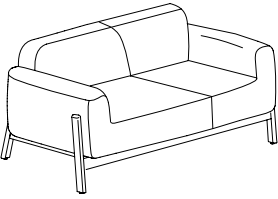
Bullnose Edge

Standard on veneer worksurface tops

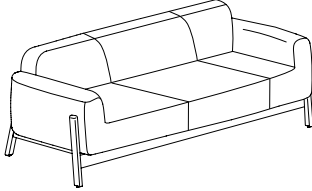


Eased Edge (R3)

Standard on laminate worksurface tops

Description	Model	Specifications	List Price Per Grade																												
Single Seat Grand Scale 	CVF3843-31 <ul style="list-style-type: none"> · maple legs standard · walnut or white oak legs available, specify and add \$371 list · tablet arm available, specify and add \$733 list, indicate right or left as seated and finish or laminate · power available in the front of the upholstered chair, specify and add \$408 list, indicate right or left as seated and color 	<table border="1"> <thead> <tr> <th>Dimensions</th> <th>D</th> <th>W</th> <th>H</th> </tr> </thead> <tbody> <tr> <td>Overall</td> <td>37 ¾</td> <td>43</td> <td>30 ½</td> </tr> <tr> <td>Seat</td> <td>21</td> <td>25</td> <td>17 ¾</td> </tr> <tr> <td>Arm</td> <td></td> <td></td> <td>25</td> </tr> <tr> <th colspan="2">Upholstery</th> <th colspan="2">Shipping</th> </tr> <tr> <td>COM Ydg</td> <td>5 ¼</td> <td>Ctn Wt</td> <td>86</td> </tr> <tr> <td>COL Sq Ft</td> <td>126</td> <td>Cu Ft</td> <td>33</td> </tr> </tbody> </table>	Dimensions	D	W	H	Overall	37 ¾	43	30 ½	Seat	21	25	17 ¾	Arm			25	Upholstery		Shipping		COM Ydg	5 ¼	Ctn Wt	86	COL Sq Ft	126	Cu Ft	33	COM \$3,500 A \$3,558 B \$3,675 COL/C \$3,876 D \$4,136 E \$4,397 F \$4,801 G \$5,235 H \$5,696 I \$6,419 J \$7,286 L1 \$6,014 L2 \$6,708
		Dimensions	D	W	H																										
Overall	37 ¾	43	30 ½																												
Seat	21	25	17 ¾																												
Arm			25																												
Upholstery		Shipping																													
COM Ydg	5 ¼	Ctn Wt	86																												
COL Sq Ft	126	Cu Ft	33																												
Single Seat 	CVF3440-31 <ul style="list-style-type: none"> · maple legs standard · walnut or white oak legs available, specify and add \$352 list · tablet arm available, specify and add \$733 list, indicate right or left as seated and finish or laminate · power available in the front of the upholstered chair, specify and add \$408 list, indicate right or left as seated and color 	<table border="1"> <thead> <tr> <th>Dimensions</th> <th>D</th> <th>W</th> <th>H</th> </tr> </thead> <tbody> <tr> <td>Overall</td> <td>34 ¼</td> <td>39 ½</td> <td>30 ½</td> </tr> <tr> <td>Seat</td> <td>21</td> <td>23 ½</td> <td>17 ¾</td> </tr> <tr> <td>Arm</td> <td></td> <td></td> <td>25</td> </tr> <tr> <th colspan="2">Upholstery</th> <th colspan="2">Shipping</th> </tr> <tr> <td>COM Ydg</td> <td>5</td> <td>Ctn Wt</td> <td>73</td> </tr> <tr> <td>COL Sq Ft</td> <td>120</td> <td>Cu Ft</td> <td>27</td> </tr> </tbody> </table>	Dimensions	D	W	H	Overall	34 ¼	39 ½	30 ½	Seat	21	23 ½	17 ¾	Arm			25	Upholstery		Shipping		COM Ydg	5	Ctn Wt	73	COL Sq Ft	120	Cu Ft	27	COM \$3,307 A \$3,365 B \$3,474 COL/C \$3,667 D \$3,914 E \$4,162 F \$4,547 G \$4,960 H \$5,400 I \$6,088 J \$6,914 L1 \$5,703 L2 \$6,362
		Dimensions	D	W	H																										
Overall	34 ¼	39 ½	30 ½																												
Seat	21	23 ½	17 ¾																												
Arm			25																												
Upholstery		Shipping																													
COM Ydg	5	Ctn Wt	73																												
COL Sq Ft	120	Cu Ft	27																												
Two Seat 	CVF3464-31 <ul style="list-style-type: none"> · maple legs standard · walnut or white oak legs available, specify and add \$463 list · tablet arm available, specify and add \$733 list per arm, indicate right, left, or both as seated and finish or laminate · power available in the front of the upholstered chair, specify and add \$408 list, indicate right, left or both as seated and color 	<table border="1"> <thead> <tr> <th>Dimensions</th> <th>D</th> <th>W</th> <th>H</th> </tr> </thead> <tbody> <tr> <td>Overall</td> <td>34 ¼</td> <td>63 ½</td> <td>30 ½</td> </tr> <tr> <td>Seat</td> <td>21</td> <td>47 ½</td> <td>17 ¾</td> </tr> <tr> <td>Arm</td> <td></td> <td></td> <td>25</td> </tr> <tr> <th colspan="2">Upholstery</th> <th colspan="2">Shipping</th> </tr> <tr> <td>COM Ydg</td> <td>6</td> <td>Ctn Wt</td> <td>107</td> </tr> <tr> <td>COL Sq Ft</td> <td>144</td> <td>Cu Ft</td> <td>44</td> </tr> </tbody> </table>	Dimensions	D	W	H	Overall	34 ¼	63 ½	30 ½	Seat	21	47 ½	17 ¾	Arm			25	Upholstery		Shipping		COM Ydg	6	Ctn Wt	107	COL Sq Ft	144	Cu Ft	44	COM \$4,283 A \$4,350 B \$4,483 COL/C \$4,713 D \$5,011 E \$5,308 F \$5,769 G \$6,264 H \$6,792 I \$7,617 J \$8,609 L1 \$7,156 L2 \$7,948
		Dimensions	D	W	H																										
Overall	34 ¼	63 ½	30 ½																												
Seat	21	47 ½	17 ¾																												
Arm			25																												
Upholstery		Shipping																													
COM Ydg	6	Ctn Wt	107																												
COL Sq Ft	144	Cu Ft	44																												

CĀAV

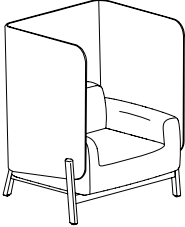
Description	Model	Specifications			List Price Per Grade		
		Dimensions	D	W	H	COM	
Three Seat 	CVF3488-31 • maple legs standard • walnut or white oak legs available, specify and add \$579 list • tablet arm available, specify and add \$733 list per arm, indicate right, left, or both as seated and finish or laminate • power available in the front of the upholstered chair, specify and add \$408 list, indicate right, left or both as seated and color	Overall	34 ¼	87 ½	30 ½	COM	\$5,166
		Seat	21	71 ½	17 ¾	COL/C	\$5,668
		Arm			25	D	\$6,014
		Upholstery		Shipping		E	\$6,361
		COM Ydg	7	Ctn Wt	141	F	\$6,901
		COL Sq Ft	168	Cu Ft	60	G	\$7,478
						H	\$8,095
						I	\$9,057
						J	\$10,213
						L1	\$8,518
						L2	\$9,442

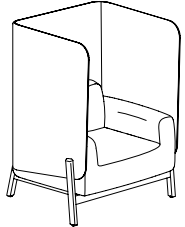
To Order, Specify:

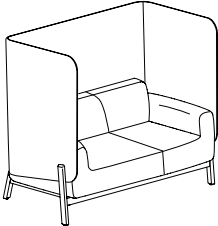
- 1 Model Number
- 2 Wood Species
 - a.) Maple (M)
 - b.) Walnut (WAL) - upcharge applies
 - c.) White Oak (WOL) - upcharge applies
- 3 Finish [See Finish Options](#)
 - a.) Maple Finish and Paint Color
 - b.) Walnut Finish
 - c.) White Oak Finish
- 4 Fabric Selection - vendor, pattern and color
 Visit www.jsifurniture.com/finishes-and-materials/textiles for our textiles program. See selection of standard and graded in manufacturers and patterns.
- 5 Optional Tablet Arm - indicate left (TBL) or right arm (TBR) as seated; Laminate (L) or Veneer (V)
- 6 Optional Power Unit - Black (B) or White (W); indicate left (PUL), right (PUR) or both left and right (PUB) arms as seated

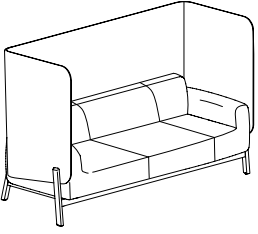
Specifications

- chair frame is puzzle jointed plywood construction
- back has a 3 7/8" tapered multi-density high resilience polyurethane foam
- arm has 3" multi-density polyurethane foam
- seat has synthetic sheet webbing and 5" multi-density high resilience polyurethane foam
- solid hardwood exterior frame
- mortise and tenon construction with corner blocks, glue and screws
- standard with rubber cushion adjustable metal leveling glides

Description	Model	Specifications	List Price Per Grade																									
Single Seat with Privacy Surround Grand Scale  <p>note: does not fit through standard single doorway</p>	CVF4043-52 <ul style="list-style-type: none"> · maple legs standard · walnut or white oak legs available, specify and add \$371 list · ships assembled · specify upholstery on seat separately from upholstery on surround · tablet arm available, specify and add \$733 list, indicate right or left as seated and finish or laminate · power available in the front of the upholstered chair, specify and add \$408 list, indicate right or left as seated and color 	<table border="1"> <thead> <tr> <th>Dimensions</th> <th>D</th> <th>W</th> <th>H</th> </tr> </thead> <tbody> <tr> <td>Overall</td> <td>40</td> <td>43</td> <td>52</td> </tr> <tr> <td>Seat</td> <td>21</td> <td>25</td> <td>17 ¾</td> </tr> <tr> <td>Arm</td> <td></td> <td></td> <td>25</td> </tr> </tbody> </table> <table border="1"> <thead> <tr> <th>Upholstery</th> <th colspan="2">Shipping</th> </tr> </thead> <tbody> <tr> <td>COM Ydg</td> <td>12</td> <td>Ctn Wt 194</td> </tr> <tr> <td>COL Sq Ft</td> <td>126</td> <td>Cu Ft 65</td> </tr> </tbody> </table> <p>*screen available in fabric only, no leather</p>	Dimensions	D	W	H	Overall	40	43	52	Seat	21	25	17 ¾	Arm			25	Upholstery	Shipping		COM Ydg	12	Ctn Wt 194	COL Sq Ft	126	Cu Ft 65	COM \$5,278 A \$5,408 B \$5,667 COL/C \$6,120 D \$6,701 E \$7,283 F \$8,187 G \$9,159 H \$10,192 I \$11,808 J \$13,748 L1 \$9,869 L2 \$11,162
		Dimensions	D	W	H																							
Overall	40	43	52																									
Seat	21	25	17 ¾																									
Arm			25																									
Upholstery	Shipping																											
COM Ydg	12	Ctn Wt 194																										
COL Sq Ft	126	Cu Ft 65																										

Single Seat with Privacy Surround 	CVF3540-52 <ul style="list-style-type: none"> · maple legs standard · walnut or white oak legs available, specify and add \$352 list · ships assembled · specify upholstery on seat separately from upholstery on surround · tablet arm available, specify and add \$733 list, indicate right or left as seated and finish or laminate · power available in the front of the upholstered chair, specify and add \$408 list, indicate right or left as seated and color 	<table border="1"> <thead> <tr> <th>Dimensions</th> <th>D</th> <th>W</th> <th>H</th> </tr> </thead> <tbody> <tr> <td>Overall</td> <td>35 ¼</td> <td>39 ½</td> <td>52</td> </tr> <tr> <td>Seat</td> <td>21</td> <td>23 ½</td> <td>17 ¾</td> </tr> <tr> <td>Arm</td> <td></td> <td></td> <td>25</td> </tr> </tbody> </table> <table border="1"> <thead> <tr> <th>Upholstery</th> <th colspan="2">Shipping</th> </tr> </thead> <tbody> <tr> <td>COM Ydg</td> <td>11</td> <td>Ctn Wt 176</td> </tr> <tr> <td>COL Sq Ft</td> <td>120</td> <td>Cu Ft 53</td> </tr> </tbody> </table> <p>*screen available in fabric only, no leather</p>	Dimensions	D	W	H	Overall	35 ¼	39 ½	52	Seat	21	23 ½	17 ¾	Arm			25	Upholstery	Shipping		COM Ydg	11	Ctn Wt 176	COL Sq Ft	120	Cu Ft 53	COM \$4,986 A \$5,108 B \$5,351 COL/C \$5,774 D \$6,321 E \$6,864 F \$7,712 G \$8,619 H \$9,588 I \$11,101 J \$12,918 L1 \$9,286 L2 \$10,496
		Dimensions	D	W	H																							
Overall	35 ¼	39 ½	52																									
Seat	21	23 ½	17 ¾																									
Arm			25																									
Upholstery	Shipping																											
COM Ydg	11	Ctn Wt 176																										
COL Sq Ft	120	Cu Ft 53																										

Two Seat with Privacy Surround 	CVF3564-52 <ul style="list-style-type: none"> · maple legs standard · walnut or white oak legs available, specify and add \$463 list · seat and surround ship assembled · specify upholstery on seat separately from upholstery on surround · tablet arm available, specify and add \$733 list per arm, indicate right, left, or both as seated and finish or laminate · power available in the front of the upholstered chair, specify and add \$408 list, indicate right, left or both as seated and color 	<table border="1"> <thead> <tr> <th>Dimensions</th> <th>D</th> <th>W</th> <th>H</th> </tr> </thead> <tbody> <tr> <td>Overall</td> <td>35 ¼</td> <td>65 ½</td> <td>52</td> </tr> <tr> <td>Seat</td> <td>21</td> <td>47 ½</td> <td>17 ¾</td> </tr> <tr> <td>Arm</td> <td></td> <td></td> <td>25</td> </tr> </tbody> </table> <table border="1"> <thead> <tr> <th>Upholstery</th> <th colspan="2">Shipping</th> </tr> </thead> <tbody> <tr> <td>COM Ydg</td> <td>13 ½</td> <td>Ctn Wt 243</td> </tr> <tr> <td>COL Sq Ft</td> <td>144</td> <td>Cu Ft 85</td> </tr> </tbody> </table> <p>*screen available in fabric only, no leather</p>	Dimensions	D	W	H	Overall	35 ¼	65 ½	52	Seat	21	47 ½	17 ¾	Arm			25	Upholstery	Shipping		COM Ydg	13 ½	Ctn Wt 243	COL Sq Ft	144	Cu Ft 85	COM \$6,284 A \$6,434 B \$6,731 COL/C \$7,250 D \$7,920 E \$8,588 F \$9,628 G \$10,741 H \$11,931 I \$13,788 J \$16,017 L1 \$11,559 L2 \$13,045
		Dimensions	D	W	H																							
Overall	35 ¼	65 ½	52																									
Seat	21	47 ½	17 ¾																									
Arm			25																									
Upholstery	Shipping																											
COM Ydg	13 ½	Ctn Wt 243																										
COL Sq Ft	144	Cu Ft 85																										

Description	Model	Specifications				List Price Per Grade	
		Dimensions	D	W	H	COM	
Three Seat with Privacy Surround 	CVF3588-52 • maple legs standard • walnut or white oak legs available, specify and add \$579 list • seat and surround ship assembled • specify upholstery on seat separately from upholstery on surround • power available in the front of the upholstered chair, specify and add \$408 list, indicate right, left or both as seated and color	Overall	35 ¼	87 ½	52	COM	\$7,241
		Seat	21	71 ½	17 ¾	COL/C	\$8,368
		Arm			25	D	\$9,150
		Upholstery		Shipping		E	\$9,929
		COM Ydg	15 ¾	Ctn Wt	273	F	\$11,142
		COL Sq Ft	168	Cu Ft	112	G	\$12,443
		*screen available in fabric only, no leather				H	\$13,829
						I	\$15,996
						J	\$18,596
						L1	\$13,396
						L2	\$15,128

To Order, Specify:

- 1 Model Number
- 2 Wood Species
 - a.) Maple (M)
 - b.) Walnut (WAL) - upcharge applies
 - c.) White Oak (WOL) - upcharge applies
- 3 Finish [See Finish Options](#)
 - a.) Maple Finish and Paint Color
 - b.) Walnut Finish
 - c.) White Oak Finish
- 4 Fabric Selection - vendor, pattern and color
 Visit www.jsifurniture.com/finishes-and-materials/textiles for our textiles program. See selection of standard and graded in manufacturers and patterns.
- 5 Optional Tablet Arm - indicate left (TBL) or right arm (TBR) as seated; Laminate (L) or Veneer (V)
- 6 Optional Power Unit - Black (B) or White (W); indicate left (PUL) or right (PUR) arms as seated

Specifications

- chair frame is puzzle jointed plywood construction
- back has a 3 7/8" tapered multi-density high resilience polyurethane foam
- arm has 3" multi-density polyurethane foam
- seat has synthetic sheet webbing and 5" multi-density high resilience polyurethane foam
- solid hardwood exterior frame
- mortise and tenon construction with corner blocks, glue and screws
- standard with rubber cushion adjustable metal leveling glides
- surround produced from molded plywood construction
- railroad upholstery on screens
- chair and privacy surround ships assembled
- privacy wing and hood requires field installation
- false welt detail around the perimeter of surround

Description

Model

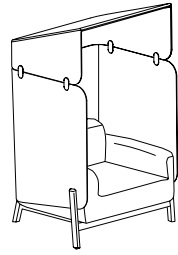
Specifications

List Price Per Grade

Single Seat with Privacy Surround and Hood
Grand Scale

CVF4043-72

- maple legs standard
- walnut or white oak legs available, specify and add \$371 list
- seat and surround ship assembled - hood ships separately
- specify upholstery on seat separately from upholstery on surround/hood
- tablet arm available, specify and add \$733 list, indicate right or left as seated and finish or laminate
- power available in the front of the upholstered chair, specify and add \$408 list, indicate right or left as seated and color



note: does not fit through standard single doorway

Dimensions	D	W	H
Overall	40	43	72
Seat	21	25	17 ¾
Arm			25
Upholstery		Shipping	
COM Ydg	18	Ctn Wt	259
COL Sq Ft	126	Cu Ft	86

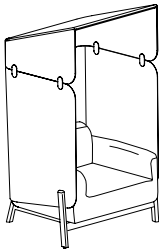
*screen available in fabric only, no leather

COM	\$7,078
A	\$7,277
B	\$7,674
COL/C	\$8,367
D	\$9,257
E	\$10,149
F	\$11,536
G	\$13,022
H	\$14,607
I	\$17,082
J	\$20,055
L1	\$14,111
L2	\$16,093

Single Seat with Privacy Surround and Hood

CVF3540-72

- maple legs standard
- walnut or white oak legs available, specify and add \$352 list
- seat and surround ship assembled - hood ships separately
- specify upholstery on seat separately from upholstery on surround/hood
- tablet arm available, specify and add \$733 list, indicate right or left as seated and finish or laminate
- power available in the front of the upholstered chair, specify and add \$408 list, indicate right or left as seated and color



Dimensions	D	W	H
Overall	35 ¼	39 ½	72
Seat	21	23 ½	17 ¾
Arm			25
Upholstery		Shipping	
COM Ydg	16 ½	Ctn Wt	236
COL Sq Ft	120	Cu Ft	71

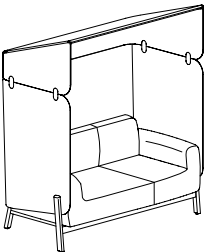
*screen available in fabric only, no leather

COM	\$6,665
A	\$6,849
B	\$7,212
COL/C	\$7,846
D	\$8,664
E	\$9,481
F	\$10,752
G	\$12,115
H	\$13,566
I	\$15,838
J	\$18,560
L1	\$13,112
L2	\$14,929

Two Seat with Privacy Surround and Hood

CVF3564-72

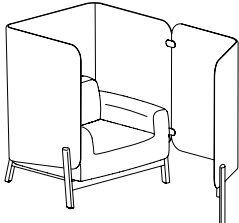
- maple legs standard
- walnut or white oak legs available, specify and add \$463 list
- seat and surround ship assembled - hood ships separately
- specify upholstery on seat separately from upholstery on surround/hood
- tablet arm available, specify and add \$733 list per arm, indicate right, left, or both as seated and finish or laminate
- power available in the front of the upholstered chair, specify and add \$408 list, indicate right, left or both as seated and color

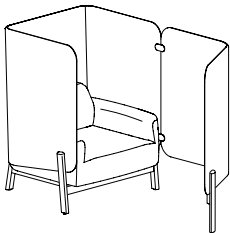


Dimensions	D	W	H
Overall	35 ¼	65 ½	72
Seat	21	47 ½	17 ¾
Arm			25
Upholstery		Shipping	
COM Ydg	21 ½	Ctn Wt	315
COL Sq Ft	144	Cu Ft	113

*screen available in fabric only, no leather

COM	\$8,539
A	\$8,777
B	\$9,250
COL/C	\$10,079
D	\$11,143
E	\$12,208
F	\$13,865
G	\$15,639
H	\$17,532
I	\$20,490
J	\$24,038
L1	\$16,941
L2	\$19,306

Description	Model	Specifications	List Price Per Grade																												
Single Seat with Privacy Surround and Privacy Wing Grand Scale  left shown note: does not fit through standard single doorway	CVF8343-52-R CVF8343-52-L <ul style="list-style-type: none"> maple legs standard walnut or white oak legs available, specify and add \$444 list seat and surround ship assembled - wing ships separately specify upholstery on seat separately from upholstery on surround/wing tablet arm available, specify and add \$733 list, indicate right or left as seated and finish or laminate power available in the front of the upholstered chair, specify and add \$408 list, indicate right or left as seated and color 	<table border="1"> <thead> <tr> <th>Dimensions</th> <th>D</th> <th>W</th> <th>H</th> </tr> </thead> <tbody> <tr> <td>Overall</td> <td>83 ¼</td> <td>43</td> <td>52</td> </tr> <tr> <td>Seat</td> <td>21</td> <td>25</td> <td>17 ¾</td> </tr> <tr> <td>Arm</td> <td colspan="3">25</td> </tr> <tr> <th colspan="2">Upholstery</th> <th colspan="2">Shipping</th> </tr> <tr> <td>COM Ydg</td> <td>15 ½</td> <td>Ctn Wt</td> <td>245</td> </tr> <tr> <td>COL Sq Ft</td> <td>126</td> <td>Cu Ft</td> <td>92</td> </tr> </tbody> </table> <p>*screen available in fabric only, no leather</p>	Dimensions	D	W	H	Overall	83 ¼	43	52	Seat	21	25	17 ¾	Arm	25			Upholstery		Shipping		COM Ydg	15 ½	Ctn Wt	245	COL Sq Ft	126	Cu Ft	92	COM \$6,559 A \$6,732 B \$7,073 COL/C \$7,670 D \$8,437 E \$9,205 F \$10,399 G \$11,678 H \$13,044 I \$15,177 J \$17,734 L1 \$12,617 L2 \$14,323
	Dimensions	D	W	H																											
Overall	83 ¼	43	52																												
Seat	21	25	17 ¾																												
Arm	25																														
Upholstery		Shipping																													
COM Ydg	15 ½	Ctn Wt	245																												
COL Sq Ft	126	Cu Ft	92																												

Single Seat with Privacy Surround and Privacy Wing  left shown	CVF7940-52-R CVF7940-52-L <ul style="list-style-type: none"> maple legs standard walnut or white oak legs available, specify and add \$426 list seat and surround ship assembled - wing ships separately specify upholstery on seat separately from upholstery on surround/wing tablet arm available, specify and add \$733 list, indicate right or left as seated and finish or laminate power available in the front of the upholstered chair, specify and add \$408 list, indicate right or left as seated and color 	<table border="1"> <thead> <tr> <th>Dimensions</th> <th>D</th> <th>W</th> <th>H</th> </tr> </thead> <tbody> <tr> <td>Overall</td> <td>78 ½</td> <td>39 ½</td> <td>52</td> </tr> <tr> <td>Seat</td> <td>21</td> <td>23 ½</td> <td>17 ¾</td> </tr> <tr> <td>Arm</td> <td colspan="3">25</td> </tr> <tr> <th colspan="2">Upholstery</th> <th colspan="2">Shipping</th> </tr> <tr> <td>COM Ydg</td> <td>14 ½</td> <td>Ctn Wt</td> <td>227</td> </tr> <tr> <td>COL Sq Ft</td> <td>120</td> <td>Cu Ft</td> <td>80</td> </tr> </tbody> </table> <p>*screen available in fabric only, no leather</p>	Dimensions	D	W	H	Overall	78 ½	39 ½	52	Seat	21	23 ½	17 ¾	Arm	25			Upholstery		Shipping		COM Ydg	14 ½	Ctn Wt	227	COL Sq Ft	120	Cu Ft	80	COM \$6,280 A \$6,441 B \$6,760 COL/C \$7,318 D \$8,036 E \$8,754 F \$9,871 G \$11,069 H \$12,346 I \$14,339 J \$16,734 L1 \$11,946 L2 \$13,542
	Dimensions	D	W	H																											
Overall	78 ½	39 ½	52																												
Seat	21	23 ½	17 ¾																												
Arm	25																														
Upholstery		Shipping																													
COM Ydg	14 ½	Ctn Wt	227																												
COL Sq Ft	120	Cu Ft	80																												

To Order, Specify:

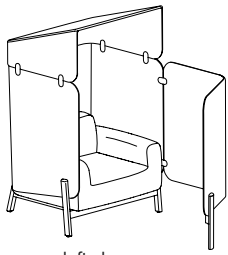
- Model Number
- Wood Species
 - Maple (M)
 - Walnut (WAL) - upcharge applies
 - White Oak (WOL) - upcharge applies
- Finish [See Finish Options](#)
 - Maple Finish and Paint Color
 - Walnut Finish
 - White Oak Finish
- Fabric Selection - vendor, pattern and color
 Visit www.jsifurniture.com/finishes-and-materials/textiles for our textiles program. See selection of standard and graded in manufacturers and patterns.
- Metal Color - [See Metal Color Options](#)
- Optional Tablet Arm - indicate left (TBL) or right arm (TBR) as seated; Laminate (L) or Veneer (V)
- Optional Seating Power Unit - Black (B) or White (W); indicate left (PUL) or right (PUR) arms as seated

Specifications

- chair frame is puzzle jointed plywood construction
- back has a 3 7/8" tapered multi-density high resilience polyurethane foam
- arm has 3" multi-density polyurethane foam
- seat has synthetic sheet webbing and 5" multi-density high resilience polyurethane foam
- solid hardwood exterior frame
- mortise and tenon construction with corner blocks, glue and screws
- standard with rubber cushion adjustable metal leveling glides
- surround produced from molded plywood construction
- railroad upholstery on screens
- chair and privacy surround ships assembled
- privacy wing and hood requires field installation
- false welt detail around the perimeter of surround

Description

Single Seat with Privacy Surround,
Hood and Privacy Wing
Grand Scale



left shown

note: does not fit through standard
single doorway

Model

CVF8343-72-R
CVF8343-72-L

- maple legs standard
- walnut or white oak legs available, specify and add \$444 list
- seat and surround ship assembled - wing and hood ships separately
- specify upholstery on seat separately from upholstery on surround/hood/wing
- tablet arm available, specify and add \$733 list, indicate right or left as seated and finish or laminate
- power available in the front of the upholstered chair, specify and add \$408 list indicate right or left as seated and color

Specifications

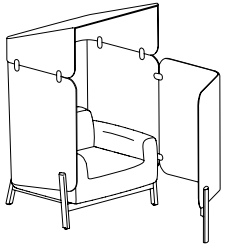
Dimensions	D	W	H
Overall	83 ¼	43	72
Seat	21	25	17 ¾
Arm			25
Upholstery		Shipping	
COM Ydg	21 ½	Ctn Wt	305
COL Sq Ft	126	Cu Ft	113

*screen available in fabric only, no leather

List Price Per Grade

COM	\$8,367
A	\$8,605
B	\$9,078
COL/C	\$9,908
D	\$10,971
E	\$12,036
F	\$13,693
G	\$15,468
H	\$17,360
I	\$20,317
J	\$23,867
L1	\$16,769
L2	\$19,134

Single Seat with Privacy Surround,
Hood and Privacy Wing



left shown

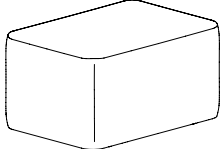
CVF7940-72-R
CVF7940-72-L

- maple legs standard
- walnut or white oak legs available, specify and add \$426 list
- seat and surround ship assembled - hood and wing ships separately
- specify upholstery on seat separately from upholstery on surround/hood/wing
- tablet arm available, specify and add \$733 list, indicate right or left as seated and finish or laminate
- power available in the front of the upholstered chair, specify and add \$408 list indicate right or left as seated and color

Dimensions	D	W	H
Overall	78 ½	39 ½	72
Seat	21	23 ½	17 ¾
Arm			25
Upholstery		Shipping	
COM Ydg	20	Ctn Wt	292
COL Sq Ft	120	Cu Ft	98

*screen available in fabric only, no leather

COM	\$8,009
A	\$8,230
B	\$8,671
COL/C	\$9,441
D	\$10,432
E	\$11,421
F	\$12,963
G	\$14,613
H	\$16,374
I	\$19,125
J	\$22,426
L1	\$15,823
L2	\$18,025

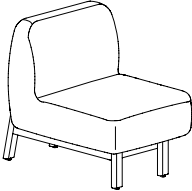
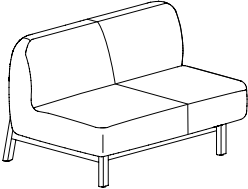
Description	① Model	Specifications				List Price Per Grade	
Ottoman 	CVO1623-12	Dimensions	D	W	H	COM	\$767
		Overall	16 ¼	23	12	A	\$785
		Upholstery	Shipping			B	\$816
		COM Ydg	1 ½	Ctn Wt	22	COL/C	\$875
		COL Sq Ft	27	Cu Ft	4	D	\$949
				E	\$1,023		
				F	\$1,139		
				G	\$1,262		
				H	\$1,396		
				I	\$1,602		
				J	\$1,850		
				L1	\$1,288		
				L2	\$1,437		

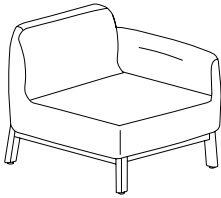
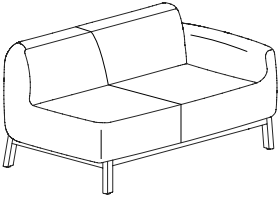
To Order, Specify:

- ① Model Number
- ② Wood Species
 - a.) Maple (M)
 - b.) Walnut (WAL) - upcharge applies
 - c.) White Oak (WOL) - upcharge applies
- ③ Finish [See Finish Options](#)
 - a.) Maple Finish and Paint Color
 - b.) Walnut Finish
 - c.) White Oak Finish
- ④ Fabric Selection - vendor, pattern and color
 Visit www.jsifurniture.com/finishes-and-materials/textiles for our textiles program. See selection of standard and graded in manufacturers and patterns.
- ⑤ Metal Color - [See Metal Color Options](#)
- ⑥ Optional Tablet Arm - indicate left (TBL) or right arm (TBR) as seated; Laminate (L) or Veneer (V)
- ⑦ Optional Seating Power Unit - Black (B) or White (W); indicate left (PUL) or right (PUR) arms as seated

Specifications

- chair frame is puzzle jointed plywood construction
- back has a 3 7/8" tapered multi-density high resilience polyurethane foam
- arm has 3" multi-density polyurethane foam
- seat has synthetic sheet webbing and 5" multi-density high resilience polyurethane foam
- solid hardwood exterior frame
- mortise and tenon construction with corner blocks, glue and screws
- standard with rubber cushion adjustable metal leveling glides
- surround produced from molded plywood construction
- railroad upholstery on screens
- chair and privacy surround ships assembled
- privacy wing and hood requires field installation
- false welt detail around the perimeter of surround

Description	Model	Specifications	List Price Per Grade																
Single Seat 	CVM3425-31 · maple legs standard · walnut or white oak legs available, specify and add \$253 list	<table border="1"> <thead> <tr> <th>Dimensions</th> <th>D</th> <th>W</th> <th>H</th> </tr> </thead> <tbody> <tr> <td>Overall</td> <td>34 ¼</td> <td>25</td> <td>30 ½</td> </tr> <tr> <td>Seat</td> <td>20</td> <td>25</td> <td>17 ¾</td> </tr> <tr> <td>Arm</td> <td></td> <td></td> <td>-</td> </tr> </tbody> </table>	Dimensions	D	W	H	Overall	34 ¼	25	30 ½	Seat	20	25	17 ¾	Arm			-	COM \$2,324 A \$2,356 B \$2,415 COL/C \$2,522 D \$2,658 E \$2,795 F \$3,006 G \$3,232 H \$3,475 I \$3,853 J \$4,308 L1 \$3,399 L2 \$3,703
		Dimensions	D	W	H														
Overall	34 ¼	25	30 ½																
Seat	20	25	17 ¾																
Arm			-																
<table border="1"> <thead> <tr> <th>Upholstery</th> <th colspan="3">Shipping</th> </tr> </thead> <tbody> <tr> <td>COM Ydg</td> <td>2 ¾</td> <td>Ctn Wt</td> <td>63</td> </tr> <tr> <td>COL Sq Ft</td> <td>61</td> <td>Cu Ft</td> <td>18</td> </tr> </tbody> </table>	Upholstery	Shipping			COM Ydg	2 ¾	Ctn Wt	63	COL Sq Ft	61	Cu Ft	18							
Upholstery	Shipping																		
COM Ydg	2 ¾	Ctn Wt	63																
COL Sq Ft	61	Cu Ft	18																
Two Seat 	CVM3450-31 · maple legs standard · walnut or white oak legs available, specify and add \$340 list	<table border="1"> <thead> <tr> <th>Dimensions</th> <th>D</th> <th>W</th> <th>H</th> </tr> </thead> <tbody> <tr> <td>Overall</td> <td>34 ¼</td> <td>50</td> <td>30 ½</td> </tr> <tr> <td>Seat</td> <td>20</td> <td>50</td> <td>17 ¾</td> </tr> <tr> <td>Arm</td> <td></td> <td></td> <td>-</td> </tr> </tbody> </table>	Dimensions	D	W	H	Overall	34 ¼	50	30 ½	Seat	20	50	17 ¾	Arm			-	COM \$3,053 A \$3,098 B \$3,186 COL/C \$3,341 D \$3,540 E \$3,737 F \$4,045 G \$4,374 H \$4,727 I \$5,278 J \$5,937 L1 \$5,057 L2 \$5,607
		Dimensions	D	W	H														
Overall	34 ¼	50	30 ½																
Seat	20	50	17 ¾																
Arm			-																
<table border="1"> <thead> <tr> <th>Upholstery</th> <th colspan="3">Shipping</th> </tr> </thead> <tbody> <tr> <td>COM Ydg</td> <td>4</td> <td>Ctn Wt</td> <td>85</td> </tr> <tr> <td>COL Sq Ft</td> <td>99</td> <td>Cu Ft</td> <td>34</td> </tr> </tbody> </table>	Upholstery	Shipping			COM Ydg	4	Ctn Wt	85	COL Sq Ft	99	Cu Ft	34							
Upholstery	Shipping																		
COM Ydg	4	Ctn Wt	85																
COL Sq Ft	99	Cu Ft	34																

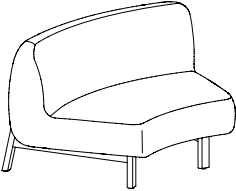
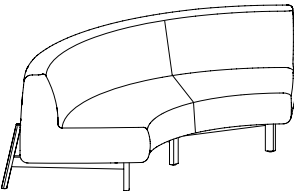
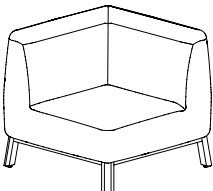
Description	① Model	Specifications	List Price Per Grade																												
Single Seat with Arm  left shown	CVM3433-31-R CVM3433-31-L <ul style="list-style-type: none"> maple legs standard walnut or white oak legs available, specify and add \$272 list tablet arm available, specify and add \$733 list, indicate finish or laminate power available in the front of the upholstered chair, specify and add \$408 list, indicate color 	<table border="1"> <thead> <tr> <th>Dimensions</th> <th>D</th> <th>W</th> <th>H</th> </tr> </thead> <tbody> <tr> <td>Overall</td> <td>34 ¼</td> <td>32 ½</td> <td>30 ½</td> </tr> <tr> <td>Seat</td> <td>20</td> <td>23 ½</td> <td>17 ¾</td> </tr> <tr> <td>Arm</td> <td></td> <td></td> <td>25</td> </tr> <tr> <th colspan="2">Upholstery</th> <th colspan="2">Shipping</th> </tr> <tr> <td>COM Ydg</td> <td>3 ½</td> <td>Ctn Wt</td> <td>69</td> </tr> <tr> <td>COL Sq Ft</td> <td>77</td> <td>Cu Ft</td> <td>23</td> </tr> </tbody> </table>	Dimensions	D	W	H	Overall	34 ¼	32 ½	30 ½	Seat	20	23 ½	17 ¾	Arm			25	Upholstery		Shipping		COM Ydg	3 ½	Ctn Wt	69	COL Sq Ft	77	Cu Ft	23	COM \$2,792 A \$2,831 B \$2,908 COL/C \$3,043 D \$3,215 E \$3,389 F \$3,660 G \$3,949 H \$4,256 I \$4,737 J \$5,315 L1 \$4,315 L2 \$4,737
		Dimensions	D	W	H																										
Overall	34 ¼	32 ½	30 ½																												
Seat	20	23 ½	17 ¾																												
Arm			25																												
Upholstery		Shipping																													
COM Ydg	3 ½	Ctn Wt	69																												
COL Sq Ft	77	Cu Ft	23																												
Two Seat with Arm  left shown	CVM3458-31-R CVM3458-31-L <ul style="list-style-type: none"> maple legs standard walnut or white oak legs available, specify and add \$357 list tablet arm available, specify and add \$733 list, indicate finish or laminate power available in the front of the upholstered chair, specify and add \$408 list, indicate color 	<table border="1"> <thead> <tr> <th>Dimensions</th> <th>D</th> <th>W</th> <th>H</th> </tr> </thead> <tbody> <tr> <td>Overall</td> <td>34 ¼</td> <td>57 ½</td> <td>30 ½</td> </tr> <tr> <td>Seat</td> <td>20</td> <td>48 ½</td> <td>17 ¾</td> </tr> <tr> <td>Arm</td> <td></td> <td></td> <td>25</td> </tr> <tr> <th colspan="2">Upholstery</th> <th colspan="2">Shipping</th> </tr> <tr> <td>COM Ydg</td> <td>5</td> <td>Ctn Wt</td> <td>101</td> </tr> <tr> <td>COL Sq Ft</td> <td>110</td> <td>Cu Ft</td> <td>39</td> </tr> </tbody> </table>	Dimensions	D	W	H	Overall	34 ¼	57 ½	30 ½	Seat	20	48 ½	17 ¾	Arm			25	Upholstery		Shipping		COM Ydg	5	Ctn Wt	101	COL Sq Ft	110	Cu Ft	39	COM \$3,634 A \$3,690 B \$3,800 COL/C \$3,994 D \$4,240 E \$4,488 F \$4,873 G \$5,286 H \$5,727 I \$6,415 J \$7,240 L1 \$5,808 L2 \$6,415
		Dimensions	D	W	H																										
Overall	34 ¼	57 ½	30 ½																												
Seat	20	48 ½	17 ¾																												
Arm			25																												
Upholstery		Shipping																													
COM Ydg	5	Ctn Wt	101																												
COL Sq Ft	110	Cu Ft	39																												

To Order, Specify:

- ① Model Number
- ② Wood Species
 - a.) Maple (M)
 - b.) Walnut (WAL) - upcharge applies
 - c.) White Oak (WOL) - upcharge applies
- ③ Finish [See Finish Options](#)
 - a.) Maple Finish and Paint Color
 - b.) Walnut Finish
 - c.) White Oak Finish
- ④ Fabric Selection - vendor, pattern and color
 Visit www.jsifurniture.com/finishes-and-materials/textiles for our textiles program. See selection of standard and graded in manufacturers and patterns.
- ⑤ Optional Tablet Arm - indicate left (TBL) or right arm (TBR) as seated; Laminate (L) or Veneer (V)
- ⑥ Optional Seating Power Unit - Black (B) or White (W); indicate left (PUL) or right (PUR) arms as seated

Specifications

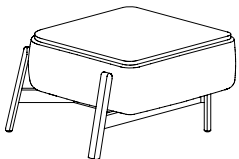
- chair frame is puzzle jointed plywood construction
- back has a 3 ¾" tapered multi-density high resilience polyurethane foam
- arm has 3" multi-density polyurethane foam
- seat has synthetic sheet webbing and 5" multi-density high resilience polyurethane foam
- solid hardwood exterior frame
- mortise and tenon construction with corner blocks, glue and screws
- standard with rubber cushion adjustable metal leveling glides
- linking brackets included

Description	① Model	Specifications	List Price Per Grade																
45° Curved Seat 	CVM4536-31 · maple legs standard · walnut or white oak legs available, specify and add \$309 list	<table border="1"> <thead> <tr> <th>Dimensions</th> <th>D</th> <th>W</th> <th>H</th> </tr> </thead> <tbody> <tr> <td>Overall</td> <td>34</td> <td>50 ¼</td> <td>30 ½</td> </tr> <tr> <td>Seat</td> <td>20</td> <td>-</td> <td>17 ¾</td> </tr> </tbody> </table>	Dimensions	D	W	H	Overall	34	50 ¼	30 ½	Seat	20	-	17 ¾	COM \$3,143 A \$3,193 B \$3,294 COL/C \$3,466 D \$3,689 E \$3,913 F \$4,258 G \$4,629 H \$5,027 I \$5,645 J \$6,389 L1 \$5,101 L2 \$5,645				
		Dimensions	D	W	H														
Overall	34	50 ¼	30 ½																
Seat	20	-	17 ¾																
<table border="1"> <thead> <tr> <th>Upholstery</th> <th colspan="3">Shipping</th> </tr> </thead> <tbody> <tr> <td>COM Ydg</td> <td>4 ½</td> <td>Ctn Wt</td> <td>81</td> </tr> <tr> <td>COL Sq Ft</td> <td>99</td> <td>Cu Ft</td> <td>35</td> </tr> </tbody> </table>	Upholstery	Shipping			COM Ydg	4 ½	Ctn Wt	81	COL Sq Ft	99	Cu Ft	35							
Upholstery	Shipping																		
COM Ydg	4 ½	Ctn Wt	81																
COL Sq Ft	99	Cu Ft	35																
90° Curved Seat 	CVM9036-31 · maple legs standard · walnut or white oak legs available, specify and add \$542 list	<table border="1"> <thead> <tr> <th>Dimensions</th> <th>D</th> <th>W</th> <th>H</th> </tr> </thead> <tbody> <tr> <td>Overall</td> <td>45</td> <td>93 ¼</td> <td>30 ½</td> </tr> <tr> <td>Seat</td> <td>20</td> <td>-</td> <td>17 ¾</td> </tr> </tbody> </table>	Dimensions	D	W	H	Overall	45	93 ¼	30 ½	Seat	20	-	17 ¾	COM \$5,253 A \$5,336 B \$5,502 COL/C \$5,791 D \$6,163 E \$6,534 F \$7,110 G \$7,729 H \$8,389 I \$9,422 J \$10,660 L1 \$9,371 L2 \$10,495				
		Dimensions	D	W	H														
Overall	45	93 ¼	30 ½																
Seat	20	-	17 ¾																
<table border="1"> <thead> <tr> <th>Upholstery</th> <th colspan="3">Shipping</th> </tr> </thead> <tbody> <tr> <td>COM Ydg</td> <td>7 ½</td> <td>Ctn Wt</td> <td>120</td> </tr> <tr> <td>COL Sq Ft</td> <td>204</td> <td>Cu Ft</td> <td>83</td> </tr> </tbody> </table>	Upholstery	Shipping			COM Ydg	7 ½	Ctn Wt	120	COL Sq Ft	204	Cu Ft	83							
Upholstery	Shipping																		
COM Ydg	7 ½	Ctn Wt	120																
COL Sq Ft	204	Cu Ft	83																
Corner Seat 	CVM3434-31-C · maple legs standard · walnut or white oak legs available, specify and add \$346 list · fabric on seat of unit runs diagonal	<table border="1"> <thead> <tr> <th>Dimensions</th> <th>D</th> <th>W</th> <th>H</th> </tr> </thead> <tbody> <tr> <td>Overall</td> <td>34 ¼</td> <td>34 ¼</td> <td>30 ½</td> </tr> <tr> <td>Seat</td> <td>20</td> <td>20</td> <td>17 ¾</td> </tr> <tr> <td>Arm</td> <td></td> <td></td> <td>-</td> </tr> </tbody> </table>	Dimensions	D	W	H	Overall	34 ¼	34 ¼	30 ½	Seat	20	20	17 ¾	Arm			-	COM \$2,856 A \$2,897 B \$2,979 COL/C \$3,125 D \$3,311 E \$3,497 F \$3,785 G \$4,094 H \$4,424 I \$4,940 J \$5,559 L1 \$4,322 L2 \$4,734
		Dimensions	D	W	H														
Overall	34 ¼	34 ¼	30 ½																
Seat	20	20	17 ¾																
Arm			-																
<table border="1"> <thead> <tr> <th>Upholstery</th> <th colspan="3">Shipping</th> </tr> </thead> <tbody> <tr> <td>COM Ydg</td> <td>3 ¾</td> <td>Ctn Wt</td> <td>72</td> </tr> <tr> <td>COL Sq Ft</td> <td>83</td> <td>Cu Ft</td> <td>24</td> </tr> </tbody> </table>	Upholstery	Shipping			COM Ydg	3 ¾	Ctn Wt	72	COL Sq Ft	83	Cu Ft	24							
Upholstery	Shipping																		
COM Ydg	3 ¾	Ctn Wt	72																
COL Sq Ft	83	Cu Ft	24																

To Order, Specify:

- ① Model Number
- ② Wood Species
 - a.) Maple (M)
 - b.) Walnut (WAL) - upcharge applies
 - c.) White Oak (WOL) - upcharge applies
- ③ Finish [See Wood Finish Options](#)
 - a.) Maple Finish and Paint Color
 - b.) Walnut Finish
 - c.) White Oak Finish

④ Fabric Selection - vendor, pattern and color
 Visit www.jsifurniture.com/finishes-and-materials/textiles for our textiles program. See selection of standard and graded in manufacturers and patterns.

Description	① Model	Specifications				List Price Per Grade	
Comer Table 	CVT3434-19-C • maple legs standard • walnut or white oak legs available, specify and add \$346 list • power available in surface, specify and add \$408 list, indicate color • surface available in veneer or laminate with 1mm band	Dimensions		D	W	H	COM \$1,976
		Overall		34 ¼	34 ¼	19	A \$1,998
		Upholstery		Shipping			B \$2,042
		COM Ydg	2	Ctn Wt	70	COL/C \$2,120	
		COL Sq Ft	44	Cu Ft	16	D \$2,220	
				E \$2,318			
				F \$2,472			
				G \$2,637			
				H \$2,813			
				I \$3,089			
				J \$3,418			
				L1 \$2,846			
				L2 \$3,089			

CĀAV

To Order, Specify:

- ① Model Number
- ② Table Top Surface Material [See Table Top Surface Options](#)
 - a.) Laminate Surface
 - b.) Veneer Surface
 - 1.) Cherry Flat Cut (CH1)
 - 2.) Maple Flat Cut (MA1)
 - 3.) Walnut Flat Cut (WA1)
 - 4.) White Oak (WO)
- ③ Fabric Selection - vendor, pattern and color
 Visit www.jsifurniture.com/finishes-and-materials/textiles for our textiles program. See selection of standard and graded in manufacturers and patterns.
- ④ Optional Surface Power Unit - Black (B) or White (W)

Specifications

- chair frame is puzzle jointed plywood construction
- back has a 3 ¾" tapered multi-density high resilience polyurethane foam
- arm has 3" multi-density polyurethane foam
- seat has synthetic sheet webbing and 5" multi-density high resilience polyurethane foam
- solid hardwood exterior frame
- mortise and tenon construction with corner blocks, glue and screws
- standard with rubber cushion adjustable metal leveling glides
- linking brackets included

Description

Model

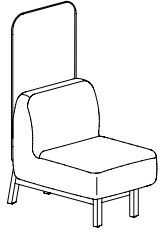
Specifications

List Price Per Grade

Single Seat with 52h Screen"

CVM3425-52

- maple legs standard
- walnut or white oak legs available, specify and add \$253 list
- seat and screen ship assembled
- specify upholstery on seat separately from upholstery on screen



Dimensions	D	W	H
Overall	34 ¼	25	52
Seat	20	25	17 ¾
Upholstery		Shipping	
COM Ydg	4 ½	Ctn Wt	115
COL Sq Ft	61	Cu Ft	33

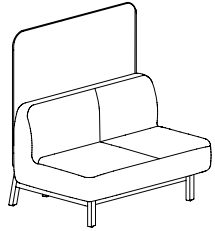
*screen available in fabric only, no leather

- COM \$3,056
- A \$3,106
- B \$3,206
- COL/C \$3,379
- D \$3,601
- E \$3,825
- F \$4,171
- G \$4,543
- H \$4,939
- I \$5,557
- J \$6,301
- L1 \$4,815
- L2 \$5,310

Two Seat with 52h Screen"

CVM3450-52

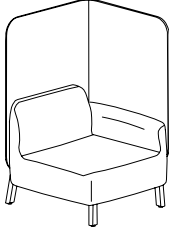
- maple legs standard
- walnut or white oak legs available, specify and add \$340 list
- seat and screen ship assembled
- specify upholstery on seat separately from upholstery on screen

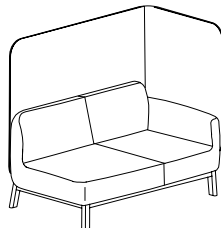


Dimensions	D	W	H
Overall	34 ¼	50	52
Seat	20	50	17 ¾
Upholstery		Shipping	
COM Ydg	7	Ctn Wt	165
COL Sq Ft	99	Cu Ft	64

*screen available in fabric only, no leather

- COM \$4,144
- A \$4,221
- B \$4,375
- COL/C \$4,645
- D \$4,991
- E \$5,340
- F \$5,878
- G \$6,455
- H \$7,073
- I \$8,035
- J \$9,190
- L1 \$6,879
- L2 \$7,650

Description	1 Model	Specifications	List Price Per Grade																												
Single Seat with Arm and 52h Screen"  left shown	CVM3533-52-R CVM3533-52-L <ul style="list-style-type: none"> maple legs standard walnut or white oak legs available, specify and add \$272 list seat and surround ship assembled specify upholstery on seat separately from upholstery on screen tablet arm available, specify and add \$733 list, indicate finish or laminate power available in the front of the upholstered chair, specify and add \$408 list, indicate color 	<table border="1"> <thead> <tr> <th>Dimensions</th> <th>D</th> <th>W</th> <th>H</th> </tr> </thead> <tbody> <tr> <td>Overall</td> <td>35 ¼</td> <td>32 ½</td> <td>52</td> </tr> <tr> <td>Seat</td> <td>20</td> <td>23 ½</td> <td>17 ¾</td> </tr> <tr> <td>Arm</td> <td colspan="3">25</td> </tr> <tr> <th colspan="2">Upholstery</th> <th colspan="2">Shipping</th> </tr> <tr> <td>COM Ydg</td> <td>7 ¼</td> <td>Ctn Wt</td> <td>146</td> </tr> <tr> <td>COL Sq Ft</td> <td>77</td> <td>Cu Ft</td> <td>44</td> </tr> </tbody> </table>	Dimensions	D	W	H	Overall	35 ¼	32 ½	52	Seat	20	23 ½	17 ¾	Arm	25			Upholstery		Shipping		COM Ydg	7 ¼	Ctn Wt	146	COL Sq Ft	77	Cu Ft	44	COM \$4,089 A \$4,168 B \$4,329 COL/C \$4,607 D \$4,967 E \$5,326 F \$5,884 G \$6,484 H \$7,122 I \$8,118 J \$9,316 L1 \$6,922 L2 \$7,200
		Dimensions	D	W	H																										
Overall	35 ¼	32 ½	52																												
Seat	20	23 ½	17 ¾																												
Arm	25																														
Upholstery		Shipping																													
COM Ydg	7 ¼	Ctn Wt	146																												
COL Sq Ft	77	Cu Ft	44																												
		*screen available in fabric only, no leather																													

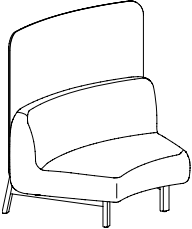
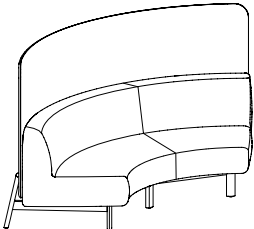
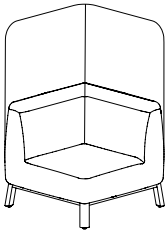
Two Seat with Arm and 52h Screen"  left shown	CVM3558-52-R CVM3558-52-L <ul style="list-style-type: none"> maple legs standard walnut or white oak legs available, specify and add \$357 list seat and surround ship assembled specify upholstery on seat separately from upholstery on screen tablet arm available, specify and add \$733 list, indicate finish or laminate power available in the front of the upholstered chair, specify and add \$408 list, indicate color 	<table border="1"> <thead> <tr> <th>Dimensions</th> <th>D</th> <th>W</th> <th>H</th> </tr> </thead> <tbody> <tr> <td>Overall</td> <td>35 ¼</td> <td>57 ½</td> <td>52</td> </tr> <tr> <td>Seat</td> <td>20</td> <td>48 ½</td> <td>17 ¾</td> </tr> <tr> <td>Arm</td> <td colspan="3">25</td> </tr> <tr> <th colspan="2">Upholstery</th> <th colspan="2">Shipping</th> </tr> <tr> <td>COM Ydg</td> <td>10 ¼</td> <td>Ctn Wt</td> <td>204</td> </tr> <tr> <td>COL Sq Ft</td> <td>110</td> <td>Cu Ft</td> <td>75</td> </tr> </tbody> </table>	Dimensions	D	W	H	Overall	35 ¼	57 ½	52	Seat	20	48 ½	17 ¾	Arm	25			Upholstery		Shipping		COM Ydg	10 ¼	Ctn Wt	204	COL Sq Ft	110	Cu Ft	75	COM \$5,146 A \$5,260 B \$5,486 COL/C \$5,880 D \$6,388 E \$6,896 F \$7,684 G \$8,531 H \$9,434 I \$10,844 J \$12,535 L1 \$9,152 L2 \$10,280
		Dimensions	D	W	H																										
Overall	35 ¼	57 ½	52																												
Seat	20	48 ½	17 ¾																												
Arm	25																														
Upholstery		Shipping																													
COM Ydg	10 ¼	Ctn Wt	204																												
COL Sq Ft	110	Cu Ft	75																												
		*screen available in fabric only, no leather																													

To Order, Specify:

- 1 Model Number
- 2 Wood Species
 - a.) Maple (M)
 - b.) Walnut (WAL) - upcharge applies
 - c.) White Oak (WOL) - upcharge applies
- 3 Finish See Finish Options
 - a.) Maple Finish and Paint Color
 - b.) Walnut Finish
 - c.) White Oak Finish
- 4 Fabric Selection - vendor, pattern and color
 Visit www.jsifurniture.com/finishes-and-materials/textiles for our textiles program. See selection of standard and graded in manufacturers and patterns.
- 5 Optional Tablet Arm - indicate left (TBL) or right arm (TBR) as seated; Laminate (L) or Veneer (V)
- 6 Optional Power Unit - Black (B) or White (W); indicate left (PUL) or right (PUR) arms as seated

Specifications

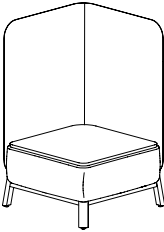
- chair frame is puzzle jointed plywood construction
- back has a 3 7/8" tapered multi-density high resilience polyurethane foam
- arm has 3" multi-density polyurethane foam
- seat has synthetic sheet webbing and 5" multi-density high resilience polyurethane foam
- solid hardwood exterior frame
- mortise and tenon construction with corner blocks, glue and screws
- standard with rubber cushion adjustable metal leveling glides
- surround produced from molded plywood construction
- railroad upholstery on screens
- chair and privacy surround ships assembled
- privacy wing and hood requires field installation
- false welt detail around the perimeter of surround

Description	Model	Specifications	List Price Per Grade																
45° Curved Seat with 52h Screen" 	CVM4536-52 · maple legs standard · walnut or white oak legs available, specify and add \$309 list · seat and screen ship assembled · specify upholstery on seat separately from upholstery on screen	<table border="1"> <thead> <tr> <th>Dimensions</th> <th>D</th> <th>W</th> <th>H</th> </tr> </thead> <tbody> <tr> <td>Overall</td> <td>34</td> <td>52 ½</td> <td>52</td> </tr> <tr> <td>Seat</td> <td>20</td> <td>-</td> <td>17 ¾</td> </tr> </tbody> </table>	Dimensions	D	W	H	Overall	34	52 ½	52	Seat	20	-	17 ¾	COM \$4,360 A \$4,448 B \$4,624 COL/C \$4,933 D \$5,328 E \$5,725 F \$6,341 G \$7,000 H \$7,705 I \$8,806 J \$10,126 L1 \$7,486 L2 \$8,366				
		Dimensions	D	W	H														
Overall	34	52 ½	52																
Seat	20	-	17 ¾																
<table border="1"> <thead> <tr> <th>Upholstery</th> <th colspan="3">Shipping</th> </tr> </thead> <tbody> <tr> <td>COM Ydg</td> <td>8</td> <td>Ctn Wt</td> <td>152</td> </tr> <tr> <td>COL Sq Ft</td> <td>99</td> <td>Cu Ft</td> <td>66</td> </tr> </tbody> </table> *screen available in fabric only, no leather	Upholstery	Shipping			COM Ydg	8	Ctn Wt	152	COL Sq Ft	99	Cu Ft	66							
Upholstery	Shipping																		
COM Ydg	8	Ctn Wt	152																
COL Sq Ft	99	Cu Ft	66																
90° Curved Seat with 52h Screen" 	CVM9036-52 · maple legs standard · walnut or white oak legs available, specify and add \$542 list · seat and screen ship assembled · specify upholstery on seat separately from upholstery on screen	<table border="1"> <thead> <tr> <th>Dimensions</th> <th>D</th> <th>W</th> <th>H</th> </tr> </thead> <tbody> <tr> <td>Overall</td> <td>45</td> <td>96 ¼</td> <td>52</td> </tr> <tr> <td>Seat</td> <td>20</td> <td>-</td> <td>17 ¾</td> </tr> </tbody> </table>	Dimensions	D	W	H	Overall	45	96 ¼	52	Seat	20	-	17 ¾	COM \$7,192 A \$7,345 B \$7,647 COL/C \$8,177 D \$8,858 E \$9,539 F \$10,597 G \$11,733 H \$12,943 I \$14,835 J \$17,105 L1 \$12,565 L2 \$14,079				
		Dimensions	D	W	H														
Overall	45	96 ¼	52																
Seat	20	-	17 ¾																
<table border="1"> <thead> <tr> <th>Upholstery</th> <th colspan="3">Shipping</th> </tr> </thead> <tbody> <tr> <td>COM Ydg</td> <td>13 ¾</td> <td>Ctn Wt</td> <td>246</td> </tr> <tr> <td>COL Sq Ft</td> <td>204</td> <td>Cu Ft</td> <td>157</td> </tr> </tbody> </table> *screen available in fabric only, no leather	Upholstery	Shipping			COM Ydg	13 ¾	Ctn Wt	246	COL Sq Ft	204	Cu Ft	157							
Upholstery	Shipping																		
COM Ydg	13 ¾	Ctn Wt	246																
COL Sq Ft	204	Cu Ft	157																
Corner Seat with 52h Screen" 	CVM3434-52-C · maple legs standard · walnut or white oak legs available, specify and add \$346 list · seat and screen ship assembled · specify upholstery on seat separately from upholstery on screen · fabric on seat of unit runs diagonal	<table border="1"> <thead> <tr> <th>Dimensions</th> <th>D</th> <th>W</th> <th>H</th> </tr> </thead> <tbody> <tr> <td>Overall</td> <td>34 ¼</td> <td>34 ¼</td> <td>52</td> </tr> <tr> <td>Seat</td> <td>20</td> <td>20</td> <td>17 ¾</td> </tr> <tr> <td>Arm</td> <td></td> <td></td> <td>-</td> </tr> </tbody> </table>	Dimensions	D	W	H	Overall	34 ¼	34 ¼	52	Seat	20	20	17 ¾	Arm			-	COM \$4,079 A \$4,164 B \$4,328 COL/C \$4,618 D \$4,989 E \$5,360 F \$5,937 G \$6,557 H \$7,218 I \$8,249 J \$9,487 L1 \$7,011 L2 \$7,837
		Dimensions	D	W	H														
Overall	34 ¼	34 ¼	52																
Seat	20	20	17 ¾																
Arm			-																
<table border="1"> <thead> <tr> <th>Upholstery</th> <th colspan="3">Shipping</th> </tr> </thead> <tbody> <tr> <td>COM Ydg</td> <td>7 ½</td> <td>Ctn Wt</td> <td>149</td> </tr> <tr> <td>COL Sq Ft</td> <td>83</td> <td>Cu Ft</td> <td>44</td> </tr> </tbody> </table> *screen available in fabric only, no leather	Upholstery	Shipping			COM Ydg	7 ½	Ctn Wt	149	COL Sq Ft	83	Cu Ft	44							
Upholstery	Shipping																		
COM Ydg	7 ½	Ctn Wt	149																
COL Sq Ft	83	Cu Ft	44																

To Order, Specify:

- 1 Model Number
- 2 Wood Species
 - a.) Maple (M)
 - b.) Walnut (WAL) - upcharge applies
 - c.) White Oak (WOL) - upcharge applies
- 3 Finish [See Finish Options](#)
 - a.) Maple Finish and Paint Color
 - b.) Walnut Finish
 - c.) White Oak Finish
- 4 Fabric Selection - vendor, pattern and color

Visit www.jsifurniture.com/finishes-and-materials/textiles for our textiles program. See selection of standard and graded in manufacturers and patterns.

Description	Model	Specifications			List Price Per Grade	
Comer Table with 52h Screen" 	CVT3434-52-C · maple legs standard · walnut or white oak legs available, specify and add \$346 list · seat and screen ship assembled · specify upholstery on seat separately from upholstery on screen · power available in surface, specify and add \$408 list, indicate color · surface available in veneer or laminate with 1mm band	Dimensions	D	W	H	COM \$3,232
		Overall	34 ¼	34 ¼	52	A \$3,297
		Upholstery	Shipping			B \$3,424
		COM Ydg	5 ¾	Ctn Wt	147	COL/C \$3,645
		COL Sq Ft	44	Cu Ft	44	D \$3,930
		*screen available in fabric only, no leather				E \$4,215
						F \$4,658
						G \$5,132
						H \$5,639
						I \$6,428
						J \$7,378
						L1 \$5,481
						L2 \$6,113

To Order, Specify:

- 1 Model Number
- 2 Table Top Surface Material [See Table Top Surface Options](#)
 - a.) Laminate Surface
 - b.) Veneer Surface
 - 1.) Cherry Flat Cut (CH1)
 - 2.) Maple Flat Cut (MA1)
 - 3.) Walnut Flat Cut (WA1)
 - 4.) White Oak (WO)
- 3 Fabric Selection - vendor, pattern and color
 Visit www.jsifurniture.com/finishes-and-materials/textiles for our textiles program. See selection of standard and graded in manufacturers and patterns.
- 4 Optional Surface Power Unit - Black (B) or White (W)

Specifications

- chair frame is puzzle jointed plywood construction
- back has a 3 ¾" tapered multi-density high resilience polyurethane foam
- arm has 3" multi-density polyurethane foam
- seat has synthetic sheet webbing and 5" multi-density high resilience polyurethane foam
- solid hardwood exterior frame
- mortise and tenon construction with corner blocks, glue and screws
- standard with rubber cushion adjustable metal leveling glides
- railroad upholstery on screens
- privacy wing and hood requires field installation
- false welt detail around the perimeter of surround
- linking brackets included

Description

Model

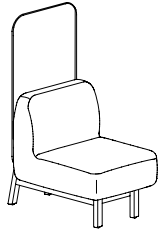
Specifications

List Price Per Grade

Single Seat with 44h Screen"

CVM3425-44

- maple legs standard
- walnut or white oak legs available, specify and add \$253 list
- seat and screen ship assembled
- specify upholstery on seat separately from upholstery on screen



Dimensions	D	W	H
Overall	34 ¼	25	44
Seat	20	25	17 ¾
Upholstery		Shipping	
COM Ydg	4 ½	Ctn Wt	112
COL Sq Ft	61	Cu Ft	29

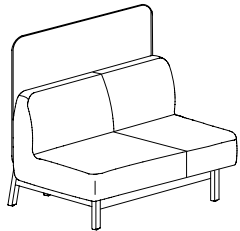
*screen available in fabric only, no leather

COM	\$3,031
A	\$3,083
B	\$3,181
COL/C	\$3,355
D	\$3,578
E	\$3,801
F	\$4,147
G	\$4,519
H	\$4,915
I	\$5,533
J	\$6,278
L1	\$4,790
L2	\$5,286

Two Seat with 44h Screen"

CVM3450-44

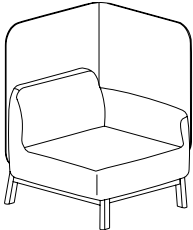
- maple legs standard
- walnut or white oak legs available, specify and add \$340 list
- seat and screen ship assembled
- specify upholstery on seat separately from upholstery on screen

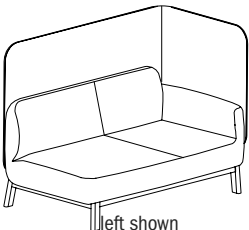


Dimensions	D	W	H
Overall	34 ¼	50	44
Seat	20	50	17 ¾
Upholstery		Shipping	
COM Ydg	7	Ctn Wt	158
COL Sq Ft	99	Cu Ft	55

*screen available in fabric only, no leather

COM	\$4,097
A	\$4,174
B	\$4,329
COL/C	\$4,599
D	\$4,945
E	\$5,292
F	\$5,832
G	\$6,409
H	\$7,026
I	\$7,988
J	\$9,143
L1	\$6,833
L2	\$7,604

Description	1 Model	Specifications	List Price Per Grade																												
Single Seat with Arm and 44h Screen"	CVM3533-44-R	<table border="1"> <thead> <tr> <th>Dimensions</th> <th>D</th> <th>W</th> <th>H</th> </tr> </thead> <tbody> <tr> <td>Overall</td> <td>35 ¼</td> <td>32 ½</td> <td>44</td> </tr> <tr> <td>Seat</td> <td>20</td> <td>23 ½</td> <td>17 ¾</td> </tr> <tr> <td>Arm</td> <td colspan="3">25</td> </tr> <tr> <th>Upholstery</th> <th colspan="3">Shipping</th> </tr> <tr> <td>COM Ydg</td> <td>7 ¼</td> <td>Ctn Wt</td> <td>138</td> </tr> <tr> <td>COL Sq Ft</td> <td>77</td> <td>Cu Ft</td> <td>38</td> </tr> </tbody> </table>	Dimensions	D	W	H	Overall	35 ¼	32 ½	44	Seat	20	23 ½	17 ¾	Arm	25			Upholstery	Shipping			COM Ydg	7 ¼	Ctn Wt	138	COL Sq Ft	77	Cu Ft	38	COM \$4,065
	Dimensions		D	W	H																										
Overall	35 ¼	32 ½	44																												
Seat	20	23 ½	17 ¾																												
Arm	25																														
Upholstery	Shipping																														
COM Ydg	7 ¼	Ctn Wt	138																												
COL Sq Ft	77	Cu Ft	38																												
	CVM3533-44-L		A \$4,145																												
 <p>left shown</p>	<ul style="list-style-type: none"> maple legs standard walnut or white oak legs available, specify and add \$272 list seat and surround ship assembled specify upholstery on seat separately from upholstery on screen tablet arm available, specify and add \$733 list, indicate finish or laminate power available in the front of the upholstered chair, specify and add \$408 list, indicate color 	<ul style="list-style-type: none"> *screen available in fabric only, no leather 	B \$4,305																												
					COL/C \$4,583																										
			D \$4,942																												
			E \$5,303																												
			F \$5,860																												
			G \$6,460																												
			H \$7,099																												
			I \$8,095																												
			J \$9,292																												
			L1 \$6,899																												
			L2 \$7,696																												

Description	1 Model	Specifications	List Price Per Grade																												
Two Seat with Arm and 44h Screen"	CVM3558-44-R	<table border="1"> <thead> <tr> <th>Dimensions</th> <th>D</th> <th>W</th> <th>H</th> </tr> </thead> <tbody> <tr> <td>Overall</td> <td>35 ¼</td> <td>57 ½</td> <td>44</td> </tr> <tr> <td>Seat</td> <td>20</td> <td>48 ½</td> <td>17 ¾</td> </tr> <tr> <td>Arm</td> <td colspan="3">25</td> </tr> <tr> <th>Upholstery</th> <th colspan="3">Shipping</th> </tr> <tr> <td>COM Ydg</td> <td>10 ¼</td> <td>Ctn Wt</td> <td>193</td> </tr> <tr> <td>COL Sq Ft</td> <td>110</td> <td>Cu Ft</td> <td>64</td> </tr> </tbody> </table>	Dimensions	D	W	H	Overall	35 ¼	57 ½	44	Seat	20	48 ½	17 ¾	Arm	25			Upholstery	Shipping			COM Ydg	10 ¼	Ctn Wt	193	COL Sq Ft	110	Cu Ft	64	COM \$5,100
	Dimensions		D	W	H																										
Overall	35 ¼	57 ½	44																												
Seat	20	48 ½	17 ¾																												
Arm	25																														
Upholstery	Shipping																														
COM Ydg	10 ¼	Ctn Wt	193																												
COL Sq Ft	110	Cu Ft	64																												
	CVM3558-44-L		A \$5,214																												
 <p>left shown</p>	<ul style="list-style-type: none"> maple legs standard walnut or white oak legs available, specify and add \$357 list seat and surround ship assembled specify upholstery on seat separately from upholstery on screen tablet arm available, specify and add \$733 list, indicate finish or laminate power available in the front of the upholstered chair, specify and add \$408 list, indicate color 	<ul style="list-style-type: none"> *screen available in fabric only, no leather 	B \$5,439																												
					COL/C \$5,833																										
			D \$6,341																												
			E \$6,850																												
			F \$7,638																												
			G \$8,484																												
			H \$9,387																												
			I \$10,797																												
			J \$12,489																												
			L1 \$9,106																												
			L2 \$10,233																												

To Order, Specify:

- Model Number
- Wood Species
 - Maple (M)
 - Walnut (WAL) - upcharge applies
 - White Oak (WOL) - upcharge applies
- Finish [See Finish Options](#)
 - Maple Finish and Paint Color
 - Walnut Finish
 - White Oak Finish
- Fabric Selection - vendor, pattern and color
 Visit www.jsifurniture.com/finishes-and-materials/textiles for our textiles program. See selection of standard and graded in manufacturers and patterns.
- Optional Tablet Arm - indicate None (NTB) or Yes (TBT); Laminate (L) or Veneer (V)
- Optional Seating Power Unit - Black (B) or White (W)

Specifications

- chair frame is puzzle jointed plywood construction
- back has a 3 ¾" tapered multi-density high resilience polyurethane foam
- arm has 3" multi-density polyurethane foam
- seat has synthetic sheet webbing and 5" multi-density high resilience polyurethane foam
- solid hardwood exterior frame
- mortise and tenon construction with corner blocks, glue and screws
- standard with rubber cushion adjustable metal leveling glides
- railroad upholstery on screens
- privacy wing and hood requires field installation
- false welt detail around the perimeter of surround
- linking brackets included

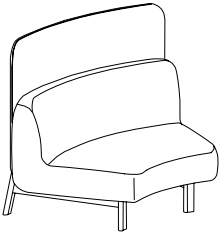
Description

1 Model

Specifications

List Price Per Grade

45° Curved Seat with 44h Screen"



CVM4536-44

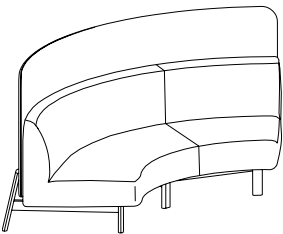
- maple legs standard
- walnut or white oak legs available, specify and add \$309 list
- seat and screen ship assembled
- specify upholstery on seat separately from upholstery on screen

Dimensions	D	W	H
Overall	34	52 ½	44
Seat	20	-	17 ¾
Upholstery		Shipping	
COM Ydg	8	Ctn Wt	146
COL Sq Ft	99	Cu Ft	57

*screen available in fabric only, no leather

COM	\$4,337
A	\$4,425
B	\$4,602
COL/C	\$4,910
D	\$5,306
E	\$5,703
F	\$6,319
G	\$6,978
H	\$7,683
I	\$8,784
J	\$10,104
L1	\$7,464
L2	\$8,343

90° Curved Seat with 44h Screen"



CVM9036-44

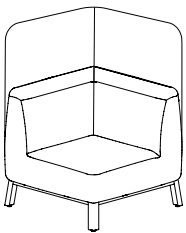
- maple legs standard
- walnut or white oak legs available, specify and add \$542 list
- seat and screen ship assembled
- specify upholstery on seat separately from upholstery on screen

Dimensions	D	W	H
Overall	45	96 ¼	44
Seat	20	-	17 ¾
Upholstery		Shipping	
COM Ydg	13 ¾	Ctn Wt	232
COL Sq Ft	204	Cu Ft	136

*screen available in fabric only, no leather

COM	\$7,222
A	\$7,375
B	\$7,677
COL/C	\$8,207
D	\$8,887
E	\$9,569
F	\$10,627
G	\$11,762
H	\$12,973
I	\$14,865
J	\$17,135
L1	\$12,596
L2	\$14,109

Corner Seat with 44h Screen"



CVM3434-44-C

- maple legs standard
- walnut or white oak legs available, specify and add \$346 list
- seat and surround ship assembled
- specify upholstery on seat separately from upholstery on screen
- fabric on seat of unit runs diagonal

Dimensions	D	W	H
Overall	34 ¼	34 ¼	44
Seat	20	20	17 ¾
Arm			-
Upholstery		Shipping	
COM Ydg	7 ½	Ctn Wt	141
COL Sq Ft	83	Cu Ft	38

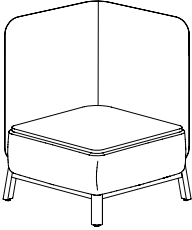
*screen available in fabric only, no leather

COM	\$4,056
A	\$4,141
B	\$4,305
COL/C	\$4,596
D	\$4,967
E	\$5,338
F	\$5,915
G	\$6,535
H	\$7,194
I	\$8,226
J	\$9,464
L1	\$6,989
L2	\$7,814

To Order, Specify:

- 1** Model Number
- 2** Wood Species
 - a.) Maple (M)
 - b.) Walnut (WAL) - upcharge applies
 - c.) White Oak (WOL) - upcharge applies
- 3** Finish [See Finish Options](#)
 - a.) Maple Finish and Paint Color
 - b.) Walnut Finish
 - c.) White Oak Finish
- 4** Fabric Selection - vendor, pattern and color

Visit www.jsifurniture.com/finishes-and-materials/textiles for our textiles program. See selection of standard and graded in manufacturers and patterns.

Description	① Model	Specifications			List Price Per Grade		
Comer Table with 44h Screen 	CVT3434-44-C · maple legs standard · walnut or white oak legs available, specify and add \$346 list · seat and surround ship assembled · specify upholstery on seat separately from upholstery on screen · power available in surface, specify and add \$408 list, indicate color · surface available in veneer or laminate with 1 mm bank	Dimensions			COM	\$3,210	
			D	W	H	A	\$3,274
		Overall	34 ¼	34 ¼	44	B	\$3,401
		Upholstery		Shipping		COL/C	\$3,623
		COM Ydg	5 ¾	Ctn Wt	139	D	\$3,908
COL Sq Ft	44	Cu Ft	38	E	\$4,192		
*screen available in fabric only, no leather					F	\$4,636	
					G	\$5,109	
					H	\$5,616	
					I	\$6,406	
					J	\$7,356	
					L1	\$5,459	
					L2	\$6,090	

To Order, Specify:

- ① Model Number
- ② Table Top Surface Material [See Table Top Surface Options](#)
 - a.) Laminate Surface
 - b.) Veneer Surface
 - 1.) Cherry Flat Cut (CH1)
 - 2.) Maple Flat Cut (MA1)
 - 3.) Walnut Flat Cut (WA1)
 - 4.) White Oak (WO)
- ③ Fabric Selection - vendor, pattern and color
Visit www.jsifurniture.com/finishes-and-materials/textiles for our textiles program. See selection of standard and graded in manufacturers and patterns.
- ④ Optional Surface Power Unit - Black (B) or White (W)

Specifications

- chair frame is puzzle jointed plywood construction
- back has a 3 ¾" tapered multi-density high resilience polyurethane foam
- arm has 3" multi-density polyurethane foam
- seat has synthetic sheet webbing and 5" multi-density high resilience polyurethane foam
- solid hardwood exterior frame
- mortise and tenon construction with corner blocks, glue and screws
- standard with rubber cushion adjustable metal leveling glides
- railroad upholstery on screens
- privacy wing and hood requires field installation
- false welt detail around the perimeter of surround
- linking brackets included

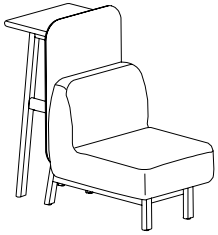
Description

Model

Specifications

List Price Per Grade

Single Seat with Privacy Screen and Stand-Up Surface



CVM3425-44-S

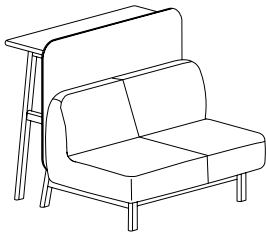
- maple legs standard
- walnut or white oak legs and surface available, specify and add \$542 list
- seat and screen ship assembled - shelf ships separately
- specify upholstery on seat separately from upholstery on screen
- stand-up surface is 42" high off floor and 14 1/2" deep
- stand-up surface available in veneer with bullnose or laminate with pvc edge
- power available in stand-up surface, specify and add \$408 list, indicate color

Dimensions	D	W	H
Overall	48 3/4	25	44
Seat	20	25	17 3/4
Upholstery		Shipping	
COM Ydg	4 1/2	Ctn Wt	146
COL Sq Ft	61	Cu Ft	31

*screen available in fabric only, no leather

- COM \$3,851
- A \$3,901
- B \$4,001
- COL/C \$4,173
- D \$4,397
- E \$4,620
- F \$4,967
- G \$5,338
- H \$5,734
- I \$6,352
- J \$7,097
- L1 \$5,609
- L2 \$6,105

Two Seat with Privacy Screen and Stand-Up Surface



CVM3450-44-S

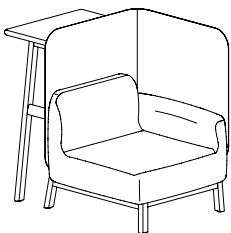
- maple legs standard
- walnut or white oak legs and surface available, specify and add \$653 list
- seat and screen ship assembled - shelf ships separately
- specify upholstery on seat separately from upholstery on screen
- stand-up surface is 42" high off floor and 14 1/2" deep
- stand-up surface available in veneer with bullnose or laminate with pvc edge
- power available in stand-up surface, specify and add \$408 list, indicate color

Dimensions	D	W	H
Overall	48 3/4	50	44
Seat	20	50	17 3/4
Upholstery		Shipping	
COM Ydg	7	Ctn Wt	201
COL Sq Ft	99	Cu Ft	59

*screen available in fabric only, no leather

- COM \$4,992
- A \$5,071
- B \$5,226
- COL/C \$5,494
- D \$5,841
- E \$6,188
- F \$6,728
- G \$7,305
- H \$7,922
- I \$8,884
- J \$10,039
- L1 \$7,728
- L2 \$8,499

Single Seat with Arm and Privacy Screen and Stand-Up Surface



left shown

CVM3533-44-R-S
CVM3533-44-L-S

- maple legs standard
- walnut or white oak legs and surface available, specify and add \$567 list
- seat and surround ship assembled - shelf ships separately
- specify upholstery on seat separately from upholstery on screen
- power available in the front of the upholstered chair, specify and add \$408 list, indicate color
- tablet arm available, specify and add \$733 list, indicate finish or laminate
- stand-up surface is 42" high off floor and 14 1/2" deep
- stand-up surface available with bullnose or laminate with pvc edge

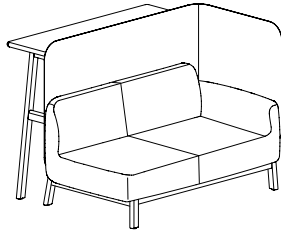
Dimensions	D	W	H
Overall	49 3/4	32 1/2	44
Seat	20	23 1/2	17 3/4
Arm			25
Upholstery		Shipping	
COM Ydg	7 1/4	Ctn Wt	174
COL Sq Ft	77	Cu Ft	42

*screen available in fabric only, no leather

- COM \$4,864
- A \$4,944
- B \$5,104
- COL/C \$5,383
- D \$5,742
- E \$6,101
- F \$6,659
- G \$7,259
- H \$7,897
- I \$8,893
- J \$10,091
- L1 \$7,697
- L2 \$8,496

Description

Two Seat with Arm and Privacy Screen and Stand-Up Surface



left shown

1 Model

CVM3558-44-R-S

CVM3558-44-L-S

- maple legs standard
- walnut or white oak legs and surface available, specify and add \$653 list
- seat and surround ship assembled - shelf ships separately
- specify upholstery on seat separately from upholstery on screen
- power available in the front of the upholstered chair, specify and add \$408 list, indicate color
- tablet arm available, specify and add \$733 list, indicate finish or laminate
- stand-up surface is 42" high off floor and 14 1/2" deep
- stand-up surface available with bullnose or laminate with pvc edge

Specifications

Dimensions	D	W	H
Overall	49 3/4	57 1/2	44
Seat	20	48 1/2	17 3/4
Arm	25		
Upholstery	Shipping		
COM Ydg	10 1/4	Ctn Wt	241
COL Sq Ft	110	Cu Ft	68

*screen available in fabric only, no leather

List Price Per Grade

COM	\$5,992
A	\$6,105
B	\$6,331
COL/C	\$6,724
D	\$7,234
E	\$7,741
F	\$8,530
G	\$9,377
H	\$10,279
I	\$11,689
J	\$13,381
L1	\$9,997
L2	\$11,125

To Order, Specify:

- 1 Model Number
- 2 Stand-Up Surface Material See Stand Up Surface Options
 - a.) Laminate Surface
 - b.) Veneer Surface
 - 1.) Cherry Flat Cut (CH1)
 - 2.) Maple Flat Cut (MA1)
 - 3.) Walnut Flat Cut (WA1)
 - 4.) Walnut Flat Cut with Walnut Wood Rim (WW1)
 - 5.) White Oak with White Oak Rim(WO)
- 3 Leg
 - a.) Maple
 - b.) Paint
 - c.) Walnut
 - d.) White Oak
- 4 Fabric Selection - vendor, pattern and color
Visit www.jsifurniture.com/finishes-and-materials/textiles for our textiles program. See selection of standard and graded in manufacturers and patterns.
- 5 Optional Tablet Arm; Laminate (L) or Veneer (V)
- 6 Optional Seating Power Unit
- 7 Optional Shelf Power Unit

Specifications

- chair frame is puzzle jointed plywood construction
- back has a 3 3/4" tapered multi-density high resilience polyurethane foam
- arm has 3" multi-density polyurethane foam
- seat has synthetic sheet webbing and 5" multi-density high resilience polyurethane foam
- solid hardwood exterior frame
- mortise and tenon construction with corner blocks, glue and screws
- standard with rubber cushion adjustable metal leveling glides
- surrounds produced from molded plywood construction
- railroad upholstery on screens
- false welt detail around perimeter of surround
- linking brackets included
- stand-up surface is field installed
- 1 3/16" thick worksurface with a bullnosed internal wood rim or pvc edge

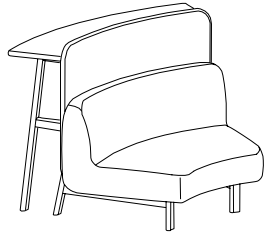
Description

Model

Specifications

List Price Per Grade

45° Curved Seat with Privacy Screen and Stand-Up Surface



CVM4536-44-S

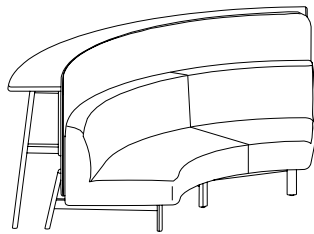
- maple legs standard
- walnut or white oak legs and surface available, specify and add \$660 list
- seat and screen ship assembled - shelf ships separately
- specify upholstery on seat separately from upholstery on screen
- stand-up surface is 42" high off floor and 14 1/2" deep
- stand-up surface available in veneer with bullnose or laminate with pvc edge
- power available in stand-up surface, specify and add \$408 list, indicate color

Dimensions	D	W	H
Overall	48 1/2	52 1/2	44
Seat	20	-	17 3/4
Upholstery		Shipping	
COM Ydg	8	Ctn Wt	196
COL Sq Ft	99	Cu Ft	62

*screen available in fabric only, no leather

COM	\$5,481
A	\$5,570
B	\$5,745
COL/C	\$6,054
D	\$6,450
E	\$6,847
F	\$7,464
G	\$8,123
H	\$8,827
I	\$9,928
J	\$11,249
L1	\$8,607
L2	\$9,487

90° Curved Seat with Privacy Screen and Stand-Up Surface



CVM9036-44-S

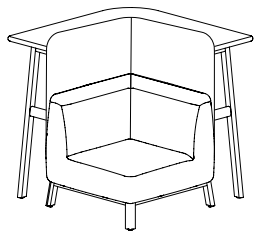
- maple legs standard
- walnut or white oak legs and surface available, specify and add \$1,133 list
- seat and screen ship assembled - shelf ships separately
- specify upholstery on seat separately from upholstery on screen
- stand-up surface is 42" high off floor and 14 1/2" deep
- stand-up surface available in veneer with bullnose or laminate with pvc edge
- power available in stand-up surface, specify and add \$408 list, indicate color

Dimensions	D	W	H
Overall	48 1/2	96 1/4	44
Seat	20	-	17 3/4
Upholstery		Shipping	
COM Ydg	13 3/4	Ctn Wt	319
COL Sq Ft	204	Cu Ft	145

*screen available in fabric only, no leather

COM	\$9,326
A	\$9,480
B	\$9,782
COL/C	\$10,312
D	\$10,993
E	\$11,673
F	\$12,733
G	\$13,867
H	\$15,078
I	\$16,969
J	\$19,240
L1	\$14,701
L2	\$16,213

Corner Seat with Privacy Screen and Stand-Up Surface



CVM3434-44-C-S

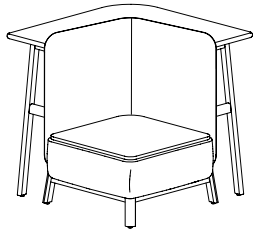
- maple legs standard
- walnut or white oak legs and surface available, specify and add \$856 list
- seat and surround ship assembled - shelf ships separately
- specify upholstery on seat separately from upholstery on screen
- stand-up surface is 42" high off floor and 14 1/2" deep
- stand-up surface available in veneer with bullnose or laminate with pvc edge
- power available in stand-up surface, specify and add \$408 list, indicate color
- fabric on seat of unit runs diagonal

Dimensions	D	W	H
Overall	34 1/4	34 1/4	44
Seat	20	20	17 3/4
Arm			-
Upholstery		Shipping	
COM Ydg	7 1/2	Ctn Wt	205
COL Sq Ft	83	Cu Ft	45

*screen available in fabric only, no leather

COM	\$5,330
A	\$5,415
B	\$5,579
COL/C	\$5,869
D	\$6,240
E	\$6,611
F	\$7,189
G	\$7,808
H	\$8,468
I	\$9,500
J	\$10,737
L1	\$8,262
L2	\$9,087

Description	Model	Specifications			List Price Per Grade			
		Dimensions	D	W	H	COM		
Comer Table with Privacy Screen and Stand-Up Surface	CVT3434-44-C-S · maple legs standard · walnut or white oak legs and surface available, specify and add \$856 list · seat and surround ship assembled - shelf ships separately · specify upholstery on seat separately from upholstery on screen · stand-up surface is 42" high off floor and 14 1/2" deep · stand-up surface available in veneer with bullnose or laminate with pvc edge · power available in stand-up surface, specify and add \$408 list, indicate color · table surface available in veneer or laminate with 1 mm band	Overall	34 1/4	34 1/4	44	COM	\$4,487	
		Upholstery		Shipping				
		COM Ydg	5 3/4	Ctn Wt	203	COL/C	\$4,900	
		COL Sq Ft	44	Cu Ft	45	D	\$5,185	
		*screen available in fabric only, no leather					E	\$5,469
						F	\$5,913	
						G	\$6,386	
						H	\$6,894	
						I	\$7,683	
						J	\$8,633	
						L1	\$6,736	
						L2	\$7,367	

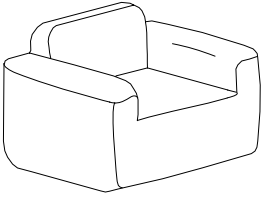
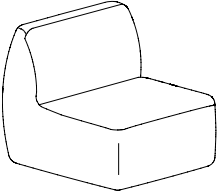
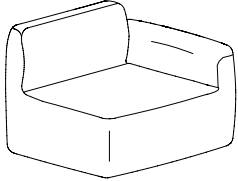
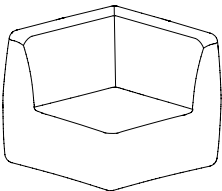


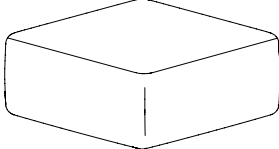
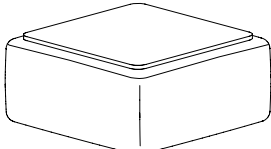
To Order, Specify:

- 1 Model Number
- 2 Stand-Up Surface Material See Stand Up Surface Options
 - a.) Laminate Surface
 - b.) Veneer Surface
 - 1.) Cherry Flat Cut (CH1)
 - 2.) Maple Flat Cut (MA1)
 - 3.) Walnut Flat Cut (WA1)
 - 4.) Walnut Flat Cut with Walnut Wood Rim (WW1)
 - 5.) White Oak with White Oak Rim(WO)
- 3 Leg
 - a.) Maple
 - b.) Paint
 - c.) Walnut
 - d.) White Oak
- 4 Fabric Selection - vendor, pattern and color
 Visit www.jsifurniture.com/finishes-and-materials/textiles for our textiles program. See selection of standard and graded in manufacturers and patterns.
- 5 Optional Tablet Arm; Laminate (L) or Veneer (V)
- 6 Optional Seating Power Unit
- 7 Optional Shelf Power Unit

Specifications

- chair frame is puzzle jointed plywood construction
- back has a 3 3/4" tapered multi-density high resilience polyurethane foam
- arm has 3" multi-density polyurethane foam
- seat has synthetic sheet webbing and 5" multi-density high resilience polyurethane foam
- solid hardwood exterior frame
- mortise and tenon construction with corner blocks, glue and screws
- standard with rubber cushion adjustable metal leveling glides
- surrounds produced from molded plywood construction
- railroad upholstery on screens
- false welt detail around perimeter of surround
- linking brackets included
- stand-up surface is field installed
- 1 3/16" thick worksurface with a bullnosed internal wood rim or pvc edge

Description	Model	Specifications	List Price Per Grade																
Single Seat Club Chair 	CVS3444-31 <ul style="list-style-type: none"> · tablet arm available, specify and add \$733 list, indicate right or left as seated and finish · power available in the side of the upholstered chair, specify and add \$408 list, indicate right or left as seated and color 	<table border="1"> <thead> <tr> <th>Dimensions</th> <th>D</th> <th>W</th> <th>H</th> </tr> </thead> <tbody> <tr> <td>Overall</td> <td>34 ¼</td> <td>44</td> <td>30 ½</td> </tr> <tr> <td>Seat</td> <td>21</td> <td>24</td> <td>17 ¾</td> </tr> <tr> <td>Arm</td> <td></td> <td></td> <td>25</td> </tr> </tbody> </table>	Dimensions	D	W	H	Overall	34 ¼	44	30 ½	Seat	21	24	17 ¾	Arm			25	COM \$2,699 A \$2,765 B \$2,897 COL/C \$3,129 D \$3,426 E \$3,723 F \$4,186 G \$4,681 H \$5,209 I \$6,034 J \$7,025 L1 \$5,572 L2 \$6,364
		Dimensions	D	W	H														
Overall	34 ¼	44	30 ½																
Seat	21	24	17 ¾																
Arm			25																
<table border="1"> <thead> <tr> <th>Upholstery</th> <th colspan="3">Shipping</th> </tr> </thead> <tbody> <tr> <td>COM Ydg</td> <td>6</td> <td>Ctn Wt</td> <td>113</td> </tr> <tr> <td>COL Sq Ft</td> <td>144</td> <td>Cu Ft</td> <td>30</td> </tr> </tbody> </table>	Upholstery	Shipping			COM Ydg	6	Ctn Wt	113	COL Sq Ft	144	Cu Ft	30							
Upholstery	Shipping																		
COM Ydg	6	Ctn Wt	113																
COL Sq Ft	144	Cu Ft	30																
Single Seat Armless 	CVS3431-31 <ul style="list-style-type: none"> · power available in the side of the upholstered chair, specify and add \$408 list, indicate right or left as seated and color 	<table border="1"> <thead> <tr> <th>Dimensions</th> <th>D</th> <th>W</th> <th>H</th> </tr> </thead> <tbody> <tr> <td>Overall</td> <td>34 ¼</td> <td>30 ½</td> <td>30 ½</td> </tr> <tr> <td>Seat</td> <td>21</td> <td>30 ½</td> <td>17 ¾</td> </tr> <tr> <td>Arm</td> <td></td> <td></td> <td>-</td> </tr> </tbody> </table>	Dimensions	D	W	H	Overall	34 ¼	30 ½	30 ½	Seat	21	30 ½	17 ¾	Arm			-	COM \$2,011 A \$2,061 B \$2,159 COL/C \$2,332 D \$2,555 E \$2,778 F \$3,125 G \$3,497 H \$3,892 I \$4,510 J \$5,256 L1 \$4,165 L2 \$4,760
		Dimensions	D	W	H														
Overall	34 ¼	30 ½	30 ½																
Seat	21	30 ½	17 ¾																
Arm			-																
<table border="1"> <thead> <tr> <th>Upholstery</th> <th colspan="3">Shipping</th> </tr> </thead> <tbody> <tr> <td>COM Ydg</td> <td>4 ½</td> <td>Ctn Wt</td> <td>91</td> </tr> <tr> <td>COL Sq Ft</td> <td>108</td> <td>Cu Ft</td> <td>22</td> </tr> </tbody> </table>	Upholstery	Shipping			COM Ydg	4 ½	Ctn Wt	91	COL Sq Ft	108	Cu Ft	22							
Upholstery	Shipping																		
COM Ydg	4 ½	Ctn Wt	91																
COL Sq Ft	108	Cu Ft	22																
Single Seat with Arm  left shown	CVS3441-31-R CVS3441-31-L <ul style="list-style-type: none"> · tablet arm available, specify and add \$733 list, indicate finish or laminate · power available in the front of the upholstered chair, specify and add \$408 list, indicate color 	<table border="1"> <thead> <tr> <th>Dimensions</th> <th>D</th> <th>W</th> <th>H</th> </tr> </thead> <tbody> <tr> <td>Overall</td> <td>34 ¼</td> <td>41</td> <td>30 ½</td> </tr> <tr> <td>Seat</td> <td>21</td> <td>29</td> <td>17 ¾</td> </tr> <tr> <td>Arm</td> <td></td> <td></td> <td>25</td> </tr> </tbody> </table>	Dimensions	D	W	H	Overall	34 ¼	41	30 ½	Seat	21	29	17 ¾	Arm			25	COM \$2,447 A \$2,503 B \$2,612 COL/C \$2,805 D \$3,052 E \$3,300 F \$3,685 G \$4,098 H \$4,538 I \$5,227 J \$6,052 L1 \$4,842 L2 \$5,502
		Dimensions	D	W	H														
Overall	34 ¼	41	30 ½																
Seat	21	29	17 ¾																
Arm			25																
<table border="1"> <thead> <tr> <th>Upholstery</th> <th colspan="3">Shipping</th> </tr> </thead> <tbody> <tr> <td>COM Ydg</td> <td>5</td> <td>Ctn Wt</td> <td>94</td> </tr> <tr> <td>COL Sq Ft</td> <td>120</td> <td>Cu Ft</td> <td>29</td> </tr> </tbody> </table>	Upholstery	Shipping			COM Ydg	5	Ctn Wt	94	COL Sq Ft	120	Cu Ft	29							
Upholstery	Shipping																		
COM Ydg	5	Ctn Wt	94																
COL Sq Ft	120	Cu Ft	29																
Corner Seat 	CVS3434-31-C <ul style="list-style-type: none"> · power available in the sides, specify right or left as seated, along with color and add \$408 list · fabric on seat of unit runs diagonal 	<table border="1"> <thead> <tr> <th>Dimensions</th> <th>D</th> <th>W</th> <th>H</th> </tr> </thead> <tbody> <tr> <td>Overall</td> <td>34 ¼</td> <td>34 ¼</td> <td>30 ½</td> </tr> <tr> <td>Seat</td> <td>21</td> <td>21</td> <td>17 ¾</td> </tr> <tr> <td>Arm</td> <td></td> <td></td> <td>-</td> </tr> </tbody> </table>	Dimensions	D	W	H	Overall	34 ¼	34 ¼	30 ½	Seat	21	21	17 ¾	Arm			-	COM \$2,438 A \$2,497 B \$2,613 COL/C \$2,815 D \$3,074 E \$3,336 F \$3,740 G \$4,173 H \$4,636 I \$5,357 J \$6,224 L1 \$4,953 L2 \$5,646
		Dimensions	D	W	H														
Overall	34 ¼	34 ¼	30 ½																
Seat	21	21	17 ¾																
Arm			-																
<table border="1"> <thead> <tr> <th>Upholstery</th> <th colspan="3">Shipping</th> </tr> </thead> <tbody> <tr> <td>COM Ydg</td> <td>5 ¼</td> <td>Ctn Wt</td> <td>77</td> </tr> <tr> <td>COL Sq Ft</td> <td>126</td> <td>Cu Ft</td> <td>24</td> </tr> </tbody> </table>	Upholstery	Shipping			COM Ydg	5 ¼	Ctn Wt	77	COL Sq Ft	126	Cu Ft	24							
Upholstery	Shipping																		
COM Ydg	5 ¼	Ctn Wt	77																
COL Sq Ft	126	Cu Ft	24																

Description	Model	Specifications	List Price Per Grade																								
Ottoman 	CVO3434-17 • power available in the sides, specify right, left or both, along with color and add \$408 list per unit	<table border="1"> <thead> <tr> <th>Dimensions</th> <th>D</th> <th>W</th> <th>H</th> </tr> </thead> <tbody> <tr> <td>Overall</td> <td>34</td> <td>34</td> <td>17</td> </tr> <tr> <td>Seat</td> <td>34</td> <td>34</td> <td>17 ¾</td> </tr> <tr> <th colspan="2">Upholstery</th> <th colspan="2">Shipping</th> </tr> <tr> <td>COM Ydg</td> <td>3 ½</td> <td>Ctn Wt</td> <td>68</td> </tr> <tr> <td>COL Sq Ft</td> <td>84</td> <td>Cu Ft</td> <td>14</td> </tr> </tbody> </table>	Dimensions	D	W	H	Overall	34	34	17	Seat	34	34	17 ¾	Upholstery		Shipping		COM Ydg	3 ½	Ctn Wt	68	COL Sq Ft	84	Cu Ft	14	COM \$1,469 A \$1,508 B \$1,586 COL/C \$1,720 D \$1,893 E \$2,068 F \$2,337 G \$2,627 H \$2,934 I \$3,415 J \$3,994 L1 \$3,145 L2 \$3,608
		Dimensions	D	W	H																						
Overall	34	34	17																								
Seat	34	34	17 ¾																								
Upholstery		Shipping																									
COM Ydg	3 ½	Ctn Wt	68																								
COL Sq Ft	84	Cu Ft	14																								
Table 	CVT3434-17 • power available in surface, specify and add \$408 list, indicate color • surface available veneer or laminate	<table border="1"> <thead> <tr> <th>Dimensions</th> <th>D</th> <th>W</th> <th>H</th> </tr> </thead> <tbody> <tr> <td>Overall</td> <td>34</td> <td>34</td> <td>17</td> </tr> <tr> <th colspan="2">Upholstery</th> <th colspan="2">Shipping</th> </tr> <tr> <td>COM Ydg</td> <td>2 ½</td> <td>Ctn Wt</td> <td>93</td> </tr> <tr> <td>COL Sq Ft</td> <td>55</td> <td>Cu Ft</td> <td>14</td> </tr> </tbody> </table>	Dimensions	D	W	H	Overall	34	34	17	Upholstery		Shipping		COM Ydg	2 ½	Ctn Wt	93	COL Sq Ft	55	Cu Ft	14	COM \$1,534 A \$1,563 B \$1,616 COL/C \$1,713 D \$1,837 E \$1,960 F \$2,153 G \$2,360 H \$2,580 I \$2,924 J \$3,336 L1 \$2,620 L2 \$2,924				
		Dimensions	D	W	H																						
Overall	34	34	17																								
Upholstery		Shipping																									
COM Ydg	2 ½	Ctn Wt	93																								
COL Sq Ft	55	Cu Ft	14																								

To Order, Specify:

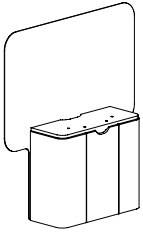
- 1 Model Number
- 2 Table Surface Material [See Table Top Surface Options](#)
 - a.) Laminate
 - b.) Cherry Flat Cut Veneer
 - c.) Maple Flat Cut Veneer
 - d.) Walnut Flat Cut Veneer
 - e.) White Oak Veneer
- 3 Finish
 - a.) Maple Finish and Paint Color
 - b.) Walnut Finish
 - c.) White Oak Finish
- 4 Fabric Selection - vendor, pattern and color
 Visit www.jsifurniture.com/finishes-and-materials/textiles for our textiles program. See selection of standard and graded in manufacturers and patterns.
- 5 Optional Tablet Arm - Indicate Left (TBL) or Right Arm (TBR) as seated; Laminate (L) or Veneer (V)
- 6 Optional Power Unit - Black (B) or White (W)

Specifications

- chair frame is puzzle jointed plywood construction
- back has a 3 ¾" tapered multi-density high resilience polyurethane foam
- arm has 3" multi-density polyurethane foam
- seat has synthetic sheet webbing and 5" multi-density high resilience polyurethane foam
- plastic foot standard
- linking brackets included

Description

Media Panel for Runoff Table



1 Model

CVP1249-52MEDT

- use with runoff table
- removable lower panel for wire management access
- wire management cutout in surface
- TV bracket available, specify and add \$417 list; accomodates up to 32" TV

Specifications

Dimensions	D	W	H
Overall	12	49	52
Upholstery		Shipping	
COM Ydg	4 ½	Ctn Wt	91
		Cu Ft	22

List Price Per Grade

COM	\$2,114
A	\$2,164
B	\$2,264
C	\$2,436
D	\$2,659
E	\$2,883
F	\$3,229
G	\$3,600
H	\$3,997
I	\$4,615
J	\$5,358

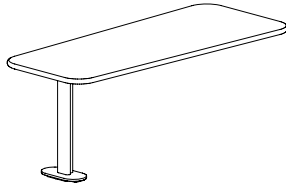
To Order, Specify:

- 1** Model Number
- 2** Surface Material [See Surface Material Options](#)
 - a.) Laminate
 - b.) Cherry Flat Cut Veneer
 - c.) Maple Flat Cut Veneer
 - d.) Walnut Flat Cut Veneer
 - e.) White Oak Veneer
- 3** Finish [See Finish Options](#)
 - a.) Maple Finish and Paint Color
 - b.) Walnut
 - c.) White Oak Finish
- 4** Fabric Selection - vendor, pattern and color
 Visit www.jsifurniture.com/finishes-and-materials/textiles for our textiles program. See selection of standard and graded in manufacturers and patterns.

Specifications

- case frame is puzzle jointed plywood construction
- solid hardwood leg cover
- standard with rubber cushion adjustable metal leveling glides on case
- railroad upholstery on screens (and case so they match unless otherwise specified)
- media unit ships assembled
- neoprene pad beneath table base to "self-level"
- media wall has removable lower panel for wire access
- 1 ¾" thick worksurface with a radiused corners and a bullnosed internal wood rim

Description	D	W	H	CTN WT	CU FT	① Model	List Price
Runoff Table for Media Panel		74	26 ½	98	20	CV2974-26ROMT	\$1,869
		50	26 ½	69	14	CV2950-26ROMT	\$1,714



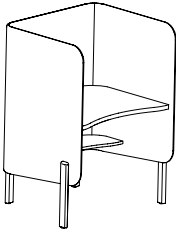
- use with CVP1249-52MEDT
- use two seat lounge with CV2950-26ROMT
- use three seat lounge with CV2974-26ROMT
- maple post standard
- walnut or white oak post and surface available, specify and add \$131 list for CV2950-26ROMT and add \$168 list for CV2974-26ROMT
- surface available in veneer with bullnose or laminate with pvc edge
- edge of veneer table surface is maple, unless walnut or white oak legs are specified, then rim is same as leg species and upcharge applies
- edge of laminate table surface is matching pvc
- EC46 power unit available in surface, specify and add \$408 list, indicate color

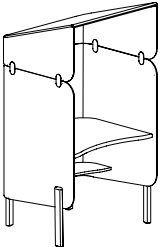
To Order, Specify:

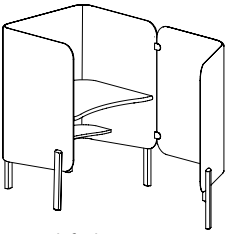
- ① Model Number
- ② Surface Material [See Surface Material Options](#)
 - a.) Laminate Surface
 - b.) Veneer Surface
 - 1.) Cherry Flat Cut (CH1)
 - 2.) Maple Flat Cut (MA1)
 - 3.) Walnut Flat Cut (WA1)
 - 4.) Walnut Flat Cut with Walnut Wood Rim (WW1)
 - 5.) White Oak with White Oak Rim(WO)
- ③ Leg [See Leg Finish/Color Options](#)
 - a.) Maple
 - b.) Paint
 - c.) Walnut
 - d.) White Oak
- ④ Fabric Selection - vendor, pattern and color
Visit www.jsifurniture.com/finishes-and-materials/textiles for our textiles program. See selection of standard and graded in manufacturers and patterns.
- ⑤ Metal Color [See Metal Color Options](#)
- ⑥ Optional Surface Power Unit

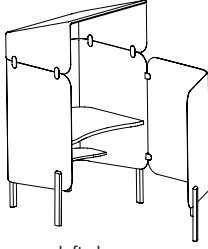
Specifications

- case frame is puzzle jointed plywood construction
- solid hardwood leg cover
- standard with rubber cushion adjustable metal leveling glides on case
- railroad upholstery on screens (and case so they match unless otherwise specified)
- media unit ships assembled
- runoff table requires field assembly and installation
- neoprene pad beneath table base to "self-level"
- media wall has removable lower panel for wire access
- TV bracket available on media wall; recommended TV size 32"
- 2" rectangular column - 14 guage steel - with solid wood cover on runoff table with integrated oval base with neoprene pads to "self-level"
- 1 ¾" thick worksurface with a bullnosed internal wood rim or pvc edge

Description	Model	Specifications	List Price Per Grade																																												
Desk Pod 	CVD3439-52 <ul style="list-style-type: none"> · maple legs standard · walnut or white oak legs and surface available, specify and add \$198 list · surface available in veneer with bullnose or laminate with pvc edge · edge of desk veneer table surface is maple, unless walnut or white oak legs are specified, then rim is same as leg species and upcharge applies · edge of laminate table surface is matching pvc · table surface height is 29 1/2" · power available in surface, specify and add \$408 list, indicate color 	<table border="1"> <thead> <tr> <th>Dimensions</th> <th>D</th> <th>W</th> <th>H</th> </tr> </thead> <tbody> <tr> <td>Overall</td> <td>33 1/2</td> <td>39</td> <td>52</td> </tr> </tbody> </table>	Dimensions	D	W	H	Overall	33 1/2	39	52	<table border="1"> <thead> <tr> <th>COM</th> <th>Grade</th> <th>Price</th> </tr> </thead> <tbody> <tr><td>COM</td><td>A</td><td>\$4,249</td></tr> <tr><td></td><td>B</td><td>\$4,316</td></tr> <tr><td></td><td>C</td><td>\$4,448</td></tr> <tr><td></td><td>D</td><td>\$4,680</td></tr> <tr><td></td><td>E</td><td>\$4,977</td></tr> <tr><td></td><td>F</td><td>\$5,274</td></tr> <tr><td></td><td>G</td><td>\$5,735</td></tr> <tr><td></td><td>H</td><td>\$6,231</td></tr> <tr><td></td><td>I</td><td>\$6,759</td></tr> <tr><td></td><td>J</td><td>\$7,584</td></tr> <tr><td></td><td>K</td><td>\$8,575</td></tr> </tbody> </table>	COM	Grade	Price	COM	A	\$4,249		B	\$4,316		C	\$4,448		D	\$4,680		E	\$4,977		F	\$5,274		G	\$5,735		H	\$6,231		I	\$6,759		J	\$7,584		K	\$8,575
		Dimensions	D	W	H																																										
Overall	33 1/2	39	52																																												
COM	Grade	Price																																													
COM	A	\$4,249																																													
	B	\$4,316																																													
	C	\$4,448																																													
	D	\$4,680																																													
	E	\$4,977																																													
	F	\$5,274																																													
	G	\$5,735																																													
	H	\$6,231																																													
	I	\$6,759																																													
	J	\$7,584																																													
	K	\$8,575																																													
	<table border="1"> <thead> <tr> <th>Upholstery</th> <th>Shipping</th> </tr> </thead> <tbody> <tr> <td>COM Ydg</td> <td>6 Ctn Wt 150</td> </tr> <tr> <td></td> <td>Cu Ft 49</td> </tr> </tbody> </table>	Upholstery	Shipping	COM Ydg	6 Ctn Wt 150		Cu Ft 49																																								
Upholstery	Shipping																																														
COM Ydg	6 Ctn Wt 150																																														
	Cu Ft 49																																														

Description	Model	Specifications	List Price Per Grade																																												
Desk Pod with Hood 	CVD3439-72 <ul style="list-style-type: none"> · maple legs standard · walnut or white oak legs and surface available, specify and add \$198 list · desk and surround ships assembled - hood ships separately · surface available in veneer with bullnose or laminate with pvc edge · edge of desk veneer table surface is maple, unless walnut or white oak legs are specified, then rim is same as leg species and upcharge applies · edge of laminate table surface is matching pvc · table surface height is 29 1/2" · power available in surface, specify and add \$408 list indicate color 	<table border="1"> <thead> <tr> <th>Dimensions</th> <th>D</th> <th>W</th> <th>H</th> </tr> </thead> <tbody> <tr> <td>Overall</td> <td>33 1/2</td> <td>39</td> <td>72</td> </tr> </tbody> </table>	Dimensions	D	W	H	Overall	33 1/2	39	72	<table border="1"> <thead> <tr> <th>COM</th> <th>Grade</th> <th>Price</th> </tr> </thead> <tbody> <tr><td>COM</td><td>A</td><td>\$6,014</td></tr> <tr><td></td><td>B</td><td>\$6,142</td></tr> <tr><td></td><td>C</td><td>\$6,395</td></tr> <tr><td></td><td>D</td><td>\$6,837</td></tr> <tr><td></td><td>E</td><td>\$7,407</td></tr> <tr><td></td><td>F</td><td>\$7,977</td></tr> <tr><td></td><td>G</td><td>\$8,863</td></tr> <tr><td></td><td>H</td><td>\$9,813</td></tr> <tr><td></td><td>I</td><td>\$10,824</td></tr> <tr><td></td><td>J</td><td>\$12,406</td></tr> <tr><td></td><td>K</td><td>\$14,305</td></tr> </tbody> </table>	COM	Grade	Price	COM	A	\$6,014		B	\$6,142		C	\$6,395		D	\$6,837		E	\$7,407		F	\$7,977		G	\$8,863		H	\$9,813		I	\$10,824		J	\$12,406		K	\$14,305
		Dimensions	D	W	H																																										
Overall	33 1/2	39	72																																												
COM	Grade	Price																																													
COM	A	\$6,014																																													
	B	\$6,142																																													
	C	\$6,395																																													
	D	\$6,837																																													
	E	\$7,407																																													
	F	\$7,977																																													
	G	\$8,863																																													
	H	\$9,813																																													
	I	\$10,824																																													
	J	\$12,406																																													
	K	\$14,305																																													
	<table border="1"> <thead> <tr> <th>Upholstery</th> <th>Shipping</th> </tr> </thead> <tbody> <tr> <td>COM Ydg</td> <td>11 1/2 Ctn Wt 210</td> </tr> <tr> <td></td> <td>Cu Ft 67</td> </tr> </tbody> </table>	Upholstery	Shipping	COM Ydg	11 1/2 Ctn Wt 210		Cu Ft 67																																								
Upholstery	Shipping																																														
COM Ydg	11 1/2 Ctn Wt 210																																														
	Cu Ft 67																																														

Description	Model	Specifications	List Price Per Grade																																												
Desk Pod with Privacy Wing  <p>left shown</p>	CVD7739-52-R CVD7739-52-L <ul style="list-style-type: none"> · maple legs standard · walnut or white oak legs and surface available, specify and add \$272 list · desk and surround ships assembled - wing ships separately · surface available in veneer with bullnose or laminate with pvc edge · edge of desk veneer table surface is maple, unless walnut or white oak legs are specified, then rim is same as leg species and upcharge applies · edge of laminate table surface is matching pvc · table surface height is 29 1/2" · power available in surface, specify and add \$408 list indicate color 	<table border="1"> <thead> <tr> <th>Dimensions</th> <th>D</th> <th>W</th> <th>H</th> </tr> </thead> <tbody> <tr> <td>Overall</td> <td>76 1/2</td> <td>39</td> <td>52</td> </tr> </tbody> </table>	Dimensions	D	W	H	Overall	76 1/2	39	52	<table border="1"> <thead> <tr> <th>COM</th> <th>Grade</th> <th>Price</th> </tr> </thead> <tbody> <tr><td>COM</td><td>A</td><td>\$5,578</td></tr> <tr><td></td><td>B</td><td>\$5,683</td></tr> <tr><td></td><td>C</td><td>\$5,892</td></tr> <tr><td></td><td>D</td><td>\$6,259</td></tr> <tr><td></td><td>E</td><td>\$6,729</td></tr> <tr><td></td><td>F</td><td>\$7,199</td></tr> <tr><td></td><td>G</td><td>\$7,931</td></tr> <tr><td></td><td>H</td><td>\$8,715</td></tr> <tr><td></td><td>I</td><td>\$9,551</td></tr> <tr><td></td><td>J</td><td>\$10,859</td></tr> <tr><td></td><td>K</td><td>\$12,426</td></tr> </tbody> </table>	COM	Grade	Price	COM	A	\$5,578		B	\$5,683		C	\$5,892		D	\$6,259		E	\$6,729		F	\$7,199		G	\$7,931		H	\$8,715		I	\$9,551		J	\$10,859		K	\$12,426
		Dimensions	D	W	H																																										
Overall	76 1/2	39	52																																												
COM	Grade	Price																																													
COM	A	\$5,578																																													
	B	\$5,683																																													
	C	\$5,892																																													
	D	\$6,259																																													
	E	\$6,729																																													
	F	\$7,199																																													
	G	\$7,931																																													
	H	\$8,715																																													
	I	\$9,551																																													
	J	\$10,859																																													
	K	\$12,426																																													
	<table border="1"> <thead> <tr> <th>Upholstery</th> <th>Shipping</th> </tr> </thead> <tbody> <tr> <td>COM Ydg</td> <td>9 1/2 Ctn Wt 201</td> </tr> <tr> <td></td> <td>Cu Ft 76</td> </tr> </tbody> </table>	Upholstery	Shipping	COM Ydg	9 1/2 Ctn Wt 201		Cu Ft 76																																								
Upholstery	Shipping																																														
COM Ydg	9 1/2 Ctn Wt 201																																														
	Cu Ft 76																																														

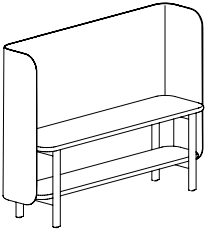
Description	Model	Specifications			List Price Per Grade		
		Dimensions	D	W	H	COM	
Desk Pod with Privacy Wing and Hood	CVD7739-72-R						
	CVD7739-72-L						
 <p>left shown</p>	<ul style="list-style-type: none"> maple legs standard walnut or white oak legs and surface available, specify and add \$272 list desk and surround ships assembled - hood and wing ships separately surface available in veneer with bullnose or laminate with pvc edge edge of desk veneer table surface is maple, unless walnut or white oak legs are specified, then rim is same as leg species and upcharge applies edge of of laminate table surface is matching pvc table surface height is 29 1/2" power available in surface, specify and add \$408 list, indicate color 	Overall	76 1/2	39	72	A	\$7,233
		Upholstery		Shipping			
		COM Ydg	15	Ctn Wt	261	C	\$8,140
				Cu Ft	94	D	\$8,883
				E	\$9,625		
				F	\$10,780		
				G	\$12,019		
				H	\$13,339		
				I	\$15,403		
				J	\$17,879		

To Order, Specify:

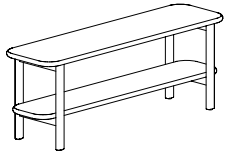
- 1 Model Number
- 2 Surface Material [See Surface Material Options](#)
 - a.) Laminate Surface
 - b.) Veneer Surface
 - 1.) Cherry Flat Cut (CH1)
 - 2.) Maple Flat Cut (MA1)
 - 3.) Walnut Flat Cut (WA1)
 - 4.) Walnut Flat Cut with Walnut Wood Rim (WW1)
 - 5.) White Oak with White Oak Rim(WO)
- 3 Leg [See Leg Finish/Color Options](#)
 - a.) Maple
 - b.) Paint
 - c.) Walnut
 - d.) White Oak
- 4 Fabric Selection - vendor, pattern and color
 Visit www.jsifurniture.com/finishes-and-materials/textiles for our textiles program.
 See selection of standard and graded in manufacturers and patterns.
- 5 Metal Color [See Metal Color Options](#)
- 6 Optional Surface Power Unit

Specifications

- solid hardwood legs
- standard with rubber cushion adjustable metal leveling glides
- surrounds produced from molded plywood construction
- railroad upholstery on screens
- false welt detail around perimeter of surround
- 1 3/8" thick worksurface with a bullnosed internal wood rim or pvc edge

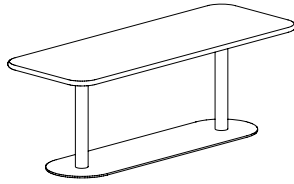
Description	① Model	Specifications	List Price Per Grade
Media Credenza with Privacy Surround	CV1864-48MCPS	Dimensions	COM \$3,475
		Overall	A \$3,536
	<ul style="list-style-type: none"> · maple legs standard · walnut or white oak legs and surface available, specify and add \$420 list · surface available in veneer with bullnose or laminate with pvc edge · edge of desk veneer table surface is maple, unless walnut or white oak legs are specified, then rim is same as leg species and upcharge applies · edge of laminate table surface is matching pvc · table surface: 23”h · wire management cutout in surface · lower shelf at 9 ¼ from floor 	Shipping	B \$3,659
		COM Ydg	C \$3,869
		Ctn Wt	D \$4,143
		Cu Ft	E \$4,414
			F \$4,837
			G \$5,291
			H \$5,776
			I \$6,534
			J \$7,441

Description	D	W	H	CTN WT	CU FT	① Model	List Price
Media Credenza	17	62	23	89	18	CV1762-23MC	\$2,056



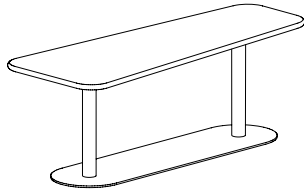
- maple legs standard
- walnut or white oak legs and surface available, specify and add \$420 list
- surface available in veneer with bullnose or laminate with pvc edge
- edge of desk surface is maple, unless walnut or white oak legs are specified, then rim is same as leg species and upcharge applies
- edge of laminate table surface is matching pvc
- lower shelf at 9 ¼ from floor

Description	D	W	H	CTN WT	CU FT	① Model	List Price
Lounge Work Table - Rectangular	27½	74	26½	212	16	CV2974-26LWTR	\$4,154
	27½	50	26½	139	11	CV2950-26LWTR	\$2,870



- surface available in veneer with bullnose or laminate with pvc edge
- walnut or white oak surface available, specify and add \$81 list for CV2950-26LWTR and add \$118 for CV2974-26LWTR
- power available in surface, specify and add \$408 list, indicate color

Lounge Work Table - View	26 narrow end 29 wide end	74	26½	212	16	CV2974-26LWTV	\$4,154
	26 narrow end 29 wide end	50	26½	139	11	CV2950-26LWTV	\$2,870



- surface available in veneer with bullnose or laminate with pvc edge
- walnut or white oak surface available, specify and add \$81 list for CV2950-26LWTV and add \$118 for CV2974-26LWTV
- power available in surface, specify and add \$408 list, indicate color

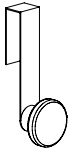
To Order, Specify:

- ① Model Number
- ② Surface Material [See Surface Material Options](#)
 - a.) Laminate Surface
 - b.) Veneer Surface
 - 1.) Cherry Flat Cut (CH1)
 - 2.) Maple Flat Cut (MA1)
 - 3.) Walnut Flat Cut (WA1)
 - 4.) Walnut Flat Cut with Walnut Wood Rim (WW1)
 - 5.) White Oak with White Oak Rim(WO)
- ③ Leg [See Leg Finish/Color Options](#)
 - a.) Maple
 - b.) Paint
 - c.) Walnut
 - d.) White Oak
- ④ Fabric Selection - vendor, pattern and color
Visit www.jsifurniture.com/finishes-and-materials/textiles for our textiles program.
See selection of standard and graded in manufacturers and patterns.
- ⑤ Metal Color [See Metal Color Options](#)
- ⑥ Optional Surface Power Unit

Specifications

- 3" diameter column - 14 guage steel
- ⅜" thick steel base
- neoprene pad beneath the base to "self-level"
- table required field assembly and installation
- 1 ¾" thick worksurface with a bullnosed internal wood rim or pvc edge

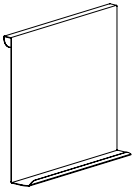
Description	D	W	H	CTN WT	CU FT	① Model	List Price
Coat Hook	3 1/8	2 1/2	7	2	1	CVA0307WS-KNOB	\$244



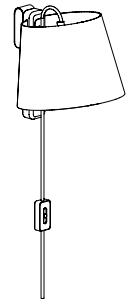
- maple knob standard
- walnut or white oak knob available, specify and add \$27 list
- supported by a metal hook
- maximum weight rating 10 lbs. (evenly distributed load)

Markerboard

4	20	19	15	2	CVA-MARKBOARD	\$488
---	----	----	----	---	---------------	-------



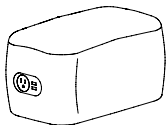
Sconce Light	10 1/2	9	9 5/8	9	4	CVA-SCONCE	\$623
--------------	--------	---	-------	---	---	------------	-------



- supported by a metal hook
- 15" graphite fabric cord
- cord mounted rocker on/off switch - three prong plug fabric power cord
- on/off switch on cord 32" from light - field assembly required
- maximum 60 watt light bulb, NOT included/LED bulb recommended
- select Maharam Mode Shade Fabric Color
- maple sconce support standard
- walnut or white oak available, specify and add \$27 list

Description	① Model	Specifications	List Price Per Grade
-------------	---------	----------------	----------------------

Power Bolster



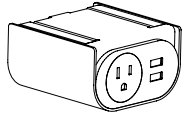
CVA-BOLSTER

- use between modular units
- includes fastening hardware to attach to seating in the field
- optional power, specify and add \$408 list
- simplex receptacle and dual powered USB-A
- 102" graphite fabric cord
- specify black or white

Dimensions	D	W	H
Overall	14 1/2	8 1/2	7 1/2
Upholstery		Shipping	
COM Ydg	3/4	Ctn Wt	15
COL Sq Ft	16	Cu Ft	1

COM	\$569
A	\$579
B	\$595
COL/C	\$624
D	\$661
E	\$699
F	\$757
G	\$817
H	\$884
I	\$988
J	\$1,112
L1	\$863
L2	\$947

Description	D	W	H	CTN WT	CU FT	❶ Model	List Price
Under Surface/Side Mount Power	3 5/8	3 5/8	2 1/8	3	1	EC47	\$438



- simplex receptacle and dual powered USB-A
- 108" graphite fabric cord
- specify black or white

To Order, Specify:

- ❶ Model Number
- ❷ Wood Species
 - a.) Maple (M)
 - b.) Walnut (WAL) - upcharge applies
 - c.) White Oak (WOL) - upcharge applies
- ❸ Finish See [Finish Options](#)
 - a.) Maple Finish and Paint Color
 - b.) Walnut Finish
 - c.) White Oak Finish
- ❹ Fabric Selection - vendor, pattern and color
 Visit www.jsifurniture.com/finishes-and-materials/textiles for our textiles program.
 See selection of standard and graded in manufacturers and patterns.
- ❺ Lamp Shade - Maharam - Mode
 See www.maharam.com/products for color selection

Cabaret Order Check List:



Specify:

- 1. Model Number
- 2. Wood Species - Maple (M)
- 3. Wood Base Finish
- 4. Fabric Selection - vendor, pattern and color
- 5. Base Selection - wood base standard; specify wood finish
 - A. Black Polyurethane Base - no upcharge
 - B. Black Pneumatic Jury Base - add \$203 list
- 6. Optional Plastic Bumper Guard - add \$25 list

Example:

CR1275 (model #)	M (wood species)	HRV (finish wood base)	MOMENTUM (fabric vendor)	VOX (pattern name)	MYSTIC (pattern color)
----------------------------	----------------------------	----------------------------------	------------------------------------	------------------------------	----------------------------------

1. Model Number

2. Wood Species - Maple (M)

3. Wood Finish Options:

ALM Ale Medium	HRV Harvest
CAL Ale Light Coordinate	CKC Khaki Coordinate
BBM Bourbon Medium	MINC Mineral Coordinate
CBZ Brazilwood Coordinate	MCH Mocha
BARC Barrel Coordinate	CPI Pinnacle Walnut Coordinate
CBO Bourbon Light Coordinate	PRL Praline
CBG Brighton Light Coordinate	RAVC Raven Coordinate
BRM Brighton Medium	SABC Sable Coordinate
BUT Butterscotch	SIE Sienna
CNDC Cinder Coordinate	CST Studio Teak Coordinate
CLA Classic	TRF Truffle
CLL Collectors	UMB Umber
EGRC Egret Coordinate	VALC Valley Coordinate
ESP Espresso	VEN Venetian
FAWC Fawn Coordinate	CWE Weathered Ash Coordinate
FLX Flax	
CGR Graphite Coordinate	

4. Fabric Selection -Please supply the following:
Fabric vendor/ Pattern name/ Pattern color

[For a complete list of JSI Standard and Graded-In Textiles click here](#)

When specifying contrasting upholstery, indicate clearly which upholstery is to be applied to the seat, back and arms. Use higher grade pricing.

- Indicate direction of fabric - Railroaded or Up the Roll
- Please provide illustration, if available

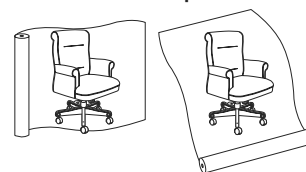
All COM orders must include the following:

- Vendor's name, pattern name and color
- Sample of the fabric attached to order
- Model numbers of items for fabric application
- Special application instructions (e.g., all stripes will be applied front to back unless specified otherwise)
- Customer and purchase order number

Ship prepaid COM material to:

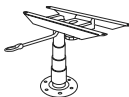
JSI
Attn: COM Department
201 East Martin Street
Receiving B, Dock 71
Orleans, IN 47452

Application of fabric:
Railroaded Up the Roll




All COM orders will ship at standard lead time from receipt of COM except for orders requiring special custom matched finishes.


5. Base Selection - wood base standard; specify wood finish
A. Black polyurethane base - no upcharge
B. Black pneumatic jury base - add \$203 list



Pneumatic lift-
NOT self-centering -
Standard

6. Optional Plastic Bumper Guard - add \$25 list

Description	Model	Specifications			List Price Per Grade	
Executive Swivel 	CR1275 • overall height range is 44 ½ - 48 • seat height range is 20 - 23 • arm height range is 27 ½ - 30 ½	Dimensions	D	W	H	COM \$2,426
		Overall	26	28	48	A \$2,484
		Seat	19 ½	19	23	B \$2,591
		Arm			30 ½	COL/C \$2,784
		Upholstery	Shipping			D \$3,028
		COM Ydg	4	Ctn Wt	60	E \$3,275
		COL Sq Ft	72	Cu Ft	19	F \$3,532
						G \$3,900
						H \$4,293
						I \$4,906
				J \$5,643		
				L1 \$3,974		
				L2 \$4,368		

Description	Model	Specifications			List Price Per Grade	
Management Swivel 	CR1270 • overall height range is 39 ½ - 43 • seat height range is 20 - 23 • arm height range is 27 ½ - 30 ½	Dimensions	D	W	H	COM \$2,339
		Overall	26	28	43	A \$2,394
		Seat	19 ½	19	23	B \$2,504
		Arm			30 ½	COL/C \$2,695
		Upholstery	Shipping			D \$2,940
		COM Ydg	4	Ctn Wt	55	E \$3,187
		COL Sq Ft	72	Cu Ft	19	F \$3,446
						G \$3,813
						H \$4,206
						I \$4,820
				J \$5,556		
				L1 \$3,887		
				L2 \$4,278		

To Order, Specify:

- 1 Model Number
- 2 Wood Species - Maple (M)
- 3 Wood Base Finish [See Wood Base Finish Options](#)
- 4 Fabric Selection - vendor, pattern and color
Visit www.jsifurniture.com/finishes-and-materials/textiles for our textiles program.
See selection of standard and graded in manufacturers and patterns.
- 5 Base Selection - wood base standard; specify wood finish
A. Black Polyurethane Base - no upcharge
B. Black Pneumatic Jury Base - add \$203 list
- 6 Optional Plastic Bumper Guard - add \$25 list

Specifications

- Wood species - Maple.
- Seat has synthetic sheet webbing and 4" polyurethane foam.
- Back has polypropylene webbing and 2" polyurethane foam and integrated lumbar support.
- Arms have ½" polyurethane foam.
- Swivel models revolve, adjusts for height and tension, have knee-tilt with a non-tilt locking mechanism and wood base with antique brass hood over dual wheel casters.
- Spiral grooved hardwood dowels with corner blocks, glue and screws.

Cabaret Order Check List:



Specify:

- 1. Model Number
- 2. Wood Species - Maple (M)
- 3. Wood Leg Finish
- 4. Fabric Selection - vendor, pattern and color
- 5. Optional Rubber Cushion Nylon Glides - no upcharge

Example:

CR1271 | **M** | **HRV** | **MOMENTUM** | **VOX** | **MYSTIC**
 (model #) | (wood species) | (finish wood legs) | (fabric vendor) | (pattern name) | (pattern color)

1. Model Number

2. Wood Species - Maple (M)

3. Wood Leg Finish Options:

ALM	Ale Medium	HRV	Harvest
CAL	Ale Light Coordinate	CKC	Khaki Coordinate
BBM	Bourbon Medium	MINC	Mineral Coordinate
CBZ	Brazilwood Coordinate	MCH	Mocha
BARC	Barrel Coordinate	CPI	Pinnacle Walnut Coordinate
CBO	Bourbon Light Coordinate	PRL	Praline
CBG	Brighton Light Coordinate	RAVC	Raven Coordinate
BRM	Brighton Medium	SABC	Sable Coordinate
BUT	Butterscotch	SIE	Sienna
CNDC	Cinder Coordinate	CST	Studio Teak Coordinate
CLA	Classic	TRF	Truffle
CLL	Collectors	UMB	Umber
EGRC	Egret Coordinate	VALC	Valley Coordinate
ESP	Espresso	VEN	Venetian
FAWC	Fawn Coordinate	CWE	Weathered Ash Coordinate
FLX	Flax		
CGR	Graphite Coordinate		

4. Fabric Selection --Please supply the following:
 Fabric vendor/ Pattern name/ Pattern color

For a complete list of JSI Standard and Graded-In Textiles click [here](#)

When specifying contrasting upholstery, indicate clearly which upholstery is to be applied to the seat, back and arms. Use higher grade pricing.

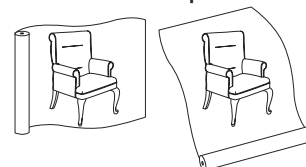
- Indicate direction of fabric - Railroaded or Up the Roll
- Please provide illustration, if available.

All COM orders must include the following:

- Vendor's name, pattern name and color
- Sample of the fabric attached to order
- Model numbers of items for fabric application
- Special application instructions (e.g., all stripes will be applied front to back unless specified otherwise)
- Customer and purchase order number


Ship prepaid COM material to:
 JSI
 Attn: COM Department
 201 East Martin Street
 Receiving B, Dock 71
 Orleans, IN 47452

Application of fabric:
 Railroaded Up the Roll



All COM orders will ship at standard lead time from receipt of COM except for orders requiring special custom matched finishes.

5. Optional Rubber Cushion Nylon Glides - no upcharge

Description	Model	Specifications			List Price Per Grade	
Guest Chair 	CR1271	Dimensions			COM \$1,940	
		Overall	D 31	W 29	H 38	A \$1,997
		Seat	19½	19	19½	B \$2,106
		Arm			27	COL/C \$2,296
		Upholstery		Shipping		D \$2,540
		COM Ydg	4	Ctn Wt	40	E \$2,787
		COL Sq Ft	72	Cu Ft	14	F \$3,047
						G \$3,414
						H \$3,806
						I \$4,420
				J \$5,158		
				L1 \$3,488		
				L2 \$3,880		

CABARET

To Order, Specify:

- 1 Model Number
- 2 Wood Species - Maple (M)
- 3 Wood Base Finish [See Wood Base Finish Options](#)
- 4 Fabric Selection - vendor, pattern and color
Visit www.jsifurniture.com/finishes-and-materials/textiles for our textiles program.
See selection of standard and graded in manufacturers and patterns.
- 5 Optional Plastic Bumper Guard - add \$25 list

Specifications

- Wood species - Maple.
- Seat has synthetic sheet webbing and 4" polyurethane foam.
- Back has polypropylene webbing and 2" polyurethane foam and integrated lumbar support.
- Arms have ½" polyurethane foam.
- Spiral grooved hardwood dowels with corner blocks, glue and screws.
- Standard with rubber cushion metal glides.

Class Act Order Check List:



Specify:

- 1. Model Number
- 2. Wood Species - Red Oak (RO) or Maple (M)
- 3. Wood Finish/Color
- 4. Fabric Selection - vendor, pattern and color
- 5. Optional Linking Brackets - add \$41 list per chair/bench
- 6. Optional Laser Engraved Back - specify location and size
- 7. Optional Rubber Cushion Nylon Glides - no upcharge; LEG MODELS ONLY

Example:

11C (model #)	RO (wood species)	HEN (finish)	MOMENTUM (fabric vendor)	VOX (pattern name)	MYSTIC (pattern color)
-------------------------	-----------------------------	------------------------	------------------------------------	------------------------------	----------------------------------

1. Model Number

2. Wood Species - Red Oak (RO) or Maple (M)

3. Wood Base/Arm Cap Finish Options:

Red Oak

BRW Brownie	ECU Ecru
CAN Canyon	HEN Henna
CIT Citron	HNY Honey
DES Desert	NUT Nut Brown

Maple

ALM Ale Medium	HRV Harvest
CAL Ale Light Coordinate	CKC Khaki Coordinate
BBM Bourbon Medium	MINC Mineral Coordinate
CBZ Brazilwood Coordinate	MCH Mocha
BARC Barrel Coordinate	CPI Pinnacle Walnut Coordinate
CBO Bourbon Light Coordinate	PRL Praline
CBG Brighton Light Coordinate	RAVC Raven Coordinate
BRM Brighton Medium	SABC Sable Coordinate
BUT Butterscotch	SIE Sienna
CNDC Cinder Coordinate	CST Studio Teak Coordinate
CLA Classic	TRF Truffle
CLL Collectors	UMB Umber
EGRC Egret Coordinate	VALC Valley Coordinate
ESP Espresso	VEN Venetian
FAWC Fawn Coordinate	CWE Weathered Ash Coordinate
FLX Flax	
CGR Graphite Coordinate	

Color - Add \$45 list per item

BKD Backdrop	GRV Greek Villa
BFX Black Fox	GLF Gulf Stream
BWH Bright White	HTB Heartthrob
CGP Cargo Pants	NET Network Gray
CHT Chatroom	NWH Nonchalant White
DSY Daisy	PAR Paradise
DRG Daring	QXP Quixotic Plum
DYN Dynamo	RBZ Relic Bronze
ENG Enigma	SND Sandbank
FRR French Roast	STM Storm
GBY Georgian Bay	TRC Tricorn Black

4. Fabric Selection - Please supply the following:

Fabric vendor/ Pattern name/ Pattern color

For a complete list of JSI Standard and Graded-In Textiles click [here](#)

When specifying contrasting upholstery, indicate clearly which upholstery is to be applied to the seat and back. Use higher grade pricing.

- Indicate direction of fabric - Railroaded or Up the Roll
- Please provide illustration, if available

All COM orders must include the following:

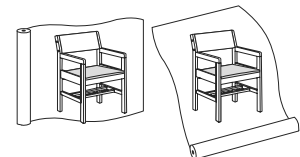
- Vendor's name, pattern name and color
- Sample of the fabric attached to order
- Model numbers of items for fabric application
- Special application instructions (e.g., all stripes will be applied front to back unless specified otherwise)
- Customer and purchase order number

Ship prepaid COM material to:

JSI
Attn: COM Department
201 East Martin Street
Receiving B, Dock 71
Orleans, IN 47452

Application of fabric:

Railroaded Up the Roll



All COM orders will ship at standard lead time from receipt of COM except for orders requiring special custom matched finishes.

5. Optional Linking Brackets - add \$41 list per chair/bench



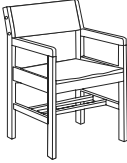

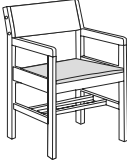
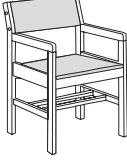
6. Optional Laser Engraved Back - available on models

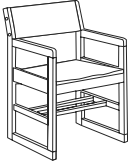
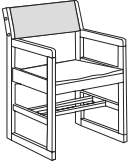
11A/C, 12A/C, 18A/C and 19A/C. See page VIII of the intro for details.

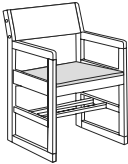


Specify:

- location - inside/outside of back
- size of design

Description	Model	Specifications	List Price Per Grade																
Arm  11A all wood	11A All Wood 11B Uph. Back <ul style="list-style-type: none"> optional linking brackets - add \$41 list per chair optional laser engraved back, specify location and size - see page VIII of Seating Price List online for details. (A model only) coordinating Children's collection - see page CA8 optional casters - add \$123 list for a set of 4 casters 	<table border="1"> <thead> <tr> <th>Dimensions</th> <th>D</th> <th>W</th> <th>H</th> </tr> </thead> <tbody> <tr> <td>Overall</td> <td>22</td> <td>21</td> <td>32 ¼</td> </tr> <tr> <td>Seat</td> <td>18</td> <td>19</td> <td>18</td> </tr> <tr> <td>Arm</td> <td></td> <td></td> <td>25 ¼</td> </tr> </tbody> </table>	Dimensions	D	W	H	Overall	22	21	32 ¼	Seat	18	19	18	Arm			25 ¼	All Wood \$544 COM \$626 A \$647 B \$668 COL/C \$705 D \$752 E \$803 F \$853 G \$923 H \$1,000 I \$1,120 J \$1,265 L1 \$939 L2 \$1,014
		Dimensions	D	W	H														
Overall	22	21	32 ¼																
Seat	18	19	18																
Arm			25 ¼																
 11B uph. back	<table border="1"> <thead> <tr> <th colspan="2">Upholstery</th> <th colspan="2">Shipping</th> </tr> </thead> <tbody> <tr> <td>COM Ydg</td> <td>¾</td> <td>Ctn Wt</td> <td>30</td> </tr> <tr> <td>COL Sq Ft</td> <td>9</td> <td>Cu Ft</td> <td>10</td> </tr> </tbody> </table>	Upholstery		Shipping		COM Ydg	¾	Ctn Wt	30	COL Sq Ft	9	Cu Ft	10						
Upholstery		Shipping																	
COM Ydg	¾	Ctn Wt	30																
COL Sq Ft	9	Cu Ft	10																
Arm 	11C Uph. Seat <ul style="list-style-type: none"> optional linking brackets - add \$41 list per chair optional laser engraved back, specify location and size - see page VIII of Seating Price List online for details. coordinating Children's collection - see page CA8 optional casters - add \$123 list for a set of 4 casters 	<table border="1"> <thead> <tr> <th>Dimensions</th> <th>D</th> <th>W</th> <th>H</th> </tr> </thead> <tbody> <tr> <td>Overall</td> <td>22</td> <td>21</td> <td>32 ¼</td> </tr> <tr> <td>Seat</td> <td>18</td> <td>19</td> <td>18</td> </tr> <tr> <td>Arm</td> <td></td> <td></td> <td>25 ¼</td> </tr> </tbody> </table>	Dimensions	D	W	H	Overall	22	21	32 ¼	Seat	18	19	18	Arm			25 ¼	COM \$626 A \$647 B \$668 COL/C \$705 D \$752 E \$803 F \$853 G \$923 H \$1,000 I \$1,120 J \$1,265 L1 \$939 L2 \$1,014
Dimensions	D	W	H																
Overall	22	21	32 ¼																
Seat	18	19	18																
Arm			25 ¼																
Arm 	11D Uph. Seat/Back <ul style="list-style-type: none"> optional linking brackets - add \$41 list per chair coordinating Children's collection - see page CA8 optional casters - add \$123 list for a set of 4 casters 	<table border="1"> <thead> <tr> <th>Dimensions</th> <th>D</th> <th>W</th> <th>H</th> </tr> </thead> <tbody> <tr> <td>Overall</td> <td>22</td> <td>21</td> <td>32 ¼</td> </tr> <tr> <td>Seat</td> <td>18</td> <td>19</td> <td>18</td> </tr> <tr> <td>Arm</td> <td></td> <td></td> <td>25 ¼</td> </tr> </tbody> </table>	Dimensions	D	W	H	Overall	22	21	32 ¼	Seat	18	19	18	Arm			25 ¼	COM \$693 A \$716 B \$737 COL/C \$775 D \$822 E \$869 F \$918 G \$990 H \$1,068 I \$1,189 J \$1,330 L1 \$1,006 L2 \$1,082
Dimensions	D	W	H																
Overall	22	21	32 ¼																
Seat	18	19	18																
Arm			25 ¼																

Description	Model	Specifications	List Price Per Grade																																																								
Arm  <p>12A all wood</p>  <p>12B uph. back</p>	12A All Wood 12B Uph. Back <ul style="list-style-type: none"> optional linking brackets - add \$41 list per chair optional laser engraved back, specify location and size - see page VIII of Seating Price List online for details. (A model only) coordinating Children's collection - see page CA8 	<table border="1"> <thead> <tr> <th>Dimensions</th> <th>D</th> <th>W</th> <th>H</th> </tr> </thead> <tbody> <tr> <td>Overall</td> <td>20 ¾</td> <td>21</td> <td>32 ¼</td> </tr> <tr> <td>Seat</td> <td>18</td> <td>19</td> <td>18</td> </tr> <tr> <td>Arm</td> <td colspan="3">25</td> </tr> <tr> <th colspan="2">Upholstery</th> <th colspan="2">Shipping</th> </tr> <tr> <td>COM Ydg</td> <td>¾</td> <td>Ctn Wt</td> <td>32</td> </tr> <tr> <td>COL Sq Ft</td> <td>9</td> <td>Cu Ft</td> <td>10</td> </tr> </tbody> </table>	Dimensions	D	W	H	Overall	20 ¾	21	32 ¼	Seat	18	19	18	Arm	25			Upholstery		Shipping		COM Ydg	¾	Ctn Wt	32	COL Sq Ft	9	Cu Ft	10	<table> <tr><td>All Wood</td><td>\$560</td></tr> <tr><td>COM</td><td>\$637</td></tr> <tr><td>A</td><td>\$660</td></tr> <tr><td>B</td><td>\$681</td></tr> <tr><td>COL/C</td><td>\$717</td></tr> <tr><td>D</td><td>\$765</td></tr> <tr><td>E</td><td>\$811</td></tr> <tr><td>F</td><td>\$866</td></tr> <tr><td>G</td><td>\$938</td></tr> <tr><td>H</td><td>\$1,012</td></tr> <tr><td>I</td><td>\$1,130</td></tr> <tr><td>J</td><td>\$1,277</td></tr> <tr><td>L1</td><td>\$950</td></tr> <tr><td>L2</td><td>\$1,026</td></tr> </table>	All Wood	\$560	COM	\$637	A	\$660	B	\$681	COL/C	\$717	D	\$765	E	\$811	F	\$866	G	\$938	H	\$1,012	I	\$1,130	J	\$1,277	L1	\$950	L2	\$1,026
	Dimensions	D	W	H																																																							
Overall	20 ¾	21	32 ¼																																																								
Seat	18	19	18																																																								
Arm	25																																																										
Upholstery		Shipping																																																									
COM Ydg	¾	Ctn Wt	32																																																								
COL Sq Ft	9	Cu Ft	10																																																								
All Wood	\$560																																																										
COM	\$637																																																										
A	\$660																																																										
B	\$681																																																										
COL/C	\$717																																																										
D	\$765																																																										
E	\$811																																																										
F	\$866																																																										
G	\$938																																																										
H	\$1,012																																																										
I	\$1,130																																																										
J	\$1,277																																																										
L1	\$950																																																										
L2	\$1,026																																																										

Arm 	12C Uph. Seat <ul style="list-style-type: none"> optional linking brackets - add \$41 list per chair optional laser engraved back, specify location and size - see page VIII of Seating Price List online for details. coordinating Children's collection - see page CA8 	<table border="1"> <thead> <tr> <th>Dimensions</th> <th>D</th> <th>W</th> <th>H</th> </tr> </thead> <tbody> <tr> <td>Overall</td> <td>20 ¾</td> <td>21</td> <td>32 ¼</td> </tr> <tr> <td>Seat</td> <td>18</td> <td>19</td> <td>18</td> </tr> <tr> <td>Arm</td> <td colspan="3">25</td> </tr> <tr> <th colspan="2">Upholstery</th> <th colspan="2">Shipping</th> </tr> <tr> <td>COM Ydg</td> <td>¾</td> <td>Ctn Wt</td> <td>32</td> </tr> <tr> <td>COL Sq Ft</td> <td>9</td> <td>Cu Ft</td> <td>10</td> </tr> </tbody> </table>	Dimensions	D	W	H	Overall	20 ¾	21	32 ¼	Seat	18	19	18	Arm	25			Upholstery		Shipping		COM Ydg	¾	Ctn Wt	32	COL Sq Ft	9	Cu Ft	10	<table> <tr><td>COM</td><td>\$637</td></tr> <tr><td>A</td><td>\$660</td></tr> <tr><td>B</td><td>\$681</td></tr> <tr><td>COL/C</td><td>\$717</td></tr> <tr><td>D</td><td>\$765</td></tr> <tr><td>E</td><td>\$811</td></tr> <tr><td>F</td><td>\$866</td></tr> <tr><td>G</td><td>\$938</td></tr> <tr><td>H</td><td>\$1,012</td></tr> <tr><td>I</td><td>\$1,130</td></tr> <tr><td>J</td><td>\$1,277</td></tr> <tr><td>L1</td><td>\$950</td></tr> <tr><td>L2</td><td>\$1,026</td></tr> </table>	COM	\$637	A	\$660	B	\$681	COL/C	\$717	D	\$765	E	\$811	F	\$866	G	\$938	H	\$1,012	I	\$1,130	J	\$1,277	L1	\$950	L2	\$1,026
Dimensions	D	W	H																																																						
Overall	20 ¾	21	32 ¼																																																						
Seat	18	19	18																																																						
Arm	25																																																								
Upholstery		Shipping																																																							
COM Ydg	¾	Ctn Wt	32																																																						
COL Sq Ft	9	Cu Ft	10																																																						
COM	\$637																																																								
A	\$660																																																								
B	\$681																																																								
COL/C	\$717																																																								
D	\$765																																																								
E	\$811																																																								
F	\$866																																																								
G	\$938																																																								
H	\$1,012																																																								
I	\$1,130																																																								
J	\$1,277																																																								
L1	\$950																																																								
L2	\$1,026																																																								

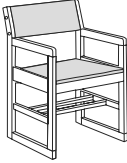

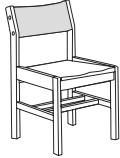

To Order, Specify:


- Model Number
- Wood Species - Red Oak (RO) or Maple (M)
- Wood Finish/Color [See Wood Finish/Color Options](#)
- Fabric Selection - vendor, pattern and color
Visit www.jsifurniture.com/finishes-and-materials/textiles for our textiles program.
See selection of standard and graded in manufacturers and patterns.
- Optional Linking Brackets - add \$41 list per chair
- Optional Laser Engraved Back - specify location and size; see page VIII of Seating Price List online for details.
(A and C MODELS ONLY)
- Optional Rubber Cushion Nylon Glides - no upcharge

LEG MODELS ONLY

Specifications

- Wood species - Red Oak or Maple.
- Two stretcher shelf for added stability.
- Seat is upholstered with 1 ½" polyurethane foam and synthetic sheet webbing for added comfort.
- Back is upholstered front and back with 1" polyurethane foam.
- Mortise and tenon construction with corner blocks, glue and screws.
- Coordinating Children's collection. See page [CA8](#).
- Standard with rubber cushion metal glides (leg models only).

Description	Model	Specifications	List Price Per Grade																
Arm 	12D Uph. Seat/Back · optional linking brackets - add \$41 list per chair · coordinating Children's collection - see page CA8	<table border="1"> <thead> <tr> <th>Dimensions</th> <th>D</th> <th>W</th> <th>H</th> </tr> </thead> <tbody> <tr> <td>Overall</td> <td>20 ¾</td> <td>21</td> <td>32 ¼</td> </tr> <tr> <td>Seat</td> <td>18</td> <td>19</td> <td>18</td> </tr> <tr> <td>Arm</td> <td></td> <td></td> <td>25</td> </tr> </tbody> </table>	Dimensions	D	W	H	Overall	20 ¾	21	32 ¼	Seat	18	19	18	Arm			25	COM \$706 A \$730 B \$748 COL/C \$787 D \$836 E \$885 F \$933 G \$1,006 H \$1,082 I \$1,202 J \$1,346 L1 \$1,020 L2 \$1,097
		Dimensions	D	W	H														
		Overall	20 ¾	21	32 ¼														
		Seat	18	19	18														
		Arm			25														
		<table border="1"> <thead> <tr> <th>Upholstery</th> <th colspan="3">Shipping</th> </tr> </thead> <tbody> <tr> <td>COM Ydg</td> <td>¾</td> <td>Ctn Wt</td> <td>32</td> </tr> <tr> <td>COL Sq Ft</td> <td>18</td> <td>Cu Ft</td> <td>10</td> </tr> </tbody> </table>	Upholstery	Shipping			COM Ydg	¾	Ctn Wt	32	COL Sq Ft	18	Cu Ft	10					
		Upholstery	Shipping																
		COM Ydg	¾	Ctn Wt	32														
		COL Sq Ft	18	Cu Ft	10														
		Armless 	18A All Wood 18B Uph. Back · optional linking brackets - add \$41 list per chair · optional laser engraved back, specify location and size - see page VIII of Seating Price List online for details. (A model only) · coordinating Children's collection - see page CA8 · optional casters - add \$123 list for a set of 4 casters	<table border="1"> <thead> <tr> <th>Dimensions</th> <th>D</th> <th>W</th> <th>H</th> </tr> </thead> <tbody> <tr> <td>Overall</td> <td>20 ½</td> <td>19</td> <td>32 ½</td> </tr> <tr> <td>Seat</td> <td>18 ¼</td> <td>17</td> <td>18</td> </tr> </tbody> </table>	Dimensions	D	W	H	Overall	20 ½	19	32 ½	Seat	18 ¼	17	18	All Wood \$500 COM \$580 A \$604 B \$624 COL/C \$664 D \$710 E \$756 F \$807 G \$881 H \$957 I \$1,077 J \$1,220 L1 \$893 L2 \$973		
Dimensions	D			W	H														
Overall	20 ½			19	32 ½														
Seat	18 ¼			17	18														
<table border="1"> <thead> <tr> <th>Upholstery</th> <th colspan="3">Shipping</th> </tr> </thead> <tbody> <tr> <td>COM Ydg</td> <td>¾</td> <td>Ctn Wt</td> <td>25</td> </tr> <tr> <td>COL Sq Ft</td> <td>9</td> <td>Cu Ft</td> <td>10</td> </tr> </tbody> </table>	Upholstery			Shipping			COM Ydg	¾	Ctn Wt	25	COL Sq Ft	9	Cu Ft	10					
Upholstery	Shipping																		
COM Ydg	¾			Ctn Wt	25														
COL Sq Ft	9			Cu Ft	10														
	18B Uph. Back · optional linking brackets - add \$41 list per chair · optional laser engraved back, specify location and size - see page VIII of Seating Price List online for details. (A model only) · coordinating Children's collection - see page CA8 · optional casters - add \$123 list for a set of 4 casters			<table border="1"> <thead> <tr> <th>Dimensions</th> <th>D</th> <th>W</th> <th>H</th> </tr> </thead> <tbody> <tr> <td>Overall</td> <td>20 ½</td> <td>19</td> <td>32 ½</td> </tr> <tr> <td>Seat</td> <td>18 ¼</td> <td>17</td> <td>18</td> </tr> </tbody> </table>	Dimensions	D	W	H	Overall	20 ½	19	32 ½	Seat	18 ¼	17	18		All Wood \$500 COM \$580 A \$604 B \$624 COL/C \$664 D \$710 E \$756 F \$807 G \$881 H \$957 I \$1,077 J \$1,220 L1 \$893 L2 \$973	
				Dimensions	D	W	H												
		Overall	20 ½	19	32 ½														
		Seat	18 ¼	17	18														
		<table border="1"> <thead> <tr> <th>Upholstery</th> <th colspan="3">Shipping</th> </tr> </thead> <tbody> <tr> <td>COM Ydg</td> <td>¾</td> <td>Ctn Wt</td> <td>25</td> </tr> <tr> <td>COL Sq Ft</td> <td>9</td> <td>Cu Ft</td> <td>10</td> </tr> </tbody> </table>	Upholstery	Shipping			COM Ydg	¾	Ctn Wt	25	COL Sq Ft	9	Cu Ft	10					
		Upholstery	Shipping																
		COM Ydg	¾	Ctn Wt	25														
		COL Sq Ft	9	Cu Ft	10														
		Armless 	18C Uph. Seat · optional linking brackets - add \$41 list per chair · optional laser engraved back, specify location and size - see page VIII of Seating Price List online for details. · coordinating Children's collection - see page CA8 · optional casters - add \$123 list for a set of 4 casters	<table border="1"> <thead> <tr> <th>Dimensions</th> <th>D</th> <th>W</th> <th>H</th> </tr> </thead> <tbody> <tr> <td>Overall</td> <td>20 ½</td> <td>19</td> <td>32 ½</td> </tr> <tr> <td>Seat</td> <td>18 ¼</td> <td>17</td> <td>18</td> </tr> </tbody> </table>	Dimensions	D	W	H	Overall	20 ½	19	32 ½	Seat	18 ¼	17	18	COM \$580 A \$604 B \$624 COL/C \$664 D \$710 E \$756 F \$807 G \$881 H \$957 I \$1,077 J \$1,220 L1 \$893 L2 \$973		
				Dimensions	D	W	H												
Overall	20 ½			19	32 ½														
Seat	18 ¼			17	18														
<table border="1"> <thead> <tr> <th>Upholstery</th> <th colspan="3">Shipping</th> </tr> </thead> <tbody> <tr> <td>COM Ydg</td> <td>¾</td> <td>Ctn Wt</td> <td>25</td> </tr> <tr> <td>COL Sq Ft</td> <td>9</td> <td>Cu Ft</td> <td>10</td> </tr> </tbody> </table>	Upholstery			Shipping			COM Ydg	¾	Ctn Wt	25	COL Sq Ft	9	Cu Ft	10					
Upholstery	Shipping																		
COM Ydg	¾			Ctn Wt	25														
COL Sq Ft	9			Cu Ft	10														

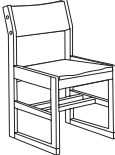

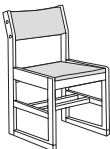
Description	① Model	Specifications			List Price Per Grade		
Armless 	18D Uph. Seat/Back · optional linking brackets - add \$41 list per chair · coordinating Children's collection - see page CA8 · optional casters - add \$123 list for a set of 4 casters	Dimensions			COM	\$649	
			D	W	H	A	\$670
		Overall	20 ½	19	32 ½	B	\$693
		Seat	18 ¼	17	18	COL/C	\$730
						D	\$779
		Upholstery		Shipping			
		COM Ydg	¾	Ctn Wt	25	E	\$826
		COL Sq Ft	18	Cu Ft	10	F	\$879
						G	\$949
						H	\$1,024
						I	\$1,145
						J	\$1,289
						L1	\$961
						L2	\$1,039

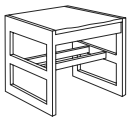

To Order, Specify:

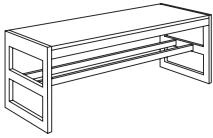
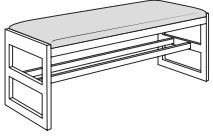
- ① Model Number
- ② Wood Species - Red Oak (RO) or Maple (M)
- ③ Wood Finish/Color [See Wood Finish/Color Options](#)
- ④ Fabric Selection - vendor, pattern and color
 Visit www.jsifurniture.com/finishes-and-materials/textiles for our textiles program.
 See selection of standard and graded in manufacturers and patterns.
- ⑤ Optional Linking Brackets - add \$41 list per chair
- ⑥ Optional Laser Engraved Back - specify location and size; see page VIII of Seating Price List online for details.
(A and C MODELS ONLY)
- ⑦ Optional Rubber Cushion Nylon Glides - no upcharge
LEG MODELS ONLY

Specifications

- Wood species - Red Oak or Maple.
- Two stretcher shelf for added stability.
- Seat is upholstered with 1 ½" polyurethane foam and synthetic sheet webbing for added comfort.
- Back is upholstered front and back with 1" polyurethane foam.
- Mortise and tenon construction with corner blocks, glue and screws.
- Coordinating Children's collection. See page CA8.
- Standard with rubber cushion metal glides (leg models only).

Description	Model	Specifications	List Price Per Grade												
Armless  19A all wood	19A All Wood 19B Uph. Back · optional linking brackets - add \$41 list per chair · optional laser engraved back, specify location and size - see page VIII of Seating Price List online for details. (A model only) · coordinating Children's collection - see page CA8	<table border="1"> <thead> <tr> <th>Dimensions</th> <th>D</th> <th>W</th> <th>H</th> </tr> </thead> <tbody> <tr> <td>Overall</td> <td>20 ½</td> <td>19</td> <td>32 ¼</td> </tr> <tr> <td>Seat</td> <td>18</td> <td>17</td> <td>18</td> </tr> </tbody> </table>	Dimensions	D	W	H	Overall	20 ½	19	32 ¼	Seat	18	17	18	All Wood \$513 COM \$596 A \$617 B \$636 COL/C \$674 D \$721 E \$771 F \$817 G \$892 H \$971 I \$1,087 J \$1,232 L1 \$908 L2 \$981
		Dimensions	D	W	H										
Overall	20 ½	19	32 ¼												
Seat	18	17	18												
<table border="1"> <thead> <tr> <th>Upholstery</th> <th colspan="3">Shipping</th> </tr> </thead> <tbody> <tr> <td>COM Ydg</td> <td>¾</td> <td>Ctn Wt</td> <td>28</td> </tr> <tr> <td>COL Sq Ft</td> <td>9</td> <td>Cu Ft</td> <td>10</td> </tr> </tbody> </table>	Upholstery	Shipping			COM Ydg	¾	Ctn Wt	28	COL Sq Ft	9	Cu Ft	10			
Upholstery	Shipping														
COM Ydg	¾	Ctn Wt	28												
COL Sq Ft	9	Cu Ft	10												
Armless 	19C Uph. Seat · optional linking brackets - add \$41 list per chair · optional laser engraved back, specify location and size - see page VIII of Seating Price List online for details. · coordinating Children's collection - see page CA8	<table border="1"> <thead> <tr> <th>Dimensions</th> <th>D</th> <th>W</th> <th>H</th> </tr> </thead> <tbody> <tr> <td>Overall</td> <td>20 ½</td> <td>19</td> <td>32 ¼</td> </tr> <tr> <td>Seat</td> <td>18</td> <td>17</td> <td>18</td> </tr> </tbody> </table>	Dimensions	D	W	H	Overall	20 ½	19	32 ¼	Seat	18	17	18	COM \$596 A \$617 B \$636 COL/C \$674 D \$721 E \$771 F \$817 G \$892 H \$971 I \$1,087 J \$1,232 L1 \$908 L2 \$981
Dimensions	D	W	H												
Overall	20 ½	19	32 ¼												
Seat	18	17	18												
		<table border="1"> <thead> <tr> <th>Upholstery</th> <th colspan="3">Shipping</th> </tr> </thead> <tbody> <tr> <td>COM Ydg</td> <td>¾</td> <td>Ctn Wt</td> <td>28</td> </tr> <tr> <td>COL Sq Ft</td> <td>9</td> <td>Cu Ft</td> <td>10</td> </tr> </tbody> </table>	Upholstery	Shipping			COM Ydg	¾	Ctn Wt	28	COL Sq Ft	9	Cu Ft	10	
Upholstery	Shipping														
COM Ydg	¾	Ctn Wt	28												
COL Sq Ft	9	Cu Ft	10												
Armless 	19D Uph. Seat/Back · optional linking brackets - add \$41 list per chair · coordinating Children's collection - see page CA8	<table border="1"> <thead> <tr> <th>Dimensions</th> <th>D</th> <th>W</th> <th>H</th> </tr> </thead> <tbody> <tr> <td>Overall</td> <td>20 ½</td> <td>19</td> <td>32 ¼</td> </tr> <tr> <td>Seat</td> <td>18</td> <td>17</td> <td>18</td> </tr> </tbody> </table>	Dimensions	D	W	H	Overall	20 ½	19	32 ¼	Seat	18	17	18	COM \$664 A \$683 B \$705 COL/C \$743 D \$788 E \$837 F \$888 G \$960 H \$1,036 I \$1,157 J \$1,298 L1 \$975 L2 \$1,053
Dimensions	D	W	H												
Overall	20 ½	19	32 ¼												
Seat	18	17	18												
		<table border="1"> <thead> <tr> <th>Upholstery</th> <th colspan="3">Shipping</th> </tr> </thead> <tbody> <tr> <td>COM Ydg</td> <td>¾</td> <td>Ctn Wt</td> <td>28</td> </tr> <tr> <td>COL Sq Ft</td> <td>18</td> <td>Cu Ft</td> <td>10</td> </tr> </tbody> </table>	Upholstery	Shipping			COM Ydg	¾	Ctn Wt	28	COL Sq Ft	18	Cu Ft	10	
Upholstery	Shipping														
COM Ydg	¾	Ctn Wt	28												
COL Sq Ft	18	Cu Ft	10												

Description	Model	Specifications			List Price Per Grade		
		Dimensions	D	W	H	All Wood	COM
Bench 19"w	25A All Wood	Overall	19	19	18	\$597	\$597
	25C Uph. Seat	Seat	19	17	18	A \$618	B \$637
	· optional linking brackets - add \$41 list per bench	Upholstery		Shipping		COL/C \$675	D \$723
		COM Ydg	¾	Ctn Wt	22	E \$772	F \$822
25A all wood		COL Sq Ft	9	Cu Ft	5	G \$893	H \$973
25C uph. seat						I \$1,088	J \$1,233
						L1 \$910	L2 \$983

Description	Model	Specifications			List Price Per Grade		
		Dimensions	D	W	H	All Wood	COM
Bench 48"w	26A All Wood	Overall	19	48	18	\$924	\$917
	26C Uph. Seat	Seat	19	46	18	A \$943	B \$962
	· optional linking brackets - add \$41 list per bench	Upholstery		Shipping		COL/C \$1,004	D \$1,050
		COM Ydg	¾	Ctn Wt	34	E \$1,099	F \$1,147
26A all wood		COL Sq Ft	23	Cu Ft	13	G \$1,220	H \$1,296
26C uph. seat						I \$1,416	J \$1,560
						L1 \$1,233	L2 \$1,310

To Order, Specify:

- 1 Model Number
- 2 Wood Species - Red Oak (RO) or Maple (M)
- 3 Wood Finish/Color [See Wood Finish/Color Options](#)
- 4 Fabric Selection - vendor, pattern and color
Visit www.jsifurniture.com/finishes-and-materials/textiles for our textiles program.
See selection of standard and graded in manufacturers and patterns.
- 5 Optional Linking Brackets - add \$41 list per chair
- 6 Optional Laser Engraved Back - specify location and size; see page VIII of Seating Price List online for details.
(A and C MODELS ONLY)
- 7 Optional Rubber Cushion Nylon Glides - no upcharge
LEG MODELS ONLY

Specifications

- Wood species - Red Oak or Maple.
- Two stretcher shelf for added stability.
- Seat is upholstered with 1 ½" polyurethane foam and synthetic sheet webbing for added comfort.
- Back is upholstered front and back with 1" polyurethane foam.
- Mortise and tenon construction with corner blocks, glue and screws.
- Coordinating Children's collection. See page [CA8](#).
- Standard with rubber cushion metal glides (leg models only).

Class Act Children's Order Check List:



Specify:

- 1. Model Number
- 2. Wood Species - Red Oak (RO) or Maple (M)
- 3. Wood Finish/Color
- 4. Fabric Selection - vendor, pattern and color
- 5. Optional Linking Brackets - add \$41 list per chair
- 6. Optional Laser Engraved Back - specify location
- 7. Optional Casters - add \$123 list; standard seat height maintained; LEG MODELS ONLY
- 8. Optional Rubber Cushion Nylon Glides - no upcharge; LEG MODELS ONLY

Example:

16C | **RO** | **HEN** | **MOMENTUM** | **VOX** | **MYSTIC**
 (model #) | (wood species) | (finish) | (fabric vendor) | (pattern name) | (pattern color)

1. Model Number

2. Wood Species - Red Oak (RO) or Maple (M)

3. Wood Finish/Color Options:

Red Oak

BRW	Brownie	ECU	Ecru
CAN	Canyon	HEN	Henna
CIT	Citron	HNY	Honey
DES	Desert	NUT	Nut Brown

Maple

ALM	Ale Medium	HRV	Harvest
CAL	Ale Light Coordinate	CKC	Khaki Coordinate
BBM	Bourbon Medium	MINC	Mineral Coordinate
CBZ	Brazilwood Coordinate	MCH	Mocha
BARC	Barrel Coordinate	CPI	Pinnacle Walnut Coordinate
CBO	Bourbon Light Coordinate	PRL	Praline
CBG	Brighton Light Coordinate	RAVC	Raven Coordinate
BRM	Brighton Medium	SABC	Sable Coordinate
BUT	Butterscotch	SIE	Sienna
CNDC	Cinder Coordinate	CST	Studio Teak Coordinate
CLA	Classic	TRF	Truffle
CLL	Collectors	UMB	Umber
EGRC	Egret Coordinate	VALC	Valley Coordinate
ESP	Espresso	VEN	Venetian
FAWC	Fawn Coordinate	CWE	Weathered Ash Coordinate
FLX	Flax		
CGR	Graphite Coordinate		

Color - Add \$45 list per item; not available with Laser

Engraving option

BKD	Backdrop	GRV	Greek Villa
BFX	Black Fox	GLF	Gulf Stream
BWH	Bright White	HTB	Heartthrob
CGP	Cargo Pants	NET	Network Gray
CHT	Chatroom	NWH	Nonchalant White
DSY	Daisy	PAR	Paradise
DRG	Daring	QXP	Quixotic Plum
DYN	Dynamo	RBZ	Relic Bronze
ENG	Enigma	SND	Sandbank
FRR	French Roast	STM	Storm
GBY	Georgian Bay	TRC	Tricorn Black

4. Fabric Selection - Please supply the following:

Fabric vendor/ Pattern name/ Pattern color

For a complete list of JSI Standard and Graded-In Textiles click here

When specifying contrasting upholstery, indicate clearly which upholstery is to be applied to the seat and back. Use higher grade pricing.

- Indicate direction of fabric - Railroaded or Up the Roll
- Please provide illustration, if available

All COM orders must include the following:

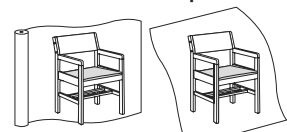
- Vendor's name, pattern name and color
- Sample of the fabric attached to order
- Model numbers of items for fabric application
- Special application instructions (e.g., all stripes will be applied front to back unless specified otherwise)
- Customer and purchase order number

Ship prepaid COM

material to:
 JSI
 Attn: COM Department
 201 East Martin Street
 Receiving B, Dock 71
 Orleans, IN 47452

Application of fabric:

Railroaded Up the Roll



All COM orders will ship at standard lead time from receipt of COM except for orders requiring special custom matched finishes.

5. Optional Linking Brackets - add \$41 list per chair



6. Optional Laser Engraved Back - available on models 14A/C, 15A/C, 16A/C and 17A/C. See page VIII of Seating Price List online for details.







Specify:

- location - inside/outside of back
- size of design

7. Optional Casters - add \$123 list; standard seat height maintained. LEG MODELS ONLY

8. Optional Rubber Cushion Nylon Glides - no upcharge LEG MODELS ONLY

Description	Model	Specifications				List Price Per Grade	
		Dimensions	D	W	H	All Wood	COM
Armless 14" h  14A all wood	14A All Wood 14B Uph. Back 14C Uph. Seat • optional laser engraved back, specify location and size; see page VIII of Seating Price List online for specifications. (A and C models only)	Overall	15	15	25	\$450	\$536
		Seat	13	13	14	\$559	\$574
		Upholstery		Shipping			\$608
 14B uph. back		COM Ydg	2/3	Ctn Wt	17	\$649	\$693
		COL Sq Ft	8	Cu Ft	4	\$740	\$803
 14C uph. seat						\$869	\$976
							\$1,102
						\$882	









Description	Model	Specifications				List Price Per Grade	
		Dimensions	D	W	H	COM	A
Armless 14" h 	14D Uph. Seat/Back	Overall	15	15	25	\$604	\$622
		Seat	13	13	14	\$641	\$675
		Upholstery		Shipping			\$717
		COM Ydg	2/3	Ctn Wt	17	\$759	\$805
		COL Sq Ft	16	Cu Ft	4	\$868	\$938
						\$1,043	\$1,171
						\$882	\$950





To Order, Specify:

- 1 Model Number
 - 2 Wood Species - Red Oak (RO) or Maple (M)
 - 3 Wood Finish/Color [See Wood Finish/Color Options](#)
 - 4 Fabric Selection - vendor, pattern and color
Visit www.jsifurniture.com/finishes-and-materials/textiles for our textiles program.
See selection of standard and graded in manufacturers and patterns.
 - 5 Optional Linking Brackets - add \$41 list per chair
 - 6 Optional Laser Engraved Back - specify location and size; see page VIII of Seating Price List online for details.
(A and C MODELS ONLY)
 - 7 Optional Rubber Cushion Nylon Glides - no upcharge
- LEG MODELS ONLY**

Specifications

- Wood species - Red Oak or Maple.
- Two stretcher shelf for added stability.
- Seat is upholstered with 1 1/2" polyurethane foam and synthetic sheet webbing for added comfort.
- Back is upholstered front and back with 1" polyurethane foam.
- Mortise and tenon construction with corner blocks, glue and screws.
- Coordinating Children's collection. See page [CA8](#).
- Standard with rubber cushion metal glides (leg models only).

Description	Model	Specifications	List Price Per Grade																								
Armless 14" h  15A all wood	15A All Wood 15B Uph. Back 15C Uph. Seat · optional laser engraved back, specify location and size; see page VIII of Seating Price List online for specifications. (A and C models only)	<table border="1"> <thead> <tr> <th>Dimensions</th> <th>D</th> <th>W</th> <th>H</th> </tr> </thead> <tbody> <tr> <td>Overall</td> <td>15</td> <td>15</td> <td>25</td> </tr> <tr> <td>Seat</td> <td>13</td> <td>13</td> <td>14</td> </tr> <tr> <th colspan="2">Upholstery</th> <th colspan="2">Shipping</th> </tr> <tr> <td>COM Ydg</td> <td>⅔</td> <td>Ctn Wt</td> <td>17</td> </tr> <tr> <td>COL Sq Ft</td> <td>8</td> <td>Cu Ft</td> <td>4</td> </tr> </tbody> </table>	Dimensions	D	W	H	Overall	15	15	25	Seat	13	13	14	Upholstery		Shipping		COM Ydg	⅔	Ctn Wt	17	COL Sq Ft	8	Cu Ft	4	All Wood \$469 COM \$545 A \$566 B \$583 COL/C \$618 D \$662 E \$704 F \$747 G \$810 H \$881 I \$986 J \$1,115 L1 \$825 L2 \$892
		Dimensions	D	W	H																						
		Overall	15	15	25																						
Seat	13	13	14																								
Upholstery		Shipping																									
COM Ydg	⅔	Ctn Wt	17																								
COL Sq Ft	8	Cu Ft	4																								
 15B uph. back																											
 15C uph. seat																											
Armless 14" h 	15D Uph. Seat/Back	<table border="1"> <thead> <tr> <th>Dimensions</th> <th>D</th> <th>W</th> <th>H</th> </tr> </thead> <tbody> <tr> <td>Overall</td> <td>15</td> <td>15</td> <td>25</td> </tr> <tr> <td>Seat</td> <td>13</td> <td>13</td> <td>14</td> </tr> <tr> <th colspan="2">Upholstery</th> <th colspan="2">Shipping</th> </tr> <tr> <td>COM Ydg</td> <td>⅔</td> <td>Ctn Wt</td> <td>17</td> </tr> <tr> <td>COL Sq Ft</td> <td>16</td> <td>Cu Ft</td> <td>4</td> </tr> </tbody> </table>	Dimensions	D	W	H	Overall	15	15	25	Seat	13	13	14	Upholstery		Shipping		COM Ydg	⅔	Ctn Wt	17	COL Sq Ft	16	Cu Ft	4	COM \$618 A \$636 B \$655 COL/C \$689 D \$733 E \$775 F \$816 G \$885 H \$950 I \$1,057 J \$1,187 L1 \$894 L2 \$962
Dimensions	D	W	H																								
Overall	15	15	25																								
Seat	13	13	14																								
Upholstery		Shipping																									
COM Ydg	⅔	Ctn Wt	17																								
COL Sq Ft	16	Cu Ft	4																								
Armless 16" h  16A all wood	16A All Wood 16B Uph. Back 16C Uph. Seat · optional laser engraved back, specify location and size; see page VIII of Seating Price List online for specifications. (A and C models only)	<table border="1"> <thead> <tr> <th>Dimensions</th> <th>D</th> <th>W</th> <th>H</th> </tr> </thead> <tbody> <tr> <td>Overall</td> <td>16</td> <td>17</td> <td>28 ¾</td> </tr> <tr> <td>Seat</td> <td>14</td> <td>15</td> <td>16</td> </tr> <tr> <th colspan="2">Upholstery</th> <th colspan="2">Shipping</th> </tr> <tr> <td>COM Ydg</td> <td>⅔</td> <td>Ctn Wt</td> <td>20</td> </tr> <tr> <td>COL Sq Ft</td> <td>8</td> <td>Cu Ft</td> <td>7</td> </tr> </tbody> </table>	Dimensions	D	W	H	Overall	16	17	28 ¾	Seat	14	15	16	Upholstery		Shipping		COM Ydg	⅔	Ctn Wt	20	COL Sq Ft	8	Cu Ft	7	All Wood \$469 COM \$545 A \$566 B \$583 COL/C \$618 D \$662 E \$704 F \$747 G \$810 H \$881 I \$986 J \$1,115 L1 \$825 L2 \$892
		Dimensions	D	W	H																						
		Overall	16	17	28 ¾																						
Seat	14	15	16																								
Upholstery		Shipping																									
COM Ydg	⅔	Ctn Wt	20																								
COL Sq Ft	8	Cu Ft	7																								
 16B uph. back																											
 16C uph. seat																											
Armless 16" h 	16D Uph. Seat/Back	<table border="1"> <thead> <tr> <th>Dimensions</th> <th>D</th> <th>W</th> <th>H</th> </tr> </thead> <tbody> <tr> <td>Overall</td> <td>16</td> <td>17</td> <td>28 ¾</td> </tr> <tr> <td>Seat</td> <td>14</td> <td>15</td> <td>16</td> </tr> <tr> <th colspan="2">Upholstery</th> <th colspan="2">Shipping</th> </tr> <tr> <td>COM Ydg</td> <td>⅔</td> <td>Ctn Wt</td> <td>20</td> </tr> <tr> <td>COL Sq Ft</td> <td>16</td> <td>Cu Ft</td> <td>7</td> </tr> </tbody> </table>	Dimensions	D	W	H	Overall	16	17	28 ¾	Seat	14	15	16	Upholstery		Shipping		COM Ydg	⅔	Ctn Wt	20	COL Sq Ft	16	Cu Ft	7	COM \$618 A \$636 B \$655 COL/C \$689 D \$733 E \$775 F \$816 G \$885 H \$950 I \$1,057 J \$1,187 L1 \$894 L2 \$962
Dimensions	D	W	H																								
Overall	16	17	28 ¾																								
Seat	14	15	16																								
Upholstery		Shipping																									
COM Ydg	⅔	Ctn Wt	20																								
COL Sq Ft	16	Cu Ft	7																								

Description	Model	Specifications				List Price Per Grade	
		Dimensions	D	W	H		
Armless 16"h  17A all wood	17A All Wood 17B Uph. Back 17C Uph. Seat • optional laser engraved back, specify location and size; see page VIII of Seating Price List online for specifications. (A and C models only)	Overall	16	17	28¾	All Wood	\$479
		Seat	14	15	16	COM	\$564
		Upholstery		Shipping			A
 17B uph. back		COM Ydg	¾	Ctn Wt	20	B	\$601
		COL Sq Ft	8	Cu Ft	7	COL/C	\$634
						D	\$675
 17C uph. seat						E	\$718
						F	\$763
						G	\$828
Armless 16"h 	17D Uph. Seat/Back	Overall	16	17	28¾	H	\$894
		Seat	14	15	16	I	\$1,004
		Upholstery		Shipping			J
		COM Ydg	¾	Ctn Wt	20	L1	\$840
		COL Sq Ft	16	Cu Ft	7	L2	\$908
						COM	\$635
					A	\$653	
					B	\$674	
					COL/C	\$706	
					D	\$748	
					E	\$791	
					F	\$837	
					G	\$900	
					H	\$970	
					I	\$1,074	
					J	\$1,202	
					L1	\$913	
					L2	\$980	

To Order, Specify:

- 1 Model Number
 - 2 Wood Species - Red Oak (RO) or Maple (M)
 - 3 Wood Finish/Color [See Wood Finish/Color Options](#)
 - 4 Fabric Selection - vendor, pattern and color
 Visit www.jsifurniture.com/finishes-and-materials/textiles for our textiles program.
 See selection of standard and graded in manufacturers and patterns.
 - 5 Optional Linking Brackets - add \$41 list per chair
 - 6 Optional Laser Engraved Back - specify location and size; see page VIII of Seating Price List online for details.
(A and C MODELS ONLY)
 - 7 Optional Rubber Cushion Nylon Glides - no upcharge
- LEG MODELS ONLY**

Specifications

- Wood species - Red Oak or Maple.
- Two stretcher shelf for added stability.
- Seat is upholstered with 1 ½" polyurethane foam and synthetic sheet webbing for added comfort.
- Back is upholstered front and back with 1" polyurethane foam.
- Mortise and tenon construction with corner blocks, glue and screws.
- Coordinating Children's collection. See page [CA8](#).
- Standard with rubber cushion metal glides (leg models only).

Collective Motion Seating Order Check List:



Specify:

- 1. Model Number
- 2. Wood Species - Maple (M)
- 3. Wood Finish
- 4. Fabric Selection - vendor, pattern and color

Example:

CM4552 | **M** | **HRV** | **MOMENTUM** | **VOX** | **MYSTIC**
 (model #) | (wood species) | (finish) | (fabric vendor) | (pattern name) | (pattern color)

1. Model Number

2. Wood Species - Maple (M)

3. Wood Seating Finish Options:

ALM	Ale Medium	HRV	Harvest
CAL	Ale Light Coordinate	CKC	Khaki Coordinate
BBM	Bourbon Medium	MINC	Mineral Coordinate
CBZ	Brazilwood Coordinate	MCH	Mocha
BARC	Barrel Coordinate	CPI	Pinnacle Walnut Coordinate
CBO	Bourbon Light Coordinate	PRL	Praline
CBG	Brighton Light Coordinate	RAVC	Raven Coordinate
BRM	Brighton Medium	SABC	Sable Coordinate
BUT	Butterscotch	SIE	Sienna
CNDC	Cinder Coordinate	CST	Studio Teak Coordinate
CLA	Classic	TRF	Truffle
CLL	Collectors	UMB	Umber
EGRC	Egret Coordinate	VALC	Valley Coordinate
ESP	Espresso	VEN	Venetian
FAWC	Fawn Coordinate	CWE	Weathered Ash Coordinate
FLX	Flax		
CGR	Graphite Coordinate		

4. Fabric Selection - Please supply the following:

Fabric vendor/Pattern name/Pattern color

For a complete list of JSI Standard and Graded-In Textiles click here

When specifying contrasting upholstery, indicate clearly which upholstery is to be applied to the seat, back, surround, seat/back and bolster. Use higher grade pricing.

- Indicate direction of fabric - Railroaded or Up the Roll
- Please provide illustration, if available

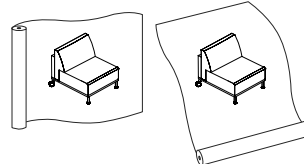
All COM orders must include the following:

- Vendor's name, pattern name and color
- Sample of the fabric attached to order
- Model numbers of items for fabric application
- Special application instructions (e.g., all stripes will be applied front to back unless specified otherwise)
- Customer and purchase order number

Ship prepaid COM material to:

JSI
 Attn: COM Department
 201 East Martin Street
 Receiving B, Dock 71
 Orleans, IN 47452

Application of fabric:
 Railroaded Up the Roll



All COM orders will ship at standard lead time from receipt of COM except for orders requiring special custom matched finishes.

Collective Motion Tables Order Check List:



Specify:

- 1. Model Number
- 2. Top Style
- 3. Wood Species - Cherry (CH1), Maple (MA1) or Walnut (WA1)
- 4. Wood Finish
- 5. Fabric Selection - vendor, pattern and color

Example:

ORTL4536-18 | **A1** | **MA1** | **ALM**
 (model #) | (top style) | (wood species) | (finish)

1. Model Number

Work surfaces may be specified to have a coordinating wood grain HPL laminate top, at no additional upcharge for these finishes:

2. Top Style



Wood with Straight Edge (A1)



Wood with Reversed Bevel Edge (A9)



White Laminate Top with Bright White Reversed Bevel Edge (A10)



Back Painted Glass Top with "Write-On-It" Glossy Glass Top feature with Bright White Reversed Bevel Edge (G2)



Frosted Back Painted Glass Top with Bright White Reversed Bevel Edge (G3)

3. Wood Species - Cherry (CH1), Maple (MA1) or Walnut (WA1)

4. Wood Finish Options:

CH1 Cherry	<i>Flat Cut Veneer</i>		
BBM Bourbon Medium		CLL Collectors	
BRM Brighton Medium		HRV Harvest	
CLA Classic		PRL Praline	

MA1 Maple	<i>Flat Cut Veneer</i>		
ALM Ale Medium		FLX Flax	
BUT Butterscotch		VEN Venetian	

WA1 Walnut	<i>Flat Cut Veneer</i>		
ESP Espresso		TRF Truffle	
MCH Mocha		UMB Umber	
SIE Sienna			

CH1 Cherry	<i>Flat Cut Veneer</i>		
CLL Collectors			
HRV Harvest			
PRL Praline			

WA1 Walnut	<i>Flat Cut Veneer</i>		
MCH Mocha		TRF Truffle	
SIE Sienna		UMB Umber	

5. Fabric Selection - Please supply the following:
 Fabric vendor/Pattern name/Pattern color

[For a complete list of JSI Standard and Graded-In Textiles click here](#)

Note: Fabric ran railroaded on cushions.

All COM orders must include the following:

- Vendor's name, pattern name and color
- Sample of the fabric attached to order
- Model numbers of items for fabric application

Special application instructions (e.g., all stripes will be applied front to back unless specified otherwise)
 • Customer and purchase order number

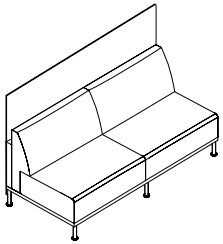
Ship prepaid COM material to:

JSI
 Attn: COM Department
 201 East Martin Street
 Receiving B, Dock 71
 Orleans, IN 47452

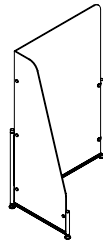
All COM orders will ship at standard lead time from receipt of COM except for orders requiring special custom matched finishes.

Privacy Screens

Satin White frosted acrylic privacy screens are affixed to other products or available as a freestanding unit.



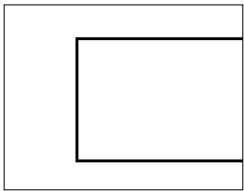
Two Seat with Screen



Privacy Screen

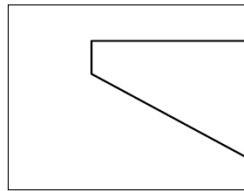
Huddle and Meeting Table Tops Styles

The Collective Motion collaborative tables offer three edge details and four top styles. The back painted glass top with “Write-On-It” glossy glass features a white-board and can be written on with erasable white-board markers.



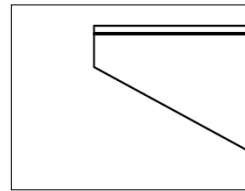
A1

Wood with Straight Edge
standard, no upcharge



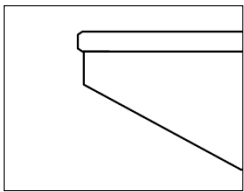
A9

Wood with Reversed
Bevel Edge
no upcharge



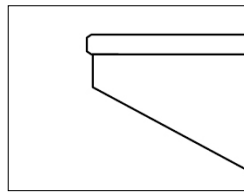
A10

White Laminate Top with Bright
White Reversed Bevel Edge
no upcharge



G2

Back Painted Glass Top with
“Write-On-It” Glossy Glass Top
feature with Bright White Reversed
Bevel Edge
add upcharge
(refer to specific models for pricing)



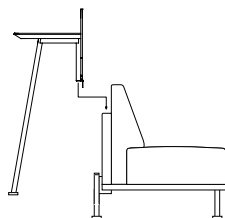
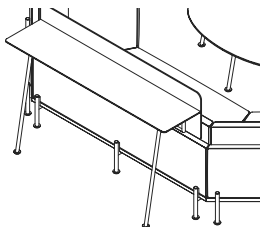
G3

Frosted Back Painted Glass with
Bright White Reversed Bevel Edge
add upcharge
(refer to specific models for pricing)

COLLECTIVE MOTION

Attaching Console Table

The console table attaches effortlessly via a mounting hook which fits snugly between the seat back and the upholstered wrap frame.



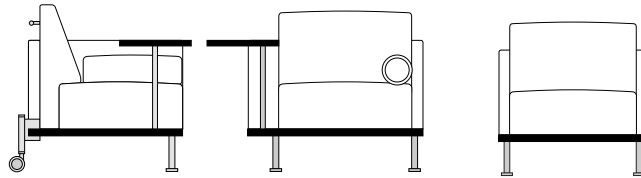
Seating Material Options

This form must accompany order when specifying contrasting or complementary upholstery.
Call for yardage and pricing.

Areas shown in black are maple wood species and requires a finish specification.

Areas (a), (b) and (c) are upholstery and can be specified in contrasting fabric or leather.

Legs, casters and handles are finished in Arctic Silver.



Lounge

Model Number: _____

Finish: _____

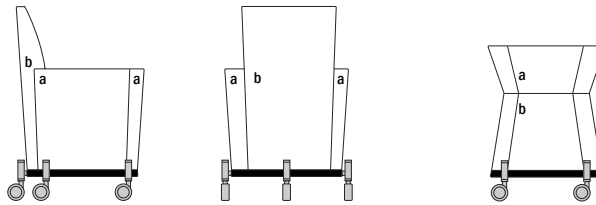
Surround (a): _____

Seat (b): _____

Back (c): _____

Bolster (d): _____

photo copy or scan



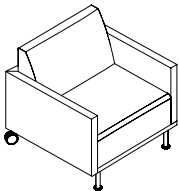
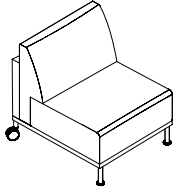
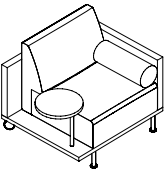
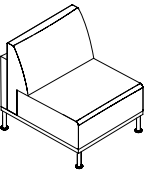
Mobile Stool

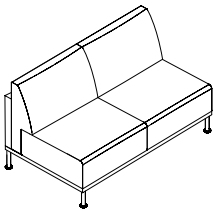
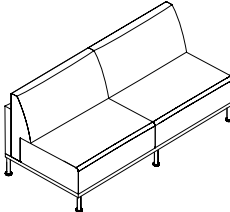
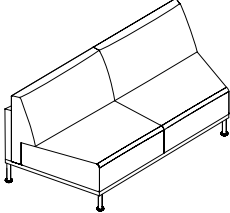
Model Number: _____

Finish: _____

Seat/Top (a): _____

Back/Bottom (b): _____

Description	① Model	Specifications	List Price Per Grade																												
Single Seat 	CM4552 <ul style="list-style-type: none"> · upholstered surround, seat and back · front legs on slides, back legs on casters for easy mobility · upholstered back features handle 	<table border="1"> <thead> <tr> <th>Dimensions</th> <th>D</th> <th>W</th> <th>H</th> </tr> </thead> <tbody> <tr> <td>Overall</td> <td>33</td> <td>31 ½</td> <td>32</td> </tr> <tr> <td>Seat</td> <td>20</td> <td>27</td> <td>17 ½</td> </tr> <tr> <td>Arm</td> <td></td> <td></td> <td>26</td> </tr> <tr> <th colspan="2">Upholstery</th> <th colspan="2">Shipping</th> </tr> <tr> <td>COM Ydg</td> <td>6 ½</td> <td>Ctn Wt</td> <td>97</td> </tr> <tr> <td>COL Sq Ft</td> <td>130</td> <td>Cu Ft</td> <td>23</td> </tr> </tbody> </table>	Dimensions	D	W	H	Overall	33	31 ½	32	Seat	20	27	17 ½	Arm			26	Upholstery		Shipping		COM Ydg	6 ½	Ctn Wt	97	COL Sq Ft	130	Cu Ft	23	COM \$3,688 A \$3,771 B \$3,932 COL/C \$4,210 D \$4,572 E \$4,932 F \$5,313 G \$5,854 H \$6,432 I \$7,331 J \$8,412 L1 \$6,251 L2 \$6,898
		Dimensions	D	W	H																										
Overall	33	31 ½	32																												
Seat	20	27	17 ½																												
Arm			26																												
Upholstery		Shipping																													
COM Ydg	6 ½	Ctn Wt	97																												
COL Sq Ft	130	Cu Ft	23																												
Single Seat 	CM4550 <ul style="list-style-type: none"> · upholstered surround, seat and back · armless · front legs on slides, back legs on casters for easy mobility · upholstered back features handle 	<table border="1"> <thead> <tr> <th>Dimensions</th> <th>D</th> <th>W</th> <th>H</th> </tr> </thead> <tbody> <tr> <td>Overall</td> <td>33</td> <td>27</td> <td>32</td> </tr> <tr> <td>Seat</td> <td>20</td> <td>27</td> <td>17 ½</td> </tr> <tr> <th colspan="2">Upholstery</th> <th colspan="2">Shipping</th> </tr> <tr> <td>COM Ydg</td> <td>4 ½</td> <td>Ctn Wt</td> <td>73</td> </tr> <tr> <td>COL Sq Ft</td> <td>90</td> <td>Cu Ft</td> <td>20</td> </tr> </tbody> </table>	Dimensions	D	W	H	Overall	33	27	32	Seat	20	27	17 ½	Upholstery		Shipping		COM Ydg	4 ½	Ctn Wt	73	COL Sq Ft	90	Cu Ft	20	COM \$3,189 A \$3,246 B \$3,356 COL/C \$3,555 D \$3,801 E \$4,051 F \$4,316 G \$4,691 H \$5,089 I \$5,712 J \$6,461 L1 \$4,962 L2 \$5,413				
		Dimensions	D	W	H																										
Overall	33	27	32																												
Seat	20	27	17 ½																												
Upholstery		Shipping																													
COM Ydg	4 ½	Ctn Wt	73																												
COL Sq Ft	90	Cu Ft	20																												
Single Seat  right shown	CM4552R CM4552L <ul style="list-style-type: none"> · upholstered surround, seat and back · front legs on slides, back legs on casters for easy mobility · upholstered back features handle · asymmetrical pivoting wood tablet · bolster attaches with snap hooks · power/communication module available, specify and add \$382 list each · bolster COM ydg: 1 · bolster COL sq ft: 18 	<table border="1"> <thead> <tr> <th>Dimensions</th> <th>D</th> <th>W</th> <th>H</th> </tr> </thead> <tbody> <tr> <td>Overall</td> <td>33</td> <td>35 ¼</td> <td>32</td> </tr> <tr> <td>Seat</td> <td>20</td> <td>27</td> <td>17 ½</td> </tr> <tr> <td>Arm</td> <td></td> <td></td> <td>26</td> </tr> <tr> <th colspan="2">Upholstery</th> <th colspan="2">Shipping</th> </tr> <tr> <td>COM Ydg</td> <td>5 ½</td> <td>Ctn Wt</td> <td>103</td> </tr> <tr> <td>COL Sq Ft</td> <td>110</td> <td>Cu Ft</td> <td>26</td> </tr> </tbody> </table>	Dimensions	D	W	H	Overall	33	35 ¼	32	Seat	20	27	17 ½	Arm			26	Upholstery		Shipping		COM Ydg	5 ½	Ctn Wt	103	COL Sq Ft	110	Cu Ft	26	COM \$4,067 A \$4,135 B \$4,273 COL/C \$4,511 D \$4,815 E \$5,119 F \$5,443 G \$5,898 H \$6,388 I \$7,150 J \$8,064 L1 \$6,236 L2 \$6,785
		Dimensions	D	W	H																										
Overall	33	35 ¼	32																												
Seat	20	27	17 ½																												
Arm			26																												
Upholstery		Shipping																													
COM Ydg	5 ½	Ctn Wt	103																												
COL Sq Ft	110	Cu Ft	26																												
Single Seat 	CM4555 <ul style="list-style-type: none"> · upholstered surround, seat and back · armless · legs feature slider glides for easy mobility · linking brackets available, specify and add \$101 list · corner table available for linking configurations, see page CC8 	<table border="1"> <thead> <tr> <th>Dimensions</th> <th>D</th> <th>W</th> <th>H</th> </tr> </thead> <tbody> <tr> <td>Overall</td> <td>33</td> <td>27</td> <td>32</td> </tr> <tr> <td>Seat</td> <td>20 ½</td> <td>27</td> <td>17 ½</td> </tr> <tr> <th colspan="2">Upholstery</th> <th colspan="2">Shipping</th> </tr> <tr> <td>COM Ydg</td> <td>4 ½</td> <td>Ctn Wt</td> <td>79</td> </tr> <tr> <td>COL Sq Ft</td> <td>90</td> <td>Cu Ft</td> <td>20</td> </tr> </tbody> </table>	Dimensions	D	W	H	Overall	33	27	32	Seat	20 ½	27	17 ½	Upholstery		Shipping		COM Ydg	4 ½	Ctn Wt	79	COL Sq Ft	90	Cu Ft	20	COM \$3,631 A \$3,687 B \$3,798 COL/C \$3,993 D \$4,241 E \$4,492 F \$4,755 G \$5,130 H \$5,530 I \$6,155 J \$6,901 L1 \$5,406 L2 \$5,854				
		Dimensions	D	W	H																										
Overall	33	27	32																												
Seat	20 ½	27	17 ½																												
Upholstery		Shipping																													
COM Ydg	4 ½	Ctn Wt	79																												
COL Sq Ft	90	Cu Ft	20																												

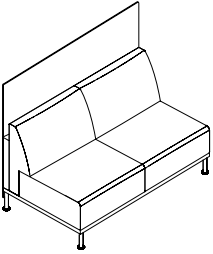
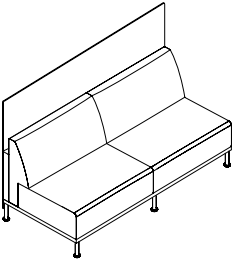
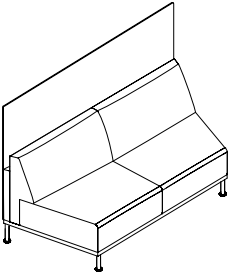
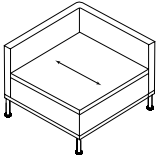
Description	① Model	Specifications	List Price Per Grade																							
Two Seat 	CM4575 <ul style="list-style-type: none"> upholstered surround, seat and back armless legs feature slider glides for easy mobility linking brackets available, specify and add \$101 list corner table available for linking configurations, see page CC8 	<table border="1"> <thead> <tr> <th>Dimensions</th> <th>D</th> <th>W</th> <th>H</th> </tr> </thead> <tbody> <tr> <td>Overall</td> <td>33</td> <td>60</td> <td>32</td> </tr> <tr> <td>Seat</td> <td>20½</td> <td>60</td> <td>17½</td> </tr> </tbody> </table>	Dimensions	D	W	H	Overall	33	60	32	Seat	20½	60	17½	<table border="1"> <thead> <tr> <th>Upholstery</th> <th>Shipping</th> </tr> </thead> <tbody> <tr> <td>COM Ydg</td> <td>8¾ Ctn Wt 145</td> </tr> <tr> <td>COL Sq Ft</td> <td>175 Cu Ft 43</td> </tr> </tbody> </table>	Upholstery	Shipping	COM Ydg	8¾ Ctn Wt 145	COL Sq Ft	175 Cu Ft 43					
		Dimensions	D	W	H																					
Overall	33	60	32																							
Seat	20½	60	17½																							
Upholstery	Shipping																									
COM Ydg	8¾ Ctn Wt 145																									
COL Sq Ft	175 Cu Ft 43																									
<table border="1"> <tbody> <tr><td>COM</td><td>\$4,092</td></tr> <tr><td>A</td><td>\$4,200</td></tr> <tr><td>B</td><td>\$4,418</td></tr> <tr><td>COL/C</td><td>\$4,792</td></tr> <tr><td>D</td><td>\$5,278</td></tr> <tr><td>E</td><td>\$5,765</td></tr> <tr><td>F</td><td>\$6,277</td></tr> <tr><td>G</td><td>\$7,003</td></tr> <tr><td>H</td><td>\$7,781</td></tr> <tr><td>I</td><td>\$8,995</td></tr> <tr><td>J</td><td>\$10,450</td></tr> <tr><td>L1</td><td>\$7,539</td></tr> <tr><td>L2</td><td>\$8,411</td></tr> </tbody> </table>	COM	\$4,092	A	\$4,200	B	\$4,418	COL/C	\$4,792	D	\$5,278	E	\$5,765	F	\$6,277	G	\$7,003	H	\$7,781	I	\$8,995	J	\$10,450	L1	\$7,539	L2	\$8,411
COM	\$4,092																									
A	\$4,200																									
B	\$4,418																									
COL/C	\$4,792																									
D	\$5,278																									
E	\$5,765																									
F	\$6,277																									
G	\$7,003																									
H	\$7,781																									
I	\$8,995																									
J	\$10,450																									
L1	\$7,539																									
L2	\$8,411																									
Three Seat 	CM4585 <ul style="list-style-type: none"> upholstered surround, seat and back armless legs feature slider glides for easy mobility linking brackets available, specify and add \$101 list corner table available for linking configurations, see page CC8 	<table border="1"> <thead> <tr> <th>Dimensions</th> <th>D</th> <th>W</th> <th>H</th> </tr> </thead> <tbody> <tr> <td>Overall</td> <td>33</td> <td>78</td> <td>32</td> </tr> <tr> <td>Seat</td> <td>20½</td> <td>78</td> <td>17½</td> </tr> </tbody> </table>	Dimensions	D	W	H	Overall	33	78	32	Seat	20½	78	17½	<table border="1"> <thead> <tr> <th>Upholstery</th> <th>Shipping</th> </tr> </thead> <tbody> <tr> <td>COM Ydg</td> <td>9 Ctn Wt 198</td> </tr> <tr> <td>COL Sq Ft</td> <td>180 Cu Ft 55</td> </tr> </tbody> </table>	Upholstery	Shipping	COM Ydg	9 Ctn Wt 198	COL Sq Ft	180 Cu Ft 55					
		Dimensions	D	W	H																					
Overall	33	78	32																							
Seat	20½	78	17½																							
Upholstery	Shipping																									
COM Ydg	9 Ctn Wt 198																									
COL Sq Ft	180 Cu Ft 55																									
<table border="1"> <tbody> <tr><td>COM</td><td>\$5,447</td></tr> <tr><td>A</td><td>\$5,559</td></tr> <tr><td>B</td><td>\$5,780</td></tr> <tr><td>COL/C</td><td>\$6,168</td></tr> <tr><td>D</td><td>\$6,667</td></tr> <tr><td>E</td><td>\$7,166</td></tr> <tr><td>F</td><td>\$7,693</td></tr> <tr><td>G</td><td>\$8,442</td></tr> <tr><td>H</td><td>\$9,239</td></tr> <tr><td>I</td><td>\$10,488</td></tr> <tr><td>J</td><td>\$11,987</td></tr> <tr><td>L1</td><td>\$8,993</td></tr> <tr><td>L2</td><td>\$9,891</td></tr> </tbody> </table>	COM	\$5,447	A	\$5,559	B	\$5,780	COL/C	\$6,168	D	\$6,667	E	\$7,166	F	\$7,693	G	\$8,442	H	\$9,239	I	\$10,488	J	\$11,987	L1	\$8,993	L2	\$9,891
COM	\$5,447																									
A	\$5,559																									
B	\$5,780																									
COL/C	\$6,168																									
D	\$6,667																									
E	\$7,166																									
F	\$7,693																									
G	\$8,442																									
H	\$9,239																									
I	\$10,488																									
J	\$11,987																									
L1	\$8,993																									
L2	\$9,891																									
Two Seat Huddle 	CM4572 <ul style="list-style-type: none"> huddle unit cannot connect to modular units with a flat end, but can connect to other huddle units upholstered surround, seat and back armless legs feature slider glides for easy mobility seat front width: 46 5/8" linking brackets included 	<table border="1"> <thead> <tr> <th>Dimensions</th> <th>D</th> <th>W</th> <th>H</th> </tr> </thead> <tbody> <tr> <td>Overall</td> <td>33</td> <td>72</td> <td>32</td> </tr> <tr> <td>Seat</td> <td>20½</td> <td>46½</td> <td>17½</td> </tr> </tbody> </table>	Dimensions	D	W	H	Overall	33	72	32	Seat	20½	46½	17½	<table border="1"> <thead> <tr> <th>Upholstery</th> <th>Shipping</th> </tr> </thead> <tbody> <tr> <td>COM Ydg</td> <td>8¾ Ctn Wt 178</td> </tr> <tr> <td>COL Sq Ft</td> <td>175 Cu Ft 50</td> </tr> </tbody> </table>	Upholstery	Shipping	COM Ydg	8¾ Ctn Wt 178	COL Sq Ft	175 Cu Ft 50					
		Dimensions	D	W	H																					
Overall	33	72	32																							
Seat	20½	46½	17½																							
Upholstery	Shipping																									
COM Ydg	8¾ Ctn Wt 178																									
COL Sq Ft	175 Cu Ft 50																									
<table border="1"> <tbody> <tr><td>COM</td><td>\$5,033</td></tr> <tr><td>A</td><td>\$5,141</td></tr> <tr><td>B</td><td>\$5,358</td></tr> <tr><td>COL/C</td><td>\$5,736</td></tr> <tr><td>D</td><td>\$6,220</td></tr> <tr><td>E</td><td>\$6,706</td></tr> <tr><td>F</td><td>\$7,219</td></tr> <tr><td>G</td><td>\$7,945</td></tr> <tr><td>H</td><td>\$8,724</td></tr> <tr><td>I</td><td>\$9,936</td></tr> <tr><td>J</td><td>\$11,391</td></tr> <tr><td>L1</td><td>\$8,480</td></tr> <tr><td>L2</td><td>\$9,353</td></tr> </tbody> </table>	COM	\$5,033	A	\$5,141	B	\$5,358	COL/C	\$5,736	D	\$6,220	E	\$6,706	F	\$7,219	G	\$7,945	H	\$8,724	I	\$9,936	J	\$11,391	L1	\$8,480	L2	\$9,353
COM	\$5,033																									
A	\$5,141																									
B	\$5,358																									
COL/C	\$5,736																									
D	\$6,220																									
E	\$6,706																									
F	\$7,219																									
G	\$7,945																									
H	\$8,724																									
I	\$9,936																									
J	\$11,391																									
L1	\$8,480																									
L2	\$9,353																									

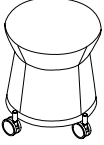
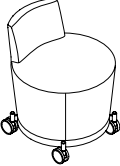
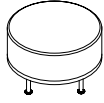
To Order, Specify:

- ① Model Number
 - ② Wood Species - Maple (M)
 - ③ Wood Finish [See Wood Finish Options](#)
 - ④ Fabric Selection - vendor, pattern and color
- Visit www.jsifurniture.com/finishes-and-materials/textiles for our textiles program.
See selection of standard and graded in manufacturers and patterns.

Specifications

- Base wood species - Maple.
- Frame interior is upholstery grade plywood with glued solid hardwood cross members reinforced with wood screws.
- Seat has synthetic sheet webbing with cross strap and high resiliency seat polyurethane multi-density foam.
- Back has polypropylene webbing and multi-density polyurethane foam.
- Arctic Silver tubular steel legs.

Description	① Model	Specifications	List Price Per Grade																																					
Two Seat with Fixed Screen 	CM4575-PS <ul style="list-style-type: none"> · upholstered surround, seat and back · armless · legs feature slider glides for easy mobility 	<table border="1"> <thead> <tr> <th>Dimensions</th> <th>D</th> <th>W</th> <th>H</th> </tr> </thead> <tbody> <tr> <td>Overall</td> <td>33</td> <td>60</td> <td>55</td> </tr> <tr> <td>Seat</td> <td>20 ½</td> <td>60</td> <td>17 ½</td> </tr> </tbody> </table>	Dimensions	D	W	H	Overall	33	60	55	Seat	20 ½	60	17 ½	<table border="1"> <thead> <tr> <th colspan="2">Shipping</th> </tr> </thead> <tbody> <tr> <td>Ctn Wt</td> <td>281</td> </tr> <tr> <td>Cu Ft</td> <td>72</td> </tr> </tbody> </table>	Shipping		Ctn Wt	281	Cu Ft	72																			
		Dimensions	D	W	H																																			
Overall	33	60	55																																					
Seat	20 ½	60	17 ½																																					
Shipping																																								
Ctn Wt	281																																							
Cu Ft	72																																							
<table border="1"> <thead> <tr> <th>Upholstery</th> <th colspan="2">Shipping</th> </tr> </thead> <tbody> <tr> <td>COM Ydg</td> <td>8 ¾</td> <td>Ctn Wt</td> <td>281</td> </tr> <tr> <td>COL Sq Ft</td> <td>175</td> <td>Cu Ft</td> <td>72</td> </tr> </tbody> </table>			Upholstery	Shipping		COM Ydg	8 ¾	Ctn Wt	281	COL Sq Ft	175	Cu Ft	72	<table border="1"> <tbody> <tr><td>COM</td><td>\$5,759</td></tr> <tr><td>A</td><td>\$5,865</td></tr> <tr><td>B</td><td>\$6,082</td></tr> <tr><td>COL/C</td><td>\$6,460</td></tr> <tr><td>D</td><td>\$6,943</td></tr> <tr><td>E</td><td>\$7,431</td></tr> <tr><td>F</td><td>\$7,942</td></tr> <tr><td>G</td><td>\$8,670</td></tr> <tr><td>H</td><td>\$9,446</td></tr> <tr><td>I</td><td>\$10,660</td></tr> <tr><td>J</td><td>\$12,117</td></tr> <tr><td>L1</td><td>\$9,203</td></tr> <tr><td>L2</td><td>\$10,077</td></tr> </tbody> </table>	COM	\$5,759	A	\$5,865	B	\$6,082	COL/C	\$6,460	D	\$6,943	E	\$7,431	F	\$7,942	G	\$8,670	H	\$9,446	I	\$10,660	J	\$12,117	L1	\$9,203	L2	\$10,077
Upholstery	Shipping																																							
COM Ydg	8 ¾	Ctn Wt	281																																					
COL Sq Ft	175	Cu Ft	72																																					
COM	\$5,759																																							
A	\$5,865																																							
B	\$6,082																																							
COL/C	\$6,460																																							
D	\$6,943																																							
E	\$7,431																																							
F	\$7,942																																							
G	\$8,670																																							
H	\$9,446																																							
I	\$10,660																																							
J	\$12,117																																							
L1	\$9,203																																							
L2	\$10,077																																							
Three Seat with Fixed Screen 	CM4585-PS <ul style="list-style-type: none"> · upholstered surround, seat and back · armless · legs feature slider glides for easy mobility · linking brackets available, specify and add \$101 list 	<table border="1"> <thead> <tr> <th>Dimensions</th> <th>D</th> <th>W</th> <th>H</th> </tr> </thead> <tbody> <tr> <td>Overall</td> <td>33</td> <td>78</td> <td>55</td> </tr> <tr> <td>Seat</td> <td>20 ½</td> <td>78</td> <td>17 ½</td> </tr> </tbody> </table>	Dimensions	D	W	H	Overall	33	78	55	Seat	20 ½	78	17 ½	<table border="1"> <thead> <tr> <th colspan="2">Shipping</th> </tr> </thead> <tbody> <tr> <td>Ctn Wt</td> <td>325</td> </tr> <tr> <td>Cu Ft</td> <td>93</td> </tr> </tbody> </table>	Shipping		Ctn Wt	325	Cu Ft	93																			
		Dimensions	D	W	H																																			
Overall	33	78	55																																					
Seat	20 ½	78	17 ½																																					
Shipping																																								
Ctn Wt	325																																							
Cu Ft	93																																							
<table border="1"> <thead> <tr> <th>Upholstery</th> <th colspan="2">Shipping</th> </tr> </thead> <tbody> <tr> <td>COM Ydg</td> <td>9</td> <td>Ctn Wt</td> <td>325</td> </tr> <tr> <td>COL Sq Ft</td> <td>180</td> <td>Cu Ft</td> <td>93</td> </tr> </tbody> </table>			Upholstery	Shipping		COM Ydg	9	Ctn Wt	325	COL Sq Ft	180	Cu Ft	93	<table border="1"> <tbody> <tr><td>COM</td><td>\$7,112</td></tr> <tr><td>A</td><td>\$7,224</td></tr> <tr><td>B</td><td>\$7,445</td></tr> <tr><td>COL/C</td><td>\$7,833</td></tr> <tr><td>D</td><td>\$8,333</td></tr> <tr><td>E</td><td>\$8,833</td></tr> <tr><td>F</td><td>\$9,357</td></tr> <tr><td>G</td><td>\$10,107</td></tr> <tr><td>H</td><td>\$10,905</td></tr> <tr><td>I</td><td>\$12,154</td></tr> <tr><td>J</td><td>\$13,650</td></tr> <tr><td>L1</td><td>\$10,658</td></tr> <tr><td>L2</td><td>\$11,557</td></tr> </tbody> </table>	COM	\$7,112	A	\$7,224	B	\$7,445	COL/C	\$7,833	D	\$8,333	E	\$8,833	F	\$9,357	G	\$10,107	H	\$10,905	I	\$12,154	J	\$13,650	L1	\$10,658	L2	\$11,557
Upholstery	Shipping																																							
COM Ydg	9	Ctn Wt	325																																					
COL Sq Ft	180	Cu Ft	93																																					
COM	\$7,112																																							
A	\$7,224																																							
B	\$7,445																																							
COL/C	\$7,833																																							
D	\$8,333																																							
E	\$8,833																																							
F	\$9,357																																							
G	\$10,107																																							
H	\$10,905																																							
I	\$12,154																																							
J	\$13,650																																							
L1	\$10,658																																							
L2	\$11,557																																							
Two Seat Huddle with Fixed Screen 	CM4572-PS <ul style="list-style-type: none"> · huddle unit cannot connect to modular units with a flat end, but can connect to other huddle units · upholstered surround, seat and back · armless · legs feature slider glides for easy mobility · seat front width: 46 ½" · linking brackets included 	<table border="1"> <thead> <tr> <th>Dimensions</th> <th>D</th> <th>W</th> <th>H</th> </tr> </thead> <tbody> <tr> <td>Overall</td> <td>33</td> <td>72</td> <td>55</td> </tr> <tr> <td>Seat</td> <td>20 ½</td> <td>46 ½</td> <td>17 ½</td> </tr> </tbody> </table>	Dimensions	D	W	H	Overall	33	72	55	Seat	20 ½	46 ½	17 ½	<table border="1"> <thead> <tr> <th colspan="2">Shipping</th> </tr> </thead> <tbody> <tr> <td>Ctn Wt</td> <td>304</td> </tr> <tr> <td>Cu Ft</td> <td>86</td> </tr> </tbody> </table>	Shipping		Ctn Wt	304	Cu Ft	86																			
		Dimensions	D	W	H																																			
Overall	33	72	55																																					
Seat	20 ½	46 ½	17 ½																																					
Shipping																																								
Ctn Wt	304																																							
Cu Ft	86																																							
<table border="1"> <thead> <tr> <th>Upholstery</th> <th colspan="2">Shipping</th> </tr> </thead> <tbody> <tr> <td>COM Ydg</td> <td>8 ¾</td> <td>Ctn Wt</td> <td>304</td> </tr> <tr> <td>COL Sq Ft</td> <td>175</td> <td>Cu Ft</td> <td>86</td> </tr> </tbody> </table>			Upholstery	Shipping		COM Ydg	8 ¾	Ctn Wt	304	COL Sq Ft	175	Cu Ft	86	<table border="1"> <tbody> <tr><td>COM</td><td>\$6,699</td></tr> <tr><td>A</td><td>\$6,808</td></tr> <tr><td>B</td><td>\$7,025</td></tr> <tr><td>COL/C</td><td>\$7,403</td></tr> <tr><td>D</td><td>\$7,887</td></tr> <tr><td>E</td><td>\$8,372</td></tr> <tr><td>F</td><td>\$8,886</td></tr> <tr><td>G</td><td>\$9,613</td></tr> <tr><td>H</td><td>\$10,390</td></tr> <tr><td>I</td><td>\$11,603</td></tr> <tr><td>J</td><td>\$13,059</td></tr> <tr><td>L1</td><td>\$10,147</td></tr> <tr><td>L2</td><td>\$11,019</td></tr> </tbody> </table>	COM	\$6,699	A	\$6,808	B	\$7,025	COL/C	\$7,403	D	\$7,887	E	\$8,372	F	\$8,886	G	\$9,613	H	\$10,390	I	\$11,603	J	\$13,059	L1	\$10,147	L2	\$11,019
Upholstery	Shipping																																							
COM Ydg	8 ¾	Ctn Wt	304																																					
COL Sq Ft	175	Cu Ft	86																																					
COM	\$6,699																																							
A	\$6,808																																							
B	\$7,025																																							
COL/C	\$7,403																																							
D	\$7,887																																							
E	\$8,372																																							
F	\$8,886																																							
G	\$9,613																																							
H	\$10,390																																							
I	\$11,603																																							
J	\$13,059																																							
L1	\$10,147																																							
L2	\$11,019																																							
Corner Table 	CM4531 <ul style="list-style-type: none"> · upholstered surround · wood top and chassis · use with units 4555, 4575, 4585 · legs feature slider glides for easy mobility · linking brackets included 	<table border="1"> <thead> <tr> <th>Dimensions</th> <th>D</th> <th>W</th> <th>H</th> </tr> </thead> <tbody> <tr> <td>Overall</td> <td>33</td> <td>33</td> <td>26</td> </tr> </tbody> </table>	Dimensions	D	W	H	Overall	33	33	26	<table border="1"> <thead> <tr> <th colspan="2">Shipping</th> </tr> </thead> <tbody> <tr> <td>Ctn Wt</td> <td>122</td> </tr> <tr> <td>Cu Ft</td> <td>20</td> </tr> </tbody> </table>	Shipping		Ctn Wt	122	Cu Ft	20																							
		Dimensions	D	W	H																																			
Overall	33	33	26																																					
Shipping																																								
Ctn Wt	122																																							
Cu Ft	20																																							
<table border="1"> <thead> <tr> <th>Upholstery</th> <th colspan="2">Shipping</th> </tr> </thead> <tbody> <tr> <td>COM Ydg</td> <td>3</td> <td>Ctn Wt</td> <td>122</td> </tr> <tr> <td>COL Sq Ft</td> <td>60</td> <td>Cu Ft</td> <td>20</td> </tr> </tbody> </table>			Upholstery	Shipping		COM Ydg	3	Ctn Wt	122	COL Sq Ft	60	Cu Ft	20	<table border="1"> <tbody> <tr><td>COM</td><td>\$4,065</td></tr> <tr><td>A</td><td>\$4,102</td></tr> <tr><td>B</td><td>\$4,177</td></tr> <tr><td>COL/C</td><td>\$4,307</td></tr> <tr><td>D</td><td>\$4,472</td></tr> <tr><td>E</td><td>\$4,637</td></tr> <tr><td>F</td><td>\$4,815</td></tr> <tr><td>G</td><td>\$5,064</td></tr> <tr><td>H</td><td>\$5,330</td></tr> <tr><td>I</td><td>\$5,746</td></tr> <tr><td>J</td><td>\$6,245</td></tr> <tr><td>L1</td><td>\$5,246</td></tr> <tr><td>L2</td><td>\$5,546</td></tr> </tbody> </table>	COM	\$4,065	A	\$4,102	B	\$4,177	COL/C	\$4,307	D	\$4,472	E	\$4,637	F	\$4,815	G	\$5,064	H	\$5,330	I	\$5,746	J	\$6,245	L1	\$5,246	L2	\$5,546
Upholstery	Shipping																																							
COM Ydg	3	Ctn Wt	122																																					
COL Sq Ft	60	Cu Ft	20																																					
COM	\$4,065																																							
A	\$4,102																																							
B	\$4,177																																							
COL/C	\$4,307																																							
D	\$4,472																																							
E	\$4,637																																							
F	\$4,815																																							
G	\$5,064																																							
H	\$5,330																																							
I	\$5,746																																							
J	\$6,245																																							
L1	\$5,246																																							
L2	\$5,546																																							

Description	① Model	Specifications				List Price Per Grade	
Mini Mobile Stool 	CM4517 · upholstered seat · four casters · non-locking	Dimensions	D	W	H	COM	\$1,430
		Overall	18 3/8	18 3/8	20 1/2	A	\$1,446
		Upholstery	Shipping		B	\$1,478	
		COM Ydg	1 1/4	Ctn Wt	31	COL/C	\$1,531
		COL Sq Ft	25	Cu Ft	5	D	\$1,598
						E	\$1,669
						F	\$1,743
						G	\$1,844
						H	\$1,957
						I	\$2,131
						J	\$2,338
						L1	\$1,923
						L2	\$2,047
Mini Mobile Stool with Backrest 	CM4519 · upholstered seat and backrest · backrest is 8" high · five casters · non-locking	Dimensions	D	W	H	COM	\$2,044
		Overall	22	21	25	A	\$2,068
		Seat	16 1/2	21	17	B	\$2,116
		Arm				COL/C	\$2,202
		Upholstery	Shipping		D	\$2,316	
		COM Ydg	2	Ctn Wt	35	E	\$2,427
		COL Sq Ft	40	Cu Ft	8	F	\$2,544
						G	\$2,709
						H	\$2,886
						I	\$3,165
						J	\$3,496
						L1	\$2,829
						L2	\$3,031
Ottoman 	CM4527 · upholstered seat	Dimensions	D	W	H	COM	\$1,956
		Overall	27	27	17 3/4	A	\$1,978
		Upholstery	Shipping		B	\$2,021	
		COM Ydg	1 3/4	Ctn Wt	54	COL/C	\$2,097
		COL Sq Ft	35	Cu Ft	9	D	\$2,194
						E	\$2,291
						F	\$2,394
						G	\$2,537
						H	\$2,694
						I	\$2,937
						J	\$3,227
						L1	\$2,645
						L2	\$2,819

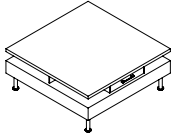
To Order, Specify:

- ① Model Number
- ② Wood Species - Maple (M)
- ③ Wood Finish [See Wood Finish Options](#)
- ④ Fabric Selection - vendor, pattern and color
 Visit www.jsifurniture.com/finishes-and-materials/textiles for our textiles program.
 See selection of standard and graded in manufacturers and patterns.

Specifications

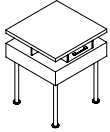
- Base wood species - Maple.
- Frame interior is upholstery grade plywood with glued solid hardwood cross members reinforced with wood screws.
- Seat has synthetic sheet webbing with cross strap and high resiliency seat polyurethane multi-density foam.
- Back has polypropylene webbing and multi-density polyurethane foam.
- Arctic Silver tubular steel legs.

Description	D	W	H	CTN WT	CU FT	Model	List Price
Coffee Table	42	42	17 ¾	229	21	OCFT4542M-18	\$3,738
	30	30	16 ¾	219	10	OCFT4530M-16	\$2,174



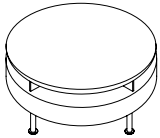
- Maple veneer - specify from seating finishes, see page [CC2](#)
- Anodized Aluminum drawer pulls
- power/communication module available, specify and add \$382 list

End Table	20	20	24	207	7	OST4520M-24	\$2,988
-----------	----	----	----	-----	---	--------------------	----------------



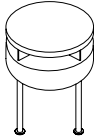
- Maple veneer - specify from seating finishes, see page [CC2](#)
- Anodized Aluminum drawer pulls

Coffee Table	36 ¾	36 ¾	16 ¾	103	15	ORT4536M-17	\$4,762
--------------	------	------	------	-----	----	--------------------	----------------



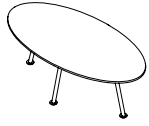
- Maple veneer - specify from seating finishes, see page [CC2](#)
- Skirt not available in paint

End Table	20	20	24 ¾	43	7	ORT4520M-24	\$4,129
-----------	----	----	------	----	---	--------------------	----------------



- Maple veneer - specify from seating finishes, see page [CC2](#)
- Skirt not available in paint

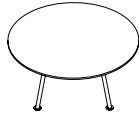
Description	D	W	H	CTN WT	CU FT	① Model	List Price
Oval Occasional Table	32	60	18	71	24	OVTL4560-18	



Top Style:

(A1) Wood with Straight Edge	\$2,467
(A9) Wood with Reversed Bevel Edge	\$2,467
(A10) White Laminate Top with Bright White Reversed Bevel Edge	\$2,467
(G2) "Write-On-It" Glossy Glass Top with Bright White Reversed Bevel Edge	\$4,541
(G3) Frosted Glass Top with Bright White Reversed Bevel Edge	\$4,541

Round Occasional Table	36	36	18	56	16	ORTL4536-18	
------------------------	----	----	----	----	----	-------------	--



Top Style:

(A1) Wood with Straight Edge	\$2,105
(A9) Wood with Reversed Bevel Edge	\$2,105
(A10) White Laminate Top with Bright White Reversed Bevel Edge	\$2,105
(G2) "Write-On-It" Glossy Glass Top with Bright White Reversed Bevel Edge	\$3,332
(G3) Frosted Glass Top with Bright White Reversed Bevel Edge	\$3,332

Round Occasional Table	30	30	18	53	11	ORTL4530-18	
------------------------	----	----	----	----	----	-------------	--



Top Style:

(A1) Wood with Straight Edge	\$1,998
(A9) Wood with Reversed Bevel Edge	\$1,998
(A10) White Laminate Top with Bright White Reversed Bevel Edge	\$1,998
(G2) "Write-On-It" Glossy Glass Top with Bright White Reversed Bevel Edge	\$3,022
(G3) Frosted Glass Top with Bright White Reversed Bevel Edge	\$3,022

COLLECTIVE MOTION

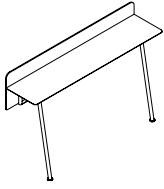
To Order, Specify:

- ① Model Number
- ② Top Style
- ③ Wood Species - Cherry (CH1), Maple (MA1) or Walnut (WA1)
- ④ Wood Finish See [Wood Finish Options](#)

Specifications

- Tops available in Cherry, Maple or Walnut veneer.
- Legs feature slider glides for easy mobility.
- Arctic Silver tubular steel legs.

Description	D	W	H	CTN WT	CU FT	① Model	List Price
Console Table	16 1/2	60	42 3/8	80	28	CC-HCH4572	

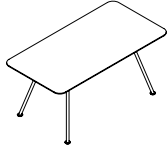


Top Style:

(A1) Wood with Straight Edge	\$3,909
(A9) Wood with Reversed Bevel Edge	\$3,909
(A10) White Laminate Top with Bright White Reversed Bevel Edge	\$3,909
(G2) "Write-On-It" Glossy Glass Top with Bright White Reversed Bevel Edge	\$4,997
(G3) Frosted Glass Top with Bright White Reversed Bevel Edge	\$4,997

- use with lounge units without screens: 4575, 4585, 4572
- table top depth: 15"
- table height: 36 3/8"
- screen height: 16"

27" H Rectangular Huddle Table	30	60	27	86	33	CC-HDTREC4560-27	
--------------------------------	----	----	----	----	----	------------------	--



Top Style:

(A1) Wood with Straight Edge	\$2,981
(A9) Wood with Reversed Bevel Edge	\$2,981
(A10) White Laminate Top with Bright White Reversed Bevel Edge	\$2,981
(G2) "Write-On-It" Glossy Glass Top with Bright White Reversed Bevel Edge	\$5,292
(G3) Frosted Glass Top with Bright White Reversed Bevel Edge	\$5,292

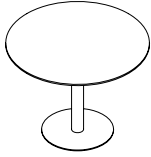
Oval Huddle Table	32	60	27	78	35	CC-HDTO4560-27	
-------------------	----	----	----	----	----	----------------	--



Top Style:

(A1) Wood with Straight Edge	\$2,950
(A9) Wood with Reversed Bevel Edge	\$2,950
(A10) White Laminate Top with Bright White Reversed Bevel Edge	\$2,950
(G2) "Write-On-It" Glossy Glass Top with Bright White Reversed Bevel Edge	\$5,025
(G3) Frosted Glass Top with Bright White Reversed Bevel Edge	\$5,025

Description	D	W	H	CTN WT	CU FT	① Model	List Price
Round Huddle Table	36	36	27	79	24	CC-HDTR4536-27	

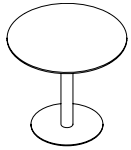


Top Style:

(A1) Wood with Straight Edge	\$2,217
(A9) Wood with Reversed Bevel Edge	\$2,217
(A10) White Laminate Top with Bright White Reversed Bevel Edge	\$2,217
(G2) "Write-On-It" Glossy Glass Top with Bright White Reversed Bevel Edge	\$3,444
(G3) Frosted Glass Top with Bright White Reversed Bevel Edge	\$3,444

- slider glides for easy mobility
- Arctic Silver base finish

Round Huddle Table	30	30	27	77	17	CC-HDTR4530-27	
--------------------	----	----	----	----	----	----------------	--

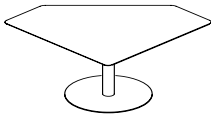


Top Style:

(A1) Wood with Straight Edge	\$2,102
(A9) Wood with Reversed Bevel Edge	\$2,102
(A10) White Laminate Top with Bright White Reversed Bevel Edge	\$2,102
(G2) "Write-On-It" Glossy Glass Top with Bright White Reversed Bevel Edge	\$3,122
(G3) Frosted Glass Top with Bright White Reversed Bevel Edge	\$3,122

- slider glides for easy mobility
- Arctic Silver base finish

Quad Huddle Table	40	40	27	110	29	CC-HPT4540-27	
-------------------	----	----	----	-----	----	---------------	--



Top Style:

(A1) Wood with Straight Edge	\$2,411
(A9) Wood with Reversed Bevel Edge	\$2,411
(A10) White Laminate Top with Bright White Reversed Bevel Edge	\$2,411

- slider glides for easy mobility
- Arctic Silver base finish

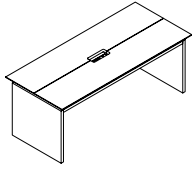
To Order, Specify:

- ① Model Number
- ② Top Style
- ③ Wood Species - Cherry (CH1), Maple (MA1) or Walnut (WA1)
- ④ Wood Finish See [Wood Finish Options](#)

Specifications

- Tops available in Cherry, Maple or Walnut veneer.
- Legs feature slider glides for easy mobility.
- Arctic Silver tubular steel legs.

Description	D	W	H	CTN WT	CU FT	① Model	List Price
Meeting Table with Expandable Worksurface	30	69	27	302	38	CC-SMT4569	

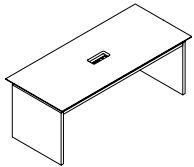


Top Style:

(A1) Wood with Straight Edge	\$13,321
(A9) Wood with Reversed Bevel Edge	\$13,321
(A10) White Laminate Top with Bright White Reversed Bevel Edge	\$13,321

- veneer bases
- adjustable glides
- White interior laminate
- power port with (2) 120 volt outlets and (2) USB ports
- not available with glass top

Meeting Table	30	69	27	231	38	CC-FMT4569	
---------------	----	----	----	-----	----	------------	--

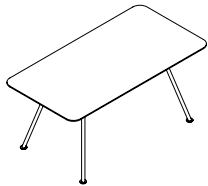


Top Style:

(A1) Wood with Straight Edge	\$6,760
(A9) Wood with Reversed Bevel Edge	\$6,760
(A10) White Laminate Top with Bright White Reversed Bevel Edge	\$6,760

- veneer bases
- adjustable glides
- power port with (2) 120 volt outlets and (2) USB ports
- not available with glass top

72" W Meeting Table	36	72	29	69	50	CC-HDTREC4572-29	
---------------------	----	----	----	----	----	------------------	--

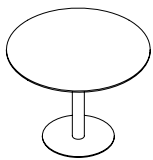


Top Style:

(A1) Wood with Straight Edge	\$3,132
(A9) Wood with Reversed Bevel Edge	\$3,132
(A10) White Laminate Top with Bright White Reversed Bevel Edge	\$3,132
(G2) "Write-On-It" Glossy Glass Top with Bright White Reversed Bevel Edge	\$5,737
(G3) Frosted Glass Top with Bright White Reversed Bevel Edge	\$5,737

- tubular steel legs

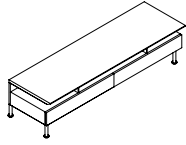
Round Meeting Table	36	36	29	69	25	CC-HDTR4536-29	
---------------------	----	----	----	----	----	----------------	--



Top Style:

(A1) Wood with Straight Edge	\$2,440
(A9) Wood with Reversed Bevel Edge	\$2,440
(A10) White Laminate Top with Bright White Reversed Bevel Edge	\$2,440
(G2) "Write-On-It" Glossy Glass Top with Bright White Reversed Bevel Edge	\$3,873
(G3) Frosted Glass Top with Bright White Reversed Bevel Edge	\$3,873

Description	D	W	H	CTN WT	CU FT	① Model	List Price
Media Console	23 ¼	72	20 ¼	223	23	CC-MCS4572	

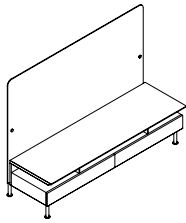


Top Style:

(A1) Wood with Straight Edge	\$3,806
(A9) Wood with Reversed Bevel Edge	\$3,806
(A10) White Laminate Top with Bright White Reversed Bevel Edge	\$3,806
(G2) "Write-On-It" Glossy Glass Top with Bright White Reversed Bevel Edge	\$5,901
(G3) Frosted Glass Top with Bright White Reversed Bevel Edge	\$5,901

- tubular steel legs
- drawer dimensions (2): 32 ½" W x 15" D

Media Console with Screen	24 ⅝	72	54	249	62	CC-MCS4572-PS	
---------------------------	------	----	----	-----	----	---------------	--



Top Style:

(A1) Wood with Straight Edge	\$5,469
(A9) Wood with Reversed Bevel Edge	\$5,469
(A10) White Laminate Top with Bright White Reversed Bevel Edge	\$5,469
(G2) "Write-On-It" Glossy Glass Top with Bright White Reversed Bevel Edge	\$7,658
(G3) Frosted Glass Top with Bright White Reversed Bevel Edge	\$7,658

- tubular steel legs
- drawer dimensions (2): 32 ½" W x 15" D

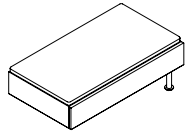
To Order, Specify:

- ① Model Number
- ② Top Style
- ③ Wood Species - Cherry (CH1), Maple (MA1) or Walnut (WA1)
- ④ Wood Finish [See Wood Finish Options](#)
- ⑤ Cabinet/Drawer Front Color
 - A. Veneer
 - B. Paint

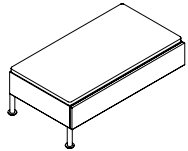
Specifications

- Tops available in Cherry, Maple or Walnut veneer.
- Slider glides for easy mobility.
- Arctic Silver base finish.

Description	D	W	H	CTN WT	CU FT	Model	List Price No Cushion	List Price With Cushion
Media Ender	22 3/8	36	15	74	9	CC-MCS4536R	\$1,977	COM \$2,015
	22 3/8	36	15	74	9	CC-MCS4536L	\$1,977	A \$2,034 B \$2,071 COL/C \$2,136 D \$2,219 E \$2,301 F \$2,390 G \$2,515 H \$2,649 I \$2,856 J \$3,105 L1 \$2,609 L2 \$2,757



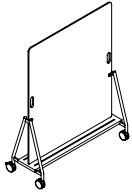
right shown with optional cushion



left shown with optional cushion

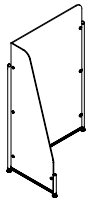
- available in Cherry, Maple, Walnut or Paint
- Arctic Silver tubular legs
- optional cushion has polyurethane foam
- use with media console
- drawer
- legs feature slider glides for easy mobility
- optional cushion
- com ydg: 1 1/2
- col sq ft: 30

Description	D	W	H	CTN WT	CU FT	① Model	List Price
Mobile Markerboard	20 ¾	50 ½	66	118	45	CC-MWB4566	\$4,820



- dry erase laminate
- marker rail available in Cherry, Maple and Walnut veneer
- Arctic Silver powder coat bases
- two locking and two non-locking casters
- board is not magnetic

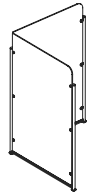
Privacy Screen	25 7/8	41 7/8	63 ¼	100	44	CC-SPS4563R	\$5,976
	25 7/8	41 7/8	63 ¼	100	44	CC-SPS4563L	\$5,976



left shown

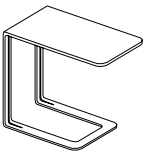
- Satin White acrylic
- legs feature slider glides for easy mobility
- Arctic Silver tubular steel legs
- ships KD
- NOTE: It is recommended other furniture be used around the screen to prevent tipping. Screens are not designed to support the weight of items hanging or leaning against them

Privacy Screen	41 7/8	41 7/8	63 ¼	100	44	CL4242-64PP-ACR	\$3,691
-----------------------	--------	--------	------	-----	----	------------------------	----------------



- Satin White acrylic
- legs feature slider glides for easy mobility
- Arctic Silver tubular steel legs
- ships KD
- NOTE: It is recommended other furniture be used around the screen to prevent tipping. Screens are not designed to support the weight of items hanging or leaning against them

Pull-Up Tablet Table	22	14	26	20	6	CC-TT4522	\$2,967
-----------------------------	----	----	----	----	---	------------------	----------------



- veneer top face available in Cherry, Maple or Walnut
- slider glides for easy mobility
- inside of aluminum frame is white powder coat

To Order, Specify:

- ① Model Number
- ② Wood Species - Cherry (CH1), Maple (MA1), Walnut (WA1) or Paint (PNT)
- ③ Wood or Paint Finish See [Wood Finish/Color Options](#)
- ④ Fabric Selection - vendor, pattern and color

Visit www.jsifurniture.com/finishes-and-materials/textiles for our textiles program.
See selection of standard and graded in manufacturers and patterns.

Connect Modular Lounge Order Check List:



Specify:

- 1. Model Number
- 2. Wood Species - Cherry (CH1), Maple (MA1), Walnut (WA1) or Double Cut (DC1)
- 3. Wood Finish
- 4. Laminate Color Selection (Stand up Surface)
- 5. Surface Corners (Stand up Surface) - Square (S), no upcharge or Rounded (R) models with straight or curved backs add \$49 list or models with corner backs add \$93 list
- 6. Fabric Selection
 - A. Seat - Vendor, Pattern and Color
 - B. Back - Vendor, Pattern and Color
 - C. Arm(s) - Vendor, Pattern and Color
 - D. Headrest - Vendor, Pattern and Color
- 7. Metal Leg Color - Black Sandtex (BSX), Pewter (PEW), Soft Nickel (SNK) or Stardust Silver (STS)
- 8. Optional Wood Back Rail - available on any unit with two arms, specify and add \$192 list
- 9. Optional Power Center - Flush Mount (EC22) - Black (B) or White (W); add \$583 list each and indicate left or right arm, end table, center console, linking table or unit with stand up surface
- 10. Arm Cap - Wood (M) or Black 3D Laminate (B3L) on W models.
- 11. Optional Drink Holder (DH):
 - one drink holder available per arm; add \$120 list each and indicate left or right arm
 - end tables, console or linking tables available with two drink holders; add \$240 list
- 12. Optional Tablet Arm - indicate left (TBL) or right arm (TBR); flat cut add \$663 list, double cut add \$691
- 13. Optional Rubber Cushion Nylon Glides - no upcharge
- 14. Product Options

Example:

CTL1304UR | **WA1** | **ESP** | **ALB** | **MOMENTUM** | **VOX** | **MYSTIC** | **STS**
 (model #) | (wood species) | (finish) | (stand up surface laminate) | (fabric vendor) | (pattern name) | (pattern color) | (metal leg color)

1. Model Number

2 & 3. Wood Species- Wood Finish

CH1	Cherry	<i>Flat Cut Veneer</i>		
BBM	Bourbon Medium		CLL	Collectors*
BRM	Brighton Medium		HRV	Harvest*
CLA	Classic		PRL	Praline*

MA1	Maple	<i>Flat Cut Veneer</i>		
ALM	Ale Medium		FLX	Flax
BUT	Butterscotch		VEN	Venetian

WA1	Walnut	<i>Flat Cut Veneer</i>		
ESP	Espresso		TRF	Truffle*
MCH	Mocha*		UMB	Umber*
SIE	Sienna*			

B01	Black Oak	<i>Flat Cut Veneer</i>		
RAV	Raven			

DC1	Double Cut Veneer			
BAR	Barrel - Oak Pattern		KHK	Khaki
BUF	Buff - Oak Pattern		MIN	Mineral - Oak Pattern*
CND	Cinder - Oak Pattern		RYE	Rye - Oak Pattern
COF	Coffee		SAB	Sable - Oak Pattern
EGR	Egret - Oak Pattern*		SAD	Saddle - Oak Pattern
FAW	Fawn*		STU	Studio Teak
GRH	Graphite		VAL	Valley*

4. Laminate Color Selection (Stand up Surface):

HPL Wood Grain Pattern Laminates

ALL	Ale Light	MIN	Mineral
BOL	Bourbon Light	OAT	Oatmeal Cookie
BZW	Brazilwood	PIN	Pinnacle Walnut
BGL	Brighton Light	STU	Studio Teak
CLL	Collectors	UMB	Umber
FAW	Fawn	VAL	Valley
FLO	Florence Walnut	VIN	Vintage
GRH	Graphite	WEA	Weathered Ash

HPL Solid Laminates

ALB	Alabaster	DWH	Designer White
BLK	Black	SHD	Shadow
BBL	Bridal Blanco	SLG	Slate Grey

5. Surface Corners (Stand up Surface):

- S** Square (standard)
- R** Rounded, models with straight or curved backs add \$49 list, Models with corner backs add \$93 list

*finishes have coordinating laminate top option

Connect Modular Lounge Order Check List (cont.):

6. Fabric Selection - Please supply the following:
Fabric vendor/Pattern name/Pattern color

For a complete list of JSI Standard and Graded-In Textiles click here

Contrasting Upholstery - Units can be specified with a contrasting upholstery feature. When this feature is desired the unit will be priced based on the higher grade fabric selected for the seat, back, arm(s) and headrest.

When specifying contrasting upholstery, indicate clearly which upholstery to be applied to the seat, back, arms and headrest.



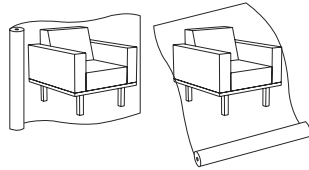
- Indicate direction of fabric - Railroaded or Up the Roll
- Please provide illustration, if available

All COM orders must include the following:

- Vendor's name, pattern name and color
- Sample of the fabric attached to order
- Model numbers of items for fabric application
- Special application instructions (e.g., all stripes will be applied front to back unless specified otherwise)
- Customer and purchase order number

Ship prepaid COM material to:
JSI
Attn: COM Department
201 East Martin Street
Receiving B, Dock 71
Orleans, IN 47452

Application of fabric:
Railroaded Up the Roll



All COM orders will ship at standard lead time from receipt of COM except for orders requiring special custom matched finishes.

6. Metal Leg Color:

Available in Black Sandtex (BSX), Pewter (PEW), Soft Nickel (SNK) or Stardust Silver (STS) powdercoat.

7. Wood Back Rail



For added elegance Connect Low Back units with two arms may be specified with the Wood Back Rail option. The 6" tall wood back rail enhances the back detail as you approach the units from the rear making this a nice feature for "freestanding" applications. This option reduces the back depth by 1½". The back rail will be in the same finish color as the rest of the unit. Specify Wood Back Rail and add \$192 list per unit.

8. Power Center - Flush Mount:

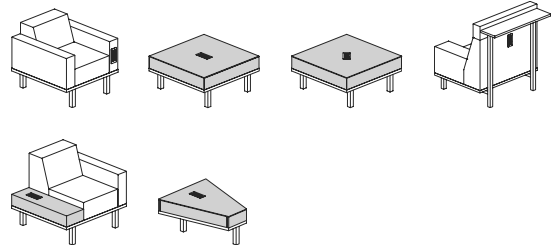


Units with arms, end table, console, linking table or stand up surface can be specified with the Power Center Flush Mount option featuring two waterproof 110 outlets and one dual USB port. Power is connected to the building supply with a 10' long standard three prong cord. Access and storage of excess power cords is provided in the base of the arm or console. Power Center is not available on Corner Seats or Corner Tables.

Power Center (EC22):

- Left or right arm with one Power Center per arm mounted vertically in the front; add \$583 list each, indicate left or right arm (as seated)
- End, console, straight or wedge linking table with one Power Center mounted front to back in top; add \$583 list each
- Single seat unit with a stand up surface and one Power Center located 7 ¼" under the surface and centered in the back; add \$583 list
- Two seat units with a stand up surface and two Power Centers located 7 ¼" under the surface and centered in each back; add \$1,166 list
- Three seat units with a stand up surface and two Power Centers located 7 ¼" under the surface and centered in the back of the left and right backs; add add \$1,749 list

NOTE: Power Center color, Black (B) or White (W) must be specified.



Power Center (EC21) - Under Mount:

This accessory item featuring one 110 volt power receptacle and one dual USB port mounts to the underside of units. See page CT66 for additional information.



Connect Modular Lounge Order Check List (cont.):

11. Drink Holder



Units with an arm, end table, console or linking table can be specified with the drink holder option. The drink holder features a plastic base with rubber coaster and a metal trim cap.

Drink Holder (DH):

- Left or right arm with **one** drink holder per arm; add \$120 list each and indicate left or right arm as seated)
- End table, console or linking table with **two** drink holders; add \$240 list

NOTE: Metal trim cap color will match the Metal Leg Color. Drink holder cannot be ordered on an arm with a tablet arm.

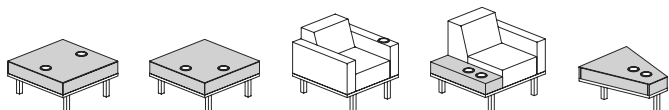
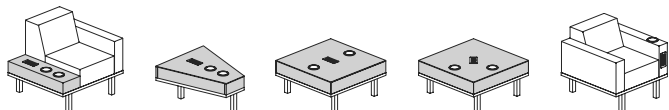


Table Power Center and Drink Holder Standard Locations:



12. Tablet Arm:



- rotating
- 10" x 18" veneer surface
- Specify Tablet Arm option left (TBL) or right (TBR) and add \$663 list for flat cut, \$691 for double cut, for each tablet arm specified

13. Optional Rubber Cushion Nylon Glides - no upcharge

14. Product Options:

Optional Coordinating Wood Grain Laminate Surfaces:

No additional upcharge. Finishes with an asterisk (*) have a coordinating laminate available.

(For wood cap arm, tables or tablet arm)

Special Finish: \$372 list upcharge

Features:

- 20" and 30" seat widths
- four back heights available on units with a 30" seat width
- arm models with a 20" seat width have an arm width of 5"
- arm models with a 30" seat width have an arm width of 10"
- all units have a 1 1/4" wood base platform
- end table, console and linking tables are made of plywood construction with maple veneer surface
- metal legs are 1 3/4" x 1 3/4" x 8 1/4" 16 guage steel tube with metal leveling glides

Linking Brackets:

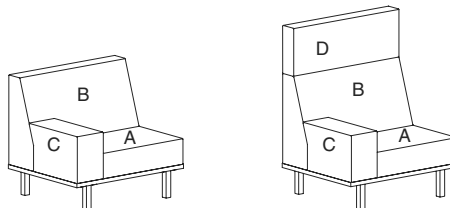


Each unit ships with two sets of link brackets; two latches and two hooks providing quick connection to form limitless configurations.

Contrasting Upholstery:



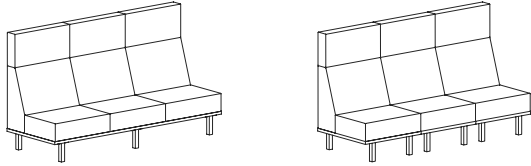
Units can be specified with a contrasting upholstery feature. When this feature is desired the unit will be priced based on the highest grade fabric selected for the seat, back, arm(s) or headrest. Specify the seat (A), back (B), arm (C) and headrest (D) fabric on your order.



Planning Section:

Modularity:

Modularity and versatility allows you to fit Connect into any footprint using large and small scale components or a mix of both. The use of wider and fewer units will diminish the number of legs in a configuration. More units shorter in width will increase the number of legs in a configuration.



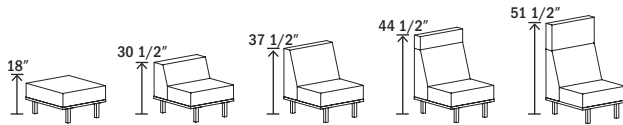
Curved Units:

Curved units in varying radius degrees are available to help aid in creating configurations with different twists and turns.

Back Heights:

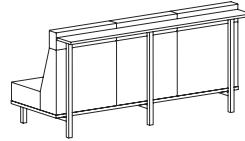
Units with a 20" seat width are available with low back height or bench style.

Units with a 30" seat width are available in bench style or four different back heights; low, mid, high and privacy. 7" and 14" headrest are included on the High and Privacy back respectively.



Complementary Components

Units with a 30" seat width and a high or privacy back are available with a 10"d stand up laminate surface with a coordinating 3mm PVC edge. These surfaces may be used as touch down spaces or to provide tiered type seating.



Laminate Color Selection for Stand Up Surface:

HPL Wood Grain Pattern Laminates

ALL Ale Light	MIN Mineral
BOL Bourbon Light	OAT Oatmeal Cookie
BZW Brazilwood	PIN Pinnacle Walnut
BGL Brighton Light	STU Studio Teak
CLL Collectors	UMB Umber
FAW Fawn	VAL Valley
FLO Florence Walnut	VIN Vintage
GRH Graphite	WEA Weathered Ash

HPL Solid Laminates

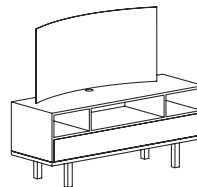
ALB Alabaster	DWH Designer White
BLK Black	SHD Shadow
BBL Bridal Blanco	SLG Slate Grey

Surface Corners for Stand Up Surface:

Specify Square (S) or Rounded (R) corner and add \$49 for straight models and \$93 on corner models.

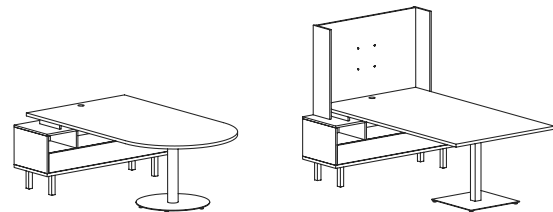
Media Cabinets

1/4"d x 50"w x 26"h straight and curved Media Cabinets with and without acrylic screens can be used for presentation and training sessions. 20" deep straight and curved media benches are available to compliment the configuration.



Media Activity Center

For meetings and presentations with an overall footprint of 60" x 72" or 60" x 84", the Media Activity Center is available with either a bullet or rectangular shaped top. These units may also be ordered with or without a back panel. The back panel feature includes a TV mount.



COM Yardage Requirements for Multiple Fabrics

Model	Description	Seat Only COM Ydg	Back Only COM Ydg	Arm Only COM Ydg	Headrest Only COM Ydg
CTC20S1UC	Corner Seat Low Back, Center	1.00	3.00		
CTC20S1UL	Corner Seat Low Back, Left	1.00	3.00		
CTC20S1UR	Corner Seat Low Back, Right	1.00	3.00		
CTC20S2UC	Corner Seat Mid Back, Center	1.00	3.50		
CTC20S2UL	Corner Seat Mid Back, Left	1.00	3.50		
CTC20S2UR	Corner Seat Mid Back, Right	1.00	3.50		
CTC20S3UC	Corner Seat High Back, Center	1.00	3.50		1.75
CTC20S3UL	Corner Seat High Back, Left	1.00	3.50		1.75
CTC20S3UR	Corner Seat High Back, Right	1.00	3.50		1.75
CTC20S4UC	Corner Seat High Back, Center	1.00	3.50		1.75
CTC20S4UL	Corner Seat High Back, Left	1.00	3.50		1.75
CTC20S4UR	Corner Seat High Back, Right	1.00	3.50		1.75
CTC20S5UC	Corner Seat Privacy Back, Center	1.00	3.50		2.50
CTC20S5UL	Corner Seat Privacy Back, Left	1.00	3.50		2.50
CTC20S5UR	Corner Seat Privacy Back, Right	1.00	3.50		2.50
CTC20S6UC	Corner Seat Privacy Back, Center	1.00	3.50		2.50
CTC20S6UL	Corner Seat Privacy Back, Left	1.00	3.50		2.50
CTC20S6UR	Corner Seat Privacy Back, Right	1.00	3.50		2.50
CTC20T2UC	Corner Table Mid Back, Center	1.25	3.50		
CTC20T2UL	Corner Table Mid Back, Left	1.25	3.50		
CTC20T2UR	Corner Table Mid Back, Right	1.25	3.50		
CTC20T2W	Corner Table Mid Back	0.75	3.50		
CTC20T3UC	Corner Table High Back, Center	1.25	3.50		1.75
CTC20T3UL	Corner Table High Back, Left	1.25	3.50		1.75
CTC20T3UR	Corner Table High Back, Right	1.25	3.50		1.75
CTC20T3W	Corner Table High Back	0.75	3.50		1.75
CTC20T4UC	Corner Table High Back, Center	1.25	3.50		1.75
CTC20T4UL	Corner Table High Back, Left	1.25	3.50		1.75
CTC20T4UR	Corner Table High Back, Right	1.25	3.50		1.75
CTC20T4W	Corner Table High Back	0.75	3.50		1.75
CTC20T5UC	Corner Table Privacy Back, Center	1.25	3.50		2.50
CTC20T5UL	Corner Table Privacy Back, Left	1.25	3.50		2.50
CTC20T5UR	Corner Table Privacy Back, Right	1.25	3.50		2.50
CTC20T5W	Corner Table Privacy Back	0.75	3.50		2.50
CTC20T6UC	Corner Table Privacy Back, Center	1.25	3.50		2.50
CTC20T6UL	Corner Table Privacy Back, Left	1.25	3.50		2.50
CTC20T6UR	Corner Table Privacy Back, Right	1.25	3.50		2.50
CTC20T6W	Corner Table Privacy Back	0.75	3.50		2.50
CTI32121	90° Curved Seat Low Back	1.50	4.00		
CTI32122	90° Curved Seat Mid Back	1.50	4.75		
CTI32123	90° Curved Seat High Back	1.50	4.75		1.75
CTI32124	90° Curved Seat High Back	1.50	4.75		1.75
CTI32125	90° Curved Seat Privacy Back	1.50	4.75		2.75
CTI32126	90° Curved Seat Privacy Back	1.50	4.75		2.75
CTI32301	45° Curved Seat Low Back	1.50	2.50		
CTI32302	45° Curved Seat Mid Back	1.50	2.75		
CTI32303	45° Curved Seat High Back	1.50	2.75		1.50
CTI32304	45° Curved Seat High Back	1.50	2.75		1.50
CTI32305	45° Curved Seat Privacy Back	1.50	2.75		2.00
CTI32306	45° Curved Seat Privacy Back	1.50	2.75		2.00
CTI32451	45° Curved Seat Low Back	1.75	3.33		
CTI32452	45° Curved Seat Mid Back	1.75	3.75		
CTI32453	45° Curved Seat High Back	1.75	3.75		1.75
CTI32454	45° Curved Seat High Back	1.75	3.75		1.75
CTI32455	45° Curved Seat Privacy Back	1.75	3.75		2.75
CTI32456	45° Curved Seat Privacy Back	1.75	3.75		2.75
CTL1201	Single Seat Low Back	2.00	1.50		
CTL1201CL	Single Seat Low Back, Left	2.00	1.50		
CTL1201CR	Single Seat Low Back, Right	2.00	1.50		
CTL1201U2	Single Seat Low Back	2.00	1.50	3.00	
CTL1201UL	Single Seat Low Back, Left	2.00	1.50	1.50	
CTL1201ULCR	Single Seat Low Back, Left	2.00	1.50	1.50	
CTL1201UR	Single Seat Low Back, Right	2.00	1.50	1.50	
CTL1201URCL	Single Seat Low Back, Right	2.00	1.50	1.50	
CTL1201W2	Single Seat Low Back	2.00	1.50	3.00	
CTL1201WL	Single Seat Low Back, Left	2.00	1.50	1.50	
CTL1201WLCR	Single Seat Low Back, Left	2.00	1.50	1.50	

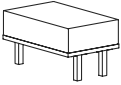
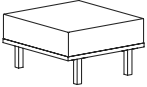
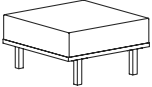
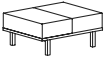
CONNECT

Model	Description	Seat Only COM Ydg	Back Only COM Ydg	Arm Only COM Ydg	Headrest Only COM Ydg
CTL1201WR	Single Seat Low Back, Right	2.00	1.50	1.50	
CTL1201WRCL	Single Seat Low Back, Right	2.00	1.50	1.50	
CTL1301	Single Seat Low Back	2.00	1.50		
CTL1301CL	Single Seat Low Back, Left	2.00	1.50		
CTL1301CR	Single Seat Low Back, Right	2.00	1.50		
CTL1301U2	Single Seat Low Back	2.00	1.50	3.00	
CTL1301UL	Single Seat Low Back, Left	2.00	1.50	1.50	
CTL1301ULCR	Single Seat Low Back, Left	2.00	1.50	1.50	
CTL1301UR	Single Seat Low Back, Right	2.00	1.50	1.50	
CTL1301URCL	Single Seat Low Back, Right	2.00	1.50	1.50	
CTL1301W2	Single Seat Low Back	2.00	1.50	3.00	
CTL1301WL	Single Seat Low Back, Left	2.00	1.50	1.50	
CTL1301WLCR	Single Seat Low Back, Left	2.00	1.50	1.50	
CTL1301WR	Single Seat Low Back, Right	2.00	1.50	1.50	
CTL1301WRCL	Single Seat Low Back, Right	2.00	1.50	1.50	
CTL1302	Single Seat Mid Back	2.00	1.75		
CTL1302UL	Single Seat Mid Back, Left	2.00	1.75	1.50	
CTL1302UR	Single Seat Mid Back, Right	2.00	1.75	1.50	
CTL1302WL	Single Seat Mid Back, Left	2.00	1.75	1.50	
CTL1302WR	Single Seat Mid Back, Right	2.00	1.75	1.50	
CTL1303	Single Seat High Back	2.00	1.75		0.75
CTL1303UL	Single Seat High Back, Left	2.00	1.75	1.50	0.75
CTL1303UR	Single Seat High Back, Right	2.00	1.75	1.50	0.75
CTL1303WL	Single Seat High Back, Left	2.00	1.75	1.50	0.75
CTL1303WR	Single Seat High Back, Right	2.00	1.75	1.50	0.75
CTL1304	Single Seat High Back	2.00	1.75		0.75
CTL1304UL	Single Seat High Back, Left	2.00	1.75	1.50	0.75
CTL1304UR	Single Seat High Back, Right	2.00	1.75	1.50	0.75
CTL1304WL	Single Seat High Back, Left	2.00	1.75	1.50	0.75
CTL1304WR	Single Seat High Back, Right	2.00	1.75	1.50	0.75
CTL1305	Single Seat Privacy Back	2.00	1.75		1.25
CTL1305UL	Single Seat Privacy Back, Left	2.00	1.75	1.50	1.25
CTL1305UR	Single Seat Privacy Back, Right	2.00	1.75	1.50	1.25
CTL1305WL	Single Seat Privacy Back, Left	2.00	1.75	1.50	1.25
CTL1305WR	Single Seat Privacy Back, Right	2.00	1.75	1.50	1.25
CTL1306	Single Seat Privacy Back	2.00	1.75		1.25
CTL1306UL	Single Seat Privacy Back, Left	2.00	1.75	1.50	1.25
CTL1306UR	Single Seat Privacy Back, Right	2.00	1.75	1.50	1.25
CTL1306WL	Single Seat Privacy Back, Left	2.00	1.75	1.50	1.25
CTL1306WR	Single Seat Privacy Back, Right	2.00	1.75	1.50	1.25
CTL2201	Two Seat Low Back	4.00	3.00		
CTL2201U2	Two Seat Low Back	4.00	3.00	3.00	
CTL2201U2CC	Two Seat Low Back	4.00	3.00	3.00	
CTL2201W2	Two Seat Low Back	4.00	3.00	3.00	
CTL2201W2CC	Two Seat Low Back	4.00	3.00	3.00	
CTL2301	Two Seat Low Back	4.00	3.00		
CTL2301U2	Two Seat Low Back	4.00	3.00	3.00	
CTL2301U2CC	Two Seat Low Back	4.00	3.00	3.00	
CTL2301UL	Two Seat Low Back, Left	4.00	3.00	1.50	
CTL2301UR	Two Seat Low Back, Right	4.00	3.00	1.50	
CTL2301W2	Two Seat Low Back	4.00	3.00	3.00	
CTL2301W2CC	Two Seat Low Back	4.00	3.00	3.00	
CTL2301WL	Two Seat Low Back, Left	4.00	3.00	1.50	
CTL2301WR	Two Seat Low Back, Right	4.00	3.00	1.50	
CTL2302	Two Seat Mid Back	4.00	3.50		
CTL2302UL	Two Seat Mid Back, Left	4.00	3.50	1.50	
CTL2302UR	Two Seat Mid Back, Right	4.00	3.50	1.50	
CTL2302WL	Two Seat Mid Back, Left	4.00	3.50	1.50	
CTL2302WR	Two Seat Mid Back, Right	4.00	3.50	1.50	
CTL2303	Two Seat High Back	4.00	3.50		1.50
CTL2303UL	Two Seat High Back, Left	4.00	3.50	1.50	1.50
CTL2303UR	Two Seat High Back, Right	4.00	3.50	1.50	1.50
CTL2303WL	Two Seat High Back, Left	4.00	3.50	1.50	1.50
CTL2303WR	Two Seat High Back, Right	4.00	3.50	1.50	1.50
CTL2304	Two Seat High Back	4.00	3.50		1.50
CTL2304UL	Two Seat High Back, Left	4.00	3.50	1.50	1.50
CTL2304UR	Two Seat High Back, Right	4.00	3.50	1.50	1.50
CTL2304WL	Two Seat High Back, Left	4.00	3.50	1.50	1.50
CTL2304WR	Two Seat High Back, Right	4.00	3.50	1.50	1.50
CTL2305	Two Seat Privacy Back	4.00	3.50		2.50

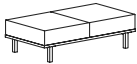
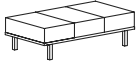
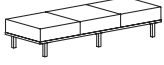
Model	Description	Seat Only COM Ydg	Back Only COM Ydg	Arm Only COM Ydg	Headrest Only COM Ydg
CTL2305UL	Two Seat Privacy Back, Left	4.00	3.50	1.50	2.50
CTL2305UR	Two Seat Privacy Back, Right	4.00	3.50	1.50	2.50
CTL2305WL	Two Seat Privacy Back, Left	4.00	3.50	1.50	2.50
CTL2305WR	Two Seat Privacy Back, Right	4.00	3.50	1.50	2.50
CTL2306	Two Seat Privacy Back	4.00	3.50		2.50
CTL2306UL	Two Seat Privacy Back, Left	4.00	3.50	1.50	2.50
CTL2306UR	Two Seat Privacy Back, Right	4.00	3.50	1.50	2.50
CTL2306WL	Two Seat Privacy Back, Left	4.00	3.50	1.50	2.50
CTL2306WR	Two Seat Privacy Back, Right	4.00	3.50	1.50	2.50
CTL3201	Three Seat Low Back	6.00	4.50		
CTL3201U2	Three Seat Low Back	6.00	4.50	3.00	
CTL3201W2	Three Seat Low Back	6.00	4.50	3.00	
CTL3301	Three Seat Low Back	6.00	4.50		
CTL3302	Three Seat Mid Back	6.00	5.25		
CTL3303	Three Seat High Back	6.00	5.25		2.25
CTL3304	Three Seat High Back	6.00	5.25		2.25
CTL3305	Three Seat Privacy Back	6.00	5.25		3.75
CTL3306	Three Seat Privacy Back	6.00	5.25		3.75
CTL4201	Four Seat Low Back	8.00	6.00		
CTL4201U2	Four Seat Low Back	8.00	6.00	3.00	
CTL4201W2	Four Seat Low Back	8.00	6.00	3.00	
CT032121	90° Curved Seat Low Back	2.25	1.50		
CT032122	90° Curved Seat Mid Back	2.25	2.00		
CT032123	90° Curved Seat High Back	2.25	2.00		0.75
CT032125	90° Curved Seat Privacy Back	2.25	2.00		1.00
CT032301	45° Curved Seat Low Back	1.50	1.50		
CT032302	45° Curved Seat Mid Back	1.50	1.75		
CT032303	45° Curved Seat High Back	1.50	1.75		0.75
CT032304	45° Curved Seat High Back	1.50	1.75		0.75
CT032305	45° Curved Seat Privacy Back	1.50	1.75		1.00
CT032306	45° Curved Seat Privacy Back	1.50	1.75		1.00
CT032451	45° Curved Seat Low Back	2.00	2.00		
CT032452	45° Curved Seat Mid Back	2.00	2.50		
CT032453	45° Curved Seat High Back	2.00	2.50		1.00
CT032454	45° Curved Seat High Back	2.00	2.50		1.00
CT032455	45° Curved Seat Privacy Back	2.00	2.50		1.50
CT032456	45° Curved Seat Privacy Back	2.00	2.50		1.50

Connect Modular Lounge



Description	① Model	Specifications	List Price Per Grade																																								
Single Seat Bench 	CTL1200 · 20" seat width · recommended for modular configuration only · double cut veneer available; specify and add \$128 list	<table border="1"> <thead> <tr> <th>Dimensions</th> <th>D</th> <th>W</th> <th>H</th> </tr> </thead> <tbody> <tr> <td>Overall</td> <td>32</td> <td>20</td> <td>18</td> </tr> <tr> <td>Seat</td> <td>32</td> <td>20</td> <td>18</td> </tr> </tbody> </table>	Dimensions	D	W	H	Overall	32	20	18	Seat	32	20	18	<table border="1"> <thead> <tr> <th>COM</th> <th>Price</th> </tr> </thead> <tbody> <tr><td>COM</td><td>\$1,523</td></tr> <tr><td>A</td><td>\$1,577</td></tr> <tr><td>B</td><td>\$1,642</td></tr> <tr><td>COL/C</td><td>\$1,754</td></tr> <tr><td>D</td><td>\$1,897</td></tr> <tr><td>E</td><td>\$2,041</td></tr> <tr><td>F</td><td>\$2,268</td></tr> <tr><td>G</td><td>\$2,509</td></tr> <tr><td>H</td><td>\$2,766</td></tr> <tr><td>I</td><td>\$3,168</td></tr> <tr><td>J</td><td>\$3,645</td></tr> <tr><td>L1</td><td>\$2,880</td></tr> <tr><td>L2</td><td>\$3,212</td></tr> </tbody> </table>	COM	Price	COM	\$1,523	A	\$1,577	B	\$1,642	COL/C	\$1,754	D	\$1,897	E	\$2,041	F	\$2,268	G	\$2,509	H	\$2,766	I	\$3,168	J	\$3,645	L1	\$2,880	L2	\$3,212
		Dimensions	D	W	H																																						
Overall	32	20	18																																								
Seat	32	20	18																																								
COM	Price																																										
COM	\$1,523																																										
A	\$1,577																																										
B	\$1,642																																										
COL/C	\$1,754																																										
D	\$1,897																																										
E	\$2,041																																										
F	\$2,268																																										
G	\$2,509																																										
H	\$2,766																																										
I	\$3,168																																										
J	\$3,645																																										
L1	\$2,880																																										
L2	\$3,212																																										
		<table border="1"> <thead> <tr> <th>Upholstery</th> <th colspan="3">Shipping</th> </tr> </thead> <tbody> <tr> <td>COM Ydg</td> <td>2 ¼</td> <td>Ctn Wt</td> <td>55</td> </tr> <tr> <td>COL Sq Ft</td> <td>52</td> <td>Cu Ft</td> <td>7</td> </tr> </tbody> </table>	Upholstery	Shipping			COM Ydg	2 ¼	Ctn Wt	55	COL Sq Ft	52	Cu Ft	7																													
Upholstery	Shipping																																										
COM Ydg	2 ¼	Ctn Wt	55																																								
COL Sq Ft	52	Cu Ft	7																																								
Single Seat Bench 	CTL1300 · 30" seat width · double cut veneer available; specify and add \$128 list	<table border="1"> <thead> <tr> <th>Dimensions</th> <th>D</th> <th>W</th> <th>H</th> </tr> </thead> <tbody> <tr> <td>Overall</td> <td>32</td> <td>30</td> <td>18</td> </tr> <tr> <td>Seat</td> <td>32</td> <td>30</td> <td>18</td> </tr> </tbody> </table>	Dimensions	D	W	H	Overall	32	30	18	Seat	32	30	18	<table border="1"> <thead> <tr> <th>COM</th> <th>Price</th> </tr> </thead> <tbody> <tr><td>COM</td><td>\$1,539</td></tr> <tr><td>A</td><td>\$1,595</td></tr> <tr><td>B</td><td>\$1,657</td></tr> <tr><td>COL/C</td><td>\$1,772</td></tr> <tr><td>D</td><td>\$1,917</td></tr> <tr><td>E</td><td>\$2,061</td></tr> <tr><td>F</td><td>\$2,284</td></tr> <tr><td>G</td><td>\$2,526</td></tr> <tr><td>H</td><td>\$2,781</td></tr> <tr><td>I</td><td>\$3,183</td></tr> <tr><td>J</td><td>\$3,665</td></tr> <tr><td>L1</td><td>\$2,895</td></tr> <tr><td>L2</td><td>\$3,231</td></tr> </tbody> </table>	COM	Price	COM	\$1,539	A	\$1,595	B	\$1,657	COL/C	\$1,772	D	\$1,917	E	\$2,061	F	\$2,284	G	\$2,526	H	\$2,781	I	\$3,183	J	\$3,665	L1	\$2,895	L2	\$3,231
		Dimensions	D	W	H																																						
Overall	32	30	18																																								
Seat	32	30	18																																								
COM	Price																																										
COM	\$1,539																																										
A	\$1,595																																										
B	\$1,657																																										
COL/C	\$1,772																																										
D	\$1,917																																										
E	\$2,061																																										
F	\$2,284																																										
G	\$2,526																																										
H	\$2,781																																										
I	\$3,183																																										
J	\$3,665																																										
L1	\$2,895																																										
L2	\$3,231																																										
		<table border="1"> <thead> <tr> <th>Upholstery</th> <th colspan="3">Shipping</th> </tr> </thead> <tbody> <tr> <td>COM Ydg</td> <td>2 ¼</td> <td>Ctn Wt</td> <td>58</td> </tr> <tr> <td>COL Sq Ft</td> <td>52</td> <td>Cu Ft</td> <td>10</td> </tr> </tbody> </table>	Upholstery	Shipping			COM Ydg	2 ¼	Ctn Wt	58	COL Sq Ft	52	Cu Ft	10																													
Upholstery	Shipping																																										
COM Ydg	2 ¼	Ctn Wt	58																																								
COL Sq Ft	52	Cu Ft	10																																								
Single Seat Bench 	CTS320 · 32" seat width · attaches to lounge, bench or other linking units to form a 90° shaped connection · double cut veneer available; specify and add \$128 list	<table border="1"> <thead> <tr> <th>Dimensions</th> <th>D</th> <th>W</th> <th>H</th> </tr> </thead> <tbody> <tr> <td>Overall</td> <td>32</td> <td>32</td> <td>18</td> </tr> <tr> <td>Seat</td> <td>32</td> <td>32</td> <td>18</td> </tr> </tbody> </table>	Dimensions	D	W	H	Overall	32	32	18	Seat	32	32	18	<table border="1"> <thead> <tr> <th>COM</th> <th>Price</th> </tr> </thead> <tbody> <tr><td>COM</td><td>\$1,785</td></tr> <tr><td>A</td><td>\$1,845</td></tr> <tr><td>B</td><td>\$1,912</td></tr> <tr><td>COL/C</td><td>\$2,022</td></tr> <tr><td>D</td><td>\$2,166</td></tr> <tr><td>E</td><td>\$2,312</td></tr> <tr><td>F</td><td>\$2,536</td></tr> <tr><td>G</td><td>\$2,774</td></tr> <tr><td>H</td><td>\$3,032</td></tr> <tr><td>I</td><td>\$3,432</td></tr> <tr><td>J</td><td>\$3,915</td></tr> <tr><td>L1</td><td>\$3,144</td></tr> <tr><td>L2</td><td>\$3,480</td></tr> </tbody> </table>	COM	Price	COM	\$1,785	A	\$1,845	B	\$1,912	COL/C	\$2,022	D	\$2,166	E	\$2,312	F	\$2,536	G	\$2,774	H	\$3,032	I	\$3,432	J	\$3,915	L1	\$3,144	L2	\$3,480
		Dimensions	D	W	H																																						
Overall	32	32	18																																								
Seat	32	32	18																																								
COM	Price																																										
COM	\$1,785																																										
A	\$1,845																																										
B	\$1,912																																										
COL/C	\$2,022																																										
D	\$2,166																																										
E	\$2,312																																										
F	\$2,536																																										
G	\$2,774																																										
H	\$3,032																																										
I	\$3,432																																										
J	\$3,915																																										
L1	\$3,144																																										
L2	\$3,480																																										
		<table border="1"> <thead> <tr> <th>Upholstery</th> <th colspan="3">Shipping</th> </tr> </thead> <tbody> <tr> <td>COM Ydg</td> <td>2 ¼</td> <td>Ctn Wt</td> <td>73</td> </tr> <tr> <td>COL Sq Ft</td> <td>52</td> <td>Cu Ft</td> <td>10</td> </tr> </tbody> </table>	Upholstery	Shipping			COM Ydg	2 ¼	Ctn Wt	73	COL Sq Ft	52	Cu Ft	10																													
Upholstery	Shipping																																										
COM Ydg	2 ¼	Ctn Wt	73																																								
COL Sq Ft	52	Cu Ft	10																																								
Two Seat Bench 	CTL2200 · 20" individual seat width · double cut veneer available; specify and add \$128 list	<table border="1"> <thead> <tr> <th>Dimensions</th> <th>D</th> <th>W</th> <th>H</th> </tr> </thead> <tbody> <tr> <td>Overall</td> <td>32</td> <td>40</td> <td>18</td> </tr> <tr> <td>Seat</td> <td>32</td> <td>40</td> <td>18</td> </tr> </tbody> </table>	Dimensions	D	W	H	Overall	32	40	18	Seat	32	40	18	<table border="1"> <thead> <tr> <th>COM</th> <th>Price</th> </tr> </thead> <tbody> <tr><td>COM</td><td>\$2,732</td></tr> <tr><td>A</td><td>\$2,840</td></tr> <tr><td>B</td><td>\$2,967</td></tr> <tr><td>COL/C</td><td>\$3,191</td></tr> <tr><td>D</td><td>\$3,479</td></tr> <tr><td>E</td><td>\$3,771</td></tr> <tr><td>F</td><td>\$4,218</td></tr> <tr><td>G</td><td>\$4,701</td></tr> <tr><td>H</td><td>\$5,213</td></tr> <tr><td>I</td><td>\$6,016</td></tr> <tr><td>J</td><td>\$6,979</td></tr> <tr><td>L1</td><td>\$5,439</td></tr> <tr><td>L2</td><td>\$6,112</td></tr> </tbody> </table>	COM	Price	COM	\$2,732	A	\$2,840	B	\$2,967	COL/C	\$3,191	D	\$3,479	E	\$3,771	F	\$4,218	G	\$4,701	H	\$5,213	I	\$6,016	J	\$6,979	L1	\$5,439	L2	\$6,112
		Dimensions	D	W	H																																						
Overall	32	40	18																																								
Seat	32	40	18																																								
COM	Price																																										
COM	\$2,732																																										
A	\$2,840																																										
B	\$2,967																																										
COL/C	\$3,191																																										
D	\$3,479																																										
E	\$3,771																																										
F	\$4,218																																										
G	\$4,701																																										
H	\$5,213																																										
I	\$6,016																																										
J	\$6,979																																										
L1	\$5,439																																										
L2	\$6,112																																										
		<table border="1"> <thead> <tr> <th>Upholstery</th> <th colspan="3">Shipping</th> </tr> </thead> <tbody> <tr> <td>COM Ydg</td> <td>4 ½</td> <td>Ctn Wt</td> <td>79</td> </tr> <tr> <td>COL Sq Ft</td> <td>104</td> <td>Cu Ft</td> <td>13</td> </tr> </tbody> </table>	Upholstery	Shipping			COM Ydg	4 ½	Ctn Wt	79	COL Sq Ft	104	Cu Ft	13																													
Upholstery	Shipping																																										
COM Ydg	4 ½	Ctn Wt	79																																								
COL Sq Ft	104	Cu Ft	13																																								

CONNECT

Description	① Model	Specifications			List Price Per Grade	
Two Seat Bench 	CTL2300 · 30" individual seat width · double cut veneer available; specify and add \$128 list	Dimensions	D	W	H	COM \$2,761
		Overall	32	60	18	A \$2,867
		Seat	32	60	18	B \$2,996
		Upholstery	Shipping			COL/C \$3,221
		COM Ydg	4 ½	Ctn Wt	100	D \$3,511
		COL Sq Ft	104	Cu Ft	19	E \$3,796
						F \$4,249
				G \$4,729		
				H \$5,241		
				I \$6,046		
				J \$7,006		
				L1 \$5,467		
				L2 \$6,141		
Three Seat Bench 	CTL3200 · 20" individual seat width · double cut veneer available; specify and add \$128 list	Dimensions	D	W	H	COM \$3,941
		Overall	32	60	18	A \$4,098
		Seat	32	60	18	B \$4,290
		Upholstery	Shipping			COL/C \$4,628
		COM Ydg	6 ¾	Ctn Wt	113	D \$5,058
		COL Sq Ft	156	Cu Ft	19	E \$5,493
						F \$6,167
				G \$6,890		
				H \$7,660		
				I \$8,863		
				J \$10,308		
				L1 \$7,997		
				L2 \$9,008		
Three Seat Bench 	CTL3300 · 30" individual seat width · double cut veneer available; specify and add \$128 list	Dimensions	D	W	H	COM \$3,985
		Overall	32	90	18	A \$4,145
		Seat	32	90	18	B \$4,336
		Upholstery	Shipping			COL/C \$4,672
		COM Ydg	6 ¾	Ctn Wt	158	D \$5,105
		COL Sq Ft	156	Cu Ft	28	E \$5,539
						F \$6,213
				G \$6,935		
				H \$7,706		
				I \$8,912		
				J \$10,352		
				L1 \$8,043		
				L2 \$9,051		

To Order, Specify:

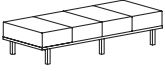
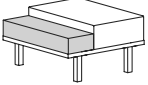
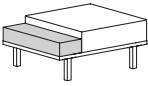
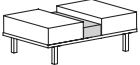
- ① Model Number
- ② Wood Species - Cherry (CH1), Maple (MA1), Walnut (WA1) or Double Cut (DC1)
- ③ Wood Finish [See Wood Finish Options](#)
- ④ Fabric Selection - vendor, pattern and color
Visit www.jsifurniture.com/finishes-and-materials/textiles for our textiles program.
See selection of standard and graded in manufacturers and patterns.
- ⑤ Metal Leg Color - [See Metal Leg Color Options](#)
- ⑥ Optional Rubber Cushion Nylon Glides - no upcharge
- ⑦ Product Options

Specifications

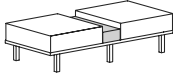
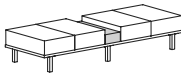

- Wood species - Cherry, Maple, Walnut or Double Cut.
- Seat has synthetic sheet webbing with cross strap reinforcement, 4 ¼" high density polyurethane foam.
- Plywood construction with locking tenons, glue and screws.
- Linking bracket included.
- Metal legs are 16 gauge steel tube with metal leveling glides.

Connect Modular Lounge



Description	① Model	Specifications	List Price Per Grade																																						
Four Seat Bench 	CTL4200 · 20" individual seat width · double cut veneer available; specify and add \$128 list	<table border="1"> <thead> <tr> <th>Dimensions</th> <th>D</th> <th>W</th> <th>H</th> </tr> </thead> <tbody> <tr> <td>Overall</td> <td>32</td> <td>80</td> <td>18</td> </tr> <tr> <td>Seat</td> <td>32</td> <td>80</td> <td>18</td> </tr> </tbody> </table>	Dimensions	D	W	H	Overall	32	80	18	Seat	32	80	18	<table border="1"> <tbody> <tr><td>COM</td><td>\$4,848</td></tr> <tr><td>A</td><td>\$5,051</td></tr> <tr><td>B</td><td>\$5,310</td></tr> <tr><td>COL/C</td><td>\$5,758</td></tr> <tr><td>D</td><td>\$6,336</td></tr> <tr><td>E</td><td>\$6,913</td></tr> <tr><td>F</td><td>\$7,810</td></tr> <tr><td>G</td><td>\$8,774</td></tr> <tr><td>H</td><td>\$9,802</td></tr> <tr><td>I</td><td>\$11,405</td></tr> <tr><td>J</td><td>\$13,330</td></tr> <tr><td>L1</td><td>\$10,250</td></tr> <tr><td>L2</td><td>\$11,596</td></tr> </tbody> </table>	COM	\$4,848	A	\$5,051	B	\$5,310	COL/C	\$5,758	D	\$6,336	E	\$6,913	F	\$7,810	G	\$8,774	H	\$9,802	I	\$11,405	J	\$13,330	L1	\$10,250	L2	\$11,596
		Dimensions	D	W	H																																				
Overall	32	80	18																																						
Seat	32	80	18																																						
COM	\$4,848																																								
A	\$5,051																																								
B	\$5,310																																								
COL/C	\$5,758																																								
D	\$6,336																																								
E	\$6,913																																								
F	\$7,810																																								
G	\$8,774																																								
H	\$9,802																																								
I	\$11,405																																								
J	\$13,330																																								
L1	\$10,250																																								
L2	\$11,596																																								
<table border="1"> <thead> <tr> <th>Upholstery</th> <th colspan="3">Shipping</th> </tr> </thead> <tbody> <tr> <td>COM Ydg</td> <td>9</td> <td>Ctn Wt</td> <td>146</td> </tr> <tr> <td>COL Sq Ft</td> <td>207</td> <td>Cu Ft</td> <td>25</td> </tr> </tbody> </table>	Upholstery	Shipping			COM Ydg	9	Ctn Wt	146	COL Sq Ft	207	Cu Ft	25																													
Upholstery	Shipping																																								
COM Ydg	9	Ctn Wt	146																																						
COL Sq Ft	207	Cu Ft	25																																						
Single Seat Bench with End Table 	CTL1200CR CTL1200CL · 20" seat width · 10" table width · double cut veneer available; specify and add \$191 list	<table border="1"> <thead> <tr> <th>Dimensions</th> <th>D</th> <th>W</th> <th>H</th> </tr> </thead> <tbody> <tr> <td>Overall</td> <td>32</td> <td>30</td> <td>18</td> </tr> <tr> <td>Seat</td> <td>32</td> <td>20</td> <td>18</td> </tr> </tbody> </table>	Dimensions	D	W	H	Overall	32	30	18	Seat	32	20	18	<table border="1"> <tbody> <tr><td>COM</td><td>\$1,830</td></tr> <tr><td>A</td><td>\$1,888</td></tr> <tr><td>B</td><td>\$1,954</td></tr> <tr><td>COL/C</td><td>\$2,066</td></tr> <tr><td>D</td><td>\$2,209</td></tr> <tr><td>E</td><td>\$2,355</td></tr> <tr><td>F</td><td>\$2,578</td></tr> <tr><td>G</td><td>\$2,819</td></tr> <tr><td>H</td><td>\$3,077</td></tr> <tr><td>I</td><td>\$3,477</td></tr> <tr><td>J</td><td>\$3,957</td></tr> <tr><td>L1</td><td>\$3,189</td></tr> <tr><td>L2</td><td>\$3,523</td></tr> </tbody> </table>	COM	\$1,830	A	\$1,888	B	\$1,954	COL/C	\$2,066	D	\$2,209	E	\$2,355	F	\$2,578	G	\$2,819	H	\$3,077	I	\$3,477	J	\$3,957	L1	\$3,189	L2	\$3,523
		Dimensions	D	W	H																																				
Overall	32	30	18																																						
Seat	32	20	18																																						
COM	\$1,830																																								
A	\$1,888																																								
B	\$1,954																																								
COL/C	\$2,066																																								
D	\$2,209																																								
E	\$2,355																																								
F	\$2,578																																								
G	\$2,819																																								
H	\$3,077																																								
I	\$3,477																																								
J	\$3,957																																								
L1	\$3,189																																								
L2	\$3,523																																								
<table border="1"> <thead> <tr> <th>Upholstery</th> <th colspan="3">Shipping</th> </tr> </thead> <tbody> <tr> <td>COM Ydg</td> <td>2 ¼</td> <td>Ctn Wt</td> <td>75</td> </tr> <tr> <td>COL Sq Ft</td> <td>52</td> <td>Cu Ft</td> <td>10</td> </tr> </tbody> </table>	Upholstery	Shipping			COM Ydg	2 ¼	Ctn Wt	75	COL Sq Ft	52	Cu Ft	10																													
Upholstery	Shipping																																								
COM Ydg	2 ¼	Ctn Wt	75																																						
COL Sq Ft	52	Cu Ft	10																																						
Single Seat Bench with End Table 	CTL1300CR CTL1300CL · 30" seat width · 10" table width · double cut veneer available; specify and add \$191 list	<table border="1"> <thead> <tr> <th>Dimensions</th> <th>D</th> <th>W</th> <th>H</th> </tr> </thead> <tbody> <tr> <td>Overall</td> <td>32</td> <td>40</td> <td>18</td> </tr> <tr> <td>Seat</td> <td>32</td> <td>30</td> <td>18</td> </tr> </tbody> </table>	Dimensions	D	W	H	Overall	32	40	18	Seat	32	30	18	<table border="1"> <tbody> <tr><td>COM</td><td>\$1,931</td></tr> <tr><td>A</td><td>\$1,992</td></tr> <tr><td>B</td><td>\$2,056</td></tr> <tr><td>COL/C</td><td>\$2,169</td></tr> <tr><td>D</td><td>\$2,315</td></tr> <tr><td>E</td><td>\$2,458</td></tr> <tr><td>F</td><td>\$2,685</td></tr> <tr><td>G</td><td>\$2,927</td></tr> <tr><td>H</td><td>\$3,181</td></tr> <tr><td>I</td><td>\$3,582</td></tr> <tr><td>J</td><td>\$4,064</td></tr> <tr><td>L1</td><td>\$3,293</td></tr> <tr><td>L2</td><td>\$3,629</td></tr> </tbody> </table>	COM	\$1,931	A	\$1,992	B	\$2,056	COL/C	\$2,169	D	\$2,315	E	\$2,458	F	\$2,685	G	\$2,927	H	\$3,181	I	\$3,582	J	\$4,064	L1	\$3,293	L2	\$3,629
		Dimensions	D	W	H																																				
Overall	32	40	18																																						
Seat	32	30	18																																						
COM	\$1,931																																								
A	\$1,992																																								
B	\$2,056																																								
COL/C	\$2,169																																								
D	\$2,315																																								
E	\$2,458																																								
F	\$2,685																																								
G	\$2,927																																								
H	\$3,181																																								
I	\$3,582																																								
J	\$4,064																																								
L1	\$3,293																																								
L2	\$3,629																																								
<table border="1"> <thead> <tr> <th>Upholstery</th> <th colspan="3">Shipping</th> </tr> </thead> <tbody> <tr> <td>COM Ydg</td> <td>2 ¼</td> <td>Ctn Wt</td> <td>85</td> </tr> <tr> <td>COL Sq Ft</td> <td>52</td> <td>Cu Ft</td> <td>13</td> </tr> </tbody> </table>	Upholstery	Shipping			COM Ydg	2 ¼	Ctn Wt	85	COL Sq Ft	52	Cu Ft	13																													
Upholstery	Shipping																																								
COM Ydg	2 ¼	Ctn Wt	85																																						
COL Sq Ft	52	Cu Ft	13																																						
Two Seat Bench with Center Console 	CTL2200CC · 20" individual seat width · 10" wide center console · double cut veneer available; specify and add \$191 list	<table border="1"> <thead> <tr> <th>Dimensions</th> <th>D</th> <th>W</th> <th>H</th> </tr> </thead> <tbody> <tr> <td>Overall</td> <td>32</td> <td>50</td> <td>18</td> </tr> <tr> <td>Seat</td> <td>32</td> <td>40</td> <td>18</td> </tr> </tbody> </table>	Dimensions	D	W	H	Overall	32	50	18	Seat	32	40	18	<table border="1"> <tbody> <tr><td>COM</td><td>\$2,911</td></tr> <tr><td>A</td><td>\$3,022</td></tr> <tr><td>B</td><td>\$3,150</td></tr> <tr><td>COL/C</td><td>\$3,375</td></tr> <tr><td>D</td><td>\$3,665</td></tr> <tr><td>E</td><td>\$3,953</td></tr> <tr><td>F</td><td>\$4,403</td></tr> <tr><td>G</td><td>\$4,884</td></tr> <tr><td>H</td><td>\$5,395</td></tr> <tr><td>I</td><td>\$6,200</td></tr> <tr><td>J</td><td>\$7,162</td></tr> <tr><td>L1</td><td>\$5,621</td></tr> <tr><td>L2</td><td>\$6,296</td></tr> </tbody> </table>	COM	\$2,911	A	\$3,022	B	\$3,150	COL/C	\$3,375	D	\$3,665	E	\$3,953	F	\$4,403	G	\$4,884	H	\$5,395	I	\$6,200	J	\$7,162	L1	\$5,621	L2	\$6,296
		Dimensions	D	W	H																																				
Overall	32	50	18																																						
Seat	32	40	18																																						
COM	\$2,911																																								
A	\$3,022																																								
B	\$3,150																																								
COL/C	\$3,375																																								
D	\$3,665																																								
E	\$3,953																																								
F	\$4,403																																								
G	\$4,884																																								
H	\$5,395																																								
I	\$6,200																																								
J	\$7,162																																								
L1	\$5,621																																								
L2	\$6,296																																								
<table border="1"> <thead> <tr> <th>Upholstery</th> <th colspan="3">Shipping</th> </tr> </thead> <tbody> <tr> <td>COM Ydg</td> <td>4 ½</td> <td>Ctn Wt</td> <td>96</td> </tr> <tr> <td>COL Sq Ft</td> <td>104</td> <td>Cu Ft</td> <td>16</td> </tr> </tbody> </table>	Upholstery	Shipping			COM Ydg	4 ½	Ctn Wt	96	COL Sq Ft	104	Cu Ft	16																													
Upholstery	Shipping																																								
COM Ydg	4 ½	Ctn Wt	96																																						
COL Sq Ft	104	Cu Ft	16																																						

CONNECT

Description	Model	Specifications				List Price Per Grade	
Two Seat Bench with Center Console 	CTL2300CC · 30" individual seat width · 10" wide center console · double cut veneer available; specify and add \$191 list	Dimensions		D	W	H	COM \$3,127
		Overall	32	70	18	COL/C \$3,590	
		Seat	32	60	18		D \$3,880
		Upholstery		Shipping		E \$4,168	
		COM Ydg	4 ½	Ctn Wt	117		F \$4,616
		COL Sq Ft	104	Cu Ft	22	G \$5,099	
							H \$5,612
							I \$6,415
							J \$7,380
							L1 \$5,837
							L2 \$6,510
Four Seat Bench with Center Console 	CTL4200CC · 20" individual seat width · 10" wide center console · double cut veneer available; specify and add \$191 list	Dimensions		D	W	H	COM \$5,090
		Overall	32	90	18	COL/C \$6,001	
		Seat	32	80	18		D \$6,580
		Upholstery		Shipping		E \$7,156	
		COM Ydg	9	Ctn Wt	163		F \$8,054
		COL Sq Ft	207	Cu Ft	28	G \$9,017	
							H \$10,044
							I \$11,650
							J \$13,573
							L1 \$10,494
							L2 \$11,842
90° Curved Bench 	CTI32120 · 12" inside radius · 44" outside radius · double cut veneer available; specify and add \$128 list	Dimensions		D	W	H	COM \$2,354
		Overall	32		18	COL/C \$2,619	
		Seat	32		18		D \$2,781
		Upholstery		Shipping		E \$2,940	
		COM Ydg	2 ½	Ctn Wt	65		F \$3,190
		COL Sq Ft	58	Cu Ft	23	G \$3,460	
							H \$3,743
							I \$4,190
							J \$4,724
							L1 \$3,868
							L2 \$4,243

To Order, Specify:

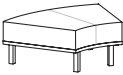
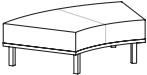
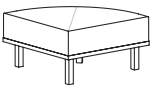
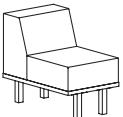
- 1 Model Number
- 2 Wood Species - Cherry (CH1), Maple (MA1), Walnut (WA1) or Double Cut (DC1)
- 3 Wood Finish *See Wood Finish Options*
- 4 Fabric Selection - vendor, pattern and color
Visit www.jsifurniture.com/finishes-and-materials/textiles for our textiles program.
See selection of standard and graded in manufacturers and patterns.
- 5 Metal Leg Color - *See Metal Leg Color Options*
- 6 Optional Power Center - Flush Mount (EC22) - Black (B) or White (W); \$583 list each, see page CT3 for location availability
- 7 Optional Drink Holders (DH) - add \$240 list
- 8 Optional Coordinating Wood Grain Laminate Available on Table Top - no upcharge.
Finishes with an asterisk have a coordinating laminate available.
- 9 Optional Rubber Cushion Nylon Glides - no upcharge
- 10 Product Options

Specifications

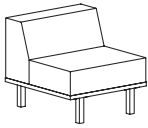
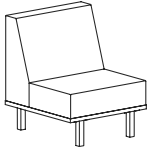
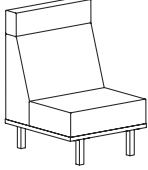
- Wood species - Cherry, Maple, Walnut or Double Cut.
- Seat has synthetic sheet webbing with cross strap reinforcement, 4 ¼" high density polyurethane foam.
- Plywood construction with locking tenons, glue and screws.
- Linking bracket included.
- Metal legs are 16 gauge steel tube with metal leveling glides.

Connect Modular Lounge



Description	① Model	Specifications	List Price Per Grade																																						
45° Curved Bench 	CTI32300 · 30" inside radius · 66" outside radius · double cut veneer available; specify and add \$128 list	<table border="1"> <thead> <tr> <th>Dimensions</th> <th>D</th> <th>W</th> <th>H</th> </tr> </thead> <tbody> <tr> <td>Overall</td> <td>32</td> <td></td> <td>18</td> </tr> <tr> <td>Seat</td> <td>32</td> <td></td> <td>18</td> </tr> </tbody> </table>	Dimensions	D	W	H	Overall	32		18	Seat	32		18	<table border="1"> <thead> <tr> <th>COM</th> <th>\$2,354</th> </tr> </thead> <tbody> <tr><td>A</td><td>\$2,417</td></tr> <tr><td>B</td><td>\$2,473</td></tr> <tr><td>COL/C</td><td>\$2,573</td></tr> <tr><td>D</td><td>\$2,700</td></tr> <tr><td>E</td><td>\$2,831</td></tr> <tr><td>F</td><td>\$3,028</td></tr> <tr><td>G</td><td>\$3,244</td></tr> <tr><td>H</td><td>\$3,473</td></tr> <tr><td>I</td><td>\$3,828</td></tr> <tr><td>J</td><td>\$4,257</td></tr> <tr><td>L1</td><td>\$3,573</td></tr> <tr><td>L2</td><td>\$3,870</td></tr> </tbody> </table>	COM	\$2,354	A	\$2,417	B	\$2,473	COL/C	\$2,573	D	\$2,700	E	\$2,831	F	\$3,028	G	\$3,244	H	\$3,473	I	\$3,828	J	\$4,257	L1	\$3,573	L2	\$3,870
		Dimensions	D	W	H																																				
Overall	32		18																																						
Seat	32		18																																						
COM	\$2,354																																								
A	\$2,417																																								
B	\$2,473																																								
COL/C	\$2,573																																								
D	\$2,700																																								
E	\$2,831																																								
F	\$3,028																																								
G	\$3,244																																								
H	\$3,473																																								
I	\$3,828																																								
J	\$4,257																																								
L1	\$3,573																																								
L2	\$3,870																																								
		<table border="1"> <thead> <tr> <th>Upholstery</th> <th colspan="3">Shipping</th> </tr> </thead> <tbody> <tr> <td>COM Ydg</td> <td>2</td> <td>Ctn Wt</td> <td>62</td> </tr> <tr> <td>COL Sq Ft</td> <td>46</td> <td>Cu Ft</td> <td>18</td> </tr> </tbody> </table>	Upholstery	Shipping			COM Ydg	2	Ctn Wt	62	COL Sq Ft	46	Cu Ft	18																											
Upholstery	Shipping																																								
COM Ydg	2	Ctn Wt	62																																						
COL Sq Ft	46	Cu Ft	18																																						
45° Curved Bench 	CTI32450 · 45" inside radius · 77" outside radius · double cut veneer available; specify and add \$128 list	<table border="1"> <thead> <tr> <th>Dimensions</th> <th>D</th> <th>W</th> <th>H</th> </tr> </thead> <tbody> <tr> <td>Overall</td> <td>32</td> <td></td> <td>18</td> </tr> <tr> <td>Seat</td> <td>32</td> <td></td> <td>18</td> </tr> </tbody> </table>	Dimensions	D	W	H	Overall	32		18	Seat	32		18	<table border="1"> <thead> <tr> <th>COM</th> <th>\$2,354</th> </tr> </thead> <tbody> <tr><td>A</td><td>\$2,424</td></tr> <tr><td>B</td><td>\$2,496</td></tr> <tr><td>COL/C</td><td>\$2,619</td></tr> <tr><td>D</td><td>\$2,781</td></tr> <tr><td>E</td><td>\$2,940</td></tr> <tr><td>F</td><td>\$3,190</td></tr> <tr><td>G</td><td>\$3,460</td></tr> <tr><td>H</td><td>\$3,743</td></tr> <tr><td>I</td><td>\$4,190</td></tr> <tr><td>J</td><td>\$4,724</td></tr> <tr><td>L1</td><td>\$3,868</td></tr> <tr><td>L2</td><td>\$4,243</td></tr> </tbody> </table>	COM	\$2,354	A	\$2,424	B	\$2,496	COL/C	\$2,619	D	\$2,781	E	\$2,940	F	\$3,190	G	\$3,460	H	\$3,743	I	\$4,190	J	\$4,724	L1	\$3,868	L2	\$4,243
		Dimensions	D	W	H																																				
Overall	32		18																																						
Seat	32		18																																						
COM	\$2,354																																								
A	\$2,424																																								
B	\$2,496																																								
COL/C	\$2,619																																								
D	\$2,781																																								
E	\$2,940																																								
F	\$3,190																																								
G	\$3,460																																								
H	\$3,743																																								
I	\$4,190																																								
J	\$4,724																																								
L1	\$3,868																																								
L2	\$4,243																																								
		<table border="1"> <thead> <tr> <th>Upholstery</th> <th colspan="3">Shipping</th> </tr> </thead> <tbody> <tr> <td>COM Ydg</td> <td>2 ½</td> <td>Ctn Wt</td> <td>65</td> </tr> <tr> <td>COL Sq Ft</td> <td>58</td> <td>Cu Ft</td> <td>22</td> </tr> </tbody> </table>	Upholstery	Shipping			COM Ydg	2 ½	Ctn Wt	65	COL Sq Ft	58	Cu Ft	22																											
Upholstery	Shipping																																								
COM Ydg	2 ½	Ctn Wt	65																																						
COL Sq Ft	58	Cu Ft	22																																						
Quarter Round Bench 	CTW900 · 32" seat width · fully upholstered · double cut veneer available; specify and add \$128 list	<table border="1"> <thead> <tr> <th>Dimensions</th> <th>D</th> <th>W</th> <th>H</th> </tr> </thead> <tbody> <tr> <td>Overall</td> <td>32</td> <td></td> <td>18</td> </tr> <tr> <td>Seat</td> <td>32</td> <td></td> <td>18</td> </tr> </tbody> </table>	Dimensions	D	W	H	Overall	32		18	Seat	32		18	<table border="1"> <thead> <tr> <th>COM</th> <th>\$1,564</th> </tr> </thead> <tbody> <tr><td>A</td><td>\$1,616</td></tr> <tr><td>B</td><td>\$1,675</td></tr> <tr><td>COL/C</td><td>\$1,773</td></tr> <tr><td>D</td><td>\$1,899</td></tr> <tr><td>E</td><td>\$2,031</td></tr> <tr><td>F</td><td>\$2,228</td></tr> <tr><td>G</td><td>\$2,443</td></tr> <tr><td>H</td><td>\$2,671</td></tr> <tr><td>I</td><td>\$3,027</td></tr> <tr><td>J</td><td>\$3,454</td></tr> <tr><td>L1</td><td>\$2,771</td></tr> <tr><td>L2</td><td>\$3,073</td></tr> </tbody> </table>	COM	\$1,564	A	\$1,616	B	\$1,675	COL/C	\$1,773	D	\$1,899	E	\$2,031	F	\$2,228	G	\$2,443	H	\$2,671	I	\$3,027	J	\$3,454	L1	\$2,771	L2	\$3,073
		Dimensions	D	W	H																																				
Overall	32		18																																						
Seat	32		18																																						
COM	\$1,564																																								
A	\$1,616																																								
B	\$1,675																																								
COL/C	\$1,773																																								
D	\$1,899																																								
E	\$2,031																																								
F	\$2,228																																								
G	\$2,443																																								
H	\$2,671																																								
I	\$3,027																																								
J	\$3,454																																								
L1	\$2,771																																								
L2	\$3,073																																								
		<table border="1"> <thead> <tr> <th>Upholstery</th> <th colspan="3">Shipping</th> </tr> </thead> <tbody> <tr> <td>COM Ydg</td> <td>2</td> <td>Ctn Wt</td> <td>58</td> </tr> <tr> <td>COL Sq Ft</td> <td>46</td> <td>Cu Ft</td> <td>11</td> </tr> </tbody> </table>	Upholstery	Shipping			COM Ydg	2	Ctn Wt	58	COL Sq Ft	46	Cu Ft	11																											
Upholstery	Shipping																																								
COM Ydg	2	Ctn Wt	58																																						
COL Sq Ft	46	Cu Ft	11																																						
Single Seat Low Back 	CTL1201 · armless · 20" seat width · COM based on single fabric · multiple fabrics, see pages CT6-CT8 for yardage requirements · double cut veneer available; specify and add \$128 list	<table border="1"> <thead> <tr> <th>Dimensions</th> <th>D</th> <th>W</th> <th>H</th> </tr> </thead> <tbody> <tr> <td>Overall</td> <td>32</td> <td>20</td> <td>30 ½</td> </tr> <tr> <td>Seat</td> <td>20</td> <td>20</td> <td>18</td> </tr> </tbody> </table>	Dimensions	D	W	H	Overall	32	20	30 ½	Seat	20	20	18	<table border="1"> <thead> <tr> <th>COM</th> <th>\$1,577</th> </tr> </thead> <tbody> <tr><td>A</td><td>\$1,652</td></tr> <tr><td>B</td><td>\$1,751</td></tr> <tr><td>COL/C</td><td>\$1,925</td></tr> <tr><td>D</td><td>\$2,150</td></tr> <tr><td>E</td><td>\$2,375</td></tr> <tr><td>F</td><td>\$2,725</td></tr> <tr><td>G</td><td>\$3,097</td></tr> <tr><td>H</td><td>\$3,498</td></tr> <tr><td>I</td><td>\$4,122</td></tr> <tr><td>J</td><td>\$4,871</td></tr> <tr><td>L1</td><td>\$3,673</td></tr> <tr><td>L2</td><td>\$4,197</td></tr> </tbody> </table>	COM	\$1,577	A	\$1,652	B	\$1,751	COL/C	\$1,925	D	\$2,150	E	\$2,375	F	\$2,725	G	\$3,097	H	\$3,498	I	\$4,122	J	\$4,871	L1	\$3,673	L2	\$4,197
		Dimensions	D	W	H																																				
Overall	32	20	30 ½																																						
Seat	20	20	18																																						
COM	\$1,577																																								
A	\$1,652																																								
B	\$1,751																																								
COL/C	\$1,925																																								
D	\$2,150																																								
E	\$2,375																																								
F	\$2,725																																								
G	\$3,097																																								
H	\$3,498																																								
I	\$4,122																																								
J	\$4,871																																								
L1	\$3,673																																								
L2	\$4,197																																								
		<table border="1"> <thead> <tr> <th>Upholstery</th> <th colspan="3">Shipping</th> </tr> </thead> <tbody> <tr> <td>COM Ydg</td> <td>3 ½</td> <td>Ctn Wt</td> <td>66</td> </tr> <tr> <td>COL Sq Ft</td> <td>81</td> <td>Cu Ft</td> <td>11</td> </tr> </tbody> </table>	Upholstery	Shipping			COM Ydg	3 ½	Ctn Wt	66	COL Sq Ft	81	Cu Ft	11																											
Upholstery	Shipping																																								
COM Ydg	3 ½	Ctn Wt	66																																						
COL Sq Ft	81	Cu Ft	11																																						

CONNECT

Description	① Model	Specifications			List Price Per Grade	
Single Seat Low Back 	CTL1301 <ul style="list-style-type: none"> armless 30" seat width COM based on single fabric multiple fabrics, see pages CT6-CT8 for yardage requirements double cut veneer available; specify and add \$128 list 	Dimensions	D	W	H	COM \$1,716
		Overall	32	30	30½	A \$1,794
		Seat	20	30	18	B \$1,892
		Upholstery	Shipping			COL/C \$2,068
		COM Ydg	3½	Ctn Wt	77	D \$2,293
		COL Sq Ft	81	Cu Ft	16	E \$2,516
						F \$2,865
						G \$3,241
						H \$3,638
						I \$4,263
						J \$5,012
						L1 \$3,816
						L2 \$4,338
Single Seat Mid Back 	CTL1302 <ul style="list-style-type: none"> armless 30" seat width COM based on single fabric multiple fabrics, see pages CT6-CT8 for yardage requirements double cut veneer available; specify and add \$128 list 	Dimensions	D	W	H	COM \$1,911
		Overall	32	30	37½	A \$1,991
		Seat	20	30	18	B \$2,100
		Upholstery	Shipping			COL/C \$2,284
		COM Ydg	3¾	Ctn Wt	82	D \$2,526
		COL Sq Ft	87	Cu Ft	21	E \$2,767
						F \$3,141
						G \$3,541
						H \$3,970
						I \$4,640
						J \$5,440
						L1 \$4,158
						L2 \$4,718
Single Seat High Back 	CTL1303 <ul style="list-style-type: none"> armless 30" seat width 7" high headrest COM based on single fabric multiple fabrics, see pages CT6-CT8 for yardage requirements double cut veneer available; specify and add \$128 list 	Dimensions	D	W	H	COM \$2,101
		Overall	32	30	44½	A \$2,197
		Seat	20	30	18	B \$2,324
		Upholstery	Shipping			COL/C \$2,547
		COM Ydg	4½	Ctn Wt	90	D \$2,840
		COL Sq Ft	104	Cu Ft	25	E \$3,127
						F \$3,578
						G \$4,058
						H \$4,569
						I \$5,374
						J \$6,338
						L1 \$4,795
						L2 \$5,469

To Order, Specify:


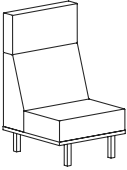
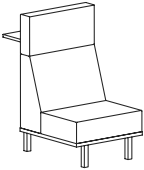
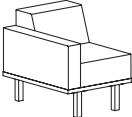
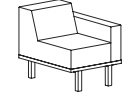
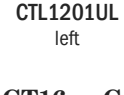
- ① Model Number
- ② Wood Species - Cherry (CH1), Maple (MA1), Walnut (WA1) or Double Cut (DC1)
- ③ Wood Finish See Wood Finish Options
- ④ Fabric Selection - vendor, pattern and color
 - A. Seat
 - B. Back
 Visit www.jsifurniture.com/finishes-and-materials/textiles for our textiles program.
 See selection of standard and graded in manufacturers and patterns.
- ⑤ Metal Leg Color - See Metal Leg Color Options
- ⑥ Optional Rubber Cushion Nylon Glides - no upcharge

Specifications

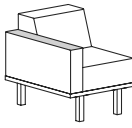

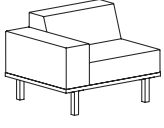

- Wood species - Cherry, Maple, Walnut or Double Cut.
- Seat has synthetic sheet webbing with cross strap reinforcement, 4¼" high density polyurethane foam.
- Back has high density polyurethane foam.
- Plywood construction with locking tenons, glue and screws.
- Linking bracket included.
- Metal legs are 16 gauge steel tube with metal leveling glides.

Connect Modular Lounge



Description	Model	Specifications	List Price Per Grade																																
Single Seat High Back with Stand Up Surface 	CTL1304 · armless · stand up surface corner; specify square (S) no upcharge or rounded (R) add \$49 list · 30" seat width · 7" high headrest · 41 ¾" high stand up surface · COM based on single fabric · multiple fabrics, see pages CT6-CT8 for yardage requirements · double cut veneer available; specify and add \$128 list	<table border="1"> <thead> <tr> <th>Dimensions</th> <th>D</th> <th>W</th> <th>H</th> </tr> </thead> <tbody> <tr> <td>Overall</td> <td>42</td> <td>30</td> <td>44 ½</td> </tr> <tr> <td>Seat</td> <td>20</td> <td>30</td> <td>18</td> </tr> </tbody> </table>	Dimensions	D	W	H	Overall	42	30	44 ½	Seat	20	30	18	<table border="1"> <thead> <tr> <th colspan="2">Shipping</th> </tr> </thead> <tbody> <tr> <td>Ctn Wt</td> <td>125</td> </tr> <tr> <td>Cu Ft</td> <td>34</td> </tr> </tbody> </table>	Shipping		Ctn Wt	125	Cu Ft	34														
		Dimensions	D	W	H																														
Overall	42	30	44 ½																																
Seat	20	30	18																																
Shipping																																			
Ctn Wt	125																																		
Cu Ft	34																																		
		<table border="1"> <thead> <tr> <th>Upholstery</th> <th>Shipping</th> </tr> </thead> <tbody> <tr> <td>COM Ydg</td> <td>4 ½</td> </tr> <tr> <td>COL Sq Ft</td> <td>104</td> </tr> </tbody> </table>	Upholstery	Shipping	COM Ydg	4 ½	COL Sq Ft	104	<table border="1"> <tbody> <tr><td>COM</td><td>\$3,261</td></tr> <tr><td>A</td><td>\$3,375</td></tr> <tr><td>B</td><td>\$3,503</td></tr> <tr><td>COL/C</td><td>\$3,729</td></tr> <tr><td>D</td><td>\$4,016</td></tr> <tr><td>E</td><td>\$4,305</td></tr> <tr><td>F</td><td>\$4,754</td></tr> <tr><td>G</td><td>\$5,236</td></tr> <tr><td>H</td><td>\$5,750</td></tr> <tr><td>I</td><td>\$6,551</td></tr> <tr><td>J</td><td>\$7,515</td></tr> <tr><td>L1</td><td>\$5,973</td></tr> <tr><td>L2</td><td>\$6,649</td></tr> </tbody> </table>	COM	\$3,261	A	\$3,375	B	\$3,503	COL/C	\$3,729	D	\$4,016	E	\$4,305	F	\$4,754	G	\$5,236	H	\$5,750	I	\$6,551	J	\$7,515	L1	\$5,973	L2	\$6,649
Upholstery	Shipping																																		
COM Ydg	4 ½																																		
COL Sq Ft	104																																		
COM	\$3,261																																		
A	\$3,375																																		
B	\$3,503																																		
COL/C	\$3,729																																		
D	\$4,016																																		
E	\$4,305																																		
F	\$4,754																																		
G	\$5,236																																		
H	\$5,750																																		
I	\$6,551																																		
J	\$7,515																																		
L1	\$5,973																																		
L2	\$6,649																																		
Single Seat Privacy Back 	CTL1305 · armless · 30" seat width · 14" high headrest · COM based on single fabric · multiple fabrics, see pages CT6-CT8 for yardage requirements · double cut veneer available; specify and add \$128 list	<table border="1"> <thead> <tr> <th>Dimensions</th> <th>D</th> <th>W</th> <th>H</th> </tr> </thead> <tbody> <tr> <td>Overall</td> <td>32</td> <td>30</td> <td>51 ½</td> </tr> <tr> <td>Seat</td> <td>20</td> <td>30</td> <td>18</td> </tr> </tbody> </table>	Dimensions	D	W	H	Overall	32	30	51 ½	Seat	20	30	18	<table border="1"> <thead> <tr> <th colspan="2">Shipping</th> </tr> </thead> <tbody> <tr> <td>Ctn Wt</td> <td>93</td> </tr> <tr> <td>Cu Ft</td> <td>29</td> </tr> </tbody> </table>	Shipping		Ctn Wt	93	Cu Ft	29														
		Dimensions	D	W	H																														
Overall	32	30	51 ½																																
Seat	20	30	18																																
Shipping																																			
Ctn Wt	93																																		
Cu Ft	29																																		
		<table border="1"> <thead> <tr> <th>Upholstery</th> <th>Shipping</th> </tr> </thead> <tbody> <tr> <td>COM Ydg</td> <td>5</td> </tr> <tr> <td>COL Sq Ft</td> <td>115</td> </tr> </tbody> </table>	Upholstery	Shipping	COM Ydg	5	COL Sq Ft	115	<table border="1"> <tbody> <tr><td>COM</td><td>\$2,290</td></tr> <tr><td>A</td><td>\$2,399</td></tr> <tr><td>B</td><td>\$2,540</td></tr> <tr><td>COL/C</td><td>\$2,791</td></tr> <tr><td>D</td><td>\$3,111</td></tr> <tr><td>E</td><td>\$3,430</td></tr> <tr><td>F</td><td>\$3,931</td></tr> <tr><td>G</td><td>\$4,466</td></tr> <tr><td>H</td><td>\$5,037</td></tr> <tr><td>I</td><td>\$5,927</td></tr> <tr><td>J</td><td>\$6,997</td></tr> <tr><td>L1</td><td>\$5,285</td></tr> <tr><td>L2</td><td>\$6,033</td></tr> </tbody> </table>	COM	\$2,290	A	\$2,399	B	\$2,540	COL/C	\$2,791	D	\$3,111	E	\$3,430	F	\$3,931	G	\$4,466	H	\$5,037	I	\$5,927	J	\$6,997	L1	\$5,285	L2	\$6,033
Upholstery	Shipping																																		
COM Ydg	5																																		
COL Sq Ft	115																																		
COM	\$2,290																																		
A	\$2,399																																		
B	\$2,540																																		
COL/C	\$2,791																																		
D	\$3,111																																		
E	\$3,430																																		
F	\$3,931																																		
G	\$4,466																																		
H	\$5,037																																		
I	\$5,927																																		
J	\$6,997																																		
L1	\$5,285																																		
L2	\$6,033																																		
Single Seat Privacy Back with Stand Up Surface 	CTL1306 · armless · stand up surface corner; specify square (S) no upcharge or rounded (R) add \$49 list · 30" seat width · 14" high headrest · 41 ¾" high stand up surface · COM based on single fabric · multiple fabrics, see pages CT6-CT8 for yardage requirements · double cut veneer available; specify and add \$128 list	<table border="1"> <thead> <tr> <th>Dimensions</th> <th>D</th> <th>W</th> <th>H</th> </tr> </thead> <tbody> <tr> <td>Overall</td> <td>42</td> <td>30</td> <td>51 ½</td> </tr> <tr> <td>Seat</td> <td>20</td> <td>30</td> <td>18</td> </tr> </tbody> </table>	Dimensions	D	W	H	Overall	42	30	51 ½	Seat	20	30	18	<table border="1"> <thead> <tr> <th colspan="2">Shipping</th> </tr> </thead> <tbody> <tr> <td>Ctn Wt</td> <td>128</td> </tr> <tr> <td>Cu Ft</td> <td>39</td> </tr> </tbody> </table>	Shipping		Ctn Wt	128	Cu Ft	39														
		Dimensions	D	W	H																														
Overall	42	30	51 ½																																
Seat	20	30	18																																
Shipping																																			
Ctn Wt	128																																		
Cu Ft	39																																		
		<table border="1"> <thead> <tr> <th>Upholstery</th> <th>Shipping</th> </tr> </thead> <tbody> <tr> <td>COM Ydg</td> <td>5</td> </tr> <tr> <td>COL Sq Ft</td> <td>115</td> </tr> </tbody> </table>	Upholstery	Shipping	COM Ydg	5	COL Sq Ft	115	<table border="1"> <tbody> <tr><td>COM</td><td>\$3,452</td></tr> <tr><td>A</td><td>\$3,578</td></tr> <tr><td>B</td><td>\$3,719</td></tr> <tr><td>COL/C</td><td>\$3,968</td></tr> <tr><td>D</td><td>\$4,289</td></tr> <tr><td>E</td><td>\$4,610</td></tr> <tr><td>F</td><td>\$5,110</td></tr> <tr><td>G</td><td>\$5,646</td></tr> <tr><td>H</td><td>\$6,215</td></tr> <tr><td>I</td><td>\$7,108</td></tr> <tr><td>J</td><td>\$8,175</td></tr> <tr><td>L1</td><td>\$6,463</td></tr> <tr><td>L2</td><td>\$7,213</td></tr> </tbody> </table>	COM	\$3,452	A	\$3,578	B	\$3,719	COL/C	\$3,968	D	\$4,289	E	\$4,610	F	\$5,110	G	\$5,646	H	\$6,215	I	\$7,108	J	\$8,175	L1	\$6,463	L2	\$7,213
Upholstery	Shipping																																		
COM Ydg	5																																		
COL Sq Ft	115																																		
COM	\$3,452																																		
A	\$3,578																																		
B	\$3,719																																		
COL/C	\$3,968																																		
D	\$4,289																																		
E	\$4,610																																		
F	\$5,110																																		
G	\$5,646																																		
H	\$6,215																																		
I	\$7,108																																		
J	\$8,175																																		
L1	\$6,463																																		
L2	\$7,213																																		
Single Seat Low Back 	CTL1201UR CTL1201UL · upholstered arm · 5" arm width · 20" seat width · COM based on single fabric · multiple fabrics, see pages CT6-CT8 for yardage requirements · double cut veneer available; specify and add \$128 list	<table border="1"> <thead> <tr> <th>Dimensions</th> <th>D</th> <th>W</th> <th>H</th> </tr> </thead> <tbody> <tr> <td>Overall</td> <td>32</td> <td>25</td> <td>30 ½</td> </tr> <tr> <td>Seat</td> <td>20</td> <td>20</td> <td>18</td> </tr> <tr> <td>Arm</td> <td></td> <td>5</td> <td>24 ½</td> </tr> </tbody> </table>	Dimensions	D	W	H	Overall	32	25	30 ½	Seat	20	20	18	Arm		5	24 ½	<table border="1"> <thead> <tr> <th colspan="2">Shipping</th> </tr> </thead> <tbody> <tr> <td>Ctn Wt</td> <td>72</td> </tr> <tr> <td>Cu Ft</td> <td>14</td> </tr> </tbody> </table>	Shipping		Ctn Wt	72	Cu Ft	14										
		Dimensions	D	W	H																														
Overall	32	25	30 ½																																
Seat	20	20	18																																
Arm		5	24 ½																																
Shipping																																			
Ctn Wt	72																																		
Cu Ft	14																																		
CTL1201UR right 		<table border="1"> <thead> <tr> <th>Upholstery</th> <th>Shipping</th> </tr> </thead> <tbody> <tr> <td>COM Ydg</td> <td>5</td> </tr> <tr> <td>COL Sq Ft</td> <td>115</td> </tr> </tbody> </table>	Upholstery	Shipping	COM Ydg	5	COL Sq Ft	115	<table border="1"> <tbody> <tr><td>COM</td><td>\$2,196</td></tr> <tr><td>A</td><td>\$2,301</td></tr> <tr><td>B</td><td>\$2,443</td></tr> <tr><td>COL/C</td><td>\$2,692</td></tr> <tr><td>D</td><td>\$3,013</td></tr> <tr><td>E</td><td>\$3,333</td></tr> <tr><td>F</td><td>\$3,832</td></tr> <tr><td>G</td><td>\$4,367</td></tr> <tr><td>H</td><td>\$4,938</td></tr> <tr><td>I</td><td>\$5,830</td></tr> <tr><td>J</td><td>\$6,898</td></tr> <tr><td>L1</td><td>\$5,189</td></tr> <tr><td>L2</td><td>\$5,935</td></tr> </tbody> </table>	COM	\$2,196	A	\$2,301	B	\$2,443	COL/C	\$2,692	D	\$3,013	E	\$3,333	F	\$3,832	G	\$4,367	H	\$4,938	I	\$5,830	J	\$6,898	L1	\$5,189	L2	\$5,935
Upholstery	Shipping																																		
COM Ydg	5																																		
COL Sq Ft	115																																		
COM	\$2,196																																		
A	\$2,301																																		
B	\$2,443																																		
COL/C	\$2,692																																		
D	\$3,013																																		
E	\$3,333																																		
F	\$3,832																																		
G	\$4,367																																		
H	\$4,938																																		
I	\$5,830																																		
J	\$6,898																																		
L1	\$5,189																																		
L2	\$5,935																																		
CTL1201UL left 																																			

CONNECT

Description	Model	Specifications			List Price Per Grade		
		Dimensions	D	W	H	COM	
Single Seat Low Back  CTL1201WR right  CTL1201WL left	CTL1201WR CTL1201WL <ul style="list-style-type: none"> • wood cap arm • 5" arm width • 20" seat width • COM based on single fabric • multiple fabrics, see pages CT6-CT8 for yardage requirements • double cut veneer available; specify and add \$163 list 	Overall	32	25	30½	COM	\$2,384
		Seat	20	20	18	COL/C	\$2,885
		Arm	5		25	D	\$3,206
		Upholstery		Shipping		E	\$3,525
		COM Ydg	5	Ctn Wt	77	F	\$4,027
		COL Sq Ft	115	Cu Ft	14	G	\$4,560
						H	\$5,132
						I	\$6,022
						J	\$7,092
						L1	\$5,380
						L2	\$6,128
Single Seat Low Back  CTL1301UR right  CTL1301UL left	CTL1301UR CTL1301UL <ul style="list-style-type: none"> • upholstered arm • 10" arm width • 30" seat width • COM based on single fabric • multiple fabrics, see pages CT6-CT8 for yardage requirements • double cut veneer available; specify and add \$128 list 	Overall	32	40	30½	COM	\$2,381
		Seat	20	30	18	COL/C	\$2,881
		Arm	10		24½	D	\$3,201
		Upholstery		Shipping		E	\$3,520
		COM Ydg	5	Ctn Wt	104	F	\$4,023
		COL Sq Ft	115	Cu Ft	21	G	\$4,556
						H	\$5,127
						I	\$6,018
						J	\$7,087
						L1	\$5,376
						L2	\$6,124

To Order, Specify:

- 1 Model Number
- 2 Wood Species - Cherry (CH1), Maple (MA1), Walnut (WA1) or Double Cut (DC1)
- 3 Wood Finish See [Wood Finish Options](#)
- 4 Laminate Color Selection (Stand Up Surface) See [Laminate Color Selection](#)
- 5 Surface Corners (Stand Up Surface) - Square (S), no upcharge or Rounded (R), add \$49 list
- 6 Fabric Selection - vendor, pattern and color
 - A. Seat
 - B. Back
 - C. Arm
 - D. Headrest
 Visit www.jsifurniture.com/finishes-and-materials/textiles for our textiles program.
 See selection of standard and graded in manufacturers and patterns.
- 7 Metal Leg Color - See [Metal Leg Color Options](#)
- 8 Optional Power Center - Flush Mount (EC22) - Black (B) or White (W); \$583 list each, see page CT3 for location availability
- 9 Arm Cap - Wood (M) or Black 3D Laminate (B3L)
- 10 Optional Drink Holder (DH) - add \$120 list each
- 11 Optional Tablet Arm - indicate left (TBL) or right arm (TBR); flat cut add \$663 list, double cut add \$691 list
- 12 Optional Coordinating Wood Grain Laminate Available on Wood Cap Arm - no upcharge. Finishes with an asterisk have a coordinating laminate available.
- 13 Optional Rubber Cushion Nylon Glides - no upcharge

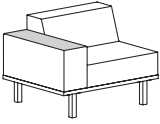
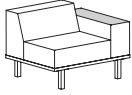
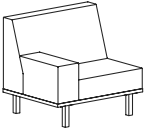
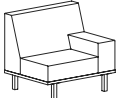
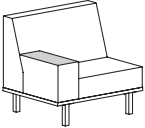
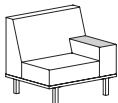
Specifications

- Wood species - Cherry, Maple, Walnut or Double Cut. Seat has synthetic sheet webbing with cross strap reinforcement, 4 ¼" high density polyurethane foam.
- Back has high density polyurethane foam.
- Arms have ¾" thick top and ¼" thick side high density polyurethane foam.
- Plywood construction with locking tenons, glue and screws.
- Linking bracket included.
- Metal legs are 16 gauge steel tube with metal leveling glides.
- ¾" thick 10" deep laminate stand up surface with coordinating 3mm PVC edge supported by steel columns, 42" surface height.

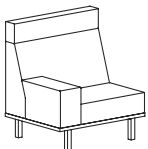

CONNECT

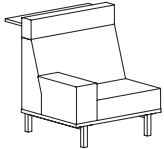
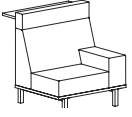
Connect Modular Lounge



Description	① Model	Specifications	List Price Per Grade
Single Seat Low Back	CTL1301WR CTL1301WL	Dimensions	COM \$2,570
	· wood cap arm · 10" arm width · 30" seat width · COM based on single fabric	D 32 W 40 H 30½	A \$2,683
CTL1301WR right	· multiple fabrics, see pages CT6-CT8 for yardage requirements	Seat 20 30 18	B \$2,821
	· double cut veneer available; specify and add \$163 list	Arm 10 25	COL/C \$3,074
CTL1301WL left		Upholstery	D \$3,393
		COM Ydg 5 Ctn Wt 109	E \$3,715
		COL Sq Ft 115 Cu Ft 21	F \$4,215
			G \$4,749
			H \$5,320
			I \$6,212
			J \$7,280
			L1 \$5,568
			L2 \$6,316
Single Seat Mid Back	CTL1302UR CTL1302UL	Dimensions	COM \$2,571
	· upholstered arm · 10" arm width · 30" seat width · COM based on single fabric	D 32 W 40 H 37½	A \$2,687
CTL1302UR right	· multiple fabrics, see pages CT6-CT8 for yardage requirements	Seat 20 30 18	B \$2,835
	· double cut veneer available; specify and add \$128 list	Arm 10 24½	COL/C \$3,096
CTL1302UL left		Upholstery	D \$3,432
		COM Ydg 5¼ Ctn Wt 104	E \$3,772
		COL Sq Ft 121 Cu Ft 27	F \$4,296
			G \$4,857
			H \$5,457
			I \$6,393
			J \$7,516
			L1 \$5,720
			L2 \$6,506
Single Seat Mid Back	CTL1302WR CTL1302WL	Dimensions	COM \$2,761
	· wood cap arm · 10" arm width · 30" seat width · COM based on single fabric	D 32 W 40 H 37½	A \$2,881
CTL1302WR right	· multiple fabrics, see pages CT6-CT8 for yardage requirements	Seat 20 30 18	B \$3,027
	· double cut veneer available; specify and add \$163 list	Arm 10 25	COL/C \$3,291
CTL1302WL left		Upholstery	D \$3,628
		COM Ydg 5¼ Ctn Wt 109	E \$3,964
		COL Sq Ft 121 Cu Ft 27	F \$4,488
			G \$5,051
			H \$5,650
			I \$6,584
			J \$7,710
			L1 \$5,911
			L2 \$6,697

CONNECT

Description	Model	Specifications			List Price Per Grade																																											
Single Seat High Back  CTL1303UR right	CTL1303UR CTL1303UL <ul style="list-style-type: none"> · upholstered arm · 10" arm width · 30" seat width · 7" high headrest · COM based on single fabric · multiple fabrics, see pages CT6-CT8 for yardage requirements · double cut veneer available; specify and add \$128 list 	<table border="1"> <thead> <tr> <th>Dimensions</th> <th>D</th> <th>W</th> <th>H</th> </tr> </thead> <tbody> <tr> <td>Overall</td> <td>32</td> <td>40</td> <td>44½</td> </tr> <tr> <td>Seat</td> <td>20</td> <td>30</td> <td>18</td> </tr> <tr> <td>Arm</td> <td></td> <td>10</td> <td>24½</td> </tr> </tbody> </table>			Dimensions	D	W	H	Overall	32	40	44½	Seat	20	30	18	Arm		10	24½	<table border="1"> <tbody> <tr> <td>COM</td> <td>\$2,764</td> </tr> <tr> <td>A</td> <td>\$2,893</td> </tr> <tr> <td>B</td> <td>\$3,060</td> </tr> <tr> <td>COL/C</td> <td>\$3,362</td> </tr> <tr> <td>D</td> <td>\$3,747</td> </tr> <tr> <td>E</td> <td>\$4,130</td> </tr> <tr> <td>F</td> <td>\$4,730</td> </tr> <tr> <td>G</td> <td>\$5,374</td> </tr> <tr> <td>H</td> <td>\$6,058</td> </tr> <tr> <td>I</td> <td>\$7,127</td> </tr> <tr> <td>J</td> <td>\$8,411</td> </tr> <tr> <td>L1</td> <td>\$6,355</td> </tr> <tr> <td>L2</td> <td>\$7,254</td> </tr> </tbody> </table>		COM	\$2,764	A	\$2,893	B	\$3,060	COL/C	\$3,362	D	\$3,747	E	\$4,130	F	\$4,730	G	\$5,374	H	\$6,058	I	\$7,127	J	\$8,411	L1	\$6,355	L2	\$7,254
		Dimensions	D	W	H																																											
Overall	32	40	44½																																													
Seat	20	30	18																																													
Arm		10	24½																																													
COM	\$2,764																																															
A	\$2,893																																															
B	\$3,060																																															
COL/C	\$3,362																																															
D	\$3,747																																															
E	\$4,130																																															
F	\$4,730																																															
G	\$5,374																																															
H	\$6,058																																															
I	\$7,127																																															
J	\$8,411																																															
L1	\$6,355																																															
L2	\$7,254																																															
 CTL1303UL left		<table border="1"> <thead> <tr> <th>Upholstery</th> <th colspan="2">Shipping</th> </tr> </thead> <tbody> <tr> <td>COM Ydg</td> <td>6</td> <td>Ctn Wt 120</td> </tr> <tr> <td>COL Sq Ft</td> <td>138</td> <td>Cu Ft 33</td> </tr> </tbody> </table>			Upholstery	Shipping		COM Ydg	6	Ctn Wt 120	COL Sq Ft	138	Cu Ft 33																																			
Upholstery	Shipping																																															
COM Ydg	6	Ctn Wt 120																																														
COL Sq Ft	138	Cu Ft 33																																														

Single Seat High Back with Stand Up Surface  CTL1304UR right	CTL1304UR CTL1304UL <ul style="list-style-type: none"> · upholstered arm · stand up surface corner; specify square (S) no upcharge or rounded (R) add \$49 list · 10" arm width · 30" seat width · 7" high headrest · 41¾" high stand up surface · COM based on single fabric · multiple fabrics, see pages CT6-CT8 for yardage requirements · double cut veneer available; specify and add \$128 list 	<table border="1"> <thead> <tr> <th>Dimensions</th> <th>D</th> <th>W</th> <th>H</th> </tr> </thead> <tbody> <tr> <td>Overall</td> <td>42</td> <td>40</td> <td>44½</td> </tr> <tr> <td>Seat</td> <td>20</td> <td>30</td> <td>18</td> </tr> <tr> <td>Arm</td> <td></td> <td>10</td> <td>24½</td> </tr> </tbody> </table>			Dimensions	D	W	H	Overall	42	40	44½	Seat	20	30	18	Arm		10	24½	<table border="1"> <tbody> <tr> <td>COM</td> <td>\$3,941</td> </tr> <tr> <td>A</td> <td>\$4,087</td> </tr> <tr> <td>B</td> <td>\$4,258</td> </tr> <tr> <td>COL/C</td> <td>\$4,558</td> </tr> <tr> <td>D</td> <td>\$4,945</td> </tr> <tr> <td>E</td> <td>\$5,327</td> </tr> <tr> <td>F</td> <td>\$5,927</td> </tr> <tr> <td>G</td> <td>\$6,570</td> </tr> <tr> <td>H</td> <td>\$7,253</td> </tr> <tr> <td>I</td> <td>\$8,323</td> </tr> <tr> <td>J</td> <td>\$9,608</td> </tr> <tr> <td>L1</td> <td>\$7,553</td> </tr> <tr> <td>L2</td> <td>\$8,451</td> </tr> </tbody> </table>		COM	\$3,941	A	\$4,087	B	\$4,258	COL/C	\$4,558	D	\$4,945	E	\$5,327	F	\$5,927	G	\$6,570	H	\$7,253	I	\$8,323	J	\$9,608	L1	\$7,553	L2	\$8,451
		Dimensions	D	W	H																																											
Overall	42	40	44½																																													
Seat	20	30	18																																													
Arm		10	24½																																													
COM	\$3,941																																															
A	\$4,087																																															
B	\$4,258																																															
COL/C	\$4,558																																															
D	\$4,945																																															
E	\$5,327																																															
F	\$5,927																																															
G	\$6,570																																															
H	\$7,253																																															
I	\$8,323																																															
J	\$9,608																																															
L1	\$7,553																																															
L2	\$8,451																																															
 CTL1304UL left		<table border="1"> <thead> <tr> <th>Upholstery</th> <th colspan="2">Shipping</th> </tr> </thead> <tbody> <tr> <td>COM Ydg</td> <td>6</td> <td>Ctn Wt 158</td> </tr> <tr> <td>COL Sq Ft</td> <td>138</td> <td>Cu Ft 43</td> </tr> </tbody> </table>			Upholstery	Shipping		COM Ydg	6	Ctn Wt 158	COL Sq Ft	138	Cu Ft 43																																			
Upholstery	Shipping																																															
COM Ydg	6	Ctn Wt 158																																														
COL Sq Ft	138	Cu Ft 43																																														

To Order, Specify:

- 1 Model Number
- 2 Wood Species - Cherry (CH1), Maple (MA1), Walnut (WA1) or Double Cut (DC1)
- 3 Wood Finish See [Wood Finish Options](#)
- 4 Laminate Color Selection (Stand Up Surface) See [Laminate Color Selection](#)
- 5 Surface Corners (Stand Up Surface) - Square (S), no upcharge or Rounded (R), add \$49 list
- 6 Fabric Selection - vendor, pattern and color
 - A. Seat
 - B. Back
 - C. Arm
 - D. Headrest
 Visit www.jsifurniture.com/finishes-and-materials/textiles for our textiles program. See selection of standard and graded in manufacturers and patterns.
- 7 Metal Leg Color - See [Metal Leg Color Options](#)
- 8 Optional Power Center - Flush Mount (EC22) - Black (B) or White (W); \$583 list each, see page CT3 for location availability
- 9 Arm Cap - Wood (M) or Black 3D Laminate (B3L)
- 10 Optional Drink Holder (DH) - add \$120 list each
- 11 Optional Tablet Arm - indicate left (TBL) or right arm (TBR); flat cut add \$663 list, double cut add \$691 list
- 12 Optional Coordinating Wood Grain Laminate Available on Wood Cap Arm - no upcharge. Finishes with an asterisk have a coordinating laminate available.
- 13 Optional Rubber Cushion Nylon Glides - no upcharge

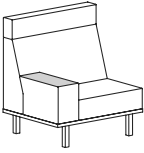
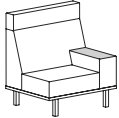
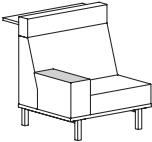
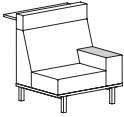
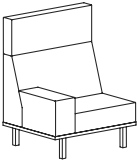

Specifications

- Wood species - Cherry, Maple, Walnut or Double Cut. Seat has synthetic sheet webbing with cross strap reinforcement, 4¼" high density polyurethane foam.
- Back has high density polyurethane foam.
- Arms have ¾" thick top and ¼" thick side high density polyurethane foam.
- Plywood construction with locking tenons, glue and screws.
- Linking bracket included.
- Metal legs are 16 gauge steel tube with metal leveling glides.
- ¾" thick 10" deep laminate stand up surface with coordinating 3mm PVC edge supported by steel columns, 42" surface height.

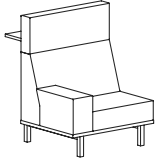
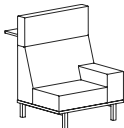
CONNECT

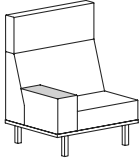
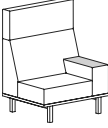
Connect Modular Lounge



Description	① Model	Specifications	List Price Per Grade																												
Single Seat High Back	CTL1303WR CTL1303WL <ul style="list-style-type: none"> · wood cap arm · 10" arm width · 30" seat width · 7" high headrest · COM based on single fabric · multiple fabrics, see pages CT6-CT8 for yardage requirements · double cut veneer available; specify and add \$163 list 	<table border="1"> <thead> <tr> <th>Dimensions</th> <th>D</th> <th>W</th> <th>H</th> </tr> </thead> <tbody> <tr> <td>Overall</td> <td>32</td> <td>40</td> <td>44 ½</td> </tr> <tr> <td>Seat</td> <td>20</td> <td>30</td> <td>18</td> </tr> <tr> <td>Arm</td> <td></td> <td>10</td> <td>25</td> </tr> </tbody> </table>	Dimensions	D	W	H	Overall	32	40	44 ½	Seat	20	30	18	Arm		10	25	<table border="1"> <thead> <tr> <th colspan="2">Upholstery</th> <th colspan="2">Shipping</th> </tr> </thead> <tbody> <tr> <td>COM Ydg</td> <td>6</td> <td>Ctn Wt</td> <td>125</td> </tr> <tr> <td>COL Sq Ft</td> <td>138</td> <td>Cu Ft</td> <td>33</td> </tr> </tbody> </table>	Upholstery		Shipping		COM Ydg	6	Ctn Wt	125	COL Sq Ft	138	Cu Ft	33
		Dimensions	D	W	H																										
Overall	32	40	44 ½																												
Seat	20	30	18																												
Arm		10	25																												
Upholstery		Shipping																													
COM Ydg	6	Ctn Wt	125																												
COL Sq Ft	138	Cu Ft	33																												
 CTL1303WR right  CTL1303WL left			<table border="1"> <tbody> <tr><td>COM</td><td>\$2,954</td></tr> <tr><td>A</td><td>\$3,084</td></tr> <tr><td>B</td><td>\$3,256</td></tr> <tr><td>COL/C</td><td>\$3,554</td></tr> <tr><td>D</td><td>\$3,940</td></tr> <tr><td>E</td><td>\$4,324</td></tr> <tr><td>F</td><td>\$4,924</td></tr> <tr><td>G</td><td>\$5,566</td></tr> <tr><td>H</td><td>\$6,252</td></tr> <tr><td>I</td><td>\$7,320</td></tr> <tr><td>J</td><td>\$8,603</td></tr> <tr><td>L1</td><td>\$6,549</td></tr> <tr><td>L2</td><td>\$7,444</td></tr> </tbody> </table>	COM	\$2,954	A	\$3,084	B	\$3,256	COL/C	\$3,554	D	\$3,940	E	\$4,324	F	\$4,924	G	\$5,566	H	\$6,252	I	\$7,320	J	\$8,603	L1	\$6,549	L2	\$7,444		
COM	\$2,954																														
A	\$3,084																														
B	\$3,256																														
COL/C	\$3,554																														
D	\$3,940																														
E	\$4,324																														
F	\$4,924																														
G	\$5,566																														
H	\$6,252																														
I	\$7,320																														
J	\$8,603																														
L1	\$6,549																														
L2	\$7,444																														
Single Seat High Back with Stand Up Surface	CTL1304WR CTL1304WL <ul style="list-style-type: none"> · wood cap arm · stand up surface corner; specify square (S) no upcharge or rounded (R) add \$49 list · 10" arm width · 30" seat width · 7" high headrest · 41 ¾" high stand up surface · COM based on single fabric · multiple fabrics, see pages CT6-CT8 for yardage requirements · double cut veneer available; specify and add \$163 list 	<table border="1"> <thead> <tr> <th>Dimensions</th> <th>D</th> <th>W</th> <th>H</th> </tr> </thead> <tbody> <tr> <td>Overall</td> <td>42</td> <td>40</td> <td>44 ½</td> </tr> <tr> <td>Seat</td> <td>20</td> <td>30</td> <td>18</td> </tr> <tr> <td>Arm</td> <td></td> <td>10</td> <td>25</td> </tr> </tbody> </table>	Dimensions	D	W	H	Overall	42	40	44 ½	Seat	20	30	18	Arm		10	25	<table border="1"> <thead> <tr> <th colspan="2">Upholstery</th> <th colspan="2">Shipping</th> </tr> </thead> <tbody> <tr> <td>COM Ydg</td> <td>6</td> <td>Ctn Wt</td> <td>163</td> </tr> <tr> <td>COL Sq Ft</td> <td>138</td> <td>Cu Ft</td> <td>43</td> </tr> </tbody> </table>	Upholstery		Shipping		COM Ydg	6	Ctn Wt	163	COL Sq Ft	138	Cu Ft	43
		Dimensions	D	W	H																										
Overall	42	40	44 ½																												
Seat	20	30	18																												
Arm		10	25																												
Upholstery		Shipping																													
COM Ydg	6	Ctn Wt	163																												
COL Sq Ft	138	Cu Ft	43																												
 CTL1304WR right  CTL1304WL left			<table border="1"> <tbody> <tr><td>COM</td><td>\$4,130</td></tr> <tr><td>A</td><td>\$4,280</td></tr> <tr><td>B</td><td>\$4,451</td></tr> <tr><td>COL/C</td><td>\$4,750</td></tr> <tr><td>D</td><td>\$5,136</td></tr> <tr><td>E</td><td>\$5,521</td></tr> <tr><td>F</td><td>\$6,120</td></tr> <tr><td>G</td><td>\$6,762</td></tr> <tr><td>H</td><td>\$7,443</td></tr> <tr><td>I</td><td>\$8,515</td></tr> <tr><td>J</td><td>\$9,799</td></tr> <tr><td>L1</td><td>\$7,746</td></tr> <tr><td>L2</td><td>\$8,643</td></tr> </tbody> </table>	COM	\$4,130	A	\$4,280	B	\$4,451	COL/C	\$4,750	D	\$5,136	E	\$5,521	F	\$6,120	G	\$6,762	H	\$7,443	I	\$8,515	J	\$9,799	L1	\$7,746	L2	\$8,643		
COM	\$4,130																														
A	\$4,280																														
B	\$4,451																														
COL/C	\$4,750																														
D	\$5,136																														
E	\$5,521																														
F	\$6,120																														
G	\$6,762																														
H	\$7,443																														
I	\$8,515																														
J	\$9,799																														
L1	\$7,746																														
L2	\$8,643																														
Single Seat Privacy Back	CTL1305UR CTL1305UL <ul style="list-style-type: none"> · upholstered arm · 10" arm width · 30" seat width · 14" high headrest · COM based on single fabric · multiple fabrics, see pages CT6-CT8 for yardage requirements · double cut veneer available; specify and add \$128 list 	<table border="1"> <thead> <tr> <th>Dimensions</th> <th>D</th> <th>W</th> <th>H</th> </tr> </thead> <tbody> <tr> <td>Overall</td> <td>32</td> <td>40</td> <td>51 ½</td> </tr> <tr> <td>Seat</td> <td>20</td> <td>30</td> <td>18</td> </tr> <tr> <td>Arm</td> <td></td> <td>10</td> <td>24 ½</td> </tr> </tbody> </table>	Dimensions	D	W	H	Overall	32	40	51 ½	Seat	20	30	18	Arm		10	24 ½	<table border="1"> <thead> <tr> <th colspan="2">Upholstery</th> <th colspan="2">Shipping</th> </tr> </thead> <tbody> <tr> <td>COM Ydg</td> <td>6 ½</td> <td>Ctn Wt</td> <td>123</td> </tr> <tr> <td>COL Sq Ft</td> <td>150</td> <td>Cu Ft</td> <td>38</td> </tr> </tbody> </table>	Upholstery		Shipping		COM Ydg	6 ½	Ctn Wt	123	COL Sq Ft	150	Cu Ft	38
		Dimensions	D	W	H																										
Overall	32	40	51 ½																												
Seat	20	30	18																												
Arm		10	24 ½																												
Upholstery		Shipping																													
COM Ydg	6 ½	Ctn Wt	123																												
COL Sq Ft	150	Cu Ft	38																												
 CTL1305UR right  CTL1305UL left			<table border="1"> <tbody> <tr><td>COM</td><td>\$2,955</td></tr> <tr><td>A</td><td>\$3,093</td></tr> <tr><td>B</td><td>\$3,277</td></tr> <tr><td>COL/C</td><td>\$3,601</td></tr> <tr><td>D</td><td>\$4,021</td></tr> <tr><td>E</td><td>\$4,438</td></tr> <tr><td>F</td><td>\$5,087</td></tr> <tr><td>G</td><td>\$5,781</td></tr> <tr><td>H</td><td>\$6,525</td></tr> <tr><td>I</td><td>\$7,680</td></tr> <tr><td>J</td><td>\$9,070</td></tr> <tr><td>L1</td><td>\$6,847</td></tr> <tr><td>L2</td><td>\$7,819</td></tr> </tbody> </table>	COM	\$2,955	A	\$3,093	B	\$3,277	COL/C	\$3,601	D	\$4,021	E	\$4,438	F	\$5,087	G	\$5,781	H	\$6,525	I	\$7,680	J	\$9,070	L1	\$6,847	L2	\$7,819		
COM	\$2,955																														
A	\$3,093																														
B	\$3,277																														
COL/C	\$3,601																														
D	\$4,021																														
E	\$4,438																														
F	\$5,087																														
G	\$5,781																														
H	\$6,525																														
I	\$7,680																														
J	\$9,070																														
L1	\$6,847																														
L2	\$7,819																														

CONNECT

Description	Model	Specifications			List Price Per Grade		
		Dimensions	D	W	H	COM	
Single Seat Privacy Back with Stand Up Surface	CTL1306UR	Overall	42	40	51 ½	COM	\$4,132
	CTL1306UL	Seat	20	30	18	A	\$4,289
 CTL1306UR right	<ul style="list-style-type: none"> · upholstered arm · stand up surface corner; specify square (S) no upcharge or rounded (R) add \$49 list · 10" arm width · 30" seat width · 14" high headrest · 41 ¾" high stand up surface · COM based on single fabric · multiple fabrics, see pages CT6-CT8 for yardage requirements · double cut veneer available; specify and add \$128 list 	Arm		10	24 ½	COL/C	\$4,797
		Upholstery		Shipping		D	\$5,217
 CTL1306UL left		COM Ydg	6 ½	Ctn Wt	161	E	\$5,634
		COL Sq Ft	150	Cu Ft	48	F	\$6,282
						G	\$6,978
						H	\$7,718
						I	\$8,878
						J	\$10,267
						L1	\$8,044
						L2	\$9,016

Description	Model	Specifications			List Price Per Grade		
		Dimensions	D	W	H	COM	
Single Seat Privacy Back	CTL1305WR	Overall	32	40	51 ½	COM	\$3,144
	CTL1305WL	Seat	20	30	18	A	\$3,286
 CTL1305WR right	<ul style="list-style-type: none"> · wood cap arm · 10" arm width · 30" seat width · 14" high headrest · COM based on single fabric · multiple fabrics, see pages CT6-CT8 for yardage requirements · double cut veneer available; specify and add \$163 list 	Arm		10	25	COL/C	\$3,794
		Upholstery		Shipping		D	\$4,212
 CTL1305WL left		COM Ydg	6 ½	Ctn Wt	128	E	\$4,629
		COL Sq Ft	150	Cu Ft	38	F	\$5,279
						G	\$5,973
						H	\$6,713
						I	\$7,874
						J	\$9,264
						L1	\$7,039
						L2	\$8,013

To Order, Specify:

- 1 Model Number
- 2 Wood Species - Cherry (CH1), Maple (MA1), Walnut (WA1) or Double Cut (DC1)
- 3 Wood Finish [See Wood Finish Options](#)
- 4 Laminate Color Selection (Stand Up Surface) [See Laminate Color Selection](#)
- 5 Surface Corners (Stand Up Surface) - Square (S), no upcharge or Rounded (R), add \$49 list
- 6 Fabric Selection - vendor, pattern and color
 - A. Seat
 - B. Back
 - C. Arm
 - D. Headrest

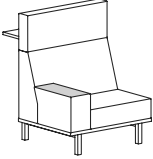





Visit www.jsifurniture.com/finishes-and-materials/textiles for our textiles program.
See selection of standard and graded in manufacturers and patterns.
- 7 Metal Leg Color - [See Metal Leg Color Options](#)
- 8 Optional Power Center - Flush Mount (EC22) - Black (B) or White (W); \$583 list each, see page CT3 for location availability
- 9 Arm Cap - Wood (M) or Black 3D Laminate (B3L)
- 10 Optional Drink Holder (DH) - add \$120 list each
- 11 Optional Tablet Arm - indicate left (TBL) or right arm (TBR); flat cut add \$663 list, double cut add \$691 list
- 12 Optional Coordinating Wood Grain Laminate Available on Wood Cap Arm - no upcharge. Finishes with an asterisk have a coordinating laminate available.
- 13 Optional Rubber Cushion Nylon Glides - no upcharge

Specifications

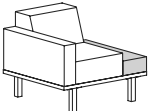
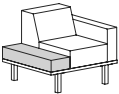
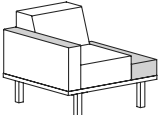
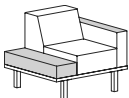
- Wood species - Cherry, Maple, Walnut or Double Cut. Seat has synthetic sheet webbing with cross strap reinforcement, 4 ¼" high density polyurethane foam.
- Back has high density polyurethane foam.
- Arms have ¾" thick top and ¼" thick side high density polyurethane foam.
- Plywood construction with locking tenons, glue and screws.
- Linking bracket included.
- Metal legs are 16 gauge steel tube with metal leveling glides.
- ¾" thick 10" deep laminate stand up surface with coordinating 3mm PVC edge supported by steel columns, 42" surface height.

Connect Modular Lounge



Description	① Model	Specifications	List Price Per Grade																										
Single Seat Privacy Back with Stand Up Surface	CTL1306WR CTL1306WL <ul style="list-style-type: none"> · wood cap arm · stand up surface corner; specify square (S) no upcharge or rounded (R) add \$49 list · 10" arm width · 30" seat width · 14" high headrest · 41 ¾" high stand up surface · COM based on single fabric · multiple fabrics, see pages CT6-CT8 for yardage requirements · double cut veneer available; specify and add \$163 list 	<table border="1"> <thead> <tr> <th>Dimensions</th> <th>D</th> <th>W</th> <th>H</th> </tr> </thead> <tbody> <tr> <td>Overall</td> <td>42</td> <td>40</td> <td>51 ½</td> </tr> <tr> <td>Seat</td> <td>20</td> <td>30</td> <td>18</td> </tr> <tr> <td>Arm</td> <td></td> <td>10</td> <td>25</td> </tr> </tbody> </table>	Dimensions	D	W	H	Overall	42	40	51 ½	Seat	20	30	18	Arm		10	25	<table border="1"> <thead> <tr> <th>Upholstery</th> <th>Shipping</th> </tr> </thead> <tbody> <tr> <td>COM Ydg</td> <td>6 ½ Ctn Wt 166</td> </tr> <tr> <td>COL Sq Ft</td> <td>150 Cu Ft 48</td> </tr> </tbody> </table>	Upholstery	Shipping	COM Ydg	6 ½ Ctn Wt 166	COL Sq Ft	150 Cu Ft 48				
		Dimensions	D	W	H																								
Overall	42	40	51 ½																										
Seat	20	30	18																										
Arm		10	25																										
Upholstery	Shipping																												
COM Ydg	6 ½ Ctn Wt 166																												
COL Sq Ft	150 Cu Ft 48																												
 CTL1306WR right  CTL1306WL left			<table border="1"> <tbody> <tr><td>COM</td><td>\$4,323</td></tr> <tr><td>A</td><td>\$4,484</td></tr> <tr><td>B</td><td>\$4,668</td></tr> <tr><td>COL/C</td><td>\$4,991</td></tr> <tr><td>D</td><td>\$5,411</td></tr> <tr><td>E</td><td>\$5,826</td></tr> <tr><td>F</td><td>\$6,475</td></tr> <tr><td>G</td><td>\$7,169</td></tr> <tr><td>H</td><td>\$7,910</td></tr> <tr><td>I</td><td>\$9,069</td></tr> <tr><td>J</td><td>\$10,461</td></tr> <tr><td>L1</td><td>\$8,236</td></tr> <tr><td>L2</td><td>\$9,210</td></tr> </tbody> </table>	COM	\$4,323	A	\$4,484	B	\$4,668	COL/C	\$4,991	D	\$5,411	E	\$5,826	F	\$6,475	G	\$7,169	H	\$7,910	I	\$9,069	J	\$10,461	L1	\$8,236	L2	\$9,210
COM	\$4,323																												
A	\$4,484																												
B	\$4,668																												
COL/C	\$4,991																												
D	\$5,411																												
E	\$5,826																												
F	\$6,475																												
G	\$7,169																												
H	\$7,910																												
I	\$9,069																												
J	\$10,461																												
L1	\$8,236																												
L2	\$9,210																												
Single Seat Low Back	CTL1201CR CTL1201CL <ul style="list-style-type: none"> · 20" seat width · 10" table width · COM based on single fabric · multiple fabrics, see pages CT6-CT8 for yardage requirements · double cut veneer available; specify and add \$191 list 	<table border="1"> <thead> <tr> <th>Dimensions</th> <th>D</th> <th>W</th> <th>H</th> </tr> </thead> <tbody> <tr> <td>Overall</td> <td>32</td> <td>30</td> <td>30 ½</td> </tr> <tr> <td>Seat</td> <td>20</td> <td>20</td> <td>18</td> </tr> </tbody> </table>	Dimensions	D	W	H	Overall	32	30	30 ½	Seat	20	20	18	<table border="1"> <thead> <tr> <th>Upholstery</th> <th>Shipping</th> </tr> </thead> <tbody> <tr> <td>COM Ydg</td> <td>3 ½ Ctn Wt 82</td> </tr> <tr> <td>COL Sq Ft</td> <td>81 Cu Ft 16</td> </tr> </tbody> </table>	Upholstery	Shipping	COM Ydg	3 ½ Ctn Wt 82	COL Sq Ft	81 Cu Ft 16								
		Dimensions	D	W	H																								
Overall	32	30	30 ½																										
Seat	20	20	18																										
Upholstery	Shipping																												
COM Ydg	3 ½ Ctn Wt 82																												
COL Sq Ft	81 Cu Ft 16																												
 CTL1201CR right  CTL1201CL left			<table border="1"> <tbody> <tr><td>COM</td><td>\$2,302</td></tr> <tr><td>A</td><td>\$2,386</td></tr> <tr><td>B</td><td>\$2,489</td></tr> <tr><td>COL/C</td><td>\$2,660</td></tr> <tr><td>D</td><td>\$2,886</td></tr> <tr><td>E</td><td>\$3,111</td></tr> <tr><td>F</td><td>\$3,461</td></tr> <tr><td>G</td><td>\$3,833</td></tr> <tr><td>H</td><td>\$4,233</td></tr> <tr><td>I</td><td>\$4,857</td></tr> <tr><td>J</td><td>\$5,607</td></tr> <tr><td>L1</td><td>\$4,407</td></tr> <tr><td>L2</td><td>\$4,934</td></tr> </tbody> </table>	COM	\$2,302	A	\$2,386	B	\$2,489	COL/C	\$2,660	D	\$2,886	E	\$3,111	F	\$3,461	G	\$3,833	H	\$4,233	I	\$4,857	J	\$5,607	L1	\$4,407	L2	\$4,934
COM	\$2,302																												
A	\$2,386																												
B	\$2,489																												
COL/C	\$2,660																												
D	\$2,886																												
E	\$3,111																												
F	\$3,461																												
G	\$3,833																												
H	\$4,233																												
I	\$4,857																												
J	\$5,607																												
L1	\$4,407																												
L2	\$4,934																												
Single Seat Low Back	CTL1301CR CTL1301CL <ul style="list-style-type: none"> · 30" seat width · 10" table width · COM based on single fabric · multiple fabrics, see pages CT6-CT8 for yardage requirements · double cut veneer available; specify and add \$191 list 	<table border="1"> <thead> <tr> <th>Dimensions</th> <th>D</th> <th>W</th> <th>H</th> </tr> </thead> <tbody> <tr> <td>Overall</td> <td>32</td> <td>40</td> <td>30 ½</td> </tr> <tr> <td>Seat</td> <td>20</td> <td>30</td> <td>18</td> </tr> </tbody> </table>	Dimensions	D	W	H	Overall	32	40	30 ½	Seat	20	30	18	<table border="1"> <thead> <tr> <th>Upholstery</th> <th>Shipping</th> </tr> </thead> <tbody> <tr> <td>COM Ydg</td> <td>3 ½ Ctn Wt 93</td> </tr> <tr> <td>COL Sq Ft</td> <td>81 Cu Ft 21</td> </tr> </tbody> </table>	Upholstery	Shipping	COM Ydg	3 ½ Ctn Wt 93	COL Sq Ft	81 Cu Ft 21								
		Dimensions	D	W	H																								
Overall	32	40	30 ½																										
Seat	20	30	18																										
Upholstery	Shipping																												
COM Ydg	3 ½ Ctn Wt 93																												
COL Sq Ft	81 Cu Ft 21																												
 CTL1301CR right  CTL1301CL left			<table border="1"> <tbody> <tr><td>COM</td><td>\$2,443</td></tr> <tr><td>A</td><td>\$2,531</td></tr> <tr><td>B</td><td>\$2,628</td></tr> <tr><td>COL/C</td><td>\$2,805</td></tr> <tr><td>D</td><td>\$3,028</td></tr> <tr><td>E</td><td>\$3,254</td></tr> <tr><td>F</td><td>\$3,601</td></tr> <tr><td>G</td><td>\$3,977</td></tr> <tr><td>H</td><td>\$4,376</td></tr> <tr><td>I</td><td>\$5,001</td></tr> <tr><td>J</td><td>\$5,750</td></tr> <tr><td>L1</td><td>\$4,553</td></tr> <tr><td>L2</td><td>\$5,075</td></tr> </tbody> </table>	COM	\$2,443	A	\$2,531	B	\$2,628	COL/C	\$2,805	D	\$3,028	E	\$3,254	F	\$3,601	G	\$3,977	H	\$4,376	I	\$5,001	J	\$5,750	L1	\$4,553	L2	\$5,075
COM	\$2,443																												
A	\$2,531																												
B	\$2,628																												
COL/C	\$2,805																												
D	\$3,028																												
E	\$3,254																												
F	\$3,601																												
G	\$3,977																												
H	\$4,376																												
I	\$5,001																												
J	\$5,750																												
L1	\$4,553																												
L2	\$5,075																												

CONNECT

Description	Model	Specifications			List Price Per Grade		
		Dimensions	D	W	H	COM	
Single Seat Low Back  CTL1201URCL right  CTL1201ULCR left	CTL1201URCL CTL1201ULCR <ul style="list-style-type: none"> · upholstered arm · 5" arm width · 20" seat width · 10" table width · COM based on single fabric · multiple fabrics, see pages CT6-CT8 for yardage requirements · double cut veneer available; specify and add \$191 list 	Overall	32	35	30½	COM	\$2,920
		Seat	20	20	18	COL/C	\$3,427
		Arm		5	24½	D	\$3,748
		Upholstery		Shipping		E	\$4,070
		COM Ydg	5	Ctn Wt	85	F	\$4,567
		COL Sq Ft	115	Cu Ft	19	G	\$5,102
						H	\$5,675
						I	\$6,565
						J	\$7,636
						L1	\$5,925
						L2	\$6,671
Single Seat Low Back  CTL1201WRCL right  CTL1201WLCR left	CTL1201WRCL CTL1201WLCR <ul style="list-style-type: none"> · wood cap arm · 5" arm width · 20" seat width · 10" table width · COM based on single fabric · multiple fabrics, see pages CT6-CT8 for yardage requirements · double cut veneer available; specify and add \$212 list 	Overall	32	35	30½	COM	\$3,109
		Seat	20	20	18	COL/C	\$3,622
		Arm		5	25	D	\$3,941
		Upholstery		Shipping		E	\$4,260
		COM Ydg	5	Ctn Wt	89	F	\$4,762
		COL Sq Ft	115	Cu Ft	19	G	\$5,295
						H	\$5,867
						I	\$6,758
						J	\$7,827
						L1	\$6,115
						L2	\$6,864

To Order, Specify:

- 1 Model Number
- 2 Wood Species - Cherry (CH1), Maple (MA1), Walnut (WA1) or Double Cut (DC1)
- 3 Wood Finish See [Wood Finish Options](#)
- 4 Laminate Color Selection (Stand Up Surface) See [Laminate Color Selection](#)
- 5 Surface Corners (Stand Up Surface) - Square (S), no upcharge or Rounded (R), add \$49 list
- 6 Fabric Selection - vendor, pattern and color
 - A. Seat
 - B. Back
 - C. Arm
 - D. Headrest
 Visit www.jsifurniture.com/finishes-and-materials/textiles for our textiles program.
 See selection of standard and graded in manufacturers and patterns.
- 7 Metal Leg Color - See [Metal Leg Color Options](#)
- 8 Optional Power Center - Flush Mount (EC22) - Black (B) or White (W); \$583 list each, see page CT3 for location availability
- 9 Arm Cap - Wood (M) or Black 3D Laminate (B3L)
- 10 Optional Drink Holder (DH) - add \$120 list each
- 11 Optional Tablet Arm - indicate left (TBL) or right arm (TBR); flat cut add \$663 list, double cut add \$691 list
- 12 Optional Coordinating Wood Grain Laminate Available on Wood Cap Arm - no upcharge. Finishes with an asterisk have a coordinating laminate available.
- 13 Optional Rubber Cushion Nylon Glides - no upcharge

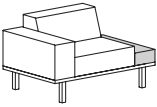

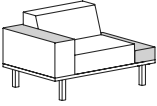
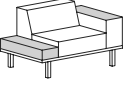
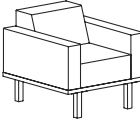
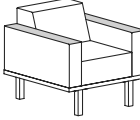
Specifications

- Wood species - Cherry, Maple, Walnut or Double Cut. Seat has synthetic sheet webbing with cross strap reinforcement, 4 ¼" high density polyurethane foam.
- Back has high density polyurethane foam.
- Arms have ¾" thick top and ¼" thick side high density polyurethane foam.
- Plywood construction with locking tenons, glue and screws.
- Linking bracket included.
- Metal legs are 16 gauge steel tube with metal leveling glides.
- ¾" thick 10" deep laminate stand up surface with coordinating 3mm PVC edge supported by steel columns, 42" surface height.

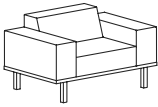
CONNECT

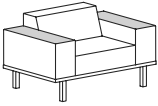
Connect Modular Lounge



Description	① Model	Specifications	List Price Per Grade																												
Single Seat Low Back	CTL1301URCL CTL1301ULCR <ul style="list-style-type: none"> · upholstered arm · 10" arm width · 30" seat width · 10" table width · COM based on single fabric · multiple fabrics, see pages CT6-CT8 for yardage requirements · double cut veneer available; specify and add \$191 list 	<table border="1"> <thead> <tr> <th>Dimensions</th> <th>D</th> <th>W</th> <th>H</th> </tr> </thead> <tbody> <tr> <td>Overall</td> <td>32</td> <td>50</td> <td>30 ½</td> </tr> <tr> <td>Seat</td> <td>20</td> <td>30</td> <td>18</td> </tr> <tr> <td>Arm</td> <td></td> <td>10</td> <td>24 ½</td> </tr> </tbody> </table>	Dimensions	D	W	H	Overall	32	50	30 ½	Seat	20	30	18	Arm		10	24 ½	<table border="1"> <thead> <tr> <th colspan="2">Upholstery</th> <th colspan="2">Shipping</th> </tr> </thead> <tbody> <tr> <td>COM Ydg</td> <td>5</td> <td>Ctn Wt</td> <td>120</td> </tr> <tr> <td>COL Sq Ft</td> <td>115</td> <td>Cu Ft</td> <td>26</td> </tr> </tbody> </table>	Upholstery		Shipping		COM Ydg	5	Ctn Wt	120	COL Sq Ft	115	Cu Ft	26
		Dimensions	D	W	H																										
Overall	32	50	30 ½																												
Seat	20	30	18																												
Arm		10	24 ½																												
Upholstery		Shipping																													
COM Ydg	5	Ctn Wt	120																												
COL Sq Ft	115	Cu Ft	26																												
 CTL1301URCL right  CTL1301ULCR left			COM \$3,103 A \$3,225 B \$3,369 COL/C \$3,617 D \$3,936 E \$4,257 F \$4,756 G \$5,291 H \$5,863 I \$6,751 J \$7,824 L1 \$6,112 L2 \$6,859																												
Single Seat Low Back	CTL1301WRCL CTL1301WLCR <ul style="list-style-type: none"> · wood cap arm · 10" arm width · 30" seat width · 10" table width · COM based on single fabric · multiple fabrics, see pages CT6-CT8 for yardage requirements · double cut veneer available; specify and add \$212 list 	<table border="1"> <thead> <tr> <th>Dimensions</th> <th>D</th> <th>W</th> <th>H</th> </tr> </thead> <tbody> <tr> <td>Overall</td> <td>32</td> <td>50</td> <td>30 ½</td> </tr> <tr> <td>Seat</td> <td>20</td> <td>30</td> <td>18</td> </tr> <tr> <td>Arm</td> <td></td> <td>10</td> <td>25</td> </tr> </tbody> </table>	Dimensions	D	W	H	Overall	32	50	30 ½	Seat	20	30	18	Arm		10	25	<table border="1"> <thead> <tr> <th colspan="2">Upholstery</th> <th colspan="2">Shipping</th> </tr> </thead> <tbody> <tr> <td>COM Ydg</td> <td>5</td> <td>Ctn Wt</td> <td>125</td> </tr> <tr> <td>COL Sq Ft</td> <td>115</td> <td>Cu Ft</td> <td>26</td> </tr> </tbody> </table>	Upholstery		Shipping		COM Ydg	5	Ctn Wt	125	COL Sq Ft	115	Cu Ft	26
		Dimensions	D	W	H																										
Overall	32	50	30 ½																												
Seat	20	30	18																												
Arm		10	25																												
Upholstery		Shipping																													
COM Ydg	5	Ctn Wt	125																												
COL Sq Ft	115	Cu Ft	26																												
 CTL1301WRCL right  CTL1301WLCR left			COM \$3,297 A \$3,419 B \$3,561 COL/C \$3,812 D \$4,130 E \$4,451 F \$4,951 G \$5,486 H \$6,054 I \$6,947 J \$8,016 L1 \$6,305 L2 \$7,056																												
Single Seat Low Back	CTL1201U2 <ul style="list-style-type: none"> · upholstered arms · 5" arm width · 20" seat width · COM based on single fabric · multiple fabrics, see pages CT6-CT8 for yardage requirements · double cut veneer available; specify and add \$128 list 	<table border="1"> <thead> <tr> <th>Dimensions</th> <th>D</th> <th>W</th> <th>H</th> </tr> </thead> <tbody> <tr> <td>Overall</td> <td>32</td> <td>30</td> <td>30 ½</td> </tr> <tr> <td>Seat</td> <td>20</td> <td>20</td> <td>18</td> </tr> <tr> <td>Arm</td> <td></td> <td>5</td> <td>24 ½</td> </tr> </tbody> </table>	Dimensions	D	W	H	Overall	32	30	30 ½	Seat	20	20	18	Arm		5	24 ½	<table border="1"> <thead> <tr> <th colspan="2">Upholstery</th> <th colspan="2">Shipping</th> </tr> </thead> <tbody> <tr> <td>COM Ydg</td> <td>6 ½</td> <td>Ctn Wt</td> <td>76</td> </tr> <tr> <td>COL Sq Ft</td> <td>150</td> <td>Cu Ft</td> <td>16</td> </tr> </tbody> </table>	Upholstery		Shipping		COM Ydg	6 ½	Ctn Wt	76	COL Sq Ft	150	Cu Ft	16
		Dimensions	D	W	H																										
Overall	32	30	30 ½																												
Seat	20	20	18																												
Arm		5	24 ½																												
Upholstery		Shipping																													
COM Ydg	6 ½	Ctn Wt	76																												
COL Sq Ft	150	Cu Ft	16																												
			COM \$2,807 A \$2,942 B \$3,129 COL/C \$3,452 D \$3,870 E \$4,287 F \$4,936 G \$5,633 H \$6,373 I \$7,531 J \$8,922 L1 \$6,698 L2 \$7,672																												
Single Seat Low Back	CTL1201W2 <ul style="list-style-type: none"> · wood cap arms · 5" arm width · 20" seat width · COM based on single fabric · multiple fabrics, see pages CT6-CT8 for yardage requirements · double cut veneer available; specify and add \$191 list 	<table border="1"> <thead> <tr> <th>Dimensions</th> <th>D</th> <th>W</th> <th>H</th> </tr> </thead> <tbody> <tr> <td>Overall</td> <td>32</td> <td>30</td> <td>30 ½</td> </tr> <tr> <td>Seat</td> <td>20</td> <td>20</td> <td>18</td> </tr> <tr> <td>Arm</td> <td></td> <td>5</td> <td>25</td> </tr> </tbody> </table>	Dimensions	D	W	H	Overall	32	30	30 ½	Seat	20	20	18	Arm		5	25	<table border="1"> <thead> <tr> <th colspan="2">Upholstery</th> <th colspan="2">Shipping</th> </tr> </thead> <tbody> <tr> <td>COM Ydg</td> <td>6 ½</td> <td>Ctn Wt</td> <td>81</td> </tr> <tr> <td>COL Sq Ft</td> <td>150</td> <td>Cu Ft</td> <td>16</td> </tr> </tbody> </table>	Upholstery		Shipping		COM Ydg	6 ½	Ctn Wt	81	COL Sq Ft	150	Cu Ft	16
		Dimensions	D	W	H																										
Overall	32	30	30 ½																												
Seat	20	20	18																												
Arm		5	25																												
Upholstery		Shipping																													
COM Ydg	6 ½	Ctn Wt	81																												
COL Sq Ft	150	Cu Ft	16																												
			COM \$3,190 A \$3,332 B \$3,517 COL/C \$3,841 D \$4,258 E \$4,679 F \$5,325 G \$6,020 H \$6,762 I \$7,921 J \$9,311 L1 \$7,087 L2 \$8,060																												

CONNECT

Description	Model	Specifications			List Price Per Grade		
		Dimensions	D	W	H	COM	
Single Seat Low Back 	CTL1301U2 <ul style="list-style-type: none"> · upholstered arms · 10" arm width · 30" seat width · COM based on single fabric · multiple fabrics, see pages CT6-CT8 for yardage requirements · double cut veneer available; specify and add \$128 list 	Overall	32	50	30½	COM	\$3,036
		Seat	20	30	18	A	\$3,175
		Arm		10	24½	B	\$3,358
		Upholstery		Shipping		COL/C	\$3,684
		COM Ydg	6½	Ctn Wt	131	D	\$4,103
		COL Sq Ft	150	Cu Ft	26	E	\$4,519
						F	\$5,170
						G	\$5,863
						H	\$6,605
						I	\$7,765
						J	\$9,155
						L1	\$6,929
						L2	\$7,902

Description	Model	Specifications			List Price Per Grade		
		Dimensions	D	W	H	COM	
Single Seat Low Back 	CTL1301W2 <ul style="list-style-type: none"> · wood cap arms · 10" arm width · 30" seat width · COM based on single fabric · multiple fabrics, see pages CT6-CT8 for yardage requirements · double cut veneer available; specify and add \$191 list 	Overall	32	50	30½	COM	\$3,423
		Seat	20	30	18	A	\$3,567
		Arm		10	25	B	\$3,753
		Upholstery		Shipping		COL/C	\$4,075
		COM Ydg	6½	Ctn Wt	141	D	\$4,494
		COL Sq Ft	150	Cu Ft	26	E	\$4,911
						F	\$5,561
						G	\$6,255
						H	\$6,997
						I	\$8,155
						J	\$9,546
						L1	\$7,321
						L2	\$8,295

To Order, Specify:

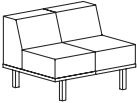
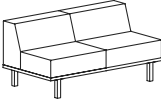
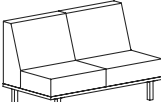
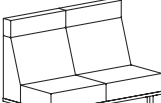
- 1 Model Number
- 2 Wood Species - Cherry (CH1), Maple (MA1), Walnut (WA1) or Double Cut (DC1)
- 3 Wood Finish See [Wood Finish Options](#)
- 4 Fabric Selection - vendor, pattern and color
 - A. Seat
 - B. Back
 - C. Arm(s)
 Visit www.jsifurniture.com/finishes-and-materials/textiles for our textiles program. See selection of standard and graded in manufacturers and patterns.
- 5 Metal Leg Color - See [Metal Leg Color Options](#)
- 6 Optional Wood Back Rail - available on any unit with two arms, specify and add \$192 list
- 7 Optional Power Center - Flush Mount (EC22) - Black (B) or White (W); \$583 list each, see page CT3 for location availability
- 8 Arm Cap - Wood (M) or Black 3D Laminate (B3L)
- 9 Optional Drink Holder(s) (DH) - add \$120 list each, indicate left or right arm; add \$240 list for end table
- 10 Optional Tablet Arm - indicate left (TBL) or right arm (TBR); flat cut add \$663 list, double cut add \$691 list
- 11 Optional Coordinating Wood Grain Laminate Available on Wood Cap Arm or Table Top - no upcharge. Finishes with an asterisk have a coordinating laminate available
- 12 Optional Rubber Cushion Nylon Glides - no upcharge

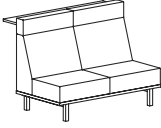
Specifications

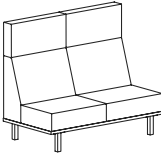
- Wood species - Cherry, Maple, Walnut or Double Cut. Seat has synthetic sheet webbing with cross strap reinforcement, 4 ¼" high density polyurethane foam.
- Back has high density polyurethane foam.
- Arms have ¾" thick top and ¼" thick side high density polyurethane foam.
- Plywood construction with locking tenons, glue and screws.
- Linking bracket included.
- Metal legs are 16 gauge steel tube with metal leveling glides.

Connect Modular Lounge



Description	① Model	Specifications	List Price Per Grade																																			
Two Seat Low Back 	CTL2201 · armless · 20" individual seat width · COM based on single fabric · multiple fabrics, see pages CT6-CT8 for yardage requirements · double cut veneer available; specify and add \$128 list	<table border="1"> <thead> <tr> <th>Dimensions</th> <th>D</th> <th>W</th> <th>H</th> </tr> </thead> <tbody> <tr> <td>Overall</td> <td>32</td> <td>40</td> <td>30 ½</td> </tr> <tr> <td>Seat</td> <td>20</td> <td>40</td> <td>18</td> </tr> </tbody> </table>	Dimensions	D	W	H	Overall	32	40	30 ½	Seat	20	40	18	<table border="1"> <thead> <tr> <th colspan="2">Shipping</th> </tr> </thead> <tbody> <tr> <td>Ctn Wt</td> <td>93</td> </tr> <tr> <td>Cu Ft</td> <td>21</td> </tr> </tbody> </table>	Shipping		Ctn Wt	93	Cu Ft	21																	
		Dimensions	D	W	H																																	
Overall	32	40	30 ½																																			
Seat	20	40	18																																			
Shipping																																						
Ctn Wt	93																																					
Cu Ft	21																																					
<table border="1"> <thead> <tr> <th>Upholstery</th> <th colspan="2">Shipping</th> </tr> </thead> <tbody> <tr> <td>COM Ydg</td> <td>7</td> <td>93</td> </tr> <tr> <td>COL Sq Ft</td> <td>161</td> <td>21</td> </tr> </tbody> </table>			Upholstery	Shipping		COM Ydg	7	93	COL Sq Ft	161	21	<table border="1"> <tbody> <tr><td>COM</td><td>\$3,124</td></tr> <tr><td>A</td><td>\$3,270</td></tr> <tr><td>B</td><td>\$3,472</td></tr> <tr><td>COL/C</td><td>\$3,821</td></tr> <tr><td>D</td><td>\$4,269</td></tr> <tr><td>E</td><td>\$4,718</td></tr> <tr><td>F</td><td>\$5,418</td></tr> <tr><td>G</td><td>\$6,166</td></tr> <tr><td>H</td><td>\$6,965</td></tr> <tr><td>I</td><td>\$8,211</td></tr> <tr><td>J</td><td>\$9,709</td></tr> <tr><td>L1</td><td>\$7,315</td></tr> <tr><td>L2</td><td>\$8,361</td></tr> </tbody> </table>	COM	\$3,124	A	\$3,270	B	\$3,472	COL/C	\$3,821	D	\$4,269	E	\$4,718	F	\$5,418	G	\$6,166	H	\$6,965	I	\$8,211	J	\$9,709	L1	\$7,315	L2	\$8,361
Upholstery	Shipping																																					
COM Ydg	7	93																																				
COL Sq Ft	161	21																																				
COM	\$3,124																																					
A	\$3,270																																					
B	\$3,472																																					
COL/C	\$3,821																																					
D	\$4,269																																					
E	\$4,718																																					
F	\$5,418																																					
G	\$6,166																																					
H	\$6,965																																					
I	\$8,211																																					
J	\$9,709																																					
L1	\$7,315																																					
L2	\$8,361																																					
Two Seat Low Back 	CTL2301 · armless · 30" individual seat width · COM based on single fabric · multiple fabrics, see pages CT6-CT8 for yardage requirements · double cut veneer available; specify and add \$128 list	<table border="1"> <thead> <tr> <th>Dimensions</th> <th>D</th> <th>W</th> <th>H</th> </tr> </thead> <tbody> <tr> <td>Overall</td> <td>32</td> <td>60</td> <td>30 ½</td> </tr> <tr> <td>Seat</td> <td>20</td> <td>60</td> <td>18</td> </tr> </tbody> </table>	Dimensions	D	W	H	Overall	32	60	30 ½	Seat	20	60	18	<table border="1"> <thead> <tr> <th colspan="2">Shipping</th> </tr> </thead> <tbody> <tr> <td>Ctn Wt</td> <td>138</td> </tr> <tr> <td>Cu Ft</td> <td>31</td> </tr> </tbody> </table>	Shipping		Ctn Wt	138	Cu Ft	31																	
		Dimensions	D	W	H																																	
Overall	32	60	30 ½																																			
Seat	20	60	18																																			
Shipping																																						
Ctn Wt	138																																					
Cu Ft	31																																					
<table border="1"> <thead> <tr> <th>Upholstery</th> <th colspan="2">Shipping</th> </tr> </thead> <tbody> <tr> <td>COM Ydg</td> <td>7</td> <td>138</td> </tr> <tr> <td>COL Sq Ft</td> <td>161</td> <td>31</td> </tr> </tbody> </table>			Upholstery	Shipping		COM Ydg	7	138	COL Sq Ft	161	31	<table border="1"> <tbody> <tr><td>COM</td><td>\$3,422</td></tr> <tr><td>A</td><td>\$3,573</td></tr> <tr><td>B</td><td>\$3,774</td></tr> <tr><td>COL/C</td><td>\$4,122</td></tr> <tr><td>D</td><td>\$4,569</td></tr> <tr><td>E</td><td>\$5,020</td></tr> <tr><td>F</td><td>\$5,720</td></tr> <tr><td>G</td><td>\$6,467</td></tr> <tr><td>H</td><td>\$7,267</td></tr> <tr><td>I</td><td>\$8,515</td></tr> <tr><td>J</td><td>\$10,012</td></tr> <tr><td>L1</td><td>\$7,617</td></tr> <tr><td>L2</td><td>\$8,665</td></tr> </tbody> </table>	COM	\$3,422	A	\$3,573	B	\$3,774	COL/C	\$4,122	D	\$4,569	E	\$5,020	F	\$5,720	G	\$6,467	H	\$7,267	I	\$8,515	J	\$10,012	L1	\$7,617	L2	\$8,665
Upholstery	Shipping																																					
COM Ydg	7	138																																				
COL Sq Ft	161	31																																				
COM	\$3,422																																					
A	\$3,573																																					
B	\$3,774																																					
COL/C	\$4,122																																					
D	\$4,569																																					
E	\$5,020																																					
F	\$5,720																																					
G	\$6,467																																					
H	\$7,267																																					
I	\$8,515																																					
J	\$10,012																																					
L1	\$7,617																																					
L2	\$8,665																																					
Two Seat Mid Back 	CTL2302 · armless · 30" individual seat width · COM based on single fabric · multiple fabrics, see pages CT6-CT8 for yardage requirements · double cut veneer available; specify and add \$128 list	<table border="1"> <thead> <tr> <th>Dimensions</th> <th>D</th> <th>W</th> <th>H</th> </tr> </thead> <tbody> <tr> <td>Overall</td> <td>32</td> <td>60</td> <td>37 ½</td> </tr> <tr> <td>Seat</td> <td>20</td> <td>60</td> <td>18</td> </tr> </tbody> </table>	Dimensions	D	W	H	Overall	32	60	37 ½	Seat	20	60	18	<table border="1"> <thead> <tr> <th colspan="2">Shipping</th> </tr> </thead> <tbody> <tr> <td>Ctn Wt</td> <td>143</td> </tr> <tr> <td>Cu Ft</td> <td>39</td> </tr> </tbody> </table>	Shipping		Ctn Wt	143	Cu Ft	39																	
		Dimensions	D	W	H																																	
Overall	32	60	37 ½																																			
Seat	20	60	18																																			
Shipping																																						
Ctn Wt	143																																					
Cu Ft	39																																					
<table border="1"> <thead> <tr> <th>Upholstery</th> <th colspan="2">Shipping</th> </tr> </thead> <tbody> <tr> <td>COM Ydg</td> <td>7 ½</td> <td>143</td> </tr> <tr> <td>COL Sq Ft</td> <td>173</td> <td>39</td> </tr> </tbody> </table>			Upholstery	Shipping		COM Ydg	7 ½	143	COL Sq Ft	173	39	<table border="1"> <tbody> <tr><td>COM</td><td>\$3,808</td></tr> <tr><td>A</td><td>\$3,973</td></tr> <tr><td>B</td><td>\$4,185</td></tr> <tr><td>COL/C</td><td>\$4,560</td></tr> <tr><td>D</td><td>\$5,042</td></tr> <tr><td>E</td><td>\$5,525</td></tr> <tr><td>F</td><td>\$6,271</td></tr> <tr><td>G</td><td>\$7,073</td></tr> <tr><td>H</td><td>\$7,929</td></tr> <tr><td>I</td><td>\$9,265</td></tr> <tr><td>J</td><td>\$10,871</td></tr> <tr><td>L1</td><td>\$8,303</td></tr> <tr><td>L2</td><td>\$9,426</td></tr> </tbody> </table>	COM	\$3,808	A	\$3,973	B	\$4,185	COL/C	\$4,560	D	\$5,042	E	\$5,525	F	\$6,271	G	\$7,073	H	\$7,929	I	\$9,265	J	\$10,871	L1	\$8,303	L2	\$9,426
Upholstery	Shipping																																					
COM Ydg	7 ½	143																																				
COL Sq Ft	173	39																																				
COM	\$3,808																																					
A	\$3,973																																					
B	\$4,185																																					
COL/C	\$4,560																																					
D	\$5,042																																					
E	\$5,525																																					
F	\$6,271																																					
G	\$7,073																																					
H	\$7,929																																					
I	\$9,265																																					
J	\$10,871																																					
L1	\$8,303																																					
L2	\$9,426																																					
Two Seat High Back 	CTL2303 · armless · 30" individual seat width · COM based on single fabric · multiple fabrics, see pages CT6-CT8 for yardage requirements · double cut veneer available; specify and add \$128 list	<table border="1"> <thead> <tr> <th>Dimensions</th> <th>D</th> <th>W</th> <th>H</th> </tr> </thead> <tbody> <tr> <td>Overall</td> <td>32</td> <td>60</td> <td>44 ½</td> </tr> <tr> <td>Seat</td> <td>20</td> <td>60</td> <td>18</td> </tr> </tbody> </table>	Dimensions	D	W	H	Overall	32	60	44 ½	Seat	20	60	18	<table border="1"> <thead> <tr> <th colspan="2">Shipping</th> </tr> </thead> <tbody> <tr> <td>Ctn Wt</td> <td>160</td> </tr> <tr> <td>Cu Ft</td> <td>48</td> </tr> </tbody> </table>	Shipping		Ctn Wt	160	Cu Ft	48																	
		Dimensions	D	W	H																																	
Overall	32	60	44 ½																																			
Seat	20	60	18																																			
Shipping																																						
Ctn Wt	160																																					
Cu Ft	48																																					
<table border="1"> <thead> <tr> <th>Upholstery</th> <th colspan="2">Shipping</th> </tr> </thead> <tbody> <tr> <td>COM Ydg</td> <td>9</td> <td>160</td> </tr> <tr> <td>COL Sq Ft</td> <td>207</td> <td>48</td> </tr> </tbody> </table>			Upholstery	Shipping		COM Ydg	9	160	COL Sq Ft	207	48	<table border="1"> <tbody> <tr><td>COM</td><td>\$4,190</td></tr> <tr><td>A</td><td>\$4,380</td></tr> <tr><td>B</td><td>\$4,640</td></tr> <tr><td>COL/C</td><td>\$5,089</td></tr> <tr><td>D</td><td>\$5,665</td></tr> <tr><td>E</td><td>\$6,243</td></tr> <tr><td>F</td><td>\$7,141</td></tr> <tr><td>G</td><td>\$8,104</td></tr> <tr><td>H</td><td>\$9,131</td></tr> <tr><td>I</td><td>\$10,736</td></tr> <tr><td>J</td><td>\$12,661</td></tr> <tr><td>L1</td><td>\$9,579</td></tr> <tr><td>L2</td><td>\$10,926</td></tr> </tbody> </table>	COM	\$4,190	A	\$4,380	B	\$4,640	COL/C	\$5,089	D	\$5,665	E	\$6,243	F	\$7,141	G	\$8,104	H	\$9,131	I	\$10,736	J	\$12,661	L1	\$9,579	L2	\$10,926
Upholstery	Shipping																																					
COM Ydg	9	160																																				
COL Sq Ft	207	48																																				
COM	\$4,190																																					
A	\$4,380																																					
B	\$4,640																																					
COL/C	\$5,089																																					
D	\$5,665																																					
E	\$6,243																																					
F	\$7,141																																					
G	\$8,104																																					
H	\$9,131																																					
I	\$10,736																																					
J	\$12,661																																					
L1	\$9,579																																					
L2	\$10,926																																					

Description	Model	Specifications			List Price Per Grade		
		Dimensions	D	W	H	COM	
Two Seat High Back with Stand Up Surface 	CTL2304 • armless • stand up surface corner; specify square (S) no upcharge or rounded (R) add \$49 list • 30" individual seat width • 7" high headrest • 41 3/4" high stand up surface • COM based on single fabric • multiple fabrics, see pages CT6-CT8 for yardage requirements • double cut veneer available; specify and add \$128 list	Overall	42	60	44 1/2	COM	\$5,401
		Seat	20	60	18	COL/C	\$6,316
		Upholstery		Shipping		D	\$6,895
		COM Ydg	9	Ctn Wt	198	E	\$7,474
		COL Sq Ft	207	Cu Ft	58	F	\$8,373
						G	\$9,335
						H	\$10,359
						I	\$11,965
						J	\$13,892
						L1	\$10,810
						L2	\$12,156

Description	Model	Specifications			List Price Per Grade		
		Dimensions	D	W	H	COM	
Two Seat Privacy Back 	CTL2305 • armless • 30" individual seat width • 14" high headrest • COM based on single fabric • multiple fabrics, see pages CT6-CT8 for yardage requirements • double cut veneer available; specify and add \$128 list	Overall	32	60	51 1/2	COM	\$4,573
		Seat	20	60	18	COL/C	\$5,570
		Upholstery		Shipping		D	\$6,212
		COM Ydg	10	Ctn Wt	164	E	\$6,853
		COL Sq Ft	230	Cu Ft	56	F	\$7,853
						G	\$8,921
						H	\$10,063
						I	\$11,845
						J	\$13,986
						L1	\$10,562
						L2	\$12,058

To Order, Specify:

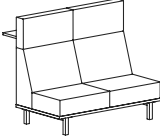
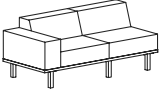
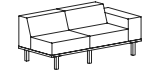
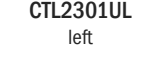
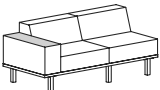
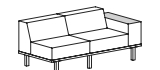
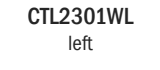
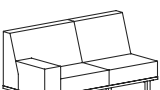


- 1 Model Number
- 2 Wood Species - Cherry (CH1), Maple (MA1), Walnut (WA1) or Double Cut (DC1)
- 3 Wood Finish [See Wood Finish Options](#)
- 4 Laminate Color Selection (Stand Up Surface) [See Laminate Color Selection](#)
- 5 Surface Corners (Stand Up Surface) - Square (S), no upcharge or Rounded (R), add \$49 list
- 6 Fabric Selection - vendor, pattern and color
 - A. Seat
 - B. Back
 - C. Arm
 - D. Headrest
 Visit www.jsifurniture.com/finishes-and-materials/textiles for our textiles program.
 See selection of standard and graded in manufacturers and patterns.
- 7 Metal Leg Color - [See Metal Leg Color Options](#)
- 8 Optional Power Center - Flush Mount (EC22) - Black (B) or White (W); \$583 list each, see page CT3 for location availability
- 9 Optional Drink Holder (DH) - add \$120 list each
- 10 Optional Tablet Arm - indicate left (TBL) or right arm (TBR); flat cut add \$663
- 11 list, double cut add \$691 list
- 12 Optional Rubber Cushion Nylon Glides - no upcharge
Product Options

Specifications

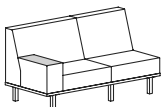

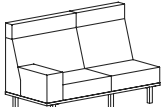
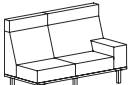
- Wood species - Cherry, Maple, Walnut or Double Cut. Seat has synthetic sheet webbing with cross strap reinforcement, 4 1/4" high density polyurethane foam.
- Back has high density polyurethane foam.
- Arms have 3/4" thick top and 1/4" thick side high density polyurethane foam.
- Plywood construction with locking tenons, glue and screws.
- Linking bracket included.
- Metal legs are 16 gauge steel tube with metal leveling glides.
- 3/4" thick 10" deep laminate stand up surface with coordinating 3mm PVC edge supported by steel columns, 42" surface height.

Connect Modular Lounge



Description	① Model	Specifications	List Price Per Grade																												
Two Seat Privacy Back with Stand Up Surface 	CTL2306 <ul style="list-style-type: none"> · armless · stand up surface corner; specify square (S) no upcharge or rounded (R) add \$49 list · 30" individual seat width · 14" high headrest · 41 ¾" high stand up surface · COM based on single fabric · multiple fabrics, see pages CT6-CT8 for yardage requirements · double cut veneer available; specify and add \$128 list 	<table border="1"> <thead> <tr> <th>Dimensions</th> <th>D</th> <th>W</th> <th>H</th> </tr> </thead> <tbody> <tr> <td>Overall</td> <td>42</td> <td>60</td> <td>51 ½</td> </tr> <tr> <td>Seat</td> <td>20</td> <td>60</td> <td>18</td> </tr> </tbody> </table>	Dimensions	D	W	H	Overall	42	60	51 ½	Seat	20	60	18	<table border="1"> <thead> <tr> <th colspan="2">Upholstery</th> <th colspan="2">Shipping</th> </tr> </thead> <tbody> <tr> <td>COM Ydg</td> <td>10</td> <td>Ctn Wt</td> <td>202</td> </tr> <tr> <td>COL Sq Ft</td> <td>230</td> <td>Cu Ft</td> <td>66</td> </tr> </tbody> </table>	Upholstery		Shipping		COM Ydg	10	Ctn Wt	202	COL Sq Ft	230	Cu Ft	66				
		Dimensions	D	W	H																										
Overall	42	60	51 ½																												
Seat	20	60	18																												
Upholstery		Shipping																													
COM Ydg	10	Ctn Wt	202																												
COL Sq Ft	230	Cu Ft	66																												
			<table border="1"> <thead> <tr> <th>Grade</th> <th>Price</th> </tr> </thead> <tbody> <tr><td>COM</td><td>\$5,784</td></tr> <tr><td>A</td><td>\$6,016</td></tr> <tr><td>B</td><td>\$6,301</td></tr> <tr><td>COL/C</td><td>\$6,800</td></tr> <tr><td>D</td><td>\$7,439</td></tr> <tr><td>E</td><td>\$8,084</td></tr> <tr><td>F</td><td>\$9,082</td></tr> <tr><td>G</td><td>\$10,152</td></tr> <tr><td>H</td><td>\$11,292</td></tr> <tr><td>I</td><td>\$13,074</td></tr> <tr><td>J</td><td>\$15,213</td></tr> <tr><td>L1</td><td>\$11,791</td></tr> <tr><td>L2</td><td>\$13,289</td></tr> </tbody> </table>	Grade	Price	COM	\$5,784	A	\$6,016	B	\$6,301	COL/C	\$6,800	D	\$7,439	E	\$8,084	F	\$9,082	G	\$10,152	H	\$11,292	I	\$13,074	J	\$15,213	L1	\$11,791	L2	\$13,289
Grade	Price																														
COM	\$5,784																														
A	\$6,016																														
B	\$6,301																														
COL/C	\$6,800																														
D	\$7,439																														
E	\$8,084																														
F	\$9,082																														
G	\$10,152																														
H	\$11,292																														
I	\$13,074																														
J	\$15,213																														
L1	\$11,791																														
L2	\$13,289																														
Two Seat Low Back 	CTL2301UR CTL2301UL <ul style="list-style-type: none"> · upholstered arm · 10" arm width · 30" individual seat width · COM based on single fabric · multiple fabrics, see pages CT6-CT8 for yardage requirements · double cut veneer available; specify and add \$128 list 	<table border="1"> <thead> <tr> <th>Dimensions</th> <th>D</th> <th>W</th> <th>H</th> </tr> </thead> <tbody> <tr> <td>Overall</td> <td>32</td> <td>70</td> <td>30 ½</td> </tr> <tr> <td>Seat</td> <td>20</td> <td>60</td> <td>18</td> </tr> <tr> <td>Arm</td> <td></td> <td>10</td> <td>24 ½</td> </tr> </tbody> </table>	Dimensions	D	W	H	Overall	32	70	30 ½	Seat	20	60	18	Arm		10	24 ½	<table border="1"> <thead> <tr> <th colspan="2">Upholstery</th> <th colspan="2">Shipping</th> </tr> </thead> <tbody> <tr> <td>COM Ydg</td> <td>8 ½</td> <td>Ctn Wt</td> <td>187</td> </tr> <tr> <td>COL Sq Ft</td> <td>196</td> <td>Cu Ft</td> <td>36</td> </tr> </tbody> </table>	Upholstery		Shipping		COM Ydg	8 ½	Ctn Wt	187	COL Sq Ft	196	Cu Ft	36
		Dimensions	D	W	H																										
Overall	32	70	30 ½																												
Seat	20	60	18																												
Arm		10	24 ½																												
Upholstery		Shipping																													
COM Ydg	8 ½	Ctn Wt	187																												
COL Sq Ft	196	Cu Ft	36																												
<p>CTL2301UR right</p>  <p>CTL2301UL left</p> 			<table border="1"> <thead> <tr> <th>Grade</th> <th>Price</th> </tr> </thead> <tbody> <tr><td>COM</td><td>\$4,084</td></tr> <tr><td>A</td><td>\$4,269</td></tr> <tr><td>B</td><td>\$4,513</td></tr> <tr><td>COL/C</td><td>\$4,936</td></tr> <tr><td>D</td><td>\$5,482</td></tr> <tr><td>E</td><td>\$6,025</td></tr> <tr><td>F</td><td>\$6,877</td></tr> <tr><td>G</td><td>\$7,784</td></tr> <tr><td>H</td><td>\$8,754</td></tr> <tr><td>I</td><td>\$10,270</td></tr> <tr><td>J</td><td>\$12,090</td></tr> <tr><td>L1</td><td>\$9,178</td></tr> <tr><td>L2</td><td>\$10,451</td></tr> </tbody> </table>	Grade	Price	COM	\$4,084	A	\$4,269	B	\$4,513	COL/C	\$4,936	D	\$5,482	E	\$6,025	F	\$6,877	G	\$7,784	H	\$8,754	I	\$10,270	J	\$12,090	L1	\$9,178	L2	\$10,451
Grade	Price																														
COM	\$4,084																														
A	\$4,269																														
B	\$4,513																														
COL/C	\$4,936																														
D	\$5,482																														
E	\$6,025																														
F	\$6,877																														
G	\$7,784																														
H	\$8,754																														
I	\$10,270																														
J	\$12,090																														
L1	\$9,178																														
L2	\$10,451																														
Two Seat Low Back 	CTL2301WR CTL2301WL <ul style="list-style-type: none"> · wood cap arm · 10" arm width · 30" individual seat width · COM based on single fabric · multiple fabrics, see pages CT6-CT8 for yardage requirements · double cut veneer available; specify and add \$163 list 	<table border="1"> <thead> <tr> <th>Dimensions</th> <th>D</th> <th>W</th> <th>H</th> </tr> </thead> <tbody> <tr> <td>Overall</td> <td>32</td> <td>70</td> <td>30 ½</td> </tr> <tr> <td>Seat</td> <td>20</td> <td>60</td> <td>18</td> </tr> <tr> <td>Arm</td> <td></td> <td>10</td> <td>25</td> </tr> </tbody> </table>	Dimensions	D	W	H	Overall	32	70	30 ½	Seat	20	60	18	Arm		10	25	<table border="1"> <thead> <tr> <th colspan="2">Upholstery</th> <th colspan="2">Shipping</th> </tr> </thead> <tbody> <tr> <td>COM Ydg</td> <td>8 ½</td> <td>Ctn Wt</td> <td>192</td> </tr> <tr> <td>COL Sq Ft</td> <td>196</td> <td>Cu Ft</td> <td>36</td> </tr> </tbody> </table>	Upholstery		Shipping		COM Ydg	8 ½	Ctn Wt	192	COL Sq Ft	196	Cu Ft	36
		Dimensions	D	W	H																										
Overall	32	70	30 ½																												
Seat	20	60	18																												
Arm		10	25																												
Upholstery		Shipping																													
COM Ydg	8 ½	Ctn Wt	192																												
COL Sq Ft	196	Cu Ft	36																												
<p>CTL2301WR right</p>  <p>CTL2301WL left</p> 			<table border="1"> <thead> <tr> <th>Grade</th> <th>Price</th> </tr> </thead> <tbody> <tr><td>COM</td><td>\$4,277</td></tr> <tr><td>A</td><td>\$4,463</td></tr> <tr><td>B</td><td>\$4,705</td></tr> <tr><td>COL/C</td><td>\$5,131</td></tr> <tr><td>D</td><td>\$5,675</td></tr> <tr><td>E</td><td>\$6,220</td></tr> <tr><td>F</td><td>\$7,069</td></tr> <tr><td>G</td><td>\$7,976</td></tr> <tr><td>H</td><td>\$8,946</td></tr> <tr><td>I</td><td>\$10,463</td></tr> <tr><td>J</td><td>\$12,282</td></tr> <tr><td>L1</td><td>\$9,371</td></tr> <tr><td>L2</td><td>\$10,643</td></tr> </tbody> </table>	Grade	Price	COM	\$4,277	A	\$4,463	B	\$4,705	COL/C	\$5,131	D	\$5,675	E	\$6,220	F	\$7,069	G	\$7,976	H	\$8,946	I	\$10,463	J	\$12,282	L1	\$9,371	L2	\$10,643
Grade	Price																														
COM	\$4,277																														
A	\$4,463																														
B	\$4,705																														
COL/C	\$5,131																														
D	\$5,675																														
E	\$6,220																														
F	\$7,069																														
G	\$7,976																														
H	\$8,946																														
I	\$10,463																														
J	\$12,282																														
L1	\$9,371																														
L2	\$10,643																														
Two Seat Mid Back 	CTL2302UR CTL2302UL <ul style="list-style-type: none"> · upholstered arm · 10" arm width · 30" individual seat width · COM based on single fabric · multiple fabrics, see pages CT6-CT8 for yardage requirements · double cut veneer available; specify and add \$128 list 	<table border="1"> <thead> <tr> <th>Dimensions</th> <th>D</th> <th>W</th> <th>H</th> </tr> </thead> <tbody> <tr> <td>Overall</td> <td>32</td> <td>70</td> <td>37 ½</td> </tr> <tr> <td>Seat</td> <td>20</td> <td>60</td> <td>18</td> </tr> <tr> <td>Arm</td> <td></td> <td>10</td> <td>24 ½</td> </tr> </tbody> </table>	Dimensions	D	W	H	Overall	32	70	37 ½	Seat	20	60	18	Arm		10	24 ½	<table border="1"> <thead> <tr> <th colspan="2">Upholstery</th> <th colspan="2">Shipping</th> </tr> </thead> <tbody> <tr> <td>COM Ydg</td> <td>9</td> <td>Ctn Wt</td> <td>187</td> </tr> <tr> <td>COL Sq Ft</td> <td>207</td> <td>Cu Ft</td> <td>46</td> </tr> </tbody> </table>	Upholstery		Shipping		COM Ydg	9	Ctn Wt	187	COL Sq Ft	207	Cu Ft	46
		Dimensions	D	W	H																										
Overall	32	70	37 ½																												
Seat	20	60	18																												
Arm		10	24 ½																												
Upholstery		Shipping																													
COM Ydg	9	Ctn Wt	187																												
COL Sq Ft	207	Cu Ft	46																												
<p>CTL2302UR right</p>  <p>CTL2302UL left</p> 			<table border="1"> <thead> <tr> <th>Grade</th> <th>Price</th> </tr> </thead> <tbody> <tr><td>COM</td><td>\$4,468</td></tr> <tr><td>A</td><td>\$4,666</td></tr> <tr><td>B</td><td>\$4,923</td></tr> <tr><td>COL/C</td><td>\$5,373</td></tr> <tr><td>D</td><td>\$5,949</td></tr> <tr><td>E</td><td>\$6,528</td></tr> <tr><td>F</td><td>\$7,425</td></tr> <tr><td>G</td><td>\$8,389</td></tr> <tr><td>H</td><td>\$9,414</td></tr> <tr><td>I</td><td>\$11,018</td></tr> <tr><td>J</td><td>\$12,945</td></tr> <tr><td>L1</td><td>\$9,864</td></tr> <tr><td>L2</td><td>\$11,211</td></tr> </tbody> </table>	Grade	Price	COM	\$4,468	A	\$4,666	B	\$4,923	COL/C	\$5,373	D	\$5,949	E	\$6,528	F	\$7,425	G	\$8,389	H	\$9,414	I	\$11,018	J	\$12,945	L1	\$9,864	L2	\$11,211
Grade	Price																														
COM	\$4,468																														
A	\$4,666																														
B	\$4,923																														
COL/C	\$5,373																														
D	\$5,949																														
E	\$6,528																														
F	\$7,425																														
G	\$8,389																														
H	\$9,414																														
I	\$11,018																														
J	\$12,945																														
L1	\$9,864																														
L2	\$11,211																														

CONNECT

Description	Model	Specifications	List Price Per Grade																												
Two Seat Mid Back  CTL2302WR right  CTL2302WL left	CTL2302WR CTL2302WL <ul style="list-style-type: none"> • wood cap arm • 10" arm width • 30" individual seat width • COM based on single fabric • multiple fabrics, see pages CT6-CT8 for yardage requirements • double cut veneer available; specify and add \$163 list 	<table border="1"> <thead> <tr> <th>Dimensions</th> <th>D</th> <th>W</th> <th>H</th> </tr> </thead> <tbody> <tr> <td>Overall</td> <td>32</td> <td>70</td> <td>37½</td> </tr> <tr> <td>Seat</td> <td>20</td> <td>60</td> <td>18</td> </tr> <tr> <td>Arm</td> <td></td> <td>10</td> <td>25</td> </tr> <tr> <th colspan="2">Upholstery</th> <th colspan="2">Shipping</th> </tr> <tr> <td>COM Ydg</td> <td>9</td> <td>Ctn Wt</td> <td>192</td> </tr> <tr> <td>COL Sq Ft</td> <td>207</td> <td>Cu Ft</td> <td>46</td> </tr> </tbody> </table>	Dimensions	D	W	H	Overall	32	70	37½	Seat	20	60	18	Arm		10	25	Upholstery		Shipping		COM Ydg	9	Ctn Wt	192	COL Sq Ft	207	Cu Ft	46	COM \$4,656 A \$4,857 B \$5,116 COL/C \$5,564 D \$6,143 E \$6,721 F \$7,618 G \$8,580 H \$9,609 I \$11,212 J \$13,136 L1 \$10,057 L2 \$11,403
		Dimensions	D	W	H																										
Overall	32	70	37½																												
Seat	20	60	18																												
Arm		10	25																												
Upholstery		Shipping																													
COM Ydg	9	Ctn Wt	192																												
COL Sq Ft	207	Cu Ft	46																												
Two Seat High Back  CTL2303UR right  CTL2303UL left	CTL2303UR CTL2303UL <ul style="list-style-type: none"> • upholstered arm • 10" arm width • 30" individual seat width • 7" high headrest • COM based on single fabric • multiple fabrics, see pages CT6-CT8 for yardage requirements • double cut veneer available; specify and add \$128 list 	<table border="1"> <thead> <tr> <th>Dimensions</th> <th>D</th> <th>W</th> <th>H</th> </tr> </thead> <tbody> <tr> <td>Overall</td> <td>32</td> <td>70</td> <td>44½</td> </tr> <tr> <td>Seat</td> <td>20</td> <td>60</td> <td>18</td> </tr> <tr> <td>Arm</td> <td></td> <td>10</td> <td>24½</td> </tr> <tr> <th colspan="2">Upholstery</th> <th colspan="2">Shipping</th> </tr> <tr> <td>COM Ydg</td> <td>10½</td> <td>Ctn Wt</td> <td>204</td> </tr> <tr> <td>COL Sq Ft</td> <td>242</td> <td>Cu Ft</td> <td>56</td> </tr> </tbody> </table>	Dimensions	D	W	H	Overall	32	70	44½	Seat	20	60	18	Arm		10	24½	Upholstery		Shipping		COM Ydg	10½	Ctn Wt	204	COL Sq Ft	242	Cu Ft	56	COM \$4,850 A \$5,075 B \$5,376 COL/C \$5,899 D \$6,574 E \$7,246 F \$8,295 G \$9,417 H \$10,616 I \$12,489 J \$14,733 L1 \$11,141 L2 \$12,712
		Dimensions	D	W	H																										
Overall	32	70	44½																												
Seat	20	60	18																												
Arm		10	24½																												
Upholstery		Shipping																													
COM Ydg	10½	Ctn Wt	204																												
COL Sq Ft	242	Cu Ft	56																												

To Order, Specify:

- 1 Model Number
- 2 Wood Species - Cherry (CH1), Maple (MA1), Walnut (WA1) or Double Cut (DC1)
- 3 Wood Finish [See Wood Finish Options](#)
- 4 Laminate Color Selection (Stand Up Surface) [See Laminate Color Selection](#)
- 5 Surface Corners (Stand Up Surface) - Square (S), no upcharge or Rounded (R), add \$49 list
- 6 Fabric Selection - vendor, pattern and color
 - A. Seat
 - B. Back
 - C. Arm
 - D. Headrest
 Visit www.jsifurniture.com/finishes-and-materials/textiles for our textiles program. See selection of standard and graded in manufacturers and patterns.
- 7 Metal Leg Color - [See Metal Leg Color Options](#)
- 8 Optional Power Center - Flush Mount (EC22) - Black (B) or White (W); \$583 list each, see page CT3 for location availability
- 9 Optional Drink Holder (DH) - add \$120 list each
- 10 Optional Tablet Arm - indicate left (TBL) or right arm (TBR); flat cut add \$663
- 11 list, double cut add \$691 list
- 12 Optional Rubber Cushion Nylon Glides - no upcharge
Product Options

Specifications

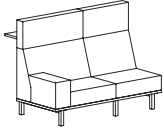

- Wood species - Cherry, Maple, Walnut or Double Cut. Seat has synthetic sheet webbing with cross strap reinforcement, 4 ¼" high density polyurethane foam.
- Back has high density polyurethane foam.
- Arms have ¾" thick top and ¼" thick side high density polyurethane foam.
- Plywood construction with locking tenons, glue and screws.
- Linking bracket included.
- Metal legs are 16 gauge steel tube with metal leveling glides.
- ¾" thick 10" deep laminate stand up surface with coordinating 3mm PVC edge supported by steel columns, 42" surface height.

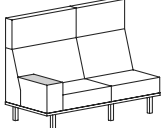
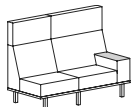
Connect Modular Lounge



Description	① Model	Specifications	List Price Per Grade																																										
Two Seat High Back	CTL2303WR CTL2303WL <ul style="list-style-type: none"> · wood cap arm · 10" arm width · 30" individual seat width · 7" high headrest · COM based on single fabric · multiple fabrics, see pages CT6-CT8 for yardage requirements · double cut veneer available; specify and add \$163 list 	<table border="1"> <thead> <tr> <th>Dimensions</th> <th>D</th> <th>W</th> <th>H</th> </tr> </thead> <tbody> <tr> <td>Overall</td> <td>32</td> <td>70</td> <td>44 ½</td> </tr> <tr> <td>Seat</td> <td>20</td> <td>60</td> <td>18</td> </tr> <tr> <td>Arm</td> <td></td> <td>10</td> <td>25</td> </tr> </tbody> </table>	Dimensions	D	W	H	Overall	32	70	44 ½	Seat	20	60	18	Arm		10	25	<table border="1"> <tbody> <tr><td>COM</td><td>\$5,042</td></tr> <tr><td>A</td><td>\$5,270</td></tr> <tr><td>B</td><td>\$5,567</td></tr> <tr><td>COL/C</td><td>\$6,092</td></tr> <tr><td>D</td><td>\$6,765</td></tr> <tr><td>E</td><td>\$7,438</td></tr> <tr><td>F</td><td>\$8,486</td></tr> <tr><td>G</td><td>\$9,612</td></tr> <tr><td>H</td><td>\$10,809</td></tr> <tr><td>I</td><td>\$12,682</td></tr> <tr><td>J</td><td>\$14,927</td></tr> <tr><td>L1</td><td>\$11,332</td></tr> <tr><td>L2</td><td>\$12,905</td></tr> </tbody> </table>	COM	\$5,042	A	\$5,270	B	\$5,567	COL/C	\$6,092	D	\$6,765	E	\$7,438	F	\$8,486	G	\$9,612	H	\$10,809	I	\$12,682	J	\$14,927	L1	\$11,332	L2	\$12,905
		Dimensions	D	W	H																																								
Overall	32	70	44 ½																																										
Seat	20	60	18																																										
Arm		10	25																																										
COM	\$5,042																																												
A	\$5,270																																												
B	\$5,567																																												
COL/C	\$6,092																																												
D	\$6,765																																												
E	\$7,438																																												
F	\$8,486																																												
G	\$9,612																																												
H	\$10,809																																												
I	\$12,682																																												
J	\$14,927																																												
L1	\$11,332																																												
L2	\$12,905																																												
<p>CTL2303WR right</p> <p>CTL2303WL left</p>																																													
Two Seat High Back with Stand Up Surface	CTL2304UR CTL2304UL <ul style="list-style-type: none"> · upholstered arm · stand up surface corner; specify square (S) no upcharge or rounded (R) add \$49 list · 10" arm width · 30" individual seat width · 7" high headrest · 41 ¾" high stand up surface · COM based on single fabric · multiple fabrics, see pages CT6-CT8 for yardage requirements · double cut veneer available; specify and add \$128 list 	<table border="1"> <thead> <tr> <th>Dimensions</th> <th>D</th> <th>W</th> <th>H</th> </tr> </thead> <tbody> <tr> <td>Overall</td> <td>42</td> <td>70</td> <td>44 ½</td> </tr> <tr> <td>Seat</td> <td>20</td> <td>60</td> <td>18</td> </tr> <tr> <td>Arm</td> <td></td> <td>10</td> <td>24 ½</td> </tr> </tbody> </table>	Dimensions	D	W	H	Overall	42	70	44 ½	Seat	20	60	18	Arm		10	24 ½	<table border="1"> <tbody> <tr><td>COM</td><td>\$6,641</td></tr> <tr><td>A</td><td>\$6,892</td></tr> <tr><td>B</td><td>\$7,190</td></tr> <tr><td>COL/C</td><td>\$7,716</td></tr> <tr><td>D</td><td>\$8,390</td></tr> <tr><td>E</td><td>\$9,064</td></tr> <tr><td>F</td><td>\$10,110</td></tr> <tr><td>G</td><td>\$11,234</td></tr> <tr><td>H</td><td>\$12,434</td></tr> <tr><td>I</td><td>\$14,303</td></tr> <tr><td>J</td><td>\$16,550</td></tr> <tr><td>L1</td><td>\$12,958</td></tr> <tr><td>L2</td><td>\$14,527</td></tr> </tbody> </table>	COM	\$6,641	A	\$6,892	B	\$7,190	COL/C	\$7,716	D	\$8,390	E	\$9,064	F	\$10,110	G	\$11,234	H	\$12,434	I	\$14,303	J	\$16,550	L1	\$12,958	L2	\$14,527
		Dimensions	D	W	H																																								
Overall	42	70	44 ½																																										
Seat	20	60	18																																										
Arm		10	24 ½																																										
COM	\$6,641																																												
A	\$6,892																																												
B	\$7,190																																												
COL/C	\$7,716																																												
D	\$8,390																																												
E	\$9,064																																												
F	\$10,110																																												
G	\$11,234																																												
H	\$12,434																																												
I	\$14,303																																												
J	\$16,550																																												
L1	\$12,958																																												
L2	\$14,527																																												
<p>CTL2304UR right</p> <p>CTL2304UL left</p>																																													
Two Seat High Back with Stand Up Surface	CTL2304WR CTL2304WL <ul style="list-style-type: none"> · wood cap arm · stand up surface corner; specify square (S) no upcharge or rounded (R) add \$49 list · 10" arm width · 30" individual seat width · 7" high headrest · 41 ¾" high stand up surface · COM based on single fabric · multiple fabrics, see pages CT6-CT8 for yardage requirements · double cut veneer available; specify and add \$163 list 	<table border="1"> <thead> <tr> <th>Dimensions</th> <th>D</th> <th>W</th> <th>H</th> </tr> </thead> <tbody> <tr> <td>Overall</td> <td>42</td> <td>70</td> <td>44 ½</td> </tr> <tr> <td>Seat</td> <td>20</td> <td>60</td> <td>18</td> </tr> <tr> <td>Arm</td> <td></td> <td>10</td> <td>25</td> </tr> </tbody> </table>	Dimensions	D	W	H	Overall	42	70	44 ½	Seat	20	60	18	Arm		10	25	<table border="1"> <tbody> <tr><td>COM</td><td>\$6,831</td></tr> <tr><td>A</td><td>\$7,086</td></tr> <tr><td>B</td><td>\$7,385</td></tr> <tr><td>COL/C</td><td>\$7,907</td></tr> <tr><td>D</td><td>\$8,583</td></tr> <tr><td>E</td><td>\$9,256</td></tr> <tr><td>F</td><td>\$10,306</td></tr> <tr><td>G</td><td>\$11,427</td></tr> <tr><td>H</td><td>\$12,625</td></tr> <tr><td>I</td><td>\$14,497</td></tr> <tr><td>J</td><td>\$16,744</td></tr> <tr><td>L1</td><td>\$13,149</td></tr> <tr><td>L2</td><td>\$14,722</td></tr> </tbody> </table>	COM	\$6,831	A	\$7,086	B	\$7,385	COL/C	\$7,907	D	\$8,583	E	\$9,256	F	\$10,306	G	\$11,427	H	\$12,625	I	\$14,497	J	\$16,744	L1	\$13,149	L2	\$14,722
		Dimensions	D	W	H																																								
Overall	42	70	44 ½																																										
Seat	20	60	18																																										
Arm		10	25																																										
COM	\$6,831																																												
A	\$7,086																																												
B	\$7,385																																												
COL/C	\$7,907																																												
D	\$8,583																																												
E	\$9,256																																												
F	\$10,306																																												
G	\$11,427																																												
H	\$12,625																																												
I	\$14,497																																												
J	\$16,744																																												
L1	\$13,149																																												
L2	\$14,722																																												
<p>CTL2304WR right</p> <p>CTL2304WL left</p>																																													
Two Seat Privacy Back	CTL2305UR CTL2305UL <ul style="list-style-type: none"> · upholstered arm · 10" arm width · 30" individual seat width · 14" high headrest · COM based on single fabric · multiple fabrics, see pages CT6-CT8 for yardage requirements · double cut veneer available; specify and add \$128 list 	<table border="1"> <thead> <tr> <th>Dimensions</th> <th>D</th> <th>W</th> <th>H</th> </tr> </thead> <tbody> <tr> <td>Overall</td> <td>32</td> <td>70</td> <td>51 ½</td> </tr> <tr> <td>Seat</td> <td>20</td> <td>60</td> <td>18</td> </tr> <tr> <td>Arm</td> <td></td> <td>10</td> <td>24 ½</td> </tr> </tbody> </table>	Dimensions	D	W	H	Overall	32	70	51 ½	Seat	20	60	18	Arm		10	24 ½	<table border="1"> <tbody> <tr><td>COM</td><td>\$5,234</td></tr> <tr><td>A</td><td>\$5,479</td></tr> <tr><td>B</td><td>\$5,806</td></tr> <tr><td>COL/C</td><td>\$6,381</td></tr> <tr><td>D</td><td>\$7,119</td></tr> <tr><td>E</td><td>\$7,858</td></tr> <tr><td>F</td><td>\$9,007</td></tr> <tr><td>G</td><td>\$10,234</td></tr> <tr><td>H</td><td>\$11,548</td></tr> <tr><td>I</td><td>\$13,598</td></tr> <tr><td>J</td><td>\$16,055</td></tr> <tr><td>L1</td><td>\$12,121</td></tr> <tr><td>L2</td><td>\$13,842</td></tr> </tbody> </table>	COM	\$5,234	A	\$5,479	B	\$5,806	COL/C	\$6,381	D	\$7,119	E	\$7,858	F	\$9,007	G	\$10,234	H	\$11,548	I	\$13,598	J	\$16,055	L1	\$12,121	L2	\$13,842
		Dimensions	D	W	H																																								
Overall	32	70	51 ½																																										
Seat	20	60	18																																										
Arm		10	24 ½																																										
COM	\$5,234																																												
A	\$5,479																																												
B	\$5,806																																												
COL/C	\$6,381																																												
D	\$7,119																																												
E	\$7,858																																												
F	\$9,007																																												
G	\$10,234																																												
H	\$11,548																																												
I	\$13,598																																												
J	\$16,055																																												
L1	\$12,121																																												
L2	\$13,842																																												
<p>CTL2305UR right</p> <p>CTL2305UL left</p>																																													

CONNECT

Description	Model	Specifications			List Price Per Grade		
		Dimensions	D	W	H	COM	
Two Seat Privacy Back with Stand Up Surface	CTL2306UR	Overall	42	70	51 ½	A	\$7,294
	CTL2306UL	Seat	20	60	18	B	\$7,623
 CTL2306UR right	<ul style="list-style-type: none"> upholstered arm stand up surface corner; specify square (S) no upcharge or rounded (R) add \$49 list 10" arm width 30" individual seat width 14" high headrest 41 ¾" high stand up surface COM based on single fabric multiple fabrics, see pages CT6-CT8 for yardage requirements double cut veneer available; specify and add \$128 list 	Arm		10	24 ½	COL/C	\$8,197
		Upholstery		Shipping		D	\$8,935
 CTL2306UL left		COM Ydg	11 ½	Ctn Wt	252	E	\$9,672
		COL Sq Ft	265	Cu Ft	78	F	\$10,821
						G	\$12,052
						H	\$13,362
						I	\$15,413
						J	\$17,875
						L1	\$13,938
						L2	\$15,656

Description	Model	Specifications			List Price Per Grade		
		Dimensions	D	W	H	COM	
Two Seat Privacy Back	CTL2305WR	Overall	32	70	51 ½	A	\$5,423
	CTL2305WL	Seat	20	60	18	B	\$6,000
 CTL2305WR right	<ul style="list-style-type: none"> wood cap arm 10" arm width 30" individual seat width 14" high headrest COM based on single fabric multiple fabrics, see pages CT6-CT8 for yardage requirements double cut veneer available; specify and add \$163 list 	Arm		10	25	COL/C	\$6,576
		Upholstery		Shipping		D	\$7,313
 CTL2305WL left		COM Ydg	11 ½	Ctn Wt	219	F	\$9,196
		COL Sq Ft	265	Cu Ft	66	G	\$10,428
						H	\$11,739
						I	\$13,791
						J	\$16,251
						L1	\$12,315
						L2	\$14,035

To Order, Specify:

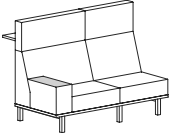
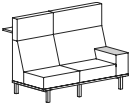
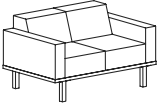
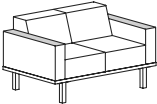
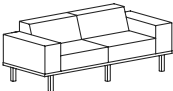
- 1 Model Number
 - 2 Wood Species - Cherry (CH1), Maple (MA1), Walnut (WA1) or Double Cut (DC1)
 - 3 Wood Finish [See Wood Finish Options](#)
 - 4 Laminate Color Selection (Stand Up Surface) [See Laminate Color Selection](#)
 - 5 Surface Corners (Stand Up Surface) - Square (S), no upcharge or Rounded (R), add \$49 list
 - 6 Fabric Selection - vendor, pattern and color
 - A. Seat
 - B. Back
 - C. Arm
 - D. Headrest
 Visit www.jsifurniture.com/finishes-and-materials/textiles for our textiles program. See selection of standard and graded in manufacturers and patterns.
 - 7 Metal Leg Color - [See Metal Leg Color Options](#)
 - 8 Optional Power Center - Flush Mount (EC22) - Black (B) or White (W); \$583 list each, see page CT3 for location availability
 - 9 Optional Drink Holder (DH) - add \$120 list each
 - 10 Optional Tablet Arm - indicate left (TBL) or right arm (TBR); flat cut add \$663
 - 11 list, double cut add \$691 list
 - 12 Optional Rubber Cushion Nylon Glides - no upcharge
- Product Options

Specifications

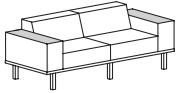
- Wood species - Cherry, Maple, Walnut or Double Cut. Seat has synthetic sheet webbing with cross strap reinforcement, 4 ¼" high density polyurethane foam.
- Back has high density polyurethane foam.
- Arms have ¾" thick top and ¼" thick side high density polyurethane foam.
- Plywood construction with locking tenons, glue and screws.
- Linking bracket included.
- Metal legs are 16 gauge steel tube with metal leveling glides.
- ¾" thick 10" deep laminate stand up surface with coordinating 3mm PVC edge supported by steel columns, 42" surface height.

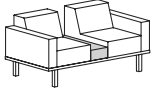
Connect Modular Lounge



Description	Model	Specifications	List Price Per Grade																												
Two Seat Privacy Back with Stand Up Surface  CTL2306WR right  CTL2306WL left	CTL2306WR CTL2306WL <ul style="list-style-type: none"> · wood cap arm · stand up surface corner; specify square (S) no upcharge or rounded (R) add \$49 list · 10" arm width · 30" individual seat width · 14" high headrest · 41 ¾" high stand up surface · COM based on single fabric · multiple fabrics, see pages CT6-CT8 for yardage requirements · double cut veneer available; specify and add \$163 list 	<table border="1"> <thead> <tr> <th>Dimensions</th> <th>D</th> <th>W</th> <th>H</th> </tr> </thead> <tbody> <tr> <td>Overall</td> <td>42</td> <td>70</td> <td>51 ½</td> </tr> <tr> <td>Seat</td> <td>20</td> <td>60</td> <td>18</td> </tr> <tr> <td>Arm</td> <td></td> <td>10</td> <td>25</td> </tr> </tbody> </table> <table border="1"> <thead> <tr> <th>Upholstery</th> <th colspan="3">Shipping</th> </tr> </thead> <tbody> <tr> <td>COM Ydg</td> <td>11 ½</td> <td>Ctn Wt</td> <td>257</td> </tr> <tr> <td>COL Sq Ft</td> <td>265</td> <td>Cu Ft</td> <td>78</td> </tr> </tbody> </table>	Dimensions	D	W	H	Overall	42	70	51 ½	Seat	20	60	18	Arm		10	25	Upholstery	Shipping			COM Ydg	11 ½	Ctn Wt	257	COL Sq Ft	265	Cu Ft	78	COM \$7,214 A \$7,488 B \$7,815 COL/C \$8,390 D \$9,128 E \$9,867 F \$11,015 G \$12,245 H \$13,557 I \$15,607 J \$18,067 L1 \$14,129 L2 \$15,853
		Dimensions	D	W	H																										
Overall	42	70	51 ½																												
Seat	20	60	18																												
Arm		10	25																												
Upholstery	Shipping																														
COM Ydg	11 ½	Ctn Wt	257																												
COL Sq Ft	265	Cu Ft	78																												
Two Seat Low Back 	CTL2201U2 <ul style="list-style-type: none"> · upholstered arms · 5" arm width · 20" individual seat width · COM based on single fabric · multiple fabrics, see pages CT6-CT8 for yardage requirements · double cut veneer available; specify and add \$163 list 	<table border="1"> <thead> <tr> <th>Dimensions</th> <th>D</th> <th>W</th> <th>H</th> </tr> </thead> <tbody> <tr> <td>Overall</td> <td>32</td> <td>50</td> <td>30 ½</td> </tr> <tr> <td>Seat</td> <td>20</td> <td>40</td> <td>18</td> </tr> <tr> <td>Arm</td> <td></td> <td>5</td> <td>24 ½</td> </tr> </tbody> </table> <table border="1"> <thead> <tr> <th>Upholstery</th> <th colspan="3">Shipping</th> </tr> </thead> <tbody> <tr> <td>COM Ydg</td> <td>10</td> <td>Ctn Wt</td> <td>105</td> </tr> <tr> <td>COL Sq Ft</td> <td>230</td> <td>Cu Ft</td> <td>26</td> </tr> </tbody> </table>	Dimensions	D	W	H	Overall	32	50	30 ½	Seat	20	40	18	Arm		5	24 ½	Upholstery	Shipping			COM Ydg	10	Ctn Wt	105	COL Sq Ft	230	Cu Ft	26	COM \$4,353 A \$4,561 B \$4,845 COL/C \$5,345 D \$5,985 E \$6,629 F \$7,626 G \$8,698 H \$9,836 I \$11,621 J \$13,758 L1 \$10,339 L2 \$11,835
Dimensions	D	W	H																												
Overall	32	50	30 ½																												
Seat	20	40	18																												
Arm		5	24 ½																												
Upholstery	Shipping																														
COM Ydg	10	Ctn Wt	105																												
COL Sq Ft	230	Cu Ft	26																												
Two Seat Low Back 	CTL2201W2 <ul style="list-style-type: none"> · wood cap arms · 5" arm width · 20" individual seat width · COM based on single fabric · multiple fabrics, see pages CT6-CT8 for yardage requirements · double cut veneer available; specify and add \$191 list 	<table border="1"> <thead> <tr> <th>Dimensions</th> <th>D</th> <th>W</th> <th>H</th> </tr> </thead> <tbody> <tr> <td>Overall</td> <td>32</td> <td>50</td> <td>30 ½</td> </tr> <tr> <td>Seat</td> <td>20</td> <td>40</td> <td>18</td> </tr> <tr> <td>Arm</td> <td></td> <td>5</td> <td>25</td> </tr> </tbody> </table> <table border="1"> <thead> <tr> <th>Upholstery</th> <th colspan="3">Shipping</th> </tr> </thead> <tbody> <tr> <td>COM Ydg</td> <td>10</td> <td>Ctn Wt</td> <td>115</td> </tr> <tr> <td>COL Sq Ft</td> <td>230</td> <td>Cu Ft</td> <td>26</td> </tr> </tbody> </table>	Dimensions	D	W	H	Overall	32	50	30 ½	Seat	20	40	18	Arm		5	25	Upholstery	Shipping			COM Ydg	10	Ctn Wt	115	COL Sq Ft	230	Cu Ft	26	COM \$4,736 A \$4,951 B \$5,236 COL/C \$5,735 D \$6,377 E \$7,020 F \$8,016 G \$9,088 H \$10,229 I \$12,010 J \$14,150 L1 \$10,727 L2 \$12,223
Dimensions	D	W	H																												
Overall	32	50	30 ½																												
Seat	20	40	18																												
Arm		5	25																												
Upholstery	Shipping																														
COM Ydg	10	Ctn Wt	115																												
COL Sq Ft	230	Cu Ft	26																												
Two Seat Low Back 	CTL2301U2 <ul style="list-style-type: none"> · upholstered arms · 10" arm width · 30" individual seat width · COM based on single fabric · multiple fabrics, see pages CT6-CT8 for yardage requirements · double cut veneer available; specify and add \$128 list 	<table border="1"> <thead> <tr> <th>Dimensions</th> <th>D</th> <th>W</th> <th>H</th> </tr> </thead> <tbody> <tr> <td>Overall</td> <td>32</td> <td>80</td> <td>30 ½</td> </tr> <tr> <td>Seat</td> <td>20</td> <td>60</td> <td>18</td> </tr> <tr> <td>Arm</td> <td></td> <td>10</td> <td>24 ½</td> </tr> </tbody> </table> <table border="1"> <thead> <tr> <th>Upholstery</th> <th colspan="3">Shipping</th> </tr> </thead> <tbody> <tr> <td>COM Ydg</td> <td>10</td> <td>Ctn Wt</td> <td>221</td> </tr> <tr> <td>COL Sq Ft</td> <td>230</td> <td>Cu Ft</td> <td>41</td> </tr> </tbody> </table>	Dimensions	D	W	H	Overall	32	80	30 ½	Seat	20	60	18	Arm		10	24 ½	Upholstery	Shipping			COM Ydg	10	Ctn Wt	221	COL Sq Ft	230	Cu Ft	41	COM \$4,742 A \$4,955 B \$5,241 COL/C \$5,740 D \$6,383 E \$7,025 F \$8,022 G \$9,091 H \$10,232 I \$12,015 J \$14,155 L1 \$10,733 L2 \$12,230
Dimensions	D	W	H																												
Overall	32	80	30 ½																												
Seat	20	60	18																												
Arm		10	24 ½																												
Upholstery	Shipping																														
COM Ydg	10	Ctn Wt	221																												
COL Sq Ft	230	Cu Ft	41																												

CONNECT

Description	1 Model	Specifications			List Price Per Grade	
Two Seat Low Back 	CTL2301W2 • wood cap arms • 10" arm width • 30" individual seat width • COM based on single fabric • multiple fabrics, see pages CT6-CT8 for yardage requirements • double cut veneer available; specify and add \$191 list	Dimensions	D	W	H	COM \$5,127
		Overall	32	80	30½	A \$5,346
		Seat	20	60	18	B \$5,633
		Arm		10	25	COL/C \$6,130
		Upholstery	Shipping			D \$6,773
		COM Ydg	10	Ctn Wt	231	E \$7,416
		COL Sq Ft	230	Cu Ft	41	F \$8,412
						G \$9,483
						H \$10,623
						I \$12,404
				J \$14,545		
				L1 \$11,123		
				L2 \$12,619		

Two Seat Low Back 	CTL2201U2CC • upholstered arms • 5" arm width • 20" individual seat width • 10" wide center console • COM based on single fabric • multiple fabrics, see pages CT6-CT8 for yardage requirements • double cut veneer available; specify and add \$191 list	Dimensions	D	W	H	COM \$5,078
		Overall	32	60	30½	A \$5,299
		Seat	20	40	18	B \$5,583
		Arm		5	24½	COL/C \$6,084
		Upholstery	Shipping			D \$6,726
		COM Ydg	10	Ctn Wt	118	E \$7,366
		COL Sq Ft	230	Cu Ft	31	F \$8,364
						G \$9,434
						H \$10,575
						I \$12,359
				J \$14,497		
				L1 \$11,076		
				L2 \$12,571		

To Order, Specify:

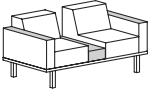
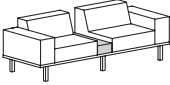
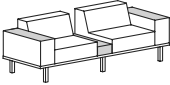
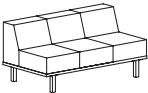
- 1 Model Number
- 2 Wood Species - Cherry (CH1), Maple (MA1), Walnut (WA1) or Double Cut (DC1)
- 3 Wood Finish [See Wood Finish Options](#)
- 4 Laminate Color Selection (Stand Up Surface) [See Laminate Color Selection](#)
- 5 Surface Corners (Stand Up Surface) - Square (S), no upcharge or Rounded(R), add \$49 list
- 6 Fabric Selection - vendor, pattern and color
 - A. Seat
 - B. Back
 - C. Arm
 - D. Headrest
 Visit www.jsifurniture.com/finishes-and-materials/textiles for our textiles program. See selection of standard and graded in manufacturers and patterns.
- 7 Metal Leg Color - [See Metal Leg Color Options](#)
- 8 Optional Wood Back Rail - available on any unit with two arms, specify and add \$192 list
- 9 Optional Power Center - Flush Mount (EC22) - Black (B) or White (W); \$583 list each, see page CT3 for location availability
- 10 Arm Cap - Wood (M) or Black 3D Laminate (B3L)
- 11 Optional Drink Holder(s) (DH) - add \$120 list each, indicate left or right arm; add \$240 list for end table
- 12 Optional Tablet Arm - indicate left (TBL) or right arm (TBR); flat cut add \$663 list, double cut add \$691 list
- 13 Optional Coordinating Wood Grain Laminate Available on Wood Cap Arm or Table Top - no upcharge. Finishes with an asterisk have a coordinating laminate available
- 14 Optional Rubber Cushion Nylon Glides - no upcharge Product Options

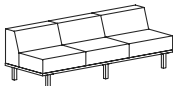
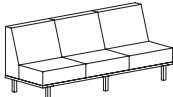
Specifications

- Wood species - Cherry, Maple, Walnut or Double Cut. Seat has synthetic sheet webbing with cross strap reinforcement, 4 ¼" high density polyurethane foam.
- Back has high density polyurethane foam.
- Arms have ¾" thick top and ¼" thick side high density polyurethane foam.
- Plywood construction with locking tenons, glue and screws.
- Linking bracket included.
- Metal legs are 16 gauge steel tube with metal leveling glides.
- ¾" thick 10" deep laminate stand up surface with coordinating 3mm PVC edge supported by steel columns, 42" surface height.

Connect Modular Lounge



Description	① Model	Specifications	List Price Per Grade																																										
Two Seat Low Back 	CTL2201W2CC · wood cap arms · 5" arm width · 20" individual seat width · 10" wide center console · COM based on single fabric · multiple fabrics, see pages CT6-CT8 for yardage requirements · double cut veneer available; specify and add \$239 list	<table border="1"> <thead> <tr> <th>Dimensions</th> <th>D</th> <th>W</th> <th>H</th> </tr> </thead> <tbody> <tr> <td>Overall</td> <td>32</td> <td>60</td> <td>30½</td> </tr> <tr> <td>Seat</td> <td>20</td> <td>40</td> <td>18</td> </tr> <tr> <td>Arm</td> <td></td> <td>5</td> <td>25</td> </tr> </tbody> </table>	Dimensions	D	W	H	Overall	32	60	30½	Seat	20	40	18	Arm		5	25	<table border="1"> <tbody> <tr><td>COM</td><td>\$5,462</td></tr> <tr><td>A</td><td>\$5,687</td></tr> <tr><td>B</td><td>\$5,972</td></tr> <tr><td>COL/C</td><td>\$6,469</td></tr> <tr><td>D</td><td>\$7,113</td></tr> <tr><td>E</td><td>\$7,755</td></tr> <tr><td>F</td><td>\$8,754</td></tr> <tr><td>G</td><td>\$9,824</td></tr> <tr><td>H</td><td>\$10,964</td></tr> <tr><td>I</td><td>\$12,746</td></tr> <tr><td>J</td><td>\$14,886</td></tr> <tr><td>L1</td><td>\$11,463</td></tr> <tr><td>L2</td><td>\$12,960</td></tr> </tbody> </table>	COM	\$5,462	A	\$5,687	B	\$5,972	COL/C	\$6,469	D	\$7,113	E	\$7,755	F	\$8,754	G	\$9,824	H	\$10,964	I	\$12,746	J	\$14,886	L1	\$11,463	L2	\$12,960
		Dimensions	D	W	H																																								
Overall	32	60	30½																																										
Seat	20	40	18																																										
Arm		5	25																																										
COM	\$5,462																																												
A	\$5,687																																												
B	\$5,972																																												
COL/C	\$6,469																																												
D	\$7,113																																												
E	\$7,755																																												
F	\$8,754																																												
G	\$9,824																																												
H	\$10,964																																												
I	\$12,746																																												
J	\$14,886																																												
L1	\$11,463																																												
L2	\$12,960																																												
<table border="1"> <thead> <tr> <th>Upholstery</th> <th colspan="2">Shipping</th> </tr> </thead> <tbody> <tr> <td>COM Ydg</td> <td>10</td> <td>Ctn Wt 123</td> </tr> <tr> <td>COL Sq Ft</td> <td>230</td> <td>Cu Ft 31</td> </tr> </tbody> </table>		Upholstery	Shipping		COM Ydg	10	Ctn Wt 123	COL Sq Ft	230	Cu Ft 31																																			
Upholstery	Shipping																																												
COM Ydg	10	Ctn Wt 123																																											
COL Sq Ft	230	Cu Ft 31																																											
Two Seat Low Back 	CTL2301U2CC · upholstered arms · 10" arm width · 30" individual seat width · 10" wide center console · COM based on single fabric · multiple fabrics, see pages CT6-CT8 for yardage requirements · double cut veneer available; specify and add \$191 list	<table border="1"> <thead> <tr> <th>Dimensions</th> <th>D</th> <th>W</th> <th>H</th> </tr> </thead> <tbody> <tr> <td>Overall</td> <td>32</td> <td>90</td> <td>30½</td> </tr> <tr> <td>Seat</td> <td>20</td> <td>60</td> <td>18</td> </tr> <tr> <td>Arm</td> <td></td> <td>10</td> <td>24½</td> </tr> </tbody> </table>	Dimensions	D	W	H	Overall	32	90	30½	Seat	20	60	18	Arm		10	24½	<table border="1"> <tbody> <tr><td>COM</td><td>\$5,466</td></tr> <tr><td>A</td><td>\$5,690</td></tr> <tr><td>B</td><td>\$5,976</td></tr> <tr><td>COL/C</td><td>\$6,476</td></tr> <tr><td>D</td><td>\$7,118</td></tr> <tr><td>E</td><td>\$7,760</td></tr> <tr><td>F</td><td>\$8,758</td></tr> <tr><td>G</td><td>\$9,828</td></tr> <tr><td>H</td><td>\$10,968</td></tr> <tr><td>I</td><td>\$12,751</td></tr> <tr><td>J</td><td>\$14,890</td></tr> <tr><td>L1</td><td>\$11,469</td></tr> <tr><td>L2</td><td>\$12,966</td></tr> </tbody> </table>	COM	\$5,466	A	\$5,690	B	\$5,976	COL/C	\$6,476	D	\$7,118	E	\$7,760	F	\$8,758	G	\$9,828	H	\$10,968	I	\$12,751	J	\$14,890	L1	\$11,469	L2	\$12,966
		Dimensions	D	W	H																																								
Overall	32	90	30½																																										
Seat	20	60	18																																										
Arm		10	24½																																										
COM	\$5,466																																												
A	\$5,690																																												
B	\$5,976																																												
COL/C	\$6,476																																												
D	\$7,118																																												
E	\$7,760																																												
F	\$8,758																																												
G	\$9,828																																												
H	\$10,968																																												
I	\$12,751																																												
J	\$14,890																																												
L1	\$11,469																																												
L2	\$12,966																																												
<table border="1"> <thead> <tr> <th>Upholstery</th> <th colspan="2">Shipping</th> </tr> </thead> <tbody> <tr> <td>COM Ydg</td> <td>10</td> <td>Ctn Wt 237</td> </tr> <tr> <td>COL Sq Ft</td> <td>230</td> <td>Cu Ft 46</td> </tr> </tbody> </table>		Upholstery	Shipping		COM Ydg	10	Ctn Wt 237	COL Sq Ft	230	Cu Ft 46																																			
Upholstery	Shipping																																												
COM Ydg	10	Ctn Wt 237																																											
COL Sq Ft	230	Cu Ft 46																																											
Two Seat Low Back 	CTL2301W2CC · wood cap arms · 10" arm width · 30" individual seat width · 10" wide center console · COM based on single fabric · multiple fabrics, see pages CT6-CT8 for yardage requirements · double cut veneer available; specify and add \$239 list	<table border="1"> <thead> <tr> <th>Dimensions</th> <th>D</th> <th>W</th> <th>H</th> </tr> </thead> <tbody> <tr> <td>Overall</td> <td>32</td> <td>90</td> <td>30½</td> </tr> <tr> <td>Seat</td> <td>20</td> <td>60</td> <td>18</td> </tr> <tr> <td>Arm</td> <td></td> <td>10</td> <td>25</td> </tr> </tbody> </table>	Dimensions	D	W	H	Overall	32	90	30½	Seat	20	60	18	Arm		10	25	<table border="1"> <tbody> <tr><td>COM</td><td>\$5,852</td></tr> <tr><td>A</td><td>\$6,084</td></tr> <tr><td>B</td><td>\$6,369</td></tr> <tr><td>COL/C</td><td>\$6,867</td></tr> <tr><td>D</td><td>\$7,510</td></tr> <tr><td>E</td><td>\$8,153</td></tr> <tr><td>F</td><td>\$9,150</td></tr> <tr><td>G</td><td>\$10,221</td></tr> <tr><td>H</td><td>\$11,361</td></tr> <tr><td>I</td><td>\$13,143</td></tr> <tr><td>J</td><td>\$15,283</td></tr> <tr><td>L1</td><td>\$11,859</td></tr> <tr><td>L2</td><td>\$13,356</td></tr> </tbody> </table>	COM	\$5,852	A	\$6,084	B	\$6,369	COL/C	\$6,867	D	\$7,510	E	\$8,153	F	\$9,150	G	\$10,221	H	\$11,361	I	\$13,143	J	\$15,283	L1	\$11,859	L2	\$13,356
		Dimensions	D	W	H																																								
Overall	32	90	30½																																										
Seat	20	60	18																																										
Arm		10	25																																										
COM	\$5,852																																												
A	\$6,084																																												
B	\$6,369																																												
COL/C	\$6,867																																												
D	\$7,510																																												
E	\$8,153																																												
F	\$9,150																																												
G	\$10,221																																												
H	\$11,361																																												
I	\$13,143																																												
J	\$15,283																																												
L1	\$11,859																																												
L2	\$13,356																																												
<table border="1"> <thead> <tr> <th>Upholstery</th> <th colspan="2">Shipping</th> </tr> </thead> <tbody> <tr> <td>COM Ydg</td> <td>10</td> <td>Ctn Wt 247</td> </tr> <tr> <td>COL Sq Ft</td> <td>230</td> <td>Cu Ft 46</td> </tr> </tbody> </table>		Upholstery	Shipping		COM Ydg	10	Ctn Wt 247	COL Sq Ft	230	Cu Ft 46																																			
Upholstery	Shipping																																												
COM Ydg	10	Ctn Wt 247																																											
COL Sq Ft	230	Cu Ft 46																																											
Three Seat Low Back 	CTL3201 · armless · 20" individual seat width · COM based on single fabric · multiple fabrics, see pages CT6-CT8 for yardage requirements · double cut veneer available; specify and add \$128 list	<table border="1"> <thead> <tr> <th>Dimensions</th> <th>D</th> <th>W</th> <th>H</th> </tr> </thead> <tbody> <tr> <td>Overall</td> <td>32</td> <td>60</td> <td>30½</td> </tr> <tr> <td>Seat</td> <td>20</td> <td>60</td> <td>18</td> </tr> </tbody> </table>	Dimensions	D	W	H	Overall	32	60	30½	Seat	20	60	18	<table border="1"> <tbody> <tr><td>COM</td><td>\$4,686</td></tr> <tr><td>A</td><td>\$4,908</td></tr> <tr><td>B</td><td>\$5,206</td></tr> <tr><td>COL/C</td><td>\$5,729</td></tr> <tr><td>D</td><td>\$6,407</td></tr> <tr><td>E</td><td>\$7,079</td></tr> <tr><td>F</td><td>\$8,129</td></tr> <tr><td>G</td><td>\$9,251</td></tr> <tr><td>H</td><td>\$10,450</td></tr> <tr><td>I</td><td>\$12,320</td></tr> <tr><td>J</td><td>\$14,566</td></tr> <tr><td>L1</td><td>\$10,971</td></tr> <tr><td>L2</td><td>\$12,543</td></tr> </tbody> </table>	COM	\$4,686	A	\$4,908	B	\$5,206	COL/C	\$5,729	D	\$6,407	E	\$7,079	F	\$8,129	G	\$9,251	H	\$10,450	I	\$12,320	J	\$14,566	L1	\$10,971	L2	\$12,543				
		Dimensions	D	W	H																																								
Overall	32	60	30½																																										
Seat	20	60	18																																										
COM	\$4,686																																												
A	\$4,908																																												
B	\$5,206																																												
COL/C	\$5,729																																												
D	\$6,407																																												
E	\$7,079																																												
F	\$8,129																																												
G	\$9,251																																												
H	\$10,450																																												
I	\$12,320																																												
J	\$14,566																																												
L1	\$10,971																																												
L2	\$12,543																																												
<table border="1"> <thead> <tr> <th>Upholstery</th> <th colspan="2">Shipping</th> </tr> </thead> <tbody> <tr> <td>COM Ydg</td> <td>10½</td> <td>Ctn Wt 141</td> </tr> <tr> <td>COL Sq Ft</td> <td>242</td> <td>Cu Ft 31</td> </tr> </tbody> </table>		Upholstery	Shipping		COM Ydg	10½	Ctn Wt 141	COL Sq Ft	242	Cu Ft 31																																			
Upholstery	Shipping																																												
COM Ydg	10½	Ctn Wt 141																																											
COL Sq Ft	242	Cu Ft 31																																											

Description	Model	Specifications			List Price Per Grade		
		Dimensions	D	W	H	COM	COL/C
Three Seat Low Back 	CTL3301 <ul style="list-style-type: none"> armless 30" individual seat width COM based on single fabric multiple fabrics, see pages CT6-CT8 for yardage requirements double cut veneer available; specify and add \$128 list 	Overall	32	90	30½	A	\$5,100
		Seat	20	90	18	B	\$5,328
						C	\$5,628
						D	\$6,153
						E	\$6,826
						F	\$7,502
						G	\$8,550
						H	\$9,671
						I	\$10,871
						J	\$12,740
				L1	\$14,988		
				L2	\$11,395		
					\$12,966		
Three Seat Mid Back 	CTL3302 <ul style="list-style-type: none"> armless 30" individual seat width COM based on single fabric multiple fabrics, see pages CT6-CT8 for yardage requirements double cut veneer available; specify and add \$128 list 	Overall	32	90	37½	A	\$5,704
		Seat	20	90	18	B	\$5,952
						C	\$6,272
						D	\$6,834
						E	\$7,557
						F	\$8,278
						G	\$9,404
						H	\$10,603
						I	\$11,889
						J	\$13,895
				L1	\$16,301		
				L2	\$12,449		
					\$14,136		

To Order, Specify:

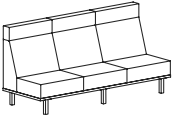
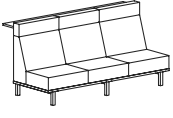
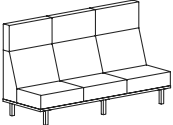
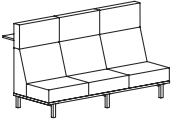
- 1 Model Number
- 2 Wood Species - Cherry (CH1), Maple (MA1), Walnut (WA1) or Double Cut (DC1)
- 3 Wood Finish See Wood Finish Options
- 4 Fabric Selection - vendor, pattern and color
 - A. Seat
 - B. Back
 - C. Arm
 - D. Headrest
 Visit www.jsifurniture.com/finishes-and-materials/textiles for our textiles program. See selection of standard and graded in manufacturers and patterns.
- 5 Metal Leg Color - See Metal Leg Color Options
- 6 Optional Wood Back Rail - available on any unit with two arms, specify and add \$192 list
- 7 Optional Power Center - Flush Mount (EC22) - Black (B) or White (W); \$583 list each, see page CT3 for location availability
- 8 Arm Cap - Wood (M) or Black 3D Laminate (B3L)
- 9 Optional Drink Holder(s) (DH) - add \$120 list each, indicate left or right arm
- 10 Optional Tablet Arm - indicate left (TBL) or right arm (TBR); flat cut add \$663 list, double cut add \$691 list
 - Optional Coordinating Wood Grain Laminate Available - no upcharge.
- 11 Finishes with an asterisk have a coordinating laminate available
- 12 Optional Rubber Cushion Nylon Glides - no upcharge
- 13 Product Options

Specifications

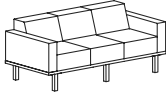
- Wood species - Cherry, Maple, Walnut or Double Cut. Seat has synthetic sheet webbing with cross strap reinforcement, 4¼" high density polyurethane foam.
- Back has high density polyurethane foam.
- Arms have ¾" thick top and ¼" thick side high density polyurethane foam.
- Plywood construction with locking tenons, glue and screws.
- Linking bracket included.
- Metal legs are 16 gauge steel tube with metal leveling glides.

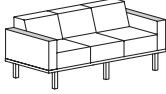
Connect Modular Lounge



Description	① Model	Specifications	List Price Per Grade												
Three Seat High Back 	CTL3303 · armless · 30" individual seat width · 7" high headrest · COM based on single fabric · multiple fabrics, see pages CT6-CT8 for yardage requirements · double cut veneer available; specify and add \$128 list	<table border="1"> <thead> <tr> <th>Dimensions</th> <th>D</th> <th>W</th> <th>H</th> </tr> </thead> <tbody> <tr> <td>Overall</td> <td>32</td> <td>90</td> <td>44 ½</td> </tr> <tr> <td>Seat</td> <td>20</td> <td>90</td> <td>18</td> </tr> </tbody> </table>	Dimensions	D	W	H	Overall	32	90	44 ½	Seat	20	90	18	COM \$6,279 A \$6,569 B \$6,952 COL/C \$7,625 D \$8,492 E \$9,362 F \$10,709 G \$12,152 H \$13,691 I \$16,097 J \$18,988 L1 \$14,366 L2 \$16,386
		Dimensions	D	W	H										
Overall	32	90	44 ½												
Seat	20	90	18												
<table border="1"> <thead> <tr> <th>Upholstery</th> <th colspan="3">Shipping</th> </tr> </thead> <tbody> <tr> <td>COM Ydg</td> <td>13 ½</td> <td>Ctn Wt</td> <td>226</td> </tr> <tr> <td>COL Sq Ft</td> <td>311</td> <td>Cu Ft</td> <td>71</td> </tr> </tbody> </table>	Upholstery	Shipping			COM Ydg	13 ½	Ctn Wt	226	COL Sq Ft	311	Cu Ft	71			
Upholstery	Shipping														
COM Ydg	13 ½	Ctn Wt	226												
COL Sq Ft	311	Cu Ft	71												
Three Seat High Back with Stand Up Surface 	CTL3304 · armless · stand up surface corner; specify square (S) no upcharge or rounded (R) add \$49 list · stand up surface · 30" individual seat width · 7" high headrest · 41 ¾" high stand up surface · COM based on single fabric · multiple fabrics, see pages CT6-CT8 for yardage requirements · double cut veneer available; specify and add \$128 list	<table border="1"> <thead> <tr> <th>Dimensions</th> <th>D</th> <th>W</th> <th>H</th> </tr> </thead> <tbody> <tr> <td>Overall</td> <td>42</td> <td>90</td> <td>44 ½</td> </tr> <tr> <td>Seat</td> <td>20</td> <td>90</td> <td>18</td> </tr> </tbody> </table>	Dimensions	D	W	H	Overall	42	90	44 ½	Seat	20	90	18	COM \$8,104 A \$8,419 B \$8,805 COL/C \$9,480 D \$10,346 E \$11,212 F \$12,562 G \$14,002 H \$15,543 I \$17,950 J \$20,839 L1 \$16,218 L2 \$18,238
		Dimensions	D	W	H										
Overall	42	90	44 ½												
Seat	20	90	18												
<table border="1"> <thead> <tr> <th>Upholstery</th> <th colspan="3">Shipping</th> </tr> </thead> <tbody> <tr> <td>COM Ydg</td> <td>13 ½</td> <td>Ctn Wt</td> <td>277</td> </tr> <tr> <td>COL Sq Ft</td> <td>311</td> <td>Cu Ft</td> <td>83</td> </tr> </tbody> </table>	Upholstery	Shipping			COM Ydg	13 ½	Ctn Wt	277	COL Sq Ft	311	Cu Ft	83			
Upholstery	Shipping														
COM Ydg	13 ½	Ctn Wt	277												
COL Sq Ft	311	Cu Ft	83												
Three Seat Privacy Back 	CTL3305 · armless · 30" individual seat width · 14" high headrest · COM based on single fabric · multiple fabrics, see pages CT6-CT8 for yardage requirements · double cut veneer available; specify and add \$128 list	<table border="1"> <thead> <tr> <th>Dimensions</th> <th>D</th> <th>W</th> <th>H</th> </tr> </thead> <tbody> <tr> <td>Overall</td> <td>32</td> <td>90</td> <td>51 ½</td> </tr> <tr> <td>Seat</td> <td>20</td> <td>90</td> <td>18</td> </tr> </tbody> </table>	Dimensions	D	W	H	Overall	32	90	51 ½	Seat	20	90	18	COM \$6,854 A \$7,173 B \$7,600 COL/C \$8,350 D \$9,311 E \$10,274 F \$11,772 G \$13,377 H \$15,090 I \$17,763 J \$20,971 L1 \$15,837 L2 \$18,081
		Dimensions	D	W	H										
Overall	32	90	51 ½												
Seat	20	90	18												
<table border="1"> <thead> <tr> <th>Upholstery</th> <th colspan="3">Shipping</th> </tr> </thead> <tbody> <tr> <td>COM Ydg</td> <td>15</td> <td>Ctn Wt</td> <td>232</td> </tr> <tr> <td>COL Sq Ft</td> <td>345</td> <td>Cu Ft</td> <td>84</td> </tr> </tbody> </table>	Upholstery	Shipping			COM Ydg	15	Ctn Wt	232	COL Sq Ft	345	Cu Ft	84			
Upholstery	Shipping														
COM Ydg	15	Ctn Wt	232												
COL Sq Ft	345	Cu Ft	84												
Three Seat Privacy Back with Stand Up Surface 	CTL3306 · armless · stand up surface corner; specify square (S) no upcharge or rounded (R) add \$49 list · 30" individual seat width · 14" high headrest · 41 ¾" high stand up surface · COM based on single fabric · multiple fabrics, see pages CT6-CT8 for yardage requirements · double cut veneer available; specify and add \$128 list	<table border="1"> <thead> <tr> <th>Dimensions</th> <th>D</th> <th>W</th> <th>H</th> </tr> </thead> <tbody> <tr> <td>Overall</td> <td>42</td> <td>90</td> <td>51 ½</td> </tr> <tr> <td>Seat</td> <td>20</td> <td>90</td> <td>18</td> </tr> </tbody> </table>	Dimensions	D	W	H	Overall	42	90	51 ½	Seat	20	90	18	COM \$8,680 A \$9,025 B \$9,453 COL/C \$10,200 D \$11,165 E \$12,127 F \$13,625 G \$15,230 H \$16,943 I \$19,616 J \$22,824 L1 \$17,689 L2 \$19,934
		Dimensions	D	W	H										
Overall	42	90	51 ½												
Seat	20	90	18												
<table border="1"> <thead> <tr> <th>Upholstery</th> <th colspan="3">Shipping</th> </tr> </thead> <tbody> <tr> <td>COM Ydg</td> <td>15</td> <td>Ctn Wt</td> <td>283</td> </tr> <tr> <td>COL Sq Ft</td> <td>345</td> <td>Cu Ft</td> <td>96</td> </tr> </tbody> </table>	Upholstery	Shipping			COM Ydg	15	Ctn Wt	283	COL Sq Ft	345	Cu Ft	96			
Upholstery	Shipping														
COM Ydg	15	Ctn Wt	283												
COL Sq Ft	345	Cu Ft	96												

CONNECT

Description	① Model	Specifications			List Price Per Grade		
		Dimensions	D	W	H	COM	
Three Seat Low Back 	CTL3201U2 • upholstered arms • 5" arm width • 20" individual seat width • COM based on single fabric • multiple fabrics, see pages CT6-CT8 for yardage requirements • double cut veneer available; specify and add \$128 list	Overall	32	70	30½	COM	\$5,886
		Seat	20	60	18	COL/C	\$7,228
		Arm		5	24½	D	\$8,094
		Upholstery		Shipping		E	\$8,962
		COM Ydg	13½	Ctn Wt	175	F	\$10,310
		COL Sq Ft	311	Cu Ft	36	G	\$11,752
						H	\$13,295
						I	\$15,700
						J	\$18,590
						L1	\$13,966
						L2	\$15,985

Description	① Model	Specifications			List Price Per Grade		
		Dimensions	D	W	H	COM	
Three Seat Low Back 	CTL3201W2 • wood cap arms • 5" arm width • 20" individual seat width • COM based on single fabric • multiple fabrics, see pages CT6-CT8 for yardage requirements • double cut veneer available; specify and add \$191 list	Overall	32	70	30½	COM	\$6,271
		Seat	20	60	18	COL/C	\$7,619
		Arm		5	25	D	\$8,485
		Upholstery		Shipping		E	\$9,351
		COM Ydg	13½	Ctn Wt	175	F	\$10,700
		COL Sq Ft	311	Cu Ft	36	G	\$12,144
						H	\$13,683
						I	\$16,090
						J	\$18,980
						L1	\$14,358
						L2	\$16,379

To Order, Specify:

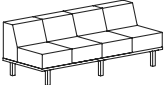
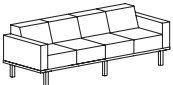
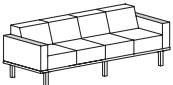
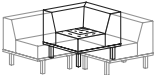



- ① Model Number
- ② Wood Species - Cherry (CH1), Maple (MA1), Walnut (WA1) or Double Cut (DC1)
- ③ Wood Finish [See Wood Finish Options](#)
- ④ Laminate Color Selection (Stand Up Surface) [See Laminate Color Selection](#)
- ⑤ Surface Corners (Stand Up Surface) - Square (S), no upcharge or Rounded (R), add \$49 list
- ⑥ Fabric Selection - vendor, pattern and color
 - A. Seat
 - B. Back
 - C. Arm
 - D. Headrest
 Visit www.jsifurniture.com/finishes-and-materials/textiles for our textiles program.
 See selection of standard and graded in manufacturers and patterns.
- ⑦ Metal Leg Color - [See Metal Leg Color Options](#)
- ⑧ Optional Wood Back Rail - available on any unit with two arms, specify and add \$192 list
- ⑨ Optional Power Center - Flush Mount (EC22) - Black (B) or White (W); \$583 list each, see page CT3 for location availability
- ⑩ Arm Cap - Wood (M) or Black 3D Laminate (B3L)
- ⑪ Optional Drink Holder(s) (DH) - add \$120 list each, indicate left or right arm
- ⑫ Optional Tablet Arm - indicate left (TBL) or right arm (TBR); flat cut add \$663 list, double cut add \$691 list
 - Optional Coordinating Wood Grain Laminate Available - no upcharge.
- ⑬ Finishes with an asterisk have a coordinating laminate available
- ⑭ Optional Rubber Cushion Nylon Glides - no upcharge




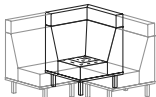


Specifications

- Wood species - Cherry, Maple, Walnut or Double Cut. Seat has synthetic sheet webbing with cross strap reinforcement, 4 ¼" high density polyurethane foam.
- Back has high density polyurethane foam.
- Arms have ¾" thick top and ¼" thick side high density polyurethane foam.
- Plywood construction with locking tenons, glue and screws.
- Linking bracket included.
- Metal legs are 16 gauge steel tube with metal leveling glides.
- ¾" thick 10" deep laminate stand up surface with coordinating 3mm PVC edge supported by steel columns, 42" surface height.

Connect Modular Lounge



Description	① Model	Specifications	List Price Per Grade																												
Four Seat Low Back 	CTL4201 · armless · 20" individual seat width · COM based on single fabric · multiple fabrics, see pages CT6-CT8 for yardage requirements · double cut veneer available; specify and add \$128 list	<table border="1"> <thead> <tr> <th>Dimensions</th> <th>D</th> <th>W</th> <th>H</th> </tr> </thead> <tbody> <tr> <td>Overall</td> <td>32</td> <td>80</td> <td>30½</td> </tr> <tr> <td>Seat</td> <td>20</td> <td>80</td> <td>18</td> </tr> </tbody> </table>	Dimensions	D	W	H	Overall	32	80	30½	Seat	20	80	18	<table border="1"> <thead> <tr> <th colspan="2">Upholstery</th> <th colspan="2">Shipping</th> </tr> </thead> <tbody> <tr> <td>COM Ydg</td> <td>14</td> <td>Ctn Wt</td> <td>194</td> </tr> <tr> <td>COL Sq Ft</td> <td>322</td> <td>Cu Ft</td> <td>41</td> </tr> </tbody> </table>	Upholstery		Shipping		COM Ydg	14	Ctn Wt	194	COL Sq Ft	322	Cu Ft	41				
		Dimensions	D	W	H																										
Overall	32	80	30½																												
Seat	20	80	18																												
Upholstery		Shipping																													
COM Ydg	14	Ctn Wt	194																												
COL Sq Ft	322	Cu Ft	41																												
			<table border="1"> <tbody> <tr><td>COM</td><td>\$6,235</td></tr> <tr><td>A</td><td>\$6,530</td></tr> <tr><td>B</td><td>\$6,929</td></tr> <tr><td>COL/C</td><td>\$7,626</td></tr> <tr><td>D</td><td>\$8,526</td></tr> <tr><td>E</td><td>\$9,425</td></tr> <tr><td>F</td><td>\$10,822</td></tr> <tr><td>G</td><td>\$12,320</td></tr> <tr><td>H</td><td>\$13,918</td></tr> <tr><td>I</td><td>\$16,414</td></tr> <tr><td>J</td><td>\$19,409</td></tr> <tr><td>L1</td><td>\$14,615</td></tr> <tr><td>L2</td><td>\$16,713</td></tr> </tbody> </table>	COM	\$6,235	A	\$6,530	B	\$6,929	COL/C	\$7,626	D	\$8,526	E	\$9,425	F	\$10,822	G	\$12,320	H	\$13,918	I	\$16,414	J	\$19,409	L1	\$14,615	L2	\$16,713		
COM	\$6,235																														
A	\$6,530																														
B	\$6,929																														
COL/C	\$7,626																														
D	\$8,526																														
E	\$9,425																														
F	\$10,822																														
G	\$12,320																														
H	\$13,918																														
I	\$16,414																														
J	\$19,409																														
L1	\$14,615																														
L2	\$16,713																														
Four Seat Low Back 	CTL4201U2 · upholstered arms · 5" arm width · 20" individual seat width · COM based on single fabric · multiple fabrics, see pages CT6-CT8 for yardage requirements · double cut veneer available; specify and add \$128 list	<table border="1"> <thead> <tr> <th>Dimensions</th> <th>D</th> <th>W</th> <th>H</th> </tr> </thead> <tbody> <tr> <td>Overall</td> <td>32</td> <td>90</td> <td>30½</td> </tr> <tr> <td>Seat</td> <td>20</td> <td>80</td> <td>18</td> </tr> <tr> <td>Arm</td> <td></td> <td>5</td> <td>24½</td> </tr> </tbody> </table>	Dimensions	D	W	H	Overall	32	90	30½	Seat	20	80	18	Arm		5	24½	<table border="1"> <thead> <tr> <th colspan="2">Upholstery</th> <th colspan="2">Shipping</th> </tr> </thead> <tbody> <tr> <td>COM Ydg</td> <td>17</td> <td>Ctn Wt</td> <td>206</td> </tr> <tr> <td>COL Sq Ft</td> <td>391</td> <td>Cu Ft</td> <td>46</td> </tr> </tbody> </table>	Upholstery		Shipping		COM Ydg	17	Ctn Wt	206	COL Sq Ft	391	Cu Ft	46
		Dimensions	D	W	H																										
Overall	32	90	30½																												
Seat	20	80	18																												
Arm		5	24½																												
Upholstery		Shipping																													
COM Ydg	17	Ctn Wt	206																												
COL Sq Ft	391	Cu Ft	46																												
			<table border="1"> <tbody> <tr><td>COM</td><td>\$7,456</td></tr> <tr><td>A</td><td>\$7,808</td></tr> <tr><td>B</td><td>\$8,295</td></tr> <tr><td>COL/C</td><td>\$9,143</td></tr> <tr><td>D</td><td>\$10,234</td></tr> <tr><td>E</td><td>\$11,326</td></tr> <tr><td>F</td><td>\$13,021</td></tr> <tr><td>G</td><td>\$14,841</td></tr> <tr><td>H</td><td>\$16,781</td></tr> <tr><td>I</td><td>\$19,812</td></tr> <tr><td>J</td><td>\$23,447</td></tr> <tr><td>L1</td><td>\$17,629</td></tr> <tr><td>L2</td><td>\$20,174</td></tr> </tbody> </table>	COM	\$7,456	A	\$7,808	B	\$8,295	COL/C	\$9,143	D	\$10,234	E	\$11,326	F	\$13,021	G	\$14,841	H	\$16,781	I	\$19,812	J	\$23,447	L1	\$17,629	L2	\$20,174		
COM	\$7,456																														
A	\$7,808																														
B	\$8,295																														
COL/C	\$9,143																														
D	\$10,234																														
E	\$11,326																														
F	\$13,021																														
G	\$14,841																														
H	\$16,781																														
I	\$19,812																														
J	\$23,447																														
L1	\$17,629																														
L2	\$20,174																														
Four Seat Low Back 	CTL4201W2 · wood cap arms · 5" arm width · 20" individual seat width · COM based on single fabric · multiple fabrics, see pages CT6-CT8 for yardage requirements · double cut veneer available; specify and add \$191 list	<table border="1"> <thead> <tr> <th>Dimensions</th> <th>D</th> <th>W</th> <th>H</th> </tr> </thead> <tbody> <tr> <td>Overall</td> <td>32</td> <td>90</td> <td>30½</td> </tr> <tr> <td>Seat</td> <td>20</td> <td>80</td> <td>18</td> </tr> <tr> <td>Arm</td> <td></td> <td>5</td> <td>25</td> </tr> </tbody> </table>	Dimensions	D	W	H	Overall	32	90	30½	Seat	20	80	18	Arm		5	25	<table border="1"> <thead> <tr> <th colspan="2">Upholstery</th> <th colspan="2">Shipping</th> </tr> </thead> <tbody> <tr> <td>COM Ydg</td> <td>17</td> <td>Ctn Wt</td> <td>216</td> </tr> <tr> <td>COL Sq Ft</td> <td>391</td> <td>Cu Ft</td> <td>46</td> </tr> </tbody> </table>	Upholstery		Shipping		COM Ydg	17	Ctn Wt	216	COL Sq Ft	391	Cu Ft	46
		Dimensions	D	W	H																										
Overall	32	90	30½																												
Seat	20	80	18																												
Arm		5	25																												
Upholstery		Shipping																													
COM Ydg	17	Ctn Wt	216																												
COL Sq Ft	391	Cu Ft	46																												
			<table border="1"> <tbody> <tr><td>COM</td><td>\$7,837</td></tr> <tr><td>A</td><td>\$8,199</td></tr> <tr><td>B</td><td>\$8,684</td></tr> <tr><td>COL/C</td><td>\$9,530</td></tr> <tr><td>D</td><td>\$10,622</td></tr> <tr><td>E</td><td>\$11,714</td></tr> <tr><td>F</td><td>\$13,411</td></tr> <tr><td>G</td><td>\$15,230</td></tr> <tr><td>H</td><td>\$17,171</td></tr> <tr><td>I</td><td>\$20,199</td></tr> <tr><td>J</td><td>\$23,836</td></tr> <tr><td>L1</td><td>\$18,019</td></tr> <tr><td>L2</td><td>\$20,561</td></tr> </tbody> </table>	COM	\$7,837	A	\$8,199	B	\$8,684	COL/C	\$9,530	D	\$10,622	E	\$11,714	F	\$13,411	G	\$15,230	H	\$17,171	I	\$20,199	J	\$23,836	L1	\$18,019	L2	\$20,561		
COM	\$7,837																														
A	\$8,199																														
B	\$8,684																														
COL/C	\$9,530																														
D	\$10,622																														
E	\$11,714																														
F	\$13,411																														
G	\$15,230																														
H	\$17,171																														
I	\$20,199																														
J	\$23,836																														
L1	\$18,019																														
L2	\$20,561																														
Corner Seat Low Back 	CTC20S1UC CTC20S1UR CTC20S1UL · armless · 20" seat width · COM based on single fabric · multiple fabrics, see pages CT6-CT8 for yardage requirements · double cut veneer available; specify and add \$128 list	<table border="1"> <thead> <tr> <th>Dimensions</th> <th>D</th> <th>W</th> <th>H</th> </tr> </thead> <tbody> <tr> <td>Overall</td> <td>32</td> <td>32</td> <td>30½</td> </tr> <tr> <td>Seat</td> <td>20</td> <td>20</td> <td>18</td> </tr> </tbody> </table>	Dimensions	D	W	H	Overall	32	32	30½	Seat	20	20	18	<table border="1"> <thead> <tr> <th colspan="2">Upholstery</th> <th colspan="2">Shipping</th> </tr> </thead> <tbody> <tr> <td>COM Ydg</td> <td>4</td> <td>Ctn Wt</td> <td>90</td> </tr> <tr> <td>COL Sq Ft</td> <td>92</td> <td>Cu Ft</td> <td>17</td> </tr> </tbody> </table>	Upholstery		Shipping		COM Ydg	4	Ctn Wt	90	COL Sq Ft	92	Cu Ft	17				
		Dimensions	D	W	H																										
Overall	32	32	30½																												
Seat	20	20	18																												
Upholstery		Shipping																													
COM Ydg	4	Ctn Wt	90																												
COL Sq Ft	92	Cu Ft	17																												
<div style="display: flex; justify-content: space-around;"> <div style="text-align: center;">  CTC20S1UC center </div> <div style="text-align: center;">  CTC20S1UR right </div> <div style="text-align: center;">  CTC20S1UL left </div> </div>			<table border="1"> <tbody> <tr><td>COM</td><td>\$3,336</td></tr> <tr><td>A</td><td>\$3,443</td></tr> <tr><td>B</td><td>\$3,558</td></tr> <tr><td>COL/C</td><td>\$3,756</td></tr> <tr><td>D</td><td>\$4,014</td></tr> <tr><td>E</td><td>\$4,270</td></tr> <tr><td>F</td><td>\$4,670</td></tr> <tr><td>G</td><td>\$5,098</td></tr> <tr><td>H</td><td>\$5,557</td></tr> <tr><td>I</td><td>\$6,267</td></tr> <tr><td>J</td><td>\$7,125</td></tr> <tr><td>L1</td><td>\$5,755</td></tr> <tr><td>L2</td><td>\$6,352</td></tr> </tbody> </table>	COM	\$3,336	A	\$3,443	B	\$3,558	COL/C	\$3,756	D	\$4,014	E	\$4,270	F	\$4,670	G	\$5,098	H	\$5,557	I	\$6,267	J	\$7,125	L1	\$5,755	L2	\$6,352		
COM	\$3,336																														
A	\$3,443																														
B	\$3,558																														
COL/C	\$3,756																														
D	\$4,014																														
E	\$4,270																														
F	\$4,670																														
G	\$5,098																														
H	\$5,557																														
I	\$6,267																														
J	\$7,125																														
L1	\$5,755																														
L2	\$6,352																														

Description	Model	Specifications	List Price Per Grade																																																		
Corner Seat Mid Back  CTC20S2UC center  CTC20S2UR right  CTC20S2UL left	CTC20S2UC CTC20S2UR CTC20S2UL <ul style="list-style-type: none"> armless 20" seat width COM based on single fabric multiple fabrics, see pages CT6-CT8 for yardage requirements double cut veneer available; specify and add \$128 list 	<table border="1"> <thead> <tr> <th>Dimensions</th> <th>D</th> <th>W</th> <th>H</th> </tr> </thead> <tbody> <tr> <td>Overall</td> <td>32</td> <td>32</td> <td>37½</td> </tr> <tr> <td>Seat</td> <td>20</td> <td>20</td> <td>18</td> </tr> <tr> <th colspan="2">Upholstery</th> <th colspan="2">Shipping</th> </tr> <tr> <td>COM Ydg</td> <td>4½</td> <td>Ctn Wt</td> <td>95</td> </tr> <tr> <td>COL Sq Ft</td> <td>104</td> <td>Cu Ft</td> <td>22</td> </tr> </tbody> </table>	Dimensions	D	W	H	Overall	32	32	37½	Seat	20	20	18	Upholstery		Shipping		COM Ydg	4½	Ctn Wt	95	COL Sq Ft	104	Cu Ft	22	<table> <tr> <td>COM</td> <td>\$3,451</td> </tr> <tr> <td>A</td> <td>\$3,567</td> </tr> <tr> <td>B</td> <td>\$3,698</td> </tr> <tr> <td>COL/C</td> <td>\$3,920</td> </tr> <tr> <td>D</td> <td>\$4,210</td> </tr> <tr> <td>E</td> <td>\$4,499</td> </tr> <tr> <td>F</td> <td>\$4,949</td> </tr> <tr> <td>G</td> <td>\$5,428</td> </tr> <tr> <td>H</td> <td>\$5,943</td> </tr> <tr> <td>I</td> <td>\$6,744</td> </tr> <tr> <td>J</td> <td>\$7,710</td> </tr> <tr> <td>L1</td> <td>\$6,167</td> </tr> <tr> <td>L2</td> <td>\$6,840</td> </tr> </table>	COM	\$3,451	A	\$3,567	B	\$3,698	COL/C	\$3,920	D	\$4,210	E	\$4,499	F	\$4,949	G	\$5,428	H	\$5,943	I	\$6,744	J	\$7,710	L1	\$6,167	L2	\$6,840
		Dimensions	D	W	H																																																
Overall	32	32	37½																																																		
Seat	20	20	18																																																		
Upholstery		Shipping																																																			
COM Ydg	4½	Ctn Wt	95																																																		
COL Sq Ft	104	Cu Ft	22																																																		
COM	\$3,451																																																				
A	\$3,567																																																				
B	\$3,698																																																				
COL/C	\$3,920																																																				
D	\$4,210																																																				
E	\$4,499																																																				
F	\$4,949																																																				
G	\$5,428																																																				
H	\$5,943																																																				
I	\$6,744																																																				
J	\$7,710																																																				
L1	\$6,167																																																				
L2	\$6,840																																																				
Corner Seat High Back  CTC20S3UC center  CTC20S3UR right  CTC20S3UL left	CTC20S3UC CTC20S3UR CTC20S3UL <ul style="list-style-type: none"> armless 20" seat width 7" high headrest COM based on single fabric multiple fabrics, see pages CT6-CT8 for yardage requirements double cut veneer available; specify and add \$128 list 	<table border="1"> <thead> <tr> <th>Dimensions</th> <th>D</th> <th>W</th> <th>H</th> </tr> </thead> <tbody> <tr> <td>Overall</td> <td>32</td> <td>32</td> <td>44½</td> </tr> <tr> <td>Seat</td> <td>20</td> <td>20</td> <td>18</td> </tr> <tr> <th colspan="2">Upholstery</th> <th colspan="2">Shipping</th> </tr> <tr> <td>COM Ydg</td> <td>6¼</td> <td>Ctn Wt</td> <td>115</td> </tr> <tr> <td>COL Sq Ft</td> <td>144</td> <td>Cu Ft</td> <td>26</td> </tr> </tbody> </table>	Dimensions	D	W	H	Overall	32	32	44½	Seat	20	20	18	Upholstery		Shipping		COM Ydg	6¼	Ctn Wt	115	COL Sq Ft	144	Cu Ft	26	<table> <tr> <td>COM</td> <td>\$3,566</td> </tr> <tr> <td>A</td> <td>\$3,709</td> </tr> <tr> <td>B</td> <td>\$3,887</td> </tr> <tr> <td>COL/C</td> <td>\$4,199</td> </tr> <tr> <td>D</td> <td>\$4,601</td> </tr> <tr> <td>E</td> <td>\$5,001</td> </tr> <tr> <td>F</td> <td>\$5,627</td> </tr> <tr> <td>G</td> <td>\$6,296</td> </tr> <tr> <td>H</td> <td>\$7,006</td> </tr> <tr> <td>I</td> <td>\$8,121</td> </tr> <tr> <td>J</td> <td>\$9,459</td> </tr> <tr> <td>L1</td> <td>\$7,320</td> </tr> <tr> <td>L2</td> <td>\$8,255</td> </tr> </table>	COM	\$3,566	A	\$3,709	B	\$3,887	COL/C	\$4,199	D	\$4,601	E	\$5,001	F	\$5,627	G	\$6,296	H	\$7,006	I	\$8,121	J	\$9,459	L1	\$7,320	L2	\$8,255
		Dimensions	D	W	H																																																
Overall	32	32	44½																																																		
Seat	20	20	18																																																		
Upholstery		Shipping																																																			
COM Ydg	6¼	Ctn Wt	115																																																		
COL Sq Ft	144	Cu Ft	26																																																		
COM	\$3,566																																																				
A	\$3,709																																																				
B	\$3,887																																																				
COL/C	\$4,199																																																				
D	\$4,601																																																				
E	\$5,001																																																				
F	\$5,627																																																				
G	\$6,296																																																				
H	\$7,006																																																				
I	\$8,121																																																				
J	\$9,459																																																				
L1	\$7,320																																																				
L2	\$8,255																																																				

To Order, Specify:

- 1 Model Number
- 2 Wood Species - Cherry (CH1), Maple (MA1), Walnut (WA1) or Double Cut (DC1)
- 3 Wood Finish [See Wood Finish Options](#)
- 4 Laminate Color Selection (Stand Up Surface) [See Laminate Color Selection](#)
- 5 Surface Corners (Stand Up Surface) - Square (S), no upcharge or Rounded (R), add \$49 list
- 6 Fabric Selection - vendor, pattern and color
 - A. Seat
 - B. Back
 - C. Arm
 - D. Headrest













Visit www.jsifurniture.com/finishes-and-materials/textiles for our textiles program.
See selection of standard and graded in manufacturers and patterns.
- 7 Metal Leg Color - [See Metal Leg Color Options](#)
- 8 Optional Wood Back Rail - available on any unit with two arms, specify and add \$192 list
- 9 Optional Power Center - Flush Mount (EC22) - Black (B) or White (W); \$583 list
- 11 each, see page CT3 for location availability
- 10 Arm Cap - Wood (M) or Black 3D Laminate (B3L)
- 11 Optional Drink Holder(s) (DH) - add \$120 list each, indicate left or right arm
- 10 Optional Tablet Arm - indicate left (TBL) or right arm (TBR); flat cut add \$663 list, double cut add \$691 list
- Optional Coordinating Wood Grain Laminate Available - no upcharge.
- 13 Finishes with an asterisk have a coordinating laminate available
- 14 Optional Rubber Cushion Nylon Glides - no upcharge

Specifications

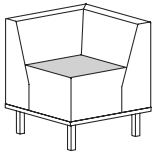
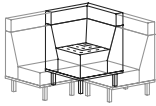


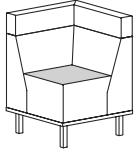
- Wood species - Cherry, Maple, Walnut or Double Cut. Seat has synthetic sheet webbing with cross strap reinforcement, 4¼" high density polyurethane foam.
- Back has high density polyurethane foam.
- Arms have ¾" thick top and ¼" thick side high density polyurethane foam.
- Plywood construction with locking tenons, glue and screws.
- Linking bracket included.
- Metal legs are 16 gauge steel tube with metal leveling glides.
- ¾" thick 10" deep laminate stand up surface with coordinating 3mm PVC edge supported by steel columns, 42" surface height.

Connect Modular Lounge



Description	Model	Specifications	List Price Per Grade																		
Corner Seat High Back with Stand Up Surface  CTC20S4UC center  CTC20S4UR right  CTC20S4UL left	CTC20S4UC CTC20S4UR CTC20S4UL <ul style="list-style-type: none"> · armless · stand up surface corner; specify square (S) no upcharge or rounded (R) add \$93 list · 20" seat width · 7" high headrest · 41 ¾" high stand up surface · COM based on single fabric · multiple fabrics, see pages CT6-CT8 for yardage requirements · double cut veneer available; specify and add \$128 list 	<table border="1"> <thead> <tr> <th>Dimensions</th> <th>D</th> <th>W</th> <th>H</th> </tr> </thead> <tbody> <tr> <td>Overall</td> <td>42</td> <td>42</td> <td>44 ½</td> </tr> <tr> <td>Seat</td> <td>20</td> <td>20</td> <td>18</td> </tr> </tbody> </table> <table border="1"> <thead> <tr> <th>Upholstery</th> <th>Shipping</th> </tr> </thead> <tbody> <tr> <td>COM Ydg</td> <td>6 ¼ Ctn Wt 153</td> </tr> <tr> <td>COL Sq Ft</td> <td>144 Cu Ft 38</td> </tr> </tbody> </table>	Dimensions	D	W	H	Overall	42	42	44 ½	Seat	20	20	18	Upholstery	Shipping	COM Ydg	6 ¼ Ctn Wt 153	COL Sq Ft	144 Cu Ft 38	COM \$5,938 A \$6,119 B \$6,298 COL/C \$6,609 D \$7,011 E \$7,411 F \$8,039 G \$8,704 H \$9,416 I \$10,532 J \$11,869 L1 \$9,729 L2 \$10,666
		Dimensions	D	W	H																
		Overall	42	42	44 ½																
Seat	20	20	18																		
Upholstery	Shipping																				
COM Ydg	6 ¼ Ctn Wt 153																				
COL Sq Ft	144 Cu Ft 38																				
Corner Seat Privacy Back  CTC20S5UC center  CTC20S5UR right  CTC20S5UL left	CTC20S5UC CTC20S5UR CTC20S5UL <ul style="list-style-type: none"> · armless · 20" seat width · 14" high headrest · COM based on single fabric · multiple fabrics, see pages CT6-CT8 for yardage requirements · double cut veneer available; specify and add \$128 list 	<table border="1"> <thead> <tr> <th>Dimensions</th> <th>D</th> <th>W</th> <th>H</th> </tr> </thead> <tbody> <tr> <td>Overall</td> <td>32</td> <td>32</td> <td>51 ½</td> </tr> <tr> <td>Seat</td> <td>20</td> <td>20</td> <td>18</td> </tr> </tbody> </table> <table border="1"> <thead> <tr> <th>Upholstery</th> <th>Shipping</th> </tr> </thead> <tbody> <tr> <td>COM Ydg</td> <td>7 Ctn Wt 125</td> </tr> <tr> <td>COL Sq Ft</td> <td>161 Cu Ft 31</td> </tr> </tbody> </table>	Dimensions	D	W	H	Overall	32	32	51 ½	Seat	20	20	18	Upholstery	Shipping	COM Ydg	7 Ctn Wt 125	COL Sq Ft	161 Cu Ft 31	COM \$3,679 A \$3,837 B \$4,035 COL/C \$4,385 D \$4,835 E \$5,285 F \$5,983 G \$6,733 H \$7,531 I \$8,780 J \$10,276 L1 \$7,879 L2 \$8,928
		Dimensions	D	W	H																
		Overall	32	32	51 ½																
Seat	20	20	18																		
Upholstery	Shipping																				
COM Ydg	7 Ctn Wt 125																				
COL Sq Ft	161 Cu Ft 31																				
Corner Seat Privacy Back with Stand Up Surface  CTC20S6UC center  CTC20S6UR right  CTC20S6UL left	CTC20S6UC CTC20S6UR CTC20S6UL <ul style="list-style-type: none"> · armless · stand up surface corner; specify square (S) no upcharge or rounded (R) add \$93 list · 20" seat width · 14" high headrest · 41 ¾" high stand up surface · COM based on single fabric · multiple fabrics, see pages CT6-CT8 for yardage requirements · double cut veneer available; specify and add \$128 list 	<table border="1"> <thead> <tr> <th>Dimensions</th> <th>D</th> <th>W</th> <th>H</th> </tr> </thead> <tbody> <tr> <td>Overall</td> <td>42</td> <td>42</td> <td>51 ½</td> </tr> <tr> <td>Seat</td> <td>20</td> <td>20</td> <td>18</td> </tr> </tbody> </table> <table border="1"> <thead> <tr> <th>Upholstery</th> <th>Shipping</th> </tr> </thead> <tbody> <tr> <td>COM Ydg</td> <td>7 Ctn Wt 163</td> </tr> <tr> <td>COL Sq Ft</td> <td>161 Cu Ft 43</td> </tr> </tbody> </table>	Dimensions	D	W	H	Overall	42	42	51 ½	Seat	20	20	18	Upholstery	Shipping	COM Ydg	7 Ctn Wt 163	COL Sq Ft	161 Cu Ft 43	COM \$6,053 A \$6,247 B \$6,447 COL/C \$6,796 D \$7,245 E \$7,693 F \$8,392 G \$9,141 H \$9,942 I \$11,187 J \$12,685 L1 \$10,290 L2 \$11,336
		Dimensions	D	W	H																
		Overall	42	42	51 ½																
Seat	20	20	18																		
Upholstery	Shipping																				
COM Ydg	7 Ctn Wt 163																				
COL Sq Ft	161 Cu Ft 43																				
Corner Table Mid Back  CTC20T2UC center  CTC20T2UR right  CTC20T2UL left	CTC20T2UC CTC20T2UR CTC20T2UL <ul style="list-style-type: none"> · upholstered top · 23" table width · table height is same as arm height · COM based on single fabric · multiple fabrics, see pages CT6-CT8 for yardage requirements · double cut veneer available; specify and add \$128 list 	<table border="1"> <thead> <tr> <th>Dimensions</th> <th>D</th> <th>W</th> <th>H</th> </tr> </thead> <tbody> <tr> <td>Overall</td> <td>32</td> <td>32</td> <td>37 ½</td> </tr> <tr> <td>Table</td> <td>23</td> <td>23</td> <td>24 ½</td> </tr> </tbody> </table> <table border="1"> <thead> <tr> <th>Upholstery</th> <th>Shipping</th> </tr> </thead> <tbody> <tr> <td>COM Ydg</td> <td>4 ¾ Ctn Wt 115</td> </tr> <tr> <td>COL Sq Ft</td> <td>110 Cu Ft 22</td> </tr> </tbody> </table>	Dimensions	D	W	H	Overall	32	32	37 ½	Table	23	23	24 ½	Upholstery	Shipping	COM Ydg	4 ¾ Ctn Wt 115	COL Sq Ft	110 Cu Ft 22	COM \$3,497 A \$3,619 B \$3,753 COL/C \$3,990 D \$4,296 E \$4,600 F \$5,075 G \$5,581 H \$6,124 I \$6,973 J \$7,988 L1 \$6,363 L2 \$7,073
		Dimensions	D	W	H																
		Overall	32	32	37 ½																
Table	23	23	24 ½																		
Upholstery	Shipping																				
COM Ydg	4 ¾ Ctn Wt 115																				
COL Sq Ft	110 Cu Ft 22																				

CONNECT

Description	1 Model	Specifications	List Price Per Grade												
Corner Table Mid Back 	CTC20T2W • wood top • diagonal grain • 23" table width • table height is same as arm height • COM based on single fabric • multiple fabrics, see pages CT6-CT8 for yardage requirements • double cut veneer available; specify and add \$191 list	<table border="1"> <thead> <tr> <th>Dimensions</th> <th>D</th> <th>W</th> <th>H</th> </tr> </thead> <tbody> <tr> <td>Overall</td> <td>32</td> <td>32</td> <td>37½</td> </tr> <tr> <td>Table</td> <td>23</td> <td>23</td> <td>25</td> </tr> </tbody> </table>	Dimensions	D	W	H	Overall	32	32	37½	Table	23	23	25	COM \$3,725 A \$3,840 B \$3,955 COL/C \$4,153 D \$4,411 E \$4,668 F \$5,069 G \$5,494 H \$5,952 I \$6,664 J \$7,521 L1 \$6,152 L2 \$6,749
		Dimensions	D	W	H										
Overall	32	32	37½												
Table	23	23	25												
<table border="1"> <thead> <tr> <th>Upholstery</th> <th colspan="2">Shipping</th> </tr> </thead> <tbody> <tr> <td>COM Ydg</td> <td>4</td> <td>Ctn Wt 120</td> </tr> <tr> <td>COL Sq Ft</td> <td>92</td> <td>Cu Ft 22</td> </tr> </tbody> </table>	Upholstery	Shipping		COM Ydg	4	Ctn Wt 120	COL Sq Ft	92	Cu Ft 22						
Upholstery	Shipping														
COM Ydg	4	Ctn Wt 120													
COL Sq Ft	92	Cu Ft 22													
Corner Table High Back  CTC20T3UC center  CTC20T2UR right  CTC20T2UL left	CTC20T3UC CTC20T3UR CTC20T3UL • upholstered top • 23" table width • table height is same as arm height • COM based on single fabric • multiple fabrics, see pages CT6-CT8 for yardage requirements • double cut veneer available; specify and add \$128 list	<table border="1"> <thead> <tr> <th>Dimensions</th> <th>D</th> <th>W</th> <th>H</th> </tr> </thead> <tbody> <tr> <td>Overall</td> <td>32</td> <td>32</td> <td>44½</td> </tr> <tr> <td>Table</td> <td>23</td> <td>23</td> <td>24½</td> </tr> </tbody> </table>	Dimensions	D	W	H	Overall	32	32	44½	Table	23	23	24½	COM \$3,613 A \$3,759 B \$3,948 COL/C \$4,269 D \$4,687 E \$5,103 F \$5,754 G \$6,449 H \$7,189 I \$8,349 J \$9,739 L1 \$7,515 L2 \$8,486
		Dimensions	D	W	H										
Overall	32	32	44½												
Table	23	23	24½												
<table border="1"> <thead> <tr> <th>Upholstery</th> <th colspan="2">Shipping</th> </tr> </thead> <tbody> <tr> <td>COM Ydg</td> <td>6½</td> <td>Ctn Wt 135</td> </tr> <tr> <td>COL Sq Ft</td> <td>150</td> <td>Cu Ft 26</td> </tr> </tbody> </table>	Upholstery	Shipping		COM Ydg	6½	Ctn Wt 135	COL Sq Ft	150	Cu Ft 26						
Upholstery	Shipping														
COM Ydg	6½	Ctn Wt 135													
COL Sq Ft	150	Cu Ft 26													
Corner Table High Back 	CTC20T3W • wood top • diagonal grain • 23" table width • table height is same as arm height • COM based on single fabric • multiple fabrics, see pages CT6-CT8 for yardage requirements • double cut veneer available; specify and add \$191 list	<table border="1"> <thead> <tr> <th>Dimensions</th> <th>D</th> <th>W</th> <th>H</th> </tr> </thead> <tbody> <tr> <td>Overall</td> <td>32</td> <td>32</td> <td>44½</td> </tr> <tr> <td>Table</td> <td>23</td> <td>23</td> <td>25</td> </tr> </tbody> </table>	Dimensions	D	W	H	Overall	32	32	44½	Table	23	23	25	COM \$3,841 A \$3,983 B \$4,148 COL/C \$4,435 D \$4,802 E \$5,172 F \$5,746 G \$6,362 H \$7,018 I \$8,043 J \$9,271 L1 \$7,306 L2 \$8,164
Dimensions	D	W	H												
Overall	32	32	44½												
Table	23	23	25												
		<table border="1"> <thead> <tr> <th>Upholstery</th> <th colspan="2">Shipping</th> </tr> </thead> <tbody> <tr> <td>COM Ydg</td> <td>5¾</td> <td>Ctn Wt 140</td> </tr> <tr> <td>COL Sq Ft</td> <td>133</td> <td>Cu Ft 26</td> </tr> </tbody> </table>	Upholstery	Shipping		COM Ydg	5¾	Ctn Wt 140	COL Sq Ft	133	Cu Ft 26				
Upholstery	Shipping														
COM Ydg	5¾	Ctn Wt 140													
COL Sq Ft	133	Cu Ft 26													

To Order, Specify:




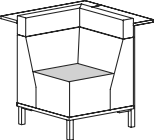
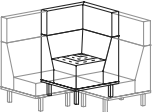


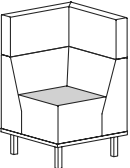
- 1 Model Number
- 2 Wood Species - Cherry (CH1), Maple (MA1), Walnut (WA1) or Double Cut (DC1)
- 3 Wood Finish [See Wood Finish Options](#)
- 4 Laminate Color Selection (Stand Up Surface) [See Laminate Color Selection](#)
- 5 Surface Corners (Stand Up Surface) - Square (S), no upcharge or Rounded (R), add \$93 list
- 6 Fabric Selection - vendor, pattern and color
 - A. Seat
 - B. Back
 - C. Headrest
 Visit www.jsifurniture.com/finishes-and-materials/textiles for our textiles program.
 See selection of standard and graded in manufacturers and patterns.
- 7 Metal Leg Color - [See Metal Leg Color Options](#)
- 8 Optional Coordinating Wood Grain Laminate Available on Table Tops - no upcharge. Finishes with an asterisk have a coordinating laminate available
- 9 Optional Rubber Cushion Nylon Glides - no upcharge
- 10 Product Options

Specifications




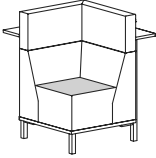
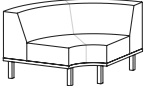
- Wood species - Cherry, Maple, Walnut or Double Cut. Seat has synthetic sheet webbing with cross strap reinforcement, 4 ¼" high density polyurethane foam.
- Back has high density polyurethane foam.
- Plywood construction with locking tenons, glue and screws.
- Linking bracket included.
- Metal legs are 16 gauge steel tube with metal leveling glides.
- ¾" thick 10" deep laminate stand up surface with coordinating 3mm PVC edge supported by steel columns, 42" surface height.

Connect Modular Lounge



Description	Model	Specifications	List Price Per Grade												
Corner Table High Back with Stand Up Surface  CTC20T4UC center	CTC20T4UC CTC20T4UR CTC20T4UL <ul style="list-style-type: none"> · upholstered top · stand up surface corner; specify square (S) no upcharge or rounded (R) add \$93 list · 23" table width · 41 3/4" high stand up surface · table height is same as arm height · COM based on single fabric · multiple fabrics, see pages CT6-CT8 for yardage requirements · double cut veneer available; specify and add \$128 list 	<table border="1"> <thead> <tr> <th>Dimensions</th> <th>D</th> <th>W</th> <th>H</th> </tr> </thead> <tbody> <tr> <td>Overall</td> <td>42</td> <td>42</td> <td>44 1/2</td> </tr> <tr> <td>Table</td> <td>23</td> <td>23</td> <td>24 1/4</td> </tr> </tbody> </table>	Dimensions	D	W	H	Overall	42	42	44 1/2	Table	23	23	24 1/4	COM \$5,984 A \$6,168 B \$6,353 COL/C \$6,678 D \$7,096 E \$7,512 F \$8,163 G \$8,855 H \$9,600 I \$10,758 J \$12,149 L1 \$9,922 L2 \$10,896
		Dimensions	D	W	H										
		Overall	42	42	44 1/2										
Table	23	23	24 1/4												
<table border="1"> <thead> <tr> <th>Upholstery</th> <th colspan="3">Shipping</th> </tr> </thead> <tbody> <tr> <td>COM Ydg</td> <td>6 1/2</td> <td>Ctn Wt</td> <td>173</td> </tr> <tr> <td>COL Sq Ft</td> <td>150</td> <td>Cu Ft</td> <td>38</td> </tr> </tbody> </table>	Upholstery	Shipping			COM Ydg	6 1/2	Ctn Wt	173	COL Sq Ft	150	Cu Ft	38			
Upholstery	Shipping														
COM Ydg	6 1/2	Ctn Wt	173												
COL Sq Ft	150	Cu Ft	38												
 CTC20T4UR right	 CTC20T4UL left														
Corner Table High Back with Stand Up Surface 	CTC20T4W <ul style="list-style-type: none"> · wood top · stand up surface corner; specify square (S) no upcharge or rounded (R) add \$93 list · diagonal grain · 23" table width · 41 3/4" high stand up surface · table height is same as arm height · COM based on single fabric · multiple fabrics, see pages CT6-CT8 for yardage requirements · double cut veneer available; specify and add \$191 list 	<table border="1"> <thead> <tr> <th>Dimensions</th> <th>D</th> <th>W</th> <th>H</th> </tr> </thead> <tbody> <tr> <td>Overall</td> <td>42</td> <td>42</td> <td>44 1/2</td> </tr> <tr> <td>Table</td> <td>23</td> <td>23</td> <td>25</td> </tr> </tbody> </table>	Dimensions	D	W	H	Overall	42	42	44 1/2	Table	23	23	25	COM \$6,215 A \$6,392 B \$6,554 COL/C \$6,842 D \$7,212 E \$7,581 F \$8,155 G \$8,768 H \$9,425 I \$10,451 J \$11,680 L1 \$9,712 L2 \$10,573
		Dimensions	D	W	H										
		Overall	42	42	44 1/2										
Table	23	23	25												
<table border="1"> <thead> <tr> <th>Upholstery</th> <th colspan="3">Shipping</th> </tr> </thead> <tbody> <tr> <td>COM Ydg</td> <td>5 3/4</td> <td>Ctn Wt</td> <td>178</td> </tr> <tr> <td>COL Sq Ft</td> <td>133</td> <td>Cu Ft</td> <td>38</td> </tr> </tbody> </table>	Upholstery	Shipping			COM Ydg	5 3/4	Ctn Wt	178	COL Sq Ft	133	Cu Ft	38			
Upholstery	Shipping														
COM Ydg	5 3/4	Ctn Wt	178												
COL Sq Ft	133	Cu Ft	38												
Corner Table Privacy Back  CTC20T5UC center	CTC20T5UC CTC20T5UR CTC20T5UL <ul style="list-style-type: none"> · upholstered top · 23" table width · table height is same as arm height · COM based on single fabric · multiple fabrics, see pages CT6-CT8 for yardage requirements · double cut veneer available; specify and add \$128 list 	<table border="1"> <thead> <tr> <th>Dimensions</th> <th>D</th> <th>W</th> <th>H</th> </tr> </thead> <tbody> <tr> <td>Overall</td> <td>32</td> <td>32</td> <td>51 1/2</td> </tr> <tr> <td>Table</td> <td>23</td> <td>23</td> <td>24 1/2</td> </tr> </tbody> </table>	Dimensions	D	W	H	Overall	32	32	51 1/2	Table	23	23	24 1/2	COM \$3,725 A \$3,887 B \$4,096 COL/C \$4,458 D \$4,923 E \$5,386 F \$6,112 G \$6,886 H \$7,714 I \$9,007 J \$10,555 L1 \$8,076 L2 \$9,159
		Dimensions	D	W	H										
		Overall	32	32	51 1/2										
Table	23	23	24 1/2												
<table border="1"> <thead> <tr> <th>Upholstery</th> <th colspan="3">Shipping</th> </tr> </thead> <tbody> <tr> <td>COM Ydg</td> <td>7 1/4</td> <td>Ctn Wt</td> <td>148</td> </tr> <tr> <td>COL Sq Ft</td> <td>167</td> <td>Cu Ft</td> <td>31</td> </tr> </tbody> </table>	Upholstery	Shipping			COM Ydg	7 1/4	Ctn Wt	148	COL Sq Ft	167	Cu Ft	31			
Upholstery	Shipping														
COM Ydg	7 1/4	Ctn Wt	148												
COL Sq Ft	167	Cu Ft	31												
 CTC20T5UR right	 CTC20T5UL left														
Corner Table Privacy Back 	CTC20T5W <ul style="list-style-type: none"> · wood top · diagonal grain · 23" table width · table height is same as arm height · COM based on single fabric · multiple fabrics, see pages CT6-CT8 for yardage requirements · double cut veneer available; specify and add \$191 list 	<table border="1"> <thead> <tr> <th>Dimensions</th> <th>D</th> <th>W</th> <th>H</th> </tr> </thead> <tbody> <tr> <td>Overall</td> <td>32</td> <td>32</td> <td>51 1/2</td> </tr> <tr> <td>Table</td> <td>23</td> <td>23</td> <td>25</td> </tr> </tbody> </table>	Dimensions	D	W	H	Overall	32	32	51 1/2	Table	23	23	25	COM \$3,956 A \$4,110 B \$4,296 COL/C \$4,620 D \$5,037 E \$5,455 F \$6,104 G \$6,797 H \$7,538 I \$8,699 J \$10,090 L1 \$7,864 L2 \$8,838
		Dimensions	D	W	H										
		Overall	32	32	51 1/2										
Table	23	23	25												
<table border="1"> <thead> <tr> <th>Upholstery</th> <th colspan="3">Shipping</th> </tr> </thead> <tbody> <tr> <td>COM Ydg</td> <td>6 1/2</td> <td>Ctn Wt</td> <td>153</td> </tr> <tr> <td>COL Sq Ft</td> <td>150</td> <td>Cu Ft</td> <td>31</td> </tr> </tbody> </table>	Upholstery	Shipping			COM Ydg	6 1/2	Ctn Wt	153	COL Sq Ft	150	Cu Ft	31			
Upholstery	Shipping														
COM Ydg	6 1/2	Ctn Wt	153												
COL Sq Ft	150	Cu Ft	31												

CONNECT

Description	Model	Specifications	List Price Per Grade																																																		
Corner Table Privacy Back with Stand Up Surface  <p>CTC20T6UC center</p>  <p>CTC20T6UR right</p>  <p>CTC20T6UL left</p>	CTC20T6UC CTC20T6UR CTC20T6UL <ul style="list-style-type: none"> · upholstered top · stand up surface corner; specify square (S) no upcharge or rounded (R) add \$93 list · 23" table width · 41 ¾" high stand up surface · table height is same as arm height · COM based on single fabric 	<table border="1"> <thead> <tr> <th>Dimensions</th> <th>D</th> <th>W</th> <th>H</th> </tr> </thead> <tbody> <tr> <td>Overall</td> <td>42</td> <td>42</td> <td>51 ½</td> </tr> <tr> <td>Table</td> <td>23</td> <td>23</td> <td>24 ½</td> </tr> <tr> <th colspan="2">Upholstery</th> <th colspan="2">Shipping</th> </tr> <tr> <td>COM Ydg</td> <td>7 ¼</td> <td>Ctn Wt</td> <td>186</td> </tr> <tr> <td>COL Sq Ft</td> <td>167</td> <td>Cu Ft</td> <td>43</td> </tr> </tbody> </table> <ul style="list-style-type: none"> · multiple fabrics, see pages CT6-CT8 for yardage requirements · double cut veneer available; specify and add \$128 list 	Dimensions	D	W	H	Overall	42	42	51 ½	Table	23	23	24 ½	Upholstery		Shipping		COM Ydg	7 ¼	Ctn Wt	186	COL Sq Ft	167	Cu Ft	43	<table> <tr><td>COM</td><td>\$6,100</td></tr> <tr><td>A</td><td>\$6,298</td></tr> <tr><td>B</td><td>\$6,504</td></tr> <tr><td>COL/C</td><td>\$6,864</td></tr> <tr><td>D</td><td>\$7,330</td></tr> <tr><td>E</td><td>\$7,795</td></tr> <tr><td>F</td><td>\$8,520</td></tr> <tr><td>G</td><td>\$9,296</td></tr> <tr><td>H</td><td>\$10,124</td></tr> <tr><td>I</td><td>\$11,414</td></tr> <tr><td>J</td><td>\$12,967</td></tr> <tr><td>L1</td><td>\$10,484</td></tr> <tr><td>L2</td><td>\$11,569</td></tr> </table>	COM	\$6,100	A	\$6,298	B	\$6,504	COL/C	\$6,864	D	\$7,330	E	\$7,795	F	\$8,520	G	\$9,296	H	\$10,124	I	\$11,414	J	\$12,967	L1	\$10,484	L2	\$11,569
		Dimensions	D	W	H																																																
		Overall	42	42	51 ½																																																
		Table	23	23	24 ½																																																
Upholstery		Shipping																																																			
COM Ydg	7 ¼	Ctn Wt	186																																																		
COL Sq Ft	167	Cu Ft	43																																																		
COM	\$6,100																																																				
A	\$6,298																																																				
B	\$6,504																																																				
COL/C	\$6,864																																																				
D	\$7,330																																																				
E	\$7,795																																																				
F	\$8,520																																																				
G	\$9,296																																																				
H	\$10,124																																																				
I	\$11,414																																																				
J	\$12,967																																																				
L1	\$10,484																																																				
L2	\$11,569																																																				
Corner Table Privacy Back with Stand Up Surface 	CTC20T6W <ul style="list-style-type: none"> · wood top · stand up surface corner; specify square (S) no upcharge or rounded (R) add \$93 list · diagonal grain · 23" table width · 41 ¾" high stand up surface · table height is same as arm height · COM based on single fabric · multiple fabrics, see pages CT6-CT8 for yardage requirements · double cut veneer available; specify and add \$191 list 	<table border="1"> <thead> <tr> <th>Dimensions</th> <th>D</th> <th>W</th> <th>H</th> </tr> </thead> <tbody> <tr> <td>Overall</td> <td>42</td> <td>42</td> <td>51 ½</td> </tr> <tr> <td>Table</td> <td>23</td> <td>23</td> <td>25</td> </tr> <tr> <th colspan="2">Upholstery</th> <th colspan="2">Shipping</th> </tr> <tr> <td>COM Ydg</td> <td>6 ½</td> <td>Ctn Wt</td> <td>191</td> </tr> <tr> <td>COL Sq Ft</td> <td>150</td> <td>Cu Ft</td> <td>43</td> </tr> </tbody> </table>	Dimensions	D	W	H	Overall	42	42	51 ½	Table	23	23	25	Upholstery		Shipping		COM Ydg	6 ½	Ctn Wt	191	COL Sq Ft	150	Cu Ft	43	<table> <tr><td>COM</td><td>\$6,332</td></tr> <tr><td>A</td><td>\$6,516</td></tr> <tr><td>B</td><td>\$6,703</td></tr> <tr><td>COL/C</td><td>\$7,029</td></tr> <tr><td>D</td><td>\$7,443</td></tr> <tr><td>E</td><td>\$7,862</td></tr> <tr><td>F</td><td>\$8,512</td></tr> <tr><td>G</td><td>\$9,209</td></tr> <tr><td>H</td><td>\$9,949</td></tr> <tr><td>I</td><td>\$11,109</td></tr> <tr><td>J</td><td>\$12,496</td></tr> <tr><td>L1</td><td>\$10,273</td></tr> <tr><td>L2</td><td>\$11,245</td></tr> </table>	COM	\$6,332	A	\$6,516	B	\$6,703	COL/C	\$7,029	D	\$7,443	E	\$7,862	F	\$8,512	G	\$9,209	H	\$9,949	I	\$11,109	J	\$12,496	L1	\$10,273	L2	\$11,245
		Dimensions	D	W	H																																																
		Overall	42	42	51 ½																																																
		Table	23	23	25																																																
Upholstery		Shipping																																																			
COM Ydg	6 ½	Ctn Wt	191																																																		
COL Sq Ft	150	Cu Ft	43																																																		
COM	\$6,332																																																				
A	\$6,516																																																				
B	\$6,703																																																				
COL/C	\$7,029																																																				
D	\$7,443																																																				
E	\$7,862																																																				
F	\$8,512																																																				
G	\$9,209																																																				
H	\$9,949																																																				
I	\$11,109																																																				
J	\$12,496																																																				
L1	\$10,273																																																				
L2	\$11,245																																																				
90° Curved Seat Low Back 	CTI32121 <ul style="list-style-type: none"> · 12" inside radius · 44" outside radius · COM based on single fabric · multiple fabrics, see pages CT6-CT8 for yardage requirements · double cut veneer available; specify and add \$128 list 	<table border="1"> <thead> <tr> <th>Dimensions</th> <th>D</th> <th>W</th> <th>H</th> </tr> </thead> <tbody> <tr> <td>Overall</td> <td>32</td> <td></td> <td>30 ½</td> </tr> <tr> <td>Seat</td> <td>20</td> <td></td> <td>18</td> </tr> <tr> <th colspan="2">Upholstery</th> <th colspan="2">Shipping</th> </tr> <tr> <td>COM Ydg</td> <td>5 ½</td> <td>Ctn Wt</td> <td>105</td> </tr> <tr> <td>COL Sq Ft</td> <td>127</td> <td>Cu Ft</td> <td>36</td> </tr> </tbody> </table>	Dimensions	D	W	H	Overall	32		30 ½	Seat	20		18	Upholstery		Shipping		COM Ydg	5 ½	Ctn Wt	105	COL Sq Ft	127	Cu Ft	36	<table> <tr><td>COM</td><td>\$2,974</td></tr> <tr><td>A</td><td>\$3,096</td></tr> <tr><td>B</td><td>\$3,254</td></tr> <tr><td>COL/C</td><td>\$3,530</td></tr> <tr><td>D</td><td>\$3,881</td></tr> <tr><td>E</td><td>\$4,233</td></tr> <tr><td>F</td><td>\$4,784</td></tr> <tr><td>G</td><td>\$5,374</td></tr> <tr><td>H</td><td>\$6,000</td></tr> <tr><td>I</td><td>\$6,980</td></tr> <tr><td>J</td><td>\$8,156</td></tr> <tr><td>L1</td><td>\$6,272</td></tr> <tr><td>L2</td><td>\$7,098</td></tr> </table>	COM	\$2,974	A	\$3,096	B	\$3,254	COL/C	\$3,530	D	\$3,881	E	\$4,233	F	\$4,784	G	\$5,374	H	\$6,000	I	\$6,980	J	\$8,156	L1	\$6,272	L2	\$7,098
		Dimensions	D	W	H																																																
		Overall	32		30 ½																																																
		Seat	20		18																																																
Upholstery		Shipping																																																			
COM Ydg	5 ½	Ctn Wt	105																																																		
COL Sq Ft	127	Cu Ft	36																																																		
COM	\$2,974																																																				
A	\$3,096																																																				
B	\$3,254																																																				
COL/C	\$3,530																																																				
D	\$3,881																																																				
E	\$4,233																																																				
F	\$4,784																																																				
G	\$5,374																																																				
H	\$6,000																																																				
I	\$6,980																																																				
J	\$8,156																																																				
L1	\$6,272																																																				
L2	\$7,098																																																				

To Order, Specify:

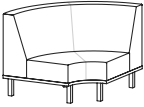
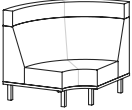
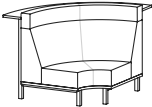
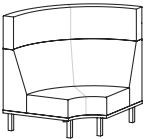
- Model Number
- Wood Species - Cherry (CH1), Maple (MA1), Walnut (WA1) or Double Cut (DC1)
- Wood Finish [See Wood Finish Options](#)
- Laminate Color Selection (Stand Up Surface) [See Laminate Color Selection](#)
- Surface Corners (Stand Up Surface) - Square (S), no upcharge or Rounded (R), add \$93 list
- Fabric Selection - vendor, pattern and color
 - A. Seat
 - B. Back
 - C. Headrest
 Visit www.jsifurniture.com/finishes-and-materials/textiles for our textiles program. See selection of standard and graded in manufacturers and patterns.
- Metal Leg Color - [See Metal Leg Color Options](#)
- Optional Coordinating Wood Grain Laminate Available on Table Tops - no upcharge. Finishes with an asterisk have a coordinating laminate available
- Optional Rubber Cushion Nylon Glides - no upcharge
- Product Options

Specifications

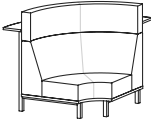

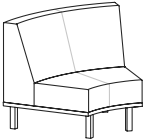
- Wood species - Cherry, Maple, Walnut or Double Cut. Table has ¾" high density polyurethane foam.
- Seat has synthetic sheet webbing with cross strap reinforcement, 4 ½" high density foam.
- Back has high density polyurethane foam.
- Plywood construction with locking tenons, glue and screws.
- Linking bracket included.
- Metal legs are 16 gauge steel tube with metal leveling glides.
- ¾" thick 10" deep laminate stand up surface with coordinating 3mm PVC edge supported by steel columns, 42" surface height.

Connect Modular Lounge



Description	① Model	Specifications	List Price Per Grade												
90° Curved Seat Mid Back 	CTI32122 · 12" inside radius · 44" outside radius · COM based on single fabric · multiple fabrics, see pages CT6-CT8 for yardage requirements · double cut veneer available; specify and add \$128 list	<table border="1"> <thead> <tr> <th>Dimensions</th> <th>D</th> <th>W</th> <th>H</th> </tr> </thead> <tbody> <tr> <td>Overall</td> <td>32</td> <td></td> <td>37 1/2</td> </tr> <tr> <td>Seat</td> <td>20</td> <td></td> <td>18</td> </tr> </tbody> </table>	Dimensions	D	W	H	Overall	32		37 1/2	Seat	20		18	COM \$3,203 A \$3,340 B \$3,519 COL/C \$3,829 D \$4,231 E \$4,635 F \$5,257 G \$5,926 H \$6,640 I \$7,754 J \$9,089 L1 \$6,951 L2 \$7,887
		Dimensions	D	W	H										
Overall	32		37 1/2												
Seat	20		18												
<table border="1"> <thead> <tr> <th>Upholstery</th> <th colspan="3">Shipping</th> </tr> </thead> <tbody> <tr> <td>COM Ydg</td> <td>6 1/4</td> <td>Ctn Wt</td> <td>110</td> </tr> <tr> <td>COL Sq Ft</td> <td>144</td> <td>Cu Ft</td> <td>46</td> </tr> </tbody> </table>	Upholstery	Shipping			COM Ydg	6 1/4	Ctn Wt	110	COL Sq Ft	144	Cu Ft	46			
Upholstery	Shipping														
COM Ydg	6 1/4	Ctn Wt	110												
COL Sq Ft	144	Cu Ft	46												
90° Curved Seat High Back 	CTI32123 · 12" inside radius · 44" outside radius · 7" high headrest · COM based on single fabric · multiple fabrics, see pages CT6-CT8 for yardage requirements · double cut veneer available; specify and add \$128 list	<table border="1"> <thead> <tr> <th>Dimensions</th> <th>D</th> <th>W</th> <th>H</th> </tr> </thead> <tbody> <tr> <td>Overall</td> <td>32</td> <td></td> <td>44 1/2</td> </tr> <tr> <td>Seat</td> <td>20</td> <td></td> <td>18</td> </tr> </tbody> </table>	Dimensions	D	W	H	Overall	32		44 1/2	Seat	20		18	COM \$3,431 A \$3,599 B \$3,827 COL/C \$4,226 D \$4,741 E \$5,254 F \$6,052 G \$6,907 H \$7,823 I \$9,249 J \$10,960 L1 \$8,221 L2 \$9,417
		Dimensions	D	W	H										
Overall	32		44 1/2												
Seat	20		18												
<table border="1"> <thead> <tr> <th>Upholstery</th> <th colspan="3">Shipping</th> </tr> </thead> <tbody> <tr> <td>COM Ydg</td> <td>8</td> <td>Ctn Wt</td> <td>130</td> </tr> <tr> <td>COL Sq Ft</td> <td>184</td> <td>Cu Ft</td> <td>56</td> </tr> </tbody> </table>	Upholstery	Shipping			COM Ydg	8	Ctn Wt	130	COL Sq Ft	184	Cu Ft	56			
Upholstery	Shipping														
COM Ydg	8	Ctn Wt	130												
COL Sq Ft	184	Cu Ft	56												
90° Curved Seat High Back with Stand Up Surface 	CTI32124 · 12" inside radius · stand up surface corner; specify square (S) no upcharge or rounded (R) add \$49 list · 44" outside radius · 7" high headrest · 41 3/4" high stand up surface · COM based on single fabric · multiple fabrics, see pages CT6-CT8 for yardage requirements · power center not available · double cut veneer available; specify and add \$128 list	<table border="1"> <thead> <tr> <th>Dimensions</th> <th>D</th> <th>W</th> <th>H</th> </tr> </thead> <tbody> <tr> <td>Overall</td> <td>42</td> <td></td> <td>44 1/2</td> </tr> <tr> <td>Seat</td> <td>20</td> <td></td> <td>18</td> </tr> </tbody> </table>	Dimensions	D	W	H	Overall	42		44 1/2	Seat	20		18	COM \$4,784 A \$4,973 B \$5,199 COL/C \$5,601 D \$6,113 E \$6,627 F \$7,425 G \$8,278 H \$9,191 I \$10,619 J \$12,330 L1 \$9,592 L2 \$10,788
		Dimensions	D	W	H										
Overall	42		44 1/2												
Seat	20		18												
<table border="1"> <thead> <tr> <th>Upholstery</th> <th colspan="3">Shipping</th> </tr> </thead> <tbody> <tr> <td>COM Ydg</td> <td>8</td> <td>Ctn Wt</td> <td>183</td> </tr> <tr> <td>COL Sq Ft</td> <td>184</td> <td>Cu Ft</td> <td>68</td> </tr> </tbody> </table>	Upholstery	Shipping			COM Ydg	8	Ctn Wt	183	COL Sq Ft	184	Cu Ft	68			
Upholstery	Shipping														
COM Ydg	8	Ctn Wt	183												
COL Sq Ft	184	Cu Ft	68												
90° Curved Seat Privacy Back 	CTI32125 · 12" inside radius · 44" outside radius · 14" high headrest · COM based on single fabric · multiple fabrics, see pages CT6-CT8 for yardage requirements · double cut veneer available; specify and add \$128 list	<table border="1"> <thead> <tr> <th>Dimensions</th> <th>D</th> <th>W</th> <th>H</th> </tr> </thead> <tbody> <tr> <td>Overall</td> <td>32</td> <td></td> <td>51 1/2</td> </tr> <tr> <td>Seat</td> <td>20</td> <td></td> <td>18</td> </tr> </tbody> </table>	Dimensions	D	W	H	Overall	32		51 1/2	Seat	20		18	COM \$3,664 A \$3,846 B \$4,104 COL/C \$4,554 D \$5,132 E \$5,710 F \$6,608 G \$7,569 H \$8,597 I \$10,199 J \$12,127 L1 \$9,044 L2 \$10,391
		Dimensions	D	W	H										
Overall	32		51 1/2												
Seat	20		18												
<table border="1"> <thead> <tr> <th>Upholstery</th> <th colspan="3">Shipping</th> </tr> </thead> <tbody> <tr> <td>COM Ydg</td> <td>9</td> <td>Ctn Wt</td> <td>135</td> </tr> <tr> <td>COL Sq Ft</td> <td>207</td> <td>Cu Ft</td> <td>66</td> </tr> </tbody> </table>	Upholstery	Shipping			COM Ydg	9	Ctn Wt	135	COL Sq Ft	207	Cu Ft	66			
Upholstery	Shipping														
COM Ydg	9	Ctn Wt	135												
COL Sq Ft	207	Cu Ft	66												

CONNECT

Description	Model	Specifications	List Price Per Grade																								
90° Curved Seat Privacy Back with Stand Up Surface 	CTI32126 • 12" inside radius • stand up surface corner; specify square (S) no upcharge or rounded (R) add \$49 list • 44" outside radius • 14" high headrest • 41 3/4" high stand up surface • COM based on single fabric • multiple fabrics, see pages CT6-CT8 for yardage requirements • power center not available • double cut veneer available; specify and add \$128 list	<table border="1"> <thead> <tr> <th>Dimensions</th> <th>D</th> <th>W</th> <th>H</th> </tr> </thead> <tbody> <tr> <td>Overall</td> <td>42</td> <td></td> <td>51 1/2</td> </tr> <tr> <td>Seat</td> <td>20</td> <td></td> <td>18</td> </tr> <tr> <th colspan="2">Upholstery</th> <th colspan="2">Shipping</th> </tr> <tr> <td>COM Ydg</td> <td>9</td> <td>Ctn Wt</td> <td>188</td> </tr> <tr> <td>COL Sq Ft</td> <td>207</td> <td>Cu Ft</td> <td>78</td> </tr> </tbody> </table>	Dimensions	D	W	H	Overall	42		51 1/2	Seat	20		18	Upholstery		Shipping		COM Ydg	9	Ctn Wt	188	COL Sq Ft	207	Cu Ft	78	COM \$5,015 A \$5,219 B \$5,475 COL/C \$5,925 D \$6,502 E \$7,079 F \$7,979 G \$8,941 H \$9,968 I \$11,571 J \$13,498 L1 \$10,418 L2 \$11,765
		Dimensions	D	W	H																						
Overall	42		51 1/2																								
Seat	20		18																								
Upholstery		Shipping																									
COM Ydg	9	Ctn Wt	188																								
COL Sq Ft	207	Cu Ft	78																								
45° Curved Seat Low Back 	CTI32301 • 30" inside radius • 62" outside radius • COM based on single fabric • multiple fabrics, see pages CT6-CT8 for yardage requirements • double cut veneer available; specify and add \$128 list	<table border="1"> <thead> <tr> <th>Dimensions</th> <th>D</th> <th>W</th> <th>H</th> </tr> </thead> <tbody> <tr> <td>Overall</td> <td>32</td> <td></td> <td>30 1/2</td> </tr> <tr> <td>Seat</td> <td>20</td> <td></td> <td>18</td> </tr> <tr> <th colspan="2">Upholstery</th> <th colspan="2">Shipping</th> </tr> <tr> <td>COM Ydg</td> <td>4</td> <td>Ctn Wt</td> <td>95</td> </tr> <tr> <td>COL Sq Ft</td> <td>92</td> <td>Cu Ft</td> <td>27</td> </tr> </tbody> </table>	Dimensions	D	W	H	Overall	32		30 1/2	Seat	20		18	Upholstery		Shipping		COM Ydg	4	Ctn Wt	95	COL Sq Ft	92	Cu Ft	27	COM \$2,886 A \$2,986 B \$3,101 COL/C \$3,301 D \$3,557 E \$3,816 F \$4,215 G \$4,643 H \$5,098 I \$5,811 J \$6,665 L1 \$5,298 L2 \$5,897
		Dimensions	D	W	H																						
Overall	32		30 1/2																								
Seat	20		18																								
Upholstery		Shipping																									
COM Ydg	4	Ctn Wt	95																								
COL Sq Ft	92	Cu Ft	27																								
45° Curved Seat Mid Back 	CTI32302 • 30" inside radius • 62" outside radius • COM based on single fabric • multiple fabrics, see pages CT6-CT8 for yardage requirements • double cut veneer available; specify and add \$128 list	<table border="1"> <thead> <tr> <th>Dimensions</th> <th>D</th> <th>W</th> <th>H</th> </tr> </thead> <tbody> <tr> <td>Overall</td> <td>32</td> <td></td> <td>37 1/2</td> </tr> <tr> <td>Seat</td> <td>20</td> <td></td> <td>18</td> </tr> <tr> <th colspan="2">Upholstery</th> <th colspan="2">Shipping</th> </tr> <tr> <td>COM Ydg</td> <td>4 1/4</td> <td>Ctn Wt</td> <td>100</td> </tr> <tr> <td>COL Sq Ft</td> <td>98</td> <td>Cu Ft</td> <td>35</td> </tr> </tbody> </table>	Dimensions	D	W	H	Overall	32		37 1/2	Seat	20		18	Upholstery		Shipping		COM Ydg	4 1/4	Ctn Wt	100	COL Sq Ft	98	Cu Ft	35	COM \$3,115 A \$3,225 B \$3,345 COL/C \$3,557 D \$3,828 E \$4,103 F \$4,525 G \$4,982 H \$5,466 I \$6,224 J \$7,133 L1 \$5,680 L2 \$6,313
		Dimensions	D	W	H																						
Overall	32		37 1/2																								
Seat	20		18																								
Upholstery		Shipping																									
COM Ydg	4 1/4	Ctn Wt	100																								
COL Sq Ft	98	Cu Ft	35																								

To Order, Specify:

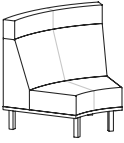
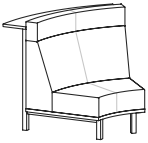
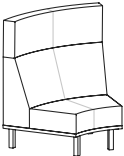
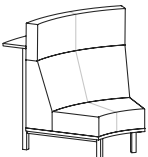
- 1 Model Number
- 2 Wood Species - Cherry (CH1), Maple (MA1), Walnut (WA1) or Double Cut (DC1)
- 3 Wood Finish [See Wood Finish Options](#)
- 4 Laminate Color Selection (Stand Up Surface) [See Laminate Color Selection](#)
- 5 Surface Corners (Stand Up Surface) - Square (S), no upcharge or Rounded (R), add \$93 list
- 6 Fabric Selection - vendor, pattern and color
 - A. Seat
 - B. Back
 - C. Headrest
 Visit www.jsifurniture.com/finishes-and-materials/textiles for our textiles program.
 See selection of standard and graded in manufacturers and patterns.
- 7 Metal Leg Color - [See Metal Leg Color Options](#)
- 8 Optional Coordinating Wood Grain Laminate Available on Table Tops - no upcharge.
 Finishes with an asterisk have a coordinating laminate available
- 9 Optional Rubber Cushion Nylon Glides - no upcharge
- 10 Product Options

Specifications

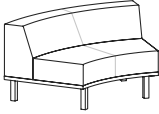
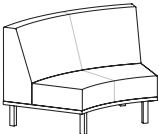
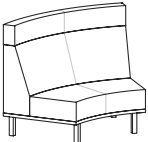
- Wood species - Cherry, Maple, Walnut or Double Cut. Table has 3/4" high density polyurethane foam.
- Seat has synthetic sheet webbing with cross strap reinforcement, 4 1/2" high density foam.
- Back has high density polyurethane foam.
- Plywood construction with locking tenons, glue and screws.
- Linking bracket included.
- Metal legs are 16 gauge steel tube with metal leveling glides.
- 3/4" thick 10" deep laminate stand up surface with coordinating 3mm PVC edge supported by steel columns, 42" surface height.

Connect Modular Lounge



Description	① Model	Specifications	List Price Per Grade												
45° Curved Seat High Back 	CTI32303 · 30" inside radius · 62" outside radius · 7" high headrest · COM based on single fabric · multiple fabrics, see pages CT6-CT8 for yardage requirements · double cut veneer available; specify and add \$128 list	<table border="1"> <thead> <tr> <th>Dimensions</th> <th>D</th> <th>W</th> <th>H</th> </tr> </thead> <tbody> <tr> <td>Overall</td> <td>32</td> <td></td> <td>44 ½</td> </tr> <tr> <td>Seat</td> <td>20</td> <td></td> <td>18</td> </tr> </tbody> </table>	Dimensions	D	W	H	Overall	32		44 ½	Seat	20		18	COM \$3,345 A \$3,478 B \$3,640 COL/C \$3,929 D \$4,299 E \$4,668 F \$5,241 G \$5,856 H \$6,511 I \$7,537 J \$8,767 L1 \$6,798 L2 \$7,660
		Dimensions	D	W	H										
Overall	32		44 ½												
Seat	20		18												
<table border="1"> <thead> <tr> <th>Upholstery</th> <th colspan="3">Shipping</th> </tr> </thead> <tbody> <tr> <td>COM Ydg</td> <td>5 ¾</td> <td>Ctn Wt</td> <td>112</td> </tr> <tr> <td>COL Sq Ft</td> <td>133</td> <td>Cu Ft</td> <td>42</td> </tr> </tbody> </table>	Upholstery	Shipping			COM Ydg	5 ¾	Ctn Wt	112	COL Sq Ft	133	Cu Ft	42			
Upholstery	Shipping														
COM Ydg	5 ¾	Ctn Wt	112												
COL Sq Ft	133	Cu Ft	42												
45° Curved Seat High Back with Stand Up Surface 	CTI32304 · 30" inside radius · stand up surface corner; specify square (S) no upcharge or rounded (R) add \$49 list · 62" outside radius · 7" high headrest · 41 ¾" high stand up surface · COM based on single fabric · multiple fabrics, see pages CT6-CT8 for yardage requirements · double cut veneer available; specify and add \$128 list	<table border="1"> <thead> <tr> <th>Dimensions</th> <th>D</th> <th>W</th> <th>H</th> </tr> </thead> <tbody> <tr> <td>Overall</td> <td>42</td> <td></td> <td>44 ½</td> </tr> <tr> <td>Seat</td> <td>20</td> <td></td> <td>18</td> </tr> </tbody> </table>	Dimensions	D	W	H	Overall	42		44 ½	Seat	20		18	COM \$4,739 A \$4,892 B \$5,056 COL/C \$5,344 D \$5,715 E \$6,083 F \$6,655 G \$7,273 H \$7,927 I \$8,951 J \$10,183 L1 \$8,211 L2 \$9,075
		Dimensions	D	W	H										
Overall	42		44 ½												
Seat	20		18												
<table border="1"> <thead> <tr> <th>Upholstery</th> <th colspan="3">Shipping</th> </tr> </thead> <tbody> <tr> <td>COM Ydg</td> <td>5 ¾</td> <td>Ctn Wt</td> <td>150</td> </tr> <tr> <td>COL Sq Ft</td> <td>133</td> <td>Cu Ft</td> <td>54</td> </tr> </tbody> </table>	Upholstery	Shipping			COM Ydg	5 ¾	Ctn Wt	150	COL Sq Ft	133	Cu Ft	54			
Upholstery	Shipping														
COM Ydg	5 ¾	Ctn Wt	150												
COL Sq Ft	133	Cu Ft	54												
45° Curved Seat Privacy Back 	CTI32305 · 30" inside radius · 62" outside radius · 14" high headrest · COM based on single fabric · multiple fabrics, see pages CT6-CT8 for yardage requirements · double cut veneer available; specify and add \$128 list	<table border="1"> <thead> <tr> <th>Dimensions</th> <th>D</th> <th>W</th> <th>H</th> </tr> </thead> <tbody> <tr> <td>Overall</td> <td>32</td> <td></td> <td>51 ½</td> </tr> <tr> <td>Seat</td> <td>20</td> <td></td> <td>18</td> </tr> </tbody> </table>	Dimensions	D	W	H	Overall	32		51 ½	Seat	20		18	COM \$3,577 A \$3,719 B \$3,897 COL/C \$4,210 D \$4,610 E \$5,011 F \$5,636 G \$6,303 H \$7,018 I \$8,131 J \$9,466 L1 \$7,327 L2 \$8,264
		Dimensions	D	W	H										
Overall	32		51 ½												
Seat	20		18												
<table border="1"> <thead> <tr> <th>Upholstery</th> <th colspan="3">Shipping</th> </tr> </thead> <tbody> <tr> <td>COM Ydg</td> <td>6 ¼</td> <td>Ctn Wt</td> <td>117</td> </tr> <tr> <td>COL Sq Ft</td> <td>144</td> <td>Cu Ft</td> <td>50</td> </tr> </tbody> </table>	Upholstery	Shipping			COM Ydg	6 ¼	Ctn Wt	117	COL Sq Ft	144	Cu Ft	50			
Upholstery	Shipping														
COM Ydg	6 ¼	Ctn Wt	117												
COL Sq Ft	144	Cu Ft	50												
45° Curved Seat Privacy Back with Stand Up Surface 	CTI32306 · 30" inside radius · stand up surface corner; specify square (S) no upcharge or rounded (R) add \$49 list · 62" outside radius · 14" high headrest · 41 ¾" high stand up surface · COM based on single fabric · multiple fabrics, see pages CT6-CT8 for yardage requirements · double cut veneer available; specify and add \$128 list	<table border="1"> <thead> <tr> <th>Dimensions</th> <th>D</th> <th>W</th> <th>H</th> </tr> </thead> <tbody> <tr> <td>Overall</td> <td>42</td> <td></td> <td>51 ½</td> </tr> <tr> <td>Seat</td> <td>20</td> <td></td> <td>18</td> </tr> </tbody> </table>	Dimensions	D	W	H	Overall	42		51 ½	Seat	20		18	COM \$4,969 A \$5,134 B \$5,312 COL/C \$5,622 D \$6,023 E \$6,423 F \$7,048 G \$7,718 H \$8,431 I \$9,545 J \$10,882 L1 \$8,744 L2 \$9,679
		Dimensions	D	W	H										
Overall	42		51 ½												
Seat	20		18												
<table border="1"> <thead> <tr> <th>Upholstery</th> <th colspan="3">Shipping</th> </tr> </thead> <tbody> <tr> <td>COM Ydg</td> <td>6 ¼</td> <td>Ctn Wt</td> <td>155</td> </tr> <tr> <td>COL Sq Ft</td> <td>144</td> <td>Cu Ft</td> <td>62</td> </tr> </tbody> </table>	Upholstery	Shipping			COM Ydg	6 ¼	Ctn Wt	155	COL Sq Ft	144	Cu Ft	62			
Upholstery	Shipping														
COM Ydg	6 ¼	Ctn Wt	155												
COL Sq Ft	144	Cu Ft	62												

CONNECT

Description	Model	Specifications				List Price Per Grade	
45° Curved Seat Low Back 	CTI32451 • 45" inside radius • 77" outside radius • COM based on single fabric • multiple fabrics, see pages CT6-CT8 for yardage requirements • double cut veneer available; specify and add \$128 list	Dimensions	D	W	H	COM	\$2,942
		Overall	32		30 ½	A	\$3,059
		Seat	20		18	B	\$3,203
		Upholstery	Shipping			COL/C	\$3,452
		COM Ydg	5	Ctn Wt	110	D	\$3,774
		COL Sq Ft	115	Cu Ft	34	E	\$4,096
						F	\$4,594
						G	\$5,131
						H	\$5,698
						I	\$6,589
						J	\$7,660
						L1	\$5,949
						L2	\$6,697
45° Curved Seat Mid Back 	CTI32452 • 45" inside radius • 77" outside radius • COM based on single fabric • multiple fabrics, see pages CT6-CT8 for yardage requirements • double cut veneer available; specify and add \$128 list	Dimensions	D	W	H	COM	\$3,174
		Overall	32		37 ½	A	\$3,301
		Seat	20		18	B	\$3,457
		Upholstery	Shipping			COL/C	\$3,733
		COM Ydg	5 ½	Ctn Wt	120	D	\$4,084
		COL Sq Ft	127	Cu Ft	44	E	\$4,439
						F	\$4,988
						G	\$5,575
						H	\$6,204
						I	\$7,185
						J	\$8,359
						L1	\$6,477
						L2	\$7,303
45° Curved Seat High Back 	CTI32453 • 45" inside radius • 77" outside radius • 7" high headrest • COM based on single fabric • multiple fabrics, see pages CT6-CT8 for yardage requirements • double cut veneer available; specify and add \$128 list	Dimensions	D	W	H	COM	\$3,402
		Overall	32		44 ½	A	\$3,559
		Seat	20		18	B	\$3,767
		Upholstery	Shipping			COL/C	\$4,126
		COM Ydg	7 ¼	Ctn Wt	135	D	\$4,592
		COL Sq Ft	167	Cu Ft	54	E	\$5,057
						F	\$5,781
						G	\$6,556
						H	\$7,385
						I	\$8,677
						J	\$10,229
						L1	\$7,747
						L2	\$8,833

To Order, Specify:

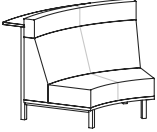

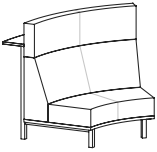

- 1 Model Number
- 2 Wood Species - Cherry (CH1), Maple (MA1), Walnut (WA1) or Double Cut (DC1)
- 3 Wood Finish [See Wood Finish Options](#)
- 4 Laminate Color Selection (Stand Up Surface) [See Laminate Color Selection](#)
- 5 Surface Corners (Stand Up Surface) - Square (S), no upcharge or Rounded (R), add \$49 list
- 6 Fabric Selection - vendor, pattern and color
 - A. Seat
 - B. Back
 - C. Headrest
 Visit www.jsifurniture.com/finishes-and-materials/textiles for our textiles program. See selection of standard and graded in manufacturers and patterns.
- 7 Metal Leg Color - [See Metal Leg Color Options](#)
- 8 Optional Power Center - Flush Mount (EC22) - Black (B) or White (W); \$583 list each, see page CT3 for location availability
- 9 Optional Rubber Cushion Nylon Glides - no upcharge
- 10 Product Options

Specifications




- Wood species - Cherry, Maple, Walnut or Double Cut. Seat has synthetic sheet webbing with cross strap reinforcement, 4 ¼" high density polyurethane foam.
- Back has high density polyurethane foam.
- Plywood construction with locking tenons, glue and screws.
- Linking bracket included.
- Metal legs are 16 gauge steel tube with metal leveling glides.
- ¾" thick 10" deep laminate stand up surface with coordinating 3mm PVC edge supported by steel columns, 42" surface height.

Connect Modular Lounge



Description	Model	Specifications	List Price Per Grade																																								
45° Curved Seat High Back with Stand Up Surface 	CTI32454 · stand up surface corner; specify square (S) no upcharge or rounded (R) add \$49 list · 77" outside radius · 7" high headrest · 41 3/4" high stand up surface · COM based on single fabric · multiple fabrics, see pages CT6-CT8 for yardage requirements · double cut veneer available; specify and add \$128 list	<table border="1"> <thead> <tr> <th>Dimensions</th> <th>D</th> <th>W</th> <th>H</th> </tr> </thead> <tbody> <tr> <td>Overall</td> <td>42</td> <td></td> <td>44 1/2</td> </tr> <tr> <td>Seat</td> <td>20</td> <td></td> <td>18</td> </tr> </tbody> </table>	Dimensions	D	W	H	Overall	42		44 1/2	Seat	20		18	<table border="1"> <thead> <tr> <th colspan="2">List Price Per Grade</th> </tr> </thead> <tbody> <tr> <td>COM</td> <td>\$5,475</td> </tr> <tr> <td>A</td> <td>\$5,662</td> </tr> <tr> <td>B</td> <td>\$5,869</td> </tr> <tr> <td>COL/C</td> <td>\$6,231</td> </tr> <tr> <td>D</td> <td>\$6,697</td> </tr> <tr> <td>E</td> <td>\$7,161</td> </tr> <tr> <td>F</td> <td>\$7,886</td> </tr> <tr> <td>G</td> <td>\$8,661</td> </tr> <tr> <td>H</td> <td>\$9,487</td> </tr> <tr> <td>I</td> <td>\$10,780</td> </tr> <tr> <td>J</td> <td>\$12,330</td> </tr> <tr> <td>L1</td> <td>\$9,850</td> </tr> <tr> <td>L2</td> <td>\$10,935</td> </tr> </tbody> </table>	List Price Per Grade		COM	\$5,475	A	\$5,662	B	\$5,869	COL/C	\$6,231	D	\$6,697	E	\$7,161	F	\$7,886	G	\$8,661	H	\$9,487	I	\$10,780	J	\$12,330	L1	\$9,850	L2	\$10,935
		Dimensions	D	W	H																																						
Overall	42		44 1/2																																								
Seat	20		18																																								
List Price Per Grade																																											
COM	\$5,475																																										
A	\$5,662																																										
B	\$5,869																																										
COL/C	\$6,231																																										
D	\$6,697																																										
E	\$7,161																																										
F	\$7,886																																										
G	\$8,661																																										
H	\$9,487																																										
I	\$10,780																																										
J	\$12,330																																										
L1	\$9,850																																										
L2	\$10,935																																										
<table border="1"> <thead> <tr> <th>Upholstery</th> <th colspan="3">Shipping</th> </tr> </thead> <tbody> <tr> <td>COM Ydg</td> <td>7 1/4</td> <td>Ctn Wt</td> <td>173</td> </tr> <tr> <td>COL Sq Ft</td> <td>167</td> <td>Cu Ft</td> <td>66</td> </tr> </tbody> </table>		Upholstery	Shipping			COM Ydg	7 1/4	Ctn Wt	173	COL Sq Ft	167	Cu Ft	66																														
Upholstery	Shipping																																										
COM Ydg	7 1/4	Ctn Wt	173																																								
COL Sq Ft	167	Cu Ft	66																																								
45° Curved Seat Privacy Back 	CTI32455 · 45" inside radius · 77" outside radius · 14" high headrest · COM based on single fabric · multiple fabrics, see pages CT6-CT8 for yardage requirements · double cut veneer available; specify and add \$128 list	<table border="1"> <thead> <tr> <th>Dimensions</th> <th>D</th> <th>W</th> <th>H</th> </tr> </thead> <tbody> <tr> <td>Overall</td> <td>32</td> <td></td> <td>51 1/2</td> </tr> <tr> <td>Seat</td> <td>20</td> <td></td> <td>18</td> </tr> </tbody> </table>	Dimensions	D	W	H	Overall	32		51 1/2	Seat	20		18	<table border="1"> <thead> <tr> <th colspan="2">List Price Per Grade</th> </tr> </thead> <tbody> <tr> <td>COM</td> <td>\$3,633</td> </tr> <tr> <td>A</td> <td>\$3,808</td> </tr> <tr> <td>B</td> <td>\$4,043</td> </tr> <tr> <td>COL/C</td> <td>\$4,452</td> </tr> <tr> <td>D</td> <td>\$4,984</td> </tr> <tr> <td>E</td> <td>\$5,514</td> </tr> <tr> <td>F</td> <td>\$6,338</td> </tr> <tr> <td>G</td> <td>\$7,220</td> </tr> <tr> <td>H</td> <td>\$8,161</td> </tr> <tr> <td>I</td> <td>\$9,631</td> </tr> <tr> <td>J</td> <td>\$11,396</td> </tr> <tr> <td>L1</td> <td>\$8,572</td> </tr> <tr> <td>L2</td> <td>\$9,807</td> </tr> </tbody> </table>	List Price Per Grade		COM	\$3,633	A	\$3,808	B	\$4,043	COL/C	\$4,452	D	\$4,984	E	\$5,514	F	\$6,338	G	\$7,220	H	\$8,161	I	\$9,631	J	\$11,396	L1	\$8,572	L2	\$9,807
		Dimensions	D	W	H																																						
Overall	32		51 1/2																																								
Seat	20		18																																								
List Price Per Grade																																											
COM	\$3,633																																										
A	\$3,808																																										
B	\$4,043																																										
COL/C	\$4,452																																										
D	\$4,984																																										
E	\$5,514																																										
F	\$6,338																																										
G	\$7,220																																										
H	\$8,161																																										
I	\$9,631																																										
J	\$11,396																																										
L1	\$8,572																																										
L2	\$9,807																																										
<table border="1"> <thead> <tr> <th>Upholstery</th> <th colspan="3">Shipping</th> </tr> </thead> <tbody> <tr> <td>COM Ydg</td> <td>8 1/4</td> <td>Ctn Wt</td> <td>140</td> </tr> <tr> <td>COL Sq Ft</td> <td>190</td> <td>Cu Ft</td> <td>63</td> </tr> </tbody> </table>		Upholstery	Shipping			COM Ydg	8 1/4	Ctn Wt	140	COL Sq Ft	190	Cu Ft	63																														
Upholstery	Shipping																																										
COM Ydg	8 1/4	Ctn Wt	140																																								
COL Sq Ft	190	Cu Ft	63																																								
45° Curved Seat Privacy Back with Stand Up Surface 	CTI32456 · 45" inside radius · stand up surface corner; specify square (S) no upcharge or rounded (R) add \$49 list · 77" outside radius · 14" high headrest · 41 3/4" high stand up surface · COM based on single fabric · multiple fabrics, see pages CT6-CT8 for yardage requirements · double cut veneer available; specify and add \$128 list	<table border="1"> <thead> <tr> <th>Dimensions</th> <th>D</th> <th>W</th> <th>H</th> </tr> </thead> <tbody> <tr> <td>Overall</td> <td>42</td> <td></td> <td>51 1/2</td> </tr> <tr> <td>Seat</td> <td>20</td> <td></td> <td>18</td> </tr> </tbody> </table>	Dimensions	D	W	H	Overall	42		51 1/2	Seat	20		18	<table border="1"> <thead> <tr> <th colspan="2">List Price Per Grade</th> </tr> </thead> <tbody> <tr> <td>COM</td> <td>\$5,704</td> </tr> <tr> <td>A</td> <td>\$5,909</td> </tr> <tr> <td>B</td> <td>\$6,145</td> </tr> <tr> <td>COL/C</td> <td>\$6,555</td> </tr> <tr> <td>D</td> <td>\$7,086</td> </tr> <tr> <td>E</td> <td>\$7,617</td> </tr> <tr> <td>F</td> <td>\$8,439</td> </tr> <tr> <td>G</td> <td>\$9,322</td> </tr> <tr> <td>H</td> <td>\$10,264</td> </tr> <tr> <td>I</td> <td>\$11,735</td> </tr> <tr> <td>J</td> <td>\$13,498</td> </tr> <tr> <td>L1</td> <td>\$10,676</td> </tr> <tr> <td>L2</td> <td>\$11,910</td> </tr> </tbody> </table>	List Price Per Grade		COM	\$5,704	A	\$5,909	B	\$6,145	COL/C	\$6,555	D	\$7,086	E	\$7,617	F	\$8,439	G	\$9,322	H	\$10,264	I	\$11,735	J	\$13,498	L1	\$10,676	L2	\$11,910
		Dimensions	D	W	H																																						
Overall	42		51 1/2																																								
Seat	20		18																																								
List Price Per Grade																																											
COM	\$5,704																																										
A	\$5,909																																										
B	\$6,145																																										
COL/C	\$6,555																																										
D	\$7,086																																										
E	\$7,617																																										
F	\$8,439																																										
G	\$9,322																																										
H	\$10,264																																										
I	\$11,735																																										
J	\$13,498																																										
L1	\$10,676																																										
L2	\$11,910																																										
<table border="1"> <thead> <tr> <th>Upholstery</th> <th colspan="3">Shipping</th> </tr> </thead> <tbody> <tr> <td>COM Ydg</td> <td>8 1/4</td> <td>Ctn Wt</td> <td>178</td> </tr> <tr> <td>COL Sq Ft</td> <td>190</td> <td>Cu Ft</td> <td>75</td> </tr> </tbody> </table>		Upholstery	Shipping			COM Ydg	8 1/4	Ctn Wt	178	COL Sq Ft	190	Cu Ft	75																														
Upholstery	Shipping																																										
COM Ydg	8 1/4	Ctn Wt	178																																								
COL Sq Ft	190	Cu Ft	75																																								
90° Curved Seat Low Back 	CT032121 · 12" outside radius · 44" inside radius · COM based on single fabric · multiple fabrics, see pages CT6-CT8 for yardage requirements · double cut veneer available; specify and add \$128 list	<table border="1"> <thead> <tr> <th>Dimensions</th> <th>D</th> <th>W</th> <th>H</th> </tr> </thead> <tbody> <tr> <td>Overall</td> <td>32</td> <td></td> <td>30 1/2</td> </tr> <tr> <td>Seat</td> <td>20</td> <td></td> <td>18</td> </tr> </tbody> </table>	Dimensions	D	W	H	Overall	32		30 1/2	Seat	20		18	<table border="1"> <thead> <tr> <th colspan="2">List Price Per Grade</th> </tr> </thead> <tbody> <tr> <td>COM</td> <td>\$2,858</td> </tr> <tr> <td>A</td> <td>\$2,954</td> </tr> <tr> <td>B</td> <td>\$3,059</td> </tr> <tr> <td>COL/C</td> <td>\$3,246</td> </tr> <tr> <td>D</td> <td>\$3,488</td> </tr> <tr> <td>E</td> <td>\$3,731</td> </tr> <tr> <td>F</td> <td>\$4,104</td> </tr> <tr> <td>G</td> <td>\$4,506</td> </tr> <tr> <td>H</td> <td>\$4,934</td> </tr> <tr> <td>I</td> <td>\$5,602</td> </tr> <tr> <td>J</td> <td>\$6,403</td> </tr> <tr> <td>L1</td> <td>\$5,119</td> </tr> <tr> <td>L2</td> <td>\$5,681</td> </tr> </tbody> </table>	List Price Per Grade		COM	\$2,858	A	\$2,954	B	\$3,059	COL/C	\$3,246	D	\$3,488	E	\$3,731	F	\$4,104	G	\$4,506	H	\$4,934	I	\$5,602	J	\$6,403	L1	\$5,119	L2	\$5,681
		Dimensions	D	W	H																																						
Overall	32		30 1/2																																								
Seat	20		18																																								
List Price Per Grade																																											
COM	\$2,858																																										
A	\$2,954																																										
B	\$3,059																																										
COL/C	\$3,246																																										
D	\$3,488																																										
E	\$3,731																																										
F	\$4,104																																										
G	\$4,506																																										
H	\$4,934																																										
I	\$5,602																																										
J	\$6,403																																										
L1	\$5,119																																										
L2	\$5,681																																										
<table border="1"> <thead> <tr> <th>Upholstery</th> <th colspan="3">Shipping</th> </tr> </thead> <tbody> <tr> <td>COM Ydg</td> <td>3 3/4</td> <td>Ctn Wt</td> <td>98</td> </tr> <tr> <td>COL Sq Ft</td> <td>87</td> <td>Cu Ft</td> <td>36</td> </tr> </tbody> </table>		Upholstery	Shipping			COM Ydg	3 3/4	Ctn Wt	98	COL Sq Ft	87	Cu Ft	36																														
Upholstery	Shipping																																										
COM Ydg	3 3/4	Ctn Wt	98																																								
COL Sq Ft	87	Cu Ft	36																																								

CONNECT

Description	Model	Specifications				List Price Per Grade	
90° Curved Seat Mid Back 	CT032122 • 12" outside radius • 44" inside radius • COM based on single fabric • multiple fabrics, see pages CT6-CT8 for yardage requirements • double cut veneer available; specify and add \$128 list	Dimensions	D	W	H	COM	\$3,087
		Overall	32		37½	A	\$3,194
		Seat	20		18	B	\$3,314
		Upholstery	Shipping			COL/C	\$3,526
		COM Ydg	4¼	Ctn Wt	103	D	\$3,800
		COL Sq Ft	98	Cu Ft	46	E	\$4,072
						F	\$4,498
						G	\$4,952
						H	\$5,438
						I	\$6,194
						J	\$7,103
						L1	\$5,649
						L2	\$6,286
90° Curved Seat High Back 	CT032123 • 12" outside radius • 44" inside radius • 7" high headrest • COM based on single fabric • multiple fabrics, see pages CT6-CT8 for yardage requirements • double cut veneer available; specify and add \$128 list	Dimensions	D	W	H	COM	\$3,316
		Overall	32		44½	A	\$3,439
		Seat	20		18	B	\$3,582
		Upholstery	Shipping			COL/C	\$3,829
		COM Ydg	5	Ctn Wt	110	D	\$4,151
		COL Sq Ft	115	Cu Ft	56	E	\$4,472
						F	\$4,973
						G	\$5,506
						H	\$6,078
						I	\$6,968
						J	\$8,040
						L1	\$6,326
						L2	\$7,074
90° Curved Seat Privacy Back 	CT032125 • 12" outside radius • 44" inside radius • 14" high headrest • COM based on single fabric • multiple fabrics, see pages CT6-CT8 for yardage requirements • double cut veneer available; specify and add \$128 list	Dimensions	D	W	H	COM	\$3,546
		Overall	32		51½	A	\$3,674
		Seat	20		18	B	\$3,824
		Upholstery	Shipping			COL/C	\$4,087
		COM Ydg	5¼	Ctn Wt	115	D	\$4,424
		COL Sq Ft	121	Cu Ft	66	E	\$4,762
						F	\$5,285
						G	\$5,846
						H	\$6,447
						I	\$7,383
						J	\$8,504
						L1	\$6,705
						L2	\$7,494

To Order, Specify:

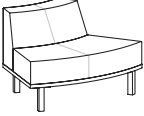



- 1 Model Number
- 2 Wood Species - Cherry (CH1), Maple (MA1), Walnut (WA1) or Double Cut (DC1)
- 3 Wood Finish *See Wood Finish Options*
- 4 Laminate Color Selection (Stand Up Surface) *See Laminate Color Selection*
- 5 Surface Corners (Stand Up Surface) - Square (S), no upcharge or Rounded (R), add \$49 list
- 6 Fabric Selection - vendor, pattern and color
 - A. Seat
 - B. Back
 - C. Headrest
 Visit www.jsifurniture.com/finishes-and-materials/textiles for our textiles program.
 See selection of standard and graded in manufacturers and patterns.
- 7 Metal Leg Color - *See Metal Leg Color Options*
- 8 Optional Power Center - Flush Mount (EC22) - Black (B) or White (W); \$583 list each, see page CT3 for location availability
- 9 Optional Rubber Cushion Nylon Glides - no upcharge
- 10 Product Options


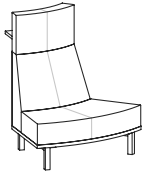

Specifications

- Wood species - Cherry, Maple, Walnut or Double Cut. Seat has synthetic sheet webbing with cross strap reinforcement, 4¼" high density polyurethane foam.
- Back has high density polyurethane foam.
- Plywood construction with locking tenons, glue and screws.
- Linking bracket included.
- Metal legs are 16 gauge steel tube with metal leveling glides.
- ¾" thick 10" deep laminate stand up surface with coordinating 3mm PVC edge supported by steel columns, 42" surface height.

Connect Modular Lounge



Description	① Model	Specifications	List Price Per Grade																										
45° Curved Seat Low Back 	CT032301 · 30" outside radius · 62" inside radius · COM based on single fabric · multiple fabrics, see pages CT6-CT8 for yardage requirements · double cut veneer available; specify and add \$128 list	<table border="1"> <thead> <tr> <th>Dimensions</th> <th>D</th> <th>W</th> <th>H</th> </tr> </thead> <tbody> <tr> <td>Overall</td> <td>32</td> <td></td> <td>30½</td> </tr> <tr> <td>Seat</td> <td>20</td> <td></td> <td>18</td> </tr> </tbody> </table>	Dimensions	D	W	H	Overall	32		30½	Seat	20		18	<table border="1"> <thead> <tr> <th colspan="2">Upholstery</th> <th colspan="2">Shipping</th> </tr> </thead> <tbody> <tr> <td>COM Ydg</td> <td>3</td> <td>Ctn Wt</td> <td>90</td> </tr> <tr> <td>COL Sq Ft</td> <td>69</td> <td>Cu Ft</td> <td>27</td> </tr> </tbody> </table>	Upholstery		Shipping		COM Ydg	3	Ctn Wt	90	COL Sq Ft	69	Cu Ft	27		
		Dimensions	D	W	H																								
Overall	32		30½																										
Seat	20		18																										
Upholstery		Shipping																											
COM Ydg	3	Ctn Wt	90																										
COL Sq Ft	69	Cu Ft	27																										
			<table border="1"> <tbody> <tr><td>COM</td><td>\$2,827</td></tr> <tr><td>A</td><td>\$2,911</td></tr> <tr><td>B</td><td>\$3,000</td></tr> <tr><td>COL/C</td><td>\$3,149</td></tr> <tr><td>D</td><td>\$3,340</td></tr> <tr><td>E</td><td>\$3,535</td></tr> <tr><td>F</td><td>\$3,833</td></tr> <tr><td>G</td><td>\$4,153</td></tr> <tr><td>H</td><td>\$4,495</td></tr> <tr><td>I</td><td>\$5,030</td></tr> <tr><td>J</td><td>\$5,674</td></tr> <tr><td>L1</td><td>\$4,647</td></tr> <tr><td>L2</td><td>\$5,096</td></tr> </tbody> </table>	COM	\$2,827	A	\$2,911	B	\$3,000	COL/C	\$3,149	D	\$3,340	E	\$3,535	F	\$3,833	G	\$4,153	H	\$4,495	I	\$5,030	J	\$5,674	L1	\$4,647	L2	\$5,096
COM	\$2,827																												
A	\$2,911																												
B	\$3,000																												
COL/C	\$3,149																												
D	\$3,340																												
E	\$3,535																												
F	\$3,833																												
G	\$4,153																												
H	\$4,495																												
I	\$5,030																												
J	\$5,674																												
L1	\$4,647																												
L2	\$5,096																												
45° Curved Seat Mid Back 	CT032302 · 30" outside radius · 62" inside radius · COM based on single fabric · multiple fabrics, see pages CT6-CT8 for yardage requirements · double cut veneer available; specify and add \$128 list	<table border="1"> <thead> <tr> <th>Dimensions</th> <th>D</th> <th>W</th> <th>H</th> </tr> </thead> <tbody> <tr> <td>Overall</td> <td>32</td> <td></td> <td>37½</td> </tr> <tr> <td>Seat</td> <td>20</td> <td></td> <td>18</td> </tr> </tbody> </table>	Dimensions	D	W	H	Overall	32		37½	Seat	20		18	<table border="1"> <thead> <tr> <th colspan="2">Upholstery</th> <th colspan="2">Shipping</th> </tr> </thead> <tbody> <tr> <td>COM Ydg</td> <td>3¼</td> <td>Ctn Wt</td> <td>95</td> </tr> <tr> <td>COL Sq Ft</td> <td>75</td> <td>Cu Ft</td> <td>35</td> </tr> </tbody> </table>	Upholstery		Shipping		COM Ydg	3¼	Ctn Wt	95	COL Sq Ft	75	Cu Ft	35		
		Dimensions	D	W	H																								
Overall	32		37½																										
Seat	20		18																										
Upholstery		Shipping																											
COM Ydg	3¼	Ctn Wt	95																										
COL Sq Ft	75	Cu Ft	35																										
			<table border="1"> <tbody> <tr><td>COM</td><td>\$3,056</td></tr> <tr><td>A</td><td>\$3,150</td></tr> <tr><td>B</td><td>\$3,243</td></tr> <tr><td>COL/C</td><td>\$3,403</td></tr> <tr><td>D</td><td>\$3,614</td></tr> <tr><td>E</td><td>\$3,822</td></tr> <tr><td>F</td><td>\$4,148</td></tr> <tr><td>G</td><td>\$4,494</td></tr> <tr><td>H</td><td>\$4,865</td></tr> <tr><td>I</td><td>\$5,445</td></tr> <tr><td>J</td><td>\$6,141</td></tr> <tr><td>L1</td><td>\$5,028</td></tr> <tr><td>L2</td><td>\$5,514</td></tr> </tbody> </table>	COM	\$3,056	A	\$3,150	B	\$3,243	COL/C	\$3,403	D	\$3,614	E	\$3,822	F	\$4,148	G	\$4,494	H	\$4,865	I	\$5,445	J	\$6,141	L1	\$5,028	L2	\$5,514
COM	\$3,056																												
A	\$3,150																												
B	\$3,243																												
COL/C	\$3,403																												
D	\$3,614																												
E	\$3,822																												
F	\$4,148																												
G	\$4,494																												
H	\$4,865																												
I	\$5,445																												
J	\$6,141																												
L1	\$5,028																												
L2	\$5,514																												
45° Curved Seat High Back 	CT032303 · 30" outside radius · 62" inside radius · 7" high headrest · COM based on single fabric · multiple fabrics, see pages CT6-CT8 for yardage requirements · double cut veneer available; specify and add \$128 list	<table border="1"> <thead> <tr> <th>Dimensions</th> <th>D</th> <th>W</th> <th>H</th> </tr> </thead> <tbody> <tr> <td>Overall</td> <td>32</td> <td></td> <td>44½</td> </tr> <tr> <td>Seat</td> <td>20</td> <td></td> <td>18</td> </tr> </tbody> </table>	Dimensions	D	W	H	Overall	32		44½	Seat	20		18	<table border="1"> <thead> <tr> <th colspan="2">Upholstery</th> <th colspan="2">Shipping</th> </tr> </thead> <tbody> <tr> <td>COM Ydg</td> <td>4</td> <td>Ctn Wt</td> <td>102</td> </tr> <tr> <td>COL Sq Ft</td> <td>92</td> <td>Cu Ft</td> <td>42</td> </tr> </tbody> </table>	Upholstery		Shipping		COM Ydg	4	Ctn Wt	102	COL Sq Ft	92	Cu Ft	42		
		Dimensions	D	W	H																								
Overall	32		44½																										
Seat	20		18																										
Upholstery		Shipping																											
COM Ydg	4	Ctn Wt	102																										
COL Sq Ft	92	Cu Ft	42																										
			<table border="1"> <tbody> <tr><td>COM</td><td>\$3,288</td></tr> <tr><td>A</td><td>\$3,393</td></tr> <tr><td>B</td><td>\$3,510</td></tr> <tr><td>COL/C</td><td>\$3,708</td></tr> <tr><td>D</td><td>\$3,964</td></tr> <tr><td>E</td><td>\$4,221</td></tr> <tr><td>F</td><td>\$4,620</td></tr> <tr><td>G</td><td>\$5,050</td></tr> <tr><td>H</td><td>\$5,506</td></tr> <tr><td>I</td><td>\$6,218</td></tr> <tr><td>J</td><td>\$7,073</td></tr> <tr><td>L1</td><td>\$5,704</td></tr> <tr><td>L2</td><td>\$6,303</td></tr> </tbody> </table>	COM	\$3,288	A	\$3,393	B	\$3,510	COL/C	\$3,708	D	\$3,964	E	\$4,221	F	\$4,620	G	\$5,050	H	\$5,506	I	\$6,218	J	\$7,073	L1	\$5,704	L2	\$6,303
COM	\$3,288																												
A	\$3,393																												
B	\$3,510																												
COL/C	\$3,708																												
D	\$3,964																												
E	\$4,221																												
F	\$4,620																												
G	\$5,050																												
H	\$5,506																												
I	\$6,218																												
J	\$7,073																												
L1	\$5,704																												
L2	\$6,303																												
45° Curved Seat High Back 	CT032304 · 30" outside radius · 62" inside radius · 7" high headrest · 41¾" high stand up surface · COM based on single fabric · multiple fabrics, see pages CT6-CT8 for yardage requirements · double cut veneer available; specify and add \$128 list	<table border="1"> <thead> <tr> <th>Dimensions</th> <th>D</th> <th>W</th> <th>H</th> </tr> </thead> <tbody> <tr> <td>Overall</td> <td>42</td> <td></td> <td>44½</td> </tr> <tr> <td>Seat</td> <td>20</td> <td></td> <td>18</td> </tr> </tbody> </table>	Dimensions	D	W	H	Overall	42		44½	Seat	20		18	<table border="1"> <thead> <tr> <th colspan="2">Upholstery</th> <th colspan="2">Shipping</th> </tr> </thead> <tbody> <tr> <td>COM Ydg</td> <td>4</td> <td>Ctn Wt</td> <td>132</td> </tr> <tr> <td>COL Sq Ft</td> <td>92</td> <td>Cu Ft</td> <td>52</td> </tr> </tbody> </table>	Upholstery		Shipping		COM Ydg	4	Ctn Wt	132	COL Sq Ft	92	Cu Ft	52		
		Dimensions	D	W	H																								
Overall	42		44½																										
Seat	20		18																										
Upholstery		Shipping																											
COM Ydg	4	Ctn Wt	132																										
COL Sq Ft	92	Cu Ft	52																										
			<table border="1"> <tbody> <tr><td>COM</td><td>\$4,547</td></tr> <tr><td>A</td><td>\$4,672</td></tr> <tr><td>B</td><td>\$4,789</td></tr> <tr><td>COL/C</td><td>\$4,986</td></tr> <tr><td>D</td><td>\$5,243</td></tr> <tr><td>E</td><td>\$5,499</td></tr> <tr><td>F</td><td>\$5,899</td></tr> <tr><td>G</td><td>\$6,327</td></tr> <tr><td>H</td><td>\$6,784</td></tr> <tr><td>I</td><td>\$7,498</td></tr> <tr><td>J</td><td>\$8,352</td></tr> <tr><td>L1</td><td>\$6,982</td></tr> <tr><td>L2</td><td>\$7,582</td></tr> </tbody> </table>	COM	\$4,547	A	\$4,672	B	\$4,789	COL/C	\$4,986	D	\$5,243	E	\$5,499	F	\$5,899	G	\$6,327	H	\$6,784	I	\$7,498	J	\$8,352	L1	\$6,982	L2	\$7,582
COM	\$4,547																												
A	\$4,672																												
B	\$4,789																												
COL/C	\$4,986																												
D	\$5,243																												
E	\$5,499																												
F	\$5,899																												
G	\$6,327																												
H	\$6,784																												
I	\$7,498																												
J	\$8,352																												
L1	\$6,982																												
L2	\$7,582																												

Description	Model	Specifications				List Price Per Grade	
		Dimensions	D	W	H	COM	
45° Curved Seat Privacy Back 	CT032305 • 30" outside radius • 62" inside radius • 14" high headrest • COM based on single fabric • multiple fabrics, see pages CT6-CT8 for yardage requirements • double cut veneer available; specify and add \$128 list	Overall	32		51 1/2	COM	\$3,517
		Seat	20		18	COL/C	\$3,964
		Upholstery		Shipping		D	\$4,239
		COM Ydg	4 1/4	Ctn Wt	107	E	\$4,510
		COL Sq Ft	98	Cu Ft	50	F	\$4,935
						G	\$5,389
						H	\$5,875
						I	\$6,631
						J	\$7,539
						L1	\$6,087
						L2	\$6,724
45° Curved Seat Privacy Back with Stand Up Surface 	CT032306 • 30" outside radius • stand up surface corner; specify square (S) no upcharge or rounded (R) add \$49 list • 62" inside radius • 14" high headrest • 41 3/4" high stand up surface • COM based on single fabric • multiple fabrics, see pages CT6-CT8 for yardage requirements • double cut veneer available; specify and add \$128 list	Overall	42		51 1/2	COM	\$4,776
		Seat	20		18	COL/C	\$5,241
		Upholstery		Shipping		D	\$5,517
		COM Ydg	4 1/4	Ctn Wt	137	E	\$5,789
		COL Sq Ft	98	Cu Ft	60	F	\$6,213
						G	\$6,666
						H	\$7,153
						I	\$7,908
						J	\$8,820
						L1	\$7,364
						L2	\$8,001
45° Curved Seat Low Back 	CT032451 • 45" outside radius • 77" inside radius • COM based on single fabric • multiple fabrics, see pages CT6-CT8 for yardage requirements • double cut veneer available; specify and add \$128 list	Overall	32		30 1/2	COM	\$2,886
		Seat	20		18	COL/C	\$3,301
		Upholstery		Shipping		D	\$3,557
		COM Ydg	4	Ctn Wt	101	E	\$3,816
		COL Sq Ft	92	Cu Ft	34	F	\$4,215
						G	\$4,643
						H	\$5,098
						I	\$5,811
						J	\$6,665
						L1	\$5,298
						L2	\$5,897

To Order, Specify:




- 1 Model Number
- 2 Wood Species - Cherry (CH1), Maple (MA1), Walnut (WA1) or Double Cut (DC1)
- 3 Wood Finish [See Wood Finish Options](#)
- 4 Laminate Color Selection (Stand Up Surface) [See Laminate Color Selection](#)
- 5 Surface Corners (Stand Up Surface) - Square (S), no upcharge or Rounded (R), add \$49 list
- 6 Fabric Selection - vendor, pattern and color
 - A. Seat
 - B. Back
 - C. Headrest
 Visit www.jsifurniture.com/finishes-and-materials/textiles for our textiles program.
 See selection of standard and graded in manufacturers and patterns.
- 7 Metal Leg Color - [See Metal Leg Color Options](#)
- 8 Optional Power Center - Flush Mount (EC22) - Black (B) or White (W); \$583 list each, see page CT3 for location availability
- 9 Optional Rubber Cushion Nylon Glides - no upcharge
- 10 Product Options



Specifications

- Wood species - Cherry, Maple, Walnut or Double Cut. Seat has synthetic sheet webbing with cross strap reinforcement, 4 1/4" high density polyurethane foam.
- Back has high density polyurethane foam.
- Plywood construction with locking tenons, glue and screws.
- Linking bracket included.
- Metal legs are 16 gauge steel tube with metal leveling glides.
- 3/4" thick 10" deep laminate stand up surface with coordinating 3mm PVC edge supported by steel columns, 42" surface height.

Connect Modular Lounge



Description	① Model	Specifications	List Price Per Grade																																						
45° Curved Seat Mid Back 	CT032452 <ul style="list-style-type: none"> · 45" outside radius · 77" inside radius · COM based on single fabric · multiple fabrics, see pages CT6-CT8 for yardage requirements · double cut veneer available; specify and add \$128 list 	<table border="1"> <thead> <tr> <th>Dimensions</th> <th>D</th> <th>W</th> <th>H</th> </tr> </thead> <tbody> <tr> <td>Overall</td> <td>32</td> <td></td> <td>37½</td> </tr> <tr> <td>Seat</td> <td>20</td> <td></td> <td>18</td> </tr> </tbody> </table>	Dimensions	D	W	H	Overall	32		37½	Seat	20		18	<table border="1"> <tbody> <tr><td>COM</td><td>\$3,115</td></tr> <tr><td>A</td><td>\$3,229</td></tr> <tr><td>B</td><td>\$3,355</td></tr> <tr><td>COL/C</td><td>\$3,580</td></tr> <tr><td>D</td><td>\$3,869</td></tr> <tr><td>E</td><td>\$4,158</td></tr> <tr><td>F</td><td>\$4,608</td></tr> <tr><td>G</td><td>\$5,090</td></tr> <tr><td>H</td><td>\$5,603</td></tr> <tr><td>I</td><td>\$6,403</td></tr> <tr><td>J</td><td>\$7,367</td></tr> <tr><td>L1</td><td>\$5,826</td></tr> <tr><td>L2</td><td>\$6,500</td></tr> </tbody> </table>	COM	\$3,115	A	\$3,229	B	\$3,355	COL/C	\$3,580	D	\$3,869	E	\$4,158	F	\$4,608	G	\$5,090	H	\$5,603	I	\$6,403	J	\$7,367	L1	\$5,826	L2	\$6,500
		Dimensions	D	W	H																																				
Overall	32		37½																																						
Seat	20		18																																						
COM	\$3,115																																								
A	\$3,229																																								
B	\$3,355																																								
COL/C	\$3,580																																								
D	\$3,869																																								
E	\$4,158																																								
F	\$4,608																																								
G	\$5,090																																								
H	\$5,603																																								
I	\$6,403																																								
J	\$7,367																																								
L1	\$5,826																																								
L2	\$6,500																																								
		<table border="1"> <thead> <tr> <th>Upholstery</th> <th colspan="3">Shipping</th> </tr> </thead> <tbody> <tr> <td>COM Ydg</td> <td>4½</td> <td>Ctn Wt</td> <td>106</td> </tr> <tr> <td>COL Sq Ft</td> <td>104</td> <td>Cu Ft</td> <td>44</td> </tr> </tbody> </table>	Upholstery	Shipping			COM Ydg	4½	Ctn Wt	106	COL Sq Ft	104	Cu Ft	44																											
Upholstery	Shipping																																								
COM Ydg	4½	Ctn Wt	106																																						
COL Sq Ft	104	Cu Ft	44																																						
45° Curved Seat High Back 	CT032453 <ul style="list-style-type: none"> · 45" outside radius · 77" inside radius · 7" high headrest · COM based on single fabric · multiple fabrics, see pages CT6-CT8 for yardage requirements · double cut veneer available; specify and add \$128 list 	<table border="1"> <thead> <tr> <th>Dimensions</th> <th>D</th> <th>W</th> <th>H</th> </tr> </thead> <tbody> <tr> <td>Overall</td> <td>32</td> <td></td> <td>44½</td> </tr> <tr> <td>Seat</td> <td>20</td> <td></td> <td>18</td> </tr> </tbody> </table>	Dimensions	D	W	H	Overall	32		44½	Seat	20		18	<table border="1"> <tbody> <tr><td>COM</td><td>\$3,345</td></tr> <tr><td>A</td><td>\$3,476</td></tr> <tr><td>B</td><td>\$3,632</td></tr> <tr><td>COL/C</td><td>\$3,907</td></tr> <tr><td>D</td><td>\$4,259</td></tr> <tr><td>E</td><td>\$4,612</td></tr> <tr><td>F</td><td>\$5,162</td></tr> <tr><td>G</td><td>\$5,750</td></tr> <tr><td>H</td><td>\$6,377</td></tr> <tr><td>I</td><td>\$7,358</td></tr> <tr><td>J</td><td>\$8,534</td></tr> <tr><td>L1</td><td>\$6,652</td></tr> <tr><td>L2</td><td>\$7,475</td></tr> </tbody> </table>	COM	\$3,345	A	\$3,476	B	\$3,632	COL/C	\$3,907	D	\$4,259	E	\$4,612	F	\$5,162	G	\$5,750	H	\$6,377	I	\$7,358	J	\$8,534	L1	\$6,652	L2	\$7,475
		Dimensions	D	W	H																																				
Overall	32		44½																																						
Seat	20		18																																						
COM	\$3,345																																								
A	\$3,476																																								
B	\$3,632																																								
COL/C	\$3,907																																								
D	\$4,259																																								
E	\$4,612																																								
F	\$5,162																																								
G	\$5,750																																								
H	\$6,377																																								
I	\$7,358																																								
J	\$8,534																																								
L1	\$6,652																																								
L2	\$7,475																																								
		<table border="1"> <thead> <tr> <th>Upholstery</th> <th colspan="3">Shipping</th> </tr> </thead> <tbody> <tr> <td>COM Ydg</td> <td>5½</td> <td>Ctn Wt</td> <td>113</td> </tr> <tr> <td>COL Sq Ft</td> <td>127</td> <td>Cu Ft</td> <td>54</td> </tr> </tbody> </table>	Upholstery	Shipping			COM Ydg	5½	Ctn Wt	113	COL Sq Ft	127	Cu Ft	54																											
Upholstery	Shipping																																								
COM Ydg	5½	Ctn Wt	113																																						
COL Sq Ft	127	Cu Ft	54																																						
45° Curved Seat High Back with Stand Up Surface 	CT032454 <ul style="list-style-type: none"> · 45" outside radius · stand up surface corner; specify square (S) no upcharge or rounded (R) add \$49 list · 77" inside radius · 7" high headrest · 41¾" high stand up surface · COM based on single fabric · multiple fabrics, see pages CT6-CT8 for yardage requirements · double cut veneer available; specify and add \$128 list 	<table border="1"> <thead> <tr> <th>Dimensions</th> <th>D</th> <th>W</th> <th>H</th> </tr> </thead> <tbody> <tr> <td>Overall</td> <td>42</td> <td></td> <td>44½</td> </tr> <tr> <td>Seat</td> <td>20</td> <td></td> <td>18</td> </tr> </tbody> </table>	Dimensions	D	W	H	Overall	42		44½	Seat	20		18	<table border="1"> <tbody> <tr><td>COM</td><td>\$4,635</td></tr> <tr><td>A</td><td>\$4,783</td></tr> <tr><td>B</td><td>\$4,941</td></tr> <tr><td>COL/C</td><td>\$5,214</td></tr> <tr><td>D</td><td>\$5,567</td></tr> <tr><td>E</td><td>\$5,923</td></tr> <tr><td>F</td><td>\$6,468</td></tr> <tr><td>G</td><td>\$7,060</td></tr> <tr><td>H</td><td>\$7,684</td></tr> <tr><td>I</td><td>\$8,666</td></tr> <tr><td>J</td><td>\$9,843</td></tr> <tr><td>L1</td><td>\$7,961</td></tr> <tr><td>L2</td><td>\$8,783</td></tr> </tbody> </table>	COM	\$4,635	A	\$4,783	B	\$4,941	COL/C	\$5,214	D	\$5,567	E	\$5,923	F	\$6,468	G	\$7,060	H	\$7,684	I	\$8,666	J	\$9,843	L1	\$7,961	L2	\$8,783
		Dimensions	D	W	H																																				
Overall	42		44½																																						
Seat	20		18																																						
COM	\$4,635																																								
A	\$4,783																																								
B	\$4,941																																								
COL/C	\$5,214																																								
D	\$5,567																																								
E	\$5,923																																								
F	\$6,468																																								
G	\$7,060																																								
H	\$7,684																																								
I	\$8,666																																								
J	\$9,843																																								
L1	\$7,961																																								
L2	\$8,783																																								
		<table border="1"> <thead> <tr> <th>Upholstery</th> <th colspan="3">Shipping</th> </tr> </thead> <tbody> <tr> <td>COM Ydg</td> <td>5½</td> <td>Ctn Wt</td> <td>143</td> </tr> <tr> <td>COL Sq Ft</td> <td>127</td> <td>Cu Ft</td> <td>64</td> </tr> </tbody> </table>	Upholstery	Shipping			COM Ydg	5½	Ctn Wt	143	COL Sq Ft	127	Cu Ft	64																											
Upholstery	Shipping																																								
COM Ydg	5½	Ctn Wt	143																																						
COL Sq Ft	127	Cu Ft	64																																						

Description	1 Model	Specifications			List Price Per Grade	
45° Curved Seat Privacy Back 	CT032455 <ul style="list-style-type: none"> 45" outside radius 77" inside radius 14" high headrest COM based on single fabric multiple fabrics, see pages CT6-CT8 for yardage requirements double cut veneer available; specify and add \$128 list 	Dimensions	D	W	H	COM \$3,577
		Overall	32		51 ½	A \$3,716
		Seat	20		18	B \$3,886
		Upholstery	Shipping			COL/C \$4,186
		COM Ydg	6	Ctn Wt	118	D \$4,569
		COL Sq Ft	138	Cu Ft	63	E \$4,955
						F \$5,557
						G \$6,199
						H \$6,882
						I \$7,951
						J \$9,235
						L1 \$7,181
						L2 \$8,080
45° Curved Seat Privacy Back with Stand Up Surface 	CT032456 <ul style="list-style-type: none"> 45" outside radius stand up surface corner; specify square (S) no upcharge or rounded (R) add \$49 list 77" inside radius 14" high headrest 41 ¾" high stand up surface COM based on single fabric multiple fabrics, see pages CT6-CT8 for yardage requirements double cut veneer available; specify and add \$128 list 	Dimensions	D	W	H	COM \$4,864
		Overall	42		51 ½	A \$5,024
		Seat	20		18	B \$5,194
		Upholstery	Shipping			COL/C \$5,493
		COM Ydg	6	Ctn Wt	148	D \$5,879
		COL Sq Ft	138	Cu Ft	73	E \$6,264
						F \$6,861
						G \$7,506
						H \$8,190
						I \$9,259
						J \$10,542
						L1 \$8,489
						L2 \$9,386

To Order, Specify:

- 1 Model Number
- 2 Wood Species - Cherry (CH1), Maple (MA1), Walnut (WA1) or Double Cut (DC1)
- 3 Wood Finish [See Wood Finish Options](#)
- 4 Laminate Color Selection (Stand Up Surface) [See Laminate Color Selection](#)
- 5 Surface Corners (Stand Up Surface) - Square (S), no upcharge or Rounded (R), add \$49 list
- 6 Fabric Selection - vendor, pattern and color
 - A. Seat
 - B. Back
 - C. Headrest

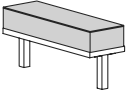
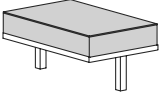
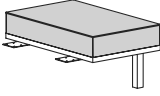
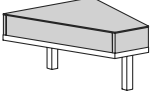
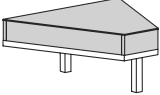
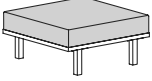
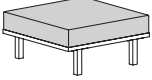
Visit www.jsifurniture.com/finishes-and-materials/textiles for our textiles program.
See selection of standard and graded in manufacturers and patterns.
- 7 Metal Leg Color - [See Metal Leg Color Options](#)
- 8 Optional Power Center - Flush Mount (EC22) - Black (B) or White (W); \$583 list each, see page CT3 for location availability
- 9 Optional Rubber Cushion Nylon Glides - no upcharge
- 10 Product Options

Specifications

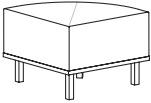
- Wood species - Cherry, Maple, Walnut or Double Cut. Seat has synthetic sheet webbing with cross strap reinforcement, 4 ¼" high density polyurethane foam.
- Back has high density polyurethane foam.
- Plywood construction with locking tenons, glue and screws.
- Linking bracket included.
- Metal legs are 16 gauge steel tube with metal leveling glides.
- ¾" thick 10" deep laminate stand up surface with coordinating 3mm PVC edge supported by steel columns, 42" surface height.

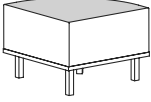
Connect Modular Lounge

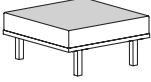


Description	D	W	H	CTN WT	CU FT	① Model	List Price
10" Linking Table  <ul style="list-style-type: none"> · attaches between lounge or bench units · wood top · wood chassis · double cut veneer available; specify and add \$170 list 	32	10	15	36	2	CTR3210CC	\$1,112
20" Linking Table  <ul style="list-style-type: none"> · attaches between lounge or bench units · wood top · wood chassis · double cut veneer available; specify and add \$170 list 	32	20	15	53	4	CTR3220CC	\$1,267
20" End Table  <ul style="list-style-type: none"> · attaches to end of lounge or bench unit · wood top · wood chassis · double cut veneer available; specify and add \$170 list 	32	20	15	58	10	CTR3220CE	\$1,336
10" - 30° Linking Table  <ul style="list-style-type: none"> · attaches between lounge or bench units to form a 30° connection · wood top · wood chassis · double cut veneer available; specify and add \$170 list 	32	10-26½	15	49	5	CTW30C	\$1,207
10" - 45° Linking Table  <ul style="list-style-type: none"> · attaches between lounge or bench units to form a 45° connection · wood top · wood chassis · double cut veneer available; specify and add \$170 list 	32	10-34½	15	56	7	CTW45C	\$1,235
Wood Table  <ul style="list-style-type: none"> · 32" square · wood top · wood chassis · straight grain · double cut veneer available; specify and add \$170 list 	32	32	15	78	9	CTS32WS	\$1,408
Wood Table  <ul style="list-style-type: none"> · 32" square · wood top · wood chassis · angled grain · double cut veneer available; specify and add \$170 list 	32	32	15	78	9	CTS32WA	\$1,408

CONNECT

Description	① Model	Specifications				List Price Per Grade	
		Dimensions	D	W	H	COM	
Upholstered Quarter Round Table 	CTW90U · upholstered top · upholstered chassis · table height is same as arm height · double cut veneer available; specify and add \$128 list	Overall	32	32	24½	COM	\$1,629
		Upholstery		Shipping			
		COM Ydg	2½	Ctn Wt	69	A	\$1,690
		COL Sq Ft	58	Cu Ft	16	B	\$1,762
						COL/C	\$1,886
						D	\$2,045
						E	\$2,207
						F	\$2,456
						G	\$2,725
						H	\$3,010
						I	\$3,454
						J	\$3,990
						L1	\$3,135
						L2	\$3,510

Description	① Model	Specifications				List Price Per Grade	
		Dimensions	D	W	H	COM	
Upholstered Quarter Round Table 	CTW90W · wood top · diagonal grain · upholstered chassis · table height is same as arm height · double cut veneer available; specify and add \$198 list	Overall	32	32	24½	COM	\$1,678
		Upholstery		Shipping			
		COM Ydg	1½	Ctn Wt	78	A	\$1,727
		COL Sq Ft	35	Cu Ft	16	B	\$1,770
						COL/C	\$1,843
						D	\$1,939
						E	\$2,035
						F	\$2,186
						G	\$2,348
						H	\$2,516
						I	\$2,784
						J	\$3,103
						L1	\$2,591
						L2	\$2,817

Description	① Model	Specifications				List Price Per Grade	
		Dimensions	D	W	H	COM	
Upholstered Table 	CTS32U · 32" square · wood top · upholstered chassis · freestanding application · double cut veneer available; specify and add \$198 list	Overall	32	32	15	COM	\$1,577
		Upholstery		Shipping			
		COM Ydg	1	Ctn Wt	78	A	\$1,616
		COL Sq Ft	23	Cu Ft	9	B	\$1,644
						COL/C	\$1,693
						D	\$1,759
						E	\$1,821
						F	\$1,921
						G	\$2,031
						H	\$2,143
						I	\$2,321
						J	\$2,537
						L1	\$2,193
						L2	\$2,344

To Order, Specify:

- ① Model Number
- ② Wood Species - Cherry (CH1), Maple (MA1), Walnut (WA1) or Double Cut (DC1)
- ③ Wood Finish See [Wood Finish Options](#)
- ④ Fabric Selection - vendor, pattern and color
Visit www.jsifurniture.com/finishes-and-materials/textiles for our textiles program.
See selection of standard and graded in manufacturers and patterns.
- ⑤ Metal Leg Color - See [Metal Leg Color Options](#)
- ⑥ Optional Power Center - Flush Mount (EC22) - Black (B) or White (W); \$583 list each for linking or end tables
- ⑦ Optional Drink Holder(s) (DH) - add \$240 list for linking or end tables
- ⑧ Optional Coordinating Wood Grain Laminate Available on Table Tops - no upcharge. Finishes with an asterisk have a coordinating laminate available
- ⑨ Optional Rubber Cushion Nylon Glides - no upcharge
- ⑩ Product Options

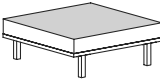
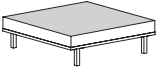
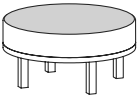
Specifications

- Wood species - Cherry, Maple, Walnut or Double Cut. Table has ¾" high density polyurethane foam.
- Plywood construction with locking tenons, glue and screws.
- Linking bracket included.
- Metal legs are 16 gauge steel tube with metal leveling glides.

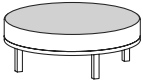
CONNECT

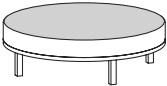
Connect Modular Lounge



Description	① Model	Specifications	List Price Per Grade																																												
Upholstered Table 	CTS40U · 40" square · wood top · upholstered chassis · freestanding application · double cut veneer available; specify and add \$198 list	<table border="1"> <thead> <tr> <th>Dimensions</th> <th>D</th> <th>W</th> <th>H</th> </tr> </thead> <tbody> <tr> <td>Overall</td> <td>40</td> <td>40</td> <td>15</td> </tr> </tbody> </table>	Dimensions	D	W	H	Overall	40	40	15	<table border="1"> <thead> <tr> <th>Upholstery</th> <th colspan="2">Shipping</th> </tr> </thead> <tbody> <tr> <td>COM Ydg</td> <td>1</td> <td>Ctn Wt 85</td> </tr> <tr> <td>COL Sq Ft</td> <td>23</td> <td>Cu Ft 14</td> </tr> </tbody> </table>	Upholstery	Shipping		COM Ydg	1	Ctn Wt 85	COL Sq Ft	23	Cu Ft 14	<table border="1"> <tbody> <tr><td>COM</td><td>\$1,771</td></tr> <tr><td>A</td><td>\$1,811</td></tr> <tr><td>B</td><td>\$1,840</td></tr> <tr><td>COL/C</td><td>\$1,889</td></tr> <tr><td>D</td><td>\$1,955</td></tr> <tr><td>E</td><td>\$2,018</td></tr> <tr><td>F</td><td>\$2,117</td></tr> <tr><td>G</td><td>\$2,224</td></tr> <tr><td>H</td><td>\$2,337</td></tr> <tr><td>I</td><td>\$2,517</td></tr> <tr><td>J</td><td>\$2,731</td></tr> <tr><td>L1</td><td>\$2,389</td></tr> <tr><td>L2</td><td>\$2,539</td></tr> </tbody> </table>	COM	\$1,771	A	\$1,811	B	\$1,840	COL/C	\$1,889	D	\$1,955	E	\$2,018	F	\$2,117	G	\$2,224	H	\$2,337	I	\$2,517	J	\$2,731	L1	\$2,389	L2	\$2,539
		Dimensions	D	W	H																																										
Overall	40	40	15																																												
Upholstery	Shipping																																														
COM Ydg	1	Ctn Wt 85																																													
COL Sq Ft	23	Cu Ft 14																																													
COM	\$1,771																																														
A	\$1,811																																														
B	\$1,840																																														
COL/C	\$1,889																																														
D	\$1,955																																														
E	\$2,018																																														
F	\$2,117																																														
G	\$2,224																																														
H	\$2,337																																														
I	\$2,517																																														
J	\$2,731																																														
L1	\$2,389																																														
L2	\$2,539																																														
Upholstered Table 	CTS50U · 50" square · wood top · upholstered chassis · freestanding application · double cut veneer available; specify and add \$198 list	<table border="1"> <thead> <tr> <th>Dimensions</th> <th>D</th> <th>W</th> <th>H</th> </tr> </thead> <tbody> <tr> <td>Overall</td> <td>50</td> <td>50</td> <td>15</td> </tr> </tbody> </table>	Dimensions	D	W	H	Overall	50	50	15	<table border="1"> <thead> <tr> <th>Upholstery</th> <th colspan="2">Shipping</th> </tr> </thead> <tbody> <tr> <td>COM Ydg</td> <td>1</td> <td>Ctn Wt 92</td> </tr> <tr> <td>COL Sq Ft</td> <td>23</td> <td>Cu Ft 21</td> </tr> </tbody> </table>	Upholstery	Shipping		COM Ydg	1	Ctn Wt 92	COL Sq Ft	23	Cu Ft 21	<table border="1"> <tbody> <tr><td>COM</td><td>\$1,968</td></tr> <tr><td>A</td><td>\$2,014</td></tr> <tr><td>B</td><td>\$2,041</td></tr> <tr><td>COL/C</td><td>\$2,093</td></tr> <tr><td>D</td><td>\$2,157</td></tr> <tr><td>E</td><td>\$2,221</td></tr> <tr><td>F</td><td>\$2,320</td></tr> <tr><td>G</td><td>\$2,428</td></tr> <tr><td>H</td><td>\$2,540</td></tr> <tr><td>I</td><td>\$2,721</td></tr> <tr><td>J</td><td>\$2,934</td></tr> <tr><td>L1</td><td>\$2,591</td></tr> <tr><td>L2</td><td>\$2,743</td></tr> </tbody> </table>	COM	\$1,968	A	\$2,014	B	\$2,041	COL/C	\$2,093	D	\$2,157	E	\$2,221	F	\$2,320	G	\$2,428	H	\$2,540	I	\$2,721	J	\$2,934	L1	\$2,591	L2	\$2,743
		Dimensions	D	W	H																																										
Overall	50	50	15																																												
Upholstery	Shipping																																														
COM Ydg	1	Ctn Wt 92																																													
COL Sq Ft	23	Cu Ft 21																																													
COM	\$1,968																																														
A	\$2,014																																														
B	\$2,041																																														
COL/C	\$2,093																																														
D	\$2,157																																														
E	\$2,221																																														
F	\$2,320																																														
G	\$2,428																																														
H	\$2,540																																														
I	\$2,721																																														
J	\$2,934																																														
L1	\$2,591																																														
L2	\$2,743																																														
Table 	CTD30U · 30" diameter · wood top · upholstered chassis · freestanding application · double cut veneer available; specify and add \$198 list	<table border="1"> <thead> <tr> <th>Dimensions</th> <th>D</th> <th>W</th> <th>H</th> </tr> </thead> <tbody> <tr> <td>Overall</td> <td>30</td> <td></td> <td>15</td> </tr> </tbody> </table>	Dimensions	D	W	H	Overall	30		15	<table border="1"> <thead> <tr> <th>Upholstery</th> <th colspan="2">Shipping</th> </tr> </thead> <tbody> <tr> <td>COM Ydg</td> <td>1</td> <td>Ctn Wt 70</td> </tr> <tr> <td>COL Sq Ft</td> <td>23</td> <td>Cu Ft 10</td> </tr> </tbody> </table>	Upholstery	Shipping		COM Ydg	1	Ctn Wt 70	COL Sq Ft	23	Cu Ft 10	<table border="1"> <tbody> <tr><td>COM</td><td>\$2,811</td></tr> <tr><td>A</td><td>\$2,866</td></tr> <tr><td>B</td><td>\$2,896</td></tr> <tr><td>COL/C</td><td>\$2,943</td></tr> <tr><td>D</td><td>\$3,010</td></tr> <tr><td>E</td><td>\$3,075</td></tr> <tr><td>F</td><td>\$3,174</td></tr> <tr><td>G</td><td>\$3,279</td></tr> <tr><td>H</td><td>\$3,395</td></tr> <tr><td>I</td><td>\$3,574</td></tr> <tr><td>J</td><td>\$3,788</td></tr> <tr><td>L1</td><td>\$3,446</td></tr> <tr><td>L2</td><td>\$3,594</td></tr> </tbody> </table>	COM	\$2,811	A	\$2,866	B	\$2,896	COL/C	\$2,943	D	\$3,010	E	\$3,075	F	\$3,174	G	\$3,279	H	\$3,395	I	\$3,574	J	\$3,788	L1	\$3,446	L2	\$3,594
		Dimensions	D	W	H																																										
Overall	30		15																																												
Upholstery	Shipping																																														
COM Ydg	1	Ctn Wt 70																																													
COL Sq Ft	23	Cu Ft 10																																													
COM	\$2,811																																														
A	\$2,866																																														
B	\$2,896																																														
COL/C	\$2,943																																														
D	\$3,010																																														
E	\$3,075																																														
F	\$3,174																																														
G	\$3,279																																														
H	\$3,395																																														
I	\$3,574																																														
J	\$3,788																																														
L1	\$3,446																																														
L2	\$3,594																																														

CONNECT

Description	① Model	Specifications				List Price Per Grade	
Table 	CTD42U · 42" diameter · wood top · upholstered chassis · freestanding application · double cut veneer available; specify and add \$198 list	Dimensions		D	W	H	COM \$3,010
		Overall		42		15	A \$3,067
		Upholstery		Shipping			B \$3,097
		COM Ydg	1	Ctn Wt	79	COL/C \$3,148	
		COL Sq Ft	23	Cu Ft	18	D \$3,211	
						E \$3,276	
				F \$3,376			
				G \$3,483			
				H \$3,597			
				I \$3,777			
				J \$3,990			
				L1 \$3,645			
				L2 \$3,795			

Description	① Model	Specifications				List Price Per Grade	
Table 	CTD50U · 50" diameter · wood top · upholstered chassis · freestanding application · double cut veneer available; specify and add \$198 list	Dimensions		D	W	H	COM \$3,125
		Overall		50		15	A \$3,187
		Upholstery		Shipping			B \$3,214
		COM Ydg	1	Ctn Wt	90	COL/C \$3,266	
		COL Sq Ft	23	Cu Ft	25	D \$3,330	
						E \$3,392	
				F \$3,492			
				G \$3,599			
				H \$3,715			
				I \$3,892			
				J \$4,106			
				L1 \$3,763			
				L2 \$3,914			

To Order, Specify:

- ① Model Number
- ② Wood Species - Cherry (CH1), Maple (MA1), Walnut (WA1) or Double Cut (DC1)
- ③ Wood Finish See [Wood Finish Options](#)
- ④ Fabric Selection - vendor, pattern and color
Visit www.jsifurniture.com/finishes-and-materials/textiles for our textiles program.
See selection of standard and graded in manufacturers and patterns.
- ⑤ Metal Leg Color - See [Metal Leg Color Options](#)
- ⑥ Optional Coordinating Wood Grain Laminate Available on Table Tops - no upcharge. Finishes with an asterisk have a coordinating laminate available
- ⑦ Optional Rubber Cushion Nylon Glides - no upcharge
- ⑧ Product Options

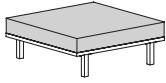
Specifications

- Wood species - Cherry, Maple, Walnut or Double Cut. Plywood construction with locking tenons, glue and screws.
- Metal legs are 16 gauge steel tube with metal leveling glides.

Connect Modular Lounge

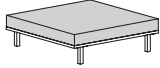


Description	D	W	H	CTN WT	CU FT	① Model	List Price
Wood Table	40	40	15	85	14	CTS40W	\$1,521



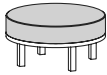
- 40" square
- wood top
- wood chassis
- freestanding application
- double cut veneer available; specify and add \$225 list

Wood Table	50	50	15	92	21	CTS50W	\$1,733
------------	----	----	----	----	----	--------	---------



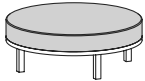
- 50" square
- wood top
- wood chassis
- freestanding application
- double cut veneer available; specify and add \$225 list

Table	30	15	81	10	CTD30W	\$2,772
-------	----	----	----	----	--------	---------



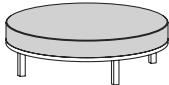
- 30" diameter
- wood top
- wood chassis
- freestanding application
- double cut veneer available; specify and add \$315 list

Table	42	15	90	18	CTD42W	\$3,168
-------	----	----	----	----	--------	---------



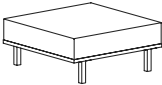
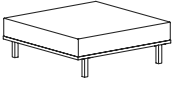

- 42" diameter
- wood top
- wood chassis
- freestanding application
- double cut veneer available; specify and add \$315 list

Table	50	15	103	25	CTD50W	\$3,672
-------	----	----	-----	----	--------	---------



- 50" diameter
- wood top
- wood chassis
- freestanding application
- double cut veneer available; specify and add \$315 list

CONNECT

Description	① Model	Specifications	List Price Per Grade												
Ottoman 	CTS400 · 40" square · fully upholstered · freestanding application · double cut veneer available; specify and add \$128 list	<table border="1"> <thead> <tr> <th>Dimensions</th> <th>D</th> <th>W</th> <th>H</th> </tr> </thead> <tbody> <tr> <td>Overall</td> <td>40</td> <td>40</td> <td>18</td> </tr> <tr> <td>Seat</td> <td>40</td> <td>40</td> <td>18</td> </tr> </tbody> </table>	Dimensions	D	W	H	Overall	40	40	18	Seat	40	40	18	COM \$1,868 A \$1,931 B \$2,004 COL/C \$2,127 D \$2,287 E \$2,448 F \$2,697 G \$2,966 H \$3,249 I \$3,698 J \$4,230 L1 \$3,375 L2 \$3,750
		Dimensions	D	W	H										
Overall	40	40	18												
Seat	40	40	18												
<table border="1"> <thead> <tr> <th>Upholstery</th> <th colspan="3">Shipping</th> </tr> </thead> <tbody> <tr> <td>COM Ydg</td> <td>2 ½</td> <td>Ctn Wt</td> <td>80</td> </tr> <tr> <td>COL Sq Ft</td> <td>58</td> <td>Cu Ft</td> <td>17</td> </tr> </tbody> </table>	Upholstery	Shipping			COM Ydg	2 ½	Ctn Wt	80	COL Sq Ft	58	Cu Ft	17			
Upholstery	Shipping														
COM Ydg	2 ½	Ctn Wt	80												
COL Sq Ft	58	Cu Ft	17												
Ottoman 	CTS500 · 50" square · fully upholstered · freestanding application · double cut veneer available; specify and add \$128 list	<table border="1"> <thead> <tr> <th>Dimensions</th> <th>D</th> <th>W</th> <th>H</th> </tr> </thead> <tbody> <tr> <td>Overall</td> <td>50</td> <td>50</td> <td>18</td> </tr> <tr> <td>Seat</td> <td>50</td> <td>50</td> <td>18</td> </tr> </tbody> </table>	Dimensions	D	W	H	Overall	50	50	18	Seat	50	50	18	COM \$1,957 A \$2,022 B \$2,093 COL/C \$2,218 D \$2,378 E \$2,538 F \$2,787 G \$3,055 H \$3,340 I \$3,787 J \$4,321 L1 \$3,465 L2 \$3,840
		Dimensions	D	W	H										
Overall	50	50	18												
Seat	50	50	18												
<table border="1"> <thead> <tr> <th>Upholstery</th> <th colspan="3">Shipping</th> </tr> </thead> <tbody> <tr> <td>COM Ydg</td> <td>2 ½</td> <td>Ctn Wt</td> <td>87</td> </tr> <tr> <td>COL Sq Ft</td> <td>58</td> <td>Cu Ft</td> <td>25</td> </tr> </tbody> </table>	Upholstery	Shipping			COM Ydg	2 ½	Ctn Wt	87	COL Sq Ft	58	Cu Ft	25			
Upholstery	Shipping														
COM Ydg	2 ½	Ctn Wt	87												
COL Sq Ft	58	Cu Ft	25												
Ottoman 	CTD300 · 30" diameter · fully upholstered · freestanding application · double cut veneer available; specify and add \$128 list	<table border="1"> <thead> <tr> <th>Dimensions</th> <th>D</th> <th>W</th> <th>H</th> </tr> </thead> <tbody> <tr> <td>Overall</td> <td>30</td> <td></td> <td>15</td> </tr> </tbody> </table>	Dimensions	D	W	H	Overall	30		15	COM \$2,550 A \$2,619 B \$2,686 COL/C \$2,800 D \$2,941 E \$3,087 F \$3,310 G \$3,552 H \$3,810 I \$4,210 J \$4,690 L1 \$3,920 L2 \$4,257				
		Dimensions	D	W	H										
Overall	30		15												
<table border="1"> <thead> <tr> <th>Upholstery</th> <th colspan="3">Shipping</th> </tr> </thead> <tbody> <tr> <td>COM Ydg</td> <td>2 ¼</td> <td>Ctn Wt</td> <td>65</td> </tr> <tr> <td>COL Sq Ft</td> <td>52</td> <td>Cu Ft</td> <td>10</td> </tr> </tbody> </table>	Upholstery	Shipping			COM Ydg	2 ¼	Ctn Wt	65	COL Sq Ft	52	Cu Ft	10			
Upholstery	Shipping														
COM Ydg	2 ¼	Ctn Wt	65												
COL Sq Ft	52	Cu Ft	10												

To Order, Specify:

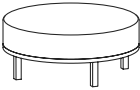
- ① Model Number
- ② Wood Species - Cherry (CH1), Maple (MA1), Walnut (WA1) or Double Cut (DC1)
- ③ Wood Finish [See Wood Finish Options](#)
- ④ Fabric Selection - vendor, pattern and color
 Visit www.jsifurniture.com/finishes-and-materials/textiles for our textiles program.
 See selection of standard and graded in manufacturers and patterns.
- ⑤ Metal Leg Color - [See Metal Leg Color Options](#)
- ⑥ Optional Coordinating Wood Grain Laminate Available on Table Tops - no upcharge. Finishes with an asterisk have a coordinating laminate available
- ⑦ Optional Rubber Cushion Nylon Glides - no upcharge
- ⑧ Product Options

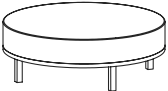
Specifications

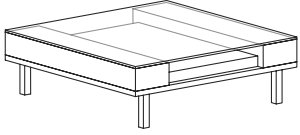
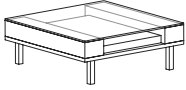
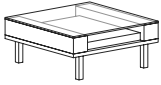
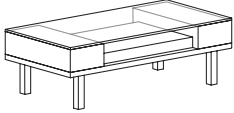
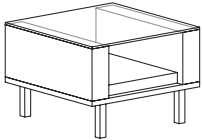
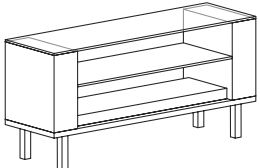
- Wood species - Cherry, Maple, Walnut or Double Cut. Plywood construction with locking tenons, glue and screws.
- Metal legs are 16 gauge steel tube with metal leveling glides.

Connect Modular Lounge



Description	① Model	Specifications				List Price Per Grade	
Ottoman 	CTD420 · 42" diameter · fully upholstered · freestanding application · double cut veneer available; specify and add \$128 list	Dimensions		D	W	H	COM \$2,663
		Overall		42		15	A \$2,743
		Upholstery		Shipping		B \$2,812	COL/C \$2,938
		COM Ydg	2 ½	Ctn Wt	74	D \$3,097	E \$3,258
		COL Sq Ft	58	Cu Ft	18	F \$3,510	G \$3,777
						H \$4,063	I \$4,507
						J \$5,042	L1 \$4,185
						L2 \$4,560	

Description	① Model	Specifications				List Price Per Grade	
Ottoman 	CTD500 · 50" diameter · fully upholstered · freestanding application · double cut veneer available; specify and add \$128 list	Dimensions		D	W	H	COM \$2,780
		Overall		50		15	A \$2,861
		Upholstery		Shipping		B \$2,940	COL/C \$3,078
		COM Ydg	2 ¾	Ctn Wt	84	D \$3,254	E \$3,429
		COL Sq Ft	64	Cu Ft	25	F \$3,706	G \$4,001
						H \$4,313	I \$4,802
						J \$5,391	L1 \$4,450
						L2 \$4,863	

Description	D	W	H	CTN WT	CU FT	① Model	List Price
 <p>Magazine Table</p> <ul style="list-style-type: none"> · glass top · freestanding application · double cut veneer available; specify and add \$225 list 	48	48	15	202	30	CT4848-15	\$3,678
 <p>Magazine Table</p> <ul style="list-style-type: none"> · glass top · freestanding application · double cut veneer available; specify and add \$225 list 	42	42	15	173	21	CT4242-15	\$3,429
 <p>Magazine Table</p> <ul style="list-style-type: none"> · glass top · freestanding application · double cut veneer available; specify and add \$225 list 	36	36	15	145	16	CT3636-15	\$3,243
 <p>Magazine Table</p> <ul style="list-style-type: none"> · glass top · freestanding application · double cut veneer available; specify and add \$225 list 	24	48	15	137	15	CT2448-15	\$3,205
 <p>End Table</p> <ul style="list-style-type: none"> · glass top · freestanding application · double cut veneer available; specify and add \$225 list 	32	32	22	134	18	CT3232-22	\$3,074
 <p>Sofa Table</p> <ul style="list-style-type: none"> · glass top and shelf · freestanding application · double cut veneer available; specify and add \$225 list 	18	60	28	182	25	CT1860-28	\$4,475

To Order, Specify:

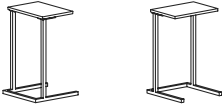
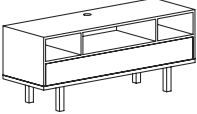
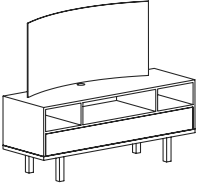
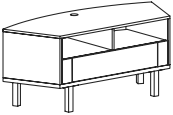
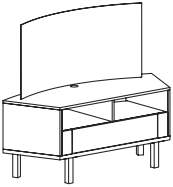
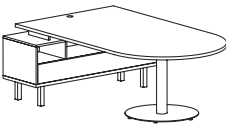
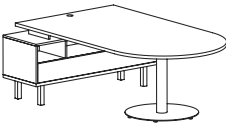
- ① Model Number
- ② Wood Species - Cherry (CH1), Maple (MA1), Walnut (WA1) or Double Cut (DC1)
- ③ Wood Finish [See Wood Finish Options](#)
- ④ Fabric Selection - vendor, pattern and color
Visit www.jsifurniture.com/finishes-and-materials/textiles for our textiles program.
See selection of standard and graded in manufacturers and patterns.
- ⑤ Metal Leg Color - [See Metal Leg Color Options](#)
- ⑥ Optional Rubber Cushion Nylon Glides - no upcharge
- ⑦ Product Options

Specifications

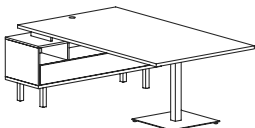
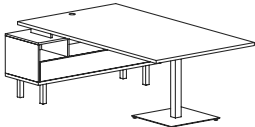
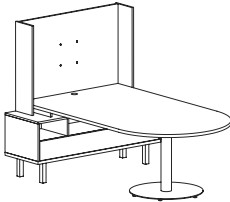
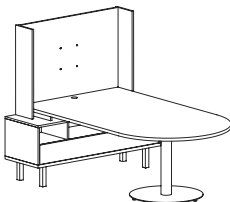
- Wood species - Cherry, Maple, Walnut or Double Cut.
- Seat has synthetic sheet webbing with cross strap reinforcement, 4 ¼" high density polyurethane foam.
- Plywood construction with locking tenons, glue and screws.
- Linking bracket included.
- Metal legs are 16 gauge steel tube with metal leveling glides.

Connect Modular Lounge



Description	D	W	H	CTN WT	CU FT	① Model	List Price
Pull Up Table  <ul style="list-style-type: none"> · ¾" top thickness · 12" top depth · double cut veneer available; specify and add \$66 list 	17	17	27	15	3	CT1717LTT	\$1,320
Media Cabinet  <ul style="list-style-type: none"> · one surface grommet · lower hinged access panel · double cut veneer available; specify and add \$280 list 	20	60	25	140	22	CT2060M	\$2,567
Media Cabinet  <ul style="list-style-type: none"> · frosted acrylic screen - ¼"d x 50"w x 26"h · one surface grommet · lower hinged access panel · double cut veneer available; specify and add \$280 list 	20	60	25	140	22	CT2060MAS	\$2,992
Media Cabinet  <ul style="list-style-type: none"> · 45 degree radius · 77" outside radius · 24 ⅝" deep at deepest point · 45" front width · one surface grommet · lower hinged access panel · double cut veneer available; specify and add \$280 list 	20	60	25	130	23	CT2060MC	\$2,551
Media Cabinet  <ul style="list-style-type: none"> · frosted acrylic screen - ¼"d x 50"w x 26"h · 45 degree radius · 77" outside radius · 24 ⅝" deep at deepest point · 45" front width · one surface grommet · lower hinged access panel · double cut veneer available; specify and add \$280 list 	20	60	25	130	23	CT2060MCAS	\$2,977
Media Activity Center  <ul style="list-style-type: none"> · bullet shape top · one surface grommet · base has a 4" diameter column with 24" diameter disc · R3 edge on worksurface · top thickness 1 ⅜" · worksurface height 29" · media cabinet included · double cut veneer available; specify and add \$417 list 	84	60	29	335	40	CT6084MACB	\$4,682
Media Activity Center  <ul style="list-style-type: none"> · bullet shape top · one surface grommet · base has a 4" diameter column with 24" diameter disc · R3 edge on worksurface · top thickness 1 ⅜" · worksurface height 29" · media cabinet included · double cut veneer available; specify and add \$417 list 	72	60	29	310	39	CT6072MACB	\$4,508

CONNECT

Description	D	W	H	CTN WT	CU FT	① Model	List Price
 <p>Media Activity Center</p> <ul style="list-style-type: none"> • rectangular shape top • one surface grommet • base has a 3" x 3" square column with an 18" x 18" square base • R3 edge on worksurface • top thickness 1 3/16" • worksurface height 29" • media cabinet included • double cut veneer available; specify and add \$417 list 	84	60	29	344	40	CT6084MACR	\$4,982
 <p>Media Activity Center</p> <ul style="list-style-type: none"> • rectangular shape top • one surface grommet • base has a 3" x 3" square column with an 18" x 18" square base • R3 edge on worksurface • top thickness 1 3/16" • worksurface height 29" • media cabinet included • double cut veneer available; specify and add \$417 list 	72	60	29	319	39	CT6072MACR	\$4,808
 <p>Media Activity Center</p> <ul style="list-style-type: none"> • bullet shape top • one surface grommet • base has a 4" diameter column with 24" diameter disc • R3 edge on worksurface • top thickness 1 3/16" • worksurface height 29" • back wall panel is 31" high from top of worksurface to top of panel • back wall panel is 48" wide, from inside panel to inside panel • back wall ships KD • media cabinet and TV mount included • TV not included • double cut veneer available; specify and add \$417 list 	84	60	29	350	40	CT6084MACBW	\$5,677
 <p>Media Activity Center</p> <ul style="list-style-type: none"> • bullet shape top • one surface grommet • base has a 4" diameter column with 24" diameter disc • R3 edge on worksurface • top thickness 1 3/16" • worksurface height 29" • back wall panel is 31" high from top of worksurface to top of panel • back wall panel is 48" wide, from inside panel to inside panel • back wall ships KD • media cabinet and TV mount included • TV not included • double cut veneer available; specify and add \$417 list 	72	60	29	325	29	CT6072MACBW	\$5,503

To Order, Specify:

- ① Model Number
- ② Wood Species - Cherry (CH1), Maple (MA1), Walnut (WA1) or Double Cut (DC1)
- ③ Wood Finish [See Wood Finish Options](#)
- ④ Metal Leg Color - [See Metal Leg Color Options](#)
- ⑤ Optional Coordinating Wood Grain Laminate Available on Main Horizontal Surface - no upcharge. Finishes with an asterisk have a coordinating laminate available.
- ⑥ Optional Rubber Cushion Nylon Glides - no upcharge
- ⑦ Product Options

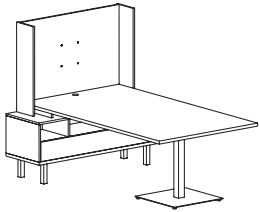
Specifications

- Wood species - Cherry, Maple, Walnut or Double Cut.
- Plywood construction with locking tenons, glue and screws.
- Linking bracket included.
- Metal legs are 16 gauge steel tube with metal leveling glides.

Connect Modular Lounge

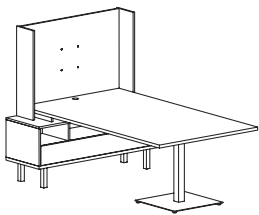


Description	D	W	H	CTN WT	CU FT	① Model	List Price
Media Activity Center	84	60	29	359	40	CT6084MACRW	\$5,978

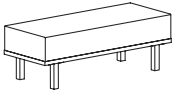
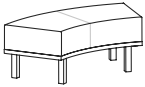
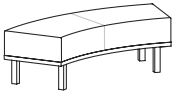


- rectangular shape top
- one surface grommet
- base has a 3" x 3" square column with an 18" x 18" square base
- R3 edge on worksurface
- top thickness 1 3/16"
- worksurface height 29"
- back wall panel is 31" high from top of worksurface to top of panel
- back wall panel is 48" wide, from inside panel to inside panel
- back wall ships KD
- media cabinet and TV mount included
- double cut veneer available; specify and add \$417 list

Media Activity Center	72	60	29	329	39	CT6072MACRW	\$5,804
-----------------------	----	----	----	-----	----	-------------	---------



- rectangular shape top
- one surface grommet
- base has a 3" x 3" square column with an 18" x 18" square base
- R3 edge on worksurface
- top thickness 1 3/16"
- worksurface height 29"
- back wall panel is 31" high from top of worksurface to top of panel
- back wall panel is 48" wide, from inside panel to inside panel
- back wall ships KD
- media cabinet and TV mount included
- double cut veneer available; specify and add \$417 list

Description	Model	Specifications				List Price Per Grade	
Media Bench 	CTR20500 <ul style="list-style-type: none"> used with media cabinet double cut veneer available; specify and add \$128 list 	Dimensions		D	W	H	COM \$1,678
		Overall	20	50	18	A	\$1,727
		Seat	20	50			B \$1,770
		Upholstery		Shipping			COL/C \$1,843
		COM Ydg	1 ½	Ctn Wt	52		D \$1,939
		COL Sq Ft	35	Cu Ft	11		E \$2,035
							F \$2,186
							G \$2,348
							H \$2,516
							I \$2,784
							J \$3,103
							L1 \$2,591
							L2 \$2,817
Curved Media Bench 	CTI20420 <ul style="list-style-type: none"> 45 degree 42" inside radius 62" outside radius used with media cabinet double cut veneer available; specify and add \$128 list 	Dimensions		D	W	H	COM \$1,989
		Overall	20		18	A	\$2,042
		Seat	20				B \$2,095
		Upholstery		Shipping			COL/C \$2,182
		COM Ydg	1 ¾	Ctn Wt	51		D \$2,294
		COL Sq Ft	41	Cu Ft	12		E \$2,405
							F \$2,580
							G \$2,770
							H \$2,968
							I \$3,279
							J \$3,658
							L1 \$3,055
							L2 \$3,317
Curved Media Bench 	CTI20570 <ul style="list-style-type: none"> 45 degree 57" inside radius 77" outside radius used with media cabinet double cut veneer available; specify and add \$128 list 	Dimensions		D	W	H	COM \$2,004
		Overall	20		18	A	\$2,063
		Seat	20				B \$2,119
		Upholstery		Shipping			COL/C \$2,220
		COM Ydg	2	Ctn Wt	54		D \$2,349
		COL Sq Ft	46	Cu Ft	16		E \$2,476
							F \$2,677
							G \$2,892
							H \$3,120
							I \$3,474
							J \$3,903
							L1 \$3,218
							L2 \$3,517

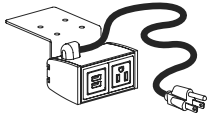
To Order, Specify:

- Model Number
- Wood Species - Cherry (CH1), Maple (MA1), Walnut (WA1) or Double Cut (DC1)
- Wood Finish [See Wood Finish Options](#)
- Fabric Selection - vendor, pattern and color
Visit www.jsifurniture.com/finishes-and-materials/textiles for our textiles program.
See selection of standard and graded in manufacturers and patterns.
- Metal Leg Color - [See Metal Leg Color Options](#)
- Optional Coordinating Wood Grain Laminate Available on Main Horizontal Surface - no upcharge. Finishes with an asterick have a coordinating laminate available.
- Optional Rubber Cushion Nylon Glides - no upcharge
- Product Options

Specifications


- Wood species - Cherry, Maple, Walnut or Double Cut.
- Seating has synthetic sheet webbing with cross strap reinforcement, 4¼" high density polyurethane foam.
- Plywood construction with locking tenons, glue and screws.
- Linking bracket included.
- Metal legs are 16 gauge steel tube with metal leveling glides.


Description	D	W	H	CTN WT	CU FT	Model	List Price
Power Center Under Mount	6	3 5/8	2 1/2	4	1	EC21	\$525




- mounts under platform or surface
- field installable
- one power receptacle - 110 volt, one dual USB port
- 10' power cord with molded plug
- specify Black (B) or White (W) finish

Description	D	W	H	CTN WT	CU FT	① Model	List Price
-------------	---	---	---	-----------	----------	---------	------------

 <p>Mini Power and Data Tilt Up</p> <ul style="list-style-type: none"> fluid one touch tilt up access one power receptacle - 120 volt; 15 amp and one opening for voice/data port adapter kit provided to accept jack from most manufacturers 72" power cord with molded plug drop in field installation required UL listed component available in Silver finish cut out provided in Media Activity Center at specified location 	4 ¼	5 ½		6	1	EC10	\$382
--	-----	-----	--	---	---	-------------	--------------

 <p>Mini Power Tilt Up</p> <ul style="list-style-type: none"> fluid one touch tilt up access two power receptacles - 120 volt; 15 amp 72" power cord with molded plug drop in field installation required UL listed component available in Silver finish cut out provided in Media Activity Center at specified location 	4 ¼	5 ½		6	1	EC11	\$397
---	-----	-----	--	---	---	-------------	--------------

 <p>Mini Power and USB Tilt Up</p> <ul style="list-style-type: none"> fluid one touch tilt up access one power receptacle - 120 volt; 15 amp dual powered USB 72" power cord with molded plug drop in field installation required UL listed component available in Silver finish cut out provided in Media Activity Center at specified location 	4 ¼	5 ½		6	1	EC12	\$428
---	-----	-----	--	---	---	-------------	--------------

To Order, Specify:

① Model Number

CONNECT

Encore Lounge Order Check List:



Specify:

- 1. Model Number
- 2. Wood Species - Maple (M)
- 3. Wood Finish
- 4. Fabric Selection - vendor, pattern and color
- 5. Leg Style - disk or column
- 6. Leg/Trim Color - Black Sandtex (BSX) or Stardust Silver (STS)
- 7. Optional Easy Mobility Package - add \$165 list per chair; available on any single seat, non-wedge lounge

Example:

EN9201UW (model #)	M (wood species)	HRV (finish)	MOMENTUM (fabric vendor)	VOX (pattern name)	MYSTIC (pattern color)	COLUMN (leg style)	BLACK SANDTEX (leg color)
------------------------------	----------------------------	------------------------	------------------------------------	------------------------------	----------------------------------	------------------------------	-------------------------------------

1. Model Number

- Model numbers of items for fabric application
- Special application instructions (e.g., all stripes will be front to back unless specified otherwise)
- Customer and purchase order number

2. Wood Species - Maple (M)

3. Wood Finish Options:

ALM	Ale Medium	HRV	Harvest *
BBM	Bourbon Medium	MCH	Mocha
BRM	Brighton Medium	PRL	Praline *
BUT	Butterscotch	SIE	Sienna
CLA	Classic	TRF	Truffle
CLL	Collectors *	UMB	Umber *
ESP	Espresso	VEN	Venetian
FLX	Flax		

*finishes have coordinating laminate top option

**4. Fabric Selection - Please supply the following:
Fabric vendor/Pattern name/Pattern color**

For a complete list of JSI Standard and Graded-In Textiles click [here](#)

When specifying contrasting upholstery, indicate clearly which upholstery is to be applied to the seat, back and arms. Use higher grade pricing.

- Indicate direction of fabric - Railroaded or Up the Roll
- Please provide illustration, if available

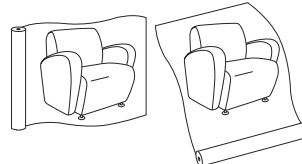
All COM orders must include the following:

- Vendor's name, pattern name and color
- Sample of the fabric attached to order

Ship prepaid COM material to:
JSI

Attn: COM Department
201 East Martin Street
Receiving B, Dock 71
Orleans, IN 47452

Application of fabric:
Railroaded Up the Roll



All COM orders will ship at standard lead time from receipt of COM except for orders requiring special custom matched finishes.

5. Leg Style Options:

Lounge Leg Style



Lounge Disk Leg
 · adjustable height glide
 · nylon glide



Lounge Column Leg
 · fixed height
 · nylon glide



Lounge Caster

Table Leg Style



Table Disk Leg
 · adjustable height glide
 · nylon glide



Lounge Column Leg
 · fixed height
 · nylon glide


6. Leg/Trim Color - Black Sandtex (BSX) or Stardust Silver (STS); all metal/trim color will match




7. Easy Mobility Package Option - add \$165 list per chair





· available on any single seat, non-wedge lounge
 · front casters, back legs for easy mobility
 · handle attached on back


8. Optional Coordinating Wood Grain Laminate Available on Wood Cap Arms, Tablet Arm and Table Tops - no upcharge.

Description	① Model	Specifications	List Price Per Grade																
Single Seat 	EN9201U · optional easy mobility package - add \$165 list per chair · optional tablet available on right or left arm (as seated in unit); specify when ordering and add \$451 list	<table border="1"> <thead> <tr> <th>Dimensions</th> <th>D</th> <th>W</th> <th>H</th> </tr> </thead> <tbody> <tr> <td>Overall</td> <td>29</td> <td>35 ½</td> <td>32</td> </tr> <tr> <td>Seat</td> <td>20 ½</td> <td>23 ½</td> <td>18</td> </tr> <tr> <td>Arm</td> <td></td> <td></td> <td>26</td> </tr> </tbody> </table>	Dimensions	D	W	H	Overall	29	35 ½	32	Seat	20 ½	23 ½	18	Arm			26	COM \$2,721 A \$2,799 B \$2,957 COL/C \$3,232 D \$3,586 E \$3,938 F \$4,311 G \$4,839 H \$5,404 I \$6,286 J \$7,346 L1 \$5,229 L2 \$5,864
		Dimensions	D	W	H														
Overall	29	35 ½	32																
Seat	20 ½	23 ½	18																
Arm			26																
<table border="1"> <thead> <tr> <th>Upholstery</th> <th colspan="3">Shipping</th> </tr> </thead> <tbody> <tr> <td>COM Ydg</td> <td>6</td> <td>Ctn Wt</td> <td>80</td> </tr> <tr> <td>COL Sq Ft</td> <td>120</td> <td>Cu Ft</td> <td>21</td> </tr> </tbody> </table>	Upholstery	Shipping			COM Ydg	6	Ctn Wt	80	COL Sq Ft	120	Cu Ft	21							
Upholstery	Shipping																		
COM Ydg	6	Ctn Wt	80																
COL Sq Ft	120	Cu Ft	21																

Description	① Model	Specifications	List Price Per Grade																
Single Seat with Folding Tablet Arm  <p>tablet on right arm</p>  <p>tablet arm stowed</p>  <p>easy mobility package</p>	EN9251 · tablet arm: 19 ¼" x 10 ¾" · ¾" thick tablet features beveled edge · tablet height: 27" · rotating tablet with tilt and stow mechanism · clearance for tablet operations is 10" · includes easy mobility package · tablet available on right or left arm (as seated in unit); specify when ordering	<table border="1"> <thead> <tr> <th>Dimensions</th> <th>D</th> <th>W</th> <th>H</th> </tr> </thead> <tbody> <tr> <td>Overall</td> <td>29</td> <td>36 ½</td> <td>32</td> </tr> <tr> <td>Seat</td> <td>20 ½</td> <td>23 ½</td> <td>18</td> </tr> <tr> <td>Arm</td> <td></td> <td></td> <td>26</td> </tr> </tbody> </table>	Dimensions	D	W	H	Overall	29	36 ½	32	Seat	20 ½	23 ½	18	Arm			26	COM \$3,191 A \$3,273 B \$3,438 COL/C \$3,724 D \$4,092 E \$4,458 F \$4,848 G \$5,401 H \$5,987 I \$6,907 J \$8,010 L1 \$5,805 L2 \$6,464
		Dimensions	D	W	H														
Overall	29	36 ½	32																
Seat	20 ½	23 ½	18																
Arm			26																
<table border="1"> <thead> <tr> <th>Upholstery</th> <th colspan="3">Shipping</th> </tr> </thead> <tbody> <tr> <td>COM Ydg</td> <td>6 ¼</td> <td>Ctn Wt</td> <td>85</td> </tr> <tr> <td>COL Sq Ft</td> <td>125</td> <td>Cu Ft</td> <td>21</td> </tr> </tbody> </table>	Upholstery	Shipping			COM Ydg	6 ¼	Ctn Wt	85	COL Sq Ft	125	Cu Ft	21							
Upholstery	Shipping																		
COM Ydg	6 ¼	Ctn Wt	85																
COL Sq Ft	125	Cu Ft	21																

Description	① Model	Specifications	List Price Per Grade																
Single Seat with Wood Cap Arm 	EN9201UW · metal spacers will match leg color · optional easy mobility package - add \$165 list per chair	<table border="1"> <thead> <tr> <th>Dimensions</th> <th>D</th> <th>W</th> <th>H</th> </tr> </thead> <tbody> <tr> <td>Overall</td> <td>30</td> <td>36 ½</td> <td>32</td> </tr> <tr> <td>Seat</td> <td>20 ½</td> <td>23 ½</td> <td>18</td> </tr> <tr> <td>Arm</td> <td></td> <td></td> <td>24 ½</td> </tr> </tbody> </table>	Dimensions	D	W	H	Overall	30	36 ½	32	Seat	20 ½	23 ½	18	Arm			24 ½	COM \$2,909 A \$2,989 B \$3,147 COL/C \$3,421 D \$3,776 E \$4,128 F \$4,500 G \$5,029 H \$5,593 I \$6,475 J \$7,536 L1 \$5,416 L2 \$6,053
		Dimensions	D	W	H														
Overall	30	36 ½	32																
Seat	20 ½	23 ½	18																
Arm			24 ½																
<table border="1"> <thead> <tr> <th>Upholstery</th> <th colspan="3">Shipping</th> </tr> </thead> <tbody> <tr> <td>COM Ydg</td> <td>6</td> <td>Ctn Wt</td> <td>80</td> </tr> <tr> <td>COL Sq Ft</td> <td>120</td> <td>Cu Ft</td> <td>21</td> </tr> </tbody> </table>	Upholstery	Shipping			COM Ydg	6	Ctn Wt	80	COL Sq Ft	120	Cu Ft	21							
Upholstery	Shipping																		
COM Ydg	6	Ctn Wt	80																
COL Sq Ft	120	Cu Ft	21																

Description	Model	Specifications				List Price Per Grade	
		Dimensions	D	W	H	COM	
Single Seat with Open Wood Cap Arm 	EN9201W · metal arm support will match leg color · optional easy mobility package - add \$165 list per chair	Overall	30	36½	32	COM	\$2,167
		Seat	20½	23½	18	A	\$2,204
		Arm			24½	B	\$2,285
		Upholstery		Shipping		COL/C	\$2,423
		COM Ydg	3	Ctn Wt	64	D	\$2,600
		COL Sq Ft	60	Cu Ft	21	E	\$2,775
						F	\$2,960
						G	\$3,227
						H	\$3,507
						I	\$3,951
						J	\$4,481
						L1	\$3,422
						L2	\$3,741

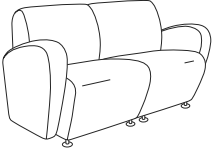
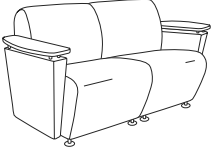
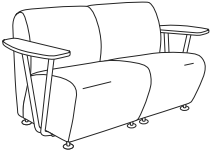
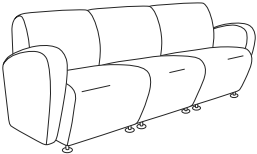
Single Seat	Model	Specifications				List Price Per Grade	
		Dimensions	D	W	H	COM	
	EN9201T-R EN9201T-L · 360° swivel tablet arm · optional tilt-out power available; specify right or left (as seated in unit); see page EN19 for more details · tablet features flat edge · metal tablet arm will match leg color · optional easy mobility package - add \$165 list per chair	Overall	29	30½	32	COM	\$1,730
		Seat	20½	23½	18	A	\$1,768
		Arm			24½	B	\$1,848
		Upholstery		Shipping		COL/C	\$1,985
		COM Ydg	3	Ctn Wt	55	D	\$2,163
		COL Sq Ft	60	Cu Ft	18	E	\$2,337
						F	\$2,525
						G	\$2,791
						H	\$3,071
						I	\$3,512
						J	\$4,043
						L1	\$2,985
						L2	\$3,302

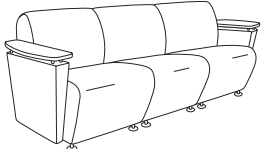
To Order, Specify:

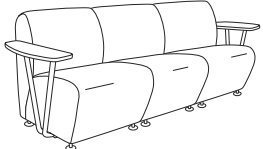
- 1 Model Number
- 2 Wood Species - Maple (M)
- 3 Wood Finish [See Wood Finish Options](#)
- 4 Fabric Selection - vendor, pattern and color
Visit www.jsifurniture.com/finishes-and-materials/textiles for our textiles program.
See selection of standard and graded in manufacturers and patterns.
- 5 Leg Style and Color
- 6 Metal Color - Black Sandtex (BSX) or Stardust Silver (STS)
- 7 Optional Easy Mobility Package - add \$165 list per chair; available on any single seat, non-wedge lounge. Optional Coordinating Wood Grain Laminate Available on Wood Cap Arms and Tablet Arm - no upcharge. Finishes with an asterisk have a coordinating laminate available.

Specifications

- Wood species - Maple.
- Seat has 8½" high density polyurethane foam.
- Back has 7½" high density polyurethane foam.
- Upholstered arms have 4½" high density polyurethane foam.
- Wood caps and tablet are ¾" thick
- Plywood construction with spiral grooved solid wood dowels, glue and screws.
- Some assembly required.
- Standard with nylon glides.

Description	① Model	Specifications			List Price Per Grade
Two Seat 	EN9202U · optional tablet available on right or left arm (as seated in unit); specify when ordering and add \$451 list	Dimensions			COM \$4,228 A \$4,345 B \$4,581 COL/C \$4,992 D \$5,521 E \$6,052 F \$6,610 G \$7,405 H \$8,252 I \$9,575 J \$11,165 L1 \$7,989 L2 \$8,942
		Overall	29	59 ¼	
		Seat	20 ½	47 ¼	18
		Arm			26
		Upholstery		Shipping	
		COM Ydg	9	Ctn Wt	130
		COL Sq Ft	180	Cu Ft	35
Two Seat with Wood Cap Arm 	EN9202UW · metal spacers will match leg color	Dimensions			COM \$4,418 A \$4,536 B \$4,773 COL/C \$5,184 D \$5,712 E \$6,243 F \$6,802 G \$7,595 H \$8,445 I \$9,767 J \$11,356 L1 \$8,178 L2 \$9,131
		Overall	30	60 ¼	
		Seat	20 ½	47 ¼	18
		Arm			24 ½
		Upholstery		Shipping	
		COM Ydg	9	Ctn Wt	130
		COL Sq Ft	180	Cu Ft	35
Two Seat with Open Wood Cap Arm 	EN9202W · metal arm support will match leg color	Dimensions			COM \$3,683 A \$3,757 B \$3,916 COL/C \$4,191 D \$4,544 E \$4,898 F \$5,270 G \$5,800 H \$6,363 I \$7,249 J \$8,307 L1 \$6,190 L2 \$6,824
		Overall	30	60 ¼	
		Seat	20 ½	47 ¼	18
		Arm			24 ½
		Upholstery		Shipping	
		COM Ydg	6	Ctn Wt	114
		COL Sq Ft	120	Cu Ft	35
Three Seat 	EN9203U · optional tablet available on right or left arm (as seated in unit); specify when ordering and add \$451 list	Dimensions			COM \$5,741 A \$5,899 B \$6,212 COL/C \$6,760 D \$7,468 E \$8,175 F \$8,917 G \$9,978 H \$11,106 I \$12,873 J \$14,992 L1 \$10,757 L2 \$12,025
		Overall	29	83	
		Seat	20 ½	70 ¾	18
		Arm			26
		Upholstery		Shipping	
		COM Ydg	12	Ctn Wt	180
		COL Sq Ft	240	Cu Ft	49

Description	① Model	Specifications				List Price Per Grade	
Three Seat with Wood Cap Arm 	EN9203UW · metal spacers will match leg color	Dimensions		D	W	H	COM \$5,930
		Overall	30	84	32	A	\$6,088
		Seat	20 ½	70 ¾	18	B	\$6,402
		Arm			24 ½	COL/C	\$6,950
		Upholstery		Shipping		D	\$7,658
		COM Ydg	12	Ctn Wt	180	E	\$8,365
		COL Sq Ft	240	Cu Ft	49	F	\$9,108
						G	\$10,168
						H	\$11,297
						I	\$13,062
				J	\$15,182		
				L1	\$10,947		
				L2	\$12,216		

Description	① Model	Specifications				List Price Per Grade	
Three Seat with Open Wood Cap Arm 	EN9203W · metal arm support will match leg color	Dimensions		D	W	H	COM \$5,187
		Overall	30	84	32	A	\$5,304
		Seat	20 ½	70 ¾	18	B	\$5,542
		Arm			24 ½	COL/C	\$5,954
		Upholstery		Shipping		D	\$6,485
		COM Ydg	9	Ctn Wt	164	E	\$7,012
		COL Sq Ft	180	Cu Ft	49	F	\$7,573
						G	\$8,366
						H	\$9,212
						I	\$10,538
				J	\$12,125		
				L1	\$8,949		
				L2	\$9,903		

To Order, Specify:

- ① Model Number
- ② Wood Species - Maple (M)
- ③ Wood Finish [See Wood Finish Options](#)
- ④ Fabric Selection - vendor, pattern and color
Visit www.jsifurniture.com/finishes-and-materials/textiles for our textiles program.
See selection of standard and graded in manufacturers and patterns.
- ⑤ Leg Style and Color
- ⑥ Metal Color - Black Sandtex (BSX) or Stardust Silver (STS)
- ⑦ Optional Coordinating Wood Grain Laminate Available on Wood Cap Arms and Tablet Arm - no upcharge. Finishes with an asterisk have a coordinating laminate available.

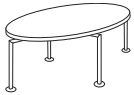
Specifications

- Wood species - Maple.
- Seat has 8 ½" high density polyurethane foam.
- Back has 7 ½" high density polyurethane foam.
- Upholstered arms have 4 ½" high density polyurethane foam.
- Wood caps and tablet are ¾" thick
- Plywood construction with spiral grooved solid wood dowels, glue and screws.
- Some assembly required.
- Standard with nylon glides.

Encore Freestanding Tables



Description	D	W	H	CTN WT	CU FT	① Model	List Price
Oval Magazine Table	21 ½	42 ½	17	25	3	EN2142	\$1,536



Round Magazine Table	36 ½	36 ½	17	28	4	EN36R	\$1,426
	30 ½	30 ½	17	25	3	EN30R	\$1,386



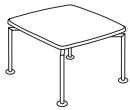
Rectangular Magazine Table	24 ½	48 ½	17	30	4	EN2448	\$1,342
----------------------------	------	------	----	----	---	--------	---------



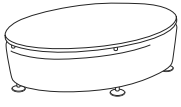
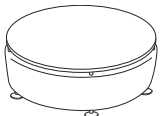
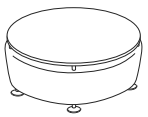
Square End Table	30 ¾	30 ¾	22 ¼	25	3	EN3030-22	\$1,300
	24 ¾	24 ¾	22 ¼	20	3	EN2424-22	\$1,129



Square Magazine Table	30 ¾	30 ¾	17	25	3	EN3030-17	\$1,268
	24 ¾	24 ¾	17	20	3	EN2424-17	\$1,102



ENCORE

Description	① Model	Specifications				List Price Per Grade	
Oval Magazine Table 	EN2142B · upholstered base · metal spacers will match leg color	Dimensions		D	W	H	COM \$1,831
		Overall		21 ½	42 ½	17	A \$1,855
		Upholstery		Shipping			B \$1,899
		COM Ydg	1 ¾	Ctn Wt	56	COL/C \$1,980	
		COL Sq Ft	35	Cu Ft	10	D \$2,084	
				E \$2,186			
				F \$2,295			
				G \$2,447			
				H \$2,614			
				I \$2,872			
				J \$3,180			
				L1 \$2,560			
				L2 \$2,745			
Round Magazine Table 	EN36RB · upholstered base · metal spacers will match leg color	Dimensions		D	W	H	COM \$1,733
		Overall		36 ½	36 ½	17	A \$1,775
		Upholstery		Shipping			B \$1,853
		COM Ydg	3	Ctn Wt	75	COL/C \$1,989	
		COL Sq Ft	60	Cu Ft	14	D \$2,167	
				E \$2,341			
				F \$2,529			
				G \$2,795			
				H \$3,076			
				I \$3,521			
				J \$4,046			
				L1 \$2,989			
				L2 \$3,307			
Round Magazine Table 	EN30RB · upholstered base · metal spacers will match leg color	Dimensions		D	W	H	COM \$1,695
		Overall		30 ½	30 ½	17	A \$1,725
		Upholstery		Shipping			B \$1,776
		COM Ydg	2	Ctn Wt	58	COL/C \$1,867	
		COL Sq Ft	40	Cu Ft	11	D \$1,985	
				E \$2,103			
				F \$2,229			
				G \$2,402			
				H \$2,590			
				I \$2,887			
				J \$3,238			
				L1 \$2,532			
				L2 \$2,743			

To Order, Specify:

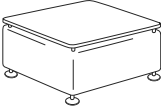
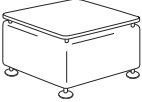
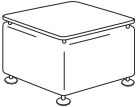
- ① Model Number
- ② Wood Species - Maple (M)
- ③ Wood Finish [See Wood Finish Options](#)
- ④ Fabric Selection - vendor, pattern and color
 Visit www.jsifurniture.com/finishes-and-materials/textiles for our textiles program.
 See selection of standard and graded in manufacturers and patterns.
- ⑤ Leg Style and Color
- ⑥ Metal Color - Black Sandtex (BSX) or Stardust Silver (STS)
- ⑦ Optional Coordinating Wood Grain Laminate Available on Table top - no up-charge. Finishes with an asterisk have a coordinating laminate available.

Specifications

- Wood species - Maple.
- Table tops are ¾" thick.
- Upholstered bases have 4 ½" high density polyurethane foam.
- Plywood construction with spiral grooved solid wood dowels, glue and screws.
- Tables ship KD; some assembly required.
- Standard with nylon glides.

Encore Freestanding Tables




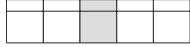

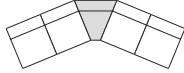

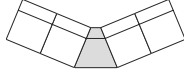
Description	① Model	Specifications	List Price Per Grade								
Square Magazine Table 	EN3030-17B · upholstered base · metal spacers will match leg color	<table border="1"> <thead> <tr> <th>Dimensions</th> <th>D</th> <th>W</th> <th>H</th> </tr> </thead> <tbody> <tr> <td>Overall</td> <td>30 ¾</td> <td>30 ¾</td> <td>17</td> </tr> </tbody> </table>	Dimensions	D	W	H	Overall	30 ¾	30 ¾	17	COM \$1,579 A \$1,621 B \$1,700 COL/C \$1,835 D \$2,014 E \$2,190 F \$2,375 G \$2,642 H \$2,923 I \$3,365 J \$3,897 L1 \$2,837 L2 \$3,153
		Dimensions	D	W	H						
		Overall	30 ¾	30 ¾	17						
		<table border="1"> <thead> <tr> <th>Upholstery</th> <th>Shipping</th> </tr> </thead> <tbody> <tr> <td>COM Ydg</td> <td>3 Ctn Wt 78</td> </tr> <tr> <td>COL Sq Ft</td> <td>60 Cu Ft 11</td> </tr> </tbody> </table>	Upholstery	Shipping	COM Ydg	3 Ctn Wt 78	COL Sq Ft	60 Cu Ft 11			
		Upholstery	Shipping								
COM Ydg	3 Ctn Wt 78										
COL Sq Ft	60 Cu Ft 11										
Square Magazine Table 	EN2424-17B · upholstered base · metal spacers will match leg color	<table border="1"> <thead> <tr> <th>Dimensions</th> <th>D</th> <th>W</th> <th>H</th> </tr> </thead> <tbody> <tr> <td>Overall</td> <td>24 ¾</td> <td>24 ¾</td> <td>17</td> </tr> </tbody> </table>	Dimensions	D	W	H	Overall	24 ¾	24 ¾	17	COM \$1,442 A \$1,469 B \$1,521 COL/C \$1,613 D \$1,731 E \$1,848 F \$1,974 G \$2,147 H \$2,334 I \$2,631 J \$2,985 L1 \$2,278 L2 \$2,490
		Dimensions	D	W	H						
		Overall	24 ¾	24 ¾	17						
		<table border="1"> <thead> <tr> <th>Upholstery</th> <th>Shipping</th> </tr> </thead> <tbody> <tr> <td>COM Ydg</td> <td>2 Ctn Wt 58</td> </tr> <tr> <td>COL Sq Ft</td> <td>40 Cu Ft 8</td> </tr> </tbody> </table>	Upholstery	Shipping	COM Ydg	2 Ctn Wt 58	COL Sq Ft	40 Cu Ft 8			
		Upholstery	Shipping								
COM Ydg	2 Ctn Wt 58										
COL Sq Ft	40 Cu Ft 8										
Square End Table 	EN2424-22B · upholstered base · metal spacers will match leg color	<table border="1"> <thead> <tr> <th>Dimensions</th> <th>D</th> <th>W</th> <th>H</th> </tr> </thead> <tbody> <tr> <td>Overall</td> <td>24 ¾</td> <td>24 ¾</td> <td>22</td> </tr> </tbody> </table>	Dimensions	D	W	H	Overall	24 ¾	24 ¾	22	COM \$1,449 A \$1,479 B \$1,535 COL/C \$1,631 D \$1,755 E \$1,879 F \$2,014 G \$2,200 H \$2,401 I \$2,713 J \$3,087 L1 \$2,337 L2 \$2,562
		Dimensions	D	W	H						
		Overall	24 ¾	24 ¾	22						
		<table border="1"> <thead> <tr> <th>Upholstery</th> <th>Shipping</th> </tr> </thead> <tbody> <tr> <td>COM Ydg</td> <td>2 ½ Ctn Wt 65</td> </tr> <tr> <td>COL Sq Ft</td> <td>43 Cu Ft 10</td> </tr> </tbody> </table>	Upholstery	Shipping	COM Ydg	2 ½ Ctn Wt 65	COL Sq Ft	43 Cu Ft 10			
		Upholstery	Shipping								
COM Ydg	2 ½ Ctn Wt 65										
COL Sq Ft	43 Cu Ft 10										

To Order, Specify:

- ① Model Number
- ② Wood Species - Maple (M)
- ③ Wood Finish [See Wood Finish Options](#)
- ④ Fabric Selection - vendor, pattern and color
 Visit www.jsifurniture.com/finishes-and-materials/textiles for our textiles program.
 See selection of standard and graded in manufacturers and patterns.
- ⑤ Leg Style and Color
- ⑥ Metal Color - Black Sandtex (BSX) or Stardust Silver (STS)
- ⑦ Optional Coordinating Wood Grain Laminate Available on Table top - no up-charge. Finishes with an asterisk have a coordinating laminate available.

Specifications

- Wood species - Maple veneer.
- Table tops are ¾" thick.
- Upholstered bases have 4 ½" high density polyurethane foam.
- Plywood construction with spiral grooved solid wood dowels, glue and screws.
- Tables ship KD; some assembly required.
- Standard with nylon glides.


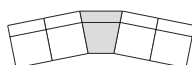
Description	① Model	Specifications	List Price Per Grade																										
Armless Lounge   Front	EN9210 <ul style="list-style-type: none"> optional tilt-out power available; specify right or left (as seated in unit); see page EN19 for more details optional easy mobility package - add \$165 list optional rotating tablet arm - see page EN16; specify right (EN9230T-R) or left (EN9230T-L) 	<table border="1"> <thead> <tr> <th>Dimensions</th> <th>D</th> <th>W</th> <th>H</th> </tr> </thead> <tbody> <tr> <td>Overall</td> <td>29</td> <td>23½</td> <td>32</td> </tr> <tr> <td>Seat</td> <td>20½</td> <td>23½</td> <td>18</td> </tr> </tbody> </table>	Dimensions	D	W	H	Overall	29	23½	32	Seat	20½	23½	18	<table border="1"> <thead> <tr> <th>Upholstery</th> <th>Shipping</th> </tr> </thead> <tbody> <tr> <td>COM Ydg</td> <td>3 Ctn Wt 50</td> </tr> <tr> <td>COL Sq Ft</td> <td>60 Cu Ft 14</td> </tr> </tbody> </table>	Upholstery	Shipping	COM Ydg	3 Ctn Wt 50	COL Sq Ft	60 Cu Ft 14								
		Dimensions	D	W	H																								
Overall	29	23½	32																										
Seat	20½	23½	18																										
Upholstery	Shipping																												
COM Ydg	3 Ctn Wt 50																												
COL Sq Ft	60 Cu Ft 14																												
			<table border="1"> <tbody> <tr><td>COM</td><td>\$1,522</td></tr> <tr><td>A</td><td>\$1,564</td></tr> <tr><td>B</td><td>\$1,641</td></tr> <tr><td>COL/C</td><td>\$1,780</td></tr> <tr><td>D</td><td>\$1,953</td></tr> <tr><td>E</td><td>\$2,131</td></tr> <tr><td>F</td><td>\$2,319</td></tr> <tr><td>G</td><td>\$2,582</td></tr> <tr><td>H</td><td>\$2,864</td></tr> <tr><td>I</td><td>\$3,307</td></tr> <tr><td>J</td><td>\$3,835</td></tr> <tr><td>L1</td><td>\$2,777</td></tr> <tr><td>L2</td><td>\$3,096</td></tr> </tbody> </table>	COM	\$1,522	A	\$1,564	B	\$1,641	COL/C	\$1,780	D	\$1,953	E	\$2,131	F	\$2,319	G	\$2,582	H	\$2,864	I	\$3,307	J	\$3,835	L1	\$2,777	L2	\$3,096
COM	\$1,522																												
A	\$1,564																												
B	\$1,641																												
COL/C	\$1,780																												
D	\$1,953																												
E	\$2,131																												
F	\$2,319																												
G	\$2,582																												
H	\$2,864																												
I	\$3,307																												
J	\$3,835																												
L1	\$2,777																												
L2	\$3,096																												
45° Armless Lounge   Front	EN9211 <ul style="list-style-type: none"> 45° inside angle seat two units joined - 90° unit casters not recommended tilt-out power not available 	<table border="1"> <thead> <tr> <th>Dimensions</th> <th>D</th> <th>W</th> <th>H</th> </tr> </thead> <tbody> <tr> <td>Overall</td> <td>29</td> <td>26½</td> <td>32</td> </tr> <tr> <td>Seat</td> <td>20½</td> <td>23½</td> <td>18</td> </tr> </tbody> </table>	Dimensions	D	W	H	Overall	29	26½	32	Seat	20½	23½	18	<table border="1"> <thead> <tr> <th>Upholstery</th> <th>Shipping</th> </tr> </thead> <tbody> <tr> <td>COM Ydg</td> <td>3¼ Ctn Wt 44</td> </tr> <tr> <td>COL Sq Ft</td> <td>65 Cu Ft 14</td> </tr> </tbody> </table>	Upholstery	Shipping	COM Ydg	3¼ Ctn Wt 44	COL Sq Ft	65 Cu Ft 14								
		Dimensions	D	W	H																								
Overall	29	26½	32																										
Seat	20½	23½	18																										
Upholstery	Shipping																												
COM Ydg	3¼ Ctn Wt 44																												
COL Sq Ft	65 Cu Ft 14																												
			<table border="1"> <tbody> <tr><td>COM</td><td>\$1,453</td></tr> <tr><td>A</td><td>\$1,498</td></tr> <tr><td>B</td><td>\$1,580</td></tr> <tr><td>COL/C</td><td>\$1,731</td></tr> <tr><td>D</td><td>\$1,921</td></tr> <tr><td>E</td><td>\$2,114</td></tr> <tr><td>F</td><td>\$2,318</td></tr> <tr><td>G</td><td>\$2,604</td></tr> <tr><td>H</td><td>\$2,908</td></tr> <tr><td>I</td><td>\$3,387</td></tr> <tr><td>J</td><td>\$3,962</td></tr> <tr><td>L1</td><td>\$2,813</td></tr> <tr><td>L2</td><td>\$3,155</td></tr> </tbody> </table>	COM	\$1,453	A	\$1,498	B	\$1,580	COL/C	\$1,731	D	\$1,921	E	\$2,114	F	\$2,318	G	\$2,604	H	\$2,908	I	\$3,387	J	\$3,962	L1	\$2,813	L2	\$3,155
COM	\$1,453																												
A	\$1,498																												
B	\$1,580																												
COL/C	\$1,731																												
D	\$1,921																												
E	\$2,114																												
F	\$2,318																												
G	\$2,604																												
H	\$2,908																												
I	\$3,387																												
J	\$3,962																												
L1	\$2,813																												
L2	\$3,155																												
45° Armless Lounge   Front	EN9212 <ul style="list-style-type: none"> 45° outside angle seat two units joined - 90° unit casters not recommended tilt-out power not available 	<table border="1"> <thead> <tr> <th>Dimensions</th> <th>D</th> <th>W</th> <th>H</th> </tr> </thead> <tbody> <tr> <td>Overall</td> <td>29</td> <td>26½</td> <td>32</td> </tr> <tr> <td>Seat</td> <td>20½</td> <td>23½</td> <td>18</td> </tr> </tbody> </table>	Dimensions	D	W	H	Overall	29	26½	32	Seat	20½	23½	18	<table border="1"> <thead> <tr> <th>Upholstery</th> <th>Shipping</th> </tr> </thead> <tbody> <tr> <td>COM Ydg</td> <td>3¼ Ctn Wt 44</td> </tr> <tr> <td>COL Sq Ft</td> <td>65 Cu Ft 14</td> </tr> </tbody> </table>	Upholstery	Shipping	COM Ydg	3¼ Ctn Wt 44	COL Sq Ft	65 Cu Ft 14								
		Dimensions	D	W	H																								
Overall	29	26½	32																										
Seat	20½	23½	18																										
Upholstery	Shipping																												
COM Ydg	3¼ Ctn Wt 44																												
COL Sq Ft	65 Cu Ft 14																												
			<table border="1"> <tbody> <tr><td>COM</td><td>\$1,453</td></tr> <tr><td>A</td><td>\$1,498</td></tr> <tr><td>B</td><td>\$1,580</td></tr> <tr><td>COL/C</td><td>\$1,731</td></tr> <tr><td>D</td><td>\$1,921</td></tr> <tr><td>E</td><td>\$2,114</td></tr> <tr><td>F</td><td>\$2,318</td></tr> <tr><td>G</td><td>\$2,604</td></tr> <tr><td>H</td><td>\$2,908</td></tr> <tr><td>I</td><td>\$3,387</td></tr> <tr><td>J</td><td>\$3,962</td></tr> <tr><td>L1</td><td>\$2,813</td></tr> <tr><td>L2</td><td>\$3,155</td></tr> </tbody> </table>	COM	\$1,453	A	\$1,498	B	\$1,580	COL/C	\$1,731	D	\$1,921	E	\$2,114	F	\$2,318	G	\$2,604	H	\$2,908	I	\$3,387	J	\$3,962	L1	\$2,813	L2	\$3,155
COM	\$1,453																												
A	\$1,498																												
B	\$1,580																												
COL/C	\$1,731																												
D	\$1,921																												
E	\$2,114																												
F	\$2,318																												
G	\$2,604																												
H	\$2,908																												
I	\$3,387																												
J	\$3,962																												
L1	\$2,813																												
L2	\$3,155																												



To Order, Specify:

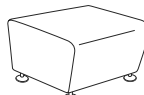
- ① Model Number
- ② Wood Species - Maple (M)
- ③ Wood Finish [See Wood Finish Options](#)
- ④ Fabric Selection - vendor, pattern and color
Visit www.jsifurniture.com/finishes-and-materials/textiles for our textiles program.
See selection of standard and graded in manufacturers and patterns.
- ⑤ Leg Style and Color
- ⑥ Metal Color - Black Sandtex (BSX) or Stardust Silver (STS)
- ⑦ Optional Easy Mobility Package - add \$165 list per chair; available on any single seat, non-wedge lounge

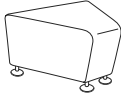
Specifications

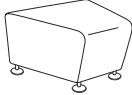
- Wood species - Maple.
- Seat has 8½" high density polyurethane foam.
- Back has 7½" high density polyurethane foam.
- Plywood construction with spiral grooved solid wood dowels, glue and screws.
- Linking bracket included.
- Some assembly required.
- Standard with nylon glides.

Description	① Model	Specifications	List Price Per Grade												
22.5° Modular Armless Lounge   Front	EN9213 · 22.5° inside angle seat · casters not recommended · tilt-out power not available	<table border="1"> <thead> <tr> <th>Dimensions</th> <th>D</th> <th>W</th> <th>H</th> </tr> </thead> <tbody> <tr> <td>Overall</td> <td>29</td> <td>26½</td> <td>32</td> </tr> <tr> <td>Seat</td> <td>20½</td> <td>23½</td> <td>18</td> </tr> </tbody> </table>	Dimensions	D	W	H	Overall	29	26½	32	Seat	20½	23½	18	COM \$1,624 A \$1,668 B \$1,752 COL/C \$1,899 D \$2,089 E \$2,282 F \$2,485 G \$2,772 H \$3,077 I \$3,556 J \$4,130 L1 \$2,984 L2 \$3,328
		Dimensions	D	W	H										
Overall	29	26½	32												
Seat	20½	23½	18												
<table border="1"> <thead> <tr> <th>Upholstery</th> <th colspan="3">Shipping</th> </tr> </thead> <tbody> <tr> <td>COM Ydg</td> <td>3¼</td> <td>Ctn Wt</td> <td>44</td> </tr> <tr> <td>COL Sq Ft</td> <td>65</td> <td>Cu Ft</td> <td>14</td> </tr> </tbody> </table>	Upholstery	Shipping			COM Ydg	3¼	Ctn Wt	44	COL Sq Ft	65	Cu Ft	14			
Upholstery	Shipping														
COM Ydg	3¼	Ctn Wt	44												
COL Sq Ft	65	Cu Ft	14												

Description	① Model	Specifications	List Price Per Grade												
22.5° Modular Armless Lounge   Front	EN9214 · 22.5° outside angle seat · casters not recommended · tilt-out power not available	<table border="1"> <thead> <tr> <th>Dimensions</th> <th>D</th> <th>W</th> <th>H</th> </tr> </thead> <tbody> <tr> <td>Overall</td> <td>29</td> <td>26½</td> <td>32</td> </tr> <tr> <td>Seat</td> <td>20½</td> <td>23½</td> <td>18</td> </tr> </tbody> </table>	Dimensions	D	W	H	Overall	29	26½	32	Seat	20½	23½	18	COM \$1,624 A \$1,668 B \$1,752 COL/C \$1,899 D \$2,089 E \$2,282 F \$2,485 G \$2,772 H \$3,077 I \$3,556 J \$4,130 L1 \$2,984 L2 \$3,328
		Dimensions	D	W	H										
Overall	29	26½	32												
Seat	20½	23½	18												
<table border="1"> <thead> <tr> <th>Upholstery</th> <th colspan="3">Shipping</th> </tr> </thead> <tbody> <tr> <td>COM Ydg</td> <td>3¼</td> <td>Ctn Wt</td> <td>44</td> </tr> <tr> <td>COL Sq Ft</td> <td>65</td> <td>Cu Ft</td> <td>14</td> </tr> </tbody> </table>	Upholstery	Shipping			COM Ydg	3¼	Ctn Wt	44	COL Sq Ft	65	Cu Ft	14			
Upholstery	Shipping														
COM Ydg	3¼	Ctn Wt	44												
COL Sq Ft	65	Cu Ft	14												

Description	① Model	Specifications	List Price Per Grade									
Bench 	EN9710 · optional tilt-out power available; specify right or left (as seated in unit); see page EN19 for more details · tilt-out power can be installed on either side of the unit, cannot be installed in the front or back · to be used for straight connections only, cannot make a 90° turn · casters are not available · optional rotating tablet arm - see page EN16 specify right (EN9230T-R) or left (EN9230T-L)	<table border="1"> <thead> <tr> <th>Dimensions</th> <th>D</th> <th>W</th> <th>H</th> </tr> </thead> <tbody> <tr> <td>Overall</td> <td>25½</td> <td>23½</td> <td>17</td> </tr> </tbody> </table>	Dimensions	D	W	H	Overall	25½	23½	17	COM \$1,034 A \$1,064 B \$1,116 COL/C \$1,205 D \$1,326 E \$1,442 F \$1,567 G \$1,740 H \$1,929 I \$2,228 J \$2,578 L1 \$1,872 L2 \$2,084	
		Dimensions	D	W	H							
Overall	25½	23½	17									
<table border="1"> <thead> <tr> <th>Upholstery</th> <th colspan="3">Shipping</th> </tr> </thead> <tbody> <tr> <td>COM Ydg</td> <td>2</td> <td>Ctn Wt</td> <td>43</td> </tr> <tr> <td>COL Sq Ft</td> <td>40</td> <td>Cu Ft</td> <td>8</td> </tr> </tbody> </table>	Upholstery	Shipping			COM Ydg	2	Ctn Wt	43	COL Sq Ft	40	Cu Ft	8
Upholstery	Shipping											
COM Ydg	2	Ctn Wt	43									
COL Sq Ft	40	Cu Ft	8									

Description	① Model	Specifications				List Price Per Grade	
45° Bench 	EN9711 · 45° angle single seat · two units joined - 90° unit · casters and tilt out power not available	Dimensions		D	W	H	COM \$995
		Overall		25½	27	17	A \$1,023
		Upholstery		Shipping			B \$1,074
		COM Ydg	2	Ctn Wt	41		COL/C \$1,164
		COL Sq Ft	40	Cu Ft	8		D \$1,285
							E \$1,401
					F \$1,525		
					G \$1,701		
					H \$1,890		
					I \$2,184		
					J \$2,538		
					L1 \$1,831		
					L2 \$2,042		



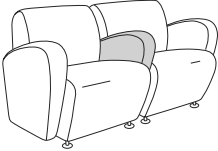


22.5° Bench 	EN9713 · 22.5° angle single seat · casters and tilt out power not available	Dimensions		D	W	H	COM \$1,111
		Overall		25½	26½	17	A \$1,139
		Upholstery		Shipping			B \$1,190
		COM Ydg	2	Ctn Wt	41		COL/C \$1,281
		COL Sq Ft	40	Cu Ft	8		D \$1,401
							E \$1,518
					F \$1,643		
					G \$1,819		
					H \$2,006		
					I \$2,302		
					J \$2,654		
					L1 \$1,947		
					L2 \$2,159		

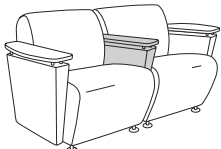
To Order, Specify:

- ① Model Number
- ② Wood Species - Maple (M)
- ③ Wood Finish [See Wood Finish Options](#)
- ④ Fabric Selection - vendor, pattern and color
 Visit www.jsifurniture.com/finishes-and-materials/textiles for our textiles program.
 See selection of standard and graded in manufacturers and patterns.
- ⑤ Leg Style and Color
- ⑥ Metal Color - Black Sandtex (BSX) or Stardust Silver (STS)

Specifications

- Wood species - Maple.
- Seat has 8½" high density polyurethane foam.
- Back has 7½" high density polyurethane foam.
- Plywood construction with spiral grooved solid wood dowels, glue and screws.
- Linking bracket included.
- Some assembly required.
- Standard with nylon glides.

Description	① Model	Specifications				List Price Per Grade	
Modular End Arm (arm only)  EN9220U-R right  EN9220U-L left	EN9220U-R EN9220U-L <ul style="list-style-type: none"> · fully upholstered · for use on right or left end (as seated in unit) · optional tablet available on right or left arm (as seated in unit); specify when ordering and add \$451 list 	Dimensions		D	W	H	COM \$612 A \$633 B \$676 COL/C \$748 D \$844 E \$939 F \$1,041 G \$1,187 H \$1,337 I \$1,575 J \$1,864 L1 \$1,290 L2 \$1,462
		Overall	23	6	25½		
		Upholstery		Shipping			
		COM Ydg	1 5/8	Ctn Wt	15		
		COL Sq Ft	33	Cu Ft	3		
Modular Center Arm (arm only) 	EN9221U-C <ul style="list-style-type: none"> · fully upholstered 	Dimensions		D	W	H	COM \$612 A \$633 B \$676 COL/C \$748 D \$844 E \$939 F \$1,041 G \$1,187 H \$1,337 I \$1,575 J \$1,864 L1 \$1,290 L2 \$1,462
		Overall	23	6	25½		
		Upholstery		Shipping			
		COM Ydg	1 5/8	Ctn Wt	15		
		COL Sq Ft	33	Cu Ft	3		
Modular End Arm (arm only)  EN9220UW-R right  EN9220UW-L left	EN9220UW-R EN9220UW-L <ul style="list-style-type: none"> · upholstered/wood arm · for use on right or left end (as seated in unit) · specify metal spacer color - Black Sandtex or Stardust Silver 	Dimensions		D	W	H	COM \$706 A \$727 B \$769 COL/C \$835 D \$924 E \$1,012 F \$1,104 G \$1,237 H \$1,378 I \$1,600 J \$1,864 L1 \$1,334 L2 \$1,494
		Overall	23	7	24½		
		Upholstery		Shipping			
		COM Ydg	1½	Ctn Wt	15		
		COL Sq Ft	30	Cu Ft	3		

Description	Model	Specifications				List Price Per Grade	
Modular Center Arm (arm only) 	EN9221UW-C · upholstered/wood · specify metal spacer color - Black Sandtex or Stardust Silver	Dimensions		D	W	H	COM \$706
		Overall		23	6	24½	A \$727
		Upholstery		Shipping			B \$769
		COM Ydg	1½	Ctn Wt	15	COL/C \$835	
		COL Sq Ft	30	Cu Ft	3	D \$924	
						E \$1,012	
				F \$1,104			
				G \$1,237			
				H \$1,378			
				I \$1,600			
				J \$1,864			
				L1 \$1,334			
				L2 \$1,494			

To Order, Specify:

- 1 Model Number
- 2 Wood Species - Maple (M)
- 3 Wood Finish See [Wood Finish Options](#)
- 4 Fabric Selection - vendor, pattern and color
Visit www.jsifurniture.com/finishes-and-materials/textiles for our textiles program.
See selection of standard and graded in manufacturers and patterns.
- 5 Leg Style and Color
- 6 Metal Color - Black Sandtex (BSX) or Stardust Silver (STS)
- 7 Optional Coordinating Wood Grain Laminate Available on Wood Cap Arms or Tablet - no upcharge. Finishes with an asterisk have a coordinating laminate available

Specifications

- Wood species - Maple.
- Upholstered arms have 4½" high density polyurethane foam.
- Wood caps and tablet are ¾" thick
- Plywood construction with spiral grooved solid wood dowels, glue and screws.
- Some assembly required.
- Linking bracket included.

Encore Modular Components



Description	D	W	H	CTN WT	CU FT	① Model	List Price
Modular End Arm (arm only)	23	7	24½	7	2	EN9220W	\$351



- wood cap metal arm
- for use on right or left end of unit while sitting
- specify metal arm color - Black Sandtex or Stardust Silver

Tablet Arm (arm only)	13	13	24½	5	2	EN9230T-R	\$366
	13	13	24½	5	2	EN9230T-L	\$366



EN9230T-R
right

- attaches to right end of lounge or bench unit while sitting
- tablet features flat edge and 360° swivel
- specify metal arm color - Black Sandtex or Stardust Silver



EN9230T-L
left

22.5° Linking Table	23 ¼	16-26	17	15	3	EN22	\$950
---------------------	------	-------	----	----	---	------	-------



- 22.5° inside/outside
- attaches between lounge or bench units
- specify metal color - Black Sandtex or Stardust Silver



Front

45° Linking Table	22	6-25	17	15	3	EN45	\$938
-------------------	----	------	----	----	---	------	-------



- 45° inside/outside
- attaches between lounge or bench units
- specify metal color - Black Sandtex or Stardust Silver



Front

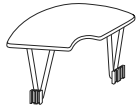
ENCORE

Description	D	W	H	CTN WT	CU FT	❶ Model	List Price
Square Linking Table	23½	25	17	20	2	EN90	\$973

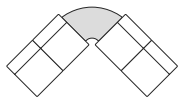


- used for straight run configurations
- attaches between lounge or bench units
- specify metal color - Black Sandtex or Stardust Silver

90° Corner Linking Table	25	46½	13½	25	4	EN90CT	\$1,220
--------------------------	----	-----	-----	----	---	--------	---------



- 90° inside/outside
- attaches between lounge or bench units
- specify metal color - Black Sandtex or Stardust Silver



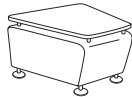
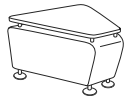

Front

To Order, Specify:

- ❶ Model Number
- ❷ Wood Species - Maple (M)
- ❸ Wood Finish [See Wood Finish Options](#)
- ❹ Leg Style and Color
- ❺ Metal Color - Black Sandtex (BSX) or Stardust Silver (STS)
- ❻ Optional Coordinating Wood Grain Laminate Available on wood cap arms or tablet - no upcharge. Finishes with an asterisk have a coordinating laminate available

Specifications

- Wood species - Maple.
- Wood caps and tablet are ¾" thick.
- Plywood construction with spiral grooved solid wood dowels, glue and screws.
- Some assembly required.
- Linking bracket included.
- Standard with nylon glides.

Description	① Model	Specifications				List Price Per Grade
		Dimensions	D	W	H	
22.5° Linking Table 	EN22B · 22.5° upholstered linking table · attaches to lounge or bench units · metal spacers will match leg color · overall width range is 16½ - 26½	Overall	27	26½	16	COM \$1,220
		Upholstery		Shipping		A \$1,241
		COM Ydg	1 5/8	Ctn Wt	46	B \$1,285
		COL Sq Ft	33	Cu Ft	8	COL/C \$1,356
						D \$1,452
						E \$1,548
						F \$1,650
						G \$1,794
						H \$1,946
						I \$2,186
						J \$2,473
						L1 \$1,898
						L2 \$2,070
45° Linking Table 	EN45B · 45° upholstered linking table · attaches to lounge or bench units · metal spacers will match leg color · overall width range is 10½ - 26½	Overall	25½	26½	16	COM \$1,185
		Upholstery		Shipping		A \$1,205
		COM Ydg	1 5/8	Ctn Wt	46	B \$1,248
		COL Sq Ft	33	Cu Ft	8	COL/C \$1,325
						D \$1,418
						E \$1,516
						F \$1,615
						G \$1,759
						H \$1,913
						I \$2,151
						J \$2,438
						L1 \$1,864
						L2 \$2,035
Square Linking Table 	EN90B · used for straight run configurations · upholstered square linking table · attaches to lounge or bench units · metal spacers will match leg color	Overall	25½	23½	16	COM \$1,276
		Upholstery		Shipping		A \$1,296
		COM Ydg	1 5/8	Ctn Wt	46	B \$1,341
		COL Sq Ft	33	Cu Ft	8	COL/C \$1,414
						D \$1,510
						E \$1,606
						F \$1,706
						G \$1,852
						H \$2,002
						I \$2,243
						J \$2,529
						L1 \$1,953
						L2 \$2,129

Description	D	W	H	CTN WT	CU FT	① Model	List Price
Mini Power Tilt Out	4 ¼	5 ½		6	1	EC11	\$397



- fluid one touch tilt up access
- two power receptacles - 120 volt; 15 amp
- 72" power cord with molded plug
- drop in field installation required
- located in side panel of Encore Lounge or Bench units without arms (indicate right or left side panel as seated in the unit)
- UL listed component
- available in Silver finish

Mini Power and USB Tilt Up	4 ¼	5 ½		6	1	EC12	\$428
-----------------------------------	-----	-----	--	---	---	-------------	--------------



- fluid one touch tilt up access
- one power receptacle - 120 volt; 15 amp dual powered USB
- 72" power cord with molded plug
- drop in field installation required
- located in side panel of Encore Lounge or Bench units without arms (indicate right or left side panel as seated in the unit)
- UL listed component
- available in Silver finish

To Order, Specify:

- ① Model Number
- ② Wood Species - Maple (M)
- ③ Wood Finish [See Wood Finish Options](#)
- ④ Fabric Selection - vendor, pattern and color
Visit www.jsifurniture.com/finishes-and-materials/textiles for our textiles program.
See selection of standard and graded in manufacturers and patterns.
- ⑤ Leg Style and Color
- ⑥ Metal Color - Black Sandtex (BSX) or Stardust Silver (STS)
- ⑦ Optional Coordinating Wood Grain Laminate Available on Top Surface - no upcharge. Finishes with an asterisk have a coordinating laminate available

Specifications

- Wood species - Maple.
- Upholstered arms have 4 ½" high density polyurethane foam.
- Table tops are ¾" thick.
- Plywood construction with spiral grooved solid wood dowels, glue and screws.
- Some assembly required.
- Linking bracket included.
- Standard with nylon glides.

Esque Lounge Order Check List:



Specify:
 1. Model Number
 2. Wood Species - Maple (M)
 3. Wood Finish/Color
 4. Fabric Selection - vendor, pattern and color

Example:

ES1331 (model #)	M (wood species)	AUB (finish)	MOMENTUM (fabric vendor)	VOX (pattern name)	MYSTIC (pattern color)
----------------------------	----------------------------	------------------------	------------------------------------	------------------------------	----------------------------------

1. Model Number

2. Wood Species - Maple (M)

3. Wood Finish/Color Options:

ALM Ale Medium	CKC Khaki Coordinate
CAL Ale Light Coordinate	MINC Mineral Coordinate
BBM Bourbon Medium	MCH Mocha
CBZ Brazilwood Coordinate	CPI Pinnacle Walnut Coordinate
BARC Barrel Coordinate	PRL Praline
CBO Bourbon Light Coordinate	RAVC Raven Coordinate
CBG Brighton Light Coordinate	SABC Sable Coordinate
BRM Brighton Medium	SIE Sienna
BUT Butterscotch	CST Studio Teak Coordinate
CNDC Cinder Coordinate	TRF Truffle
CLA Classic	UMB Umber
CLL Collectors	VALC Valley Coordinate
EGRC Egret Coordinate	VEN Venetian
ESP Espresso	CWE Weathered Ash Coordinate
FAWC Fawn Coordinate	
FLX Flax	
CGR Graphite Coordinate	
HRV Harvest	

Color - Add \$45 list per item

BKD Backdrop	GRV Greek Villa
BFX Black Fox	GLF Gulf Stream
BWH Bright White	HTB Heartthrob
CGP Cargo Pants	NET Network Gray
CHT Chatroom	NWH Nonchalant White
DSY Daisy	PAR Paradise
DRG Daring	QXP Quixotic Plum
DYN Dynamo	RBZ Relic Bronze
ENG Enigma	SND Sandbank
FRR French Roast	STM Storm
GBY Georgian Bay	TRC Tricorn Black

4. Fabric Selection - Please supply the following:
 Fabric vendor/Pattern name/Pattern color

For a complete list of JSI Standard and Graded-In Textiles click here

When specifying contrasting upholstery, indicate clearly which upholstery is to be applied to the seat, back and arms. Use higher grade pricing.

- Indicate direction of fabric - Railroaded or Up the Roll
- Please provide illustration, if available

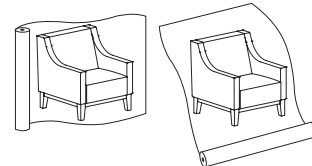
All COM orders must include the following:

- Vendor's name, pattern name and color
- Sample of the fabric attached to order
- Model numbers of items for fabric application
- Special application instructions (e.g., all stripes will be applied front to back unless specified otherwise)
- Customer and purchase order number

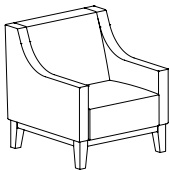
Ship prepaid COM material to:

JSI
 Attn: COM Department
 201 East Martin Street
 Receiving B, Dock 71
 Orleans, IN 47452

Application of fabric:
 Railroaded Up the Roll



All COM orders will ship at standard lead time from receipt of COM except for orders requiring special custom matched finishes.

Description	① Model	Specifications			List Price Per Grade		
Club Chair 	ES1331	Dimensions			COM	\$3,541	
			D	W	H	A	\$3,621
		Overall	32	31 ¼	34 ¼	B	\$3,776
		Seat	21 ½	24	17 ½	COL/C	\$4,047
		Arm			24	D	\$4,473
		Upholstery		Shipping		E	\$4,750
		COM Ydg	5	Ctn Wt	89	F	\$5,294
		COL Sq Ft	115	Cu Ft	23	G	\$5,875
						H	\$6,501
						I	\$7,475
				J	\$8,641		
				L1	\$6,304		
				L2	\$7,085		

To Order, Specify:

- ① Model Number
 - ② Wood Species - Maple (M)
 - ③ Wood Finish/Color [See Wood Finish/Color Options](#)
 - ④ Fabric Selection - vendor, pattern and color
- Visit www.jsifurniture.com/finishes-and-materials/textiles for our textiles program. See selection of standard and graded in manufacturers and patterns.

Specifications

- Base wood species - Maple.
- Frame interior is upholstery grade plywood with glued solid hardwood cross members reinforced with corner blocks.
- Seat has sinuous steel springs with high resiliency seat polyurethane foam with Dacron® wrap.
- Back has sinuous steel springs and polyurethane foam with dacron wrap.

Finn Lounge Order Check List:



Specify:

- 1. Model Number
- 2. Wood Species - Cherry (C), Maple (M), White Oak (WO) or Walnut (W)
- 3. Wood Finish
- 4. Fabric Selection - vendor, pattern and color
- 5. Table Tops - Glass (G) or Wood (W)
- 6. Optional Rubber Cushion Nylon Glides - no upcharge

Example:

FI2311 (model #)	C (wood species)	CLC (finish)	MOMENTUM (fabric vendor)	VOX (pattern name)	MYSTIC (pattern color)
----------------------------	----------------------------	------------------------	------------------------------------	------------------------------	----------------------------------

1. Model Number

2. Wood Species - Cherry (C), Maple (M), White Oak (WO), or Walnut (W)

3. Wood Finish Options:

- CLC Clear on Cherry
- CLM Clear on Maple
- CLK Clear on White Oak
- CLW Clear on Walnut

4. Fabric Selection - Please supply the following:
Fabric vendor/Pattern name/Pattern color

[For a complete list of JSI Standard and Graded-In Textiles click here](#)

When specifying contrasting upholstery, indicate clearly which upholstery is to be applied to the seat and back. Use higher grade pricing.

- Indicate direction of fabric - Railroaded or Up the Roll
- Please provide illustration, if available

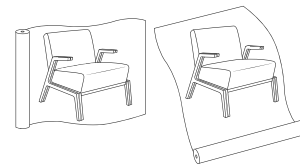
All COM orders must include the following:

- Vendor's name, pattern name and color
- Sample of the fabric attached to order
- Model numbers of items for fabric application
- Special application instructions (e.g., all stripes will be applied front to back unless specified otherwise)
- Customer and purchase order number


Ship prepaid COM material to:
JSI


Attn: COM Department
201 East Martin Street
Receiving B, Dock 71
Orleans, IN 47452

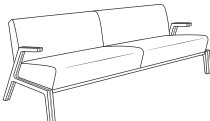
Application of fabric:
Railroaded Up the Roll



All COM orders will ship at standard lead time from receipt of COM except for orders requiring special custom matched finishes.

Description	① Model	Specifications				List Price Per Grade	
Single Seat 	FI2311 · cantilever arm	Dimensions				COM \$3,039 A \$3,068 B \$3,127 COL/C \$3,227 D \$3,359 E \$3,493 F \$3,632 G \$3,830 H \$4,039 I \$4,369 J \$4,765 L1 \$4,131 L2 \$4,409	
			D	W	H		
		Overall	30 ½	28	30 ¾		
		Seat	20 ½	24	16 ¾		
		Arm			22		
		Upholstery		Shipping			
		COM Ydg	2 ½	Ctn Wt	36		
		COL Sq Ft	58	Cu Ft	25		

Description	① Model	Specifications				List Price Per Grade	
Two Seat 	FI2312 · cantilever arm	Dimensions				COM \$3,922 A \$3,971 B \$4,065 COL/C \$4,230 D \$4,439 E \$4,650 F \$4,872 G \$5,187 H \$5,523 I \$6,052 J \$6,685 L1 \$5,675 L2 \$6,115	
			D	W	H		
		Overall	30 ½	51 ¾	30 ¾		
		Seat	20 ½	47 ¾	16 ¾		
		Arm			22		
		Upholstery		Shipping			
		COM Ydg	4	Ctn Wt	56		
		COL Sq Ft	92	Cu Ft	39		



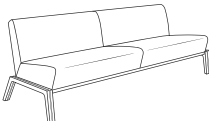
Description	① Model	Specifications				List Price Per Grade	
Three Seat 	FI2313 · cantilever arm	Dimensions				COM \$4,658 A \$4,736 B \$4,886 COL/C \$5,151 D \$5,494 E \$5,839 F \$6,199 G \$6,714 H \$7,262 I \$8,116 J \$9,146 L1 \$7,500 L2 \$8,220	
			D	W	H		
		Overall	30 ½	75 ½	30 ¾		
		Seat	20 ½	71 ½	16 ¾		
		Arm			22		
		Upholstery		Shipping			
		COM Ydg	6 ½	Ctn Wt	64		
		COL Sq Ft	150	Cu Ft	75		

To Order, Specify:



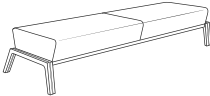
- ① Model Number
- ② Wood Species - Cherry (C), Maple (M), White Oak (WO) or Walnut (W)
- ③ Wood Finish See [Wood Finish Options](#)
- ④ Fabric Selection - vendor, pattern and color
 Visit www.jsifurniture.com/finishes-and-materials/textiles for our textiles program.
 See selection of standard and graded in manufacturers and patterns.
- ⑤ Optional Rubber Cushion Nylon Glides - no upcharge

Specifications

- Wood species - Cherry, Maple, White Oak or Walnut in clear finish.
- Seat has 3" high density polyurethane foam and synthetic sheet webbing with cross strap reinforcement.
- Back has 1 ½" high density polyurethane foam.
- Mortise and tenon construction with corner blocks, glue and screws.
- Internal aluminum core throughout the legs and arms.
- Features fixed cushions.
- Standard with rubber cushion metal glides.

Description	① Model	Specifications			List Price Per Grade	
	F12321	Dimensions			COM \$2,171	
			D	W	H	A \$2,201
		Overall	30 ½	28	30 ¾	B \$2,262
		Seat	20 ½	24	16 ¾	COL/C \$2,364
		Arm				D \$2,493
		Upholstery		Shipping		E \$2,627
		COM Ydg	2 ½	Ctn Wt	29	F \$2,764
		COL Sq Ft	58	Cu Ft	25	G \$2,963
						H \$3,174
						I \$3,503
				J \$3,898		
				L1 \$3,267		
				L2 \$3,542		
	F12322	Dimensions			COM \$3,054	
			D	W	H	A \$3,101
		Overall	30 ½	51 ¾	30 ¾	B \$3,197
		Seat	20 ½	47 ¾	16 ¾	COL/C \$3,359
		Arm				D \$3,571
		Upholstery		Shipping		E \$3,784
		COM Ydg	4	Ctn Wt	49	F \$4,005
		COL Sq Ft	92	Cu Ft	39	G \$4,322
						H \$4,658
						I \$5,184
				J \$5,818		
				L1 \$4,805		
				L2 \$5,247		
	F12323	Dimensions			COM \$3,785	
			D	W	H	A \$3,863
		Overall	30 ½	75 ½	30 ¾	B \$4,013
		Seat	20 ½	71 ½	16 ¾	COL/C \$4,279
		Arm				D \$4,621
		Upholstery		Shipping		E \$4,965
		COM Ydg	6 ½	Ctn Wt	68	F \$5,325
		COL Sq Ft	150	Cu Ft	64	G \$5,841
						H \$6,389
						I \$7,244
				J \$8,273		
				L1 \$6,627		
				L2 \$7,346		

FINN

Description	① Model	Specifications				List Price Per Grade
Single Seat Bench 	FI2331	Dimensions				COM \$1,917
			D	W	H	A \$1,935
		Overall	22 ¼	28	16 ¾	B \$1,970
		Seat	20 ½	24	16 ¾	COL/C \$2,032
		Arm				D \$2,110
		Upholstery		Shipping		E \$2,191
		COM Ydg	1 ½	Ctn Wt	22	F \$2,275
		COL Sq Ft	35	Cu Ft	13	G \$2,392
						H \$2,518
						I \$2,716
				J \$2,952		
				L1 \$2,574		
				L2 \$2,739		
Two Seat Bench 	FI2332	Dimensions				COM \$2,688
			D	W	H	A \$2,718
		Overall	22 ¼	51 ¾	16 ¾	B \$2,778
		Seat	20 ½	47 ¾	16 ¾	COL/C \$2,882
		Arm				D \$3,012
		Upholstery		Shipping		E \$3,143
		COM Ydg	2 ½	Ctn Wt	40	F \$3,283
		COL Sq Ft	58	Cu Ft	20	G \$3,481
						H \$3,693
						I \$4,022
				J \$4,417		
				L1 \$3,785		
				L2 \$4,063		
Three Seat Bench 	FI2333	Dimensions				COM \$3,354
			D	W	H	A \$3,414
		Overall	22 ¼	75 ½	16 ¾	B \$3,531
		Seat	20 ½	71 ½	16 ¾	COL/C \$3,736
		Arm				D \$3,999
		Upholstery		Shipping		E \$4,261
		COM Ydg	5	Ctn Wt	57	F \$4,539
		COL Sq Ft	115	Cu Ft	32	G \$4,936
						H \$5,357
						I \$6,015
				J \$6,805		
				L1 \$5,543		
				L2 \$6,094		

To Order, Specify:

- ① Model Number
- ② Wood Species - Cherry (C), Maple (M), White Oak (WO) or Walnut (W)
- ③ Wood Finish See [Wood Finish Options](#)
- ④ Fabric Selection - vendor, pattern and color
Visit www.jsifurniture.com/finishes-and-materials/textiles for our textiles program.
See selection of standard and graded in manufacturers and patterns.
- ⑤ Optional Rubber Cushion Nylon Glides - no upcharge

Specifications

- Wood species - Cherry, Maple, White Oak or Walnut in clear finish.
- Seat has 3" high density polyurethane foam and synthetic sheet webbing with cross strap reinforcement.
- Back has 1 ½" high density polyurethane foam.
- Mortise and tenon construction with corner blocks, glue and screws.
- Internal aluminum core throughout the legs and arms.
- Features fixed cushions.
- Standard with rubber cushion metal glides.

Description	D	W	H	CTN WT	CU FT	Model	List Price
End Table	24	24	16	40	7	FI2424G	\$2,302



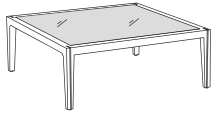
- glass top
- glossy low iron white back painted glass

End Table	28	20	16	39	7	FI2028G	\$2,315
-----------	----	----	----	----	---	---------	---------



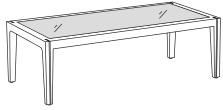
- glass top
- glossy low iron white back painted glass

Coffee Table	42	42	16	111	20	FI4242G	\$3,930
--------------	----	----	----	-----	----	---------	---------



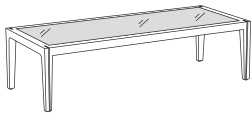
- glass top
- glossy low iron white back painted glass

Coffee Table	24	50	16	77	14	FI2450G	\$3,125
--------------	----	----	----	----	----	---------	---------



- glass top
- glossy low iron white back painted glass

Coffee Table	24	60	16	91	17	FI2460G	\$4,038
--------------	----	----	----	----	----	---------	---------



- glass top
- glossy low iron white back painted glass

FINN

Description	D	W	H	CTN WT	CU FT	① Model	List Price
End Table	24	24	16	24	7	FI2424W	\$2,150



- wood top
- parquet veneer face

End Table	28	20	16	24	7	FI2028W	\$2,177
-----------	----	----	----	----	---	---------	---------



- wood top
- parquet veneer face

Coffee Table	42	42	16	62	20	FI4242W	\$3,064
--------------	----	----	----	----	----	---------	---------



- wood top
- parquet veneer face

Coffee Table	24	50	16	45	14	FI2450W	\$2,681
--------------	----	----	----	----	----	---------	---------



- wood top
- parquet veneer face

Coffee Table	24	60	16	52	17	FI2460W	\$3,403
--------------	----	----	----	----	----	---------	---------



- wood top
- parquet veneer face

To Order, Specify:

- ① Model Number
- ② Wood Species - Cherry (C), Maple (M), White Oak (O) or Walnut (W)
- ③ Wood Finish See [Wood Finish Options](#)
- ④ Optional Rubber Cushion Nylon Glides - no upcharge

Specifications

- Wood species - Cherry, Maple, White Oak or Walnut in clear finish.
- Internal aluminum core throughout the legs.
- Standard with nylon glides.

Finn Nu Lounge Order Check List:



FINN NU

Specify:

- 1. Model Number
- 2. Wood Species - Maple (M)
- 3. Wood Finish
- 4. Fabric Selection - vendor, pattern and color
- 5. Table Tops - Glass (G) or Wood (W)
- 6. Optional Rubber Cushion Nylon Glides (Seating Only) - no upcharge

Example:

FI2351 | **M** | **AUB** | **MOMENTUM** | **VOX** | **MYSTIC**
 (model #) | (wood species) | (finish) | (fabric vendor) | (pattern name) | (pattern color)

1. Model Number

2. Wood Species - Maple (M)

3. Wood Finish Options:

ALM	Ale Medium	CKC	Khaki Coordinate
CAL	Ale Light Coordinate	MINC	Mineral Coordinate
BBM	Bourbon Medium	MCH	Mocha
CBZ	Brazilwood Coordinate	CPI	Pinnacle Walnut Coordinate
BARC	Barrel Coordinate	PRL	Praline
CBO	Bourbon Light Coordinate	RAVC	Raven Coordinate
CBG	Brighton Light Coordinate	SABC	Sable Coordinate
BRM	Brighton Medium	SIE	Sienna
BUT	Butterscotch	CST	Studio Teak Coordinate
CNDC	Cinder Coordinate	TRF	Truffle
CLA	Classic	UMB	Umber
CLL	Collectors	VALC	Valley Coordinate
EGRC	Egret Coordinate	VEN	Venetian
ESP	Espresso	CWE	Weathered Ash Coordinate
FAWC	Fawn Coordinate		
FLX	Flax		
CGR	Graphite Coordinate		
HRV	Harvest		

4. Fabric Selection - Please supply the following:
 Fabric vendor/Pattern name/Pattern color

For a complete list of JSI Standard and Graded-In Textiles click here

When specifying contrasting upholstery, indicate clearly which upholstery is to be applied to the seat and back. Use higher grade pricing.

- Indicate direction of fabric - Railroaded or Up the Roll
- Please provide illustration, if available

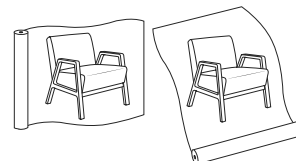
All COM orders must include the following:

- Vendor's name, pattern name and color
- Sample of the fabric attached to order
- Model numbers of items for fabric application
- Special application instructions (e.g., all stripes will be applied front to back unless specified otherwise)
- Customer and purchase order number

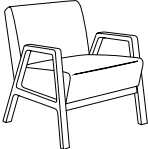

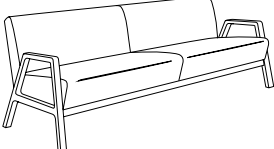
Ship prepaid COM material to:

JSI
 Attn: COM Department
 201 East Martin Street
 Receiving B, Dock 71
 Orleans, IN 47452

Application of fabric:
 Railroaded Up the Roll



All COM orders will ship at standard lead time from receipt of COM except for orders requiring special custom matched finishes.


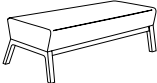
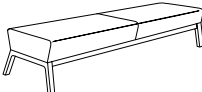
Description	Model	Specifications				List Price Per Grade			
Single Seat 	FI2351 · arm	Dimensions	D	W	H	COM \$1,703 A \$1,734 B \$1,798 COL/C \$1,907 D \$2,046 E \$2,183 F \$2,329 G \$2,540 H \$2,762 I \$3,109 J \$3,526 L1 \$2,859 L2 \$3,151			
		Overall	30 ½	27 ½	30 ¾				
		Seat	20 ½	24	16 ¾				
		Arm			22				
		Upholstery	Shipping						
		COM Ydg	2 ½	Ctn Wt	36				
		COL Sq Ft	58	Cu Ft	25				
		Two Seat 	FI2352 · arm	Dimensions	D		W	H	COM \$2,345 A \$2,396 B \$2,495 COL/C \$2,668 D \$2,890 E \$3,112 F \$3,345 G \$3,681 H \$4,036 I \$4,592 J \$5,258 L1 \$4,193 L2 \$4,657
				Overall	30 ½		51 ¼	30 ¾	
				Seat	20 ½		47 ¾	16 ¾	
Arm					22				
Upholstery	Shipping								
COM Ydg	4			Ctn Wt	56				
COL Sq Ft	92			Cu Ft	39				
Three Seat 	FI2353 · arm			Dimensions	D	W	H	COM \$2,989 A \$3,072 B \$3,233 COL/C \$3,515 D \$3,876 E \$4,238 F \$4,620 G \$5,160 H \$5,738 I \$6,644 J \$7,727 L1 \$5,992 L2 \$6,750	
				Overall	30 ½	75	30 ¾		
				Seat	20 ½	71 ½	16 ¾		
		Arm			22				
		Upholstery	Shipping						
		COM Ydg	6 ½	Ctn Wt	64				
		COL Sq Ft	150	Cu Ft	75				

To Order, Specify:

- 1 Model Number
- 2 Wood Species - Maple (M)
- 3 Wood Finish [See Wood Finish Options](#)
- 4 Fabric Selection - vendor, pattern and color
 Visit www.jsifurniture.com/finishes-and-materials/textiles for our textiles program.
 See selection of standard and graded in manufacturers and patterns.
- 5 Optional Rubber Cushion Nylon Glides (seating only) - no upcharge

Specifications

- Wood species - Maple.
- Seat has 3" high density polyurethane foam and synthetic sheet webbing with cross strap reinforcement.
- Mortise and tenon construction with corner blocks, glue and screws
- Features fixed cushions.
- Standard with rubber cushion metal glides..

Description	① Model	Specifications				List Price Per Grade
Single Seat Bench 	F12371	Dimensions	D	W	H	COM \$1,269
		Overall	22 ¼	24	16 ¾	A \$1,287
		Seat	20 ½	24	16 ¾	B \$1,325
		Upholstery	Shipping			COL/C \$1,389
		COM Ydg	1 ½	Ctn Wt	22	D \$1,473
		COL Sq Ft	35	Cu Ft	13	E \$1,555
						F \$1,645
				G \$1,771		
				H \$1,905		
				I \$2,112		
				J \$2,361		
				L1 \$1,961		
				L2 \$2,136		
Two Seat Bench 	F12372	Dimensions	D	W	H	COM \$1,687
		Overall	22 ¼	47 ¾	16 ¾	A \$1,718
		Seat	20 ½	47 ¾	16 ¾	B \$1,781
		Upholstery	Shipping			COL/C \$1,886
		COM Ydg	2 ½	Ctn Wt	40	D \$2,026
		COL Sq Ft	58	Cu Ft	20	E \$2,165
						F \$2,313
				G \$2,521		
				H \$2,744		
				I \$3,092		
				J \$3,508		
				L1 \$2,840		
				L2 \$3,132		
Three Seat Bench 	F12373	Dimensions	D	W	H	COM \$2,228
		Overall	22 ¼	71 ½	16 ¾	A \$2,291
		Seat	20 ½	71 ½	16 ¾	B \$2,414
		Upholstery	Shipping			COL/C \$2,631
		COM Ydg	5	Ctn Wt	57	D \$2,909
		COL Sq Ft	115	Cu Ft	32	E \$3,187
						F \$3,479
				G \$3,900		
				H \$4,340		
				I \$5,037		
				J \$5,870		
				L1 \$4,536		
				L2 \$5,120		

Description	D	W	H	CTN WT	CU FT	① Model	List Price
End Table	24	24	16	40	8	FI2424PG	\$1,734



- glass top
- glossy low iron white back painted glass

End Table	28	20	16	39	7	FI2028PG	\$1,732
-----------	----	----	----	----	---	----------	---------



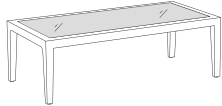
- glass top
- glossy low iron white back painted glass

Coffee Table	42	42	16	111	21	FI4242PG	\$3,190
--------------	----	----	----	-----	----	----------	---------



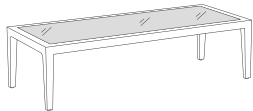
- glass top
- glossy low iron white back painted glass

Coffee Table	24	50	16	77	15	FI2450PG	\$2,478
--------------	----	----	----	----	----	----------	---------



- glass top
- glossy low iron white back painted glass

Coffee Table	24	60	16	91	17	FI2460PG	\$2,719
--------------	----	----	----	----	----	----------	---------



- glass top
- glossy low iron white back painted glass

To Order, Specify:

- ① Model Number
- ② Wood Species - Maple (M)
- ③ Wood Finish See [Wood Finish Options](#)
- ④ Fabric Selection - vendor, pattern and color

Visit www.jsifurniture.com/finishes-and-materials/textiles for our textiles program.
See selection of standard and graded in manufacturers and patterns.

Specifications

- Wood species - Maple.
- Standard with nylon glides.

Description	D	W	H	CTN WT	CU FT	① Model	List Price
End Table	24	24	16	24	8	FI2424PW	\$1,507



- wood top
- bookmatch maple veneer

End Table	28	20	16	24	7	FI2028PW	\$1,523
-----------	----	----	----	----	---	----------	---------



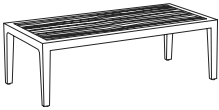
- wood top
- bookmatch maple veneer

Coffee Table	42	42	16	62	21	FI4242PW	\$1,998
--------------	----	----	----	----	----	----------	---------



- wood top
- bookmatch maple veneer

Coffee Table	24	50	16	45	15	FI2450PW	\$1,795
--------------	----	----	----	----	----	----------	---------



- wood top
- bookmatch maple veneer

Coffee Table	24	60	16	52	17	FI2460PW	\$1,839
--------------	----	----	----	----	----	----------	---------



- wood top
- bookmatch maple veneer

To Order, Specify:

- ① Model Number
- ② Wood Species - Maple (M)
- ③ Wood Finish [See Wood Finish Options](#)

Specifications

- Wood species - Maple.
- Standard with nylon glides.

Garvey R5 Order Check List:



Specify:

- 1. Model Number
- 2. Fabric Selection - vendor, pattern and color
- 3. Arm Selection:
 - Garvey Back Style
 - A. Polished Aluminum Loop Arms (PAA) - no upcharge
 - B. Polished Aluminum Loop Arms with Arm Cap (PAC) - add \$84 list
 - R5 Back Style
 - A. Adjustable T Arms (ATA) - no upcharge
 - B. Polyurethane C Arms (CPU) - add \$84 list
 - C. Polished Aluminum C Arms with Arm Cap (CAC) - add \$202 list
- 4. Control Selection:
 - A. Swivel Tilt (SWT) - no upcharge
 - B. Synchro (SNC) - add \$158 list
 - C. Synchro with Seat Slide (SCC) - add \$200 list
- 5. 5 Star Base Selection:
 - A. Black Nylon (BL) - no upcharge
 - B. Polished Aluminum (PA) - add \$116 list
- 6. Caster Selection:
 - A. Black Hard Tread Dual Wheel (BLK) - no upcharge
 - B. Premium Polished Trim Gray Dual Wheel Soft Urethane (PPG) - add \$366 list

Example:

GV2105 (model #)	MOMENTUM (fabric vendor)	CANTER EPU (pattern name)	FOLKSTONE GREY (pattern color)	PAA (arm)	SWT (control)	BL (base)	BLK (caster)
----------------------------	------------------------------------	-------------------------------------	--	---------------------	-------------------------	---------------------	------------------------

1. Model Number

All COM orders will ship at standard lead time from receipt of COM except for orders requiring special custom matched finishes.

2. Fabric Selection - Please supply the following:
Fabric vendor/Pattern name/Pattern color

[For a complete list of JSI Standard and Graded-In Textiles click here](#)

When specifying contrasting upholstery, indicate clearly which upholstery is to be applied to the seat, back and arms. Use higher grade pricing.

- Indicate direction of fabric - Railroaded or Up the Roll
- Please provide illustration, if available

All COM orders must include the following:

- Vendor's name, pattern name and color
- Sample of the fabric attached to order
- Model numbers of items for fabric application
- Special application instructions (e.g., all stripes will be applied front to back unless specified otherwise)
- Customer and purchase order number

Ship prepaid COM material to:

JSI
Attn: COM Department
201 East Martin Street
Receiving B, Dock 71
Orleans, IN 47452

Application of fabric:
Railroaded Up the Roll



3. Arm Selection:

Garvey Back Style

- A. Polished Aluminum Loop Arms (PAA) - no upcharge
- B. Polished Aluminum Loop Arms with Arm Cap (PAC) - add \$84 list

R5 Back Style

- A. Adjustable T Arms (ATA) - no upcharge
- B. Polyurethane C Arms (CPU) - add \$84 list
- C. Polished Aluminum C Arms with Cap (CAC) - add \$202

4. Control Selection:


- A. Swivel Tilt (SWT) - no upcharge
- B. Synchro (SNC) - add \$158 list
- C. Synchro with Seat Slide (SSC) - add \$200 list


5. 5 Star Base Selection:

- A. Black Nylon (BL) - no upcharge
- B. Polished Aluminum (PA) - add \$116 list

6. Caster Selection:


- A. Black Hard Tread Dual Wheel (BLK) - no upcharge
- B. Premium Polished Trim Gray Dual Wheel Soft Urethane (PPG) - add \$366 list


Description	① Model	Specifications				List Price Per Grade	
		Dimensions	D	W	H	COM	
Garvey Back Style - Executive High Back 	GV2105 <ul style="list-style-type: none"> unique curved back detail molds around the loop arm specify arm: polished aluminum loop arms or polished aluminum loop arms with arm cap specify control: swivel tilt or synchro tilt control specify 5 star base: black nylon or polished aluminum base specify caster: black hard tread dual wheel caster or premium polished trim grey dual wheel soft urethane caster 	Overall	26	25	42-45 1/2	A	\$1,475
		Seat	20	20 1/2	18-21 1/2	B	\$1,500
		Arm			25-30	C	\$1,550
		Upholstery		Shipping		D	\$1,634
		Ydg	2 1/4	Ctn Wt	60	E	\$1,744
		Sq Ft	41 1/2	Cu Ft	20	F	\$1,855
						G	\$2,025
						H	\$2,207
						I	\$2,402
						J	\$2,704
						L1	\$3,070
						L2	\$2,341
							\$2,585

Description	① Model	Specifications				List Price Per Grade	
		Dimensions	D	W	H	COM	
Garvey Back Style - Management Mid Back 	GV2100 <ul style="list-style-type: none"> unique curved back detail molds around the loop arm specify arm: polished aluminum loop arms or polished aluminum loop arms with arm cap specify control: swivel tilt or synchro tilt control specify 5 star base: black nylon or polished aluminum base specify caster: black hard tread dual wheel caster or premium polished trim grey dual wheel soft urethane caster 	Overall	26	25	38-41 1/2	A	\$1,438
		Seat	20	20 1/2	18-21 1/2	B	\$1,459
		Arm			25-30	C	\$1,501
		Upholstery		Shipping		D	\$1,578
		Ydg	2	Ctn Wt	55	E	\$1,675
		Sq Ft	41 1/4	Cu Ft	18	F	\$1,774
						G	\$1,923
						H	\$2,086
						I	\$2,259
						J	\$2,529
						L1	\$2,854
						L2	\$2,205
							\$2,421


To Order, Specify:


- ① Model Number
- ② Fabric Selection - vendor, pattern and color
Visit www.jsifurniture.com/finishes-and-materials/textiles for our textiles program.
See selection of standard and graded in manufacturers and patterns.
- ③ Arms - Polished Aluminum Loop Arms (PAA), no upcharge,
Polished Aluminum Loop Arms with Arm Cap (PAC), or \$84 list
- ④ Control - Swivel Tilt (SWT), no upcharge;
Synchro (SNC), add \$158 list
Synchro Seat Slide (SSC), add \$200 list
- ⑤ Base - Black Nylon (BL), - no upcharge;
Polished Aluminum (PA), - add \$116 list
- ⑥ Caster - Black Hard Tread Dual Wheel (BLK), - no upcharge;
Premium Polished Trim Gray Dual Wheel Soft Urethane (PPG), - add \$366 list

Description	① Model	Specifications			List Price Per Grade	
R5 Back Style - Executive Fixed High Back 	GV1722 <ul style="list-style-type: none"> · specify arm: adjustable T arms, polyurethane C arms or polished aluminum C arms with arm cap · specify control: swivel tilt or synchro tilt or synchro w/seat slider control · specify 5 star base: black nylon or polished aluminum base · specify caster: black hard tread dual wheel caster or premium polished trim grey dual wheel soft urethane caster 	Dimensions	D	W	H	COM \$1,342
		Overall	25	30	43-48 ½	A \$1,372
		Seat	18 ½	21 ½	21 ½	B \$1,424
		Arm	23 ½-29			C \$1,519
		Upholstery	Shipping			D \$1,642
		Ydg	2 ½	Ctn Wt	52	E \$1,763
		Sq Ft	55	Cu Ft	16	F \$1,952
						G \$2,156
						H \$2,370
						I \$2,709
						J \$3,113
						L1 \$2,303
						L2 \$2,574

R5 Back Style - Management Fixed Mid Back 	GV1721 <ul style="list-style-type: none"> · specify arm: adjustable T arms, polyurethane C arms or polished aluminum C arms with arm cap · specify control: swivel tilt or synchro tilt or synchro w/seat slider control · specify 5 star base: black nylon or polished aluminum base · specify caster: black hard tread dual wheel caster or premium polished trim grey dual wheel soft urethane caster 	Dimensions	D	W	H	COM \$1,314
		Overall	25	30	38-41 ½	A \$1,338
		Seat	18 ½	21 ½	21 ½	B \$1,387
		Arm	23 ½-29			C \$1,472
		Upholstery	Shipping			D \$1,582
		Ydg	2 ½	Ctn Wt	49	E \$1,692
		Sq Ft	50	Cu Ft	12	F \$1,861
						G \$2,044
						H \$2,239
						I \$2,542
						J \$2,908
						L1 \$2,178
						L2 \$2,421

GARVEY R5

Description	① Model	Specifications			List Price Per Grade		
		Dimensions	D	W	H	COM	
R5 Back Style - Executive Adjustable High Back	GV1724 <ul style="list-style-type: none"> back has five height ratchet positions for 2 1/2" vertical adjustment. specify arm: adjustable T arms, polyurethane C arms or polished aluminum C arms with arm cap specify control: swivel tilt or synchro tilt or synchro w/seat slider control specify 5 star base: black nylon or polished aluminum base specify caster: black hard tread dual wheel caster or premium polished trim grey dual wheel soft urethane caster 	Overall	25	30	43-48 1/2	A	\$1,384
		Seat	18 1/2	21 1/2	21 1/2	B	\$1,413
		Arm	23 1/2-29			C	\$1,466
		Upholstery		Shipping		D	\$1,561
		Ydg	2 2/3	Ctn Wt	52	E	\$1,684
		Sq Ft	55	Cu Ft	16	F	\$1,806
						G	\$1,993
						H	\$2,197
						I	\$2,412
						J	\$2,751
						L1	\$3,155
						L2	\$2,345

Description	① Model	Specifications			List Price Per Grade		
		Dimensions	D	W	H	COM	
R5 Back Style - Management Adjustable Mid Back	GV1723 <ul style="list-style-type: none"> back has five height ratchet positions for 2 1/2" vertical adjustment. specify arm: adjustable T arms, polyurethane C arms or polished aluminum C arms with arm cap specify control: swivel tilt or synchro tilt or synchro w/seat slider control specify 5 star base: black nylon or polished aluminum base specify caster: black hard tread dual wheel caster or premium polished trim grey dual wheel soft urethane caster 	Overall	25	30	38-41 1/2	A	\$1,371
		Seat	18 1/2	21 1/2	21 1/2	B	\$1,396
		Arm	23 1/2-29			C	\$1,444
		Upholstery		Shipping		D	\$1,530
		Ydg	2 1/3	Ctn Wt	49	E	\$1,639
		Sq Ft	50	Cu Ft	12	F	\$1,748
						G	\$1,918
						H	\$2,101
						I	\$2,295
						J	\$2,599
						L1	\$2,966
						L2	\$2,234

GARVEY R5

To Order, Specify:

- ① Model Number
- ② Fabric Selection - vendor, pattern and color
Visit www.jsifurniture.com/finishes-and-materials/textiles for our textiles program.
See selection of standard and graded in manufacturers and patterns.
- ③ Arms - Adjustable T Arms (ATA), no upcharge;
Polyurethane C Arms (CPU), add \$84 list
Polished Aluminum C Arms with Arm Cap (CAC), or \$202 list
- ④ Control - Swivel Tilt (SWT), no upcharge;
Synchro (SNC), add \$158 list
Synchro Seat Slide (SSC), add \$200 list
- ⑤ Base - Black Nylon (BL), - no upcharge;
Polished Aluminum (PA), - add \$116 list
- ⑥ Caster - Black Hard Tread Dual Wheel (BLK), - no upcharge;
Premium Polished Trim Gray Dual Wheel Soft Urethane (PPG), - add \$366 list

Gatsby Order Check List:



Specify:

- 1. Model Number
- 2. Wood Species - Maple (M)
- 3. Wood Finish
- 4. Fabric Selection - vendor, pattern and color
- 5. Optional Black Anti-Microbial Polyurethane Arm Caps
 - A. Single Seat - add \$122 list
 - B. Two Seat Tandem - add \$182 list
 - C. Three Seat Tandem - add \$241 list
 - D. Four Seat Tandem - add \$301 list
- 6. Optional Rubber Cushion Nylon Glides - no upcharge

Example:

GT4901E | M | HRV | MOMENTUM | VOX | MYSTIC
 (model #) | (wood species) | (finish) | (fabric vendor) | (pattern name) | (pattern color)

1. Model Number

- Model numbers of items for fabric application
- Special application instructions (e.g., all stripes will be applied front to back unless specified otherwise)
- Customer and purchase order number

2. Wood Species - Maple (M)

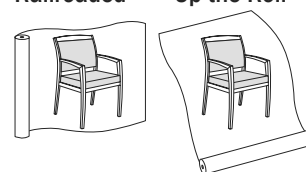
3. Wood Finish Options:

ALM Ale Medium	HRV Harvest
CAL Ale Light Coordinate	CKC Khaki Coordinate
BBM Bourbon Medium	MINC Mineral Coordinate
CBZ Brazilwood Coordinate	MCH Mocha
BARC Barrel Coordinate	CPI Pinnacle Walnut Coordinate
CBO Bourbon Light Coordinate	PRL Praline
CBG Brighton Light Coordinate	RAVC Raven Coordinate
BRM Brighton Medium	SABC Sable Coordinate
BUT Butterscotch	SIE Sienna
CNDC Cinder Coordinate	CST Studio Teak Coordinate
CLA Classic	TRF Truffle
CLL Collectors	UMB Umber
EGRC Egret Coordinate	VALC Valley Coordinate
ESP Espresso	VEN Venetian
FAWC Fawn Coordinate	CWE Weathered Ash Coordinate
FLX Flax	
CGR Graphite Coordinate	

Ship prepaid COM material to:

JSI
 Attn: COM Department
 201 East Martin Street
 Receiving B, Dock 71
 Orleans, IN 47452

Application of fabric:
 Railroaded Up the Roll



All COM orders will ship at standard lead time from receipt of COM except for orders requiring special custom matched finishes.

4. Fabric Selection - Please supply the following:
 Fabric vendor/Pattern name/Pattern color

For a complete list of JSI Standard and Graded-In Textiles click here

When specifying contrasting upholstery, indicate clearly which upholstery is to be applied to the seat and back. Use higher grade pricing.

- Indicate direction of fabric - Railroaded or Up the Roll
- Please provide illustration, if available

All COM orders must include the following:

- Vendor's name, pattern name and color
- Sample of the fabric attached to order


5. Optional Black Anti-Microbial Polyurethane Arm Caps


- A. Single Seat - add \$122 list
- B. Two Seat Tandem - add \$182 list
- C. Three Seat Tandem - add \$241 list
- D. Four Seat Tandem - add \$301 list




6. Optional Rubber Cushion Nylon Glides - no upcharge

7. Product Options - Special Finish: \$372 list upcharge

Description	Model	Specifications				List Price Per Grade	
Guest Chair 	GT4903D · upholstered seat · fully upholstered back · armless · solid hardwood back frame with synthetic sheet webbing and 3/4" high density polyurethane foam · pre-drilled to accept linking kit, see page GT15 for kit	Dimensions		D	W	H	COM \$994
		Overall	24 1/2	22 1/8	35 3/8	A \$1,010	
		Seat	18 1/2	20	19	B \$1,042	
		Upholstery		Shipping		COL/C \$1,097	
		COM Ydg	1 1/2	Ctn Wt	30	D \$1,170	
		COL Sq Ft	27	Cu Ft	17	E \$1,242	
						F \$1,353	
						G \$1,471	
						H \$1,601	
						I \$1,798	
						J \$2,038	
						L1 \$1,496	
						L2 \$1,640	

Guest Chair 	GT4903E · upholstered seat · 3/4 upholstered back · armless · solid hardwood back frame with synthetic sheet webbing and 3/4" high density polyurethane foam · pre-drilled to accept linking kit, see page GT15 for kit	Dimensions		D	W	H	COM \$984
		Overall	24 1/2	22 1/8	35 3/8	A \$1,002	
		Seat	18 1/2	20	19	B \$1,033	
		Upholstery		Shipping		COL/C \$1,089	
		COM Ydg	1 1/2	Ctn Wt	29	D \$1,161	
		COL Sq Ft	27	Cu Ft	17	E \$1,233	
						F \$1,344	
						G \$1,463	
						H \$1,592	
						I \$1,791	
						J \$2,031	
						L1 \$1,488	
						L2 \$1,632	


Guest Chair 	GT4903F · upholstered seat · veneer plywood back panel · armless · pre-drilled to accept linking kit, see page GT15 for kit	Dimensions		D	W	H	COM \$895
		Overall	24 1/2	22 1/8	35 3/8	A \$906	
		Seat	18 1/2	20	19	B \$924	
		Upholstery		Shipping		COL/C \$956	
		COM Ydg	7/8	Ctn Wt	26	D \$999	
		COL Sq Ft	16	Cu Ft	17	E \$1,041	
						F \$1,105	
						G \$1,175	
						H \$1,249	
						I \$1,365	
						J \$1,505	
						L1 \$1,188	
						L2 \$1,271	


To Order, Specify:



- 1 Model Number
- 2 Wood Species - Maple (M)
- 3 Wood Finish [See Wood Finish Options](#)
- 4 Fabric Selection - vendor, pattern and color
 Visit www.jsifurniture.com/finishes-and-materials/textiles for our textiles program.
 See selection of standard and graded in manufacturers and patterns.
- 5 Optional Rubber Cushion Nylon Glides - no upcharge




Specifications

- Wood species - Maple.
- Mortise and tenon construction with corner blocks, glue and screws.
- Seat has 1/2" plywood with synthetic sheet webbing and 2 1/2" high density polyurethane foam.
- Wall saver feature.
- Standard with rubber cushion metal glides.

Description	① Model	Specifications	List Price Per Grade												
Guest Chair 	GT4903G <ul style="list-style-type: none"> · upholstered seat · upholstered plywood back panel with 1/2" high density polyurethane foam · armless · pre-drilled to accept linking kit, see page GT15 for kit 	<table border="1"> <thead> <tr> <th>Dimensions</th> <th>D</th> <th>W</th> <th>H</th> </tr> </thead> <tbody> <tr> <td>Overall</td> <td>24 1/2</td> <td>22 1/8</td> <td>35 3/8</td> </tr> <tr> <td>Seat</td> <td>18 1/2</td> <td>20</td> <td>19</td> </tr> </tbody> </table>	Dimensions	D	W	H	Overall	24 1/2	22 1/8	35 3/8	Seat	18 1/2	20	19	COM \$915 A \$924 B \$943 COL/C \$975 D \$1,018 E \$1,060 F \$1,124 G \$1,195 H \$1,268 I \$1,384 J \$1,525 L1 \$1,208 L2 \$1,291
		Dimensions	D	W	H										
Overall	24 1/2	22 1/8	35 3/8												
Seat	18 1/2	20	19												
<table border="1"> <thead> <tr> <th>Upholstery</th> <th colspan="3">Shipping</th> </tr> </thead> <tbody> <tr> <td>COM Ydg</td> <td>7/8</td> <td>Ctn Wt</td> <td>27</td> </tr> <tr> <td>COL Sq Ft</td> <td>16</td> <td>Cu Ft</td> <td>17</td> </tr> </tbody> </table>	Upholstery	Shipping			COM Ydg	7/8	Ctn Wt	27	COL Sq Ft	16	Cu Ft	17			
Upholstery	Shipping														
COM Ydg	7/8	Ctn Wt	27												
COL Sq Ft	16	Cu Ft	17												

Description	① Model	Specifications	List Price Per Grade												
Guest Chair 	GT4903I <ul style="list-style-type: none"> · upholstered seat · vertical slat back · steam bent slats · armless · pre-drilled to accept linking kit, see page GT15 for kit 	<table border="1"> <thead> <tr> <th>Dimensions</th> <th>D</th> <th>W</th> <th>H</th> </tr> </thead> <tbody> <tr> <td>Overall</td> <td>24 1/2</td> <td>22 1/8</td> <td>35 3/8</td> </tr> <tr> <td>Seat</td> <td>18 1/2</td> <td>20</td> <td>19</td> </tr> </tbody> </table>	Dimensions	D	W	H	Overall	24 1/2	22 1/8	35 3/8	Seat	18 1/2	20	19	COM \$997 A \$1,005 B \$1,025 COL/C \$1,056 D \$1,098 E \$1,141 F \$1,205 G \$1,276 H \$1,349 I \$1,466 J \$1,605 L1 \$1,289 L2 \$1,373
		Dimensions	D	W	H										
Overall	24 1/2	22 1/8	35 3/8												
Seat	18 1/2	20	19												
<table border="1"> <thead> <tr> <th>Upholstery</th> <th colspan="3">Shipping</th> </tr> </thead> <tbody> <tr> <td>COM Ydg</td> <td>7/8</td> <td>Ctn Wt</td> <td>26</td> </tr> <tr> <td>COL Sq Ft</td> <td>16</td> <td>Cu Ft</td> <td>17</td> </tr> </tbody> </table>	Upholstery	Shipping			COM Ydg	7/8	Ctn Wt	26	COL Sq Ft	16	Cu Ft	17			
Upholstery	Shipping														
COM Ydg	7/8	Ctn Wt	26												
COL Sq Ft	16	Cu Ft	17												

Description	① Model	Specifications	List Price Per Grade												
Guest Chair   upholstered vertical slat back	GT4903J <ul style="list-style-type: none"> · upholstered seat · upholstered vertical slat back · steam bent slats with 3/4" high density polyurethane foam · armless · pre-drilled to accept linking kit, see page GT15 for kit 	<table border="1"> <thead> <tr> <th>Dimensions</th> <th>D</th> <th>W</th> <th>H</th> </tr> </thead> <tbody> <tr> <td>Overall</td> <td>24 1/2</td> <td>22 1/8</td> <td>35 3/8</td> </tr> <tr> <td>Seat</td> <td>18 1/2</td> <td>20</td> <td>19</td> </tr> </tbody> </table>	Dimensions	D	W	H	Overall	24 1/2	22 1/8	35 3/8	Seat	18 1/2	20	19	COM \$1,052 A \$1,070 B \$1,100 COL/C \$1,157 D \$1,228 E \$1,301 F \$1,413 G \$1,531 H \$1,660 I \$1,859 J \$2,099 L1 \$1,555 L2 \$1,700
		Dimensions	D	W	H										
Overall	24 1/2	22 1/8	35 3/8												
Seat	18 1/2	20	19												
<table border="1"> <thead> <tr> <th>Upholstery</th> <th colspan="3">Shipping</th> </tr> </thead> <tbody> <tr> <td>COM Ydg</td> <td>1 1/2</td> <td>Ctn Wt</td> <td>29</td> </tr> <tr> <td>COL Sq Ft</td> <td>27</td> <td>Cu Ft</td> <td>17</td> </tr> </tbody> </table>	Upholstery	Shipping			COM Ydg	1 1/2	Ctn Wt	29	COL Sq Ft	27	Cu Ft	17			
Upholstery	Shipping														
COM Ydg	1 1/2	Ctn Wt	29												
COL Sq Ft	27	Cu Ft	17												

Description	Model	Specifications	List Price Per Grade																
Guest Chair 	GT4901D • upholstered seat • fully upholstered back • solid hardwood back frame with synthetic sheet webbing and ¾" high density polyurethane foam • pre-drilled to accept linking kit, see page GT15 for kit	<table border="1"> <thead> <tr> <th>Dimensions</th> <th>D</th> <th>W</th> <th>H</th> </tr> </thead> <tbody> <tr> <td>Overall</td> <td>24 ½</td> <td>22 ⅞</td> <td>35 ⅜</td> </tr> <tr> <td>Seat</td> <td>18 ¼</td> <td>20</td> <td>19</td> </tr> <tr> <td>Arm</td> <td></td> <td></td> <td>25 ⅞</td> </tr> </tbody> </table>	Dimensions	D	W	H	Overall	24 ½	22 ⅞	35 ⅜	Seat	18 ¼	20	19	Arm			25 ⅞	COM \$994 A \$1,010 B \$1,042 COL/C \$1,097 D \$1,170 E \$1,242 F \$1,353 G \$1,471 H \$1,601 I \$1,798 J \$2,038 L1 \$1,496 L2 \$1,640
		Dimensions	D	W	H														
Overall	24 ½	22 ⅞	35 ⅜																
Seat	18 ¼	20	19																
Arm			25 ⅞																
<table border="1"> <thead> <tr> <th>Upholstery</th> <th colspan="2">Shipping</th> </tr> </thead> <tbody> <tr> <td>COM Ydg</td> <td>1 ½</td> <td>Ctn Wt 30</td> </tr> <tr> <td>COL Sq Ft</td> <td>27</td> <td>Cu Ft 17</td> </tr> </tbody> </table>	Upholstery	Shipping		COM Ydg	1 ½	Ctn Wt 30	COL Sq Ft	27	Cu Ft 17										
Upholstery	Shipping																		
COM Ydg	1 ½	Ctn Wt 30																	
COL Sq Ft	27	Cu Ft 17																	
Guest Chair 	GT4901E • upholstered seat • ¾ upholstered back • solid hardwood back frame with synthetic sheet webbing and ¾" high density polyurethane foam • pre-drilled to accept linking kit, see page GT15 for kit	<table border="1"> <thead> <tr> <th>Dimensions</th> <th>D</th> <th>W</th> <th>H</th> </tr> </thead> <tbody> <tr> <td>Overall</td> <td>24 ½</td> <td>22 ⅞</td> <td>35 ⅜</td> </tr> <tr> <td>Seat</td> <td>18 ¼</td> <td>20</td> <td>19</td> </tr> <tr> <td>Arm</td> <td></td> <td></td> <td>25 ⅞</td> </tr> </tbody> </table>	Dimensions	D	W	H	Overall	24 ½	22 ⅞	35 ⅜	Seat	18 ¼	20	19	Arm			25 ⅞	COM \$984 A \$1,002 B \$1,033 COL/C \$1,089 D \$1,161 E \$1,233 F \$1,344 G \$1,463 H \$1,592 I \$1,791 J \$2,031 L1 \$1,488 L2 \$1,632
		Dimensions	D	W	H														
Overall	24 ½	22 ⅞	35 ⅜																
Seat	18 ¼	20	19																
Arm			25 ⅞																
<table border="1"> <thead> <tr> <th>Upholstery</th> <th colspan="2">Shipping</th> </tr> </thead> <tbody> <tr> <td>COM Ydg</td> <td>1 ½</td> <td>Ctn Wt 29</td> </tr> <tr> <td>COL Sq Ft</td> <td>27</td> <td>Cu Ft 17</td> </tr> </tbody> </table>	Upholstery	Shipping		COM Ydg	1 ½	Ctn Wt 29	COL Sq Ft	27	Cu Ft 17										
Upholstery	Shipping																		
COM Ydg	1 ½	Ctn Wt 29																	
COL Sq Ft	27	Cu Ft 17																	
Guest Chair 	GT4901F • upholstered seat • veneer plywood back panel • pre-drilled to accept linking kit, see page GT15 for kit	<table border="1"> <thead> <tr> <th>Dimensions</th> <th>D</th> <th>W</th> <th>H</th> </tr> </thead> <tbody> <tr> <td>Overall</td> <td>24 ½</td> <td>22 ⅞</td> <td>35 ⅜</td> </tr> <tr> <td>Seat</td> <td>19</td> <td>20</td> <td>19</td> </tr> <tr> <td>Arm</td> <td></td> <td></td> <td>25 ⅞</td> </tr> </tbody> </table>	Dimensions	D	W	H	Overall	24 ½	22 ⅞	35 ⅜	Seat	19	20	19	Arm			25 ⅞	COM \$895 A \$906 B \$924 COL/C \$956 D \$999 E \$1,041 F \$1,105 G \$1,175 H \$1,249 I \$1,365 J \$1,505 L1 \$1,188 L2 \$1,271
		Dimensions	D	W	H														
Overall	24 ½	22 ⅞	35 ⅜																
Seat	19	20	19																
Arm			25 ⅞																
<table border="1"> <thead> <tr> <th>Upholstery</th> <th colspan="2">Shipping</th> </tr> </thead> <tbody> <tr> <td>COM Ydg</td> <td>⅞</td> <td>Ctn Wt 26</td> </tr> <tr> <td>COL Sq Ft</td> <td>16</td> <td>Cu Ft 17</td> </tr> </tbody> </table>	Upholstery	Shipping		COM Ydg	⅞	Ctn Wt 26	COL Sq Ft	16	Cu Ft 17										
Upholstery	Shipping																		
COM Ydg	⅞	Ctn Wt 26																	
COL Sq Ft	16	Cu Ft 17																	


GATSBY


To Order, Specify:



- 1 Model Number
- 2 Wood Species - Maple (M)
- 3 Wood Finish [See Wood Finish Options](#)
- 4 Fabric Selection - vendor, pattern and color
 Visit www.jsifurniture.com/finishes-and-materials/textiles for our textiles program.
 See selection of standard and graded in manufacturers and patterns.
- 5 Optional Black Anti-Microbial Polyurethane Arm Caps - add \$122 list
- 6 Optional Rubber Cushion Nylon Glides - no upcharge

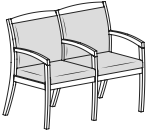
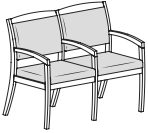
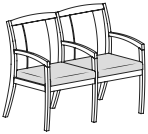
Specifications

- Wood species - Maple.
- Mortise and tenon construction with corner blocks, glue and screws.
- Seat has ½" plywood with synthetic sheet webbing and 2 ½" high density polyurethane foam.
- Wall saver feature.
- Standard with rubber cushion metal glides.

Description	① Model	Specifications	List Price Per Grade																																										
Guest Chair 	GT4901G · upholstered seat · upholstered plywood back panel with ½" high density polyurethane foam · pre-drilled to accept linking kit, see page GT15 for kit	<table border="1"> <thead> <tr> <th>Dimensions</th> <th>D</th> <th>W</th> <th>H</th> </tr> </thead> <tbody> <tr> <td>Overall</td> <td>24 ½</td> <td>22 ⅞</td> <td>35 ⅜</td> </tr> <tr> <td>Seat</td> <td>18 ½</td> <td>20</td> <td>19</td> </tr> <tr> <td>Arm</td> <td></td> <td></td> <td>25 ⅞</td> </tr> </tbody> </table>	Dimensions	D	W	H	Overall	24 ½	22 ⅞	35 ⅜	Seat	18 ½	20	19	Arm			25 ⅞	<table border="1"> <tbody> <tr> <td>COM</td> <td>\$915</td> </tr> <tr> <td>A</td> <td>\$924</td> </tr> <tr> <td>B</td> <td>\$943</td> </tr> <tr> <td>COL/C</td> <td>\$975</td> </tr> <tr> <td>D</td> <td>\$1,018</td> </tr> <tr> <td>E</td> <td>\$1,060</td> </tr> <tr> <td>F</td> <td>\$1,124</td> </tr> <tr> <td>G</td> <td>\$1,195</td> </tr> <tr> <td>H</td> <td>\$1,268</td> </tr> <tr> <td>I</td> <td>\$1,384</td> </tr> <tr> <td>J</td> <td>\$1,525</td> </tr> <tr> <td>L1</td> <td>\$1,208</td> </tr> <tr> <td>L2</td> <td>\$1,291</td> </tr> </tbody> </table>	COM	\$915	A	\$924	B	\$943	COL/C	\$975	D	\$1,018	E	\$1,060	F	\$1,124	G	\$1,195	H	\$1,268	I	\$1,384	J	\$1,525	L1	\$1,208	L2	\$1,291
		Dimensions	D	W	H																																								
Overall	24 ½	22 ⅞	35 ⅜																																										
Seat	18 ½	20	19																																										
Arm			25 ⅞																																										
COM	\$915																																												
A	\$924																																												
B	\$943																																												
COL/C	\$975																																												
D	\$1,018																																												
E	\$1,060																																												
F	\$1,124																																												
G	\$1,195																																												
H	\$1,268																																												
I	\$1,384																																												
J	\$1,525																																												
L1	\$1,208																																												
L2	\$1,291																																												
<table border="1"> <thead> <tr> <th>Upholstery</th> <th colspan="3">Shipping</th> </tr> </thead> <tbody> <tr> <td>COM Ydg</td> <td>⅞</td> <td>Ctn Wt</td> <td>27</td> </tr> <tr> <td>COL Sq Ft</td> <td>16</td> <td>Cu Ft</td> <td>17</td> </tr> </tbody> </table>	Upholstery	Shipping			COM Ydg	⅞	Ctn Wt	27	COL Sq Ft	16	Cu Ft	17																																	
Upholstery	Shipping																																												
COM Ydg	⅞	Ctn Wt	27																																										
COL Sq Ft	16	Cu Ft	17																																										

Guest Chair 	GT4901I · upholstered seat · vertical slat back · steam bent slats · pre-drilled to accept linking kit, see page GT15 for kit	<table border="1"> <thead> <tr> <th>Dimensions</th> <th>D</th> <th>W</th> <th>H</th> </tr> </thead> <tbody> <tr> <td>Overall</td> <td>24 ½</td> <td>22 ⅞</td> <td>35 ⅜</td> </tr> <tr> <td>Seat</td> <td>19</td> <td>20</td> <td>19</td> </tr> <tr> <td>Arm</td> <td></td> <td></td> <td>25 ⅞</td> </tr> </tbody> </table>	Dimensions	D	W	H	Overall	24 ½	22 ⅞	35 ⅜	Seat	19	20	19	Arm			25 ⅞	<table border="1"> <tbody> <tr> <td>COM</td> <td>\$997</td> </tr> <tr> <td>A</td> <td>\$1,005</td> </tr> <tr> <td>B</td> <td>\$1,025</td> </tr> <tr> <td>COL/C</td> <td>\$1,056</td> </tr> <tr> <td>D</td> <td>\$1,098</td> </tr> <tr> <td>E</td> <td>\$1,141</td> </tr> <tr> <td>F</td> <td>\$1,205</td> </tr> <tr> <td>G</td> <td>\$1,276</td> </tr> <tr> <td>H</td> <td>\$1,349</td> </tr> <tr> <td>I</td> <td>\$1,466</td> </tr> <tr> <td>J</td> <td>\$1,605</td> </tr> <tr> <td>L1</td> <td>\$1,289</td> </tr> <tr> <td>L2</td> <td>\$1,373</td> </tr> </tbody> </table>	COM	\$997	A	\$1,005	B	\$1,025	COL/C	\$1,056	D	\$1,098	E	\$1,141	F	\$1,205	G	\$1,276	H	\$1,349	I	\$1,466	J	\$1,605	L1	\$1,289	L2	\$1,373
		Dimensions	D	W	H																																								
Overall	24 ½	22 ⅞	35 ⅜																																										
Seat	19	20	19																																										
Arm			25 ⅞																																										
COM	\$997																																												
A	\$1,005																																												
B	\$1,025																																												
COL/C	\$1,056																																												
D	\$1,098																																												
E	\$1,141																																												
F	\$1,205																																												
G	\$1,276																																												
H	\$1,349																																												
I	\$1,466																																												
J	\$1,605																																												
L1	\$1,289																																												
L2	\$1,373																																												
<table border="1"> <thead> <tr> <th>Upholstery</th> <th colspan="3">Shipping</th> </tr> </thead> <tbody> <tr> <td>COM Ydg</td> <td>⅞</td> <td>Ctn Wt</td> <td>26</td> </tr> <tr> <td>COL Sq Ft</td> <td>16</td> <td>Cu Ft</td> <td>17</td> </tr> </tbody> </table>	Upholstery	Shipping			COM Ydg	⅞	Ctn Wt	26	COL Sq Ft	16	Cu Ft	17																																	
Upholstery	Shipping																																												
COM Ydg	⅞	Ctn Wt	26																																										
COL Sq Ft	16	Cu Ft	17																																										

Guest Chair   upholstered vertical slat back	GT4901J · upholstered seat · upholstered vertical slat back · steam bent slats with ¾" high density polyurethane foam · pre-drilled to accept linking kit, see page GT15 for kit	<table border="1"> <thead> <tr> <th>Dimensions</th> <th>D</th> <th>W</th> <th>H</th> </tr> </thead> <tbody> <tr> <td>Overall</td> <td>24 ½</td> <td>22 ⅞</td> <td>35 ⅜</td> </tr> <tr> <td>Seat</td> <td>18 ¼</td> <td>20</td> <td>19</td> </tr> <tr> <td>Arm</td> <td></td> <td></td> <td>25 ⅞</td> </tr> </tbody> </table>	Dimensions	D	W	H	Overall	24 ½	22 ⅞	35 ⅜	Seat	18 ¼	20	19	Arm			25 ⅞	<table border="1"> <tbody> <tr> <td>COM</td> <td>\$1,052</td> </tr> <tr> <td>A</td> <td>\$1,070</td> </tr> <tr> <td>B</td> <td>\$1,100</td> </tr> <tr> <td>COL/C</td> <td>\$1,157</td> </tr> <tr> <td>D</td> <td>\$1,228</td> </tr> <tr> <td>E</td> <td>\$1,301</td> </tr> <tr> <td>F</td> <td>\$1,413</td> </tr> <tr> <td>G</td> <td>\$1,531</td> </tr> <tr> <td>H</td> <td>\$1,660</td> </tr> <tr> <td>I</td> <td>\$1,859</td> </tr> <tr> <td>J</td> <td>\$2,099</td> </tr> <tr> <td>L1</td> <td>\$1,555</td> </tr> <tr> <td>L2</td> <td>\$1,700</td> </tr> </tbody> </table>	COM	\$1,052	A	\$1,070	B	\$1,100	COL/C	\$1,157	D	\$1,228	E	\$1,301	F	\$1,413	G	\$1,531	H	\$1,660	I	\$1,859	J	\$2,099	L1	\$1,555	L2	\$1,700
		Dimensions	D	W	H																																								
Overall	24 ½	22 ⅞	35 ⅜																																										
Seat	18 ¼	20	19																																										
Arm			25 ⅞																																										
COM	\$1,052																																												
A	\$1,070																																												
B	\$1,100																																												
COL/C	\$1,157																																												
D	\$1,228																																												
E	\$1,301																																												
F	\$1,413																																												
G	\$1,531																																												
H	\$1,660																																												
I	\$1,859																																												
J	\$2,099																																												
L1	\$1,555																																												
L2	\$1,700																																												
<table border="1"> <thead> <tr> <th>Upholstery</th> <th colspan="3">Shipping</th> </tr> </thead> <tbody> <tr> <td>COM Ydg</td> <td>1 ½</td> <td>Ctn Wt</td> <td>29</td> </tr> <tr> <td>COL Sq Ft</td> <td>27</td> <td>Cu Ft</td> <td>17</td> </tr> </tbody> </table>	Upholstery	Shipping			COM Ydg	1 ½	Ctn Wt	29	COL Sq Ft	27	Cu Ft	17																																	
Upholstery	Shipping																																												
COM Ydg	1 ½	Ctn Wt	29																																										
COL Sq Ft	27	Cu Ft	17																																										

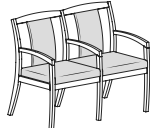

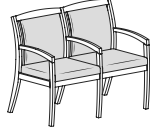
Description	Model	Specifications				List Price Per Grade		
Two Seat Tandem Guest Chair 	GT4992D <ul style="list-style-type: none"> · upholstered seat · fully upholstered back · solid hardwood back frame with synthetic sheet webbing and 3/4" high density polyurethane foam · pre-drilled to accept linking kit, see page GT15 for kit 	Dimensions		D	W	H	COM \$1,780 A \$1,814 B \$1,878 COL/C \$1,989 D \$2,131 E \$2,276 F \$2,499 G \$2,738 H \$2,992 I \$3,391 J \$3,870 L1 \$2,786 L2 \$3,073	
		Overall	24 1/2	43 1/8	35 3/8			
		Seat	18 1/4	20	19			
		Arm				25 7/8		
		Upholstery		Shipping				
		COM Ydg	3	Ctn Wt	48			
		COL Sq Ft	54	Cu Ft	25			
Two Seat Tandem Guest Chair 	GT4992E <ul style="list-style-type: none"> · upholstered seat · 3/4 upholstered back · solid hardwood back frame with synthetic sheet webbing and 3/4" high density polyurethane foam · pre-drilled to accept linking kit, see page GT15 for kit 	Dimensions		D	W	H	COM \$1,767 A \$1,798 B \$1,863 COL/C \$1,975 D \$2,118 E \$2,262 F \$2,484 G \$2,723 H \$2,979 I \$3,377 J \$3,856 L1 \$2,771 L2 \$3,058	
		Overall	24 1/2	43 1/8	35 3/8			
		Seat	18 1/4	20	19			
		Arm				25 7/8		
		Upholstery		Shipping				
		COM Ydg	3	Ctn Wt	47			
		COL Sq Ft	54	Cu Ft	25			
Two Seat Tandem Guest Chair 	GT4992F <ul style="list-style-type: none"> · upholstered seat · veneer plywood back panel · pre-drilled to accept linking kit, see page GT15 for kit 	Dimensions		D	W	H	COM \$1,640 A \$1,660 B \$1,697 COL/C \$1,760 D \$1,844 E \$1,930 F \$2,060 G \$2,198 H \$2,348 I \$2,580 J \$2,858 L1 \$2,227 L2 \$2,394	
		Overall	24 1/2	43 1/8	35 3/8			
		Seat	19	20	19			
		Arm				25 7/8		
		Upholstery		Shipping				
		COM Ydg	1 3/4	Ctn Wt	44			
		COL Sq Ft	32	Cu Ft	25			

To Order, Specify:

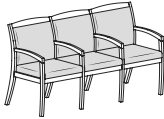
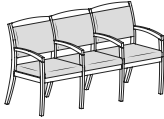
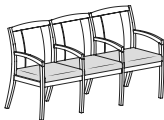
- 1 Model Number
- 2 Wood Species - Maple (M)
- 3 Wood Finish See Wood Finish Options
- 4 Fabric Selection - vendor, pattern and color
Visit www.jsifurniture.com/finishes-and-materials/textiles for our textiles program.
See selection of standard and graded in manufacturers and patterns.
- 5 Optional Black Anti-Microbial Polyurethane Arm Caps
A. Single Seat - add \$122 list
B. Two Seat Tandem - add \$182 list
- 6 Optional Rubber Cushion Nylon Glides - no upcharge

Specifications

- Wood species - Maple.
- Mortise and tenon construction with corner blocks, glue and screws.
- Seat has 1/2" plywood with synthetic sheet webbing and 2 1/2" high density polyurethane foam.
- Wall saver feature.
- Standard with rubber cushion metal glides.

Description	① Model	Specifications	List Price Per Grade																
Two Seat Tandem Guest Chair 	GT4992G · upholstered seat · upholstered plywood back panel with 1/2" high density polyurethane foam · pre-drilled to accept linking kit, see page GT15 for kit	<table border="1"> <thead> <tr> <th>Dimensions</th> <th>D</th> <th>W</th> <th>H</th> </tr> </thead> <tbody> <tr> <td>Overall</td> <td>24 1/2</td> <td>43 1/8</td> <td>35 3/8</td> </tr> <tr> <td>Seat</td> <td>18 1/2</td> <td>20</td> <td>19</td> </tr> <tr> <td>Arm</td> <td></td> <td></td> <td>25 7/8</td> </tr> </tbody> </table>	Dimensions	D	W	H	Overall	24 1/2	43 1/8	35 3/8	Seat	18 1/2	20	19	Arm			25 7/8	COM \$1,756 A \$1,776 B \$1,814 COL/C \$1,878 D \$1,960 E \$2,045 F \$2,176 G \$2,315 H \$2,464 I \$2,696 J \$2,975 L1 \$2,343 L2 \$2,510
		Dimensions	D	W	H														
Overall	24 1/2	43 1/8	35 3/8																
Seat	18 1/2	20	19																
Arm			25 7/8																
<table border="1"> <thead> <tr> <th>Upholstery</th> <th colspan="3">Shipping</th> </tr> </thead> <tbody> <tr> <td>COM Ydg</td> <td>1 3/4</td> <td>Ctn Wt</td> <td>46</td> </tr> <tr> <td>COL Sq Ft</td> <td>32</td> <td>Cu Ft</td> <td>25</td> </tr> </tbody> </table>	Upholstery	Shipping			COM Ydg	1 3/4	Ctn Wt	46	COL Sq Ft	32	Cu Ft	25							
Upholstery	Shipping																		
COM Ydg	1 3/4	Ctn Wt	46																
COL Sq Ft	32	Cu Ft	25																
Two Seat Tandem Guest Chair 	GT4992I · upholstered seat · vertical slat back · steam bent slats · pre-drilled to accept linking kit, see page GT15 for kit	<table border="1"> <thead> <tr> <th>Dimensions</th> <th>D</th> <th>W</th> <th>H</th> </tr> </thead> <tbody> <tr> <td>Overall</td> <td>24 1/2</td> <td>43 1/8</td> <td>35 3/8</td> </tr> <tr> <td>Seat</td> <td>19</td> <td>20</td> <td>19</td> </tr> <tr> <td>Arm</td> <td></td> <td></td> <td>25 7/8</td> </tr> </tbody> </table>	Dimensions	D	W	H	Overall	24 1/2	43 1/8	35 3/8	Seat	19	20	19	Arm			25 7/8	COM \$1,862 A \$1,881 B \$1,919 COL/C \$1,983 D \$2,066 E \$2,151 F \$2,281 G \$2,419 H \$2,569 I \$2,802 J \$3,080 L1 \$2,448 L2 \$2,615
		Dimensions	D	W	H														
Overall	24 1/2	43 1/8	35 3/8																
Seat	19	20	19																
Arm			25 7/8																
<table border="1"> <thead> <tr> <th>Upholstery</th> <th colspan="3">Shipping</th> </tr> </thead> <tbody> <tr> <td>COM Ydg</td> <td>1 3/4</td> <td>Ctn Wt</td> <td>46</td> </tr> <tr> <td>COL Sq Ft</td> <td>32</td> <td>Cu Ft</td> <td>25</td> </tr> </tbody> </table>	Upholstery	Shipping			COM Ydg	1 3/4	Ctn Wt	46	COL Sq Ft	32	Cu Ft	25							
Upholstery	Shipping																		
COM Ydg	1 3/4	Ctn Wt	46																
COL Sq Ft	32	Cu Ft	25																
Two Seat Tandem Guest Chair 	GT4992J · upholstered seat · upholstered vertical slat back · steam bent slats with 3/4" high density polyurethane foam · pre-drilled to accept linking kit, see page GT15 for kit	<table border="1"> <thead> <tr> <th>Dimensions</th> <th>D</th> <th>W</th> <th>H</th> </tr> </thead> <tbody> <tr> <td>Overall</td> <td>24 1/2</td> <td>43 1/8</td> <td>35 3/8</td> </tr> <tr> <td>Seat</td> <td>18 1/4</td> <td>20</td> <td>19</td> </tr> <tr> <td>Arm</td> <td></td> <td></td> <td>25 7/8</td> </tr> </tbody> </table>	Dimensions	D	W	H	Overall	24 1/2	43 1/8	35 3/8	Seat	18 1/4	20	19	Arm			25 7/8	COM \$1,913 A \$1,947 B \$2,012 COL/C \$2,122 D \$2,265 E \$2,409 F \$2,633 G \$2,870 H \$3,126 I \$3,524 J \$4,003 L1 \$2,920 L2 \$3,207
		Dimensions	D	W	H														
Overall	24 1/2	43 1/8	35 3/8																
Seat	18 1/4	20	19																
Arm			25 7/8																
<table border="1"> <thead> <tr> <th>Upholstery</th> <th colspan="3">Shipping</th> </tr> </thead> <tbody> <tr> <td>COM Ydg</td> <td>3</td> <td>Ctn Wt</td> <td>48</td> </tr> <tr> <td>COL Sq Ft</td> <td>54</td> <td>Cu Ft</td> <td>25</td> </tr> </tbody> </table>	Upholstery	Shipping			COM Ydg	3	Ctn Wt	48	COL Sq Ft	54	Cu Ft	25							
Upholstery	Shipping																		
COM Ydg	3	Ctn Wt	48																
COL Sq Ft	54	Cu Ft	25																

GATSBY

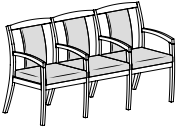
Description	Model	Specifications				List Price Per Grade				
Three Seat Tandem Guest Chair 	GT4993D • upholstered seat • fully upholstered back • solid hardwood back frame with synthetic sheet webbing and 3/4" high density polyurethane foam • pre-drilled to accept linking kit, see page GT15 for kit	Dimensions		D	W	H	COM \$2,509 A \$2,558 B \$2,653 COL/C \$2,819 D \$3,036 E \$3,251 F \$3,585 G \$3,945 H \$4,327 I \$4,924 J \$5,642 L1 \$4,015 L2 \$4,446			
		Overall		24 1/2	64 1/8	35 3/8				
		Seat		18 1/4	20	19				
		Arm		25 7/8						
		Upholstery		Shipping						
		COM Ydg		4 1/2	Ctn Wt	68				
		COL Sq Ft		81	Cu Ft	37				
		Three Seat Tandem Guest Chair 	GT4993E • upholstered seat • 3/4 upholstered back • solid hardwood back frame with synthetic sheet webbing and 3/4" high density polyurethane foam • pre-drilled to accept linking kit, see page GT15 for kit	Dimensions		D		W	H	COM \$2,486 A \$2,535 B \$2,631 COL/C \$2,798 D \$3,013 E \$3,229 F \$3,563 G \$3,922 H \$4,304 I \$4,902 J \$5,621 L1 \$3,994 L2 \$4,424
				Overall		24 1/2		64 1/8	35 3/8	
				Seat		18 1/4		20	19	
Arm				25 7/8						
Upholstery				Shipping						
COM Ydg				4 1/2	Ctn Wt	67				
COL Sq Ft				81	Cu Ft	37				
Three Seat Tandem Guest Chair 	GT4993F • upholstered seat • veneer plywood back panel • pre-drilled to accept linking kit, see page GT15 for kit			Dimensions		D	W	H	COM \$2,261 A \$2,289 B \$2,346 COL/C \$2,442 D \$2,568 E \$2,694 F \$2,889 G \$3,098 H \$3,321 I \$3,670 J \$4,088 L1 \$3,140 L2 \$3,390	
				Overall		24 1/2	64 1/8	35 3/8		
				Seat		19	20	19		
		Arm		25 7/8						
		Upholstery		Shipping						
		COM Ydg		2 5/8	Ctn Wt	62				
		COL Sq Ft		48	Cu Ft	37				

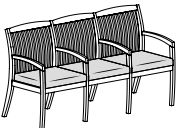
To Order, Specify:

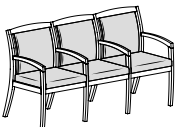
- 1 Model Number
- 2 Wood Species - Maple (M)
- 3 Wood Finish See Wood Finish Options
- 4 Fabric Selection - vendor, pattern and color
 Visit www.jsifurniture.com/finishes-and-materials/textiles for our textiles program.
 See selection of standard and graded in manufacturers and patterns.
- 5 Optional Black Anti-Microbial Polyurethane Arm Caps
 A. Single Seat - add \$122 list
 B. Two Seat Tandem - add \$182 list
- 6 Optional Rubber Cushion Nylon Glides - no upcharge

Specifications

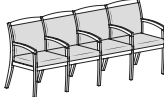

- Wood species - Maple.
- Mortise and tenon construction with corner blocks, glue and screws.
- Seat has 1/2" plywood with synthetic sheet webbing and 2 1/2" high density polyurethane foam.
- Wall saver feature.
- Standard with rubber cushion metal glides.

Description	① Model	Specifications	List Price Per Grade																
Three Seat Tandem Guest Chair 	GT4993G · upholstered seat · upholstered plywood back panel with 1/2" high density polyurethane foam · pre-drilled to accept linking kit, see page GT15 for kit	<table border="1"> <thead> <tr> <th>Dimensions</th> <th>D</th> <th>W</th> <th>H</th> </tr> </thead> <tbody> <tr> <td>Overall</td> <td>24 1/2</td> <td>64 1/8</td> <td>35 3/8</td> </tr> <tr> <td>Seat</td> <td>18 1/2</td> <td>20</td> <td>19</td> </tr> <tr> <td>Arm</td> <td></td> <td></td> <td>25 7/8</td> </tr> </tbody> </table>	Dimensions	D	W	H	Overall	24 1/2	64 1/8	35 3/8	Seat	18 1/2	20	19	Arm			25 7/8	COM \$2,464 A \$2,493 B \$2,549 COL/C \$2,646 D \$2,771 E \$2,897 F \$3,093 G \$3,301 H \$3,524 I \$3,873 J \$4,291 L1 \$3,343 L2 \$3,594
		Dimensions	D	W	H														
Overall	24 1/2	64 1/8	35 3/8																
Seat	18 1/2	20	19																
Arm			25 7/8																
<table border="1"> <thead> <tr> <th>Upholstery</th> <th colspan="3">Shipping</th> </tr> </thead> <tbody> <tr> <td>COM Ydg</td> <td>2 5/8</td> <td>Ctn Wt</td> <td>65</td> </tr> <tr> <td>COL Sq Ft</td> <td>48</td> <td>Cu Ft</td> <td>37</td> </tr> </tbody> </table>	Upholstery	Shipping			COM Ydg	2 5/8	Ctn Wt	65	COL Sq Ft	48	Cu Ft	37							
Upholstery	Shipping																		
COM Ydg	2 5/8	Ctn Wt	65																
COL Sq Ft	48	Cu Ft	37																

Description	① Model	Specifications	List Price Per Grade																
Three Seat Tandem Guest Chair 	GT4993I · upholstered seat · vertical slat back · steam bent slats · pre-drilled to accept linking kit, see page GT15 for kit	<table border="1"> <thead> <tr> <th>Dimensions</th> <th>D</th> <th>W</th> <th>H</th> </tr> </thead> <tbody> <tr> <td>Overall</td> <td>24 1/2</td> <td>64 1/8</td> <td>35 3/8</td> </tr> <tr> <td>Seat</td> <td>19</td> <td>20</td> <td>19</td> </tr> <tr> <td>Arm</td> <td></td> <td></td> <td>25 7/8</td> </tr> </tbody> </table>	Dimensions	D	W	H	Overall	24 1/2	64 1/8	35 3/8	Seat	19	20	19	Arm			25 7/8	COM \$2,581 A \$2,610 B \$2,665 COL/C \$2,763 D \$2,889 E \$3,014 F \$3,210 G \$3,420 H \$3,642 I \$3,992 J \$4,409 L1 \$3,461 L2 \$3,711
		Dimensions	D	W	H														
Overall	24 1/2	64 1/8	35 3/8																
Seat	19	20	19																
Arm			25 7/8																
<table border="1"> <thead> <tr> <th>Upholstery</th> <th colspan="3">Shipping</th> </tr> </thead> <tbody> <tr> <td>COM Ydg</td> <td>2 5/8</td> <td>Ctn Wt</td> <td>65</td> </tr> <tr> <td>COL Sq Ft</td> <td>48</td> <td>Cu Ft</td> <td>37</td> </tr> </tbody> </table>	Upholstery	Shipping			COM Ydg	2 5/8	Ctn Wt	65	COL Sq Ft	48	Cu Ft	37							
Upholstery	Shipping																		
COM Ydg	2 5/8	Ctn Wt	65																
COL Sq Ft	48	Cu Ft	37																

Description	① Model	Specifications	List Price Per Grade																
Three Seat Tandem Guest Chair 	GT4993J · upholstered seat · upholstered vertical slat back · steam bent slats with 3/4" high density polyurethane foam · pre-drilled to accept linking kit, see page GT15 for kit	<table border="1"> <thead> <tr> <th>Dimensions</th> <th>D</th> <th>W</th> <th>H</th> </tr> </thead> <tbody> <tr> <td>Overall</td> <td>24 1/2</td> <td>64 1/8</td> <td>35 3/8</td> </tr> <tr> <td>Seat</td> <td>18 1/4</td> <td>20</td> <td>19</td> </tr> <tr> <td>Arm</td> <td></td> <td></td> <td>25 7/8</td> </tr> </tbody> </table>	Dimensions	D	W	H	Overall	24 1/2	64 1/8	35 3/8	Seat	18 1/4	20	19	Arm			25 7/8	COM \$2,706 A \$2,756 B \$2,851 COL/C \$3,019 D \$3,233 E \$3,450 F \$3,784 G \$4,143 H \$4,525 I \$5,122 J \$5,841 L1 \$4,214 L2 \$4,645
		Dimensions	D	W	H														
Overall	24 1/2	64 1/8	35 3/8																
Seat	18 1/4	20	19																
Arm			25 7/8																
<table border="1"> <thead> <tr> <th>Upholstery</th> <th colspan="3">Shipping</th> </tr> </thead> <tbody> <tr> <td>COM Ydg</td> <td>4 1/2</td> <td>Ctn Wt</td> <td>68</td> </tr> <tr> <td>COL Sq Ft</td> <td>81</td> <td>Cu Ft</td> <td>37</td> </tr> </tbody> </table>	Upholstery	Shipping			COM Ydg	4 1/2	Ctn Wt	68	COL Sq Ft	81	Cu Ft	37							
Upholstery	Shipping																		
COM Ydg	4 1/2	Ctn Wt	68																
COL Sq Ft	81	Cu Ft	37																

GATSBY

Description	Model	Specifications				List Price Per Grade				
Four Seat Tandem Guest Chair 	GT4994D <ul style="list-style-type: none"> · upholstered seat · fully upholstered back · solid hardwood back frame with synthetic sheet webbing and 3/4" high density polyurethane foam · pre-drilled to accept linking kit, see page GT15 for kit 	Dimensions		D	W	H	COM \$3,248 A \$3,312 B \$3,440 COL/C \$3,663 D \$3,950 E \$4,237 F \$4,683 G \$5,161 H \$5,671 I \$6,467 J \$7,426 L1 \$5,257 L2 \$5,831			
		Overall		24 1/2	85 1/8	35 3/8				
		Seat		18 1/4	20	19				
		Arm		25 7/8						
		Upholstery		Shipping						
		COM Ydg		6	Ctn Wt	88				
		COL Sq Ft		108	Cu Ft	49				
		Four Seat Tandem Guest Chair 	GT4994E <ul style="list-style-type: none"> · upholstered seat · 3/4 upholstered back · solid hardwood back frame with synthetic sheet webbing and 3/4" high density polyurethane foam · pre-drilled to accept linking kit, see page GT15 for kit 	Dimensions		D		W	H	COM \$3,219 A \$3,282 B \$3,411 COL/C \$3,633 D \$3,920 E \$4,208 F \$4,654 G \$5,132 H \$5,642 I \$6,439 J \$7,395 L1 \$5,228 L2 \$5,802
				Overall		24 1/2		85 1/8	35 3/8	
				Seat		18 1/4		20	19	
Arm				25 7/8						
Upholstery				Shipping						
COM Ydg				6	Ctn Wt	86				
COL Sq Ft				108	Cu Ft	49				
Four Seat Tandem Guest Chair 	GT4994F <ul style="list-style-type: none"> · upholstered seat · veneer plywood back panel · pre-drilled to accept linking kit, see page GT15 for kit 			Dimensions		D	W	H	COM \$2,877 A \$2,915 B \$2,989 COL/C \$3,119 D \$3,287 E \$3,454 F \$3,715 G \$3,994 H \$4,291 I \$4,754 J \$5,314 L1 \$4,049 L2 \$4,383	
				Overall		24 1/2	85 1/8	35 3/8		
				Seat		19	20	19		
		Arm		25 7/8						
		Upholstery		Shipping						
		COM Ydg		3 1/2	Ctn Wt	79				
		COL Sq Ft		63	Cu Ft	49				



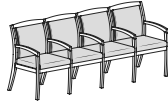
GATSBY

To Order, Specify:

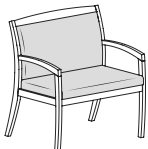
- 1 Model Number
- 2 Wood Species - Maple (M)
- 3 Wood Finish See [Wood Finish Options](#)
- 4 Fabric Selection - vendor, pattern and color
 Visit www.jsifurniture.com/finishes-and-materials/textiles for our textiles program.
 See selection of standard and graded in manufacturers and patterns.
- 5 Optional Black Anti-Microbial Polyurethane Arm Caps
 A. Three Seat Tandem - add \$241 list
 B. Four Seat Tandem - add \$301 list
- 6 Optional Rubber Cushion Nylon Glides - no upcharge

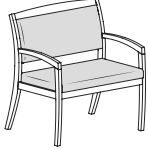
Specifications

- Wood species - Maple.
- Mortise and tenon construction with corner blocks, glue and screws.
- Seat has 1/2" plywood with synthetic sheet webbing and 2 1/2" high density polyurethane foam.
- Wall saver feature.
- Standard with rubber cushion metal glides.

Description	① Model	Specifications	List Price Per Grade																
Four Seat Tandem Guest Chair 	GT4994G · upholstered seat · upholstered plywood back panel with 1/2" high density polyurethane foam · pre-drilled to accept linking kit, see page GT15 for kit	<table border="1"> <thead> <tr> <th>Dimensions</th> <th>D</th> <th>W</th> <th>H</th> </tr> </thead> <tbody> <tr> <td>Overall</td> <td>24 1/2</td> <td>85 1/8</td> <td>35 3/8</td> </tr> <tr> <td>Seat</td> <td>18 1/2</td> <td>20</td> <td>19</td> </tr> <tr> <td>Arm</td> <td></td> <td></td> <td>25 7/8</td> </tr> </tbody> </table>	Dimensions	D	W	H	Overall	24 1/2	85 1/8	35 3/8	Seat	18 1/2	20	19	Arm			25 7/8	COM \$3,164 A \$3,202 B \$3,276 COL/C \$3,406 D \$3,574 E \$3,741 F \$4,002 G \$4,281 H \$4,578 I \$5,041 J \$5,601 L1 \$4,336 L2 \$4,671
		Dimensions	D	W	H														
Overall	24 1/2	85 1/8	35 3/8																
Seat	18 1/2	20	19																
Arm			25 7/8																
<table border="1"> <thead> <tr> <th>Upholstery</th> <th colspan="3">Shipping</th> </tr> </thead> <tbody> <tr> <td>COM Ydg</td> <td>3 1/2</td> <td>Ctn Wt</td> <td>85</td> </tr> <tr> <td>COL Sq Ft</td> <td>63</td> <td>Cu Ft</td> <td>49</td> </tr> </tbody> </table>	Upholstery	Shipping			COM Ydg	3 1/2	Ctn Wt	85	COL Sq Ft	63	Cu Ft	49							
Upholstery	Shipping																		
COM Ydg	3 1/2	Ctn Wt	85																
COL Sq Ft	63	Cu Ft	49																
Four Seat Tandem Guest Chair 	GT4994I · upholstered seat · vertical slat back · steam bent slats · pre-drilled to accept linking kit, see page GT15 for kit	<table border="1"> <thead> <tr> <th>Dimensions</th> <th>D</th> <th>W</th> <th>H</th> </tr> </thead> <tbody> <tr> <td>Overall</td> <td>24 1/2</td> <td>85 1/8</td> <td>35 3/8</td> </tr> <tr> <td>Seat</td> <td>19</td> <td>20</td> <td>19</td> </tr> <tr> <td>Arm</td> <td></td> <td></td> <td>25 7/8</td> </tr> </tbody> </table>	Dimensions	D	W	H	Overall	24 1/2	85 1/8	35 3/8	Seat	19	20	19	Arm			25 7/8	COM \$3,295 A \$3,333 B \$3,408 COL/C \$3,537 D \$3,705 E \$3,872 F \$4,132 G \$4,412 H \$4,709 I \$5,173 J \$5,732 L1 \$4,466 L2 \$4,801
		Dimensions	D	W	H														
Overall	24 1/2	85 1/8	35 3/8																
Seat	19	20	19																
Arm			25 7/8																
<table border="1"> <thead> <tr> <th>Upholstery</th> <th colspan="3">Shipping</th> </tr> </thead> <tbody> <tr> <td>COM Ydg</td> <td>3 1/2</td> <td>Ctn Wt</td> <td>85</td> </tr> <tr> <td>COL Sq Ft</td> <td>63</td> <td>Cu Ft</td> <td>49</td> </tr> </tbody> </table>	Upholstery	Shipping			COM Ydg	3 1/2	Ctn Wt	85	COL Sq Ft	63	Cu Ft	49							
Upholstery	Shipping																		
COM Ydg	3 1/2	Ctn Wt	85																
COL Sq Ft	63	Cu Ft	49																
Four Seat Tandem Guest Chair 	GT4994J · upholstered seat · upholstered vertical slat back · steam bent slats with 3/4" high density polyurethane foam · pre-drilled to accept linking kit, see page GT15 for kit	<table border="1"> <thead> <tr> <th>Dimensions</th> <th>D</th> <th>W</th> <th>H</th> </tr> </thead> <tbody> <tr> <td>Overall</td> <td>24 1/2</td> <td>85 1/8</td> <td>35 3/8</td> </tr> <tr> <td>Seat</td> <td>18 1/4</td> <td>20</td> <td>19</td> </tr> <tr> <td>Arm</td> <td></td> <td></td> <td>25 7/8</td> </tr> </tbody> </table>	Dimensions	D	W	H	Overall	24 1/2	85 1/8	35 3/8	Seat	18 1/4	20	19	Arm			25 7/8	COM \$3,500 A \$3,564 B \$3,693 COL/C \$3,916 D \$4,203 E \$4,490 F \$4,936 G \$5,414 H \$5,924 I \$6,721 J \$7,678 L1 \$5,510 L2 \$6,084
		Dimensions	D	W	H														
Overall	24 1/2	85 1/8	35 3/8																
Seat	18 1/4	20	19																
Arm			25 7/8																
<table border="1"> <thead> <tr> <th>Upholstery</th> <th colspan="3">Shipping</th> </tr> </thead> <tbody> <tr> <td>COM Ydg</td> <td>6</td> <td>Ctn Wt</td> <td>88</td> </tr> <tr> <td>COL Sq Ft</td> <td>108</td> <td>Cu Ft</td> <td>49</td> </tr> </tbody> </table>	Upholstery	Shipping			COM Ydg	6	Ctn Wt	88	COL Sq Ft	108	Cu Ft	49							
Upholstery	Shipping																		
COM Ydg	6	Ctn Wt	88																
COL Sq Ft	108	Cu Ft	49																

GATSBY

Description	1 Model	Specifications				List Price Per Grade																										
30" Bariatric Guest Chair 	GT4951D <ul style="list-style-type: none"> · upholstered seat · fully upholstered back · solid hardwood back frame with synthetic sheet webbing and 3/4" high density polyurethane foam · pre-drilled to accept linking kit, see page GT15 for kit · meets BIFMA x5.11 large occupant standard (253-400 lb individual) 	<table border="1"> <thead> <tr> <th>Dimensions</th> <th>D</th> <th>W</th> <th>H</th> </tr> </thead> <tbody> <tr> <td>Overall</td> <td>24 1/2</td> <td>32 1/8</td> <td>35 3/8</td> </tr> <tr> <td>Seat</td> <td>18 1/4</td> <td>30</td> <td>19</td> </tr> <tr> <td>Arm</td> <td></td> <td></td> <td>25 7/8</td> </tr> </tbody> </table>				Dimensions	D	W	H	Overall	24 1/2	32 1/8	35 3/8	Seat	18 1/4	30	19	Arm			25 7/8	<table border="1"> <thead> <tr> <th>Upholstery</th> <th>Shipping</th> </tr> </thead> <tbody> <tr> <td>COM Ydg</td> <td>2 1/2 Ctn Wt 46</td> </tr> <tr> <td>COL Sq Ft</td> <td>45 Cu Ft 19</td> </tr> </tbody> </table>		Upholstery	Shipping	COM Ydg	2 1/2 Ctn Wt 46	COL Sq Ft	45 Cu Ft 19			
		Dimensions	D	W	H																											
Overall	24 1/2	32 1/8	35 3/8																													
Seat	18 1/4	30	19																													
Arm			25 7/8																													
Upholstery	Shipping																															
COM Ydg	2 1/2 Ctn Wt 46																															
COL Sq Ft	45 Cu Ft 19																															
						<table border="1"> <tbody> <tr><td>COM</td><td>\$1,925</td></tr> <tr><td>A</td><td>\$1,952</td></tr> <tr><td>B</td><td>\$2,004</td></tr> <tr><td>COL/C</td><td>\$2,099</td></tr> <tr><td>D</td><td>\$2,218</td></tr> <tr><td>E</td><td>\$2,339</td></tr> <tr><td>F</td><td>\$2,523</td></tr> <tr><td>G</td><td>\$2,723</td></tr> <tr><td>H</td><td>\$2,935</td></tr> <tr><td>I</td><td>\$3,267</td></tr> <tr><td>J</td><td>\$3,666</td></tr> <tr><td>L1</td><td>\$2,763</td></tr> <tr><td>L2</td><td>\$3,002</td></tr> </tbody> </table>	COM	\$1,925	A	\$1,952	B	\$2,004	COL/C	\$2,099	D	\$2,218	E	\$2,339	F	\$2,523	G	\$2,723	H	\$2,935	I	\$3,267	J	\$3,666	L1	\$2,763	L2	\$3,002
COM	\$1,925																															
A	\$1,952																															
B	\$2,004																															
COL/C	\$2,099																															
D	\$2,218																															
E	\$2,339																															
F	\$2,523																															
G	\$2,723																															
H	\$2,935																															
I	\$3,267																															
J	\$3,666																															
L1	\$2,763																															
L2	\$3,002																															

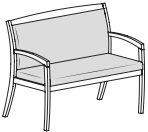
30" Bariatric Guest Chair 	GT4951E <ul style="list-style-type: none"> · upholstered seat · 3/4 upholstered back · solid hardwood back frame with synthetic sheet webbing and 3/4" high density polyurethane foam · pre-drilled to accept linking kit, see page GT15 for kit · meets BIFMA x5.11 large occupant standard (253-400 lb individual) 	<table border="1"> <thead> <tr> <th>Dimensions</th> <th>D</th> <th>W</th> <th>H</th> </tr> </thead> <tbody> <tr> <td>Overall</td> <td>24 1/2</td> <td>32 1/8</td> <td>35 3/8</td> </tr> <tr> <td>Seat</td> <td>18 1/4</td> <td>30</td> <td>19</td> </tr> <tr> <td>Arm</td> <td></td> <td></td> <td>25 7/8</td> </tr> </tbody> </table>				Dimensions	D	W	H	Overall	24 1/2	32 1/8	35 3/8	Seat	18 1/4	30	19	Arm			25 7/8	<table border="1"> <thead> <tr> <th>Upholstery</th> <th>Shipping</th> </tr> </thead> <tbody> <tr> <td>COM Ydg</td> <td>2 1/2 Ctn Wt 45</td> </tr> <tr> <td>COL Sq Ft</td> <td>45 Cu Ft 19</td> </tr> </tbody> </table>		Upholstery	Shipping	COM Ydg	2 1/2 Ctn Wt 45	COL Sq Ft	45 Cu Ft 19			
		Dimensions	D	W	H																											
Overall	24 1/2	32 1/8	35 3/8																													
Seat	18 1/4	30	19																													
Arm			25 7/8																													
Upholstery	Shipping																															
COM Ydg	2 1/2 Ctn Wt 45																															
COL Sq Ft	45 Cu Ft 19																															
						<table border="1"> <tbody> <tr><td>COM</td><td>\$1,886</td></tr> <tr><td>A</td><td>\$1,913</td></tr> <tr><td>B</td><td>\$1,966</td></tr> <tr><td>COL/C</td><td>\$2,060</td></tr> <tr><td>D</td><td>\$2,179</td></tr> <tr><td>E</td><td>\$2,300</td></tr> <tr><td>F</td><td>\$2,484</td></tr> <tr><td>G</td><td>\$2,684</td></tr> <tr><td>H</td><td>\$2,896</td></tr> <tr><td>I</td><td>\$3,228</td></tr> <tr><td>J</td><td>\$3,626</td></tr> <tr><td>L1</td><td>\$2,724</td></tr> <tr><td>L2</td><td>\$2,963</td></tr> </tbody> </table>	COM	\$1,886	A	\$1,913	B	\$1,966	COL/C	\$2,060	D	\$2,179	E	\$2,300	F	\$2,484	G	\$2,684	H	\$2,896	I	\$3,228	J	\$3,626	L1	\$2,724	L2	\$2,963
COM	\$1,886																															
A	\$1,913																															
B	\$1,966																															
COL/C	\$2,060																															
D	\$2,179																															
E	\$2,300																															
F	\$2,484																															
G	\$2,684																															
H	\$2,896																															
I	\$3,228																															
J	\$3,626																															
L1	\$2,724																															
L2	\$2,963																															

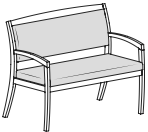
To Order, Specify:

- 1 Model Number
- 2 Wood Species - Maple (M)
- 3 Wood Finish [See Wood Finish Options](#)
- 4 Fabric Selection - vendor, pattern and color
Visit www.jsifurniture.com/finishes-and-materials/textiles for our textiles program. See selection of standard and graded in manufacturers and patterns.
- 5 Optional Black Anti-Microbial Polyurethane Arm Caps
A. Single Seat - add \$122 list
B. Four Seat Tandem - add \$301 list
- 6 Optional Rubber Cushion Nylon Glides - no upcharge

Specifications

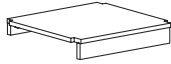
- Wood species - Maple.
- Mortise and tenon construction with corner blocks, glue and screws.
- Seat has 1/2" plywood with synthetic sheet webbing and 2 1/2" high density polyurethane foam.
- Wall saver feature.
- Standard with rubber cushion metal glides.

Description	① Model	Specifications				List Price Per Grade		
41" Bariatric Guest Chair 	GT4952D · upholstered seat · fully upholstered back · solid hardwood back frame with synthetic sheet webbing and ¾" high density polyurethane foam · pre-drilled to accept linking kit, see page GT15 for kit · meets BIFMA x5.11 large occupant standard (253-400 lb individual)	Dimensions		D	W	H	COM \$2,108 A \$2,136 B \$2,188 COL/C \$2,281 D \$2,400 E \$2,521 F \$2,705 G \$2,905 H \$3,118 I \$3,450 J \$3,848 L1 \$2,945 L2 \$3,184	
		Overall	24 ½	43 ⅛	35 ⅜			
		Seat	18 ¼	41	19			
		Arm				25 ⅞		
		Upholstery		Shipping				
		COM Ydg	2 ½	Ctn Wt	56			
		COL Sq Ft	45	Cu Ft	25			

41" Bariatric Guest Chair 	GT4952E · upholstered seat · ¾ upholstered back · solid hardwood back frame with synthetic sheet webbing and ¾" high density polyurethane foam · pre-drilled to accept linking kit, see page GT15 for kit · meets BIFMA x5.11 large occupant standard (253-400 lb individual)	Dimensions		D	W	H	COM \$2,070 A \$2,099 B \$2,150 COL/C \$2,243 D \$2,363 E \$2,483 F \$2,669 G \$2,868 H \$3,080 I \$3,412 J \$3,810 L1 \$2,907 L2 \$3,146	
		Overall	24 ½	43 ⅛	35 ⅜			
		Seat	18 ¼	41	19			
		Arm				25 ⅞		
		Upholstery		Shipping				
		COM Ydg	2 ½	Ctn Wt	55			
		COL Sq Ft	45	Cu Ft	25			

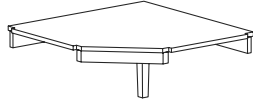
GATSBY

Description	D	W	H	CTN WT	CU FT	① Model	List Price
20" Center Linking Table	20 3/8	21 1/8	3 3/8	19	2	GT2021LT	\$917



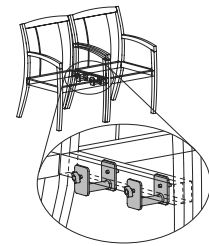
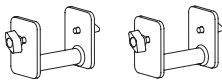
- attaches between single, bariatric or tandem units
- linking hardware included
- no tools required for installation
- ships KD

Corner Linking Table	31	31	16 7/8	35	4	GT3131CT	\$1,122
----------------------	----	----	--------	----	---	----------	---------



- attaches between single, bariatric or tandem units
- linking hardware included
- no tools required for installation
- ships KD

Chair Linking Kit						GT49BRKT	\$155
-------------------	--	--	--	--	--	----------	-------



- kit contains two brackets and four thumb screws
- no tools required
- one kit required for each two guest chairs, bariatric chairs or tandem models that are to be linked together
- three models linked together require two kits, four models linked together require three kits, etc.

To Order, Specify:

- ① Model Number
- ② Wood Species - Maple (M)
- ③ Wood Finish [See Wood Finish Options](#)
- ④ Fabric Selection - vendor, pattern and color
Visit www.jsifurniture.com/finishes-and-materials/textiles for our textiles program. See selection of standard and graded in manufacturers and patterns.
- ⑤ Optional Black Anti-Microbial Polyurethane Arm Caps - add \$122 list
- ⑥ Optional Rubber Cushion Nylon Glides - no upcharge

Specifications

- Wood species - Maple.
- Mortise and tenon construction with corner blocks, glue and screws.
- Seat has 1/2" plywood with synthetic sheet webbing and 2 1/2" high density polyurethane foam.
- Wall saver feature.
- Standard with rubber cushion metal glides.

Harbor Order Check List:



Specify:

- 1. Model Number
- 2. Wood Species - Maple (M)
- 3. Wood Base/Arm Detail Finish
- 4. Fabric Selection - vendor, pattern and color
- 5. Base Selection - wood base standard; specify wood finish
 - A. Black Polyurethane Base - no upcharge
 - B. Black Jury Base - add \$203 list
- 6. Optional Plastic Bumper Guard - add \$25 list

Example:

HB2905 (model #)	M (wood species)	HRV (finish) wood base/arm detail	MOMENTUM (fabric vendor)	VOX (pattern name)	MYSTIC (pattern color)
----------------------------	----------------------------	--	------------------------------------	------------------------------	----------------------------------

1. Model Number

2. Wood Species - Maple (M)

3. Wood Base/Arm Detail Finish Options:

ALM Ale Medium	MCH Mocha
BBM Bourbon Medium	CPI Pinnacle Walnut Coordinate
CBZ Brazilwood Coordinate	PRL Praline
BRM Brighton Medium	RAVC Raven Coordinate
BUT Butterscotch	SABC Sable Coordinate
CNDC Cinder Coordinate	SADC Saddle Coordinate
CLA Classic	SIE Sienna
CLL Collectors	CST Studio Teak Coordinate
EGRC Egret Coordinate	TRF Truffle
ESP Espresso	UMB Umber
FAWC Fawn Coordinate	VALC Valley Coordinate
FLX Flax	VEN Venetian
CGR Graphite Coordinate	CWE Weathered Ash Coordinate
HRV Harvest	
CKC Khaki Coordinate	
MINC Mineral Coordinate	

4. Fabric Selection - Please supply the following:
Fabric vendor/Pattern name/Pattern color

For a complete list of JSI Standard and Graded-In Textiles click [here](#)

When specifying contrasting upholstery, indicate clearly which upholstery is to be applied to the seat, back and arms. Use higher grade pricing.

- Indicate direction of fabric - Railroaded or Up the Roll
- Please provide illustration, if available

All COM orders must include the following:

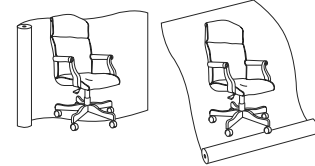
- Vendor's name, pattern name and color
- Sample of the fabric attached to order
- Model numbers of items for fabric application
- Special application instructions (e.g., all stripes will be applied front to back unless specified otherwise)
- Customer and purchase order number

Ship prepaid COM material to:

JSI
Attn: COM Department
201 East Martin Street
Receiving B, Dock 71
Orleans, IN 47452

Application of fabric:

Railroaded Up the Roll



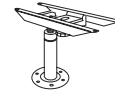
All COM orders will ship at standard lead time from receipt of COM except for orders requiring special custom matched finishes.

5. Base Selection - wood base standard; specify wood finish

- A. Black polyurethane base - no upcharge
- B. Black jury base - add \$203 list





Pneumatic lift - NOT self-centering - Standard



Mechanical self-centering lift - MUST BE SPECIFIED

6. Optional Plastic Bumper Guard - add \$25 list

Description	① Model	Specifications			List Price Per Grade	
Executive Swivel 	HB2905 <ul style="list-style-type: none"> · upholstered open arms · overall height range is 45 ½ - 50 ½ · seat height range is 19 - 24 · arm height range is 27 ½ - 32 ½ 	Dimensions	D	W	H	COM \$1,998
		Overall	29	26 ½	50 ½	A \$2,030
		Seat	19 ½	20 ¾	24	B \$2,101
		Arm			32 ½	COL/C \$2,221
		Upholstery	Shipping			D \$2,371
		COM Ydg	2 ¾	Ctn Wt	50	E \$2,523
		COL Sq Ft	50	Cu Ft	19	F \$2,684
						G \$2,915
						H \$3,160
						I \$3,542
						J \$4,000
						L1 \$2,961
						L2 \$3,206

Management Swivel 	HB2900 <ul style="list-style-type: none"> · upholstered open arms · overall height range is 39 - 44 · seat height range is 19 - 24 · arm height range is 27 ½ - 32 ½ 	Dimensions	D	W	H	COM \$1,894
		Overall	28 ½	26 ½	44	A \$1,925
		Seat	19 ½	20 ¾	24	B \$1,987
		Arm			32 ½	COL/C \$2,096
		Upholstery	Shipping			D \$2,235
		COM Ydg	2 ½	Ctn Wt	46	E \$2,372
		COL Sq Ft	45	Cu Ft	14	F \$2,520
						G \$2,730
						H \$2,950
						I \$3,299
						J \$3,717
						L1 \$2,771
						L2 \$2,995

To Order, Specify:

- ① Model Number
- ② Wood Species - Maple (M)
- ③ Wood Base/Arm Detail Finish [See Wood Base/Arm Detail Finish Options](#)
- ④ Fabric Selection - vendor, pattern and color
 Visit www.jsifurniture.com/finishes-and-materials/textiles for our textiles program.
 See selection of standard and graded in manufacturers and patterns.
- ⑤ Base Selection - wood base standard; specify wood finish
 - A. Black Polyurethane Base - no upcharge
 - B. Black Jury Base - add \$203 list
 (self-centering manual available - specify when ordering)
- ⑥ Optional Plastic Bumper Guard - add \$25 list

Specifications

- Wood species - Maple.
- Seat and back are 3" high density polyurethane foam.
- Swivel models revolve, adjusts for height and tension, have swivel tilt, a pneumatic lift with wood base and black dual wheel casters.
- Arms have ½" polyurethane foam.
- Frame construction consist of one piece molded plywood shell.

Harbor Order Check List:



Specify:

- 1. Model Number
- 2. Wood Species - Maple (M)
- 3. Wood Finish
- 4. Fabric Selection - vendor, pattern and color
- 5. Optional Casters - add \$123 list; specify color
- 6. Optional Rubber Cushion Nylon Glides - no upcharge

Example:

HB2901 | **M** | **HRV** | **MOMENTUM** | **VOX** | **MYSTIC**
 (model #) | (wood species) | (finish) | (fabric vendor) | (pattern name) | (pattern color)

1. Model Number

2. Wood Species - Maple (M)

3. Wood Finish Options:

ALM	Ale Medium	MCH	Mocha
BBM	Bourbon Medium	CPI	Pinnacle Walnut
CBZ	Brazilwood Coordinate		Coordinate
BRM	Brighton Medium	PRL	Praline
BUT	Butterscotch	RAVC	Raven Coordinate
CNDC	Cinder Coordinate	SABC	Sable Coordinate
CLA	Classic	SADC	Saddle Coordinate
CLL	Collectors	SIE	Sienna
EGRC	Egret Coordinate	CST	Studio Teak Coordinate
ESP	Espresso	TRF	Truffle
FAWC	Fawn Coordinate	UMB	Umber
FLX	Flax	VALC	Valley Coordinate
CGR	Graphite Coordinate	VEN	Venetian
HRV	Harvest	CWE	Weathered Ash
CKC	Khaki Coordinate		Coordinate
MINC	Mineral Coordinate		

4. Fabric Selection - Please supply the following:

Fabric vendor/Pattern name/Pattern color

For a complete list of JSI Standard and Graded-In Textiles click [here](#)

When specifying contrasting upholstery, indicate clearly which upholstery is to be applied to the seat, back and arms. Use higher grade pricing.

- Indicate direction of fabric - Railroaded or Up the Roll
- Please provide illustration, if available

All COM orders must include the following:

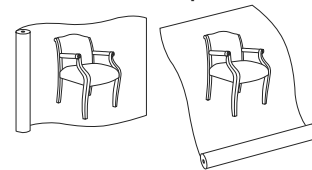
- Vendor's name, pattern name and color
- Sample of the fabric attached to order
- Model numbers of items for fabric application
- Special application instructions (e.g., all stripes will be applied front to back unless specified otherwise)
- Customer and purchase order number

Ship prepaid COM material to:

JSI
 Attn: COM Department
 201 East Martin Street
 Receiving B, Dock 71
 Orleans, IN 47452

Application of fabric:

Railroaded Up the Roll

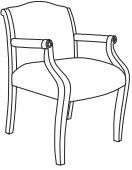


All COM orders will ship at standard lead time from receipt of COM except for orders requiring special custom matched finishes.

5. Optional Casters - add \$123 list; specify color.

- Color:**
- Black
 - Antique Brass

6. Optional Rubber Cushion Nylon Glides - no upcharge

Description	① Model	Specifications				List Price Per Grade	
Guest Chair 	HB2901	Dimensions				COM	\$1,419
		Overall	26	24 ¾	34	A	\$1,446
		Seat	18 ½	20	19	B	\$1,493
		Arm			26 ½	COL/C	\$1,582
		Upholstery		Shipping		D	\$1,693
		COM Ydg	2	Ctn Wt	40	E	\$1,803
		COL Sq Ft	36	Cu Ft	16	F	\$1,921
						G	\$2,087
						H	\$2,266
						I	\$2,546
				J	\$2,879		
				L1	\$2,121		
				L2	\$2,300		

To Order, Specify:

- ① Model Number
- ② Wood Species - Maple (M)
- ③ Wood Finish [See Wood Finish Options](#)
- ④ Fabric Selection - vendor, pattern and color
 Visit www.jsifurniture.com/finishes-and-materials/textiles for our textiles program.
 See selection of standard and graded in manufacturers and patterns.
- ⑤ Optional Casters - add \$123 list; specify color
- ⑥ Optional Rubber Cushion Nylon Glides - no upcharge

Specifications

- Wood species - Maple.
- Seat has synthetic sheet webbing and 2" polyurethane foam.
- Back has polypropylene webbing and 3 ½" polyurethane foam.
- Spiral grooved hardwood dowels with corner blocks, glue and screws.
- Standard with rubber cushion metal glides.

Harbor Lounge Order Check List:



Specify:

- 1. Model Number
- 2. Wood Species - Maple (M)
- 3. Wood Finish
- 4. Fabric Selection - vendor, pattern and color
- 5. Optional Rubber Cushion Nylon Glides - no upcharge

Example:

HD2911 | M | HRV | MOMENTUM | VOX | MYSTIC
 (model #) | (wood species) | (finish) | (fabric vendor) | (pattern name) | (pattern color)

1. Model Number

2. Wood Species - Maple (M)

3. Wood Finish Options:

ALM	Ale Medium	HRV	Harvest
CAL	Ale Light Coordinate	CKC	Khaki Coordinate
BBM	Bourbon Medium	MINC	Mineral Coordinate
CBZ	Brazilwood Coordinate	MCH	Mocha
BARC	Barrel Coordinate	CPI	Pinnacle Walnut Coordinate
CBO	Bourbon Light Coordinate	PRL	Praline
CBG	Brighton Light Coordinate	RAVC	Raven Coordinate
BRM	Brighton Medium	SABC	Sable Coordinate
BUT	Butterscotch	SIE	Sienna
CNDC	Cinder Coordinate	CST	Studio Teak Coordinate
CLA	Classic	TRF	Truffle
CLL	Collectors	UMB	Umber
EGRC	Egret Coordinate	VALC	Valley Coordinate
ESP	Espresso	VEN	Venetian
FAWC	Fawn Coordinate	CWE	Weathered Ash Coordinate
FLX	Flax		
CGR	Graphite Coordinate		

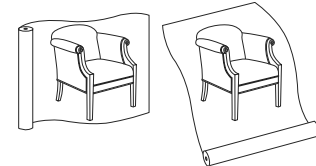
All COM orders must include the following:

- Vendor's name, pattern name and color
- Sample of the fabric attached to order
- Model numbers of items for fabric application
- Special application instructions (e.g., all stripes will be applied front to back unless specified otherwise)
- Customer and purchase order number

Ship prepaid COM material to:

JSI
 Attn: COM Department
 201 East Martin Street
 Receiving B, Dock 71
 Orleans, IN 47452

Application of fabric:
 Railroaded Up the Roll



All COM orders will ship at standard lead time from receipt of COM except for orders requiring special custom matched finishes.


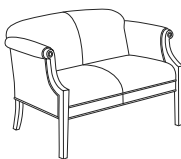
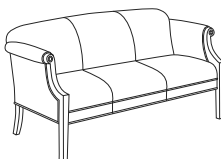
4. Fabric Selection - Please supply the following:
 Fabric vendor/Pattern name/Pattern color

For a complete list of JSI Standard and Graded-In Textiles click [here](#)

When specifying contrasting upholstery, indicate clearly which upholstery is to be applied to the seat and back. Use higher grade pricing.

- Indicate direction of fabric - Railroaded or Up the Roll
- Please provide illustration, if available

5. Optional Rubber Cushion Nylon Glides - no upcharge

Description	Model	Specifications			List Price Per Grade	
Club Chair 	HB2911	Dimensions	D	W	H	COM \$2,262
		Overall	30 1/2	28 1/2	34 1/2	A \$2,339
		Seat	19 1/4	18 1/2	17 1/2	B \$2,486
		Arm			29	COL/C \$2,745
		Upholstery	Shipping			D \$3,079
		COM Ydg	6	Ctn Wt	70	E \$3,413
		COL Sq Ft	120	Cu Ft	31	F \$3,764
						G \$4,264
						H \$4,799
						I \$5,633
				J \$6,634		
				L1 \$4,632		
				L2 \$5,234		
Loveseat 	HB2912	Dimensions	D	W	H	COM \$2,905
		Overall	30 1/2	52 1/2	34 1/2	A \$3,012
		Seat	19 1/4	42 1/2	17 1/2	B \$3,221
		Arm			29	COL/C \$3,587
		Upholstery	Shipping			D \$4,061
		COM Ydg	8 1/2	Ctn Wt	95	E \$4,533
		COL Sq Ft	170	Cu Ft	51	F \$5,034
						G \$5,743
						H \$6,497
						I \$7,677
				J \$9,097		
				L1 \$6,260		
				L2 \$7,110		
Sofa 	HB2913	Dimensions	D	W	H	COM \$3,705
		Overall	30 1/2	76 1/2	34 1/2	A \$3,841
		Seat	19 1/4	66 1/2	17 1/2	B \$4,114
		Arm			29	COL/C \$4,589
		Upholstery	Shipping			D \$5,200
		COM Ydg	11	Ctn Wt	125	E \$5,814
		COL Sq Ft	220	Cu Ft	74	F \$6,459
						G \$7,375
						H \$8,353
						I \$9,884
				J \$11,719		
				L1 \$8,049		
				L2 \$9,148		

To Order, Specify:

- 1 Model Number
- 2 Wood Species - Maple (M)
- 3 Wood Finish See [Wood Finish Options](#)
- 4 Fabric Selection - vendor, pattern and color
Visit www.jsifurniture.com/finishes-and-materials/textiles for our textiles program. See selection of standard and graded in manufacturers and patterns.
- 5 Optional Rubber Cushion Nylon Glides - no upcharge

Specifications

- Wood species - Maple.
- Seat has synthetic sheet webbing with cross strap reinforcement and 3 1/2" polyurethane high density foam.
- Back has synthetic sheet webbing and 3 1/2" polyurethane high density foam.
- Arms have 1/2" polyurethane foam.
- Spiral grooved hardwood dowels with corner blocks, glue and screws.
- Standard with rubber cushion metal glides.

Hoopz Order Check List:



Specify:

- 1. Model Number
- 2. Seat and Back Plastic Color
- 3. Fabric Selections - vendor, pattern and color
- 4. Metal Frame Color
 - A. Tier 1 - no upcharge
 - B. Tier 2 - add \$150 list
 - C. Tier 3 - add \$170 list

Example:

HZ143PA | **DGM** | **CHR**
 (model #) | (seat & back color) | (metal frame color)

1. Model Number

All COM orders will ship at standard lead time from receipt of COM except for orders requiring special custom matched finishes.

2. Seat and Back Plastic Color Options:

(seat and back will be the same color)

- BBM Balanced Beige
- DGM Dancing Green
- EWM Extra White
- HSM Heartstone Gray
- SRM Stop Red
- TBM Tricorn Black

4. Metal Frame Color

Tier 1:

MBK Matte Black CHR Chrome

Tier 2: add \$150 list

ABZ Aged Bronze PEW Pewter
 ASL Arctic Silver SBZ Soft Bronze
 BWH Bright White SNK Soft Nickel
 GLD Gold

Tier 3: add \$170 list

BRD Beige Red (RAL3012) SAL Salmon Orange (RAL2012)
 CAR Carmine Red (RAL3002) SPB Sapphire Blue (RAL4007)
 COP Copper Brown (RAL8004) SGR Signal Green (RAL6032)
 HYL Honey Yellow (RAL1005) SIG Signal Orange (RAL2010)
 LGR Leaf Green (RAL6002) SGY Silk Grey (RAL7044)
 MHB Mahogany Brown (RAL8016) SKY Sky Blue (RAL5015)
 MTQ Mint Turquoise (RAL6033) TBL Traffic Blue (RAL5017)
 OGR Olive Green (RAL6003) TRD Traffic Red (RAL3020)
 PPV Purple Violet (RAL4007) TQP Turquoise Pastel (RAL6034)
 QZG Quartz Grey (RAL7039) ZYL Zinc Yellow (RAL1018)

3. Fabric Selection - Please supply the following:

Fabric vendor/Pattern name/Pattern color

For a complete list of JSI Standard and Graded-In Textiles click here

When specifying contrasting upholstery, indicate clearly which upholstery is to be applied to the seat and back. Use higher grade pricing.

- Indicate direction of fabric - Railroaded or Up the Roll
- Please provide illustration, if available

All COM orders must include the following:

- Vendor's name, pattern name and color
- Sample of the fabric attached to order
- Model numbers of items for fabric application
- Special application instructions (e.g., all stripes will be applied front to back unless specified otherwise)
- Customer and purchase order number

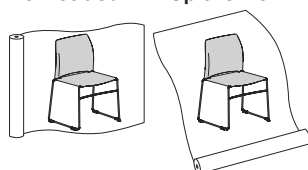
Matte Black, Pewter or Aged Bronze metal frame dictates black glide sleeve.

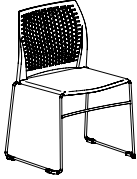
All other metal frame finishes dictate clear glide sleeve.

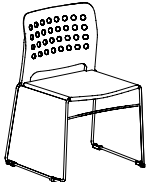
Ship prepaid COM material to:


JSI
 Attn: COM Dept
 201 East Martin Street
 Receiving B, Dock 71
 Orleans, IN 47452

Application of fabric:
 Railroaded Up the Roll



Description	① Model	Specifications			List Price Per Grade	
Guest Chair, Plastic Perforated Back - Plastic Seat 	HZ143PA · plastic seat · plastic, perforated back · metal frame · load capacity meets or exceeds BIFMA requirements · integrated passive linking glide · stacks 10 high on the floor or 45 on the cart	Dimensions	D	W	H	\$333
		Overall	22	21 ¾	33	
		Seat	16 ¾	17 ½	18	
		Upholstery	Shipping			
			Ctn Wt	13		
			Cu Ft	12		

Description	① Model	Specifications			List Price Per Grade	
Guest Chair, Plastic Back with Holes - Plastic Seat 	HZ143HA · plastic seat · plastic, holes back · metal frame · load capacity meets or exceeds BIFMA requirements · integrated passive linking glide · stacks 10 high on the floor or 45 on the cart	Dimensions	D	W	H	\$333
		Overall	22	21 ¾	33	
		Seat	16 ¾	17 ½	18	
		Upholstery	Shipping			
			Ctn Wt	13		
			Cu Ft	12		

Description	① Model	Specifications			List Price Per Grade		
Guest Chair, Plastic Perforated Back - Upholstered Seat 	HZ143PC · upholstered seat · plastic, perforated back · metal frame · load capacity meets or exceeds BIFMA requirements · integrated passive linking glide · stacks 10 high on the floor or 10 on the cart	Dimensions	D	W	H	COM	\$507
		Overall	22	21 ¾	33	A	\$516
		Seat	16 ¾	17 ½	18	B	\$535
		Upholstery	Shipping			COL/C	\$566
		COM Ydg	¾	Ctn Wt	13	D	\$607
		COL Sq Ft	15	Cu Ft	12	E	\$648
						F	\$713
						G	\$779
						H	\$854
						I	\$968
						J	\$1,103
						L1	\$796
						L2	\$875

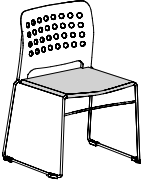
To Order, Specify:

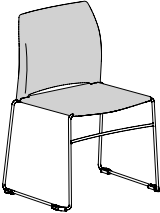
- ① Model Number
- ② Seat and Back Plastic Color [See Seat and Back Plastic Color Options](#)
- ③ Fabric Selection - vendor, pattern and color
 Visit www.jsifurniture.com/finishes-and-materials/textiles for our textiles program.
 See selection of standard and graded in manufacturers and patterns.
- ④ Metal Frame Color [See Metal Frame Tier/Color Options](#)

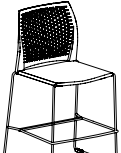
Specifications


- Metal frame.
- Load capacity meets or exceeds BIFMA requirements.
- Integrated passive linking glide.


HOOPZ


Description	Model	Specifications	List Price Per Grade																																						
Guest Chair, Plastic Back with Holes - Upholstered Seat 	HZ143HC <ul style="list-style-type: none"> · upholstered seat · plastic, holes back · metal frame · load capacity meets or exceeds BIFMA requirements · integrated passive linking glide · stacks 10 high on the floor or 10 on the cart 	<table border="1"> <thead> <tr> <th>Dimensions</th> <th>D</th> <th>W</th> <th>H</th> </tr> </thead> <tbody> <tr> <td>Overall</td> <td>22</td> <td>21 ¾</td> <td>33</td> </tr> <tr> <td>Seat</td> <td>16 ¾</td> <td>17 ½</td> <td>18</td> </tr> </tbody> </table>	Dimensions	D	W	H	Overall	22	21 ¾	33	Seat	16 ¾	17 ½	18	<table border="1"> <tbody> <tr> <td>COM</td> <td>\$507</td> </tr> <tr> <td>A</td> <td>\$516</td> </tr> <tr> <td>B</td> <td>\$535</td> </tr> <tr> <td>COL/C</td> <td>\$566</td> </tr> <tr> <td>D</td> <td>\$607</td> </tr> <tr> <td>E</td> <td>\$648</td> </tr> <tr> <td>F</td> <td>\$713</td> </tr> <tr> <td>G</td> <td>\$779</td> </tr> <tr> <td>H</td> <td>\$854</td> </tr> <tr> <td>I</td> <td>\$968</td> </tr> <tr> <td>J</td> <td>\$1,103</td> </tr> <tr> <td>L1</td> <td>\$796</td> </tr> <tr> <td>L2</td> <td>\$875</td> </tr> </tbody> </table>	COM	\$507	A	\$516	B	\$535	COL/C	\$566	D	\$607	E	\$648	F	\$713	G	\$779	H	\$854	I	\$968	J	\$1,103	L1	\$796	L2	\$875
		Dimensions	D	W	H																																				
Overall	22	21 ¾	33																																						
Seat	16 ¾	17 ½	18																																						
COM	\$507																																								
A	\$516																																								
B	\$535																																								
COL/C	\$566																																								
D	\$607																																								
E	\$648																																								
F	\$713																																								
G	\$779																																								
H	\$854																																								
I	\$968																																								
J	\$1,103																																								
L1	\$796																																								
L2	\$875																																								
<table border="1"> <thead> <tr> <th>Upholstery</th> <th colspan="2">Shipping</th> </tr> </thead> <tbody> <tr> <td>COM Ydg</td> <td>¾</td> <td>Ctn Wt 13</td> </tr> <tr> <td>COL Sq Ft</td> <td>15</td> <td>Cu Ft 12</td> </tr> </tbody> </table>	Upholstery	Shipping		COM Ydg	¾	Ctn Wt 13	COL Sq Ft	15	Cu Ft 12																																
Upholstery	Shipping																																								
COM Ydg	¾	Ctn Wt 13																																							
COL Sq Ft	15	Cu Ft 12																																							

Guest Chair, Fully Upholstered 	HZ143D <ul style="list-style-type: none"> · upholstered seat · fully upholstered back · metal frame · load capacity meets or exceeds BIFMA requirements · integrated passive linking glide · stacks 6 high on the floor or 10 on the cart 	<table border="1"> <thead> <tr> <th>Dimensions</th> <th>D</th> <th>W</th> <th>H</th> </tr> </thead> <tbody> <tr> <td>Overall</td> <td>22</td> <td>21 ¾</td> <td>33</td> </tr> <tr> <td>Seat</td> <td>16 ¾</td> <td>17 ½</td> <td>18</td> </tr> </tbody> </table>	Dimensions	D	W	H	Overall	22	21 ¾	33	Seat	16 ¾	17 ½	18	<table border="1"> <tbody> <tr> <td>COM</td> <td>\$608</td> </tr> <tr> <td>A</td> <td>\$624</td> </tr> <tr> <td>B</td> <td>\$654</td> </tr> <tr> <td>COL/C</td> <td>\$707</td> </tr> <tr> <td>D</td> <td>\$775</td> </tr> <tr> <td>E</td> <td>\$845</td> </tr> <tr> <td>F</td> <td>\$951</td> </tr> <tr> <td>G</td> <td>\$1,065</td> </tr> <tr> <td>H</td> <td>\$1,184</td> </tr> <tr> <td>I</td> <td>\$1,375</td> </tr> <tr> <td>J</td> <td>\$1,603</td> </tr> <tr> <td>L1</td> <td>\$1,087</td> </tr> <tr> <td>L2</td> <td>\$1,223</td> </tr> </tbody> </table>	COM	\$608	A	\$624	B	\$654	COL/C	\$707	D	\$775	E	\$845	F	\$951	G	\$1,065	H	\$1,184	I	\$1,375	J	\$1,603	L1	\$1,087	L2	\$1,223
		Dimensions	D	W	H																																				
Overall	22	21 ¾	33																																						
Seat	16 ¾	17 ½	18																																						
COM	\$608																																								
A	\$624																																								
B	\$654																																								
COL/C	\$707																																								
D	\$775																																								
E	\$845																																								
F	\$951																																								
G	\$1,065																																								
H	\$1,184																																								
I	\$1,375																																								
J	\$1,603																																								
L1	\$1,087																																								
L2	\$1,223																																								
<table border="1"> <thead> <tr> <th>Upholstery</th> <th colspan="2">Shipping</th> </tr> </thead> <tbody> <tr> <td>COM Ydg</td> <td>1 ¼</td> <td>Ctn Wt 15</td> </tr> <tr> <td>COL Sq Ft</td> <td>23</td> <td>Cu Ft 12</td> </tr> </tbody> </table>	Upholstery	Shipping		COM Ydg	1 ¼	Ctn Wt 15	COL Sq Ft	23	Cu Ft 12																																
Upholstery	Shipping																																								
COM Ydg	1 ¼	Ctn Wt 15																																							
COL Sq Ft	23	Cu Ft 12																																							

39¾" Counter Height Stool, Plastic Perforated Back - Plastic Seat 	HZ144PA <ul style="list-style-type: none"> · plastic seat · plastic, perforated back · metal frame · load capacity meets or exceeds BIFMA requirements · integrated passive linking glide 	<table border="1"> <thead> <tr> <th>Dimensions</th> <th>D</th> <th>W</th> <th>H</th> </tr> </thead> <tbody> <tr> <td>Overall</td> <td>23</td> <td>21 ¾</td> <td>39 ¾</td> </tr> <tr> <td>Seat</td> <td>16 ¾</td> <td>17 ½</td> <td>24 ¾</td> </tr> </tbody> </table>	Dimensions	D	W	H	Overall	23	21 ¾	39 ¾	Seat	16 ¾	17 ½	24 ¾	\$655
		Dimensions	D	W	H										
Overall	23	21 ¾	39 ¾												
Seat	16 ¾	17 ½	24 ¾												
<table border="1"> <thead> <tr> <th>Upholstery</th> <th colspan="2">Shipping</th> </tr> </thead> <tbody> <tr> <td></td> <td>Ctn Wt</td> <td>19</td> </tr> <tr> <td></td> <td>Cu Ft</td> <td>14</td> </tr> </tbody> </table>	Upholstery	Shipping			Ctn Wt	19		Cu Ft	14						
Upholstery	Shipping														
	Ctn Wt	19													
	Cu Ft	14													

39¾" Counter Height Stool, Plastic Back with Holes - Plastic Seat 	HZ144HA <ul style="list-style-type: none"> · plastic seat · plastic, holes back · metal frame · load capacity meets or exceeds BIFMA requirements · integrated passive linking glide 	<table border="1"> <thead> <tr> <th>Dimensions</th> <th>D</th> <th>W</th> <th>H</th> </tr> </thead> <tbody> <tr> <td>Overall</td> <td>23</td> <td>21 ¾</td> <td>39 ¾</td> </tr> <tr> <td>Seat</td> <td>16 ¾</td> <td>17 ½</td> <td>24 ¾</td> </tr> </tbody> </table>	Dimensions	D	W	H	Overall	23	21 ¾	39 ¾	Seat	16 ¾	17 ½	24 ¾	\$655
		Dimensions	D	W	H										
Overall	23	21 ¾	39 ¾												
Seat	16 ¾	17 ½	24 ¾												
<table border="1"> <thead> <tr> <th>Upholstery</th> <th colspan="2">Shipping</th> </tr> </thead> <tbody> <tr> <td></td> <td>Ctn Wt</td> <td>19</td> </tr> <tr> <td></td> <td>Cu Ft</td> <td>14</td> </tr> </tbody> </table>	Upholstery	Shipping			Ctn Wt	19		Cu Ft	14						
Upholstery	Shipping														
	Ctn Wt	19													
	Cu Ft	14													

Description	① Model	Specifications				List Price Per Grade	
39¾" h Counter Height Stool, Plastic Perforated Back - Upholstered Seat 	HZ144PC · upholstered seat · plastic, perforated back · metal frame · load capacity meets or exceeds BIFMA requirements · integrated passive linking glide	Dimensions		D	W	H	COM \$856
		Overall	23	21 ¾	39 ¾	A \$866	
		Seat	16 ¾	17 ½	24 ¾	B \$883	COL/C \$916
		Upholstery		Shipping		D \$957	E \$998
		COM Ydg	¾	Ctn Wt	19	F \$1,060	G \$1,130
		COL Sq Ft	15	Cu Ft	14	H \$1,202	I \$1,315
						J \$1,452	L1 \$1,142
						L2 \$1,225	

Description	① Model	Specifications				List Price Per Grade	
39¾" h Counter Height Stool, Plastic Back with Holes - Upholstered Seat 	HZ144HC · upholstered seat · plastic, holes back · metal frame · load capacity meets or exceeds BIFMA requirements · integrated passive linking glide	Dimensions		D	W	H	COM \$856
		Overall	23	21 ¾	39 ¾	A \$866	
		Seat	16 ¾	17 ½	24 ¾	B \$883	COL/C \$916
		Upholstery		Shipping		D \$957	E \$998
		COM Ydg	¾	Ctn Wt	19	F \$1,060	G \$1,130
		COL Sq Ft	15	Cu Ft	14	H \$1,202	I \$1,315
						J \$1,452	L1 \$1,142
						L2 \$1,225	

To Order, Specify:

- ① Model Number
- ② Seat and Back Plastic Color [See Seat and Back Plastic Color Options](#)
- ③ Fabric Selection - vendor, pattern and color
 Visit www.jsifurniture.com/finishes-and-materials/textiles for our textiles program.
 See selection of standard and graded in manufacturers and patterns.
- ④ Metal Frame Color [See Metal Frame Tier/Color Options](#)

Specifications

- Metal frame.
- Load capacity meets or exceeds BIFMA requirements.
- Integrated passive linking glide.

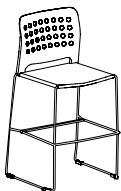
Description	Model	Specifications	List Price Per Grade												
39¾" Counter Height Stool, Fully Upholstered	HZ144D <ul style="list-style-type: none"> · upholstered seat · fully upholstered back · metal frame · load capacity meets or exceeds BIFMA requirements · integrated passive linking glide 	<table border="1"> <thead> <tr> <th>Dimensions</th> <th>D</th> <th>W</th> <th>H</th> </tr> </thead> <tbody> <tr> <td>Overall</td> <td>23</td> <td>21 ¾</td> <td>39 ¾</td> </tr> <tr> <td>Seat</td> <td>16 ¾</td> <td>17 ½</td> <td>24 ¾</td> </tr> </tbody> </table>	Dimensions	D	W	H	Overall	23	21 ¾	39 ¾	Seat	16 ¾	17 ½	24 ¾	COM \$939 A \$956 B \$983 COL/C \$1,038 D \$1,106 E \$1,175 F \$1,282 G \$1,397 H \$1,515 I \$1,706 J \$1,934 L1 \$1,418 L2 \$1,554
		Dimensions	D	W	H										
Overall	23	21 ¾	39 ¾												
Seat	16 ¾	17 ½	24 ¾												
<table border="1"> <thead> <tr> <th>Upholstery</th> <th colspan="3">Shipping</th> </tr> </thead> <tbody> <tr> <td>COM Ydg</td> <td>1 ¼</td> <td>Ctn Wt</td> <td>21</td> </tr> <tr> <td>COL Sq Ft</td> <td>23</td> <td>Cu Ft</td> <td>14</td> </tr> </tbody> </table>	Upholstery	Shipping			COM Ydg	1 ¼	Ctn Wt	21	COL Sq Ft	23	Cu Ft	14			
Upholstery	Shipping														
COM Ydg	1 ¼	Ctn Wt	21												
COL Sq Ft	23	Cu Ft	14												



Description	Model	Specifications	List Price Per Grade												
43" Bar Stool, Plastic Perforated Back - Plastic Seat	HZ148PA <ul style="list-style-type: none"> · plastic seat · plastic, perforated back · metal frame · load capacity meets or exceeds BIFMA requirements · integrated passive linking glide 	<table border="1"> <thead> <tr> <th>Dimensions</th> <th>D</th> <th>W</th> <th>H</th> </tr> </thead> <tbody> <tr> <td>Overall</td> <td>23</td> <td>21 ¾</td> <td>43</td> </tr> <tr> <td>Seat</td> <td>16 ¾</td> <td>17 ½</td> <td>28</td> </tr> </tbody> </table>	Dimensions	D	W	H	Overall	23	21 ¾	43	Seat	16 ¾	17 ½	28	\$655
		Dimensions	D	W	H										
Overall	23	21 ¾	43												
Seat	16 ¾	17 ½	28												
<table border="1"> <thead> <tr> <th>Upholstery</th> <th colspan="3">Shipping</th> </tr> </thead> <tbody> <tr> <td></td> <td></td> <td>Ctn Wt</td> <td>25</td> </tr> <tr> <td></td> <td></td> <td>Cu Ft</td> <td>15</td> </tr> </tbody> </table>	Upholstery	Shipping					Ctn Wt	25			Cu Ft	15			
Upholstery	Shipping														
		Ctn Wt	25												
		Cu Ft	15												





Description	Model	Specifications	List Price Per Grade												
43" Bar Stool, Plastic Back with Holes - Plastic Seat	HZ148HA <ul style="list-style-type: none"> · plastic seat · plastic, holes back · metal frame · load capacity meets or exceeds BIFMA requirements · integrated passive linking glide 	<table border="1"> <thead> <tr> <th>Dimensions</th> <th>D</th> <th>W</th> <th>H</th> </tr> </thead> <tbody> <tr> <td>Overall</td> <td>23</td> <td>21 ¾</td> <td>43</td> </tr> <tr> <td>Seat</td> <td>16 ¾</td> <td>17 ½</td> <td>28</td> </tr> </tbody> </table>	Dimensions	D	W	H	Overall	23	21 ¾	43	Seat	16 ¾	17 ½	28	\$655
		Dimensions	D	W	H										
Overall	23	21 ¾	43												
Seat	16 ¾	17 ½	28												
<table border="1"> <thead> <tr> <th>Upholstery</th> <th colspan="3">Shipping</th> </tr> </thead> <tbody> <tr> <td></td> <td></td> <td>Ctn Wt</td> <td>25</td> </tr> <tr> <td></td> <td></td> <td>Cu Ft</td> <td>15</td> </tr> </tbody> </table>	Upholstery	Shipping					Ctn Wt	25			Cu Ft	15			
Upholstery	Shipping														
		Ctn Wt	25												
		Cu Ft	15												

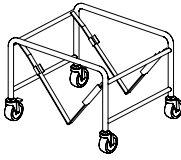


Description	Model	Specifications	List Price Per Grade												
43" Bar Stool, Plastic Perforated Back - Upholstered Seat	HZ148PC <ul style="list-style-type: none"> · upholstered seat · plastic, perforated back · metal frame · load capacity meets or exceeds BIFMA requirements · integrated passive linking glide 	<table border="1"> <thead> <tr> <th>Dimensions</th> <th>D</th> <th>W</th> <th>H</th> </tr> </thead> <tbody> <tr> <td>Overall</td> <td>23</td> <td>21 ¾</td> <td>43</td> </tr> <tr> <td>Seat</td> <td>16 ¾</td> <td>17 ½</td> <td>28</td> </tr> </tbody> </table>	Dimensions	D	W	H	Overall	23	21 ¾	43	Seat	16 ¾	17 ½	28	COM \$856 A \$866 B \$883 COL/C \$916 D \$957 E \$998 F \$1,060 G \$1,130 H \$1,202 I \$1,315 J \$1,452 L1 \$1,142 L2 \$1,225
		Dimensions	D	W	H										
Overall	23	21 ¾	43												
Seat	16 ¾	17 ½	28												
<table border="1"> <thead> <tr> <th>Upholstery</th> <th colspan="3">Shipping</th> </tr> </thead> <tbody> <tr> <td>COM Ydg</td> <td>¾</td> <td>Ctn Wt</td> <td>25</td> </tr> <tr> <td>COL Sq Ft</td> <td>15</td> <td>Cu Ft</td> <td>15</td> </tr> </tbody> </table>	Upholstery	Shipping			COM Ydg	¾	Ctn Wt	25	COL Sq Ft	15	Cu Ft	15			
Upholstery	Shipping														
COM Ydg	¾	Ctn Wt	25												
COL Sq Ft	15	Cu Ft	15												



Description	① Model	Specifications	List Price Per Grade																								
43" h Bar Stool, Plastic Back with Holes - Upholstered Seat 	HZ148HC <ul style="list-style-type: none"> · upholstered seat · plastic, holes back · metal frame · load capacity meets or exceeds BIFMA requirements · integrated passive linking glide 	<table border="1"> <thead> <tr> <th>Dimensions</th> <th>D</th> <th>W</th> <th>H</th> </tr> </thead> <tbody> <tr> <td>Overall</td> <td>23</td> <td>21 ¾</td> <td>43</td> </tr> <tr> <td>Seat</td> <td>16 ¾</td> <td>17 ½</td> <td>28</td> </tr> <tr> <th colspan="2">Upholstery</th> <th colspan="2">Shipping</th> </tr> <tr> <td>COM Ydg</td> <td>¾</td> <td>Ctn Wt</td> <td>25</td> </tr> <tr> <td>COL Sq Ft</td> <td>15</td> <td>Cu Ft</td> <td>15</td> </tr> </tbody> </table>	Dimensions	D	W	H	Overall	23	21 ¾	43	Seat	16 ¾	17 ½	28	Upholstery		Shipping		COM Ydg	¾	Ctn Wt	25	COL Sq Ft	15	Cu Ft	15	COM \$856 A \$866 B \$883 COL/C \$916 D \$957 E \$998 F \$1,060 G \$1,130 H \$1,202 I \$1,315 J \$1,452 L1 \$1,142 L2 \$1,225
		Dimensions	D	W	H																						
Overall	23	21 ¾	43																								
Seat	16 ¾	17 ½	28																								
Upholstery		Shipping																									
COM Ydg	¾	Ctn Wt	25																								
COL Sq Ft	15	Cu Ft	15																								

43" h Bar Stool, Fully Upholstered 	HZ148D <ul style="list-style-type: none"> · upholstered seat · fully upholstered back · metal frame · load capacity meets or exceeds BIFMA requirements · integrated passive linking glide 	<table border="1"> <thead> <tr> <th>Dimensions</th> <th>D</th> <th>W</th> <th>H</th> </tr> </thead> <tbody> <tr> <td>Overall</td> <td>23</td> <td>21 ¾</td> <td>43</td> </tr> <tr> <td>Seat</td> <td>16 ¾</td> <td>17 ½</td> <td>28</td> </tr> <tr> <th colspan="2">Upholstery</th> <th colspan="2">Shipping</th> </tr> <tr> <td>COM Ydg</td> <td>1 ¼</td> <td>Ctn Wt</td> <td>27</td> </tr> <tr> <td>COL Sq Ft</td> <td>23</td> <td>Cu Ft</td> <td>15</td> </tr> </tbody> </table>	Dimensions	D	W	H	Overall	23	21 ¾	43	Seat	16 ¾	17 ½	28	Upholstery		Shipping		COM Ydg	1 ¼	Ctn Wt	27	COL Sq Ft	23	Cu Ft	15	COM \$939 A \$956 B \$983 COL/C \$1,038 D \$1,106 E \$1,175 F \$1,282 G \$1,397 H \$1,515 I \$1,706 J \$1,934 L1 \$1,418 L2 \$1,554
		Dimensions	D	W	H																						
Overall	23	21 ¾	43																								
Seat	16 ¾	17 ½	28																								
Upholstery		Shipping																									
COM Ydg	1 ¼	Ctn Wt	27																								
COL Sq Ft	23	Cu Ft	15																								

Description	① Model	Specifications	List Price Per Grade																				
Transportation Cart 	HZ140 <ul style="list-style-type: none"> · welded steal frame · welded steel frame · two locking casters · only available in black · plastic seat - stack 45 high on the cart · upholstered seat - stack 10 high on the cart · fully upholstered chair - stack 10 high on the cart 	<table border="1"> <thead> <tr> <th>Dimensions</th> <th>D</th> <th>W</th> <th>H</th> </tr> </thead> <tbody> <tr> <td></td> <td>30</td> <td>26</td> <td>19</td> </tr> <tr> <th colspan="2"></th> <th colspan="2">Shipping</th> </tr> <tr> <td></td> <td></td> <td>Ctn Wt</td> <td>40</td> </tr> <tr> <td></td> <td></td> <td>Cu Ft</td> <td>9</td> </tr> </tbody> </table>	Dimensions	D	W	H		30	26	19			Shipping				Ctn Wt	40			Cu Ft	9	\$1,312
		Dimensions	D	W	H																		
	30	26	19																				
		Shipping																					
		Ctn Wt	40																				
		Cu Ft	9																				

To Order, Specify:

- ① Model Number
- ② Seat and Back Plastic Color [See Seat and Back Plastic Color Options](#)
- ③ Fabric Selection - vendor, pattern and color
 Visit www.jsifurniture.com/finishes-and-materials/textiles for our textiles program.
 See selection of standard and graded in manufacturers and patterns.
- ④ Metal Frame Color [See Metal Frame Tier/Color Options](#)

Specifications

- Metal frame.
- Load capacity meets or exceeds BIFMA requirements.
- Integrated passive linking glide.

Indie Seating Order Check List:



Specify:

- 1. Model Number
- 2. Wood Species - STANDARD Maple (M) - no upcharge, PREMIUM Walnut (W) or White Oak (WK1) - upcharge applies
- 3. Wood Finish
- 4. Fabric Selection - vendor, pattern and color
- 5. Optional Power Center
 - Under Mount (EC30) - Black (B) or White (W); add \$363 list each and indicate left or right arm, optional Graphite (G) cord available, specify and add \$187 list
 - Flush Mount (EC31) - Black (B) or White (W); add \$420 list each and indicate left or right arm, optional Graphite (G) cord available, specify and add \$187 list
 - Arm Mounted Power Block (EC32) - add \$515 list each and indicate left or right arm and cord color; Graphite, Indigo or Yellow
- 6. Optional Arm Mounted Knob - add \$123 list each and indicate left or right arm
- 7. Optional Arm Mounted Pouch - add \$306 list each and indicate left or right arm
- 8. Optional Rubber Cushion Nylon Glides - no upcharge

Example:

INS3262-29 | M | HRV | MOMENTUM | VOX | MYSTIC
 (model #) | (wood species) | (finish) | (fabric vendor) | (pattern name) | (pattern color)

1. Model Number

2. Wood Species - STANDARD Maple (M), PREMIUM Walnut (W) or White Oak (WK1); upcharge applies

3. Wood Finish/Color Options:

Maple Frame

ALM Ale Medium	CGR Graphite Coordinate
CAL Ale Light Coordinate	HRV Harvest
BBM Bourbon Medium	CKC Khaki Coordinate
CBZ Brazilwood Coordinate	MINC Mineral Coordinate
BARC Barrel Coordinate	MCH Mocha
CBO Bourbon Light Coordinate	CPI Pinnacle Walnut Coordinate
CBG Brighton Light Coordinate	PRL Praline
BRM Brighton Medium	RAVC Raven Coordinate
BUT Butterscotch	SABC Sable Coordinate
CNDC Cinder Coordinate	SIE Sienna
CLA Classic	CST Studio Teak Coordinate
CLL Collectors	TRF Truffle
EGRC Egret Coordinate	UMB Umber
ESP Espresso	VALC Valley Coordinate
FAWC Fawn Coordinate	VEN Venetian
FLX Flax	CWE Weathered Ash Coordinate

Paint Color - Add \$45 list per item

BKD Backdrop	GRV Greek Villa
BFX Black Fox	GLF Gulf Stream
BWH Bright White	HTB Heartthrob
CGP Cargo Pants	NET Network Gray
CHT Chatroom	NWH Nonchalant White
DSY Daisy	PAR Paradise
DRG Daring	QXP Quixotic Plum
DYN Dynamo	RBZ Relic Bronze
ENG Engima	SND Sandbank
FRR French Roast	STM Storm
GBY Georgian Bay	TRC Tricorn Black

***Walnut Frame (upcharge applies)**

ESP Espresso	TRF Truffle
MCH Mocha	UMB Umber
SIE Sienna	

***White Oak Frame (upcharge applies)**

ACR Acorn	MIN Mineral
BAR Barrel	POR Porter
BUF Buff	RAV Raven
BUR Burlap	RYE Rye
CHE Chestnut	SAB Sable
CND Cinder	SAD Saddle
EGR Egret	WWO Whitewash

4. Fabric Selection - Please supply the following:
 Fabric vendor/Pattern name/Pattern color

For a complete list of JSI Standard and Graded-In Textiles click here

- Indicate direction of fabric - Railroaded or Up the Roll
- Please provide illustration, if available

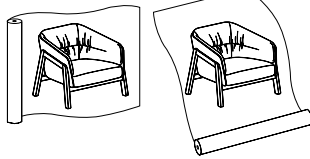
All COM orders must include the following:

***Note:** Walnut and White Oak Solid Hardwoods are PREMIUM materials and an upcharge applies. Associated upcharges are located in the bullet points under units where applicable.

- Vendor's name, pattern name and color
- Sample of the fabric attached to the order
- Model numbers of items for fabric application
- Special application instructions
- Customer and purchase order number

Ship prepaid COM material to:
 JSI
 Attn: COM Department
 201 East Martin Street
 Receiving B, Dock 71
 Orleans, IN 47452

Application of fabric:
 Railroaded Up the Roll



All COM orders will ship at standard lead time from receipt of COM except for orders requiring special custom matched finishes.

5. Power Centers

EC30 - Under Mount

- Frame mounted simplex receptacle and two USB/10' - three prong power cord/factory installed.
- Specify Black (B) or White (W) and add \$363 list each. Indicate left or right arm (as seated). Cord color will match unit unless optional Graphite cord is specified. Add \$187 list for optional Graphite cord.



EC31 - Flush Mount

- Integrated simplex receptacle and two USB/10' - three prong power cord/factory installed
- Specify Black (B) or White (W) and add \$420 list each. Indicate left or right arm (as seated). Cord color will match unit unless optional Graphite cord is specified. Add \$187 list for optional Graphite cord.



EC32 - Arm Mounted Power Block

- Indicate left or right arm (as seated) and add \$515 list each. Specify cord color; Graphite (G), Indigo (I) or Yellow (Y). Power Block will be finished the same as the frame of the chair.



- 6. Arm Mounted Knob** - A factory installed arm mounted knob can be specified. Indicate left or right arm (as seated) and add \$123 list each. Knob will be finished the same as the frame of the chair.



- 7. Arm Mounted Pouch** - A factory installed arm mounted pouch can be specified. Indicate left or right arm (as seated) and add \$306 list each. Pouch is aniline dye leather



- 8. Optional Rubber Cushion Nylon Glides** - no upcharge

Note: Consider when selecting options.



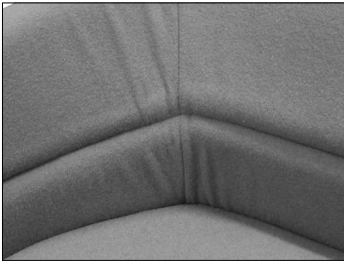
Pouch and EC32 power cannot be specified on the same arm.



INDIE

Upholstery Selection

When selecting the upholstery materials, consider the affect the upholstery structure has on the appearance of the comfort wrinkles.



High wool content upholstery, soft pliable vinyl, non-backed upholstery materials may limit the appearance of comfort wrinkles.



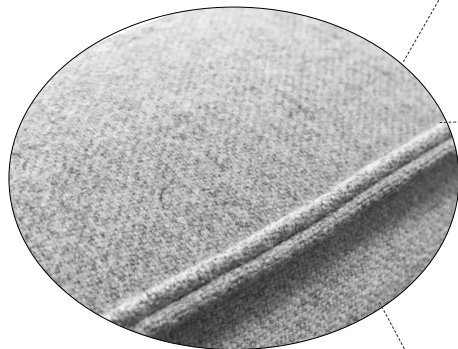
Highly structured, thick vinyl, backed non-stretch upholstery materials and leather can increase the appearance of comfort wrinkles.

Note: Large scale and geometric patterns applied over Indie soft contours with false welt details will impact the pattern visual.

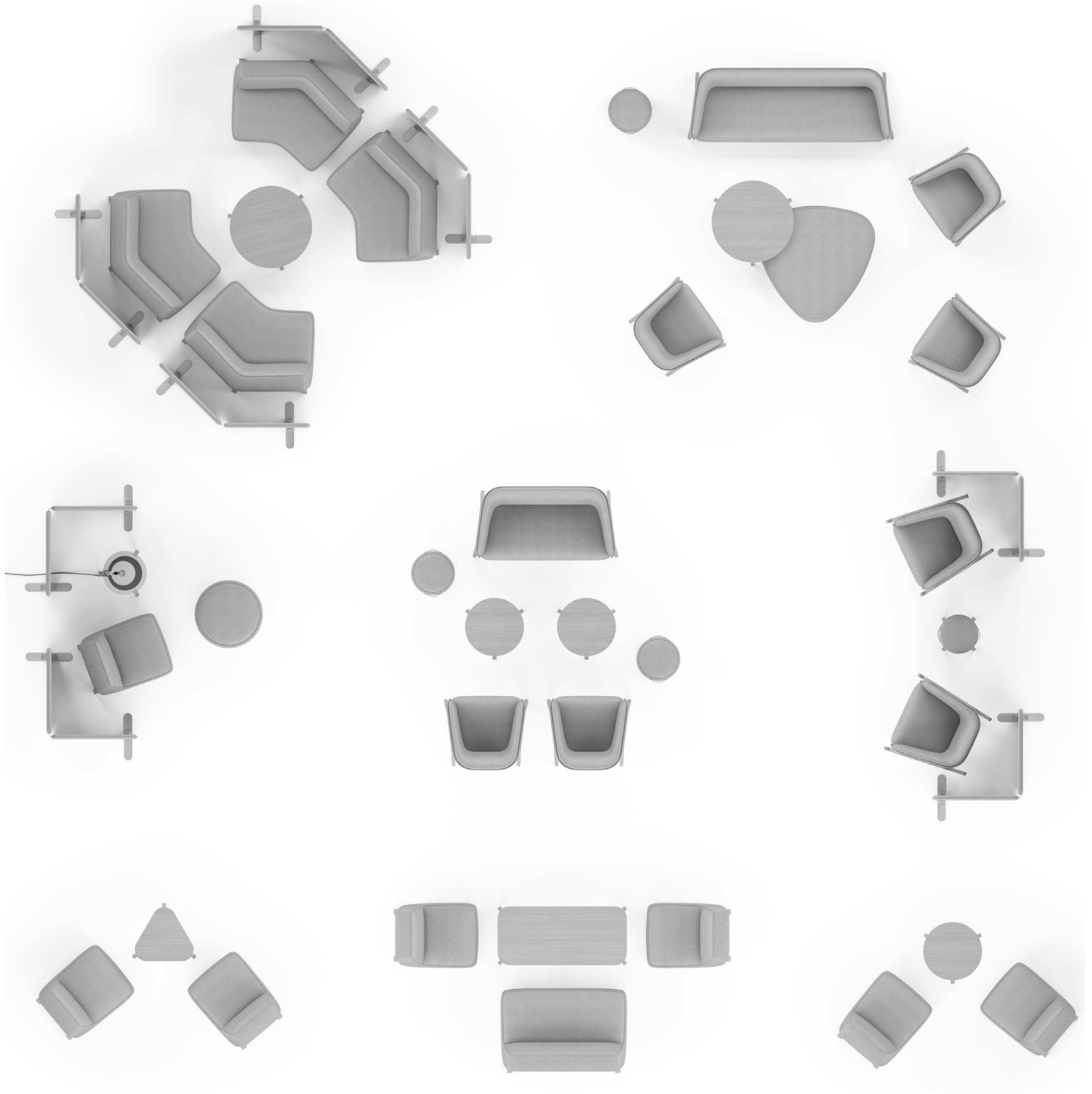
Upholstery Detail - False Welt

False Welt - Double fold upholstery seam detail is present on Indie Lounge, Low Lounge and Pouf units.

An integral part of the upholstery application, the false welt creates a defined line while maintaining flexibility for ultimate casual comfort.



Indie Configurations



INDIE

Indie Tables Order Check List:



Specify:

- 1. Model Number
- 2. Top Material
 - a.) Veneer with STANDARD Maple Solid Hardwood Rim
 - 1.) Wood Species - Cherry (CH1), Maple (MA1), Walnut (WA1) or Double Cut (DC1)
 - 2.) Wood Finish
 - b.) Laminate with STANDARD Maple Solid Hardwood Rim
 - 1.) Laminate Color with finish color matched rim
 - c.) Walnut Veneer with PREMIUM Walnut Solid Hardwood Rim
 - 1.) Wood Species - Walnut (WW1)
 - 2.) Wood Finish
 - d.) White Oak Veneer with PREMIUM White Oak Solid Hardwood Rim
 - 1.) Wood Species - White Oak (WK1)
 - 2.) Wood Finish
- 3. Leg Species
 - a.) STANDARD Maple (M)
 - 1.) Wood Finish or Paint Color
 - b.) PREMIUM Walnut (W) or White Oak (WK1); upcharge applies
 - 1.) Wood Finish
- 4. Lamp Shade - Maharam - Mode - Color
- 5. Optional Rubber Cushion Nylon Glides - no upcharge

Examples:

INT1919-14TT | WA1 | HRV | W | AUB
 (model #) | (top material/veneer) | (top material/finish) | (leg species) | (leg finish)

1. Model Number

2. Top Material Selection:

a.) Veneer with STANDARD Maple Solid Hardwood Rim

CH1 Cherry *Flat Cut Veneer*
 BBM Bourbon Medium CLL Collectors
 BRM Brighton Medium HRV Harvest
 CLA Classic PRL Praline

MA1 Maple *Flat Cut Veneer*
 ALM Ale Medium FLX Flax
 BUT Butterscotch VEN Venetian

WA1 Walnut *Flat Cut Veneer*
 ESP Espresso TRF Truffle
 MCH Mocha UMB Umber
 SIE Sienna

DC1 Double Cut Veneer
 COF Coffee KHK Khaki
 FAW Fawn STU Studio Teak
 GRH Graphite VAL Valley

b.) Solid Laminates with STANDARD Maple Solid Hardwood Rim

ALB Alabaster DWH Designer White
 BBL Bridal Blanco SHD Shadow
 BLK Black SLG Slate Grey

***c.) Walnut Veneer with PREMIUM Walnut Solid Hardwood Rim**

Flat Cut Walnut (WW1); upcharge applies
 ESP Espresso TRF Truffle
 MCH Mocha UMB Umber
 SIE Sienna

***d.) White Oak Veneer with PREMIUM White Oak Solid Hardwood Rim**

White Oak (WK1); upcharge applies
 ACR Acorn MIN Mineral
 BAR Barrel POR Porter
 BUF Buff RAV Raven
 BUR Burlap RYE Rye
 CHE Chestnut SAB Sable
 CND Cinder SAD Saddle
 EGR Egret WWO Whitewash

INDIE

3. Legs Species/Finish
Maple (M)

ALM	Ale Medium	HRV	Harvest
CAL	Ale Light Coordinate	CKC	Khaki Coordinate
BBM	Bourbon Medium	MINC	Mineral Coordinate
CBZ	Brazilwood Coordinate	MCH	Mocha
BARC	Barrel Coordinate	CPI	Pinnacle Walnut Coordinate
CBO	Bourbon Light Coordinate		
CBG	Brighton Light Coordinate	PRL	Praline
BRM	Brighton Medium	RAVC	Raven Coordinate
BUT	Butterscotch	SABC	Sable Coordinate
CNDC	Cinder Coordinate	SIE	Sienna
CLA	Classic	CST	Studio Teak Coordinate
CLL	Collectors	TRF	Truffle
EGRC	Egret Coordinate	UMB	Umber
ESP	Espresso	VALC	Valley Coordinate
FAWC	Fawn Coordinate	VEN	Venetian
FLX	Flax	CWE	Weathered Ash Coordinate
CGR	Graphite Coordinate		

Paint Color - Add \$45 list per item

BKD	Backdrop	GRV	Greek Villa
BFX	Black Fox	GLF	Gulf Stream
BWH	Bright White	HTB	Heartthrob
CGP	Cargo Pants	NET	Network Gray
CHT	Chatroom	NWH	Nonchalant White
DSY	Daisy	PAR	Paradise
DRG	Daring	QXP	Quixotic Plum
DYN	Dynamo	RBZ	Relic Bronze
ENG	Engima	SND	Sandbank
FRR	French Roast	STM	Storm
GBY	Georgian Bay	TRC	Tricorn Black

***Walnut (W) (upcharge applies)**

ESP	Espresso	TRF	Truffle
MCH	Mocha	UMB	Umber
SIE	Sienna		

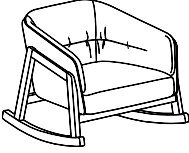
***White Oak (WK1) (upcharge applies)**

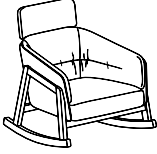
ACR	Acorn	MIN	Mineral
BAR	Barrel	POR	Porter
BUF	Buff	RAV	Raven
BUR	Burlap	RYE	Rye
CHE	Chesnut	SAB	Sable
CND	Cinder	SAD	Saddle
EGR	Egret	WWO	Whitewash

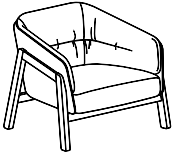
4. Lamp Shade: Maharam/Mode - Color

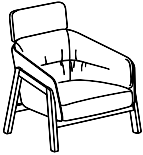
See www.maharam.com/products for color selection

***Note:** Walnut and White Oak Solid hardwoods are PREMIUM materials and upcharges apply. Associated upcharges can be located within bullet points under units where applicable. A single upcharge listed applies to any combination of premium materials; premium top, premium legs or premium top and legs.

Description	Model	Specifications				List Price Per Grade
Single Seat Rocker 	INS3536-29 · maple frame standard · walnut or white oak frame available, specify and add \$809 list	Dimensions	D	W	H	COM \$3,332
		Overall	34 ½	36	29 ¼	A \$3,394
		Seat	22 ½	25	17 ¼	B \$3,519
		Arm			27	COL/C \$3,736
		Upholstery	Shipping			D \$4,015
		COM Ydg	6	Ctn Wt	70	E \$4,294
		COL Sq Ft	120	Cu Ft	23	F \$4,728
						G \$5,194
						H \$5,690
						I \$6,465
						J \$7,397
						L1 \$5,534
						L2 \$6,156

Description	Model	Specifications				List Price Per Grade
Single Seat Rocker with Headrest 	INS3536-38 · maple frame standard · walnut or white oak legs available, specify and add \$809 list	Dimensions	D	W	H	COM \$3,698
		Overall	34 ½	36	38	A \$3,766
		Seat	22 ½	25	17 ¼	B \$3,901
		Arm			27	COL/C \$4,134
		Upholstery	Shipping			D \$4,439
		COM Ydg	6 ½	Ctn Wt	80	E \$4,741
		COL Sq Ft	130	Cu Ft	32	F \$5,212
						G \$5,716
						H \$6,253
						I \$7,093
						J \$8,101
						L1 \$6,085
						L2 \$6,757

Description	Model	Specifications				List Price Per Grade	
Single Seat 	INS3236-29 · maple frame standard · walnut or white oak frame available, specify and add \$405 list	Dimensions	D	W	H	COM	\$3,091
		Overall	31 ½	36	29 ¼	A	\$3,153
		Seat	22 ½	25	17 ¼	B	\$3,277
		Arm			27	COL/C	\$3,496
		Upholstery	Shipping			D	\$3,776
		COM Ydg	6	Ctn Wt	68	E	\$4,054
		COL Sq Ft	120	Cu Ft	24	F	\$4,488
						G	\$4,953
						H	\$5,449
						I	\$6,225
				J	\$7,156		
				L1	\$5,294		
				L2	\$5,915		

Description	Model	Specifications				List Price Per Grade	
Single Seat with Headrest 	INS3236-38 · maple frame standard · walnut or white oak frame available, specify and add \$405 list	Dimensions	D	W	H	COM	\$3,464
		Overall	32 ½	36	38	A	\$3,533
		Seat	22 ½	25	17 ¼	B	\$3,668
		Arm			27	COL/C	\$3,902
		Upholstery	Shipping			D	\$4,205
		COM Ydg	6 ½	Ctn Wt	78	E	\$4,508
		COL Sq Ft	130	Cu Ft	31	F	\$4,978
						G	\$5,482
						H	\$6,019
						I	\$6,861
				J	\$7,868		
				L1	\$5,851		
				L2	\$6,524		

To Order, Specify:

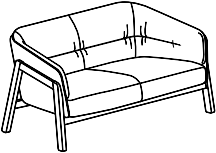
- 1 Model Number
- 2 Wood Species:
 - a.) STANDARD Maple (M)
 - b.) PREMIUM Walnut (W) - upcharge applies
 - c.) PREMIUM White Oak (WK1) - upcharge applies
- 3 Finish [See Wood Finish/Color Options](#)
 - a.) Maple Finish
 - b.) Walnut Finish
 - c.) White Oak Finish
- 4 Fabric Selection - vendor, pattern and color
 Visit www.jsifurniture.com/finishes-and-materials/textiles for our textiles program.
 See selection of standard and graded in manufacturers and patterns.
- 5 Optional Power Centers, see page IN3
- 6 Optional Arm Mounted Knob, add \$123 list each and indicate left or right arm (as seated), see page IN3
- 7 Optional Arm Mounted Pouch, add \$306 list each and indicate left or right arm (as seated), see page IN3
- 8 Optional Rubber Cushion Nylon Glides - no upcharge

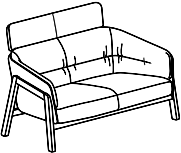
Specifications

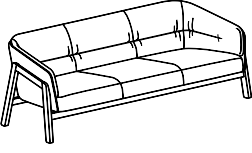
- Inner and outer back frame molded plywood.
- Back has 4 ¼" tapered high density high resilience polyurethane foam.
- Arm has 1 ½" multi-density high resilience polyurethane foam.
- Seat frame is puzzle jointed plywood construction.
- Seat has synthetic sheet webbing and 5" multi-density high resilience polyurethane foam.
- Seat has ½" dacron over wrap for upholstery detailing.
- Solid hardwood frame.
- Mortise and tenon construction with corner blocks, glue and screws.
- Standard with rubber cushion metal glides on leg models.

Note: EC32 power and pouch cannot be specified on the same arm

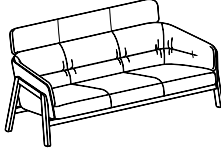
Note: Walnut and White Oak Solid hardwoods are PREMIUM materials and upcharges apply. Associated upcharges are located in bullet points under units where applicable.

Description	Model	Specifications	List Price Per Grade																																										
Two Seat 	INS3262-29 · maple frame standard · walnut or white oak frame available, specify and add \$561 list	<table border="1"> <thead> <tr> <th>Dimensions</th> <th>D</th> <th>W</th> <th>H</th> </tr> </thead> <tbody> <tr> <td>Overall</td> <td>31 ½</td> <td>62</td> <td>29 ¼</td> </tr> <tr> <td>Seat</td> <td>22 ½</td> <td>51</td> <td>17 ¼</td> </tr> <tr> <td>Arm</td> <td></td> <td></td> <td>27</td> </tr> </tbody> </table>	Dimensions	D	W	H	Overall	31 ½	62	29 ¼	Seat	22 ½	51	17 ¼	Arm			27	<table border="1"> <tbody> <tr> <td>COM</td> <td>\$4,305</td> </tr> <tr> <td>A</td> <td>\$4,390</td> </tr> <tr> <td>B</td> <td>\$4,555</td> </tr> <tr> <td>COL/C</td> <td>\$4,845</td> </tr> <tr> <td>D</td> <td>\$5,218</td> </tr> <tr> <td>E</td> <td>\$5,590</td> </tr> <tr> <td>F</td> <td>\$6,168</td> </tr> <tr> <td>G</td> <td>\$6,788</td> </tr> <tr> <td>H</td> <td>\$7,451</td> </tr> <tr> <td>I</td> <td>\$8,484</td> </tr> <tr> <td>J</td> <td>\$9,726</td> </tr> <tr> <td>L1</td> <td>\$7,243</td> </tr> <tr> <td>L2</td> <td>\$8,071</td> </tr> </tbody> </table>	COM	\$4,305	A	\$4,390	B	\$4,555	COL/C	\$4,845	D	\$5,218	E	\$5,590	F	\$6,168	G	\$6,788	H	\$7,451	I	\$8,484	J	\$9,726	L1	\$7,243	L2	\$8,071
		Dimensions	D	W	H																																								
Overall	31 ½	62	29 ¼																																										
Seat	22 ½	51	17 ¼																																										
Arm			27																																										
COM	\$4,305																																												
A	\$4,390																																												
B	\$4,555																																												
COL/C	\$4,845																																												
D	\$5,218																																												
E	\$5,590																																												
F	\$6,168																																												
G	\$6,788																																												
H	\$7,451																																												
I	\$8,484																																												
J	\$9,726																																												
L1	\$7,243																																												
L2	\$8,071																																												
		<table border="1"> <thead> <tr> <th>Upholstery</th> <th colspan="2">Shipping</th> </tr> </thead> <tbody> <tr> <td>COM Ydg</td> <td>8</td> <td>Ctn Wt 107</td> </tr> <tr> <td>COL Sq Ft</td> <td>160</td> <td>Cu Ft 39</td> </tr> </tbody> </table>	Upholstery	Shipping		COM Ydg	8	Ctn Wt 107	COL Sq Ft	160	Cu Ft 39																																		
Upholstery	Shipping																																												
COM Ydg	8	Ctn Wt 107																																											
COL Sq Ft	160	Cu Ft 39																																											

Description	Model	Specifications	List Price Per Grade																																										
Two Seat with Headrest 	INS3262-38 · maple frame standard · walnut or white oak frame available, specify and add \$561 list	<table border="1"> <thead> <tr> <th>Dimensions</th> <th>D</th> <th>W</th> <th>H</th> </tr> </thead> <tbody> <tr> <td>Overall</td> <td>32 ½</td> <td>62</td> <td>38</td> </tr> <tr> <td>Seat</td> <td>22 ½</td> <td>51</td> <td>17 ¼</td> </tr> <tr> <td>Arm</td> <td></td> <td></td> <td>27</td> </tr> </tbody> </table>	Dimensions	D	W	H	Overall	32 ½	62	38	Seat	22 ½	51	17 ¼	Arm			27	<table border="1"> <tbody> <tr> <td>COM</td> <td>\$4,891</td> </tr> <tr> <td>A</td> <td>\$4,989</td> </tr> <tr> <td>B</td> <td>\$5,186</td> </tr> <tr> <td>COL/C</td> <td>\$5,531</td> </tr> <tr> <td>D</td> <td>\$5,973</td> </tr> <tr> <td>E</td> <td>\$6,415</td> </tr> <tr> <td>F</td> <td>\$7,103</td> </tr> <tr> <td>G</td> <td>\$7,839</td> </tr> <tr> <td>H</td> <td>\$8,625</td> </tr> <tr> <td>I</td> <td>\$9,853</td> </tr> <tr> <td>J</td> <td>\$11,327</td> </tr> <tr> <td>L1</td> <td>\$8,379</td> </tr> <tr> <td>L2</td> <td>\$9,362</td> </tr> </tbody> </table>	COM	\$4,891	A	\$4,989	B	\$5,186	COL/C	\$5,531	D	\$5,973	E	\$6,415	F	\$7,103	G	\$7,839	H	\$8,625	I	\$9,853	J	\$11,327	L1	\$8,379	L2	\$9,362
		Dimensions	D	W	H																																								
Overall	32 ½	62	38																																										
Seat	22 ½	51	17 ¼																																										
Arm			27																																										
COM	\$4,891																																												
A	\$4,989																																												
B	\$5,186																																												
COL/C	\$5,531																																												
D	\$5,973																																												
E	\$6,415																																												
F	\$7,103																																												
G	\$7,839																																												
H	\$8,625																																												
I	\$9,853																																												
J	\$11,327																																												
L1	\$8,379																																												
L2	\$9,362																																												
		<table border="1"> <thead> <tr> <th>Upholstery</th> <th colspan="2">Shipping</th> </tr> </thead> <tbody> <tr> <td>COM Ydg</td> <td>9 ½</td> <td>Ctn Wt 127</td> </tr> <tr> <td>COL Sq Ft</td> <td>190</td> <td>Cu Ft 50</td> </tr> </tbody> </table>	Upholstery	Shipping		COM Ydg	9 ½	Ctn Wt 127	COL Sq Ft	190	Cu Ft 50																																		
Upholstery	Shipping																																												
COM Ydg	9 ½	Ctn Wt 127																																											
COL Sq Ft	190	Cu Ft 50																																											

Description	Model	Specifications	List Price Per Grade																																										
Three Seat 	INS3288-29 · maple frame standard · walnut or white oak frame available, specify and add \$686 list	<table border="1"> <thead> <tr> <th>Dimensions</th> <th>D</th> <th>W</th> <th>H</th> </tr> </thead> <tbody> <tr> <td>Overall</td> <td>31 ½</td> <td>88</td> <td>29 ¼</td> </tr> <tr> <td>Seat</td> <td>22 ½</td> <td>77</td> <td>17 ¼</td> </tr> <tr> <td>Arm</td> <td></td> <td></td> <td>27</td> </tr> </tbody> </table>	Dimensions	D	W	H	Overall	31 ½	88	29 ¼	Seat	22 ½	77	17 ¼	Arm			27	<table border="1"> <tbody> <tr> <td>COM</td> <td>\$5,219</td> </tr> <tr> <td>A</td> <td>\$5,330</td> </tr> <tr> <td>B</td> <td>\$5,554</td> </tr> <tr> <td>COL/C</td> <td>\$5,942</td> </tr> <tr> <td>D</td> <td>\$6,442</td> </tr> <tr> <td>E</td> <td>\$6,943</td> </tr> <tr> <td>F</td> <td>\$7,721</td> </tr> <tr> <td>G</td> <td>\$8,555</td> </tr> <tr> <td>H</td> <td>\$9,444</td> </tr> <tr> <td>I</td> <td>\$10,834</td> </tr> <tr> <td>J</td> <td>\$12,500</td> </tr> <tr> <td>L1</td> <td>\$9,166</td> </tr> <tr> <td>L2</td> <td>\$10,277</td> </tr> </tbody> </table>	COM	\$5,219	A	\$5,330	B	\$5,554	COL/C	\$5,942	D	\$6,442	E	\$6,943	F	\$7,721	G	\$8,555	H	\$9,444	I	\$10,834	J	\$12,500	L1	\$9,166	L2	\$10,277
		Dimensions	D	W	H																																								
Overall	31 ½	88	29 ¼																																										
Seat	22 ½	77	17 ¼																																										
Arm			27																																										
COM	\$5,219																																												
A	\$5,330																																												
B	\$5,554																																												
COL/C	\$5,942																																												
D	\$6,442																																												
E	\$6,943																																												
F	\$7,721																																												
G	\$8,555																																												
H	\$9,444																																												
I	\$10,834																																												
J	\$12,500																																												
L1	\$9,166																																												
L2	\$10,277																																												
		<table border="1"> <thead> <tr> <th>Upholstery</th> <th colspan="2">Shipping</th> </tr> </thead> <tbody> <tr> <td>COM Ydg</td> <td>10 ¾</td> <td>Ctn Wt 145</td> </tr> <tr> <td>COL Sq Ft</td> <td>215</td> <td>Cu Ft 55</td> </tr> </tbody> </table>	Upholstery	Shipping		COM Ydg	10 ¾	Ctn Wt 145	COL Sq Ft	215	Cu Ft 55																																		
Upholstery	Shipping																																												
COM Ydg	10 ¾	Ctn Wt 145																																											
COL Sq Ft	215	Cu Ft 55																																											

INDIE

Description	Model	Specifications			List Price Per Grade		
		Dimensions	D	W	H	COM	COL/C
Three Seat with Headrest 	INS3288-38 · maple frame standard · walnut or white oak frame available, specify and add \$686 list	Overall	32 ½	88	38	A	\$6,095
		Seat	22 ½	77	17 ¼	B	\$6,364
		Arm			27	COL/C	\$6,834
		Upholstery		Shipping		D	\$7,441
		COM Ydg	13	Ctn Wt	175	E	\$8,045
		COL Sq Ft	260	Cu Ft	71	F	\$8,986
						G	\$9,995
						H	\$11,069
						I	\$12,749
						J	\$14,767
						L1	\$10,733
						L2	\$12,077

To Order, Specify:

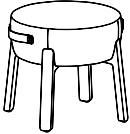

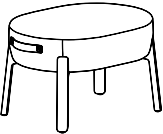
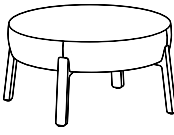
- 1 Model Number
- 2 Wood Species:
 - a.) STANDARD Maple (M)
 - b.) PREMIUM Walnut (W) - upcharge applies
 - c.) PREMIUM White Oak (WK1) - upcharge applies
- 3 Finish [See Wood Finish/Color Options](#)
 - a.) Maple Finish
 - b.) Walnut Finish
 - c.) White Oak Finish
- 4 Fabric Selection - vendor, pattern and color
 Visit www.jsifurniture.com/finishes-and-materials/textiles for our textiles program.
 See selection of standard and graded in manufacturers and patterns.
- 5 Optional Power Centers, see page IN3
- 6 Optional Arm Mounted Knob, add \$123 list each and indicate left or right arm (as seated), see page IN3
- 7 Optional Arm Mounted Pouch, add \$306 list each and indicate left or right arm (as seated), see page IN3
- 8 Optional Rubber Cushion Nylon Glides - no upcharge

Note: EC32 power and pouch cannot be specified on the same arm

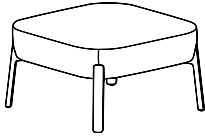
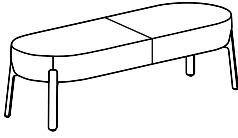
Note: Walnut and White Oak Solid hardwoods are PREMIUM materials and upcharges apply. Associated upcharges are located in bullet points under units where applicable.

Specifications

- Inner and outer back frame molded plywood.
- Back has 4 ¼" tapered high density high resilience polyurethane foam.
- Arm has 1 ½" multi-density high resilience polyurethane foam.
- Seat frame is puzzle jointed plywood construction.
- Seat has synthetic sheet webbing and 5" multi-density high resilience polyurethane foam.
- Seat has ½" dacron over wrap for upholstery detailing.
- Solid hardwood frame.
- Mortise and tenon construction with corner blocks, glue and screws.
- Standard with rubber cushion metal glides on leg models.

Description	Model	Specifications	List Price Per Grade									
Round Ottoman 	INO1717-17RDO · two leather handles · maple legs standard · walnut or white oak legs available, specify and add \$95 list	<table border="1"> <thead> <tr> <th>Dimensions</th> <th>D</th> <th>W</th> <th>H</th> </tr> </thead> <tbody> <tr> <td>Overall</td> <td>17</td> <td>17</td> <td>16 ½</td> </tr> </tbody> </table>	Dimensions	D	W	H	Overall	17	17	16 ½	COM \$1,275 A \$1,283 B \$1,298 COL/C \$1,325 D \$1,361 E \$1,397 F \$1,450 G \$1,508 H \$1,571 I \$1,667 J \$1,784 L1 \$1,520 L2 \$1,589	
		Dimensions	D	W	H							
Overall	17	17	16 ½									
<table border="1"> <thead> <tr> <th>Upholstery</th> <th colspan="3">Shipping</th> </tr> </thead> <tbody> <tr> <td>COM Ydg</td> <td>¾</td> <td>Ctn Wt</td> <td>17</td> </tr> <tr> <td>COL Sq Ft</td> <td>14</td> <td>Cu Ft</td> <td>4</td> </tr> </tbody> </table>	Upholstery	Shipping			COM Ydg	¾	Ctn Wt	17	COL Sq Ft	14	Cu Ft	4
Upholstery	Shipping											
COM Ydg	¾	Ctn Wt	17									
COL Sq Ft	14	Cu Ft	4									
Oval Ottoman 	INO1319-17OVO · two leather handles · maple legs standard · walnut or white oak legs available, specify and add \$95 list	<table border="1"> <thead> <tr> <th>Dimensions</th> <th>D</th> <th>W</th> <th>H</th> </tr> </thead> <tbody> <tr> <td>Overall</td> <td>13</td> <td>19</td> <td>16 ½</td> </tr> </tbody> </table>	Dimensions	D	W	H	Overall	13	19	16 ½	COM \$1,276 A \$1,284 B \$1,299 COL/C \$1,326 D \$1,362 E \$1,398 F \$1,451 G \$1,509 H \$1,572 I \$1,668 J \$1,785 L1 \$1,521 L2 \$1,591	
		Dimensions	D	W	H							
Overall	13	19	16 ½									
<table border="1"> <thead> <tr> <th>Upholstery</th> <th colspan="3">Shipping</th> </tr> </thead> <tbody> <tr> <td>COM Ydg</td> <td>¾</td> <td>Ctn Wt</td> <td>16</td> </tr> <tr> <td>COL Sq Ft</td> <td>14</td> <td>Cu Ft</td> <td>4</td> </tr> </tbody> </table>	Upholstery	Shipping			COM Ydg	¾	Ctn Wt	16	COL Sq Ft	14	Cu Ft	4
Upholstery	Shipping											
COM Ydg	¾	Ctn Wt	16									
COL Sq Ft	14	Cu Ft	4									
Oval Ottoman 	INO1925-17OVO · two leather handles · maple legs standard · walnut or white oak legs available, specify and add \$95 list	<table border="1"> <thead> <tr> <th>Dimensions</th> <th>D</th> <th>W</th> <th>H</th> </tr> </thead> <tbody> <tr> <td>Overall</td> <td>19</td> <td>25</td> <td>16 ½</td> </tr> </tbody> </table>	Dimensions	D	W	H	Overall	19	25	16 ½	COM \$1,386 A \$1,398 B \$1,419 COL/C \$1,455 D \$1,500 E \$1,548 F \$1,620 G \$1,698 H \$1,780 I \$1,910 J \$2,065 L1 \$1,712 L2 \$1,807	
		Dimensions	D	W	H							
Overall	19	25	16 ½									
<table border="1"> <thead> <tr> <th>Upholstery</th> <th colspan="3">Shipping</th> </tr> </thead> <tbody> <tr> <td>COM Ydg</td> <td>1</td> <td>Ctn Wt</td> <td>25</td> </tr> <tr> <td>COL Sq Ft</td> <td>18</td> <td>Cu Ft</td> <td>6</td> </tr> </tbody> </table>	Upholstery	Shipping			COM Ydg	1	Ctn Wt	25	COL Sq Ft	18	Cu Ft	6
Upholstery	Shipping											
COM Ydg	1	Ctn Wt	25									
COL Sq Ft	18	Cu Ft	6									
Round Ottoman 	INO2727-17RDO · maple legs standard · walnut or white oak legs available, specify and add \$95 list	<table border="1"> <thead> <tr> <th>Dimensions</th> <th>D</th> <th>W</th> <th>H</th> </tr> </thead> <tbody> <tr> <td>Overall</td> <td>27</td> <td>27</td> <td>16 ½</td> </tr> </tbody> </table>	Dimensions	D	W	H	Overall	27	27	16 ½	COM \$1,571 A \$1,584 B \$1,610 COL/C \$1,656 D \$1,712 E \$1,772 F \$1,861 G \$1,959 H \$2,063 I \$2,224 J \$2,417 L1 \$1,979 L2 \$2,095	
		Dimensions	D	W	H							
Overall	27	27	16 ½									
<table border="1"> <thead> <tr> <th>Upholstery</th> <th colspan="3">Shipping</th> </tr> </thead> <tbody> <tr> <td>COM Ydg</td> <td>1 ¼</td> <td>Ctn Wt</td> <td>38</td> </tr> <tr> <td>COL Sq Ft</td> <td>23</td> <td>Cu Ft</td> <td>10</td> </tr> </tbody> </table>	Upholstery	Shipping			COM Ydg	1 ¼	Ctn Wt	38	COL Sq Ft	23	Cu Ft	10
Upholstery	Shipping											
COM Ydg	1 ¼	Ctn Wt	38									
COL Sq Ft	23	Cu Ft	10									

INDIE

Description	① Model	Specifications				List Price Per Grade	
Square Ottoman 	IN02727-17SQO · maple legs standard · walnut or white oak legs available, specify and add \$95 list	Dimensions		D	W	H	COM \$1,593
		Overall		27	27	16½	A \$1,610
		Upholstery		Shipping			B \$1,640
		COM Ydg	1½	Ctn Wt	38	COL/C \$1,694	
		COL Sq Ft	27	Cu Ft	10	D \$1,765	
					E \$1,834		
					F \$1,943		
					G \$2,058		
					H \$2,183		
					I \$2,376		
					J \$2,610		
					L1 \$2,082		
					L2 \$2,222		
Oval Ottoman 	IN01955-17OVO · maple legs standard · walnut or white oak legs available, specify and add \$95 list	Dimensions		D	W	H	COM \$1,922
		Overall		19	55	16½	A \$1,944
		Upholstery		Shipping			B \$1,985
		COM Ydg	2	Ctn Wt	53	COL/C \$2,058	
		COL Sq Ft	36	Cu Ft	13	D \$2,152	
					E \$2,244		
					F \$2,389		
					G \$2,544		
					H \$2,710		
					I \$2,969		
					J \$3,277		
					L1 \$2,575		
					L2 \$2,761		

To Order, Specify:

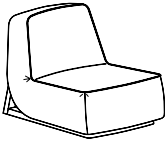
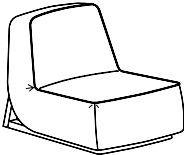
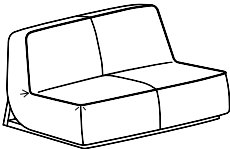
- ① Model Number
- ② Wood Species:
 - a.) STANDARD Maple (M)
 - b.) PREMIUM Walnut (W) - upcharge applies
 - c.) PREMIUM White Oak (WK1) - upcharge applies
- ③ Finish [See Wood Finish/Color Options](#)
 - a.) Maple Finish
 - b.) Walnut Finish
 - c.) White Oak Finish
- ④ Fabric Selection - vendor, pattern and color
 Visit www.jsifurniture.com/finishes-and-materials/textiles for our textiles program.
 See selection of standard and graded in manufacturers and patterns.
- ⑤ Optional Power Centers, see page IN3
- ⑥ Optional Arm Mounted Knob, add \$123 list each and indicate left or right arm (as seated), see page IN3
- ⑦ Optional Arm Mounted Pouch, add \$306 list each and indicate left or right arm (as seated), see page IN3
- ⑧ Optional Rubber Cushion Nylon Glides - no upcharge

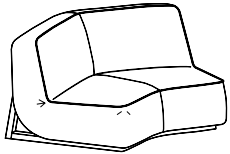
Specifications

- Inner and outer back frame molded plywood.
- Back has 4 ¼" tapered high density high resilience polyurethane foam.
- Arm has 1 ½" multi-density high resilience polyurethane foam.
- Seat frame is puzzle jointed plywood construction.
- Seat has synthetic sheet webbing and 5" multi-density high resilience polyurethane foam.
- Seat has ½" dacron over wrap for upholstery detailing.
- Solid hardwood frame.
- Mortise and tenon construction with corner blocks, glue and screws.
- Standard with rubber cushion metal glides on leg models.

Note: EC32 power and pouch cannot be specified on the same arm

Note: Walnut and White Oak Solid hardwoods are PREMIUM materials and upcharges apply. Associated upcharges are located in bullet points under units where applicable.

Description	① Model	Specifications	List Price Per Grade												
Single Seat Mini Low Lounge 	INS3119-25 · maple legs standard · walnut or white oak frame available, specify and add \$332 list	<table border="1"> <thead> <tr> <th>Dimensions</th> <th>D</th> <th>W</th> <th>H</th> </tr> </thead> <tbody> <tr> <td>Overall</td> <td>31</td> <td>19</td> <td>25</td> </tr> <tr> <td>Seat</td> <td>18</td> <td>19</td> <td>14½</td> </tr> </tbody> </table>	Dimensions	D	W	H	Overall	31	19	25	Seat	18	19	14½	COM \$1,541 A \$1,562 B \$1,604 COL/C \$1,676 D \$1,770 E \$1,862 F \$2,006 G \$2,162 H \$2,327 I \$2,587 J \$2,897 L1 \$2,276 L2 \$2,482
		Dimensions	D	W	H										
Overall	31	19	25												
Seat	18	19	14½												
<table border="1"> <thead> <tr> <th>Upholstery</th> <th colspan="3">Shipping</th> </tr> </thead> <tbody> <tr> <td>COM Ydg</td> <td>2</td> <td>Ctn Wt</td> <td>39</td> </tr> <tr> <td>COL Sq Ft</td> <td>42</td> <td>Cu Ft</td> <td>18</td> </tr> </tbody> </table>	Upholstery	Shipping			COM Ydg	2	Ctn Wt	39	COL Sq Ft	42	Cu Ft	18			
Upholstery	Shipping														
COM Ydg	2	Ctn Wt	39												
COL Sq Ft	42	Cu Ft	18												
Single Seat Low Lounge 	INS3627-27 · maple frame standard · walnut or white oak frame available, specify and add \$332 list	<table border="1"> <thead> <tr> <th>Dimensions</th> <th>D</th> <th>W</th> <th>H</th> </tr> </thead> <tbody> <tr> <td>Overall</td> <td>36</td> <td>27</td> <td>27</td> </tr> <tr> <td>Seat</td> <td>23</td> <td>27</td> <td>14½</td> </tr> </tbody> </table>	Dimensions	D	W	H	Overall	36	27	27	Seat	23	27	14½	COM \$1,970 A \$2,009 B \$2,087 COL/C \$2,224 D \$2,398 E \$2,572 F \$2,843 G \$3,135 H \$3,444 I \$3,929 J \$4,512 L1 \$3,658 L2 \$4,124
		Dimensions	D	W	H										
Overall	36	27	27												
Seat	23	27	14½												
<table border="1"> <thead> <tr> <th>Upholstery</th> <th colspan="3">Shipping</th> </tr> </thead> <tbody> <tr> <td>COM Ydg</td> <td>3¾</td> <td>Ctn Wt</td> <td>52</td> </tr> <tr> <td>COL Sq Ft</td> <td>90</td> <td>Cu Ft</td> <td>19</td> </tr> </tbody> </table>	Upholstery	Shipping			COM Ydg	3¾	Ctn Wt	52	COL Sq Ft	90	Cu Ft	19			
Upholstery	Shipping														
COM Ydg	3¾	Ctn Wt	52												
COL Sq Ft	90	Cu Ft	19												
Two Seat Low Lounge 	INS3653-27 · maple frame standard · walnut or white oak frame available, specify and add \$437 list	<table border="1"> <thead> <tr> <th>Dimensions</th> <th>D</th> <th>W</th> <th>H</th> </tr> </thead> <tbody> <tr> <td>Overall</td> <td>36</td> <td>53</td> <td>27</td> </tr> <tr> <td>Seat</td> <td>23</td> <td>53</td> <td>14½</td> </tr> </tbody> </table>	Dimensions	D	W	H	Overall	36	53	27	Seat	23	53	14½	COM \$3,174 A \$3,247 B \$3,392 COL/C \$3,645 D \$3,970 E \$4,297 F \$4,804 G \$5,346 H \$5,926 I \$6,830 J \$7,916 L1 \$6,323 L2 \$7,192
		Dimensions	D	W	H										
Overall	36	53	27												
Seat	23	53	14½												
<table border="1"> <thead> <tr> <th>Upholstery</th> <th colspan="3">Shipping</th> </tr> </thead> <tbody> <tr> <td>COM Ydg</td> <td>7</td> <td>Ctn Wt</td> <td>107</td> </tr> <tr> <td>COL Sq Ft</td> <td>168</td> <td>Cu Ft</td> <td>35</td> </tr> </tbody> </table>	Upholstery	Shipping			COM Ydg	7	Ctn Wt	107	COL Sq Ft	168	Cu Ft	35			
Upholstery	Shipping														
COM Ydg	7	Ctn Wt	107												
COL Sq Ft	168	Cu Ft	35												

Description	Model	Specifications			List Price Per Grade		
		Dimensions	D	W	H		
Two Seat Elbow Low Lounge 	INS4458-27 · maple frame standard · walnut or white oak frame available, specify and add \$561 list	Overall	44 ½	58 ½	27	COM	\$4,046
		Seat	23	53	14 ½	A	\$4,120
		Upholstery		Shipping		B	\$4,264
		COM Ydg	7	Ctn Wt	118	COL/C	\$4,518
		COL Sq Ft	168	Cu Ft	47	D	\$4,844
						E	\$5,171
						F	\$5,677
						G	\$6,219
						H	\$6,799
						I	\$7,703
						J	\$8,789
						L1	\$7,196
						L2	\$8,065

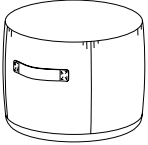
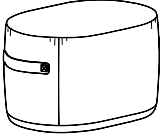
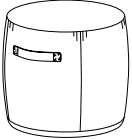
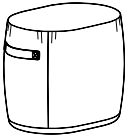
To Order, Specify:

- ❶ Model Number
- ❷ Wood Species:
 - a.) STANDARD Maple (M)
 - b.) PREMIUM Walnut (W) - upcharge applies
 - c.) PREMIUM White Oak (WK1) - upcharge applies
- ❸ Finish [See Finish/Color Options](#)
 - a.) Maple Finish
 - b.) Walnut Finish
 - c.) White Oak Finish
- ❹ Fabric Selection - vendor, pattern and color
 Visit www.jsifurniture.com/finishes-and-materials/textiles for our textiles program.
 See selection of standard and graded in manufacturers and patterns.
- ❺ Optional Power Centers, see page IN3
- ❻ Optional Rubber Cushion Nylon Glides - no upcharge

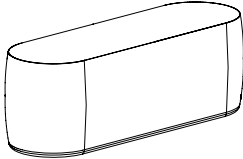
Note: Walnut and White Oak Solid hardwoods are PREMIUM materials and upcharges apply. Associated upcharges are located in bullet points under units where applicable.

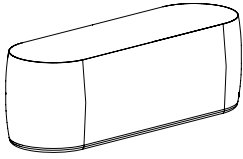
Specifications

- Frame is puzzle jointed plywood construction.
- Back has synthetic sheet webbing and 5" high density high resilience polyurethane foam.
- Seat has synthetic sheet webbing and 7" multi-density high resilience polyurethane foam.
- Seat and back have 2" dacron over wrap for upholstery detailing.
- Solid hardwood frame.
- Mortise and tenon construction with corner blocks, glue and screws.
- Standard with rubber cushion metal glides.

Description	Model	Specifications				List Price Per Grade	
Round Pouf 	INP1818-12RDP · two leather handles	Dimensions		D	W	H	COM \$825
		Overall	18	18	12		
		Upholstery		Shipping			B \$855
		COM Ydg	1	Ctn Wt	22		COL/C \$892
		COL Sq Ft	18	Cu Ft	3		D \$938
							E \$986
							F \$1,058
							G \$1,135
							H \$1,218
							I \$1,347
							J \$1,502
							L1 \$1,151
							L2 \$1,244
Oval Pouf 	INP1319-120VP · two leather handles	Dimensions		D	W	H	COM \$810
		Overall	13	19	12		
		Upholstery		Shipping			B \$842
		COM Ydg	1	Ctn Wt	19		COL/C \$878
		COL Sq Ft	18	Cu Ft	3		D \$925
							E \$972
							F \$1,043
							G \$1,122
							H \$1,204
							I \$1,334
							J \$1,488
							L1 \$1,136
							L2 \$1,229
Round Pouf 	INP1818-17RDP · two leather handles	Dimensions		D	W	H	COM \$873
		Overall	18	18	16½		
		Upholstery		Shipping			B \$912
		COM Ydg	1¼	Ctn Wt	26		COL/C \$958
		COL Sq Ft	23	Cu Ft	4		D \$1,015
							E \$1,075
							F \$1,164
							G \$1,261
							H \$1,364
							I \$1,526
							J \$1,720
							L1 \$1,281
							L2 \$1,398
Oval Pouf 	INP1319-170VP · two leather handles	Dimensions		D	W	H	COM \$841
		Overall	13	19	16½		
		Upholstery		Shipping			B \$879
		COM Ydg	1¼	Ctn Wt	23		COL/C \$926
		COL Sq Ft	23	Cu Ft	4		D \$983
							E \$1,042
							F \$1,132
							G \$1,229
							H \$1,333
							I \$1,494
							J \$1,688
							L1 \$1,249
							L2 \$1,365

INDIE

Description	① Model	Specifications				List Price Per Grade	
Oval Bench 	INB1855-190VB	Dimensions		D	W	H	COM \$1,905
		Overall		20	60	19	A \$1,937
		Upholstery		Shipping		B \$2,000	
		COM Ydg	3	Ctn Wt	109	COL/C \$2,108	
		COL Sq Ft	66	Cu Ft	13	D \$2,246	
						E \$2,388	
				F \$2,604			
				G \$2,837			
				H \$3,085			
				I \$3,472			
				J \$3,939			
				L1 \$3,008			
				L2 \$3,317			

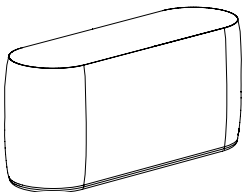
Oval Bench 	INB1860-190VB	Dimensions		D	W	H	COM \$1,977
		Overall		20	66	19	A \$2,012
		Upholstery		Shipping		B \$2,085	
		COM Ydg	3 ½	Ctn Wt	113	COL/C \$2,212	
		COL Sq Ft	77	Cu Ft	15	D \$2,374	
						E \$2,538	
				F \$2,792			
				G \$3,062			
				H \$3,352			
				I \$3,804			
				J \$4,348			
				L1 \$3,262			
				L2 \$3,624			

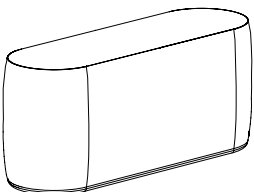
To Order, Specify:

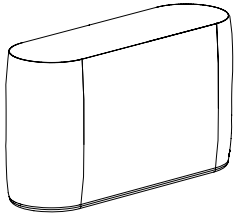
- ① Model Number
- ② Wood Species - Birch (B)
- ③ Finish [See Finish/Color Options](#)
- ④ Fabric Selection - vendor, pattern and color
 Visit www.jsifurniture.com/finishes-and-materials/textiles for our textiles program.
 See selection of standard and graded in manufacturers and patterns.
- ⑤ Optional Rubber Cushion Nylon Glides - no upcharge

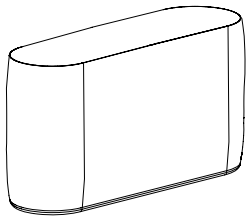
Specifications

- Frame is puzzle jointed plywood construction.
- Seat has 5" high density high resilience polyurethane foam.
- Seat has 2" dacron over wrap for upholstery detailing.
- Solid birch plywood base.
- Standard with rubber cushion metal glides.
- Aniline dye leather handles with sewn reinforced gussets.

Description	① Model	Specifications				List Price Per Grade	
Oval Bench 	INB1855-250VB	Dimensions		D	W	H	COM \$2,056
		Overall		20	60	25	A \$2,093
		Upholstery		Shipping			B \$2,165
		COM Ydg	3 1/2	Ctn Wt	124	COL/C \$2,291	
		COL Sq Ft	77	Cu Ft	17	D \$2,454	
				E \$2,618			
				F \$2,872			
				G \$3,143			
				H \$3,433			
				I \$3,884			
				J \$4,427			
				L1 \$3,342			
				L2 \$3,704			

Oval Bench 	INB1860-250VB	Dimensions		D	W	H	COM \$2,130
		Overall		20	66	25	A \$2,172
		Upholstery		Shipping			B \$2,255
		COM Ydg	4	Ctn Wt	129	COL/C \$2,400	
		COL Sq Ft	92	Cu Ft	19	D \$2,587	
				E \$2,773			
				F \$3,061			
				G \$3,372			
				H \$3,703			
				I \$4,219			
				J \$4,840			
				L1 \$3,598			
				L2 \$4,013			

Description	① Model	Specifications				List Price Per Grade	
Oval Bench 	INB1855-310VB	Dimensions		D	W	H	COM \$2,388
		Overall		20	60	31	A \$2,442
		Upholstery		Shipping			B \$2,551
		COM Ydg	5 ¼	Ctn Wt	143	COL/C \$2,740	
		COL Sq Ft	132	Cu Ft	21	D \$2,985	
						E \$3,230	
				F \$3,610			
				G \$4,017			
				H \$4,451			
				I \$5,131			
				J \$5,944			
				L1 \$4,316			
				L2 \$4,858			

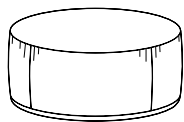
Oval Bench 	INB1860-310VB	Dimensions		D	W	H	COM \$2,414
		Overall		20	66	31	A \$2,475
		Upholstery		Shipping			B \$2,593
		COM Ydg	5 ¾	Ctn Wt	148	COL/C \$2,802	
		COL Sq Ft	144	Cu Ft	23	D \$3,070	
						E \$3,337	
				F \$3,754			
				G \$4,199			
				H \$4,676			
				I \$5,418			
				J \$6,310			
				L1 \$4,527			
				L2 \$5,120			

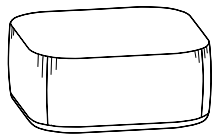
To Order, Specify:

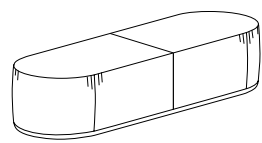
- ① Model Number
- ② Wood Species - Birch (B)
- ③ Finish [See Finish/Color Options](#)
- ④ Fabric Selection - vendor, pattern and color
Visit www.jsifurniture.com/finishes-and-materials/textiles for our textiles program.
See selection of standard and graded in manufacturers and patterns.
- ⑤ Optional Rubber Cushion Nylon Glides - no upcharge

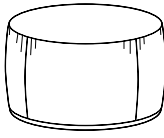
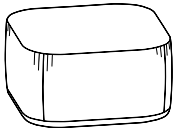
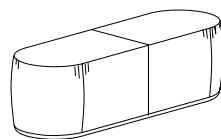
Specifications

- Frame is puzzle jointed plywood construction.
- Seat has 5" high density high resilience polyurethane foam.
- Seat has 2" dacron over wrap for upholstery detailing.
- Solid birch plywood base.
- Standard with rubber cushion metal glides.
- Aniline dye leather handles with sewn reinforced gussets.

Description	① Model	Specifications			List Price Per Grade	
Round Pouf 	INP2727-12RDP	Dimensions	D	W	H	COM \$1,232
		Overall	27	27	12	A \$1,248
		Upholstery	Shipping			B \$1,278
		COM Ydg	1 ½	Ctn Wt	52	COL/C \$1,333
		COL Sq Ft	27	Cu Ft	7	D \$1,402
						E \$1,472
				F \$1,581		
				G \$1,697		
				H \$1,821		
				I \$2,015		
				J \$2,247		
				L1 \$1,720		
				L2 \$1,860		

Description	① Model	Specifications			List Price Per Grade	
Square Pouf 	INP2727-12SQP	Dimensions	D	W	H	COM \$1,233
		Overall	27	27	12	A \$1,249
		Upholstery	Shipping			B \$1,279
		COM Ydg	1 ½	Ctn Wt	61	COL/C \$1,334
		COL Sq Ft	27	Cu Ft	7	D \$1,403
						E \$1,473
				F \$1,582		
				G \$1,698		
				H \$1,822		
				I \$2,016		
				J \$2,249		
				L1 \$1,721		
				L2 \$1,861		

Description	① Model	Specifications			List Price Per Grade	
Oval Pouf 	INP1855-120VP	Dimensions	D	W	H	COM \$1,771
		Overall	18	55	12	A \$1,792
		Upholstery	Shipping			B \$1,833
		COM Ydg	2	Ctn Wt	88	COL/C \$1,906
		COL Sq Ft	36	Cu Ft	9	D \$2,000
						E \$2,093
				F \$2,237		
				G \$2,392		
				H \$2,557		
				I \$2,816		
				J \$3,126		
				L1 \$2,423		
				L2 \$2,609		

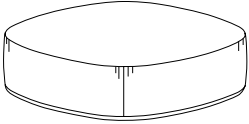
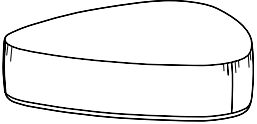
Description	① Model	Specifications				List Price Per Grade	
Round Pouf 	INP2727-17RDP	Dimensions		D	W	H	COM \$1,278
		Overall		27	27	16½	A \$1,297
		Upholstery		Shipping		COL/C \$1,397	
		COM Ydg	1¾	Ctn Wt	60		D \$1,476
		COL Sq Ft	32	Cu Ft	9		E \$1,560
						G \$1,821	
						H \$1,966	
						I \$2,193	
						J \$2,464	
						L1 \$1,849	
						L2 \$2,011	
Square Pouf 	INP2727-17SQP	Dimensions		D	W	H	COM \$1,279
		Overall		27	27	16½	A \$1,298
		Upholstery		Shipping		COL/C \$1,398	
		COM Ydg	1¾	Ctn Wt	72		D \$1,478
		COL Sq Ft	32	Cu Ft	9		E \$1,561
						G \$1,822	
						H \$1,967	
						I \$2,194	
						J \$2,465	
						L1 \$1,850	
						L2 \$2,012	
Oval Pouf 	INP1855-170VP	Dimensions		D	W	H	COM \$1,834
		Overall		18	55	16½	A \$1,858
		Upholstery		Shipping		COL/C \$1,986	
		COM Ydg	2¼	Ctn Wt	97		D \$2,091
		COL Sq Ft	41	Cu Ft	12		E \$2,196
						G \$2,534	
						H \$2,719	
						I \$3,010	
						J \$3,359	
						L1 \$2,567	
						L2 \$2,777	

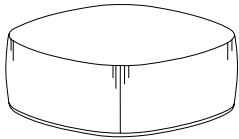
To Order, Specify:

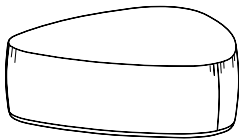
- ① Model Number
- ② Wood Species - Birch (B)
- ③ Finish [See Finish Options](#)
- ④ Fabric Selection - vendor, pattern and color
 Visit www.jsifurniture.com/finishes-and-materials/textiles for our textiles program.
 See selection of standard and graded in manufacturers and patterns.
- ⑤ Optional Rubber Cushion Nylon Glides - no upcharge

Specifications

- Frame is puzzle jointed plywood construction.
- Seat has 5" high density high resilience polyurethane foam.
- Seat has 2" dacron over wrap for upholstery detailing.
- Solid birch plywood base.
- Standard with rubber cushion metal glides.

Description	① Model	Specifications				List Price Per Grade	
Square Pouf 	INP4444-12SQP	Dimensions		D	W	H	COM \$2,371
		Overall		44	44	12	A \$2,404
		Upholstery		Shipping			B \$2,467
		COM Ydg	3	Ctn Wt	101	COL/C \$2,575	
		COL Sq Ft	90	Cu Ft	17	D \$2,714	
					E \$2,854		
					F \$3,071		
					G \$3,304		
					H \$3,552		
					I \$3,940		
					J \$4,405		
					L1 \$3,722		
					L2 \$4,093		
Triangular Pouf 	INP4848-12TRP	Dimensions		D	W	H	COM \$2,479
		Overall		48	48	12	A \$2,514
		Upholstery		Shipping			B \$2,580
		COM Ydg	3	Ctn Wt	109	COL/C \$2,698	
		COL Sq Ft	90	Cu Ft	20	D \$2,849	
					E \$3,001		
					F \$3,235		
					G \$3,488		
					H \$3,757		
					I \$4,177		
					J \$4,682		
					L1 \$3,942		
					L2 \$4,344		

Description	① Model	Specifications			List Price Per Grade		
Square Pouf 	INP4444-17SQP	Dimensions	D	W	H	COM	\$2,473
		Overall	44	44	16½	A	\$2,508
		Upholstery	Shipping			B	\$2,581
		COM Ydg	3½	Ctn Wt	114	COL/C	\$2,709
		COL Sq Ft	90	Cu Ft	22	D	\$2,870
						E	\$3,034
				F	\$3,288		
				G	\$3,558		
				H	\$3,848		
				I	\$4,300		
				J	\$4,844		
				L1	\$4,046		
				L2	\$4,482		

Description	① Model	Specifications			List Price Per Grade		
Triangular Pouf 	INP4848-17TRP	Dimensions	D	W	H	COM	\$2,630
		Overall	48	48	16½	A	\$2,662
		Upholstery	Shipping			B	\$2,725
		COM Ydg	4 ¼	Ctn Wt	125	COL/C	\$2,834
		COL Sq Ft	90	Cu Ft	26	D	\$2,972
						E	\$3,112
				F	\$3,330		
				G	\$3,561		
				H	\$3,809		
				I	\$4,198		
				J	\$4,663		
				L1	\$3,981		
				L2	\$4,353		

To Order, Specify:

- ① Model Number
- ② Wood Species - Birch (B)
- ③ Finish [See Finish Options](#)
- ④ Fabric Selection - vendor, pattern and color
 Visit www.jsifurniture.com/finishes-and-materials/textiles for our textiles program.
 See selection of standard and graded in manufacturers and patterns.
- ⑤ Optional Rubber Cushion Nylon Glides - no upcharge

Specifications

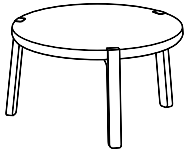
- Frame is puzzle jointed plywood construction.
- Seat has 5" high density high resilience polyurethane foam.
- Seat has 2" dacron over wrap for upholstery detailing.
- Solid birch plywood base.
- Standard with rubber cushion metal glides.

Description	D	W	H	CTN WT	CU FT	① Model	Flat Cut List Price	Double Cut List Price
Round Lounge Table	19	19	13 ¾	16	5	INT1919-14RD	\$1,154	\$1,269



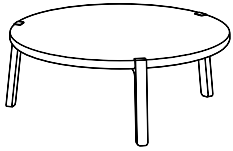
- ships factory assembled
- maple legs standard
- walnut or white oak rims and/or legs available, specify and add \$102 list

Round Lounge Table	25	25	13 ¾	24	7	INT2525-14RD	\$1,197	\$1,318
--------------------	----	----	------	----	---	--------------	---------	---------



- ships factory assembled
- maple legs standard
- walnut or white oak rims and/or legs available, specify and add \$102 list

Round Lounge Table	35	35	13 ¾	45	13	INT3535-14RD	\$1,381	\$1,520
--------------------	----	----	------	----	----	--------------	---------	---------



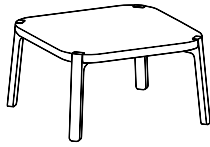
- ships factory assembled
- maple legs standard
- walnut or white oak rims and/or legs available, specify and add \$102 list

Description	D	W	H	CTN WT	CU FT	① Model	Flat Cut List Price	Double Cut List Price
Square Lounge Table	19	19	13 ¾	19	5	INT1919-14TT	\$1,212	\$1,335



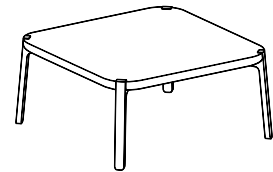
- ships factory assembled
- maple legs standard
- walnut or white oak rims and/or legs available, specify and add \$115 list

Square Lounge Table	25	25	13 ¾	30	7	INT2525-14TT	\$1,288	\$1,415
---------------------	----	----	------	----	---	--------------	---------	---------



- ships factory assembled
- maple legs standard
- walnut or white oak rims and/or legs available, specify and add \$115 list

Square Lounge Table	35	35	13 ¾	56	13	INT3535-14TT	\$1,447	\$1,593
---------------------	----	----	------	----	----	--------------	---------	---------



- ships factory assembled
- maple legs standard
- walnut or white oak rims and/or legs available, specify and add \$115 list

To Order, Specify:

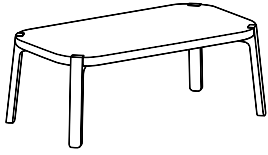
- ① Model Number
- ② Top Material:
 - a.) Veneer with STANDARD Maple Solid Hardwood Rims
[See Standard Veneer Top Finish with Maple Solid Hardwood Rim Options](#)
 - 1.) Wood Species - Cherry (CH1), Maple (MA1), Walnut (WA1) or Double Cut (DC1)
 - 2.) Wood Finish Color
 - b.) Laminate with STANDARD Maple Solid Hardwood Rims
[See Solid Laminate Top with Maple Solid Hardwood Rim Options](#)
 Alabaster (ALB), Bridal Blanco (BBL), Designer White (DWH), Shadow (SHD) or Slate Grey (SLG)
 - c.) Walnut Veneer with PREMIUM Walnut Solid Hardwood Rims
[See Walnut Veneer Top with PREMIUM Walnut Solid Hardwood Rim Options](#)
 - 1.) Wood Species - Walnut (WW1)
 - 2.) Wood Finish Color
 - d.) White Oak Veneer with PREMIUM White Oak Solid Hardwood Rims
[See White Oak Veneer Top with PREMIUM White Oak Solid Hardwood Rim Options](#)
 - 1.) Wood Species - White Oak (WK1)
 - 2.) Wood Finish Color
- ③ Leg Wood Species:
 - a.) STANDARD Maple (M)
[See Maple Leg Species/Finish Options](#)
 - 1.) Finish Color or Paint Color on maple legs
 - b.) PREMIUM Walnut (W) - upcharge applies
[See Walnut Leg Species/Finish Options](#)
 - 1.) Finish Color - Walnut finishes only on Walnut legs
 - c.) PREMIUM White Oak (WK1) - upcharge applies
[See White Oak Leg Species/Finish Options](#)
 - 1.) Finish Color - Whitewash finish only on White Oak legs
- ④ Optional Rubber Cushion Nylon Glides - no upcharge

Specifications

- Solid hardwood wood legs with steel plate reinforced mounting.
- 5 ply balanced top construction 1 ½" thick with profile shaped solid hardwood lumber rims
- Surfaces available in wood veneer or high pressure laminate.
- Standard with rubber cushion metal glides.

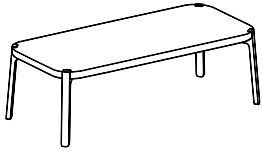
Note: Walnut and White Oak Solid hardwoods are PREMIUM materials and upcharges apply. Associated upcharges are located in bullet points under units where applicable. A single upcharge listed applies to any combination of premium materials; premium top, premium legs or premium top and legs.

Description	D	W	H	CTN WT	CU FT	① Model	Flat Cut List Price	Double Cut List Price
Rectangular Lounge Table	25	35	13 ¾	41	10	INT2535-14TT	\$1,369	\$1,506



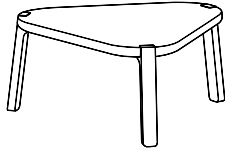
- ships factory assembled
- maple legs standard
- walnut or white oak rims and/or legs available, specify and add \$115 list

Rectangular Lounge Table	25	55	13 ¾	62	15	INT2555-14TT	\$1,520	\$1,671
--------------------------	----	----	------	----	----	--------------	---------	---------



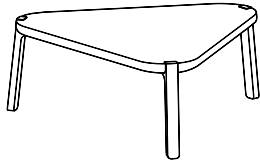
- ships factory assembled
- maple legs standard
- walnut or white oak rims and/or legs available, specify and add \$115 list

Description	D	W	H	CTN WT	CU FT	① Model	Flat Cut List Price	Double Cut List Price
Triangular Lounge Table	25	25	13 ¾	22	6	INT2525-14TR	\$1,142	\$1,259



- ships factory assembled
- maple legs standard
- walnut or white oak rims and/or legs available, specify and add \$102 list

Triangular Lounge Table	35	35	13 ¾	34	11	INT3535-14TR	\$1,299	\$1,429
-------------------------	----	----	------	----	----	--------------	---------	---------



- ships factory assembled
- maple legs standard
- walnut or white oak rims and/or legs available, specify and add \$102 list

To Order, Specify:

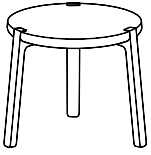
- ① Model Number
- ② Top Material:
 - a.) Veneer with STANDARD Maple Solid Hardwood Rims
[See Standard Veneer Top Finish with Maple Solid Hardwood Rim Options](#)
 - 1.) Wood Species - Cherry (CH1), Maple (MA1), Walnut (WA1) or Double Cut (DC1)
 - 2.) Wood Finish Color
 - b.) Laminate with STANDARD Maple Solid Hardwood Rims
[See Solid Laminate Top with Maple Solid Hardwood Rim Options](#)
 Alabaster (ALB), Bridal Blanco (BBL), Designer White (DWH), Shadow (SHD) or Slate Grey (SLG)
 - c.) Walnut Veneer with PREMIUM Walnut Solid Hardwood Rims
[See Walnut Veneer Top with PREMIUM Walnut Solid Hardwood Rim Options](#)
 - 1.) Wood Species - Walnut (WW1)
 - 2.) Wood Finish Color
 - d.) White Oak Veneer with PREMIUM White Oak Solid Hardwood Rims
[See White Oak Veneer Top with PREMIUM White Oak Solid Hardwood Rim Options](#)
 - 1.) Wood Species - White Oak (WK1)
 - 2.) Wood Finish Color
- ③ Leg Wood Species:
 - a.) STANDARD Maple (M)
[See Maple Leg Species/Finish Options](#)
 - 1.) Finish Color or Paint Color on maple legs
 - b.) PREMIUM Walnut (W) - upcharge applies
[See Walnut Leg Species/Finish Options](#)
 - 1.) Finish Color - Walnut finishes only on Walnut legs
 - c.) PREMIUM White Oak (WK1) - upcharge applies
[See White Oak Leg Species/Finish Options](#)
 - 1.) Finish Color - Whitewash finish only on White Oak legs
- ④ Optional Rubber Cushion Nylon Glides - no upcharge

Specifications

- Solid hardwood wood legs with steel plate reinforced mounting.
- 5 ply balanced top construction 1 ½" thick with profile shaped solid hardwood lumber rims
- Surfaces available in wood veneer or high pressure laminate.
- Standard with rubber cushion metal glides.

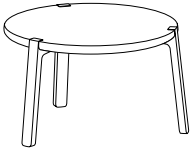
Note: Walnut and White Oak Solid hardwoods are PREMIUM materials and upcharges apply. Associated upcharges are located in bullet points under units where applicable. A single upcharge listed applies to any combination of premium materials; premium top, premium legs or premium top and legs.

Description	D	W	H	CTN WT	CU FT	① Model	Flat Cut List Price	Double Cut List Price
Round Lounge Table	19	19	16½	17	5	INT1919-17RD	\$1,154	\$1,269



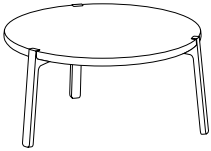
- ships factory assembled
- maple legs standard
- walnut or white oak rims and/or legs available, specify and add \$102 list

Round Lounge Table	25	25	16½	25	8	INT2525-17RD	\$1,197	\$1,318
--------------------	----	----	-----	----	---	--------------	---------	---------



- ships factory assembled
- maple legs standard
- walnut or white oak rims and/or legs available, specify and add \$102 list

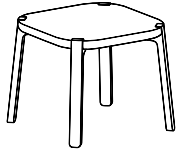
Round Lounge Table	35	35	16½	46	15	INT3535-17RD	\$1,381	\$1,520
--------------------	----	----	-----	----	----	--------------	---------	---------



- ships factory assembled
- maple legs standard
- walnut or white oak rims and/or legs available, specify and add \$102 list

INDIE

Description	D	W	H	CTN WT	CU FT	① Model	Flat Cut List Price	Double Cut List Price
Square Lounge Table	19	19	16 1/2	20	5	INT1919-17TT	\$1,212	\$1,335



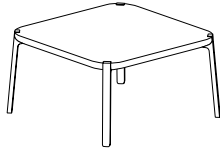
- ships factory assembled
- maple legs standard
- walnut or white oak rims and/or legs available, specify and add \$115 list

Square Lounge Table	25	25	16 1/2	31	8	INT2525-17TT	\$1,288	\$1,415
---------------------	----	----	--------	----	---	--------------	---------	---------



- ships factory assembled
- maple legs standard
- walnut or white oak rims and/or legs available, specify and add \$115 list

Square Lounge Table	35	35	16 1/2	57	15	INT3535-17TT	\$1,447	\$1,593
---------------------	----	----	--------	----	----	--------------	---------	---------



- ships factory assembled
- maple legs standard
- walnut or white oak rims and/or legs available, specify and add \$115 list

To Order, Specify:

- ① Model Number
- ② Top Material:
 - a.) Veneer with STANDARD Maple Solid Hardwood Rims
[See Standard Veneer Top Finish with Maple Solid Hardwood Rim Options](#)
 - 1.) Wood Species - Cherry (CH1), Maple (MA1), Walnut (WA1) or Double Cut (DC1)
 - 2.) Wood Finish Color
 - b.) Laminate with STANDARD Maple Solid Hardwood Rims
[See Solid Laminate Top with Maple Solid Hardwood Rim Options](#)
 Alabaster (ALB), Bridal Blanco (BBL), Designer White (DWH), Shadow (SHD) or Slate Grey (SLG)
 - c.) Walnut Veneer with PREMIUM Walnut Solid Hardwood Rims
[See Walnut Veneer Top with PREMIUM Walnut Solid Hardwood Rim Options](#)
 - 1.) Wood Species - Walnut (WW1)
 - 2.) Wood Finish Color
 - d.) White Oak Veneer with PREMIUM White Oak Solid Hardwood Rims
[See White Oak Veneer Top with PREMIUM White Oak Solid Hardwood Rim Options](#)
 - 1.) Wood Species - White Oak (WK1)
 - 2.) Wood Finish Color
- ③ Leg Wood Species:
 - a.) STANDARD Maple (M)
[See Maple Leg Species/Finish Options](#)
 - 1.) Finish Color or Paint Color on maple legs
 - b.) PREMIUM Walnut (W) - upcharge applies
[See Walnut Leg Species/Finish Options](#)
 - 1.) Finish Color - Walnut finishes only on Walnut legs
 - c.) PREMIUM White Oak (WK1) - upcharge applies
[See White Oak Leg Species/Finish Options](#)
 - 1.) Finish Color - Whitewash finish only on White Oak legs
- ④ Optional Rubber Cushion Nylon Glides - no upcharge

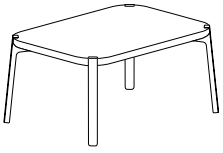
Specifications

- Solid hardwood wood legs with steel plate reinforced mounting.
- 5 ply balanced top construction 1 1/2" thick with profile shaped solid hardwood lumber rims
- Surfaces available in wood veneer or high pressure laminate.
- Standard with rubber cushion metal glides.

Note: Walnut and White Oak Solid hardwoods are PREMIUM materials and upcharges apply. Associated upcharges are located in bullet points under units where applicable. A single upcharge listed applies to any combination of premium materials; premium top, premium legs or premium top and legs.

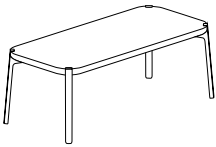
INDIE

Description	D	W	H	CTN WT	CU FT	① Model	Flat Cut List Price	Double Cut List Price
Rectangular Lounge Table	25	35	16½	42	11	INT2535-17TT	\$1,369	\$1,506



- ships factory assembled
- maple legs standard
- walnut or white oak rims and/or legs available, specify and add \$115 list

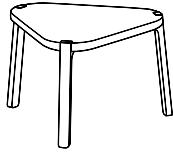
Rectangular Lounge Table	25	55	16½	63	17	INT2555-17TT	\$1,520	\$1,671
--------------------------	----	----	-----	----	----	--------------	---------	---------



- ships factory assembled
- maple legs standard
- walnut or white oak rims and/or legs available, specify and add \$115 list

INDIE

Description	D	W	H	CTN WT	CU FT	1 Model	Flat Cut List Price	Double Cut List Price
Triangular Lounge Table	25	25	16 1/2	23	7	INT2525-17TR	\$1,142	\$1,259



- ships factory assembled
- maple legs standard
- walnut or white oak rims and/or legs available, specify and add \$102 list

Triangular Lounge Table	35	35	16 1/2	35	13	INT3535-17TR	\$1,299	\$1,429
-------------------------	----	----	--------	----	----	--------------	---------	---------



- ships factory assembled
- maple legs standard
- walnut or white oak rims and/or legs available, specify and add \$102 list

To Order, Specify:

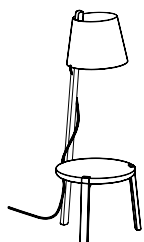
- 1 Model Number
- 2 Top Material:
 - a.) Veneer with STANDARD Maple Solid Hardwood Rims
[See Standard Veneer Top Finish with Maple Solid Hardwood Rim Options](#)
 - 1.) Wood Species - Cherry (CH1), Maple (MA1), Walnut (WA1) or Double Cut (DC1)
 - 2.) Wood Finish Color
 - b.) Laminate with STANDARD Maple Solid Hardwood Rims
[See Solid Laminate Top with Maple Solid Hardwood Rim Options](#)
 Alabaster (ALB), Bridal Blanco (BBL), Designer White (DWH), Shadow (SHD) or Slate Grey (SLG)
 - c.) Walnut Veneer with PREMIUM Walnut Solid Hardwood Rims
[See Walnut Veneer Top with PREMIUM Walnut Solid Hardwood Rim Options](#)
 - 1.) Wood Species - Walnut (WW1)
 - 2.) Wood Finish Color
 - d.) White Oak Veneer with PREMIUM White Oak Solid Hardwood Rims
[See White Oak Veneer Top with PREMIUM White Oak Solid Hardwood Rim Options](#)
 - 1.) Wood Species - White Oak (WK1)
 - 2.) Wood Finish Color
- 3 Leg Wood Species:
 - a.) STANDARD Maple (M)
[See Maple Leg Species/Finish Options](#)
 - 1.) Finish Color or Paint Color on maple legs
 - b.) PREMIUM Walnut (W) - upcharge applies
[See Walnut Leg Species/Finish Options](#)
 - 1.) Finish Color - Walnut finishes only on Walnut legs
 - c.) PREMIUM White Oak (WK1) - upcharge applies
[See White Oak Leg Species/Finish Options](#)
 - 1.) Finish Color - Whitewash finish only on White Oak legs
- 4 Optional Rubber Cushion Nylon Glides - no upcharge

Specifications

- Solid hardwood wood legs with steel plate reinforced mounting.
- 5 ply balanced top construction 1 1/2" thick with profile shaped solid hardwood lumber rims
- Surfaces available in wood veneer or high pressure laminate.
- Standard with rubber cushion metal glides.

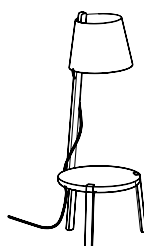
Note: Walnut and White Oak Solid hardwoods are PREMIUM materials and upcharges apply. Associated upcharges are located in bullet points under units where applicable. A single upcharge listed applies to any combination of premium materials; premium top, premium legs or premium top and legs.

Description	D	W	H	CTN WT	CU FT	① Model	Flat Cut List Price	Double Cut List Price
Floor Lamp with 17" h Table	19	19	55 1/2	38	15	INT1919-56RDT	\$1,527	\$1,642



- 15' cord
- cord mounted rocker on/off switch - three prong plug fabric power cord
- specify graphite, yellow or indigo fabric cord color
- maximum 60 watt light bulb, NOT included/LED bulb recommended
- light fixture with 15' cord with on/off switch on cord 32" from light - field assembly
- SELECT Maharam Mode SHADE FABRIC COLOR
- maple legs standard
- walnut or white oak rims and/or legs available, specify and add \$189 list

Floor Lamp with 14" h Table	19	19	52 3/4	35	14	INT1919-53RDT	\$1,526	\$1,640
-----------------------------	----	----	--------	----	----	---------------	---------	---------



- 15' cord
- cord mounted rocker on/off switch - three prong plug fabric power cord
- specify graphite, yellow or indigo fabric cord color
- maximum 60 watt light bulb, NOT included/LED bulb recommended
- light fixture with 15' cord with on/off switch on cord 32" from light - field assembly
- SELECT Maharam Mode SHADE FABRIC COLOR
- maple legs standard
- walnut or white oak rims and/or legs available, specify and add \$189 list

To Order, Specify:

① Model Number

② Top Material:

- a.) Veneer with STANDARD Maple Solid Hardwood Rims
[See Standard Veneer Top Finish with Maple Solid Hardwood Rim Options](#)
 - 1.) Wood Species - Cherry (CH1), Maple (MA1), Walnut (WA1) or Double Cut (DC1)
 - 2.) Wood Finish Color
- b.) Laminate with STANDARD Maple Solid Hardwood Rims
[See Solid Laminate Top with Maple Solid Hardwood Rim Options](#)
 Alabaster (ALB), Bridal Blanco (BBL), Designer White (DWH), Shadow (SHD) or Slate Grey (SLG)
- c.) Walnut Veneer with PREMIUM Walnut Solid Hardwood Rims
[See Walnut Veneer Top with PREMIUM Walnut Solid Hardwood Rim Options](#)
 - 1.) Wood Species - Walnut (WW1)
 - 2.) Wood Finish Color
- d.) White Oak Veneer with PREMIUM White Oak Solid Hardwood Rims
[See White Oak Veneer Top with PREMIUM White Oak Solid Hardwood Rim Options](#)
 - 1.) Wood Species - White Oak (WK1)
 - 2.) Wood Finish Color

③ Leg Wood Species:

- a.) STANDARD Maple (M)
[See Maple Leg Species/Finish Options](#)
 - 1.) Finish Color or Paint Color on maple legs
- b.) PREMIUM Walnut (W) - upcharge applies
[See Walnut Leg Species/Finish Options](#)
 - 1.) Finish Color - Walnut finishes only on Walnut legs
- c.) PREMIUM White Oak (WK1) - upcharge applies
[See White Oak Leg Species/Finish Options](#)
 - 1.) Finish Color - Whitewash finish only on White Oak legs

④ Lamp Shade - Maharam - Mode

www.maharam.com/products for color selection

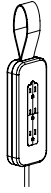
⑤ Optional Rubber Cushion Nylon Glides - no upcharge

Note: Walnut and White Oak Solid hardwoods are PREMIUM materials and upcharges apply. Associated upcharges are located in bullet points under units where applicable. A single upcharge listed applies to any combination of premium materials; premium top, premium legs or premium top and legs.

Specifications

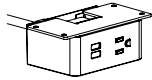
- Solid hardwood wood legs with steel plate reinforced mounting.
- 5 ply balanced top construction 1 1/2" thick with profile shaped solid hardwood lumber rims
- Surfaces available in wood veneer or high pressure laminate.
- Standard with rubber cushion metal glides.

Description	D	W	H	CTN WT	CU FT	① Model	List Price
Free Placement - Power Block	3	10	3			INA0310-POWER	\$515



- 9' cord
- triplex receptacle - three prong plug fabric power cord
- specify graphite, yellow or indigo fabric cord color
- maple block standard
- walnut or white oak block available, specify and add \$20 list

Power Center - Under Mount	2 3/4	4	2 5/8			EC30	\$363
----------------------------	-------	---	-------	--	--	------	-------

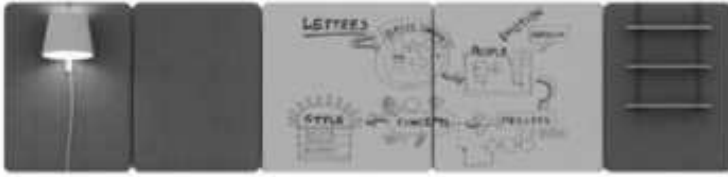


- 10' cord
- frame mounted simplex receptacle and two USB/10' - three prong plug power cord
- specify black or white - cord color will match unit
- optional graphite fabric cord available, specify and add \$187 list
- overall mounting bracket tabs: 5"w

To Order, Specify:

- ① Model Number

Indie Tiles, Screens and Accessories Order Check List:



Specify:

- 1. Model Number
- 2. Wood Species - STANDARD Maple (M) - no upcharge, PREMIUM Walnut (W) or White Oak (WK1) - upcharge applies (accessory: knob, shelves, planter shelves, sconce, tray, cubby shelf and freestanding screen foot support)
- 3. Wood Finish or Paint Color (accessory: knob, shelves, planter shelves, sconce, tray, cubby shelf and freestanding screen foot support)
- 4. Fabric Selection - vendor, pattern and color (puffy, tackboard tiles, cubby units, accessory tackboard and freestanding screens)
- 5. Metal Color - accessories and freestanding screen foot supports

Example:

INF3060-1SUP (model #)	M (wood species)	HRV (finish)	MOMENTUM (fabric vendor)	VOX (pattern name)	MYSTIC (pattern color)	PEW (metal color)
---------------------------	---------------------	-----------------	-----------------------------	-----------------------	---------------------------	----------------------

1. Model Number

Solid Laminate

ALB	Alabaster	DWH	Designer White
BLK	Black	SLG	Slate Grey
BBL	Bridal Blanco		

2. Wood Species - STANDARD Maple (M), PREMIUM Walnut (W) or White Oak (WK1); upcharge applies

Paint Color - Add \$45 list per item - (accessories only)

BKD	Backdrop	GRV	Greek Villa
BFX	Black Fox	GLF	Gulf Stream
BWH	Bright White	HTB	Heartthrob
CGP	Cargo Pants	NET	Network Gray
CHT	Chatroom	NWH	Nonchalant White
DSY	Daisy	PAR	Paradise
DRG	Daring	QXP	Quixotic Plum
DYN	Dynamo	RBZ	Relic Bronze
ENG	Engima	SND	Sandbank
FRR	French Roast	STM	Storm
GBY	Georgian Bay	TRC	Tricorn Black

3. Wood Finish/Color Options:

Maple Frame/Cubby Shelf

ALM	Ale Medium	MCH	Mocha
BBM	Bourbon Medium	CPI	Pinnacle Walnut Coordinate
CBZ	Brazilwood Coordinate		
BRM	Brighton Medium	PRL	Praline
BUT	Butterscotch	RAVC	Raven Coordinate
CND	Cinder Coordinate	SABC	Sable Coordinate
CLA	Classic	SADC	Saddle Coordinate
CLL	Collectors	SIE	Sienna
EGRC	Egret Coordinate	CST	Studio Teak Coordinate
ESP	Espresso	TRF	Truffle
FAWC	Fawn Coordinate	UMB	Umber
FLX	Flax	VALC	Valley Coordinate
CGR	Graphite Coordinate	VEN	Venetian
HRV	Harvest	CWE	Weathered Ash Coordinate
CKC	Khaki Coordinate		
MINC	Mineral Coordinate		

***Note:** Walnut and White Oak Solid Hardwoods are PREMIUM materials and an upcharge applies. Associated upcharges are located in the bullet points under units where applicable.

4. Fabric Selection - Please supply the following:

Fabric vendor/Pattern name/Pattern color

For a complete list of JSI Standard and Graded-In Textiles click [here](#)

- Indicate direction of fabric - Railroaded or Up the Roll
- Please provide illustration, if available

All COM orders must include the following:

***Walnut Frame (upcharge applies)/Cubby Shelf**

ESP	Espresso	TRF	Truffle
MCH	Mocha	UMB	Umber
SIE	Sienna		

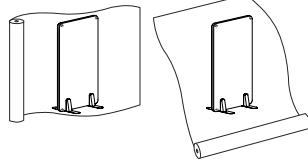
***White Oak Frame (upcharge applies)/Cubby Shelf**

ACR	Acorn	MIN	Mineral
BAR	Barrel	POR	Porter
BUF	Buff	RAV	Raven
BUR	Burlap	RYE	Rye
CHE	Chestnut	SAB	Sable
CND	Cinder	SAD	Saddle
EGR	Egret	WWO	Whitewash

- Vendor's name, pattern name and color
- Sample of the fabric attached to order
- Model numbers of items for fabric application
- Special application instructions
- Customer and purchase order number

Ship prepaid COM material to:
 JSI
 Attn: COM Department
 201 East Martin Street
 Receiving B, Dock 71
 Orleans, IN 47452

Application of fabric:
 Railroaded *Up the Roll



All COM orders will ship at standard lead time from receipt of COM except for orders requiring special custom matched finishes.

*Upholstery can only be cut Up the Roll for 60"h freestanding screen

5. Metal Color:

ABZ	Aged Bronze**	SBZ	Soft Bronze**
GLD	Gold **	SNK	Soft Nickel
MBK	Matte Black	STS	Stardust Silver
PEW	Pewter		

** Select metal finishes - Add \$150 list per item
 JSI's extended powdercoat program of bright colors is available, upon request, on Indie. Contact Customer Service for a specific quote based on qty of units.

6. Power Center

EC30 - Under Mount

- Cubby shelf mounted simplex receptacle and two USB/10' - three prong power cord/field installed.
- Specify Black (B) or White (W) add \$363 list each. Can be left or right mounted under the cubby shelf. Cord color will match unit unless optional Graphite cord is specified. Add \$187 list for optional Graphite cord.

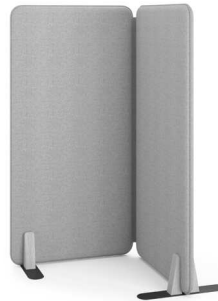
STC (Sound Transmission Class) - represents a material or



product's ability to block sound from traveling through a wall, ceiling, floor or other building assembly.



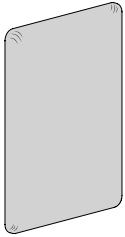
NRC (Noise Reduction Coefficient) - measure the amount of energy absorbed when it strikes a particular surface.



Note: In any application, determining the overall acoustic value of a space can only be determined by testing space with all surface elements present. STC test was performed on a single 60"h x 48"w freestanding screen and NRC test was performed on a double 60"h x 78"w freestanding screen.

Poufy - Upholstered Wall Mount Tile

Description	D	W	H	CTN WT	CU FT	① Model	List Price Per Grade
Rectangular - Poufy Upholstered Wall Mount Tile	1 3/8	36	48	28	3	INW3648RTUP	COM \$664
							A \$680
							B \$712
							C \$765
							D \$835
							E \$906
							F \$1,014
							G \$1,129
							H \$1,254
							I \$1,448
							J \$1,681





- vertical wall mount tile
- supported by aluminum Z clips
- wall fastener hardware provided by installer
- heavy cushioned surface not recommended for tacking
- com ydg: 1 1/2

Rectangular - Poufy Upholstered Wall Mount Tile	1 3/8	30	48	23	2	INW3048RTUP	COM \$661
							A \$677
							B \$707
							C \$762
							D \$831
							E \$902
							F \$1,011
							G \$1,126
							H \$1,251
							I \$1,445
							J \$1,678



- vertical wall mount tile
- supported by aluminum Z clips
- wall fastener hardware provided by installer
- heavy cushioned surface not recommended for tacking
- com ydg: 1 1/2

Description	D	W	H	CTN WT	CU FT	① Model	List Price Per Grade
Rectangular Poufy Upholstered Wall Mount Tile  <ul style="list-style-type: none"> vertical wall mount tile supported by aluminum Z clips wall fastener hardware provided by installer heavy cushioned surface not recommended for tacking com ydg: 1 1/2 	1 3/8	24	48	19	2	INW2448RTUP	COM \$550
	A	\$566					
	B	\$596					
	C	\$651					
	D	\$720					
	E	\$791					
	F	\$899					
	G	\$1,015					
	H	\$1,140					
	I	\$1,334					
	J	\$1,568					

Rectangular Poufy Upholstered Wall Mount Tile  <ul style="list-style-type: none"> vertical wall mount tile supported by aluminum Z clips wall fastener hardware provided by installer heavy cushioned surface not recommended for tacking com ydg: 1 1/2 	1 3/8	18	48	15	2	INW1848RTUP	COM \$487
	A	\$504					
	B	\$533					
	C	\$589					
	D	\$658					
	E	\$728					
	F	\$837					
	G	\$953					
	H	\$1,078					
	I	\$1,271					
	J	\$1,505					

To Order, Specify:

① Model Number

② Fabric Selection - vendor, pattern and color

Visit www.jsifurniture.com/finishes-and-materials/textiles for our textiles program.

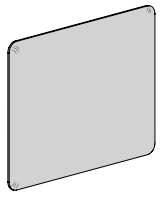
See selection of standard and graded in manufacturers and patterns.

Specifications

- 12mm birch plywood panel frame
- 1/2" polyurethane foam surface cushioning
- extruded aluminum mounting Z clips

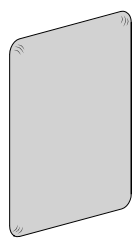
Poufy - Upholstered Wall Mount Tile

Description	D	W	H	CTN WT	CU FT	① Model	List Price Per Grade
Rectangular - Poufy Upholstered Wall Mount Tile	1 3/8	48	36	28	3	INW4836RTUP	COM \$650
							A \$664
							B \$689
							C \$735
							D \$792
							E \$851
							F \$940
							G \$1,039
							H \$1,141
							I \$1,302
							J \$1,497



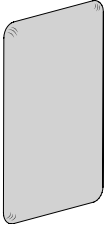
- horizontal wall mount tile
- supported by aluminum Z clips
- wall fastener hardware provided by installer
- heavy cushioned surface not recommended for tacking
- com ydg: 1 1/4


Rectangular - Poufy Upholstered Wall Mount Tile	1 3/8	30	36	18	2	INW3036RTUP	COM \$625
							A \$638
							B \$663
							C \$708
							D \$766
							E \$826
							F \$915
							G \$1,013
							H \$1,115
							I \$1,277
							J \$1,471



- vertical wall mount tile
- supported by aluminum Z clips
- wall fastener hardware provided by installer
- heavy cushioned surface not recommended for tacking
- com ydg: 1 1/4

INDIE

Description	D	W	H	CTN WT	CU FT	① Model	List Price Per Grade
Rectangular - Poufy Upholstered Wall Mount Tile  <ul style="list-style-type: none"> vertical wall mount tile supported by aluminum Z clips wall fastener hardware provided by installer heavy cushioned surface not recommended for tacking com ydg: 1 ¼ 	1 ¾	24	36	15	2	INW2436RTUP	COM \$519
	A	\$532					
	B	\$557					
	C	\$604					
	D	\$662					
	E	\$720					
	F	\$810					
	G	\$909					
	H	\$1,011					
	I	\$1,172					
	J	\$1,366					

Rectangular - Poufy Upholstered Wall Mount Tile  <ul style="list-style-type: none"> vertical wall mount tile supported by aluminum Z clips wall fastener hardware provided by installer heavy cushioned surface not recommended for tacking com ydg: 1 ¼ 	1 ¾	18	36	11	1	INW1836RTUP	COM \$429
	A	\$443					
	B	\$468					
	C	\$514					
	D	\$571					
	E	\$631					
	F	\$720					
	G	\$818					
	H	\$921					
	I	\$1,083					
	J	\$1,277					

To Order, Specify:

- ① Model Number
 - ② Fabric Selection - vendor, pattern and color
- Visit www.jsifurniture.com/finishes-and-materials/textiles for our textiles program.
See selection of standard and graded in manufacturers and patterns.

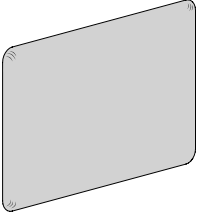
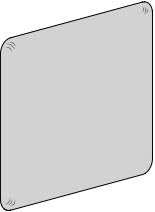
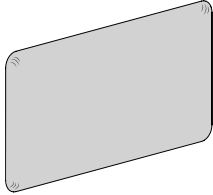
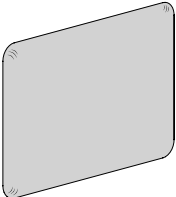
Specifications

- 12mm birch plywood panel frame
- ½" polyurethane foam surface cushioning
- extruded aluminum mounting Z clips

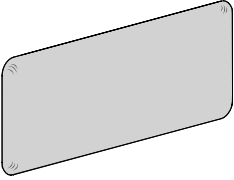
Indie

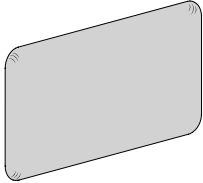
Poufy - Upholstered Wall Mount Tile



Description	D	W	H	CTN WT	CU FT	① Model	List Price Per Grade
Rectangular - Poufy Upholstered Wall Mount Tile 	1 3/8	48	30	23	2	INW4830RTUP	COM \$642
	<ul style="list-style-type: none"> horizontal wall mount tile supported by aluminum Z clips wall fastener hardware provided by installer heavy cushioned surface not recommended for tacking com ydg: 1 						A \$653 B \$675 C \$712 D \$757 E \$804 F \$876 G \$954 H \$1,037 I \$1,166 J \$1,321
Rectangular - Poufy Upholstered Wall Mount Tile 	1 3/8	36	30	18	2	INW3630RTUP	COM \$607
	<ul style="list-style-type: none"> horizontal wall mount tile supported by aluminum Z clips wall fastener hardware provided by installer heavy cushioned surface not recommended for tacking com ydg: 1 						A \$618 B \$639 C \$676 D \$722 E \$768 F \$841 G \$918 H \$1,001 I \$1,130 J \$1,285
Rectangular - Poufy Upholstered Wall Mount Tile 	1 3/8	48	24	19	2	INW4824RTUP	COM \$550
	<ul style="list-style-type: none"> horizontal wall mount tile supported by aluminum Z clips wall fastener hardware provided by installer heavy cushioned surface not recommended for tacking com ydg: 1 						A \$561 B \$582 C \$618 D \$664 E \$712 F \$783 G \$861 H \$942 I \$1,073 J \$1,227
Rectangular - Poufy Upholstered Wall Mount Tile 	1 3/8	36	24	15	2	INW3624RTUP	COM \$503
	<ul style="list-style-type: none"> horizontal wall mount tile supported by aluminum Z clips wall fastener hardware provided by installer heavy cushioned surface not recommended for tacking com ydg: 1 						A \$513 B \$533 C \$570 D \$617 E \$664 F \$736 G \$813 H \$896 I \$1,025 J \$1,179

INDIE

Description	D	W	H	CTN WT	CU FT	① Model	List Price Per Grade
Rectangular - Poufy Upholstered Wall Mount Tile  <ul style="list-style-type: none"> horizontal wall mount tile supported by aluminum Z clips wall fastener hardware provided by installer heavy cushioned surface not recommended for tacking com ydg: ¾ 	1 ¾	48	18	15	2	INW4818RTUP	COM \$470
	A	\$479					
	B	\$494					
	C	\$521					
	D	\$556					
	E	\$592					
	F	\$647					
	G	\$704					
	H	\$766					
	I	\$864					
J	\$979						

Rectangular - Poufy Upholstered Wall Mount Tile  <ul style="list-style-type: none"> horizontal wall mount tile supported by aluminum Z clips wall fastener hardware provided by installer heavy cushioned surface not recommended for tacking com ydg: ¾ 	1 ¾	36	18	11	1	INW3618RTUP	COM \$431
	A	\$439					
	B	\$455					
	C	\$481					
	D	\$517					
	E	\$552					
	F	\$606					
	G	\$664					
	H	\$726					
	I	\$824					
J	\$939						

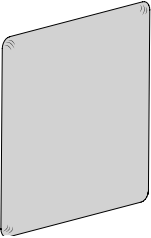
To Order, Specify:

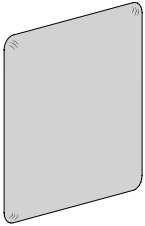
- ① Model Number
 - ② Fabric Selection - vendor, pattern and color
- Visit www.jsifurniture.com/finishes-and-materials/textiles for our textiles program.
See selection of standard and graded in manufacturers and patterns.

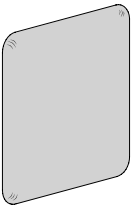
Specifications

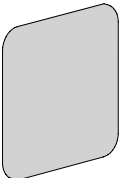
- 12mm birch plywood panel frame
- ½" polyurethane foam surface cushioning
- extruded aluminum mounting Z clips

Poufy - Upholstered Wall Mount Tile

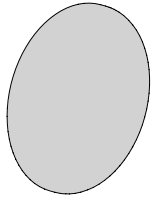
Description	D	W	H	CTN WT	CU FT	① Model	List Price Per Grade	
Square - Poufy Upholstered Wall Mount Tile  <ul style="list-style-type: none"> · supported by aluminum Z clips · wall fastener hardware provided by installer · heavy cushioned surface not recommended for tacking · com ydg: 1 ½ 	1 ¾	48	48	38	3	INW4848SQUP	COM \$686	
	A							\$703
	B							\$734
	C							\$788
	D							\$856
	E							\$928
	F							\$1,037
	G							\$1,152
	H							\$1,277
	I							\$1,470
J							\$1,704	

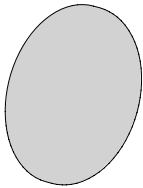
Square - Poufy Upholstered Wall Mount Tile  <ul style="list-style-type: none"> · supported by aluminum Z clips · wall fastener hardware provided by installer · heavy cushioned surface not recommended for tacking · com ydg: 1 ¼ 	1 ¾	36	36	21	2	INW3636SQUP	COM \$641	
	A							\$655
	B							\$680
	C							\$726
	D							\$785
	E							\$843
	F							\$933
	G							\$1,031
	H							\$1,133
	I							\$1,295
J							\$1,489	

Square - Poufy Upholstered Wall Mount Tile  <ul style="list-style-type: none"> · supported by aluminum Z clips · wall fastener hardware provided by installer · heavy cushioned surface not recommended for tacking · com ydg: 1 	1 ¾	24	24	10	1	INW2424SQUP	COM \$436	
	A							\$445
	B							\$467
	C							\$504
	D							\$550
	E							\$596
	F							\$669
	G							\$747
	H							\$829
	I							\$959
J							\$1,113	

Square - Poufy Upholstered Wall Mount Tile  <ul style="list-style-type: none"> · supported by aluminum Z clips · wall fastener hardware provided by installer · heavy cushioned surface not recommended for tacking · com ydg: ¾ 	1 ¾	18	18	7	1	INW1818SQUP	COM \$394	
	A							\$402
	B							\$418
	C							\$444
	D							\$480
	E							\$515
	F							\$569
	G							\$628
	H							\$690
	I							\$787
J							\$904	

INDIE

Description	D	W	H	CTN WT	CU FT	① Model	List Price Per Grade
Round - Poufy Upholstered Wall Mount Tile 	1 3/8	24	24	10	1	INW24RDUP	COM \$436 A \$445 B \$467 C \$504 D \$550 E \$596 F \$669 G \$747 H \$829 I \$959 J \$1,113
<ul style="list-style-type: none"> · supported by aluminum Z clips · wall fastener hardware provided by installer · heavy cushioned surface not recommended for tacking · com ydg: 1 							

Round - Poufy Upholstered Wall Mount Tile 	1 3/8	18	18	7	1	INW18RDUP	COM \$394 A \$402 B \$418 C \$444 D \$480 E \$515 F \$569 G \$628 H \$690 I \$787 J \$904
<ul style="list-style-type: none"> · supported by aluminum Z clips · wall fastener hardware provided by installer · heavy cushioned surface not recommended for tacking · com ydg: 3/4 							

To Order, Specify:

① Model Number

② Fabric Selection - vendor, pattern and color

Visit www.jsifurniture.com/finishes-and-materials/textiles for our textiles program.

See selection of standard and graded in manufacturers and patterns.

Specifications

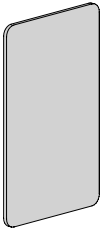
- 12mm birch plywood panel frame
- 1/2" polyurethane foam surface cushioning
- extruded aluminum mounting Z clips

Tackboard - Upholstered Wall Mount Tile

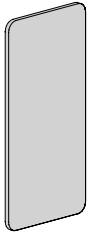
Description	D	W	H	CTN WT	CU FT	① Model	List Price Per Grade
Rectangular - Tackboard Upholstered Wall Mount Tile	1	36	48	28	3	INW3648RTUT	COM \$689
<ul style="list-style-type: none"> · vertical wall mount tile · supported by aluminum Z clips · wall fastener hardware provided by installer · com ydg: 1 ½ 							A \$705 B \$736 C \$790 D \$860 E \$930 F \$1,039 G \$1,154 H \$1,279 I \$1,472 J \$1,706

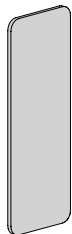


Rectangular - Tackboard Upholstered Wall Mount Tile	1	30	48	23	2	INW3048RTUT	COM \$677
<ul style="list-style-type: none"> · vertical wall mount tile · supported by aluminum Z clips · wall fastener hardware provided by installer · com ydg: 1 ½ 							A \$693 B \$724 C \$778 D \$848 E \$918 F \$1,027 G \$1,142 H \$1,268 I \$1,461 J \$1,694



INDIE

Description	D	W	H	CTN WT	CU FT	① Model	List Price Per Grade
Rectangular - Tackboard Upholstered Wall Mount Tile  <ul style="list-style-type: none"> vertical wall mount tile supported by aluminum Z clips wall fastener hardware provided by installer com ydg: 1 ½ 	1	24	48	19	2	INW2448RTUT	COM \$587
	A	\$603					
	B	\$633					
	C	\$688					
	D	\$757					
	E	\$828					
	F	\$936					
	G	\$1,052					
	H	\$1,176					
	I	\$1,370					
	J	\$1,604					

Rectangular - Tackboard Upholstered Wall Mount Tile  <ul style="list-style-type: none"> vertical wall mount tile supported by aluminum Z clips wall fastener hardware provided by installer com ydg: 1 ½ 	1	18	48	15	2	INW1848RTUT	COM \$518
	A	\$533					
	B	\$565					
	C	\$619					
	D	\$689					
	E	\$760					
	F	\$868					
	G	\$983					
	H	\$1,109					
	I	\$1,301					
	J	\$1,535					

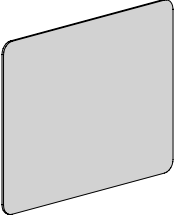
To Order, Specify:


- ① Model Number
 - ② Fabric Selection - vendor, pattern and color
- Visit www.jsifurniture.com/finishes-and-materials/textiles for our textiles program.
See selection of standard and graded in manufacturers and patterns.

Specifications


- ½" soft tack core face
- ¼" hard board backer panel
- covered with surface glued and stapled upholstery
- extruded aluminum mounting Z clips


Tackboard - Upholstered Wall Mount Tile

Description	D	W	H	CTN WT	CU FT	① Model	List Price Per Grade
Rectangular - Tackboard Upholstered Wall Mount Tile  <ul style="list-style-type: none"> · horizontal wall mount tile · supported by aluminum Z clips · wall fastener hardware provided by installer · com ydg: 1 ¼ 	1	48	36	28	3	INW4836RTUT	COM \$673 A \$686 B \$712 C \$757 D \$814 E \$874 F \$963 G \$1,061 H \$1,164 I \$1,325 J \$1,520

Rectangular - Tackboard Upholstered Wall Mount Tile  <ul style="list-style-type: none"> · vertical wall mount tile · supported by aluminum Z clips · wall fastener hardware provided by installer · com ydg: 1 ¼ 	1	30	36	18	2	INW3036RTUT	COM \$640 A \$654 B \$679 C \$725 D \$783 E \$842 F \$931 G \$1,029 H \$1,132 I \$1,294 J \$1,488
---	---	----	----	----	---	-------------	---

INDIE

Description	D	W	H	CTN WT	CU FT	① Model	List Price Per Grade
Rectangular - Tackboard Upholstered Wall Mount Tile  <ul style="list-style-type: none"> vertical wall mount tile supported by aluminum Z clips wall fastener hardware provided by installer com ydg: 1 ¼ 	1	24	36	15	2	INW2436RTUT	COM \$524
	A	\$539					
	B	\$563					
	C	\$608					
	D	\$667					
	E	\$725					
	F	\$814					
	G	\$913					
	H	\$1,015					
	I	\$1,176					
	J	\$1,371					

Rectangular - Tackboard Upholstered Wall Mount Tile  <ul style="list-style-type: none"> vertical wall mount tile supported by aluminum Z clips wall fastener hardware provided by installer com ydg: 1 ¼ 	1	18	36	11	1	INW1836RTUT	COM \$438
	A	\$453					
	B	\$477					
	C	\$523					
	D	\$581					
	E	\$639					
	F	\$728					
	G	\$827					
	H	\$929					
	I	\$1,090					
	J	\$1,285					

To Order, Specify:

① Model Number

② Fabric Selection - vendor, pattern and color

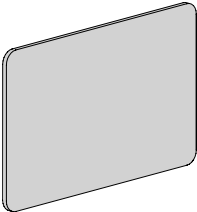
Visit www.jsifurniture.com/finishes-and-materials/textiles for our textiles program.

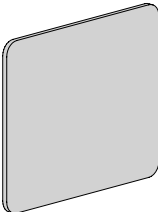
See selection of standard and graded in manufacturers and patterns.

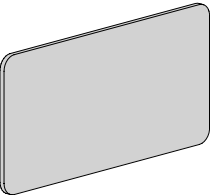
Specifications

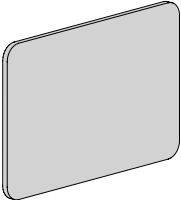
- ½" soft tack core face
- ¼" hard board backer panel
- covered with surface glued and stapled upholstery
- extruded aluminum mounting Z clips

Tackboard - Upholstered Wall Mount Tile

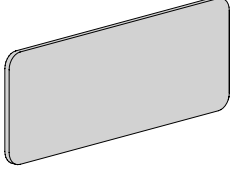
Description	D	W	H	CTN WT	CU FT	① Model	List Price Per Grade
Rectangular - Tackboard Upholstered Wall Mount Tile  <ul style="list-style-type: none"> horizontal wall mount tile supported by aluminum Z clips wall fastener hardware provided by installer com ydg: 1 	1	48	30	23	2	INW4830RTUT	COM \$656
	A \$668						
	B \$689						
	C \$725						
	D \$771						
	E \$818						
	F \$890						
	G \$968						
	H \$1,050						
	I \$1,179						
	J \$1,335						

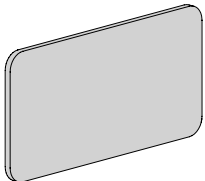
Rectangular - Tackboard Upholstered Wall Mount Tile  <ul style="list-style-type: none"> horizontal wall mount tile supported by aluminum Z clips wall fastener hardware provided by installer com ydg: 1 	1	36	30	18	2	INW3630RTUT	COM \$626
	A \$636						
	B \$656						
	C \$693						
	D \$740						
	E \$787						
	F \$858						
	G \$936						
	H \$1,018						
	I \$1,148						
	J \$1,302						

Rectangular - Tackboard Upholstered Wall Mount Tile  <ul style="list-style-type: none"> horizontal wall mount tile supported by aluminum Z clips wall fastener hardware provided by installer com ydg: 1 	1	48	24	19	2	INW4824RTUT	COM \$587
	A \$596						
	B \$618						
	C \$654						
	D \$701						
	E \$748						
	F \$819						
	G \$897						
	H \$979						
	I \$1,110						
	J \$1,263						

Rectangular - Tackboard Upholstered Wall Mount Tile  <ul style="list-style-type: none"> horizontal wall mount tile supported by aluminum Z clips wall fastener hardware provided by installer com ydg: 1 	1	36	24	15	2	INW3624RTUT	COM \$507
	A \$518						
	B \$540						
	C \$576						
	D \$621						
	E \$669						
	F \$741						
	G \$818						
	H \$900						
	I \$1,031						
	J \$1,185						

INDIE

Description	D	W	H	CTN WT	CU FT	① Model	List Price Per Grade
Rectangular - Tackboard Upholstered Wall Mount Tile  <ul style="list-style-type: none"> horizontal wall mount tile supported by aluminum Z clips wall fastener hardware provided by installer com ydg: ¾ 	1	48	18	15	2	INW4818RTUT	COM \$502
	A	\$509					
	B	\$525					
	C	\$552					
	D	\$588					
	E	\$623					
	F	\$677					
	G	\$735					
	H	\$798					
	I	\$893					
	J	\$1,011					

Rectangular - Tackboard Upholstered Wall Mount Tile  <ul style="list-style-type: none"> horizontal wall mount tile supported by aluminum Z clips wall fastener hardware provided by installer com ydg: ¾ 	1	36	18	11	1	INW3618RTUT	COM \$460
	A	\$468					
	B	\$483					
	C	\$511					
	D	\$546					
	E	\$582					
	F	\$636					
	G	\$693					
	H	\$756					
	I	\$852					
	J	\$970					

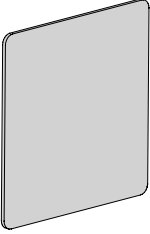
To Order, Specify:

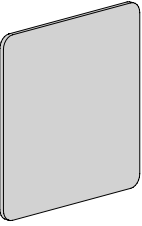
- ① Model Number
 - ② Fabric Selection - vendor, pattern and color
- Visit www.jsifurniture.com/finishes-and-materials/textiles for our textiles program.
See selection of standard and graded in manufacturers and patterns.

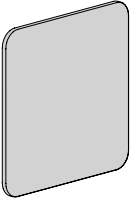
Specifications


- ½" soft tack core face
- ¼" hard board backer panel
- covered with surface glued and stapled upholstery
- extruded aluminum mounting Z clips

Tackboard - Upholstered Wall Mount Tile

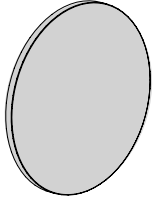
Description	D	W	H	CTN WT	CU FT	① Model	List Price Per Grade
Square - Tackboard Upholstered Wall Mount Tile  <ul style="list-style-type: none"> · supported by aluminum Z clips · wall fastener hardware provided by installer · com ydg: 1 ½ 	1	48	48	38	3	INW4848SQUT	COM \$737
	A \$754						
	B \$785						
	C \$839						
	D \$909						
	E \$978						
	F \$1,087						
	G \$1,203						
	H \$1,327						
	I \$1,521						
J \$1,754							

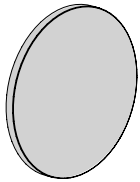
Square - Tackboard Upholstered Wall Mount Tile  <ul style="list-style-type: none"> · supported by aluminum Z clips · wall fastener hardware provided by installer · com ydg: 1 ¼ 	1	36	36	21	2	INW3636SQUT	COM \$686
	A \$701						
	B \$725						
	C \$771						
	D \$829						
	E \$888						
	F \$977						
	G \$1,076						
	H \$1,177						
	I \$1,339						
J \$1,534							

Square - Tackboard Upholstered Wall Mount Tile  <ul style="list-style-type: none"> · supported by aluminum Z clips · wall fastener hardware provided by installer · com ydg: 1 	1	24	24	10	1	INW2424SQUT	COM \$465
	A \$476						
	B \$497						
	C \$532						
	D \$579						
	E \$627						
	F \$699						
	G \$776						
	H \$858						
	I \$989						
J \$1,142							

Square - Tackboard Upholstered Wall Mount Tile  <ul style="list-style-type: none"> · supported by aluminum Z clips · wall fastener hardware provided by installer · com ydg: ¾ 	1	18	18	7	1	INW1818SQUT	COM \$416
	A \$424						
	B \$439						
	C \$466						
	D \$502						
	E \$537						
	F \$591						
	G \$649						
	H \$712						
	I \$807						
J \$925							

INDIE

Description	D	W	H	CTN WT	CU FT	① Model	List Price Per Grade
Round - Tackboard Upholstered Wall Mount Tile  <ul style="list-style-type: none"> · supported by aluminum Z clips · wall fastener hardware provided by installer · com ydg: 1 	1	24	24	10	1	INW24RDUT	COM \$465 A \$476 B \$497 C \$532 D \$579 E \$627 F \$699 G \$776 H \$858 I \$989 J \$1,142

Round - Tackboard Upholstered Wall Mount Tile  <ul style="list-style-type: none"> · supported by aluminum Z clips · wall fastener hardware provided by installer · com ydg: ¾ 	1	18	18	7	1	INW18RDUT	COM \$416 A \$424 B \$439 C \$466 D \$502 E \$537 F \$591 G \$649 H \$712 I \$807 J \$925
---	---	----	----	---	---	-----------	---

To Order, Specify:

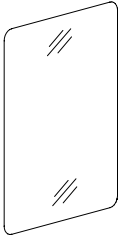
- ① Model Number
 - ② Fabric Selection - vendor, pattern and color
- Visit www.jsifurniture.com/finishes-and-materials/textiles for our textiles program.
See selection of standard and graded in manufacturers and patterns.

Specifications

- ½" soft tack core face
- ¼" hard board backer panel
- covered with surface glued and stapled upholstery
- extruded aluminum mounting Z clips

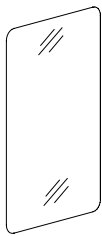
Glass Magnetic Marker - Wall Mount Tile

Description	D	W	H	CTN WT	CU FT	Model	List Price
Rectangular - Glass Magnetic Wall Mounted Marker Tile	5/8	36	48	39	4	INW3648RTMBG	\$3,312



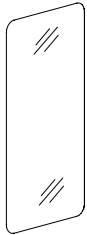
- vertical wall mount tile
- supported by aluminum Z clips
- wall fastener hardware provided by installer
- 4mm white back painted tempered glass
- hidden aluminum 1/2" thin profile frame
- metal backer sheet for use with magnets

Rectangular - Glass Magnetic Wall Mounted Marker Tile	5/8	30	48	32	4	INW3048RTMBG	\$2,643
---	-----	----	----	----	---	--------------	---------



- vertical wall mount tile
- supported by aluminum Z clips
- wall fastener hardware provided by installer
- 4mm white back painted tempered glass
- hidden aluminum 1/2" thin profile frame
- metal backer sheet for use with magnets

Rectangular - Glass Magnetic Wall Mounted Marker Tile	5/8	24	48	26	3	INW2448RTMBG	\$2,374
---	-----	----	----	----	---	--------------	---------



- vertical wall mount tile
- supported by aluminum Z clips
- wall fastener hardware provided by installer
- 4mm white back painted tempered glass
- hidden aluminum 1/2" thin profile frame
- metal backer sheet for use with magnets

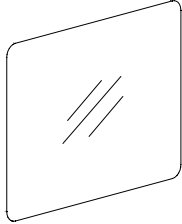
Rectangular - Glass Magnetic Wall Mounted Marker Tile	5/8	18	48	20	2	INW1848RTMBG	\$1,694
---	-----	----	----	----	---	--------------	---------



- vertical wall mount tile
- supported by aluminum Z clips
- wall fastener hardware provided by installer
- 4mm white back painted tempered glass
- hidden aluminum 1/2" thin profile frame
- metal backer sheet for use with magnets

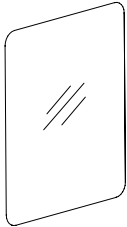
INDIE

Description	D	W	H	CTN WT	CU FT	① Model	List Price
Rectangular - Glass Magnetic Wall Mounted Marker Tile	5/8	48	36	39	4	INW4836RTMBG	\$3,368



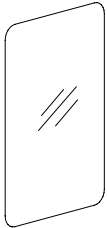
- horizontal wall mount tile
- supported by aluminum Z clips
- wall fastener hardware provided by installer
- 4mm white back painted tempered glass
- hidden aluminum 1/2" thin profile frame
- metal backer sheet for use with magnets

Rectangular - Glass Magnetic Wall Mounted Marker Tile	5/8	30	36	25	3	INW3036RTMBG	\$2,041
---	-----	----	----	----	---	--------------	---------



- vertical wall mount tile
- supported by aluminum Z clips
- wall fastener hardware provided by installer
- 4mm white back painted tempered glass
- hidden aluminum 1/2" thin profile frame
- metal backer sheet for use with magnets

Rectangular - Glass Magnetic Wall Mounted Marker Tile	5/8	24	36	20	2	INW2436RTMBG	\$1,932
---	-----	----	----	----	---	--------------	---------



- vertical wall mount tile
- supported by aluminum Z clips
- wall fastener hardware provided by installer
- 4mm white back painted tempered glass
- hidden aluminum 1/2" thin profile frame
- metal backer sheet for use with magnets

Rectangular - Glass Magnetic Wall Mounted Marker Tile	5/8	18	36	15	2	INW1836RTMBG	\$1,408
---	-----	----	----	----	---	--------------	---------



- vertical wall mount tile
- supported by aluminum Z clips
- wall fastener hardware provided by installer
- 4mm white back painted tempered glass
- hidden aluminum 1/2" thin profile frame
- metal backer sheet for use with magnets

To Order, Specify:

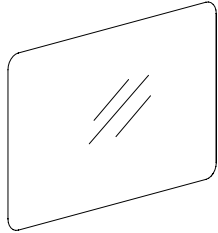
① Model Number

Specifications

- 4mm white back painted tempered glass marker surface
- 20 gauge metal backer sheet for magnet application
- 1/2" thin profile hidden extruded aluminum frame
- extruded aluminum mounting Z clips

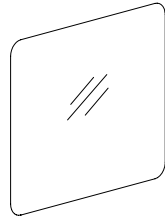
Glass Magnetic Marker - Wall Mount Tile

Description	D	W	H	CTN WT	CU FT	① Model	List Price
Rectangular - Glass Magnetic Wall Mounted Marker Tile	5/8	48	30	32	4	INW4830RTMBG	\$2,725



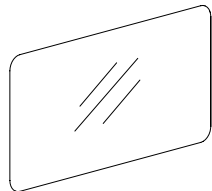
- horizontal wall mount tile
- supported by aluminum Z clips
- wall fastener hardware provided by installer
- 4mm white back painted tempered glass
- hidden aluminum 1/2" thin profile frame
- metal backer sheet for use with magnets

Rectangular - Glass Magnetic Wall Mounted Marker Tile	5/8	36	30	25	3	INW3630RTMBG	\$2,069
---	-----	----	----	----	---	--------------	---------



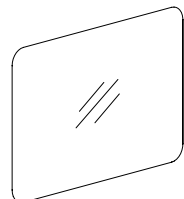
- horizontal wall mount tile
- supported by aluminum Z clips
- wall fastener hardware provided by installer
- 4mm white back painted tempered glass
- hidden aluminum 1/2" thin profile frame
- metal backer sheet for use with magnets

Rectangular - Glass Magnetic Wall Mounted Marker Tile	5/8	48	24	26	3	INW4824RTMBG	\$2,485
---	-----	----	----	----	---	--------------	---------



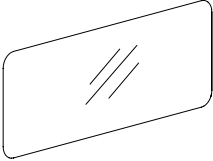
- horizontal wall mount tile
- supported by aluminum Z clips
- wall fastener hardware provided by installer
- 4mm white back painted tempered glass
- hidden aluminum 1/2" thin profile frame
- metal backer sheet for use with magnets

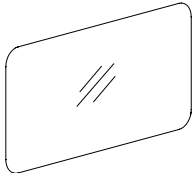
Rectangular - Glass Magnetic Wall Mounted Marker Tile	5/8	36	24	20	2	INW3624RTMBG	\$1,985
---	-----	----	----	----	---	--------------	---------



- horizontal wall mount tile
- supported by aluminum Z clips
- wall fastener hardware provided by installer
- 4mm white back painted tempered glass
- hidden aluminum 1/2" thin profile frame
- metal backer sheet for use with magnets

INDIE

Description	D	W	H	CTN WT	CU FT	① Model	List Price
Rectangular - Glass Magnetic Wall Mounted Marker Tile 	5/8	48	18	20	2	INW4818RTMBG	\$1,832
<ul style="list-style-type: none"> horizontal wall mount tile supported by aluminum Z clips wall fastener hardware provided by installer 4mm white back painted tempered glass hidden aluminum 1/2" thin profile frame metal backer sheet for use with magnets 							

Rectangular - Glass Magnetic Wall Mounted Marker Tile 	5/8	36	18	15	2	INW3618RTMBG	\$1,490
<ul style="list-style-type: none"> horizontal wall mount tile supported by aluminum Z clips wall fastener hardware provided by installer 4mm white back painted tempered glass hidden aluminum 1/2" thin profile frame metal backer sheet for use with magnets 							

To Order, Specify:

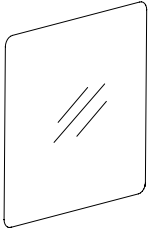
① Model Number

Specifications

- 4mm white back painted tempered glass marker surface
- 20 gauge metal backer sheet for magnet application
- 1/2" thin profile hidden extruded aluminum frame
- extruded aluminum mounting Z clips

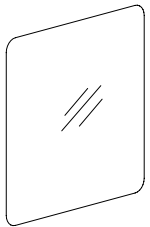
Glass Magnetic Marker - Wall Mount Tile

Description	D	W	H	CTN WT	CU FT	① Model	List Price
Square - Glass Magnetic Wall Mounted Marker Tile	5/8	48	48	50	6	INW4848SQMBG	\$3,927



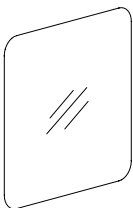
- supported by aluminum Z clips
- wall fastener hardware provided by installer
- 4mm white back painted tempered glass
- hidden aluminum 1/2" thin profile frame
- metal backer sheet for use with magnets

Square - Glass Magnetic Wall Mounted Marker Tile	5/8	36	36	30	3	INW3636SQMBG	\$2,453
--	-----	----	----	----	---	--------------	---------



- supported by aluminum Z clips
- wall fastener hardware provided by installer
- 4mm white back painted tempered glass
- hidden aluminum 1/2" thin profile frame
- metal backer sheet for use with magnets

Square - Glass Magnetic Wall Mounted Marker Tile	5/8	24	24	14	2	INW2424SQMBG	\$1,358
--	-----	----	----	----	---	--------------	---------



- supported by aluminum Z clips
- wall fastener hardware provided by installer
- 4mm white back painted tempered glass
- hidden aluminum 1/2" thin profile frame
- metal backer sheet for use with magnets

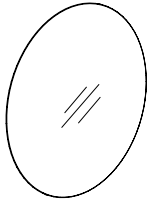
Square - Glass Magnetic Wall Mounted Marker Tile	5/8	18	18	9	1	INW1818SQMBG	\$982
--	-----	----	----	---	---	--------------	-------



- supported by aluminum Z clips
- wall fastener hardware provided by installer
- 4mm white back painted tempered glass
- hidden aluminum 1/2" thin profile frame
- metal backer sheet for use with magnets

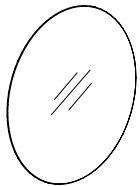
INDIE

Description	D	W	H	CTN WT	CU FT	① Model	List Price
Round - Glass Magnetic Wall Mounted Marker Tile	5/8	24	24	12	2	INW24RDMBG	\$2,262



- supported by aluminum Z clips
- wall fastener hardware provided by installer
- 4mm white back painted tempered glass
- hidden aluminum 1/2" thin profile frame
- metal backer sheet for use with magnets

Round - Glass Magnetic Wall Mounted Marker Tile	5/8	18	18	9	1	INW18RDMBG	\$1,832
---	-----	----	----	---	---	------------	---------



- supported by aluminum Z clips
- wall fastener hardware provided by installer
- 4mm white back painted tempered glass
- hidden aluminum 1/2" thin profile frame
- metal backer sheet for use with magnets

To Order, Specify:

① Model Number

Specifications

- 4mm white back painted tempered glass marker surface
- 20 gauge metal backer sheet for magnet application
- 1/2" thin profile hidden extruded aluminum frame
- extruded aluminum mounting Z clips

Indie

Laminate - Marker Wall Mount Tile



Description	D	W	H	CTN WT	CU FT	① Model	List Price
Rectangular - Laminate Wall Mount Marker Tile	1	36	48	43	3	INW3648RTMBL	\$983



- vertical wall mount tile
- supported by aluminum Z clips
- wall fastener hardware provided by installer
- white markerboard high pressure laminate
- white edge band

Rectangular - Laminate Wall Mount Marker Tile	1	30	48	37	2	INW3048RTMBL	\$867
---	---	----	----	----	---	--------------	-------



- vertical wall mount tile
- supported by aluminum Z clips
- wall fastener hardware provided by installer
- white markerboard high pressure laminate
- white edge band

Rectangular - Laminate Wall Mount Marker Tile	1	24	48	30	2	INW2448RTMBL	\$749
---	---	----	----	----	---	--------------	-------



- vertical wall mount tile
- supported by aluminum Z clips
- wall fastener hardware provided by installer
- white markerboard high pressure laminate
- white edge band

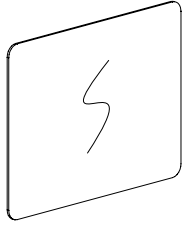
Rectangular - Laminate Wall Mount Marker Tile	1	18	48	22	2	INW1848RTMBL	\$596
---	---	----	----	----	---	--------------	-------



- vertical wall mount tile
- supported by aluminum Z clips
- wall fastener hardware provided by installer
- white markerboard high pressure laminate
- white edge band

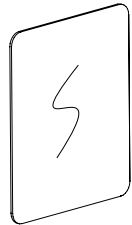
INDIE

Description	D	W	H	CTN WT	CU FT	① Model	List Price
Rectangular - Laminate Wall Mount Marker Tile	1	48	36	43	3	INW4836RTMBL	\$983



- horizontal wall mount tile
- supported by aluminum Z clips
- wall fastener hardware provided by installer
- white markerboard high pressure laminate
- white edge band

Rectangular - Laminate Wall Mount Marker Tile	1	30	36	28	2	INW3036RTMBL	\$722
---	---	----	----	----	---	--------------	-------



- horizontal wall mount tile
- supported by aluminum Z clips
- wall fastener hardware provided by installer
- white markerboard high pressure laminate
- white edge band

Rectangular - Laminate Wall Mount Marker Tile	1	24	36	22	2	INW2436RTMBL	\$545
---	---	----	----	----	---	--------------	-------



- vertical wall mount tile
- supported by aluminum Z clips
- wall fastener hardware provided by installer
- white markerboard high pressure laminate
- white edge band

Rectangular - Laminate Wall Mount Marker Tile	1	18	36	18	1	INW1836RTMBL	\$512
---	---	----	----	----	---	--------------	-------



- vertical wall mount tile
- supported by aluminum Z clips
- wall fastener hardware provided by installer
- white markerboard high pressure laminate
- white edge band

To Order, Specify:

① Model Number

Specifications

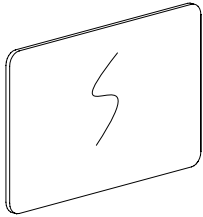
- 3/4" thickness, 3 ply balanced construction
- 1mm PVC edge
- white high pressure marker laminate face
- phenolic balancing backer panel
- extruded aluminum mounting Z clips

Indie

Laminate - Marker Wall Mount Tile

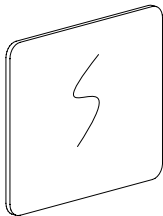


Description	D	W	H	CTN WT	CU FT	① Model	List Price
Rectangular - Laminate Wall Mount Marker Tile	1	48	30	37	2	INW4830RTMBL	\$867



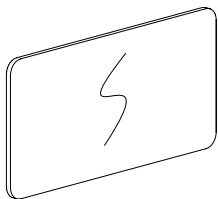
- horizontal wall mount tile
- supported by aluminum Z clips
- wall fastener hardware provided by installer
- white markerboard high pressure laminate
- white edge band

Rectangular - Laminate Wall Mount Marker Tile	1	36	30	28	2	INW3630RTMBL	\$722
---	---	----	----	----	---	--------------	-------



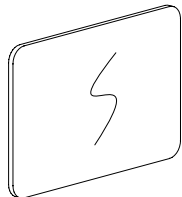
- horizontal wall mount tile
- supported by aluminum Z clips
- wall fastener hardware provided by installer
- white markerboard high pressure laminate
- white edge band

Rectangular - Laminate Wall Mount Marker Tile	1	48	24	30	2	INW4824RTMBL	\$749
---	---	----	----	----	---	--------------	-------



- horizontal wall mount tile
- supported by aluminum Z clips
- wall fastener hardware provided by installer
- white markerboard high pressure laminate
- white edge band

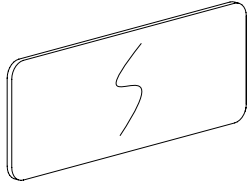
Rectangular - Laminate Wall Mount Marker Tile	1	36	24	22	2	INW3624RTMBL	\$545
---	---	----	----	----	---	--------------	-------



- horizontal wall mount tile
- supported by aluminum Z clips
- wall fastener hardware provided by installer
- white markerboard high pressure laminate
- white edge band

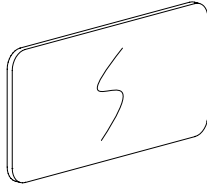
INDIE

Description	D	W	H	CTN WT	CU FT	① Model	List Price
Rectangular - Laminate Wall Mount Marker Tile	1	48	18	22	2	INW4818RTMBL	\$596



- horizontal wall mount tile
- supported by aluminum Z clips
- wall fastener hardware provided by installer
- white markerboard high pressure laminate
- white edge band

Rectangular - Laminate Wall Mount Marker Tile	1	36	18	18	1	INW3618RTMBL	\$512
---	---	----	----	----	---	--------------	-------



- horizontal wall mount tile
- supported by aluminum Z clips
- wall fastener hardware provided by installer
- white markerboard high pressure laminate
- white edge band

To Order, Specify:

① Model Number

Specifications

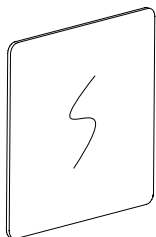
- 3/4" thickness, 3 ply balanced construction
- 1mm PVC edge
- white high pressure marker laminate face
- phenolic balancing backer panel
- extruded aluminum mounting Z clips

Indie

Laminate - Marker Wall Mount Tile

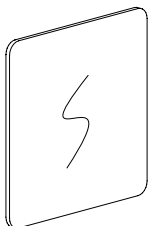


Description	D	W	H	CTN WT	CU FT	Model	List Price
Square - Laminate Wall Mount Marker Tile	1	48	48	57	3	INW4848SQMBL	\$1,218



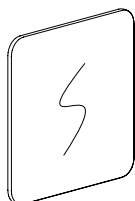
- supported by aluminum Z clips
- wall fastener hardware provided by installer
- white markerboard high pressure laminate
- white edge band

Square - Laminate Wall Mount Marker Tile	1	36	36	33	2	INW3636SQMBL	\$806
---	---	----	----	----	---	--------------	-------



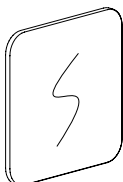
- supported by aluminum Z clips
- wall fastener hardware provided by installer
- white markerboard high pressure laminate
- white edge band

Square - Laminate Wall Mount Marker Tile	1	24	24	16	1	INW2424SQMBL	\$518
---	---	----	----	----	---	--------------	-------



- supported by aluminum Z clips
- wall fastener hardware provided by installer
- white markerboard high pressure laminate
- white edge band

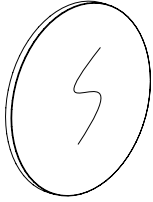
Square - Laminate Wall Mount Marker Tile	1	18	18	11	1	INW1818SQMBL	\$380
---	---	----	----	----	---	--------------	-------



- supported by aluminum Z clips
- wall fastener hardware provided by installer
- white markerboard high pressure laminate
- white edge band

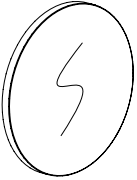
INDIE

Description	D	W	H	CTN WT	CU FT	① Model	List Price
Round - Laminate Wall Mount Marker Tile	1	24	24	16	1	INW24RDMBL	\$512



- supported by aluminum Z clips
- wall fastener hardware provided by installer
- white markerboard high pressure laminate
- white edge band

Round - Laminate Wall Mount Marker Tile	1	18	18	11	1	INW18RDMBL	\$397
--	---	----	----	----	---	------------	-------



- supported by aluminum Z clips
- wall fastener hardware provided by installer
- white markerboard high pressure laminate
- white edge band

To Order, Specify:

① Model Number

Specifications

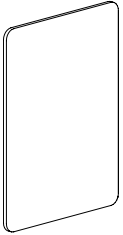
- 3/4" thickness, 3 ply balanced construction
- 1mm PVC edge
- white high pressure marker laminate face
- phenolic balancing backer panel
- extruded aluminum mounting Z clips

Indie

Veneer - Wall Mount Tile



Description	D	W	H	CTN WT	CU FT	① Model	Flat Cut List Price	Double Cut List Price
Rectangular - Veneer Wall Mounted Tile	1	36	48	43	3	INW3648RTV	\$1,077	\$1,207



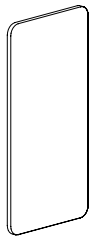
- vertical wall mount tile
- supported by aluminum Z clips
- wall fastener hardware provided by installer
- veneer grain direction runs vertical on tile face

Rectangular - Veneer Wall Mounted Tile	1	30	48	37	2	INW3048RTV	\$1,022	\$1,144
--	---	----	----	----	---	------------	---------	---------



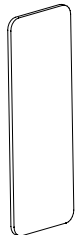
- vertical wall mount tile
- supported by aluminum Z clips
- wall fastener hardware provided by installer
- veneer grain direction runs vertical on tile face

Rectangular - Veneer Wall Mounted Tile	1	24	48	30	2	INW2448RTV	\$967	\$1,085
--	---	----	----	----	---	------------	-------	---------



- vertical wall mount tile
- supported by aluminum Z clips
- wall fastener hardware provided by installer
- veneer grain direction runs vertical on tile face

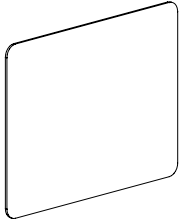
Rectangular - Veneer Wall Mounted Tile	1	18	48	22	2	INW1848RTV	\$877	\$984
--	---	----	----	----	---	------------	-------	-------



- vertical wall mount tile
- supported by aluminum Z clips
- wall fastener hardware provided by installer
- veneer grain direction runs vertical on tile face

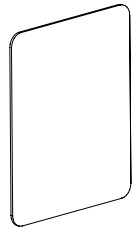
INDIE

Description	D	W	H	CTN WT	CU FT	① Model	Flat Cut List Price	Double Cut List Price
Rectangular - Veneer Wall Mounted Tile	1	48	36	43	3	INW4836RTV	\$1,077	\$1,207



- horizontal wall mount tile
- supported by aluminum Z clips
- wall fastener hardware provided by installer
- veneer grain direction runs vertical on tile face

Rectangular - Veneer Wall Mounted Tile	1	30	36	28	2	INW3036RTV	\$956	\$1,071
--	---	----	----	----	---	------------	-------	---------



- horizontal wall mount tile
- supported by aluminum Z clips
- wall fastener hardware provided by installer
- veneer grain direction runs vertical on tile face

Rectangular - Veneer Wall Mounted Tile	1	24	36	22	2	INW2436RTV	\$911	\$1,021
--	---	----	----	----	---	------------	-------	---------



- vertical wall mount tile
- supported by aluminum Z clips
- wall fastener hardware provided by installer
- veneer grain direction runs vertical on tile face

Rectangular - Veneer Wall Mounted Tile	1	18	36	18	1	INW1836RTV	\$834	\$933
--	---	----	----	----	---	------------	-------	-------



- vertical wall mount tile
- supported by aluminum Z clips
- wall fastener hardware provided by installer
- veneer grain direction runs vertical on tile face

To Order, Specify:

- ① Model Number
- ② Wood Species:
 - a.) Maple (M)
 - b.) Walnut (W)
 - c.) White Oak (WK1)
 - d.) Double Cut (DC1)
- ③ Finish
 - a.) Maple Finish
 - b.) Walnut Finish
 - c.) White Oak Finish
 - d.) Double Cut Finish

Specifications

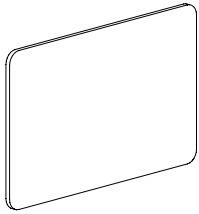
- 3/4" thickness, 3 ply balanced construction
- veneer edge band
- balancing backer panel
- extruded aluminum mounting Z clips

Indie

Veneer - Wall Mount Tile

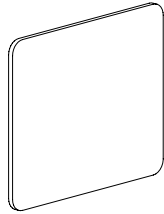


Description	D	W	H	CTN WT	CU FT	① Model	Flat Cut List Price	Double Cut List Price
Rectangular - Veneer Wall Mounted Tile	1	48	30	37	2	INW4830RTV	\$1,022	\$1,144



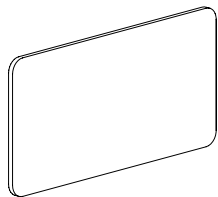
- horizontal wall mount tile
- supported by aluminum Z clips
- wall fastener hardware provided by installer
- veneer grain direction runs vertical on tile face

Rectangular - Veneer Wall Mounted Tile	1	36	30	28	2	INW3630RTV	\$956	\$1,071
--	---	----	----	----	---	------------	-------	---------



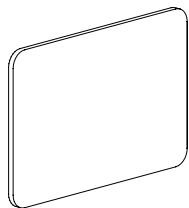
- horizontal wall mount tile
- supported by aluminum Z clips
- wall fastener hardware provided by installer
- veneer grain direction runs vertical on tile face

Rectangular - Veneer Wall Mounted Tile	1	48	24	30	2	INW4824RTV	\$967	\$1,085
--	---	----	----	----	---	------------	-------	---------



- horizontal wall mount tile
- supported by aluminum Z clips
- wall fastener hardware provided by installer
- veneer grain direction runs vertical on tile face

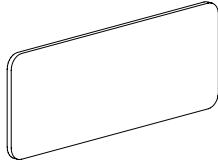
Rectangular - Veneer Wall Mounted Tile	1	36	24	22	2	INW3624RTV	\$911	\$1,021
--	---	----	----	----	---	------------	-------	---------



- horizontal wall mount tile
- supported by aluminum Z clips
- wall fastener hardware provided by installer
- veneer grain direction runs vertical on tile face

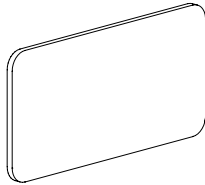
INDIE

Description	D	W	H	CTN WT	CU FT	① Model	Flat Cut List Price	Double Cut List Price
Rectangular - Veneer Wall Mounted Tile	1	48	18	22	2	INW4818RTV	\$877	\$984



- horizontal wall mount tile
- supported by aluminum Z clips
- wall fastener hardware provided by installer
- veneer grain direction runs vertical on tile face

Rectangular - Veneer Wall Mounted Tile	1	36	18	18	1	INW3618RTV	\$834	\$933
--	---	----	----	----	---	------------	-------	-------



- horizontal wall mount tile
- supported by aluminum Z clips
- wall fastener hardware provided by installer
- veneer grain direction runs vertical on tile face

To Order, Specify:

- ① Model Number
- ② Wood Species:
 - a.) Maple (M)
 - b.) Walnut (W)
 - c.) White Oak (WK1)
 - d.) Double Cut (DC1)
- ③ Finish
 - a.) Maple Finish
 - b.) Walnut Finish
 - c.) White Oak Finish
 - d.) Double Cut Finish

Specifications

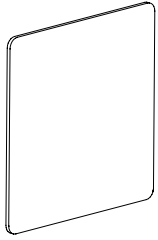
- 3/4" thickness, 3 ply balanced construction
- veneer edge band
- balancing backer panel
- extruded aluminum mounting Z clips

Indie

Veneer - Wall Mount Tile

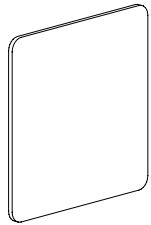


Description	D	W	H	CTN WT	CU FT	① Model	Flat Cut List Price	Double Cut List Price
Square - Veneer Wall Mounted Tile	1	48	48	57	3	INW4848SQV	\$1,195	\$1,338



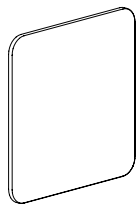
- supported by aluminum Z clips
- wall fastener hardware provided by installer
- veneer grain direction runs vertical on tile face

Square - Veneer Wall Mounted Tile	1	36	36	33	2	INW3636SQV	\$995	\$1,114
-----------------------------------	---	----	----	----	---	------------	-------	---------



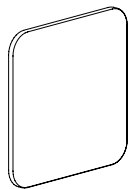
- supported by aluminum Z clips
- wall fastener hardware provided by installer
- veneer grain direction runs vertical on tile face

Square - Veneer Wall Mounted Tile	1	24	24	16	1	INW2424SQV	\$853	\$956
-----------------------------------	---	----	----	----	---	------------	-------	-------



- supported by aluminum Z clips
- wall fastener hardware provided by installer
- veneer grain direction runs vertical on tile face

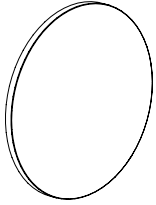
Square - Veneer Wall Mounted Tile	1	18	18	11	1	INW1818SQV	\$774	\$868
-----------------------------------	---	----	----	----	---	------------	-------	-------



- supported by aluminum Z clips
- wall fastener hardware provided by installer
- veneer grain direction runs vertical on tile face

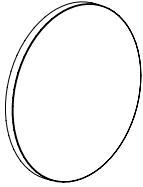
INDIE

Description	D	W	H	CTN WT	CU FT	① Model	Flat Cut List Price	Double Cut List Price
Round - Veneer Wall Mounted Tile	1	24	24	16	1	INW24RDV	\$818	\$917



- supported by aluminum Z clips
- wall fastener hardware provided by installer
- veneer grain direction runs vertical on tile face

Round - Veneer Wall Mounted Tile	1	18	18	11	1	INW18RDV	\$774	\$868
----------------------------------	---	----	----	----	---	----------	-------	-------



- supported by aluminum Z clips
- wall fastener hardware provided by installer
- veneer grain direction runs vertical on tile face

To Order, Specify:

- ① Model Number
- ② Wood Species:
 - a.) Maple (M)
 - b.) Walnut (W)
 - c.) White Oak (WK1)
 - d.) Double Cut (DC1)
- ③ Finish
 - a.) Maple Finish
 - b.) Walnut Finish
 - c.) White Oak Finish
 - d.) Double Cut Finish

Specifications

- 3/4" thickness, 3 ply balanced construction
- veneer edge band
- balancing backer panel
- extruded aluminum mounting Z clips

Indie

Cork - Wall Mount Tile

Description	D	W	H	CTN WT	CU FT	① Model	List Price
Rectangular - Cork Wall Mounted Tile	1	36	48	21	3	INW3648RTC	\$1,259



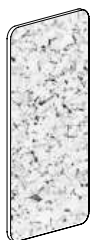
- vertical wall mount tile
- supported by aluminum Z clips
- wall fastener hardware provided by installer
- natural cork tackable face

Rectangular - Cork Wall Mounted Tile	1	30	48	17	3	INW3048RTC	\$874
--------------------------------------	---	----	----	----	---	------------	-------



- vertical wall mount tile
- supported by aluminum Z clips
- wall fastener hardware provided by installer
- natural cork tackable face

Rectangular - Cork Wall Mounted Tile	1	24	48	14	2	INW2448RTC	\$779
--------------------------------------	---	----	----	----	---	------------	-------



- vertical wall mount tile
- supported by aluminum Z clips
- wall fastener hardware provided by installer
- natural cork tackable face

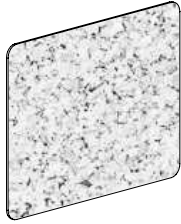
Rectangular - Cork Wall Mounted Tile	1	18	48	11	2	INW1848RTC	\$615
--------------------------------------	---	----	----	----	---	------------	-------



- vertical wall mount tile
- supported by aluminum Z clips
- wall fastener hardware provided by installer
- natural cork tackable face

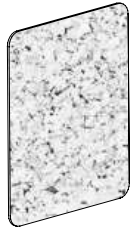
INDIE

Description	D	W	H	CTN WT	CU FT	① Model	List Price
Rectangular - Cork Wall Mounted Tile	1	48	36	21	3	INW4836RTC	\$1,259



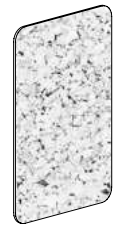
- horizontal wall mount tile
- supported by aluminum Z clips
- wall fastener hardware provided by installer
- natural cork tackable face

Rectangular - Cork Wall Mounted Tile	1	30	36	13	2	INW3036RTC	\$702
--------------------------------------	---	----	----	----	---	------------	-------



- vertical wall mount tile
- supported by aluminum Z clips
- wall fastener hardware provided by installer
- natural cork tackable face

Rectangular - Cork Wall Mounted Tile	1	24	36	11	2	INW2436RTC	\$605
--------------------------------------	---	----	----	----	---	------------	-------



- vertical wall mount tile
- supported by aluminum Z clips
- wall fastener hardware provided by installer
- natural cork tackable face

Rectangular - Cork Wall Mounted Tile	1	18	36	8	1	INW1836RTC	\$506
--------------------------------------	---	----	----	---	---	------------	-------



- vertical wall mount tile
- supported by aluminum Z clips
- wall fastener hardware provided by installer
- natural cork tackable face

To Order, Specify:

① Model Number

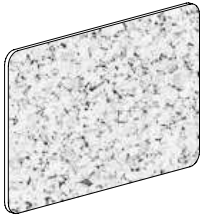
Specifications

- extruded PVC 1/2" thick panel
- natural cork 1/4" thick tackable face
- extruded aluminum mounting Z clips

Indie

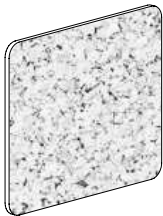
Cork - Wall Mount Tile

Description	D	W	H	CTN WT	CU FT	① Model	List Price
Rectangular - Cork Wall Mounted Tile	1	48	30	17	2	INW4830RTC	\$874



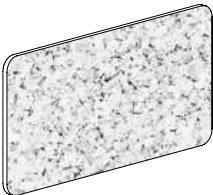
- horizontal wall mount tile
- supported by aluminum Z clips
- wall fastener hardware provided by installer
- natural cork tackable face

Rectangular - Cork Wall Mounted Tile	1	36	30	13	2	INW3630RTC	\$702
--------------------------------------	---	----	----	----	---	------------	-------



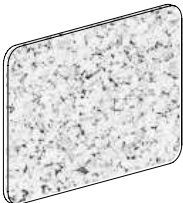
- horizontal wall mount tile
- supported by aluminum Z clips
- wall fastener hardware provided by installer
- natural cork tackable face

Rectangular - Cork Wall Mounted Tile	1	48	24	14	2	INW4824RTC	\$779
--------------------------------------	---	----	----	----	---	------------	-------



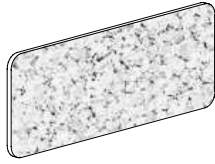
- horizontal wall mount tile
- supported by aluminum Z clips
- wall fastener hardware provided by installer
- natural cork tackable face

Rectangular - Cork Wall Mounted Tile	1	36	24	11	2	INW3624RTC	\$605
--------------------------------------	---	----	----	----	---	------------	-------



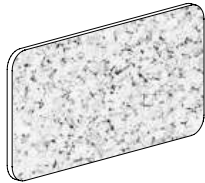
- horizontal wall mount tile
- supported by aluminum Z clips
- wall fastener hardware provided by installer
- natural cork tackable face

Description	D	W	H	CTN WT	CU FT	① Model	List Price
Rectangular - Cork Wall Mounted Tile	1	48	18	11	2	INW4818RTC	\$615



- horizontal wall mount tile
- supported by aluminum Z clips
- wall fastener hardware provided by installer
- natural cork tackable face

Rectangular - Cork Wall Mounted Tile	1	36	18	8	1	INW3618RTC	\$506
--------------------------------------	---	----	----	---	---	------------	-------



- horizontal wall mount tile
- supported by aluminum Z clips
- wall fastener hardware provided by installer
- natural cork tackable face

To Order, Specify:

① Model Number

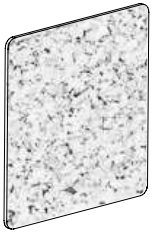
Specifications

- extruded PVC 1/2" thick panel
- natural cork 1/4" thick tackable face
- extruded aluminum mounting Z clips

Indie

Cork - Wall Mount Tile

Description	D	W	H	CTN WT	CU FT	Model	List Price
Square - Cork Wall Mounted Tile	1	48	48	28	3	INW4848SQC	\$1,275



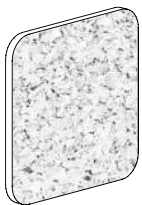
- supported by aluminum Z clips
- wall fastener hardware provided by installer
- natural cork tackable face

Square - Cork Wall Mounted Tile	1	36	36	16	2	INW3636SQC	\$809
---------------------------------	---	----	----	----	---	------------	-------



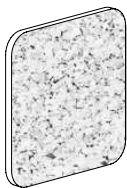
- supported by aluminum Z clips
- wall fastener hardware provided by installer
- natural cork tackable face

Square - Cork Wall Mounted Tile	1	24	24	7	1	INW2424SQC	\$470
---------------------------------	---	----	----	---	---	------------	-------



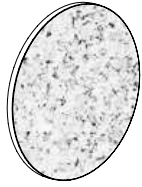
- supported by aluminum Z clips
- wall fastener hardware provided by installer
- natural cork tackable face

Square - Cork Wall Mounted Tile	1	18	18	4	1	INW1818SQC	\$358
---------------------------------	---	----	----	---	---	------------	-------



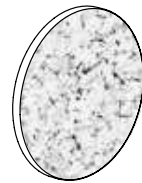
- supported by aluminum Z clips
- wall fastener hardware provided by installer
- natural cork tackable face

Description	D	W	H	CTN WT	CU FT	① Model	List Price
Round - Cork Wall Mounted Tile	1	24	24	7	1	INW24RDC	\$470



- supported by aluminum Z clips
- wall fastener hardware provided by installer
- natural cork tackable face

Round - Cork Wall Mounted Tile	1	18	18	7	1	INW18RDC	\$358
--------------------------------	---	----	----	---	---	----------	-------



- supported by aluminum Z clips
- wall fastener hardware provided by installer
- natural cork tackable face

To Order, Specify:

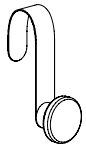
① Model Number

Specifications

- extruded PVC 1/2" thick panel
- natural cork 1/4" thick tackable face
- extruded aluminum mounting Z clips

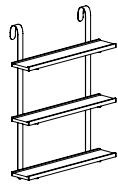
Wall Mount Tile Accessories - Poufy Upholstered Tiles and Conversation Cubby Back Panel

Description	D	W	H	CTN WT	CU FT	① Model	List Price
Knob - Poufy Upholstered Wall Mount Tile Accessory	3 1/8	2 1/2	7	2	1	INA0307WR-KNOB	\$240



- supported by a radius metal hook
- solid maple knob standard
- solid walnut or white oak knob available, specify and add \$21 list
- maximum weight rating 10 lbs. (evenly distributed load)

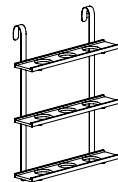
Shelves - Poufy Upholstered Wall Mount Tile Accessories	5 7/8	24	32	9	4	INA2432WR-3SHELF	\$818
	5 7/8	24	20	7	3	INA2420WR-2SHELF	\$641
	5 7/8	24	8	5	2	INA2408WR-1SHELF	\$456



- supported by two radius metal hooks
- shelf depth 4 3/4"
- solid maple shelves standard
- walnut or white oak shelves available, -3SHELF specify and add \$115 list, -2SHELF specify and add \$78 list or -1SHELF specify and add \$41 list
- maximum weight rating 10 lbs. per shelf (evenly distributed load)

-3SHELF shown

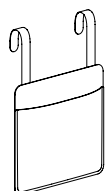
Planter Shelves - Poufy Upholstered Wall Mount Tile Accessories	5 7/8	24	32	9	4	INA2432WR-3PLANTER	\$860
	5 7/8	24	20	7	3	INA2420WR-2PLANTER	\$670
	5 7/8	24	8	5	2	INA2408WR-1PLANTER	\$469



- supported by two radius metal hooks
- solid maple planter shelves standard
- planter shelf with nine 3 1/2" holes for plant containers
- walnut or white oak shelves available, -3PLANTER specify and add \$115 list, -2PLANTER specify and add \$78 list or -1PLANTER specify and add \$41 list
- maximum weight rating 10 lbs. per shelf (evenly distributed load)

-3PLANTER shown

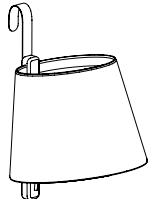
Pouch - Poufy Upholstered Wall Mount Tile Accessory	2 5/8	14	20	2	1	INA1111WR-POUCH	\$539
---	-------	----	----	---	---	-----------------	-------



- supported by two radius metal hooks
- aniline dye leather
- maximum weight rating 10 lbs. (evenly distributed load)

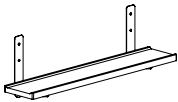
Wall Mount Tile Accessories - Poufy Upholstered Tiles and Conversation Cubby Back Panel

Description	D	W	H	CTN WT	CU FT	① Model	List Price
Sconce Lamp - Poufy Upholstered Wall Mount Tile Accessory	17 1/8	15	22	9	4	INA1522WR-SCONCE	\$777



- supported by a radius metal hook
- 15' cord
- cord mounted rocker on/off switch - three prong plug fabric power cord
- specify graphite, yellow or indigo fabric cord color
- on/off switch on cord 32" from light - field assembly required
- maximum 60 watt light bulb, NOT included/LED bulb recommended
- SELECT Maharam Mode SHADE FABRIC COLOR
- maple sconce support standard
- walnut or white oak sconce support available, specify and add \$27 list

Tray - Poufy and Square Upholstered Wall Mount Tile Accessory	4 3/4	24	1	5	2	INA0524T	\$392
---	-------	----	---	---	---	----------	-------



- for use with square laminate marker, cork and tackable screen accessories
- supported by two metal brackets
- tray can be field installed on any 24" or wider tile except glass marker tiles
- tray can not be installed on intermediate positioned tiles (space is required below tile for clearance)
- maximum weight rating 10 lbs. (evenly distributed load)
- walnut or white oak tray available, specify and add \$41 list

To Order, Specify:

- ① Model Number
- ② Wood Species:
 - a.) Standard Maple (M)
 - b.) Premium Walnut (W) - upcharge applies
 - c.) Premium White Oak (WK1) - upcharge applies
- ③ Finish - Accessory Knob, Shelf, Planter, Lamp or Tray
 - a.) Maple Finish (M)
 - b.) Walnut Finish (W)
 - c.) White Oak Finish (WK1)
 - d.) Paint Color
- ④ Lamp Shade - Maharam - Mode
- ⑤ Metal Color - Arctic Silver (ASL), Matte Black (MBK), Pewter (PEW) or Soft Nickel (SNK)

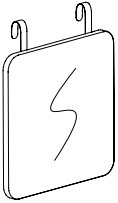
Specifications

- 16 gauge stamped metal mounting hooks

Wall Mount Tile Accessories - Poufy Upholstered Tiles and Conversation Cubby Back Panel

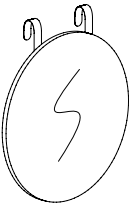
Description	D	W	H	CTN WT	CU FT	Model	List Price
Square Laminate Marker Tile - Poufy Upholstered Wall Mount Tile Accessory	2 1/8	24	24	17	2	INA2424WR-SQM	\$546

- supported by two radius metal hooks
- white markerboard high pressure laminate
- white edge band



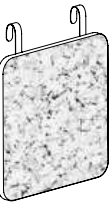
Round Laminate Marker Tile - Poufy Upholstered Wall Mount Tile Accessory	2 1/8	24	24	17	2	INA24WR-RDM	\$539
--	-------	----	----	----	---	-------------	-------

- supported by two radius metal hooks
- white markerboard high pressure laminate
- white edge band



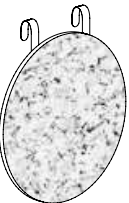
Square Cork Tile - Poufy Upholstered Wall Mount Tile Accessory	2 1/8	24	24	8	2	INA2424WR-SQC	\$512
--	-------	----	----	---	---	---------------	-------

- supported by two radius metal hooks
- extruded PVC 1/2" thick panel
- natural cork 1/4" thick tackable face



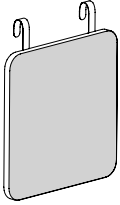
Round Cork Tile - Poufy Upholstered Wall Mount Tile Accessory	2 1/8	24	24	7	2	INA24WR-RDC	\$512
---	-------	----	----	---	---	-------------	-------

- supported by two radius metal hooks
- extruded PVC 1/2" thick panel
- natural cork 1/4" thick tackable face

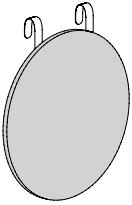


INDIE

Wall Mount Tile Accessories - Poufy Upholstered Tiles and Conversation Cubby Back Panel

Description	D	W	H	CTN WT	CU FT	① Model	List Price Per Grade
Square Tackboard Tile - Poufy Upholstered Wall Mount Tile Accessory 	2 1/8	48	48	11	2	INA2424WR-SQUT	COM \$505
							A \$515
							B \$537
							C \$573
							D \$619
							E \$667
							F \$738
							G \$816
							H \$898
							I \$1,028
J \$1,183							

- supported by two radius metal hooks
- 1/2" soft tack core face
- 1/4" hardwood backer panel
- covered with surface glue and stapled upholstery
- com ydg: 1

Round Tackboard Tile - Poufy Upholstered Wall Mount Tile Accessory 	2 1/8	24	24	11	2	INA24WR-RDUT	COM \$506
							A \$523
							B \$553
							C \$607
							D \$677
							E \$748
							F \$855
							G \$972
							H \$1,097
							I \$1,290
J \$1,524							

- supported by two radius metal hooks
- 1/2" soft tack core face
- 1/4" hardwood backer panel
- covered with surface glue and stapled upholstery
- com ydg: 1 1/2

To Order, Specify:

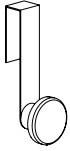
- ① Model Number
- ② Fabric Selection - vendor, pattern and color
Visit www.jsifurniture.com/finishes-and-materials/textiles for our textiles program.
See selection of standard and graded in manufacturers and patterns.
- ③ Metal Color - [See Metal Colors Options](#)

Specifications

- 16 gauge stamped metal mounting hooks

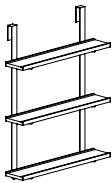
Wall Mount Tile Accessories - Square Profile Tiles (Tackboard, Cork, Veneer and Laminate Marker)

Description	D	W	H	CTN WT	CU FT	① Model	List Price
Knob - Square Profile Wall Mount Tile Accessory	3 1/8	2 1/2	7	2	1	INA0307WS-KNOB	\$240



- supported by a metal hook
- solid maple knob standard
- solid walnut or white oak knob available, specify and add \$21 list
- maximum weight rating 10 lbs. (evenly distributed load)

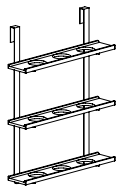
Shelves - Square Profile Wall Mount Tile Accessories	5 7/8	24	32	9	4	INA2432WS-3SHELF	\$818
	5 7/8	24	20	7	3	INA2420WS-2SHELF	\$641
	5 7/8	24	8	5	2	INA2408WS-1SHELF	\$456



-3SHELF shown

- supported by two metal hooks
- shelf depth 4 3/4"
- solid maple shelves standard
- walnut or white oak shelves available, -3SHELF specify and add \$115 list, -2SHELF specify and add \$78 list or -1SHELF specify and add \$41 list
- maximum weight rating 10 lbs. per shelf (evenly distributed)

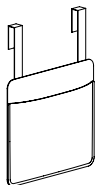
Planter Shelves - Square Profile Wall Mount Tile Accessories	5 7/8	24	32	9	4	INA2432WS-3PLANTER	\$860
	5 7/8	24	20	7	3	INA2420WS-2PLANTER	\$670
	5 7/8	24	8	5	2	INA2408WS-1PLANTER	\$469



-3PLANTER shown

- supported by two metal hooks
- planter shelf with nine 3 1/2" holes for plant containers
- maple planter shelves standard
- walnut or white oak shelves available, -3PLANTER specify and add \$115 list, -2PLANTER specify and add \$78 list or -1PLANTER specify and add \$41 list
- maximum weight rating 10 lbs. per shelf (evenly distributed load)

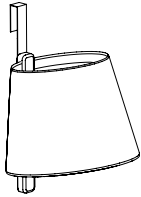
Pouch - Square Profile Wall Mount Tile Accessory	2 5/8	14	20	2	1	INA1111WS-POUCH	\$539
--	-------	----	----	---	---	-----------------	-------



- supported by two metal hooks
- aniline dye leather
- maximum weight rating 10 lbs. (evenly distributed load)

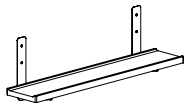
Wall Mount Tile Accessories - Square Profile Tiles (Tackboard, Cork, Veneer and Laminate Marker)

Description	D	W	H	CTN WT	CU FT	① Model	List Price
Sconce Lamp - Square Profile Wall Mount Tile Accessory	17 1/8	15	22	9	4	INA1522WS-SCONCE	\$777



- supported by a radius metal hook
- 15' cord
- cord mounted rocker on/off switch - three prong plug fabric power cord
- specify graphite, yellow or indigo fabric cord color
- on/off switch on cord 32" from light - field assembly required
- maximum 60 watt light bulb, NOT included/LED bulb recommended
- SELECT Maharam Mode SHADE FABRIC COLOR
- maple sconce support standard
- walnut or white oak sconce support available, specify and add \$27 list

Tray - Poufy and Square Upholstered Wall Mount Tile Accessory	4 3/4	24	1	5	2	INA0524T	\$392
--	-------	----	---	---	---	----------	-------



- for use with square laminate marker, cork and tackable screen accessories
- supported by two metal brackets
- tray can be field installed on any 24" or wider tile except glass marker tiles
- tray can not be installed on intermediate positioned tiles (space is required below tile for clearance)
- maximum weight rating 10 lbs. (evenly distributed load)
- walnut or white oak tray available, specify and add \$41 list

To Order, Specify:

- ① Model Number
- ② Wood Species:
 - a.) Standard Maple (M)
 - b.) Premium Walnut (W) - upcharge applies
 - c.) Premium White Oak (WK1) - upcharge applies
- ③ Finish - Accessory Knob, Shelf, Planter, Lamp or Tray
 - a.) Maple Finish (M)
 - b.) Walnut Finish (W)
 - c.) White Oak Finish (WK1)
 - d.) Paint Color
- ④ Lamp Shade - Maharam - Mode
- ⑤ Metal Color - Arctic Silver (ASL), Matte Black (MBK), Pewter (PEW) or Soft Nickel (SNK)

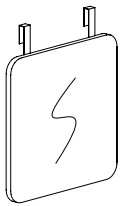
Specifications

- 16 gauge stamped metal mounting hooks

Wall Mount Tile Accessories - Square Profile Tiles (Tackboard, Cork, Veneer and Laminate Marker)

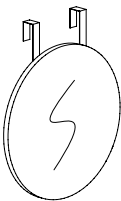
Description	D	W	H	CTN WT	CU FT	Model	List Price
Square - Laminate Marker Tile Square Profile Wall Mount Tile Accessory	2 1/8	24	24	17	2	INA2424WS-SQM	\$546

- supported by two metal hooks
- white markboard high pressure laminate
- white edge band



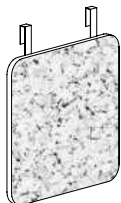
Round - Laminate Marker Tile Square Profile Wall Mount Tile Accessory	2 1/8	24	24	17	2	INA24WS-RDM	\$539
---	-------	----	----	----	---	-------------	-------

- supported by two metal hooks
- white markboard high pressure laminate
- white edge band



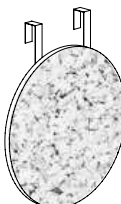
Square - Cork Tile Square Profile Wall Mount Tile Accessory	2 1/8	24	24	8	2	INA2424WS-SQC	\$512
--	-------	----	----	---	---	---------------	-------

- supported by two radius metal hooks
- extruded PVC 1/2" thick panel
- natural cork 1/4" thick tackable face

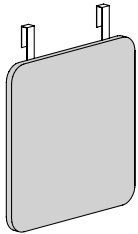


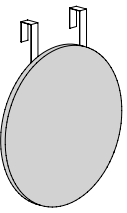
Round - Cork Tile Square Profile Wall Mount Tile Accessory	2 1/8	24	24	7	2	INA24WS-RDC	\$512
---	-------	----	----	---	---	-------------	-------

- supported by two radius metal hooks
- extruded PVC 1/2" thick panel
- natural cork 1/4" thick tackable face



Wall Mount Tile Accessories - Square Profile Tiles

Description	D	W	H	CTN WT	CU FT	① Model	List Price Per Grade
Square - Tackboard Tile Square Profile Wall Mount Tile Accessory  <ul style="list-style-type: none"> · supported by two radius metal hooks · 1/2" soft tack core face · 1/4" hardwood backer panel · covered with surface glue and stapled upholstery · com ydg: 1 	2 1/8	48	48	11	2	INA2424WS-SQUT	COM \$505
	A	\$515					
	B	\$537					
	C	\$573					
	D	\$619					
	E	\$667					
	F	\$738					
	G	\$816					
	H	\$898					
	I	\$1,028					
	J	\$1,183					

Round - Tackboard Tile Square Profile Wall Mount Tile Accessory  <ul style="list-style-type: none"> · supported by two radius metal hooks · 1/2" soft tack core face · 1/4" hardwood backer panel · covered with surface glue and stapled upholstery · com ydg: 1 1/2 	2 1/8	24	24	11	2	INA24WS-RDUT	COM \$506
	A	\$523					
	B	\$553					
	C	\$607					
	D	\$677					
	E	\$748					
	F	\$855					
	G	\$972					
	H	\$1,097					
	I	\$1,290					
	J	\$1,524					

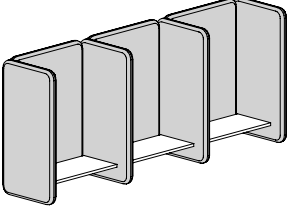
To Order, Specify:

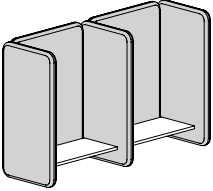
- ① Model Number
- ② Fabric Selection - vendor, pattern and color
 Visit www.jsifurniture.com/finishes-and-materials/textiles for our textiles program.
 See selection of standard and graded in manufacturers and patterns.
- ③ Metal Color - [See Metal Colors Options](#)

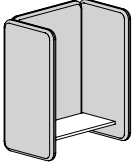
Specifications

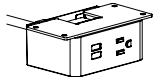
- 16 gauge stamped metal mounting hooks

Conversation Cubby - Upholstered Wall Mount Unit

Description	D	W	H	CTN WT	CU FT	① Model	List Price Per Grade
Triple Conversation Cubby with Laminate Shelf - Upholstered Wall Mount Unit  <ul style="list-style-type: none"> · triple section · supported by two wall cleats · wall fastener hardware provided by installer · under mount power center available under the cubby shelf; EC30 unit must be ordered separately, see page IN84 · com ydg: 8 	18 ¼	86	36	140	39	INW8636CUPL	COM \$4,067 A \$4,151 B \$4,316 C \$4,605 D \$4,978 E \$5,350 F \$5,929 G \$6,549 H \$7,211 I \$8,246 J \$9,487

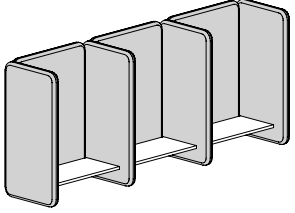
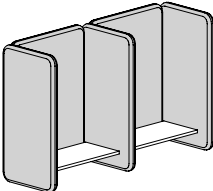
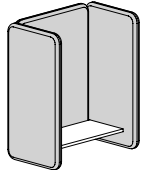
Double Conversation Cubby with Laminate Shelf - Upholstered Wall Mount Unit  <ul style="list-style-type: none"> · double section · supported by two wall cleats · wall fastener hardware provided by installer · under mount power center available under the cubby shelf; EC30 unit must be ordered separately, see page IN84 · com ydg: 6 ¼ 	18 ¼	58	36	97	27	INW5836CUPL	COM \$3,124 A \$3,189 B \$3,318 C \$3,545 D \$3,835 E \$4,127 F \$4,579 G \$5,064 H \$5,581 I \$6,389 J \$7,358
--	------	----	----	----	----	-------------	---

Conversation Cubby with Laminate Shelf - Upholstered Wall Mount Unit  <ul style="list-style-type: none"> · single section · supported by two wall cleats · wall fastener hardware provided by installer · under mount power center available under the cubby shelf; EC30 unit must be ordered separately, see page IN84 · com ydg: 3 ½ 	18 ¼	30	36	52	14	INW3036CUPL	COM \$1,778 A \$1,815 B \$1,886 C \$2,014 D \$2,177 E \$2,341 F \$2,593 G \$2,864 H \$3,155 I \$3,606 J \$4,150
---	------	----	----	----	----	-------------	---

Description	D	W	H	CTN WT	CU FT	① Model	List Price
Power Center - Under Mount  <ul style="list-style-type: none"> · 10' - three prong power cord · shelf mounted simplex receptacle and two USB overall mounting bracket tabs: 5"w · field installed under cubby shelf in desired location · specify black or white - cord will match unit · optional graphite fabric cord available, specify and add \$187 list 	2 ¾	4	2 ⅞			EC30	\$363

INDIE

Conversation Cubby - Upholstered Wall Mount Unit

Description	D	W	H	CTN WT	CU FT	① Model	List Price Per Grade
Triple Conversation Cubby with Veneer Shelf - Upholstered Wall Mount Unit  <ul style="list-style-type: none"> · triple section · supported by two wall cleats · wall fastener hardware provided by installer · under mount power center available under the cubby shelf: EC30 unit must be ordered separately, see page IN84 com ydg: 8 	18 ¼	86	36	140	39	INW8636CUPV	COM \$4,226 A \$4,308 B \$4,474 C \$4,764 D \$5,136 E \$5,508 F \$6,087 G \$6,707 H \$7,369 I \$8,403 J \$9,644
Double Conversation Cubby with Veneer Shelf - Upholstered Wall Mount Unit  <ul style="list-style-type: none"> · double section · supported by two wall cleats · wall fastener hardware provided by installer · under mount power center available under the cubby shelf: EC30 unit must be ordered separately, see page IN84 com ydg: 6 ¼ 	18 ¼	58	36	97	27	INW5836CUPV	COM \$2,967 A \$3,033 B \$3,162 C \$3,388 D \$3,679 E \$3,970 F \$4,423 G \$4,907 H \$5,423 I \$6,231 J \$7,200
Conversation Cubby with Veneer Shelf - Upholstered Wall Mount Unit  <ul style="list-style-type: none"> · single section · supported by two wall cleats · wall fastener hardware provided by installer · under mount power center available under the cubby shelf: EC30 unit must be ordered separately, see page IN84 com ydg: 3 ½ 	18 ¼	30	36	52	14	INW3036CUPV	COM \$1,894 A \$1,930 B \$2,003 C \$2,129 D \$2,291 E \$2,455 F \$2,710 G \$2,979 H \$3,270 I \$3,721 J \$4,264

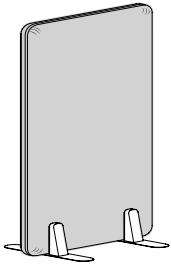
To Order, Specify:

- ① Model Number
- ② Shelf Material:
 - a.) Veneer See [Conversation Cubby with Veneer Shelf Options](#)
 - 1.) Wood Species - Cherry (C), Maple (M), Walnut (W) or Double Cut (DC1)
 - 2.) Wood Finish Color
 - b.) Solid Laminates See [Conversation Cubby with Solid Laminate Shelf Options](#)
- ④ Fabric Selection - vendor, pattern and color
 Visit www.jsifurniture.com/finishes-and-materials/textiles for our textiles program.
 See selection of standard and graded in manufacturers and patterns.

Specifications

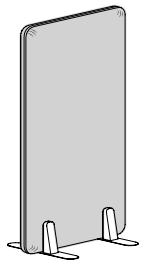
- 12mm birch plywood back panel frame
- two 12 mm sandwiched birch plywood wing panels
- ½" polyurethane foam surface cushioning on back panel and each face of wing panels
- two solid hardwood wall mounting cleats per section
- ¾" thickness 3 ply balanced shelf construction
- veneer edge band on veneer shelf
- 1mm PVC edge band on laminate shelf

Description	D	W	H	CTN WT	CU FT	① Model	List Price Per Grade
60"h Single - Poufy Freestanding Upholstered Screen	2 1/8	48	60	73	9	INF4860-1SUP	COM \$1,819
							A \$1,891
							B \$2,029
							C \$2,275
							D \$2,588
							E \$2,902
							F \$3,391
							G \$3,914
							H \$4,473
							I \$5,345
							J \$6,392



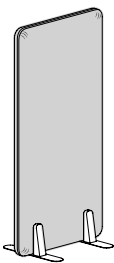
- two metal bases with solid wood supports
- maple solid wood supports standard
- walnut or white oak solid wood supports available, specify and add \$189 list
- heavy cushioned surface not recommended for tacking
- **upholstery can only be cut up the roll for 60"h freestanding screens**
- com ydg: 6 3/4

60"h Single - Poufy Freestanding Upholstered Screen	2 1/8	36	60	60	7	INF3660-1SUP	COM \$1,686
							A \$1,744
							B \$1,858
							C \$2,056
							D \$2,313
							E \$2,568
							F \$2,966
							G \$3,393
							H \$3,847
							I \$4,560
							J \$5,411

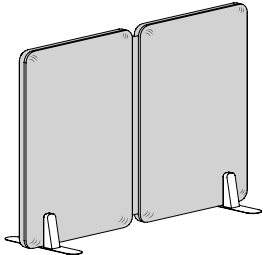


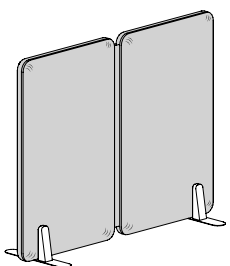
- two metal bases with solid wood supports
- maple solid wood supports standard
- walnut or white oak solid wood supports available, specify and add \$189 list
- heavy cushioned surface not recommended for tacking
- **upholstery can only be cut up the roll for 60"h freestanding screens**
- com ydg: 5 1/2

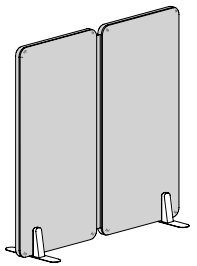
60"h Single - Poufy Freestanding Upholstered Screen	2 1/8	30	60	50	6	INF3060-1SUP	COM \$1,487
							A \$1,539
							B \$1,643
							C \$1,824
							D \$2,056
							E \$2,289
							F \$2,651
							G \$3,039
							H \$3,454
							I \$4,099
							J \$4,874



- two metal bases with solid wood supports
- maple solid wood supports standard
- walnut or white oak solid wood supports available, specify and add \$189 list
- heavy cushioned surface not recommended for tacking
- **upholstery can only be cut up the roll for 60"h freestanding screens**
- com ydg: 5

Description	D	W	H	CTN WT	CU FT	① Model	List Price Per Grade
60" h Double - Poufy Freestanding Upholstered Screen  <ul style="list-style-type: none"> two metal bases with solid wood supports maple solid wood supports standard walnut or white oak solid wood supports available, specify and add \$189 list heavy cushioned surface not recommended for tacking upholstery can only be cut up the roll for 60" h freestanding screens com ydg: 10 ¼ 	2 ½	98	60	134	12	INF4860-2SUP	COM \$2,842
	A	\$2,949					
	B	\$3,162					
	C	\$3,532					
	D	\$4,008					
	E	\$4,487					
	F	\$5,228					
	G	\$6,023					
	H	\$6,871					
	I	\$8,196					
	J	\$9,786					

60" h Double - Poufy Freestanding Upholstered Screen  <ul style="list-style-type: none"> two metal bases with solid wood supports maple solid wood supports standard walnut or white oak solid wood supports available, specify and add \$189 list heavy cushioned surface not recommended for tacking upholstery can only be cut up the roll for 60" h freestanding screens com ydg: 8 ½ 	2 ½	74	60	107	10	INF3660-2SUP	COM \$2,649
	A	\$2,737					
	B	\$2,914					
	C	\$3,222					
	D	\$3,617					
	E	\$4,013					
	F	\$4,627					
	G	\$5,286					
	H	\$5,991					
	I	\$7,088					
	J	\$8,408					

60" h Double - Poufy Freestanding Upholstered Screen  <ul style="list-style-type: none"> two metal bases with solid wood supports maple solid wood supports standard walnut or white oak solid wood supports available, specify and add \$189 list heavy cushioned surface not recommended for tacking upholstery can only be cut up the roll for 60" h freestanding screens com ydg: 7 ¼ 	2 ½	62	60	89	9	INF3060-2SUP	COM \$2,240
	A	\$2,315					
	B	\$2,467					
	C	\$2,728					
	D	\$3,064					
	E	\$3,403					
	F	\$3,928					
	G	\$4,490					
	H	\$5,090					
	I	\$6,027					
	J	\$7,151					

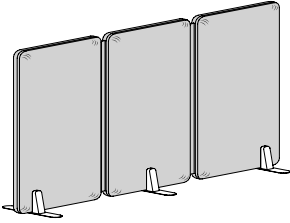
To Order, Specify:

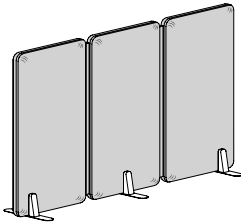
- ① Model Number
- ② Wood Species:
 - a.) STANDARD Maple (M)
 - b.) PREMIUM Walnut (W) - upcharge applies
 - c.) PREMIUM White Oak (WK1) - upcharge applies
- ③ Finish
 - a.) Maple Finish
 - b.) Walnut Finish
 - c.) White Oak Finish
- ④ Fabric Selection - vendor, pattern and color
 Visit www.jsifurniture.com/finishes-and-materials/textiles for our textiles program. See selection of standard and graded in manufacturers and patterns.
- ⑤ Metal Color - [See Metal Colors Options](#)

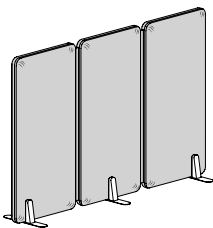
Specifications

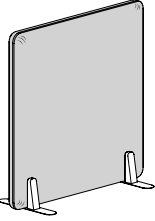
- two 12mm sandwiched birch plywood panel frames
- ½" polyurethane foam surface cushions on both faces
- living hinge is high density polyethylene with sewn upholstery
- solid hardwood supports
- 12 gauge metal base feet

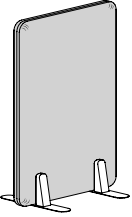
Note: Walnut and White Oak Solid hardwoods are PREMIUM materials and upcharges apply. Associated upcharges are located in bullet points under units where applicable.

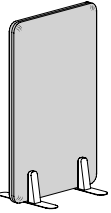
Description	D	W	H	CTN WT	CU FT	① Model	List Price Per Grade
60" h Triple - Poufy Freestanding Upholstered Screen  <ul style="list-style-type: none"> · three metal bases with solid wood supports · maple solid wood supports standard · walnut or white oak solid wood supports available, specify and add \$281 list · heavy cushioned surface not recommended for tacking · upholstery can only be cut up the roll for 60" h freestanding screens · com ydg: 14 	2 1/8	148	60	199	16	INF4860-3SUP	COM \$4,098 A \$4,243 B \$4,534 C \$5,039 D \$5,691 E \$6,342 F \$7,357 G \$8,441 H \$9,601 I \$11,411 J \$13,581

60" h Triple - Poufy Freestanding Upholstered Screen  <ul style="list-style-type: none"> · three metal bases with solid wood supports · maple solid wood supports standard · walnut or white oak solid wood supports available, specify and add \$281 list · heavy cushioned surface not recommended for tacking · upholstery can only be cut up the roll for 60" h freestanding screens · com ydg: 11 3/4 	2 1/8	112	60	158	13	INF3660-3SUP	COM \$3,360 A \$3,483 B \$3,726 C \$4,152 D \$4,699 E \$5,245 F \$6,095 G \$7,007 H \$7,979 I \$9,499 J \$11,321
--	-------	-----	----	-----	----	--------------	--

60" h Triple - Poufy Freestanding Upholstered Screen  <ul style="list-style-type: none"> · three metal bases with solid wood supports · maple solid wood supports standard · walnut or white oak solid wood supports available, specify and add \$281 list · heavy cushioned surface not recommended for tacking · upholstery can only be cut up the roll for 60" h freestanding screens · com ydg: 10 3/4 	2 1/8	94	60	132	11	INF3060-3SUP	COM \$3,292 A \$3,403 B \$3,627 C \$4,015 D \$4,515 E \$5,015 F \$5,794 G \$6,627 H \$7,517 I \$8,907 J \$10,573
--	-------	----	----	-----	----	--------------	--

Description	D	W	H	CTN WT	CU FT	① Model	List Price Per Grade
48" Single - Poufy Freestanding Upholstered Screen  <ul style="list-style-type: none"> two metal bases with solid wood supports maple solid wood supports standard walnut or white oak solid wood supports available, specify and add \$189 list heavy cushioned surface not recommended for tacking com ydg: 5 3/4 	2 1/8	48	48	62	7	INF4848-1SUP	COM \$1,713 A \$1,774 B \$1,894 C \$2,103 D \$2,369 E \$2,637 F \$3,053 G \$3,499 H \$3,975 I \$4,718 J \$5,609

48" Single - Poufy Freestanding Upholstered Screen  <ul style="list-style-type: none"> two metal bases with solid wood supports maple solid wood supports standard walnut or white oak solid wood supports available, specify and add \$189 list heavy cushioned surface not recommended for tacking com ydg: 4 3/4 	2 1/8	36	48	51	6	INF3648-1SUP	COM \$1,605 A \$1,655 B \$1,753 C \$1,924 D \$2,146 E \$2,367 F \$2,711 G \$3,079 H \$3,471 I \$4,086 J \$4,822
---	-------	----	----	----	---	--------------	---

48" Single - Poufy Freestanding Upholstered Screen  <ul style="list-style-type: none"> two metal bases with solid wood supports maple solid wood supports standard walnut or white oak solid wood supports available, specify and add \$189 list heavy cushioned surface not recommended for tacking com ydg: 4 1/2 	2 1/8	30	48	44	5	INF3048-1SUP	COM \$1,474 A \$1,522 B \$1,616 C \$1,778 D \$1,988 E \$2,197 F \$2,523 G \$2,872 H \$3,245 I \$3,826 J \$4,525
---	-------	----	----	----	---	--------------	---

To Order, Specify:

- ① Model Number
- ② Wood Species:
 - a.) STANDARD Maple (M)
 - b.) PREMIUM Walnut (W) - upcharge applies
 - c.) PREMIUM White Oak (WK1) - upcharge applies
- ③ Finish
 - a.) Maple Finish
 - b.) Walnut Finish
 - c.) White Oak Finish
- ④ Fabric Selection - vendor, pattern and color
 Visit www.jsifurniture.com/finishes-and-materials/textiles for our textiles program. See selection of standard and graded in manufacturers and patterns.
- ⑤ Metal Color - [See Metal Colors Options](#)

Specifications

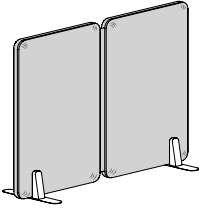
- two 12mm sandwiched birch plywood panel frames
- 1/2" polyurethane foam surface cushions on both faces
- living hinge is high density polyethylene with sewn upholstery
- solid hardwood supports
- 12 gauge metal base feet

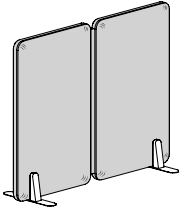
Note: Walnut and White Oak Solid hardwoods are PREMIUM materials and upcharges apply. Associated upcharges are located in bullet points under units where applicable.

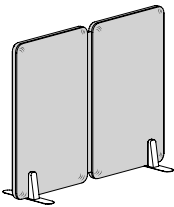
Indie

Poufy - Freestanding Upholstered Screens

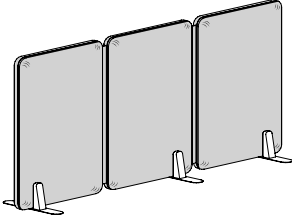


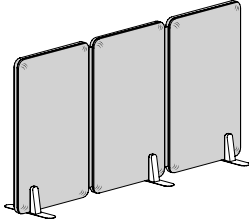
Description	D	W	H	CTN WT	CU FT	① Model	List Price Per Grade
48" h Double - Poufy Freestanding Upholstered Screen  <ul style="list-style-type: none"> · two metal bases with solid wood supports · maple solid wood supports standard · walnut or white oak solid wood supports available, specify and add \$189 list · heavy cushioned surface not recommended for tacking · com ydg: 8½ 	2 1/8	98	48	112	10	INF4848-2SUP	COM \$2,643 A \$2,731 B \$2,908 C \$3,215 D \$3,611 E \$4,006 F \$4,622 G \$5,281 H \$5,985 I \$7,083 J \$8,400

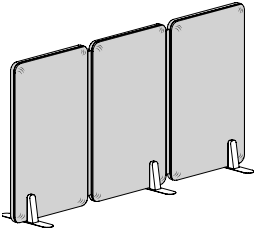
48" h Double - Poufy Freestanding Upholstered Screen  <ul style="list-style-type: none"> · two metal bases with solid wood supports · maple solid wood supports standard · walnut or white oak solid wood supports available, specify and add \$189 list · heavy cushioned surface not recommended for tacking · com ydg: 7 1/4 	2 1/8	74	48	89	8	INF3648-2SUP	COM \$2,499 A \$2,575 B \$2,726 C \$2,987 D \$3,325 E \$3,662 F \$4,188 G \$4,749 H \$5,349 I \$6,287 J \$7,410
--	-------	----	----	----	---	---------------------	--

48" h Double - Poufy Freestanding Upholstered Screen  <ul style="list-style-type: none"> · two metal bases with solid wood supports · maple solid wood supports standard · walnut or white oak solid wood supports available, specify and add \$189 list · heavy cushioned surface not recommended for tacking · com ydg: 6 	2 1/8	62	48	76	7	INF3048-2SUP	COM \$2,195 A \$2,258 B \$2,383 C \$2,600 D \$2,879 E \$3,159 F \$3,592 G \$4,057 H \$4,554 I \$5,329 J \$6,261
--	-------	----	----	----	---	---------------------	--

INDIE

Description	D	W	H	CTN WT	CU FT	① Model	List Price Per Grade
48" Triple - Poufy Freestanding Upholstered Screen  <ul style="list-style-type: none"> • three metal bases with solid wood supports • maple solid wood supports standard • walnut or white oak solid wood supports available, specify and add \$281 list • heavy cushioned surface not recommended for tacking • com ydg: 11 ½ 	2 ½	148	48	166	13	INF4848-3SUP	COM \$3,805
	A	\$3,926					
	B	\$4,164					
	C	\$4,579					
	D	\$5,114					
	E	\$5,650					
	F	\$6,483					
	G	\$7,374					
	H	\$8,326					
	I	\$9,812					
J	\$11,597						

48" Triple - Poufy Freestanding Upholstered Screen  <ul style="list-style-type: none"> • three metal bases with solid wood supports • maple solid wood supports standard • walnut or white oak solid wood supports available, specify and add \$281 list • heavy cushioned surface not recommended for tacking • com ydg: 9 ¾ 	2 ½	112	48	131	11	INF3648-3SUP	COM \$3,607
	A	\$3,708					
	B	\$3,911					
	C	\$4,263					
	D	\$4,718					
	E	\$5,172					
	F	\$5,878					
	G	\$6,633					
	H	\$7,440					
	I	\$8,700					
J	\$10,213						

48" Triple - Poufy Freestanding Upholstered Screen  <ul style="list-style-type: none"> • three metal bases with solid wood supports • maple solid wood supports standard • walnut or white oak solid wood supports available, specify and add \$281 list • heavy cushioned surface not recommended for tacking • com ydg: 8 ¾ 	2 ½	94	48	112	9	INF3048-3SUP	COM \$3,211
	A	\$3,304					
	B	\$3,483					
	C	\$3,801					
	D	\$4,207					
	E	\$4,615					
	F	\$5,247					
	G	\$5,927					
	H	\$6,651					
	I	\$7,782					
J	\$9,139						

To Order, Specify:

- ① Model Number
- ② Wood Species:
 - a.) STANDARD Maple (M)
 - b.) PREMIUM Walnut (W) - upcharge applies
 - c.) PREMIUM White Oak (WK1) - upcharge applies
- ③ Finish
 - a.) Maple Finish
 - b.) Walnut Finish
 - c.) White Oak Finish
- ④ Fabric Selection - vendor, pattern and color
 Visit www.jsifurniture.com/finishes-and-materials/textiles for our textiles program. See selection of standard and graded in manufacturers and patterns.
- ⑤ Metal Color - [See Metal Colors Options](#)

Specifications

- two 12mm sandwiched birch plywood panel frames
- ½" polyurethane foam surface cushions on both faces
- living hinge is high density polyethylene with sewn upholstery
- solid hardwood supports
- 12 gauge metal base feet

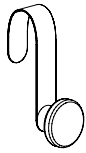
Note: Walnut and White Oak Solid hardwoods are PREMIUM materials and upcharges apply. Associated upcharges are located in bullet points under units where applicable.

Indie

Freestanding Screen Accessories

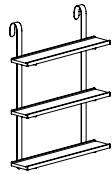


Description	D	W	H	CTN WT	CU FT	① Model	List Price
Knob - Freestanding Screen Accessory	3 7/8	2 1/2	7	2	1	INA0307F-KNOB	\$240



- supported by a metal hook
- solid maple knob standard
- solid walnut or white oak knob available, specify and add \$21 list
- maximum weight rating 10 lbs. (evenly distributed load)

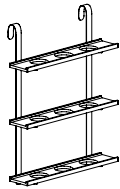
Shelves - Freestanding Screen Accessories	6 5/8	24	32	9	4	INA2432F-3SHELF	\$818
	6 5/8	24	20	7	3	INA2420F-2SHELF	\$641
	6 5/8	24	8	5	2	INA2408F-1SHELF	\$456



-3SHELF shown

- supported by two metal hooks
- shelf depth 4 3/4"
- solid maple shelves standard
- walnut or white oak shelves available, -3SHELF specify and add \$115 list, -2SHELF specify and add \$78 list or -1SHELF specify and add \$41 list
- maximum weight rating 10 lbs. per shelf (evenly distributed load)

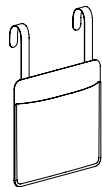
Planter Shelves - Freestanding Screen Accessories	6 5/8	24	32	9	4	INA2432F-3PLANTER	\$860
	6 5/8	24	20	7	3	INA2420F-2PLANTER	\$670
	6 5/8	24	8	5	2	INA2408F-1PLANTER	\$469



-3PLANTER shown

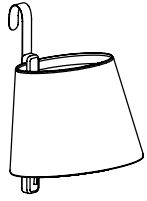
- supported by two metal hooks
- planter shelf with nine 3 1/2" holes for plant containers
- solid maple planter shelves standard
- walnut or white oak shelves available, -3PLANTER specify and add \$115 list, -2PLANTER specify and add \$78 list or -1PLANTER specify and add \$41 list
- maximum weight rating 10 lbs. per shelf (evenly distributed load)

Pouch - Freestanding Screen Accessory	3 3/8	14	20	2	1	INA1111F-POUCH	\$539
--	-------	----	----	---	---	-----------------------	--------------



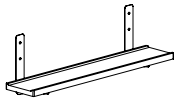
- supported by two metal hooks
- aniline dye leather
- maximum weight rating 10 lbs. (evenly distributed load)

Description	D	W	H	CTN WT	CU FT	① Model	List Price
Scone Lamp - Freestanding Screen Accessory	17 ⁷ / ₈	15	22	9	4	INA1522F-SCONCE	\$777



- supported by a metal hook
- 15' cord
- cord mounted rocker on/off switch - three prong plug fabric power cord
- specify graphite, yellow or indigo fabric cord color
- on/off switch on 32" from light - field assembly required
- maximum 60 watt light bulb, NOT included/LED bulb recommended
- select Maharam Mode SHADE FABRIC COLOR
- maple sconce support stand
- walnut or white oak sconce support available, specify and add \$27 list

Tray - Poufy and Square Upholstered Wall Mount Tile Accessory	4 ³ / ₄	24	1	5	2	INA0524T	\$392
---	-------------------------------	----	---	---	---	----------	-------



- for use with square laminate marker, cork and tackable screen accessories
- supported by two metal brackets
- tray can be field installed on any 24" or wider tile except glass marker tiles
- tray can not be installed on intermediate positioned tiles (space is required below tile for clearance)
- maximum weight rating 10 lbs. (evenly distributed load)
- walnut or white oak tray available, specify and add \$41 list

To Order, Specify:

① Model Number

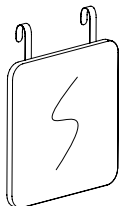
Specifications

- extruded PVC 1/2" thick panel
- natural cork 1/4" thick tackable face
- extruded aluminum mounting Z clips

Indie

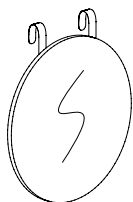
Freestanding Screen Accessories

Description	D	W	H	CTN WT	CU FT	① Model	List Price
Square - Laminate Marker Tile Freestanding Screen Accessory	27 ⁸ / ₈	24	24	17	2	INA2424F-SQM	\$546



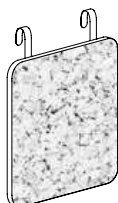
- supported by two metal hooks
- white markerboard high pressure laminate
- white edge band

Round - Laminate Marker Tile Freestanding Screen Accessory	27 ⁸ / ₈	24	24	17	2	INA24F-RDM	\$539
---	--------------------------------	----	----	----	---	------------	-------



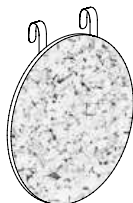
- supported by two metal hooks
- white markerboard high pressure laminate
- white edge band

Square - Cork Tile Freestanding Screen Accessory	27 ⁸ / ₈	24	24	8	2	INA2424F-SQC	\$512
---	--------------------------------	----	----	---	---	--------------	-------

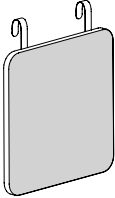


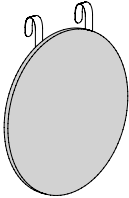
- supported by two metal hooks
- extruded PVC 1/2" thick panel
- natural cork 1/4" thick tackable face

Round - Cork Tile Freestanding Screen Accessory	27 ⁸ / ₈	24	24	7	2	INA24F-RDC	\$512
--	--------------------------------	----	----	---	---	------------	-------



- supported by two metal hooks
- extruded PVC 1/2" thick panel
- natural cork 1/4" thick tackable face

Description	D	W	H	CTN WT	CU FT	① Model	List Price Per Grade
Square - Tackboard Tile Freestanding Screen Accessory	27 ⁷ / ₈	48	48	11	2	INA2424F-SQUT	COM \$505
 <ul style="list-style-type: none"> · supported by two metal hooks · 1/2" soft tack core face · 1/4" hardwood backer panel · covered with surface glued and stapled upholstery · com ydg: 1 1/2 							A \$515
							B \$537
							C \$573
							D \$619
							E \$667
							F \$738
							G \$816
							H \$898
							I \$1,028
							J \$1,183

Round - Tackboard Tile Freestanding Screen Accessory	27 ⁷ / ₈	24	24	11	2	INA24F-RDUT	COM \$506
 <ul style="list-style-type: none"> · supported by two metal hooks · 1/2" soft tack core face · 1/4" hardwood backer panel · covered with surface glued and stapled upholstery · com ydg: 1 1/2 							A \$523
							B \$553
							C \$607
							D \$677
							E \$748
							F \$855
							G \$972
							H \$1,097
							I \$1,290
							J \$1,524

To Order, Specify:

- ① Model Number
- ② Fabric Selection - vendor, pattern and color
Visit www.jsifurniture.com/finishes-and-materials/textiles for our textiles program.
See selection of standard and graded in manufacturers and patterns.
- ③ Metal Color - [See Metal Colors Options](#)

Specifications

- 16 gauge stamped metal mounting hooks

Jude Order Check List:



Specify:

- 1. Model Number
- 2. Wood Species - Beech (B)
- 3. Wood Finish/Paint Color
- 4. Plastic Color
- 5. Fabric Selection - vendor, pattern and color
- 6. Optional Rubber Cushion Nylon Glides - no upcharge; chairs only

Example:

JU413C (model #)	B (wood species)	HRV (finish)	EWM (plastic color)	MOMENTUM (fabric vendor)	VOX (pattern name)	MYSTIC (pattern color)
----------------------------	----------------------------	------------------------	-------------------------------	------------------------------------	------------------------------	----------------------------------

1. Model Number

2. Wood Species - Beech

3. Wood Finish/Color Options:

ALM Ale Medium	HRV Harvest
CAL Ale Light Coordinate	CKC Khaki Coordinate
BBM Bourbon Medium	MINC Mineral Coordinate
CBZ Brazilwood Coordinate	MCH Mocha
BARC Barrel Coordinate	CPI Pinnacle Walnut Coordinate
CBO Bourbon Light Coordinate	PRL Praline
CBG Brighton Light Coordinate	RAVC Raven Coordinate
BRM Brighton Medium	SABC Sable Coordinate
BUT Butterscotch	SIE Sienna
CNDC Cinder Coordinate	CST Studio Teak Coordinate
CLA Classic	TRF Truffle
CLL Collectors	UMB Umber
EGRC Egret Coordinate	VALC Valley Coordinate
ESP Espresso	VEN Venetian
FAWC Fawn Coordinate	CWE Weathered Ash Coordinate
FLX Flax	
CGR Graphite Coordinate	

Paint Color - Add \$45 list per item

BKD Backdrop	GRV Greek Villa
BFX Black Fox	GLF Gulf Stream
BWH Bright White	HTB Heartthrob
CGP Cargo Pants	NET Network Gray
CHT Chatroom	NWH Nonchalant White
DSY Daisy	PAR Paradise
DRG Daring	QXP Quixotic Plum
DYN Dynamo	RBZ Relic Bronze
ENG Enigma	SND Sandbank
FRR French Roast	STM Storm
GBY Georgian Bay	TRC Tricorn Black

4. Plastic Color:

EWM Extra White	SRM Stop Red
MGM Morning Fog	TRC Tricorn Black

5. Fabric Selection - Please supply the following:
Fabric vendor/Pattern name/Pattern color

For a complete list of JSI Standard and Graded-In Textiles click [here](#)

When specifying contrasting upholstery, indicate clearly which upholstery is to be applied to the seat, back and arms. Use higher grade pricing.

- Indicate direction of fabric - Railroaded or Up the Roll
- Please provide illustration, if available

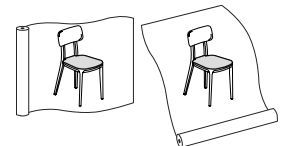
All COM orders must include the following:

- Fabric vendor's name, pattern name and color
- Sample of the fabric attached to order
- Model numbers of items for fabric application
- Special application instructions (e.g., all stripes will be applied front to back unless specified otherwise)
- Customer and purchase order number

Ship prepaid COM material to:

JSI
Attn: COM Dept
201 East Martin Street
Receiving B, Dock 71
Orleans, IN 47452

Application of fabric:
Railroaded Up the Roll



All COM orders will ship at standard lead time from receipt of COM except for orders requiring special custom matched finishes.

Description	① Model	Specifications	List Price												
Armless Guest Chair with Plastic Seat and Back	JU413A · plastic seat and back	<table border="1"> <thead> <tr> <th>Dimensions</th> <th>D</th> <th>W</th> <th>H</th> </tr> </thead> <tbody> <tr> <td>Overall</td> <td>19 ½</td> <td>16</td> <td>31 ½</td> </tr> <tr> <td>Seat</td> <td>16</td> <td>15 ¾</td> <td>18 ½</td> </tr> </tbody> </table>	Dimensions	D	W	H	Overall	19 ½	16	31 ½	Seat	16	15 ¾	18 ½	\$682
		Dimensions	D	W	H										
Overall	19 ½	16	31 ½												
Seat	16	15 ¾	18 ½												
<table border="1"> <thead> <tr> <th>Upholstery</th> <th>Shipping</th> </tr> </thead> <tbody> <tr> <td></td> <td>Ctn Wt 13</td> </tr> <tr> <td></td> <td>Cu Ft 8</td> </tr> </tbody> </table>	Upholstery	Shipping		Ctn Wt 13		Cu Ft 8									
Upholstery	Shipping														
	Ctn Wt 13														
	Cu Ft 8														





Description	① Model	Specifications	List Price Per Grade												
Armless Guest Chair with Upholstered Seat and Plastic Back	JU413C · upholstered seat · plastic back	<table border="1"> <thead> <tr> <th>Dimensions</th> <th>D</th> <th>W</th> <th>H</th> </tr> </thead> <tbody> <tr> <td>Overall</td> <td>19 ½</td> <td>16</td> <td>31 ½</td> </tr> <tr> <td>Seat</td> <td>16</td> <td>15 ¾</td> <td>18 ½</td> </tr> </tbody> </table>	Dimensions	D	W	H	Overall	19 ½	16	31 ½	Seat	16	15 ¾	18 ½	COM \$874 A \$884 B \$904 COL/C \$937 D \$980 E \$1,021 F \$1,089 G \$1,160 H \$1,237 I \$1,357 J \$1,498 L1 \$1,212 L2 \$1,308
		Dimensions	D	W	H										
Overall	19 ½	16	31 ½												
Seat	16	15 ¾	18 ½												
<table border="1"> <thead> <tr> <th>Upholstery</th> <th>Shipping</th> </tr> </thead> <tbody> <tr> <td>COM Ydg ¾</td> <td>Ctn Wt 13</td> </tr> <tr> <td>COL Sq Ft 9</td> <td>Cu Ft 8</td> </tr> </tbody> </table>	Upholstery	Shipping	COM Ydg ¾	Ctn Wt 13	COL Sq Ft 9	Cu Ft 8									
Upholstery	Shipping														
COM Ydg ¾	Ctn Wt 13														
COL Sq Ft 9	Cu Ft 8														




Description	① Model	Specifications	List Price Per Grade												
Armless Guest Chair with Upholstered Seat and Back	JU413D · upholstered seat and back	<table border="1"> <thead> <tr> <th>Dimensions</th> <th>D</th> <th>W</th> <th>H</th> </tr> </thead> <tbody> <tr> <td>Overall</td> <td>19 ½</td> <td>16</td> <td>31 ½</td> </tr> <tr> <td>Seat</td> <td>16</td> <td>15 ¾</td> <td>18 ½</td> </tr> </tbody> </table>	Dimensions	D	W	H	Overall	19 ½	16	31 ½	Seat	16	15 ¾	18 ½	COM \$955 A \$963 B \$984 COL/C \$1,017 D \$1,059 E \$1,102 F \$1,171 G \$1,241 H \$1,317 I \$1,435 J \$1,578 L1 \$1,291 L2 \$1,386
		Dimensions	D	W	H										
Overall	19 ½	16	31 ½												
Seat	16	15 ¾	18 ½												
<table border="1"> <thead> <tr> <th>Upholstery</th> <th>Shipping</th> </tr> </thead> <tbody> <tr> <td>COM Ydg ¾</td> <td>Ctn Wt 13</td> </tr> <tr> <td>COL Sq Ft 18</td> <td>Cu Ft 8</td> </tr> </tbody> </table>	Upholstery	Shipping	COM Ydg ¾	Ctn Wt 13	COL Sq Ft 18	Cu Ft 8									
Upholstery	Shipping														
COM Ydg ¾	Ctn Wt 13														
COL Sq Ft 18	Cu Ft 8														



Description	1 Model	Specifications	List Price																								
37³/₈"h Counter Height Stool with Plastic Seat and Back 	JU414A • plastic seat and back • optional matte black, polished aluminum or brass scuff plate available; specify color and add \$23 list each	<table border="1"> <thead> <tr> <th>Dimensions</th> <th>D</th> <th>W</th> <th>H</th> </tr> </thead> <tbody> <tr> <td>Overall</td> <td>20 ³/₄</td> <td>17</td> <td>37 ³/₈</td> </tr> <tr> <td>Seat</td> <td>16</td> <td>15 ³/₄</td> <td>26 ¹/₄</td> </tr> <tr> <th colspan="2">Upholstery</th> <th colspan="2">Shipping</th> </tr> <tr> <td colspan="2"></td> <td>Ctn Wt</td> <td>14</td> </tr> <tr> <td colspan="2"></td> <td>Cu Ft</td> <td>10</td> </tr> </tbody> </table>	Dimensions	D	W	H	Overall	20 ³ / ₄	17	37 ³ / ₈	Seat	16	15 ³ / ₄	26 ¹ / ₄	Upholstery		Shipping				Ctn Wt	14			Cu Ft	10	\$999
		Dimensions	D	W	H																						
Overall	20 ³ / ₄	17	37 ³ / ₈																								
Seat	16	15 ³ / ₄	26 ¹ / ₄																								
Upholstery		Shipping																									
		Ctn Wt	14																								
		Cu Ft	10																								

Description	1 Model	Specifications	List Price Per Grade																								
37³/₈"h Counter Height Stool with Upholstered Seat and Plastic Back 	JU414C • upholstered seat • plastic back • optional matte black, polished aluminum or brass scuff plate available; specify color and add \$23 list each	<table border="1"> <thead> <tr> <th>Dimensions</th> <th>D</th> <th>W</th> <th>H</th> </tr> </thead> <tbody> <tr> <td>Overall</td> <td>20 ³/₄</td> <td>17</td> <td>37 ³/₈</td> </tr> <tr> <td>Seat</td> <td>16</td> <td>15 ³/₄</td> <td>26 ¹/₄</td> </tr> <tr> <th colspan="2">Upholstery</th> <th colspan="2">Shipping</th> </tr> <tr> <td>COM Ydg</td> <td>³/₄</td> <td>Ctn Wt</td> <td>14</td> </tr> <tr> <td>COL Sq Ft</td> <td>9</td> <td>Cu Ft</td> <td>10</td> </tr> </tbody> </table>	Dimensions	D	W	H	Overall	20 ³ / ₄	17	37 ³ / ₈	Seat	16	15 ³ / ₄	26 ¹ / ₄	Upholstery		Shipping		COM Ydg	³ / ₄	Ctn Wt	14	COL Sq Ft	9	Cu Ft	10	COM \$1,189 A \$1,200 B \$1,220 COL/C \$1,252 D \$1,296 E \$1,337 F \$1,406 G \$1,476 H \$1,554 I \$1,671 J \$1,816 L1 \$1,529 L2 \$1,623
		Dimensions	D	W	H																						
Overall	20 ³ / ₄	17	37 ³ / ₈																								
Seat	16	15 ³ / ₄	26 ¹ / ₄																								
Upholstery		Shipping																									
COM Ydg	³ / ₄	Ctn Wt	14																								
COL Sq Ft	9	Cu Ft	10																								


Description	1 Model	Specifications	List Price																								
37³/₈"h Counter Height Stool with Upholstered Seat and Back 	JU414D • upholstered seat and back • optional matte black, polished aluminum or brass scuff plate available; specify color and add \$23 list each	<table border="1"> <thead> <tr> <th>Dimensions</th> <th>D</th> <th>W</th> <th>H</th> </tr> </thead> <tbody> <tr> <td>Overall</td> <td>20 ³/₄</td> <td>17</td> <td>37 ³/₈</td> </tr> <tr> <td>Seat</td> <td>16</td> <td>15 ³/₄</td> <td>26 ¹/₄</td> </tr> <tr> <th colspan="2">Upholstery</th> <th colspan="2">Shipping</th> </tr> <tr> <td>COM Ydg</td> <td>³/₄</td> <td>Ctn Wt</td> <td>14</td> </tr> <tr> <td>COL Sq Ft</td> <td>18</td> <td>Cu Ft</td> <td>10</td> </tr> </tbody> </table>	Dimensions	D	W	H	Overall	20 ³ / ₄	17	37 ³ / ₈	Seat	16	15 ³ / ₄	26 ¹ / ₄	Upholstery		Shipping		COM Ydg	³ / ₄	Ctn Wt	14	COL Sq Ft	18	Cu Ft	10	COM \$1,280 A \$1,288 B \$1,308 COL/C \$1,339 D \$1,382 E \$1,425 F \$1,493 G \$1,566 H \$1,642 I \$1,759 J \$1,903 L1 \$1,617 L2 \$1,712
		Dimensions	D	W	H																						
Overall	20 ³ / ₄	17	37 ³ / ₈																								
Seat	16	15 ³ / ₄	26 ¹ / ₄																								
Upholstery		Shipping																									
COM Ydg	³ / ₄	Ctn Wt	14																								
COL Sq Ft	18	Cu Ft	10																								


To Order, Specify:


- 1 Model Number
- 2 Wood Species - Beech
- 3 Wood Finish/Paint Color [See Wood Finish/Paint Color Options](#)
- 4 Plastic Color [See Plastic Color Options](#)
- 5 Fabric Selection - vendor, pattern and color
 Visit www.jsifurniture.com/finishes-and-materials/textiles for our textiles program. See selection of standard and graded in manufacturers and patterns.
- 6 Optional Rubber Cushion Nylon Glides - no upcharge


Specifications

- Wood species - Beech.
- Plastic is polypropylene.
- Upholstered seats and backs use polyurethane foam.
- Standard with rubber cushion metal glides.

Description	Model	Specifications	List Price		
42" h Barstool with Plastic Seat and Back 	JU418A · plastic seat and back · optional matte black, polished aluminum or brass scuff plate available; specify color and add \$23 list each	Dimensions	\$1,034		
				D	W
		Overall	22	17 ½	42
		Seat	16	15 ¾	30 ½
		Upholstery	Shipping		
	Ctn Wt	15			
	Cu Ft	12			

Description	Model	Specifications	List Price Per Grade		
42" h Barstool with Upholstered Seat and Plastic Back 	JU418C · upholstered seat · plastic back · optional matte black, polished aluminum or brass scuff plate available; specify color and add \$23 list each	Dimensions	COM \$1,230		
			D	W	H
		Overall	22	17 ½	42
		Seat	16	15 ¾	30 ½
		Upholstery	Shipping		
		COM Ydg	¾	Ctn Wt	15
		COL Sq Ft	9	Cu Ft	12
					A \$1,241
					B \$1,261
					COL/C \$1,295
			D \$1,336		
			E \$1,380		
			F \$1,448		
			G \$1,519		
			H \$1,595		
			I \$1,712		
			J \$1,855		
			L1 \$1,572		
			L2 \$1,667		

Description	Model	Specifications	List Price		
42" h Barstool with Upholstered Seat and Back 	JU418D · upholstered seat and back · optional matte black, polished aluminum or brass scuff plate available; specify color and add \$23 list each	Dimensions	COM \$1,290		
			D	W	H
		Overall	22	17 ½	42
		Seat	16	15 ¾	30 ½
		Upholstery	Shipping		
		COM Ydg	¾	Ctn Wt	15
		COL Sq Ft	18	Cu Ft	12
					A \$1,301
					B \$1,320
					COL/C \$1,353
			D \$1,396		
			E \$1,439		
			F \$1,506		
			G \$1,576		
			H \$1,652		
			I \$1,773		
			J \$1,916		
			L1 \$1,630		
			L2 \$1,726		

Description	① Model	Specifications			List Price Per Grade		
Lounge Chair 	JU420D · upholstered seat and back	Dimensions			COM	\$1,978	
		D	W	H	A	\$1,996	
		Overall	24½	28¾	27	B	\$2,034
		Seat	20	28	17	COL/C	\$2,102
		Upholstery		Shipping		D	\$2,189
		COM Ydg	1¾	Ctn Wt	28	E	\$2,273
		COL Sq Ft	35	Cu Ft	14	F	\$2,406
						G	\$2,549
						H	\$2,702
						I	\$2,941
						J	\$3,226
						L1	\$2,654
						L2	\$2,846

JUDE

To Order, Specify:

- ① Model Number
- ② Wood Species - Beech
- ③ Wood Finish/Paint Color [See Wood Finish/Paint Color Options](#)
- ④ Plastic Color [See Plastic Color Options](#)
- ⑤ Fabric Selection - vendor, pattern and color
 Visit www.jsifurniture.com/finishes-and-materials/textiles for our textiles program. See selection of standard and graded in manufacturers and patterns.
- ⑥ Optional Rubber Cushion Nylon Glides - no upcharge

Specifications

- Wood species - Beech.
- Plastic is polypropylene.
- Upholstered seats and backs use polyurethane foam.
- Standard with rubber cushion metal glides.

Knox Order Check List:



Specify:

- 1. Model Number
- 2. Fabric Selection - vendor, pattern and color
- 3. Plastic Color or Wood Finish
- 4. Handle Cut Out - upcharge applies
- 5. Arm Option - Arctic Silver Nylon (ASP) or Matte Black Nylon (MBK) - no upcharge
- 6. Optional Wood Cap - add \$98 list per arm
- 7. Metal Frame - upcharge applies for chrome
- 8. Swivel Base - Black Nylon (BL) - no upcharge or Polished Aluminum (PA) - add \$103 list
- 9. Table Top Material - Laminate or Walnut Veneer (WA1)

Example:

KN3001WUF | MA1 | HRV | HC | MAHARAM | MESSENGER | NY | ASL
 (model #) | (wood species) | (finish) | (handle cut out) | (fabric vendor) | (pattern name) | (arm) | (metal color)

1. Model Number

2. Fabric Selection - Please supply the following:
 Fabric vendor/Pattern name/Pattern color

For a complete list of JSI Standard and Graded-In Textiles click here

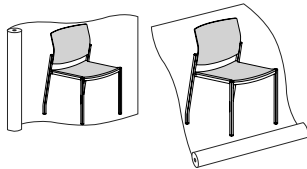
- Indicate direction of fabric - Railroaded or Up the Roll
- Please provide illustration, if available

All COM orders must include the following:

- Vendor's name, pattern name and color
- Sample of the fabric attached to order
- Model numbers of items for fabric application
- Special application instructions (e.g., all stripes will be applied front to back unless specified otherwise)
- Customer and purchase order number

Ship prepaid COM material to:
 JSI
 Attn: COM Dept
 201 East Martin Street
 Receiving B, Dock 71
 Orleans, IN 47452

Application of fabric:
 Railroaded Up the Roll



All COM orders will ship at standard lead time from receipt of COM except for orders requiring special custom matched finishes

3. Plastic Color or Wood Finish Options

Plastic Colors:

BWH	Bright White	SDB	Salty Blue
CYP	Cyberspace	SEB	Secure Blue
GRM	Grey Matters	TBM	Tricorn Black
PON	Poinsettia Red	WGR	Worldly Grey

Maple Wood Species (MA1):

ALM	Ale Medium	MCH	Mocha
CAL	Ale Light Coordinate	CPI	Pinnacle Walnut Coordinate
BBM	Bourbon Medium	PRL	Praline
CBZ	Brazilwood Coordinate	RAVC	Raven Coordinate
BARC	Barrel Coordinate	SABC	Sable Coordinate
CBO	Bourbon Light Coordinate	SIE	Sienna
CBG	Brighton Light Coordinate	CST	Studio Teak Coordinate
BRM	Brighton Medium	TRF	Truffle
BUT	Butterscotch	UMB	Umber
CNDC	Cinder Coordinate	VALC	Valley Coordinate
CLA	Classic	VEN	Venetian
CLL	Collectors	CWE	Weathered Ash Coordinate
EGRC	Egret Coordinate		
ESP	Espresso		
FAWC	Fawn Coordinate		
FLX	Flax		
CGR	Graphite Coordinate		
HRV	Harvest		
CKC	Khaki Coordinate		
MINC	Mineral Coordinate		

Walnut Wood Species (WA1) - upcharge applies

ESP	Espresso	TRF	Truffle
MCH	Mocha	UMB	Umber
SIE	Sienna		

Double Cut Wood Species - Horizontal (DC1)

- up charge applies

KHK	Khaki	STU	Studio Teak
-----	-------	-----	-------------

4. Handle Cut Out Option -

Standard on Plastic Backs
 Optional on Wood Backs, add \$22 list per back
 MBK Matte Black

5. Arm

Structural Nylon - no upcharge
 ASP Arctic Silver
 MBK Matte Black

6. Optional Wood Cap - add \$98 list per arm

7. Metal Frame

Guest/Swivel Chairs & Tables

ABZ Aged Bronze - add \$150 list
 ASL Arctic Silver
 CHR Chrome - add \$100 list
 GLD Gold - add \$150 list
 MBK Matte Black
 PEW Pewter
 SBZ Soft Bronze - add \$150 list

Stools

ABZ Aged Bronze - add \$150 list
 ASL Arctic Silver
 CHR Chrome - add \$123 list
 GLD Gold - add \$150 list
 MBK Matte Black
 PEW Pewter
 SBZ Soft Bronze - add \$150 list

Bariatric & Multiple Seating

ABZ Aged Bronze - add \$150 list
 ASL Arctic Silver
 GLD Gold - add \$150 list
 MBK Matte Black
 PEW Pewter
 SBZ Soft Bronze - add \$150 list

Inline Table Bracket

ASL Arctic Silver
 MBK Matte Black

8. Swivel Base

BL Black Nylon
 PA Polished Aluminum - add \$103 list

9. Top Material Selection on Tables

Laminate:

ALB Alabaster	GRH Graphite
ALL Ale Light	MIN Mineral
BLK Black	OAT Oatmeal Cookie
BOL Bourbon Light	PIN Pinnacle Walnut
BZW Brazilwood	SHD Shadow
BBL Bridal Blanco	SLG Slate Grey
BGL Brighton Light	STU Studio Teak
CLL Collectors	VAL Valley
DWH Designer White	VIN Vintage
FAW Fawn	WEA Weathered Ash
FLO Florence Walnut	

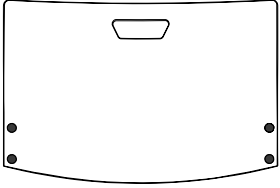
Maple Wood Species:

ALM Ale Medium	CKC Khaki Coordinate
CAL Ale Light Coordinate	MINC Mineral Coordinate
BBM Bourbon Medium	MCH Mocha
CBZ Brazilwood Coordinate	CPI Pinnacle Walnut Coordinate
BARC Barrel Coordinate	PRL Praline
CBO Bourbon Light Coordinate	RAVC Raven Coordinate
CBG Brighton Light Coordinate	SABC Sable Coordinate
BRM Brighton Medium	SIE Sienna
BUT Butterscotch	CST Studio Teak Coordinate
CNDC Cinder Coordinate	TRF Truffle
CLA Classic	UMB Umber
CLL Collectors	VALC Valley Coordinate
EGRC Egret Coordinate	VEN Venetian
ESP Espresso	CWE Weathered Ash Coordinate
FAWC Fawn Coordinate	
FLX Flax	
CGR Graphite Coordinate	
HRV Harvest	

Walnut Wood Species

ESP Espresso	TRF Truffle
MCH Mocha	UMB Umber
SIE Sienna	

Back Materials

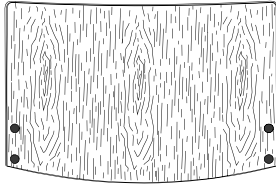


Plastic Back

Available Colors - [see Pg KN2](#)

Handle cut is standard

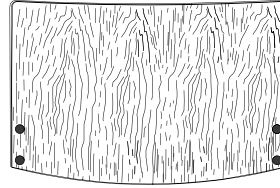
Front fasteners match frame back
Screw caps match plastic color



Maple Veneer Back

Maple Finishes Available - [see Pg KN2](#)

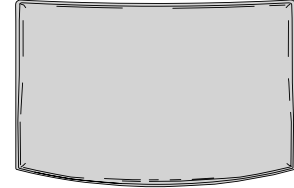
Front fasteners and screw cap covers co-ordinate with frame on armless models;
Front fasteners match frame and arms on arm models



Walnut Veneer

Walnut Finishes Available - [see Pg KN2](#)

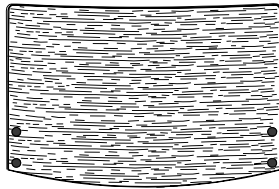
Add \$30 list per back



Upholstered Flex Back

Handle cut is NOT available

All fasteners are hidden on single chairs, stools and bariatric

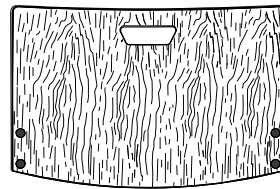


Double Cut Veneer - Horizontal

Available Finishes

KHK Khaki
STU Studio Teak

Add \$32 list per back



Handle Cut Out

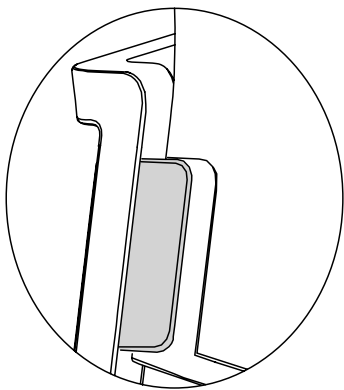
Veneer back only

Add \$22 list per back

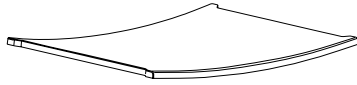
Back Screw Cap Cover

All chairs with plastic on wood backs have screw cap covers on the back side.

Upholstered multiply seating chairs have screw cap covers on the back side. All other upholstered chairs cover the hardware with the upholstery.

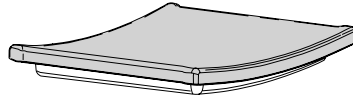


Seat Materials



Plastic Seat

Available Colors - [see Pg KN2](#)

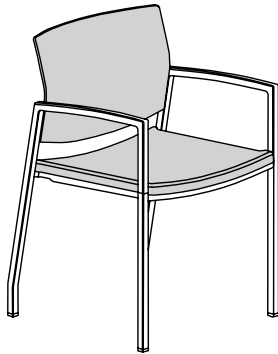


Upholstered Seat

Seat pan offers a recess to add additional comfort
 Seat foam is molded with a high resilient foam

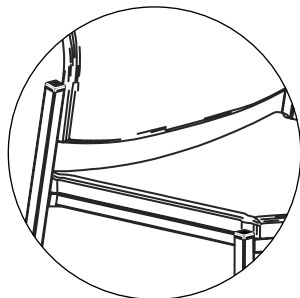
Multiple Fabrics

Units can be specified with a contrasting upholstery. When this feature is determined the unit **will be priced based on the highest grade fabric.** At the time of ordering identify the location of each textile according to the following code.



A = Seat
 B = Back

Arms

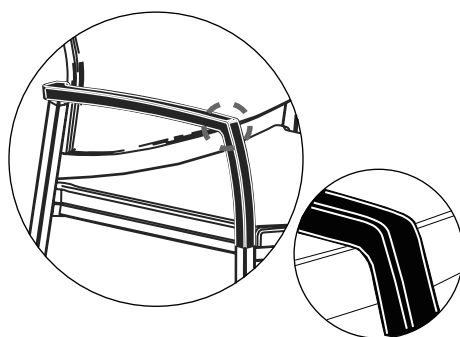


Armless

Available on guest, stools, bariatric and multiple seating

Armless style allows for linking

Tube cap matches the frame color



Flared Arms

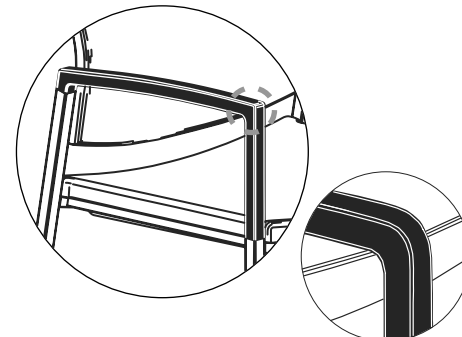
Available on guest, stools, swivels or bariatric

Linking NOT available

Allows for stacking

Structural nylon - no upcharge
arctic silver (ASP)
matte black (MBK)

Wood cap - add \$98 list per arm



Straight Arm

Available on guest, stools, swivels, bariatric and multiple seating

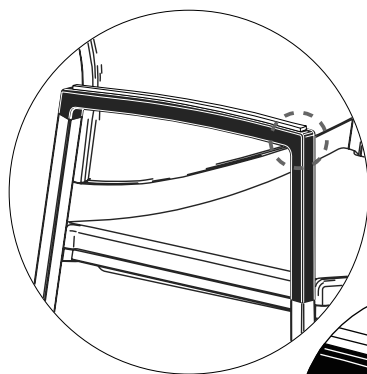
Stacking NOT allowed

Structural nylon - no upcharge
arctic silver (ASP)
matte black (MBK)

Wood cap - add \$98 list per arm

KNOX

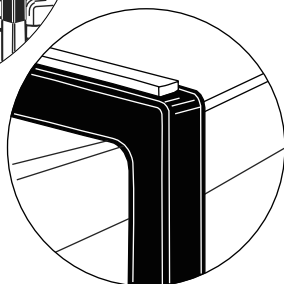
Optional Wood Cap



Available on straight and flared arms

Shaped solid maple
All standard maple finishes and coordinate finishes available

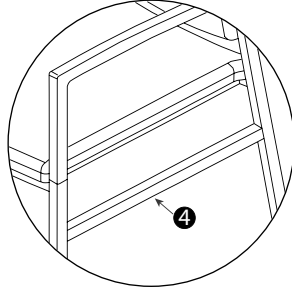
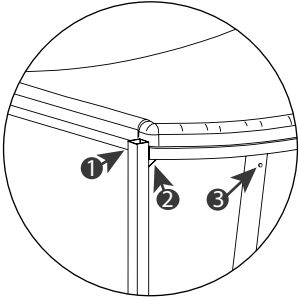
Add \$98 list per arm



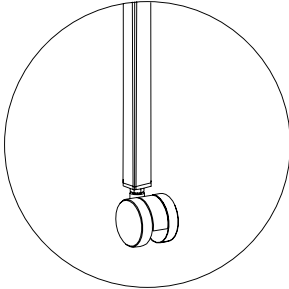
Specifications

Frame Construction

1. Tubular steel frame, 1 7/8", 12 gauge fabricated welded frame.
2. Caster and Bariatric chair frames have a gusset for additional strength.
3. All guest frames have a clear neoprene bumper on the inside of the leg to protect finish when stacking.
4. Multiple seating frames have front to back stretcher on each side section.
5. Multiple seating starter, adders and ender sections bolt together for assembly, instructions are included.

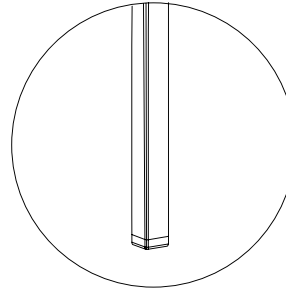


Casters



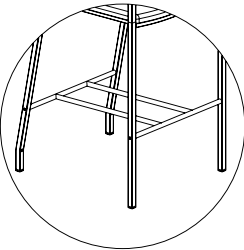
Guest chairs ending in a **C** are standard with a 50mm black nylon dual wheel caster.

Glides



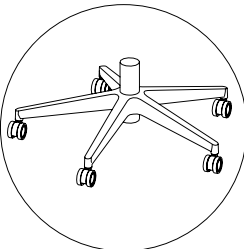
All other guest chairs, multiple seating, bariatric and stools are standard with nylon glides, color matched to frame

Foot Rail On Counter Stools

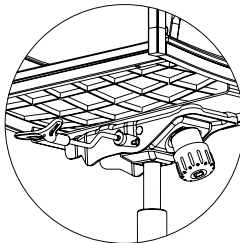


foot rail matches the frame color

Swivel Seating



black polyurethane base (standard)
polished aluminum base (optional)



limited tilt mechanism with tension adjustment and tilt lock -
pneumatic height adjustment

optional conference height mechanism

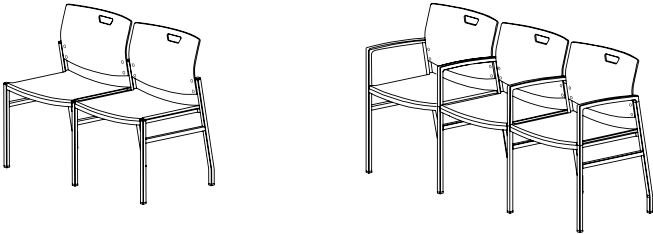
KNOX

Creating Configurations with Chairs and Tables

Knox provides multiple seating, linking brackets and connecting brackets to build an array of solutions for public seating needs, see examples on the next page and learn the building blocks below.

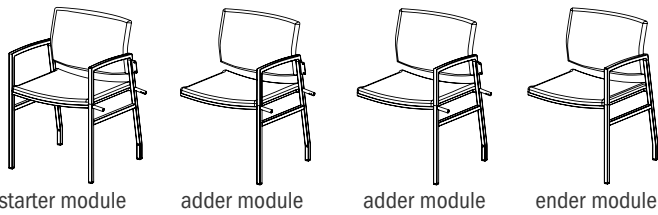
Multiple Seating

Unique model numbers have been created for two and three seat units.



Modular Multiple Seating

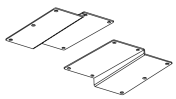
Multiple seating can also be ordered using modular components and assembled in the field. This allows for a row of chairs greater than three seats and only using one starter module. Adder and ender modules are shipped KD, instructions included.



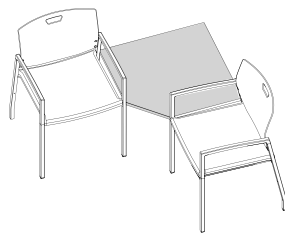
KNOX

Connecting Tables

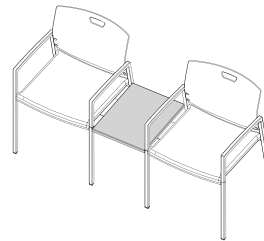
Tables can be added to any guest, bariatric or freestanding multiple seating model. Connecting brackets are installed on the underneath side of the table and require field installation.



connecting brackets included with table



corner table



in-line table

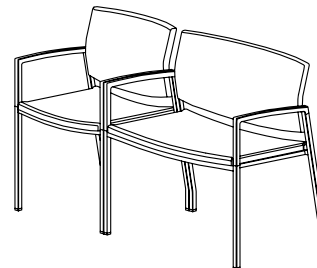
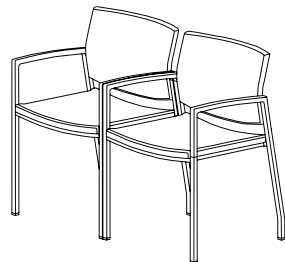
Linked Seating

Guest, bariatric and freestanding multiple seating models can be linked together with linking brackets.

Brackets attach under seat rail and are installed in the field.



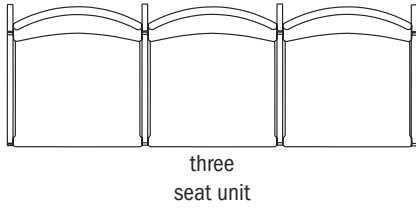
linking brackets sold separately KN30BRKT



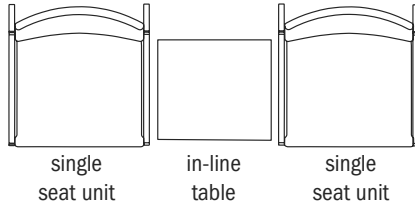
Linking, connecting and modular multiple seating available on armless and straight arm models with glides.

Configuration Typicals

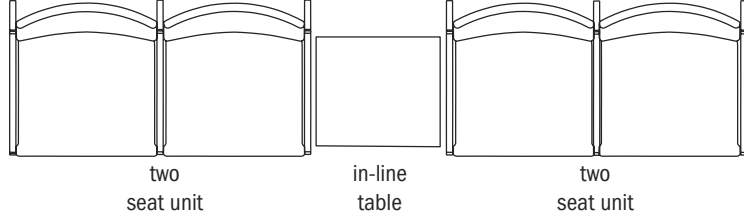
KN001



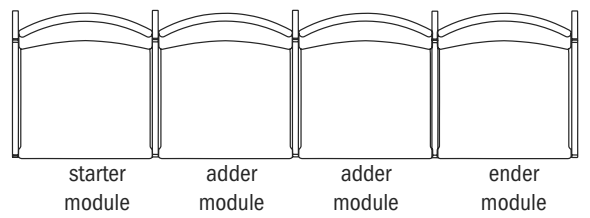
KN002



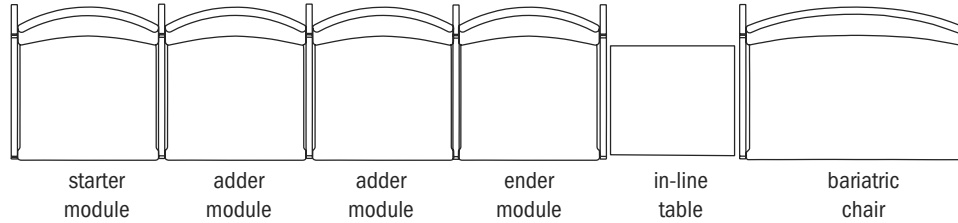
KN003



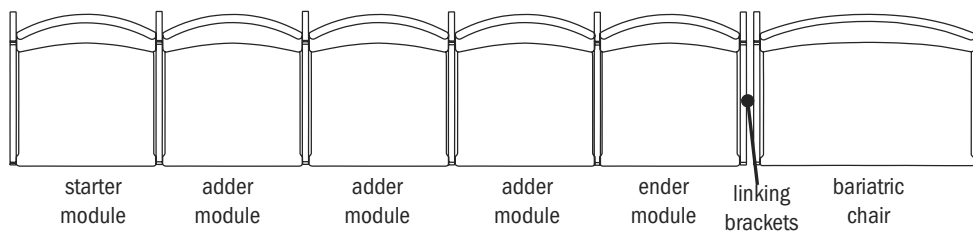
KN004



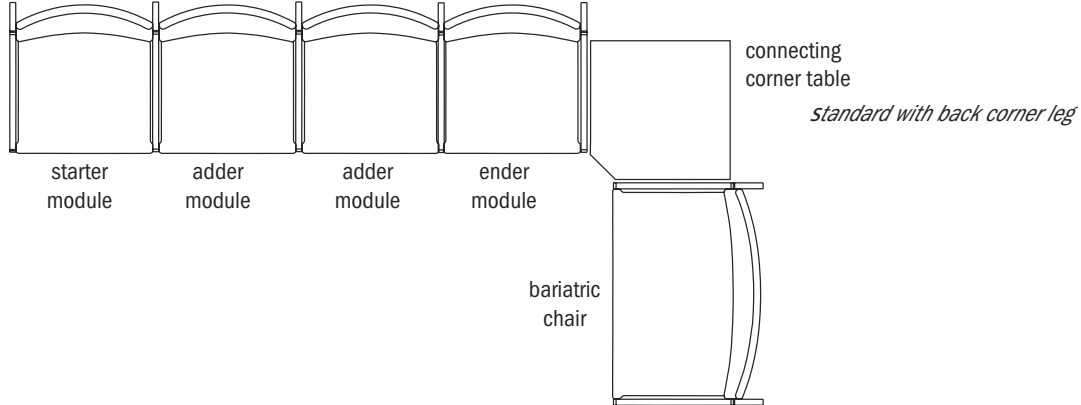
KN005



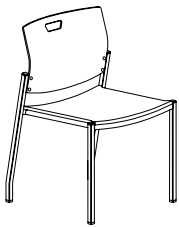
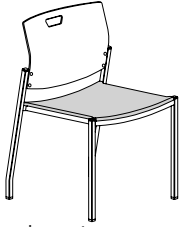
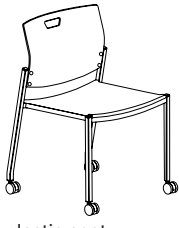
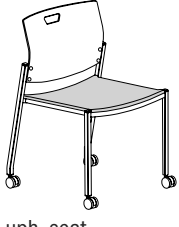
KN006



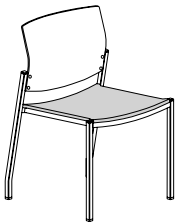
KN007



KNOX

Description	Model	Specifications	List Price Per Grade																								
Armless Stack Chair  plastic seat	KN3003PP - All Plastic KN3003PU - Seat Uph. · stacks six high · linking bracket available, order separately, see page KN33 · passes a 500 lb load rating test · wall saver	<table border="1"> <thead> <tr> <th>Dimensions</th> <th>D</th> <th>W</th> <th>H</th> </tr> </thead> <tbody> <tr> <td>Overall</td> <td>21 ¼</td> <td>21 ¼</td> <td>32</td> </tr> <tr> <td>Seat</td> <td>17 ¾</td> <td>19</td> <td>18 ½</td> </tr> <tr> <th colspan="2">Upholstery</th> <th colspan="2">Shipping</th> </tr> <tr> <td>COM Ydg</td> <td>¾</td> <td>Ctn Wt</td> <td>15</td> </tr> <tr> <td>COL Sq Ft</td> <td>14</td> <td>Cu Ft</td> <td>11</td> </tr> </tbody> </table>	Dimensions	D	W	H	Overall	21 ¼	21 ¼	32	Seat	17 ¾	19	18 ½	Upholstery		Shipping		COM Ydg	¾	Ctn Wt	15	COL Sq Ft	14	Cu Ft	11	All Plastic \$497 COM \$648 A \$656 B \$675 COL/C \$705 D \$746 E \$787 F \$847 G \$914 H \$984 I \$1,094 J \$1,227 L1 \$926 L2 \$1,006
		Dimensions	D	W	H																						
Overall	21 ¼	21 ¼	32																								
Seat	17 ¾	19	18 ½																								
Upholstery		Shipping																									
COM Ydg	¾	Ctn Wt	15																								
COL Sq Ft	14	Cu Ft	11																								
 uph. seat	KN3003PP-3 - All Plastic KN3003PU-3 - Seat Uph. · sets of 3 packaged together - must have all same options · stacks six high · linking bracket available, order separately, see page KN33 · passes a 500 lb load rating test · wall saver	<table border="1"> <thead> <tr> <th>Dimensions</th> <th>D</th> <th>W</th> <th>H</th> </tr> </thead> <tbody> <tr> <td>Overall</td> <td>21 ¼</td> <td>21 ¼</td> <td>32</td> </tr> <tr> <td>Seat</td> <td>17 ¾</td> <td>19</td> <td>18 ½</td> </tr> <tr> <th colspan="2">Upholstery</th> <th colspan="2">Shipping</th> </tr> <tr> <td>COM Ydg</td> <td>1 ½</td> <td>Ctn Wt</td> <td>41</td> </tr> <tr> <td>COL Sq Ft</td> <td>27</td> <td>Cu Ft</td> <td>15</td> </tr> </tbody> </table>	Dimensions	D	W	H	Overall	21 ¼	21 ¼	32	Seat	17 ¾	19	18 ½	Upholstery		Shipping		COM Ydg	1 ½	Ctn Wt	41	COL Sq Ft	27	Cu Ft	15	All Plastic \$1,279 COM \$1,650 A \$1,668 B \$1,703 COL/C \$1,766 D \$1,843 E \$1,924 F \$2,047 G \$2,180 H \$2,322 I \$2,541 J \$2,807 L1 \$2,206 L2 \$2,365
		Dimensions	D	W	H																						
Overall	21 ¼	21 ¼	32																								
Seat	17 ¾	19	18 ½																								
Upholstery		Shipping																									
COM Ydg	1 ½	Ctn Wt	41																								
COL Sq Ft	27	Cu Ft	15																								
Armless Stack Chair with Casters  plastic seat	KN3003PPC - All Plastic KN3003PUC - Seat Uph. · stacks six high · wall saver	<table border="1"> <thead> <tr> <th>Dimensions</th> <th>D</th> <th>W</th> <th>H</th> </tr> </thead> <tbody> <tr> <td>Overall</td> <td>21 ¼</td> <td>21 ¼</td> <td>32</td> </tr> <tr> <td>Seat</td> <td>17 ¾</td> <td>19</td> <td>18 ½</td> </tr> <tr> <th colspan="2">Upholstery</th> <th colspan="2">Shipping</th> </tr> <tr> <td>COM Ydg</td> <td>¾</td> <td>Ctn Wt</td> <td>15</td> </tr> <tr> <td>COL Sq Ft</td> <td>14</td> <td>Cu Ft</td> <td>11</td> </tr> </tbody> </table>	Dimensions	D	W	H	Overall	21 ¼	21 ¼	32	Seat	17 ¾	19	18 ½	Upholstery		Shipping		COM Ydg	¾	Ctn Wt	15	COL Sq Ft	14	Cu Ft	11	All Plastic \$523 COM \$678 A \$688 B \$705 COL/C \$736 D \$776 E \$817 F \$878 G \$945 H \$1,015 I \$1,126 J \$1,258 L1 \$958 L2 \$1,037
		Dimensions	D	W	H																						
Overall	21 ¼	21 ¼	32																								
Seat	17 ¾	19	18 ½																								
Upholstery		Shipping																									
COM Ydg	¾	Ctn Wt	15																								
COL Sq Ft	14	Cu Ft	11																								
 uph. seat	KN3003PPC-3 - All Plastic KN3003PUC-3 - Seat Uph. · sets of 3 packaged together - must have all same options · stacks six high · wall saver	<table border="1"> <thead> <tr> <th>Dimensions</th> <th>D</th> <th>W</th> <th>H</th> </tr> </thead> <tbody> <tr> <td>Overall</td> <td>21 ¼</td> <td>21 ¼</td> <td>32</td> </tr> <tr> <td>Seat</td> <td>17 ¾</td> <td>19</td> <td>18 ½</td> </tr> <tr> <th colspan="2">Upholstery</th> <th colspan="2">Shipping</th> </tr> <tr> <td>COM Ydg</td> <td>1 ½</td> <td>Ctn Wt</td> <td>41</td> </tr> <tr> <td>COL Sq Ft</td> <td>27</td> <td>Cu Ft</td> <td>15</td> </tr> </tbody> </table>	Dimensions	D	W	H	Overall	21 ¼	21 ¼	32	Seat	17 ¾	19	18 ½	Upholstery		Shipping		COM Ydg	1 ½	Ctn Wt	41	COL Sq Ft	27	Cu Ft	15	All Plastic \$1,333 COM \$1,703 A \$1,721 B \$1,756 COL/C \$1,819 D \$1,898 E \$1,979 F \$2,102 G \$2,233 H \$2,375 I \$2,595 J \$2,860 L1 \$2,260 L2 \$2,419
		Dimensions	D	W	H																						
Overall	21 ¼	21 ¼	32																								
Seat	17 ¾	19	18 ½																								
Upholstery		Shipping																									
COM Ydg	1 ½	Ctn Wt	41																								
COL Sq Ft	27	Cu Ft	15																								

KN0X

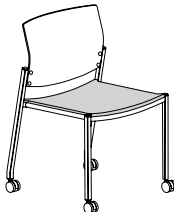
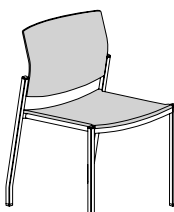
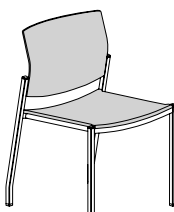
Description	① Model	Specifications				List Price Per Grade	
Armless Stack Chair - Wood Back/Upholstered Seat 	KN3003WU <ul style="list-style-type: none"> stacks six high standard maple veneer back available in maple finishes optional walnut veneer back available in walnut finishes; add \$30 list optional horizontal double cut; add \$32 list optional handle cut out; add \$22 list linking bracket available, order separately, see page KN33 passes a 500 lb load rating test wall saver 	Dimensions		D	W	H	COM \$858
		Overall	21 ¼	21 ¼	32	A \$868	
		Seat		17 ¾	19	18 ½	B \$886
		Upholstery		Shipping			COL/C \$916
		COM Ydg	¾	Ctn Wt	16		D \$957
		COL Sq Ft	14	Cu Ft	11		E \$996
							F \$1,058
							G \$1,125
							H \$1,195
							I \$1,305
							J \$1,438
							L1 \$1,137
							L2 \$1,216

KN3003WU-3 <ul style="list-style-type: none"> sets of 3 packaged together - must have all same options stacks six high standard maple veneer back available in maple finishes optional walnut veneer back available in walnut finishes; add \$90 list optional horizontal double cut; add \$96 list optional handle cut out; add \$66 list linking bracket available, order separately, see page KN33 passes a 500 lb load rating test wall saver 	Dimensions		D	W	H	COM \$2,170
	Overall	21 ¼	21 ¼	32	A \$2,190	
	Seat		17 ¾	19	18 ½	B \$2,225
	Upholstery		Shipping			COL/C \$2,286
	COM Ydg	1 ½	Ctn Wt	44		D \$2,365
	COL Sq Ft	27	Cu Ft	15		E \$2,446
						F \$2,570
						G \$2,700
						H \$2,843
						I \$3,063
						J \$3,329
						L1 \$2,727
						L2 \$2,888

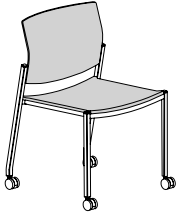
To Order, Specify:

- ① Model Number
- ② Fabric Selection - vendor, pattern and color
Visit www.jsifurniture.com/finishes-and-materials/textiles for our textiles program. See selection of standard and graded in manufacturers and patterns.
- ③ Plastic Color or Wood Finish - See [Plastic Color or Wood Finish Options](#)
 - a. Plastic Back - standard
 - b. Maple Back - standard
 - c. Walnut Back - add \$30 list per back
 - d. Double Cut Back - add \$32 list per back
- ④ Handle Cut Out - add \$22 list per veneer back
- ⑦ Metal Frame Finish - See [Metal Frame Options](#)

KNOX

Description	Model	Specifications	List Price Per Grade																								
Armless Stack Chair with Casters - Wood Back/Upholstered Seat 	KN3003WUC • stacks six high • standard maple veneer back available in maple finishes • optional walnut veneer back available in walnut finishes; add \$30 list • optional horizontal double cut; add \$32 list • optional handle cut out; add \$22 list • wall saver	<table border="1"> <thead> <tr> <th>Dimensions</th> <th>D</th> <th>W</th> <th>H</th> </tr> </thead> <tbody> <tr> <td>Overall</td> <td>21 ¼</td> <td>21 ¼</td> <td>32</td> </tr> <tr> <td>Seat</td> <td>17 ¾</td> <td>19</td> <td>18 ½</td> </tr> <tr> <th colspan="2">Upholstery</th> <th colspan="2">Shipping</th> </tr> <tr> <td>COM Ydg</td> <td>¾</td> <td>Ctn Wt</td> <td>16</td> </tr> <tr> <td>COL Sq Ft</td> <td>14</td> <td>Cu Ft</td> <td>11</td> </tr> </tbody> </table>	Dimensions	D	W	H	Overall	21 ¼	21 ¼	32	Seat	17 ¾	19	18 ½	Upholstery		Shipping		COM Ydg	¾	Ctn Wt	16	COL Sq Ft	14	Cu Ft	11	COM \$881 A \$889 B \$908 COL/C \$937 D \$978 E \$1,017 F \$1,080 G \$1,144 H \$1,216 I \$1,327 J \$1,459 L1 \$1,159 L2 \$1,238
		Dimensions	D	W	H																						
Overall	21 ¼	21 ¼	32																								
Seat	17 ¾	19	18 ½																								
Upholstery		Shipping																									
COM Ydg	¾	Ctn Wt	16																								
COL Sq Ft	14	Cu Ft	11																								
Armless Stack Chair - All Upholstered 	KN3003UU • stacks six high • multiple fabrics, see page KN5 • linking bracket available, order separately, see page KN33 • passes a 500 lb load rating test • wall saver	<table border="1"> <thead> <tr> <th>Dimensions</th> <th>D</th> <th>W</th> <th>H</th> </tr> </thead> <tbody> <tr> <td>Overall</td> <td>21 ¼</td> <td>21 ¼</td> <td>32</td> </tr> <tr> <td>Seat</td> <td>17 ¾</td> <td>19</td> <td>18 ½</td> </tr> <tr> <th colspan="2">Upholstery</th> <th colspan="2">Shipping</th> </tr> <tr> <td>COM Ydg</td> <td>1 ¼</td> <td>Ctn Wt</td> <td>17</td> </tr> <tr> <td>COL Sq Ft</td> <td>23</td> <td>Cu Ft</td> <td>11</td> </tr> </tbody> </table>	Dimensions	D	W	H	Overall	21 ¼	21 ¼	32	Seat	17 ¾	19	18 ½	Upholstery		Shipping		COM Ydg	1 ¼	Ctn Wt	17	COL Sq Ft	23	Cu Ft	11	COM \$784 A \$799 B \$827 COL/C \$881 D \$946 E \$1,013 F \$1,115 G \$1,226 H \$1,342 I \$1,526 J \$1,747 L1 \$1,248 L2 \$1,380
		Dimensions	D	W	H																						
Overall	21 ¼	21 ¼	32																								
Seat	17 ¾	19	18 ½																								
Upholstery		Shipping																									
COM Ydg	1 ¼	Ctn Wt	17																								
COL Sq Ft	23	Cu Ft	11																								
Armless Stack Chair - All Upholstered 	KN3003UU-3 • sets of 3 packaged together - must have all same options • stacks six high • multiple fabrics, see page KN5 • linking bracket available, order separately, see page KN33 • passes a 500 lb load rating test • wall saver	<table border="1"> <thead> <tr> <th>Dimensions</th> <th>D</th> <th>W</th> <th>H</th> </tr> </thead> <tbody> <tr> <td>Overall</td> <td>21 ¼</td> <td>21 ¼</td> <td>32</td> </tr> <tr> <td>Seat</td> <td>17 ¾</td> <td>19</td> <td>18 ½</td> </tr> <tr> <th colspan="2">Upholstery</th> <th colspan="2">Shipping</th> </tr> <tr> <td>COM Ydg</td> <td>2 ¾</td> <td>Ctn Wt</td> <td>47</td> </tr> <tr> <td>COL Sq Ft</td> <td>50</td> <td>Cu Ft</td> <td>15</td> </tr> </tbody> </table>	Dimensions	D	W	H	Overall	21 ¼	21 ¼	32	Seat	17 ¾	19	18 ½	Upholstery		Shipping		COM Ydg	2 ¾	Ctn Wt	47	COL Sq Ft	50	Cu Ft	15	COM \$1,999 A \$2,033 B \$2,097 COL/C \$2,210 D \$2,356 E \$2,503 F \$2,727 G \$2,970 H \$3,229 I \$3,633 J \$4,119 L1 \$3,019 L2 \$3,310
		Dimensions	D	W	H																						
Overall	21 ¼	21 ¼	32																								
Seat	17 ¾	19	18 ½																								
Upholstery		Shipping																									
COM Ydg	2 ¾	Ctn Wt	47																								
COL Sq Ft	50	Cu Ft	15																								

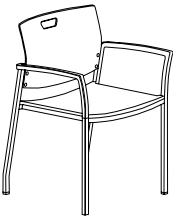
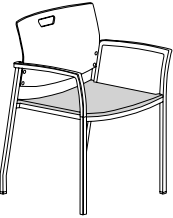
KNOX

Description	① Model	Specifications				List Price Per Grade	
Armless Stack Chair with Casters - All Upholstered 	KN3003UUC · stacks six high · multiple fabrics, see page KN5 · wall saver	Dimensions		D	W	H	COM \$787
		Overall	21 ¼	21 ¼	32	A \$802	
		Seat	17 ¾	19	18 ½	B \$830	
		Upholstery		Shipping		COL/C \$883	
		COM Ydg	1 ¼	Ctn Wt	17	D \$948	
		COL Sq Ft	23	Cu Ft	11	E \$1,015	
						F \$1,117	
						G \$1,228	
						H \$1,345	
						I \$1,529	
						J \$1,750	
						L1 \$1,250	
						L2 \$1,382	
<hr/>							
	KN3003UUC-3 · sets of 3 packaged together - must have all same options · stacks six high · multiple fabrics, see page KN5 · wall saver	Dimensions		D	W	H	COM \$2,054
		Overall	21 ¼	21 ¼	32	A \$2,086	
		Seat	17 ¾	19	18 ½	B \$2,152	
		Upholstery		Shipping		COL/C \$2,264	
		COM Ydg	2 ¾	Ctn Wt	47	D \$2,409	
		COL Sq Ft	50	Cu Ft	15	E \$2,556	
						F \$2,782	
						G \$3,023	
						H \$3,283	
						I \$3,688	
						J \$4,173	
						L1 \$3,074	
						L2 \$3,365	



KNOX

To Order, Specify:

- ① Model Number
- ② Fabric Selection - vendor, pattern and color
 Visit www.jsifurniture.com/finishes-and-materials/textiles for our textiles program.
 See selection of standard and graded in manufacturers and patterns.
- ③ Plastic Color or Wood Finish - See [Plastic Color or Wood Finish Options](#)
 - a. Plastic Back - standard
 - b. Maple Back - standard
 - c. Walnut Back - add \$30 list per back
 - d. Double Cut Back - add \$32 list per back
- ④ Handle Cut Out - add \$22 list per veneer back
- ⑦ Metal Frame Finish - See [Metal Frame Options](#)

Description	Model	Specifications	List Price Per Grade																
Flared Arm Stack Chair  plastic seat  uph. seat	KN3001PPF - All Plastic KN3001PUF - Seat Uph. · stacks six high · maple wood trim arm caps available on standard nylon arms; add \$195 · passes a 500 lb load rating test · wall saver	<table border="1"> <thead> <tr> <th>Dimensions</th> <th>D</th> <th>W</th> <th>H</th> </tr> </thead> <tbody> <tr> <td>Overall</td> <td>21 ¼</td> <td>24 ⅛</td> <td>32</td> </tr> <tr> <td>Seat</td> <td>17 ¾</td> <td>21 ½</td> <td>18 ½</td> </tr> <tr> <td>Arm</td> <td></td> <td></td> <td>26 ⅝</td> </tr> </tbody> </table>	Dimensions	D	W	H	Overall	21 ¼	24 ⅛	32	Seat	17 ¾	21 ½	18 ½	Arm			26 ⅝	All Plastic \$592 COM \$734 A \$744 B \$761 COL/C \$792 D \$832 E \$872 F \$934 G \$999 H \$1,070 I \$1,180 J \$1,312 L1 \$1,013 L2 \$1,091
		Dimensions	D	W	H														
Overall	21 ¼	24 ⅛	32																
Seat	17 ¾	21 ½	18 ½																
Arm			26 ⅝																
<table border="1"> <thead> <tr> <th>Upholstery</th> <th colspan="2">Shipping</th> </tr> </thead> <tbody> <tr> <td>COM Ydg</td> <td>¾</td> <td>Ctn Wt 16</td> </tr> <tr> <td>COL Sq Ft</td> <td>14</td> <td>Cu Ft 12</td> </tr> </tbody> </table>	Upholstery	Shipping		COM Ydg	¾	Ctn Wt 16	COL Sq Ft	14	Cu Ft 12										
Upholstery	Shipping																		
COM Ydg	¾	Ctn Wt 16																	
COL Sq Ft	14	Cu Ft 12																	
	KN3001PPF-3 - All Plastic KN3001PUF-3 - Seat Uph. · sets of 3 packaged together - must have all same options · stacks six high · maple wood trim arm caps available on standard nylon arms; add \$292 · passes a 500 lb load rating test · wall saver	<table border="1"> <thead> <tr> <th>Dimensions</th> <th>D</th> <th>W</th> <th>H</th> </tr> </thead> <tbody> <tr> <td>Overall</td> <td>21 ¼</td> <td>24 ⅛</td> <td>32</td> </tr> <tr> <td>Seat</td> <td>17 ¾</td> <td>21 ½</td> <td>18 ½</td> </tr> <tr> <td>Arm</td> <td></td> <td></td> <td>26 ⅝</td> </tr> </tbody> </table>	Dimensions	D	W	H	Overall	21 ¼	24 ⅛	32	Seat	17 ¾	21 ½	18 ½	Arm			26 ⅝	All Plastic \$1,539 COM \$1,910 A \$1,930 B \$1,963 COL/C \$2,025 D \$2,105 E \$2,185 F \$2,308 G \$2,439 H \$2,581 I \$2,801 J \$3,066 L1 \$2,467 L2 \$2,626
Dimensions	D	W	H																
Overall	21 ¼	24 ⅛	32																
Seat	17 ¾	21 ½	18 ½																
Arm			26 ⅝																
		<table border="1"> <thead> <tr> <th>Upholstery</th> <th colspan="2">Shipping</th> </tr> </thead> <tbody> <tr> <td>COM Ydg</td> <td>1 ½</td> <td>Ctn Wt 44</td> </tr> <tr> <td>COL Sq Ft</td> <td>27</td> <td>Cu Ft 16</td> </tr> </tbody> </table>	Upholstery	Shipping		COM Ydg	1 ½	Ctn Wt 44	COL Sq Ft	27	Cu Ft 16								
Upholstery	Shipping																		
COM Ydg	1 ½	Ctn Wt 44																	
COL Sq Ft	27	Cu Ft 16																	

KNOX

Description	Model	Specifications	List Price Per Grade																												
Flared Arm Stack Chair with Casters  plastic seat	KN3001PPFC - All Plastic KN3001PUFC - Seat Uph. <ul style="list-style-type: none"> stacks six high maple wood trim arm caps available on standard nylon arms; add \$195 list wall saver 	<table border="1"> <thead> <tr> <th>Dimensions</th> <th>D</th> <th>W</th> <th>H</th> </tr> </thead> <tbody> <tr> <td>Overall</td> <td>21 ¼</td> <td>24 ½</td> <td>32</td> </tr> <tr> <td>Seat</td> <td>17 ¾</td> <td>21 ½</td> <td>18 ½</td> </tr> <tr> <td>Arm</td> <td></td> <td></td> <td>26 ½</td> </tr> <tr> <th colspan="2">Upholstery</th> <th colspan="2">Shipping</th> </tr> <tr> <td>COM Ydg</td> <td>¾</td> <td>Ctn Wt</td> <td>16</td> </tr> <tr> <td>COL Sq Ft</td> <td>14</td> <td>Cu Ft</td> <td>12</td> </tr> </tbody> </table>	Dimensions	D	W	H	Overall	21 ¼	24 ½	32	Seat	17 ¾	21 ½	18 ½	Arm			26 ½	Upholstery		Shipping		COM Ydg	¾	Ctn Wt	16	COL Sq Ft	14	Cu Ft	12	All Plastic \$614 COM \$755 A \$765 B \$783 COL/C \$813 D \$852 E \$893 F \$956 G \$1,020 H \$1,091 I \$1,202 J \$1,334 L1 \$1,035 L2 \$1,113
		Dimensions	D	W	H																										
Overall	21 ¼	24 ½	32																												
Seat	17 ¾	21 ½	18 ½																												
Arm			26 ½																												
Upholstery		Shipping																													
COM Ydg	¾	Ctn Wt	16																												
COL Sq Ft	14	Cu Ft	12																												
 uph. seat	KN3001PPFC-3 - All Plastic KN3001PUFC-3 - Seat Uph. <ul style="list-style-type: none"> sets of 3 packaged together - must have all same options stacks six high maple wood trim arm caps available on standard nylon arms; add \$292 list wall saver 	<table border="1"> <thead> <tr> <th>Dimensions</th> <th>D</th> <th>W</th> <th>H</th> </tr> </thead> <tbody> <tr> <td>Overall</td> <td>21 ¼</td> <td>24 ½</td> <td>32</td> </tr> <tr> <td>Seat</td> <td>17 ¾</td> <td>21 ½</td> <td>18 ½</td> </tr> <tr> <td>Arm</td> <td></td> <td></td> <td>26 ½</td> </tr> <tr> <th colspan="2">Upholstery</th> <th colspan="2">Shipping</th> </tr> <tr> <td>COM Ydg</td> <td>1 ½</td> <td>Ctn Wt</td> <td>44</td> </tr> <tr> <td>COL Sq Ft</td> <td>27</td> <td>Cu Ft</td> <td>16</td> </tr> </tbody> </table>	Dimensions	D	W	H	Overall	21 ¼	24 ½	32	Seat	17 ¾	21 ½	18 ½	Arm			26 ½	Upholstery		Shipping		COM Ydg	1 ½	Ctn Wt	44	COL Sq Ft	27	Cu Ft	16	All Plastic \$1,592 COM \$1,963 A \$1,983 B \$2,017 COL/C \$2,079 D \$2,158 E \$2,238 F \$2,361 G \$2,493 H \$2,636 I \$2,856 J \$3,120 L1 \$2,520 L2 \$2,679
Dimensions	D	W	H																												
Overall	21 ¼	24 ½	32																												
Seat	17 ¾	21 ½	18 ½																												
Arm			26 ½																												
Upholstery		Shipping																													
COM Ydg	1 ½	Ctn Wt	44																												
COL Sq Ft	27	Cu Ft	16																												

To Order, Specify:

- 1 Model Number
- 2 Fabric Selection - vendor, pattern and color
 Visit www.jsifurniture.com/finishes-and-materials/textiles for our textiles program.
 See selection of standard and graded in manufacturers and patterns.
- 3 Plastic Color or Wood Finish - See [Plastic Color or Wood Finish Options](#)
 - a. Plastic Back - standard
 - b. Maple Back - standard
 - c. Walnut Back - add \$30 list per back
 - d. Double Cut Back - add \$32 list per back
- 4 Handle Cut Out - add \$22 list per veneer back
- 7 Metal Frame Finish - See [Metal Frame Options](#)

KNOX

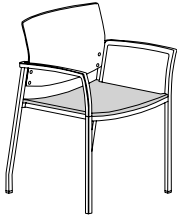
Description

Model

Specifications

List Price Per Grade

Flared Arm Stack Chair -
Wood Back/Upholstered Seat



KN3001WUF

- stacks six high
- standard maple veneer back available in maple finishes
- optional walnut veneer back available in walnut finishes; add \$30 list
- optional horizontal double cut; add \$32 list
- optional handle cut out; add \$22 list
- nylon arms available in matte black or arctic silver
- maple wood trim arm caps available on standard nylon arms; add \$195 list
- passes a 500 lb load rating test
- wall saver

Dimensions	D	W	H
Overall	21 ¼	24 ⅛	32
Seat	17 ¾	21 ½	18 ½
Arm			26 ⅝
Upholstery		Shipping	
COM Ydg	¾	Ctn Wt	16
COL Sq Ft	14	Cu Ft	12

COM	\$951
A	\$961
B	\$978
COL/C	\$1,009
D	\$1,048
E	\$1,089
F	\$1,152
G	\$1,216
H	\$1,287
I	\$1,398
J	\$1,530
L1	\$1,230
L2	\$1,308

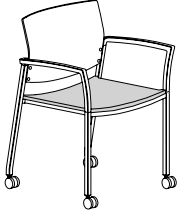
KN3001WUF-3

- sets of 3 packaged together - must have all same options
- stacks six high
- standard maple veneer back available in maple finishes
- optional walnut veneer back available in walnut finishes; add \$90 list
- optional horizontal double cut; add \$96 list
- optional handle cut out; add \$66 list
- nylon arms available in matte black or arctic silver
- maple wood trim arm caps available on standard nylon arms; add \$292 list
- passes a 500 lb load rating test
- wall saver

Dimensions	D	W	H
Overall	21 ¼	24 ⅛	32
Seat	17 ¾	21 ½	18 ½
Arm			26 ⅝
Upholstery		Shipping	
COM Ydg	1 ½	Ctn Wt	44
COL Sq Ft	27	Cu Ft	16

COM	\$2,408
A	\$2,428
B	\$2,462
COL/C	\$2,524
D	\$2,603
E	\$2,683
F	\$2,807
G	\$2,938
H	\$3,081
I	\$3,301
J	\$3,566
L1	\$2,965
L2	\$3,125

KNOX

Description	Model	Specifications	List Price Per Grade																										
Flared Arm Chair with Casters - Wood Back/Upholstered Seat 	KN3001WUFC <ul style="list-style-type: none"> stacks six high standard maple veneer back available in maple finishes optional walnut veneer back available in walnut finishes; add \$30 list optional horizontal double cut; add \$32 list optional handle cut out; add \$22 list maple wood trim arm caps available on standard nylon arms; add \$195 list wall saver 	<table border="1"> <thead> <tr> <th>Dimensions</th> <th>D</th> <th>W</th> <th>H</th> </tr> </thead> <tbody> <tr> <td>Overall</td> <td>21 ¼</td> <td>24 ⅛</td> <td>32</td> </tr> <tr> <td>Seat</td> <td>17 ¾</td> <td>21 ½</td> <td>18 ½</td> </tr> <tr> <td>Arm</td> <td></td> <td></td> <td>26 ⅝</td> </tr> </tbody> </table>	Dimensions	D	W	H	Overall	21 ¼	24 ⅛	32	Seat	17 ¾	21 ½	18 ½	Arm			26 ⅝	<table border="1"> <thead> <tr> <th>Upholstery</th> <th>Shipping</th> </tr> </thead> <tbody> <tr> <td>COM Ydg</td> <td>¾ Ctn Wt 16</td> </tr> <tr> <td>COL Sq Ft</td> <td>14 Cu Ft 12</td> </tr> </tbody> </table>	Upholstery	Shipping	COM Ydg	¾ Ctn Wt 16	COL Sq Ft	14 Cu Ft 12				
		Dimensions	D	W	H																								
Overall	21 ¼	24 ⅛	32																										
Seat	17 ¾	21 ½	18 ½																										
Arm			26 ⅝																										
Upholstery	Shipping																												
COM Ydg	¾ Ctn Wt 16																												
COL Sq Ft	14 Cu Ft 12																												
			<table border="1"> <tbody> <tr><td>COM</td><td>\$971</td></tr> <tr><td>A</td><td>\$981</td></tr> <tr><td>B</td><td>\$998</td></tr> <tr><td>COL/C</td><td>\$1,030</td></tr> <tr><td>D</td><td>\$1,069</td></tr> <tr><td>E</td><td>\$1,110</td></tr> <tr><td>F</td><td>\$1,170</td></tr> <tr><td>G</td><td>\$1,237</td></tr> <tr><td>H</td><td>\$1,307</td></tr> <tr><td>I</td><td>\$1,418</td></tr> <tr><td>J</td><td>\$1,550</td></tr> <tr><td>L1</td><td>\$1,250</td></tr> <tr><td>L2</td><td>\$1,329</td></tr> </tbody> </table>	COM	\$971	A	\$981	B	\$998	COL/C	\$1,030	D	\$1,069	E	\$1,110	F	\$1,170	G	\$1,237	H	\$1,307	I	\$1,418	J	\$1,550	L1	\$1,250	L2	\$1,329
COM	\$971																												
A	\$981																												
B	\$998																												
COL/C	\$1,030																												
D	\$1,069																												
E	\$1,110																												
F	\$1,170																												
G	\$1,237																												
H	\$1,307																												
I	\$1,418																												
J	\$1,550																												
L1	\$1,250																												
L2	\$1,329																												

KN3001WUFC-3 <ul style="list-style-type: none"> sets of 3 packaged together - must have all same options stacks six high standard maple veneer back available in maple finishes optional walnut veneer back available in walnut finishes; add \$90 list optional horizontal double cut; add \$96 list optional handle cut out; add \$66 list nylon arms available in matte black or arctic silver maple wood trim arm caps available on standard nylon arms; add \$292 list wall saver 	<table border="1"> <thead> <tr> <th>Dimensions</th> <th>D</th> <th>W</th> <th>H</th> </tr> </thead> <tbody> <tr> <td>Overall</td> <td>21 ¼</td> <td>24 ⅛</td> <td>32</td> </tr> <tr> <td>Seat</td> <td>17 ¾</td> <td>21 ½</td> <td>18 ½</td> </tr> <tr> <td>Arm</td> <td></td> <td></td> <td>26 ⅝</td> </tr> </tbody> </table>	Dimensions	D	W	H	Overall	21 ¼	24 ⅛	32	Seat	17 ¾	21 ½	18 ½	Arm			26 ⅝	<table border="1"> <thead> <tr> <th>Upholstery</th> <th>Shipping</th> </tr> </thead> <tbody> <tr> <td>COM Ydg</td> <td>1 ½ Ctn Wt 44</td> </tr> <tr> <td>COL Sq Ft</td> <td>27 Cu Ft 16</td> </tr> </tbody> </table>	Upholstery	Shipping	COM Ydg	1 ½ Ctn Wt 44	COL Sq Ft	27 Cu Ft 16				
	Dimensions	D	W	H																								
Overall	21 ¼	24 ⅛	32																									
Seat	17 ¾	21 ½	18 ½																									
Arm			26 ⅝																									
Upholstery	Shipping																											
COM Ydg	1 ½ Ctn Wt 44																											
COL Sq Ft	27 Cu Ft 16																											
		<table border="1"> <tbody> <tr><td>COM</td><td>\$2,463</td></tr> <tr><td>A</td><td>\$2,482</td></tr> <tr><td>B</td><td>\$2,518</td></tr> <tr><td>COL/C</td><td>\$2,578</td></tr> <tr><td>D</td><td>\$2,657</td></tr> <tr><td>E</td><td>\$2,738</td></tr> <tr><td>F</td><td>\$2,862</td></tr> <tr><td>G</td><td>\$2,992</td></tr> <tr><td>H</td><td>\$3,135</td></tr> <tr><td>I</td><td>\$3,355</td></tr> <tr><td>J</td><td>\$3,621</td></tr> <tr><td>L1</td><td>\$3,019</td></tr> <tr><td>L2</td><td>\$3,180</td></tr> </tbody> </table>	COM	\$2,463	A	\$2,482	B	\$2,518	COL/C	\$2,578	D	\$2,657	E	\$2,738	F	\$2,862	G	\$2,992	H	\$3,135	I	\$3,355	J	\$3,621	L1	\$3,019	L2	\$3,180
COM	\$2,463																											
A	\$2,482																											
B	\$2,518																											
COL/C	\$2,578																											
D	\$2,657																											
E	\$2,738																											
F	\$2,862																											
G	\$2,992																											
H	\$3,135																											
I	\$3,355																											
J	\$3,621																											
L1	\$3,019																											
L2	\$3,180																											

To Order, Specify:

- ① Model Number
- ② Fabric Selection - vendor, pattern and color
Visit www.jsifurniture.com/finishes-and-materials/textiles for our textiles program. See selection of standard and graded in manufacturers and patterns.
- ③ Plastic Color or Wood Finish - See [Plastic Color or Wood Finish Options](#)
 - a. Plastic Back - standard
 - b. Maple Back - standard
 - c. Walnut Back - add \$30 list per back
 - d. Double Cut Back - add \$32 list per back
- ④ Handle Cut Out - add \$22 list per veneer back
- ⑦ Metal Frame Finish - See [Metal Frame Options](#)

KNOX

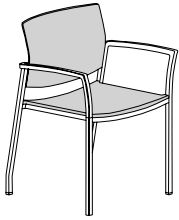
Description

Model

Specifications

List Price Per Grade

Flared Arm Stack Chair -
All Upholstered



KN3001UUF

- stacks six high
- nylon arms available in matte black or arctic silver
- maple wood trim arm caps available on standard nylon arms; add \$195 list
- multiple fabrics, see page [KN5](#)
- passes a 500 lb load rating test
- wall saver

Dimensions	D	W	H
Overall	21 ¼	24 ⅛	32
Seat	17 ¾	21 ½	18 ½
Arm			26 ⅝
Upholstery		Shipping	
COM Ydg	1 ¼	Ctn Wt	18
COL Sq Ft	23	Cu Ft	12

- COM \$878
- A \$894
- B \$922
- COL/C \$974
- D \$1,041
- E \$1,109
- F \$1,210
- G \$1,322
- H \$1,438
- I \$1,621
- J \$1,842
- L1 \$1,342
- L2 \$1,475

KN3001UUF-3

- sets of 3 packaged together - must have all same options
- stacks six high
- nylon arms available in matte black or arctic silver
- maple wood trim arm caps available on standard nylon arms; add \$292 list
- multiple fabrics, see page [KN5](#)
- passes a 500 lb load rating test
- wall saver

Dimensions	D	W	H
Overall	21 ¼	24 ⅛	32
Seat	17 ¾	21 ½	18 ½
Arm			26 ⅝
Upholstery		Shipping	
COM Ydg	2 ¾	Ctn Wt	50
COL Sq Ft	50	Cu Ft	16

- COM \$2,265
- A \$2,299
- B \$2,362
- COL/C \$2,476
- D \$2,621
- E \$2,768
- F \$2,992
- G \$3,235
- H \$3,495
- I \$3,900
- J \$4,384
- L1 \$3,286
- L2 \$3,577

KNOX

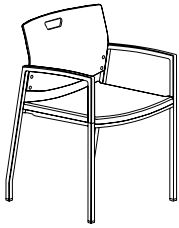
Description

Model

Specifications

List Price Per Grade

Straight Arm Chair



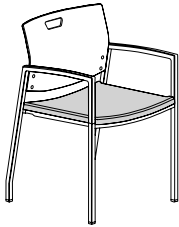
KN3001PPS
plastic seat

KN3001PPS - All Plastic
KN3001PUS - Seat Uph.

- non-stacking
- maple wood trim arm caps available on standard nylon arms; add \$195 list
- linking bracket available, order separately, see page [KN33](#)
- passes a 500 lb load rating test
- wall saver

Dimensions	D	W	H
Overall	21 ¼	21 ¼	32
Seat	17 ¾	19 ¾	18 ½
Arm			26 ¾
Upholstery		Shipping	
COM Ydg	¾	Ctn Wt	16
COL Sq Ft	14	Cu Ft	11

All Plastic	\$590
COM	\$731
A	\$742
B	\$760
COL/C	\$791
D	\$830
E	\$871
F	\$932
G	\$998
H	\$1,069
I	\$1,179
J	\$1,311
L1	\$1,011
L2	\$1,090



KN3001PUS
uph. seat

Straight Arm Chair with Casters



KN3001PPFC
plastic seat

KN3001PPSC - All Plastic
KN3001PUSC - Seat Uph.

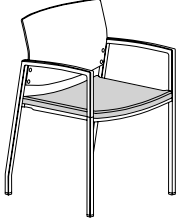
- non-stacking
- maple wood trim arm caps available on standard nylon arms; add \$195 list
- wall saver

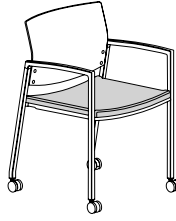
Dimensions	D	W	H
Overall	21 ¼	21 ¼	32
Seat	17 ¾	19 ¾	18 ½
Arm			26 ¾
Upholstery		Shipping	
COM Ydg	¾	Ctn Wt	16
COL Sq Ft	14	Cu Ft	11

All Plastic	\$612
COM	\$754
A	\$763
B	\$781
COL/C	\$812
D	\$851
E	\$892
F	\$954
G	\$1,019
H	\$1,090
I	\$1,201
J	\$1,333
L1	\$1,033
L2	\$1,112



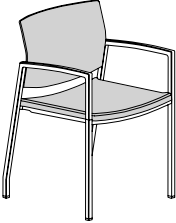
KN3003PUC
uph. seat

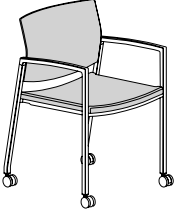
Description	Model	Specifications	List Price Per Grade																						
Straight Arm Chair - Wood Back/Upholstered Seat 	KN3001WUS <ul style="list-style-type: none"> · non-stacking · standard maple veneer back available in maple finishes · optional walnut veneer back available in walnut finishes; add \$30 list · optional horizontal double cut; add \$32 list · optional handle cut out; add \$22 list · maple wood trim arm caps available on standard nylon arms; add \$195 list · linking bracket available, order separately, see page KN33 · passes a 500 lb load rating test · wall saver 	<table border="1"> <thead> <tr> <th>Dimensions</th> <th>D</th> <th>W</th> <th>H</th> </tr> </thead> <tbody> <tr> <td>Overall</td> <td>21 ¼</td> <td>21 ¼</td> <td>32</td> </tr> <tr> <td>Seat</td> <td>17 ¾</td> <td>19 ¾</td> <td>18 ½</td> </tr> <tr> <td>Arm</td> <td></td> <td></td> <td>26 ½</td> </tr> </tbody> </table> <table border="1"> <thead> <tr> <th>Upholstery</th> <th>Shipping</th> </tr> </thead> <tbody> <tr> <td>COM Ydg</td> <td>¾ Ctn Wt 17</td> </tr> <tr> <td>COL Sq Ft</td> <td>14 Cu Ft 11</td> </tr> </tbody> </table>	Dimensions	D	W	H	Overall	21 ¼	21 ¼	32	Seat	17 ¾	19 ¾	18 ½	Arm			26 ½	Upholstery	Shipping	COM Ydg	¾ Ctn Wt 17	COL Sq Ft	14 Cu Ft 11	COM \$950 A \$959 B \$976 COL/C \$1,008 D \$1,047 E \$1,088 F \$1,150 G \$1,215 H \$1,286 I \$1,397 J \$1,529 L1 \$1,228 L2 \$1,307
		Dimensions	D	W	H																				
Overall	21 ¼	21 ¼	32																						
Seat	17 ¾	19 ¾	18 ½																						
Arm			26 ½																						
Upholstery	Shipping																								
COM Ydg	¾ Ctn Wt 17																								
COL Sq Ft	14 Cu Ft 11																								

Description	Model	Specifications	List Price Per Grade																						
Straight Arm Chair with Casters - Wood Back/Upholstered Seat 	KN3001WUSC <ul style="list-style-type: none"> · non-stacking · standard maple veneer back available in maple finishes · optional walnut veneer back available in walnut finishes; add \$30 list · optional horizontal double cut; add \$32 list · optional handle cut out; add \$22 list · maple wood trim arm caps available on standard nylon arms; add \$195 list · wall saver 	<table border="1"> <thead> <tr> <th>Dimensions</th> <th>D</th> <th>W</th> <th>H</th> </tr> </thead> <tbody> <tr> <td>Overall</td> <td>21 ¼</td> <td>21 ¼</td> <td>32</td> </tr> <tr> <td>Seat</td> <td>17 ¾</td> <td>19 ¾</td> <td>18 ½</td> </tr> <tr> <td>Arm</td> <td></td> <td></td> <td>26 ½</td> </tr> </tbody> </table> <table border="1"> <thead> <tr> <th>Upholstery</th> <th>Shipping</th> </tr> </thead> <tbody> <tr> <td>COM Ydg</td> <td>¾ Ctn Wt 17</td> </tr> <tr> <td>COL Sq Ft</td> <td>14 Cu Ft 11</td> </tr> </tbody> </table>	Dimensions	D	W	H	Overall	21 ¼	21 ¼	32	Seat	17 ¾	19 ¾	18 ½	Arm			26 ½	Upholstery	Shipping	COM Ydg	¾ Ctn Wt 17	COL Sq Ft	14 Cu Ft 11	COM \$983 A \$993 B \$1,010 COL/C \$1,041 D \$1,081 E \$1,121 F \$1,183 G \$1,249 H \$1,321 I \$1,429 J \$1,563 L1 \$1,262 L2 \$1,340
		Dimensions	D	W	H																				
Overall	21 ¼	21 ¼	32																						
Seat	17 ¾	19 ¾	18 ½																						
Arm			26 ½																						
Upholstery	Shipping																								
COM Ydg	¾ Ctn Wt 17																								
COL Sq Ft	14 Cu Ft 11																								

To Order, Specify:

- 1 Model Number
- 2 Fabric Selection - vendor, pattern and color
 Visit www.jsifurniture.com/finishes-and-materials/textiles for our textiles program.
 See selection of standard and graded in manufacturers and patterns.
- 3 Plastic Color or Wood Finish - See [Plastic Color or Wood Finish Options](#)
 - a. Plastic Back - standard
 - b. Maple Back - standard
 - c. Walnut Back - add \$30 list per back
 - d. Double Cut Back - add \$32 list per back
- 4 Handle Cut Out - add \$22 list per veneer back
- 7 Metal Frame Finish - See [Metal Frame Options](#)

Description	Model	Specifications				List Price Per Grade	
Straight Arm Chair - All Upholstered 	KN3001UUS · non-stacking · maple wood trim arm caps available on standard nylon arms; add \$195 list · linking bracket available, order separately, see page KN33 · multiple fabrics, see page KN5 · passes a 500 lb load rating test · wall saver	Dimensions		D	W	H	COM \$877
		Overall	21 ¼	21 ¼	32	A \$893	
		Seat	17 ¾	19 ¾	18 ½	B \$921	
		Arm			26 ⅝	COL/C \$973	
		Upholstery		Shipping		D \$1,040	
		COM Ydg	1 ¼	Ctn Wt	18	E \$1,106	
		COL Sq Ft	23	Cu Ft	11	F \$1,208	
						G \$1,321	
						H \$1,435	
						I \$1,620	
						J \$1,841	
						L1 \$1,340	
						L2 \$1,474	

Description	Model	Specifications				List Price Per Grade	
Straight Arm Chair with Casters - All Upholstered 	KN3001UUSC · non-stacking · maple wood trim arm caps available on standard nylon arms; add \$195 list · multiple fabrics, see page KN5 · wall saver	Dimensions		D	W	H	COM \$897
		Overall	21 ¼	21 ¼	32	A \$914	
		Seat	17 ¾	19 ¾	18 ½	B \$941	
		Arm			26 ⅝	COL/C \$994	
		Upholstery		Shipping		D \$1,059	
		COM Ydg	1 ¼	Ctn Wt	18	E \$1,127	
		COL Sq Ft	23	Cu Ft	11	F \$1,228	
						G \$1,339	
						H \$1,456	
						I \$1,640	
						J \$1,862	
						L1 \$1,361	
						L2 \$1,494	

KNOX

Description	D	W	H	CTN WT	CU FT	① Model	List Price Per Grade
Transport Cart	34	23 ¾	40 ¾	29	22	TC01	\$981

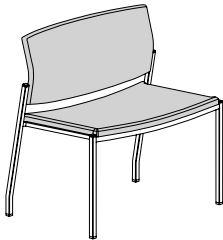
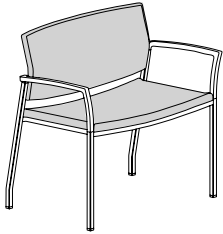
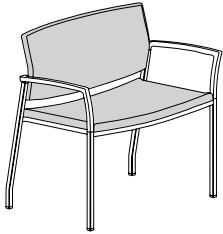


- 16 gauge steel tube
- 4" heavy duty casters
- only available in black
- stacks six armless or flared single chairs

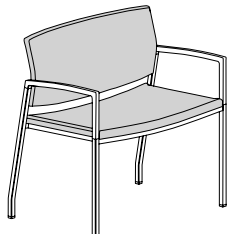
KNOX

To Order, Specify:

- ① Model Number
- ② Fabric Selection - vendor, pattern and color
Visit www.jsifurniture.com/finishes-and-materials/textiles for our textiles program. See selection of standard and graded in manufacturers and patterns.
- ③ Plastic Color or Wood Finish - [See Plastic Color or Wood Finish Options](#)
 - a. Plastic Back - standard
 - b. Maple Back - standard
 - c. Walnut Back - add \$30 list per back
 - d. Double Cut Back - add \$32 list per back
- ④ Handle Cut Out - add \$22 list per veneer back
- ⑦ Metal Frame Finish - [See Metal Frame Options](#)

Description	Model	Specifications	List Price Per Grade																																										
Armless Bariatric Chair - All Upholstered 	KN3053UU <ul style="list-style-type: none"> · non-stacking · meets or exceed BIFMA 5.11 large occupant standard · passes a 500 lb load rating test · multiple fabrics, see page KN5 · linking bracket available, order separately, see page KN33 · wall saver 	<table border="1"> <thead> <tr> <th>Dimensions</th> <th>D</th> <th>W</th> <th>H</th> </tr> </thead> <tbody> <tr> <td>Overall</td> <td>21 ¼</td> <td>32</td> <td>32</td> </tr> <tr> <td>Seat</td> <td>17 ¾</td> <td>30</td> <td>18 ½</td> </tr> </tbody> </table>	Dimensions	D	W	H	Overall	21 ¼	32	32	Seat	17 ¾	30	18 ½	<table border="1"> <tbody> <tr><td>COM</td><td>\$1,222</td></tr> <tr><td>A</td><td>\$1,247</td></tr> <tr><td>B</td><td>\$1,292</td></tr> <tr><td>COL/C</td><td>\$1,376</td></tr> <tr><td>D</td><td>\$1,482</td></tr> <tr><td>E</td><td>\$1,588</td></tr> <tr><td>F</td><td>\$1,751</td></tr> <tr><td>G</td><td>\$1,930</td></tr> <tr><td>H</td><td>\$2,116</td></tr> <tr><td>I</td><td>\$2,411</td></tr> <tr><td>J</td><td>\$2,764</td></tr> <tr><td>L1</td><td>\$1,963</td></tr> <tr><td>L2</td><td>\$2,176</td></tr> </tbody> </table>	COM	\$1,222	A	\$1,247	B	\$1,292	COL/C	\$1,376	D	\$1,482	E	\$1,588	F	\$1,751	G	\$1,930	H	\$2,116	I	\$2,411	J	\$2,764	L1	\$1,963	L2	\$2,176				
		Dimensions	D	W	H																																								
Overall	21 ¼	32	32																																										
Seat	17 ¾	30	18 ½																																										
COM	\$1,222																																												
A	\$1,247																																												
B	\$1,292																																												
COL/C	\$1,376																																												
D	\$1,482																																												
E	\$1,588																																												
F	\$1,751																																												
G	\$1,930																																												
H	\$2,116																																												
I	\$2,411																																												
J	\$2,764																																												
L1	\$1,963																																												
L2	\$2,176																																												
<table border="1"> <thead> <tr> <th>Upholstery</th> <th colspan="2">Shipping</th> </tr> </thead> <tbody> <tr> <td>COM Ydg</td> <td>2</td> <td>Ctn Wt 28</td> </tr> <tr> <td>COL Sq Ft</td> <td>44</td> <td>Cu Ft 15</td> </tr> </tbody> </table>	Upholstery	Shipping		COM Ydg	2	Ctn Wt 28	COL Sq Ft	44	Cu Ft 15																																				
Upholstery	Shipping																																												
COM Ydg	2	Ctn Wt 28																																											
COL Sq Ft	44	Cu Ft 15																																											
Flared Bariatric Chair - All Upholstered 	KN3051UUF <ul style="list-style-type: none"> · non-stacking · meets or exceed BIFMA 5.11 large occupant standard · passes a 500 lb load rating test · nylon arms available in matte black or arctic silver · nylon arms available in matte black or arctic silver · maple wood trim arm caps available on standard nylon arms; add \$195 list · multiple fabrics, see page KN5 · wall saver 	<table border="1"> <thead> <tr> <th>Dimensions</th> <th>D</th> <th>W</th> <th>H</th> </tr> </thead> <tbody> <tr> <td>Overall</td> <td>21 ¼</td> <td>34 ¾</td> <td>32</td> </tr> <tr> <td>Seat</td> <td>17 ¾</td> <td>30</td> <td>18 ½</td> </tr> <tr> <td>Arm</td> <td></td> <td></td> <td>26 ¾</td> </tr> </tbody> </table>	Dimensions	D	W	H	Overall	21 ¼	34 ¾	32	Seat	17 ¾	30	18 ½	Arm			26 ¾	<table border="1"> <tbody> <tr><td>COM</td><td>\$1,322</td></tr> <tr><td>A</td><td>\$1,345</td></tr> <tr><td>B</td><td>\$1,392</td></tr> <tr><td>COL/C</td><td>\$1,475</td></tr> <tr><td>D</td><td>\$1,581</td></tr> <tr><td>E</td><td>\$1,688</td></tr> <tr><td>F</td><td>\$1,851</td></tr> <tr><td>G</td><td>\$2,028</td></tr> <tr><td>H</td><td>\$2,216</td></tr> <tr><td>I</td><td>\$2,510</td></tr> <tr><td>J</td><td>\$2,863</td></tr> <tr><td>L1</td><td>\$2,063</td></tr> <tr><td>L2</td><td>\$2,275</td></tr> </tbody> </table>	COM	\$1,322	A	\$1,345	B	\$1,392	COL/C	\$1,475	D	\$1,581	E	\$1,688	F	\$1,851	G	\$2,028	H	\$2,216	I	\$2,510	J	\$2,863	L1	\$2,063	L2	\$2,275
		Dimensions	D	W	H																																								
Overall	21 ¼	34 ¾	32																																										
Seat	17 ¾	30	18 ½																																										
Arm			26 ¾																																										
COM	\$1,322																																												
A	\$1,345																																												
B	\$1,392																																												
COL/C	\$1,475																																												
D	\$1,581																																												
E	\$1,688																																												
F	\$1,851																																												
G	\$2,028																																												
H	\$2,216																																												
I	\$2,510																																												
J	\$2,863																																												
L1	\$2,063																																												
L2	\$2,275																																												
<table border="1"> <thead> <tr> <th>Upholstery</th> <th colspan="2">Shipping</th> </tr> </thead> <tbody> <tr> <td>COM Ydg</td> <td>2</td> <td>Ctn Wt 29</td> </tr> <tr> <td>COL Sq Ft</td> <td>44</td> <td>Cu Ft 16</td> </tr> </tbody> </table>	Upholstery	Shipping		COM Ydg	2	Ctn Wt 29	COL Sq Ft	44	Cu Ft 16																																				
Upholstery	Shipping																																												
COM Ydg	2	Ctn Wt 29																																											
COL Sq Ft	44	Cu Ft 16																																											
Flared Bariatric Chair - All Upholstered 	KN3051UUF-3 <ul style="list-style-type: none"> · sets of 3 packaged together - must have all same options · non-stacking · meets or exceed BIFMA 5.11 large occupant standard · passes a 500 lb load rating test · nylon arms available in matte black or arctic silver · maple wood trim arm caps available on standard nylon arms; add \$292 list · multiple fabrics, see page KN5 · wall saver 	<table border="1"> <thead> <tr> <th>Dimensions</th> <th>D</th> <th>W</th> <th>H</th> </tr> </thead> <tbody> <tr> <td>Overall</td> <td>21 ¼</td> <td>34 ¾</td> <td>32</td> </tr> <tr> <td>Seat</td> <td>17 ¾</td> <td>30</td> <td>18 ½</td> </tr> <tr> <td>Arm</td> <td></td> <td></td> <td>26 ¾</td> </tr> </tbody> </table>	Dimensions	D	W	H	Overall	21 ¼	34 ¾	32	Seat	17 ¾	30	18 ½	Arm			26 ¾	<table border="1"> <tbody> <tr><td>COM</td><td>\$3,488</td></tr> <tr><td>A</td><td>\$3,548</td></tr> <tr><td>B</td><td>\$3,665</td></tr> <tr><td>COL/C</td><td>\$3,871</td></tr> <tr><td>D</td><td>\$4,135</td></tr> <tr><td>E</td><td>\$4,401</td></tr> <tr><td>F</td><td>\$4,813</td></tr> <tr><td>G</td><td>\$5,254</td></tr> <tr><td>H</td><td>\$5,724</td></tr> <tr><td>I</td><td>\$6,459</td></tr> <tr><td>J</td><td>\$7,343</td></tr> <tr><td>L1</td><td>\$5,343</td></tr> <tr><td>L2</td><td>\$5,871</td></tr> </tbody> </table>	COM	\$3,488	A	\$3,548	B	\$3,665	COL/C	\$3,871	D	\$4,135	E	\$4,401	F	\$4,813	G	\$5,254	H	\$5,724	I	\$6,459	J	\$7,343	L1	\$5,343	L2	\$5,871
		Dimensions	D	W	H																																								
Overall	21 ¼	34 ¾	32																																										
Seat	17 ¾	30	18 ½																																										
Arm			26 ¾																																										
COM	\$3,488																																												
A	\$3,548																																												
B	\$3,665																																												
COL/C	\$3,871																																												
D	\$4,135																																												
E	\$4,401																																												
F	\$4,813																																												
G	\$5,254																																												
H	\$5,724																																												
I	\$6,459																																												
J	\$7,343																																												
L1	\$5,343																																												
L2	\$5,871																																												
<table border="1"> <thead> <tr> <th>Upholstery</th> <th colspan="2">Shipping</th> </tr> </thead> <tbody> <tr> <td>COM Ydg</td> <td>5</td> <td>Ctn Wt 81</td> </tr> <tr> <td>COL Sq Ft</td> <td>90</td> <td>Cu Ft 20</td> </tr> </tbody> </table>	Upholstery	Shipping		COM Ydg	5	Ctn Wt 81	COL Sq Ft	90	Cu Ft 20																																				
Upholstery	Shipping																																												
COM Ydg	5	Ctn Wt 81																																											
COL Sq Ft	90	Cu Ft 20																																											

KNOX

Description	① Model	Specifications				List Price Per Grade																																										
Straight Arm Bariatric Chair - All Upholstered	KN3051UUS <ul style="list-style-type: none"> · non-stacking · meets or exceed BIFMA 5.11 large occupant standard · passes a 500 lb load rating test · maple wood trim arm caps available on standard nylon arms; add \$195 list · multiple fabrics, see page KN5 · linking bracket available, order separately, see page KN33 · wall saver 	<table border="1"> <thead> <tr> <th data-bbox="841 212 1088 241">Dimensions</th> <th data-bbox="1088 212 1144 241">D</th> <th data-bbox="1144 212 1226 241">W</th> <th data-bbox="1226 212 1339 241">H</th> </tr> </thead> <tbody> <tr> <td data-bbox="841 254 1088 283">Overall</td> <td data-bbox="1088 254 1144 283">21 ¼</td> <td data-bbox="1144 254 1226 283">32</td> <td data-bbox="1226 254 1339 283">32</td> </tr> <tr> <td data-bbox="841 296 1088 325">Seat</td> <td data-bbox="1088 296 1144 325">17 ¾</td> <td data-bbox="1144 296 1226 325">30</td> <td data-bbox="1226 296 1339 325">18 ½</td> </tr> <tr> <td data-bbox="841 338 1088 367">Arm</td> <td colspan="2" data-bbox="1088 338 1226 367"></td> <td data-bbox="1226 338 1339 367">26 ¾</td> </tr> </tbody> </table>				Dimensions	D	W	H	Overall	21 ¼	32	32	Seat	17 ¾	30	18 ½	Arm			26 ¾	<table border="0"> <tr><td>COM</td><td>\$1,322</td></tr> <tr><td>A</td><td>\$1,345</td></tr> <tr><td>B</td><td>\$1,392</td></tr> <tr><td>COL/C</td><td>\$1,475</td></tr> <tr><td>D</td><td>\$1,581</td></tr> <tr><td>E</td><td>\$1,688</td></tr> <tr><td>F</td><td>\$1,851</td></tr> <tr><td>G</td><td>\$2,028</td></tr> <tr><td>H</td><td>\$2,216</td></tr> <tr><td>I</td><td>\$2,510</td></tr> <tr><td>J</td><td>\$2,863</td></tr> <tr><td>L1</td><td>\$2,063</td></tr> <tr><td>L2</td><td>\$2,275</td></tr> </table>	COM	\$1,322	A	\$1,345	B	\$1,392	COL/C	\$1,475	D	\$1,581	E	\$1,688	F	\$1,851	G	\$2,028	H	\$2,216	I	\$2,510	J	\$2,863	L1	\$2,063	L2	\$2,275
Dimensions	D	W	H																																													
Overall	21 ¼	32	32																																													
Seat	17 ¾	30	18 ½																																													
Arm			26 ¾																																													
COM	\$1,322																																															
A	\$1,345																																															
B	\$1,392																																															
COL/C	\$1,475																																															
D	\$1,581																																															
E	\$1,688																																															
F	\$1,851																																															
G	\$2,028																																															
H	\$2,216																																															
I	\$2,510																																															
J	\$2,863																																															
L1	\$2,063																																															
L2	\$2,275																																															
		<table border="1"> <thead> <tr> <th data-bbox="841 367 1088 399">Upholstery</th> <th colspan="3" data-bbox="1088 367 1339 399">Shipping</th> </tr> </thead> <tbody> <tr> <td data-bbox="841 411 1088 441">COM Ydg</td> <td data-bbox="1088 411 1144 441">2</td> <td data-bbox="1144 411 1226 441">Ctn Wt</td> <td data-bbox="1226 411 1339 441">29</td> </tr> <tr> <td data-bbox="841 453 1088 483">COL Sq Ft</td> <td data-bbox="1088 453 1144 483">44</td> <td data-bbox="1144 453 1226 483">Cu Ft</td> <td data-bbox="1226 453 1339 483">15</td> </tr> </tbody> </table>				Upholstery	Shipping			COM Ydg	2	Ctn Wt	29	COL Sq Ft	44	Cu Ft	15																															
Upholstery	Shipping																																															
COM Ydg	2	Ctn Wt	29																																													
COL Sq Ft	44	Cu Ft	15																																													

KNOX

To Order, Specify:

- ① Model Number
- ② Fabric Selection - vendor, pattern and color
 Visit www.jsifurniture.com/finishes-and-materials/textiles for our textiles program.
 See selection of standard and graded in manufacturers and patterns.
- ③ Plastic Color or Wood Finish - [See Plastic Color or Wood Finish Options](#)
 - a. Plastic Back - standard
 - b. Maple Back - standard
 - c. Walnut Back - add \$30 list per back
 - d. Double Cut Back - add \$32 list per back
- ④ Handle Cut Out - add \$22 list per veneer back
- ⑦ Metal Frame Finish - [See Metal Frame Options](#)

Description

Model

Specifications

List Price Per Grade

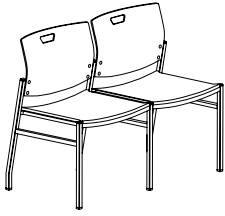
Armless Two Seat Unit

KN3092PP - All Plastic
KN3092PU - Uph. Seat

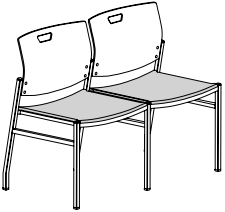
- shipped assembled
- wall saver

Dimensions	D	W	H
Overall	21 ¼	40 ⅝	32
Seat	17 ⅜	19	18 ½
Upholstery		Shipping	
COM Ydg	¾	Ctn Wt	28
COL Sq Ft	14	Cu Ft	19

All Plastic	\$1,043
COM	\$1,299
A	\$1,307
B	\$1,326
COL/C	\$1,356
D	\$1,397
E	\$1,435
F	\$1,498
G	\$1,565
H	\$1,634
I	\$1,745
J	\$1,877
L1	\$1,577
L2	\$1,656



KN3092PP
plastic seat



KN3092PU
uph. seat

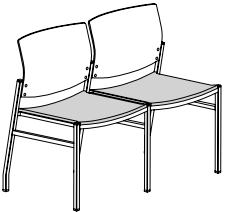
Armless Two Seat Unit -
Wood Back/Uph. Seat

KN3092WU

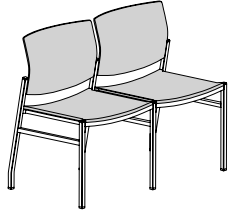
- shipped assembled
- standard maple veneer back available in maple finishes
- optional walnut veneer back available in walnut finishes; add \$60 list
- optional horizontal double cut; add \$64 list
- optional handle cut out; add \$44 list
- wall saver

Dimensions	D	W	H
Overall	21 ¼	40 ⅝	32
Seat	17 ⅜	19	18 ½
Upholstery		Shipping	
COM Ydg	¾	Ctn Wt	28
COL Sq Ft	14	Cu Ft	19

COM	\$1,621
A	\$1,630
B	\$1,649
COL/C	\$1,678
D	\$1,719
E	\$1,760
F	\$1,821
G	\$1,888
H	\$1,958
I	\$2,068
J	\$2,201
L1	\$1,900
L2	\$1,980



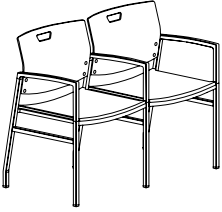

KNOX

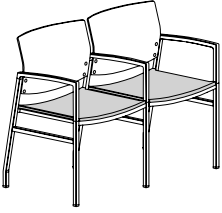
Description	① Model	Specifications			List Price Per Grade	
Armless Two Seat Unit - All Upholstered 	KN3092UU • shipped assembled • multiple fabrics, see page KN5 • wall saver	Dimensions	D	W	H	COM \$1,607
		Overall	21 ¼	40 ⅝	32	A \$1,630
		Seat	17 ¾	19	18 ½	B \$1,677
		Upholstery	Shipping			COL/C \$1,761
		COM Ydg	2	Ctn Wt	30	D \$1,867
		COL Sq Ft	40	Cu Ft	19	E \$1,973
						F \$2,137
						G \$2,313
						H \$2,501
						I \$2,796
						J \$3,149
						L1 \$2,349
						L2 \$2,560

KNOX

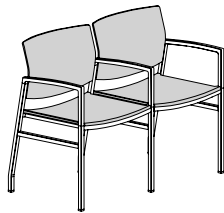
To Order, Specify:

- ① Model Number
- ② Fabric Selection - vendor, pattern and color
 Visit www.jsifurniture.com/finishes-and-materials/textiles for our textiles program.
 See selection of standard and graded in manufacturers and patterns.
- ③ Plastic Color or Wood Finish - See [Plastic Color or Wood Finish Options](#)
 - a. Plastic Back - standard
 - b. Maple Back - standard
 - c. Walnut Back - add \$30 list per back
 - d. Double Cut Back - add \$32 list per back
- ④ Handle Cut Out - add \$22 list per veneer back
- ⑦ Metal Frame Finish - See [Metal Frame Options](#)

Description	Model	Specifications	List Price Per Grade																
Straight Arm Two Seat Unit  KN3092PPS plastic seat	KN3092PPS- All Plastic KN3092PUS- Uph. Seat <ul style="list-style-type: none"> · shipped assembled · maple wood trim arm caps available on standard nylon arms; add \$292 list · linking bracket available, order separately, see page KN33 · wall saver 	<table border="1"> <thead> <tr> <th>Dimensions</th> <th>D</th> <th>W</th> <th>H</th> </tr> </thead> <tbody> <tr> <td>Overall</td> <td>21 ¼</td> <td>40 ⅝</td> <td>32</td> </tr> <tr> <td>Seat</td> <td>17 ⅜</td> <td>19</td> <td>18 ½</td> </tr> <tr> <td>Arm</td> <td></td> <td></td> <td>26 ⅝</td> </tr> </tbody> </table>	Dimensions	D	W	H	Overall	21 ¼	40 ⅝	32	Seat	17 ⅜	19	18 ½	Arm			26 ⅝	All Plastic \$1,180 COM \$1,434 A \$1,445 B \$1,461 COL/C \$1,493 D \$1,533 E \$1,573 F \$1,634 G \$1,700 H \$1,772 I \$1,882 J \$2,015 L1 \$1,714 L2 \$1,793
		Dimensions	D	W	H														
Overall	21 ¼	40 ⅝	32																
Seat	17 ⅜	19	18 ½																
Arm			26 ⅝																
<table border="1"> <thead> <tr> <th>Upholstery</th> <th colspan="3">Shipping</th> </tr> </thead> <tbody> <tr> <td>COM Ydg</td> <td>¾</td> <td>Ctn Wt</td> <td>30</td> </tr> <tr> <td>COL Sq Ft</td> <td>14</td> <td>Cu Ft</td> <td>19</td> </tr> </tbody> </table>	Upholstery	Shipping			COM Ydg	¾	Ctn Wt	30	COL Sq Ft	14	Cu Ft	19							
Upholstery	Shipping																		
COM Ydg	¾	Ctn Wt	30																
COL Sq Ft	14	Cu Ft	19																
KN3092PUS uph. seat 																			

Straight Arm Two Seat Unit - Wood Back/Upholstered Seat  KN3092WUS	<ul style="list-style-type: none"> · shipped assembled · standard maple veneer back available in maple finishes · optional walnut veneer back available in walnut finishes; add \$60 list · optional horizontal double cut; add \$64 list · optional handle cut out; add \$44 list · maple wood trim arm caps available on standard nylon arms; add \$292 list · linking bracket available, order separately, see page KN33 · wall saver 	<table border="1"> <thead> <tr> <th>Dimensions</th> <th>D</th> <th>W</th> <th>H</th> </tr> </thead> <tbody> <tr> <td>Overall</td> <td>21 ¼</td> <td>40 ⅝</td> <td>32</td> </tr> <tr> <td>Seat</td> <td>17 ⅜</td> <td>19</td> <td>18 ½</td> </tr> <tr> <td>Arm</td> <td></td> <td></td> <td>26 ⅝</td> </tr> </tbody> </table>	Dimensions	D	W	H	Overall	21 ¼	40 ⅝	32	Seat	17 ⅜	19	18 ½	Arm			26 ⅝	COM \$1,756 A \$1,767 B \$1,784 COL/C \$1,815 D \$1,856 E \$1,895 F \$1,957 G \$2,022 H \$2,094 I \$2,203 J \$2,335 L1 \$2,036 L2 \$2,115
		Dimensions	D	W	H														
Overall	21 ¼	40 ⅝	32																
Seat	17 ⅜	19	18 ½																
Arm			26 ⅝																
<table border="1"> <thead> <tr> <th>Upholstery</th> <th colspan="3">Shipping</th> </tr> </thead> <tbody> <tr> <td>COM Ydg</td> <td>¾</td> <td>Ctn Wt</td> <td>32</td> </tr> <tr> <td>COL Sq Ft</td> <td>14</td> <td>Cu Ft</td> <td>19</td> </tr> </tbody> </table>	Upholstery	Shipping			COM Ydg	¾	Ctn Wt	32	COL Sq Ft	14	Cu Ft	19							
Upholstery	Shipping																		
COM Ydg	¾	Ctn Wt	32																
COL Sq Ft	14	Cu Ft	19																

KNOX

Description	① Model	Specifications				List Price Per Grade																																																							
Straight Arm Two Seat Unit - All Upholstered 	KN3092UUS · shipped assembled · maple wood trim arm caps available on standard nylon arms; add \$292 list · multiple fabrics, see page KN5 · linking bracket available, order separately, see page KN33 · wall saver	<table border="1"> <thead> <tr> <th data-bbox="836 210 1088 241">Dimensions</th> <th data-bbox="1088 210 1161 241">D</th> <th data-bbox="1161 210 1242 241">W</th> <th data-bbox="1242 210 1339 241">H</th> </tr> </thead> <tbody> <tr> <td data-bbox="836 241 1088 283">Overall</td> <td data-bbox="1088 241 1161 283">21 ¼</td> <td data-bbox="1161 241 1242 283">40 ⅝</td> <td data-bbox="1242 241 1339 283">32</td> </tr> <tr> <td data-bbox="836 283 1088 325">Seat</td> <td data-bbox="1088 283 1161 325">17 ⅜</td> <td data-bbox="1161 283 1242 325">19</td> <td data-bbox="1242 283 1339 325">18 ½</td> </tr> <tr> <td data-bbox="836 325 1088 367">Arm</td> <td colspan="2" data-bbox="1088 325 1242 367"></td> <td data-bbox="1242 325 1339 367">26 ⅝</td> </tr> <tr> <th colspan="2" data-bbox="836 367 1088 409">Upholstery</th> <th colspan="2" data-bbox="1088 367 1339 409">Shipping</th> </tr> <tr> <td data-bbox="836 409 1088 451">COM Ydg</td> <td data-bbox="1088 409 1161 451">2 ¼</td> <td data-bbox="1161 409 1242 451">Ctn Wt</td> <td data-bbox="1242 409 1339 451">36</td> </tr> <tr> <td data-bbox="836 451 1088 493">COL Sq Ft</td> <td data-bbox="1088 451 1161 493">45</td> <td data-bbox="1161 451 1242 493">Cu Ft</td> <td data-bbox="1242 451 1339 493">19</td> </tr> </tbody> </table>				Dimensions	D	W	H	Overall	21 ¼	40 ⅝	32	Seat	17 ⅜	19	18 ½	Arm			26 ⅝	Upholstery		Shipping		COM Ydg	2 ¼	Ctn Wt	36	COL Sq Ft	45	Cu Ft	19	<table> <tbody> <tr><td>COM</td><td>\$1,744</td></tr> <tr><td>A</td><td>\$1,771</td></tr> <tr><td>B</td><td>\$1,824</td></tr> <tr><td>COL/C</td><td>\$1,916</td></tr> <tr><td>D</td><td>\$2,036</td></tr> <tr><td>E</td><td>\$2,155</td></tr> <tr><td>F</td><td>\$2,340</td></tr> <tr><td>G</td><td>\$2,539</td></tr> <tr><td>H</td><td>\$2,751</td></tr> <tr><td>I</td><td>\$3,081</td></tr> <tr><td>J</td><td>\$3,478</td></tr> <tr><td>L1</td><td>\$2,577</td></tr> <tr><td>L2</td><td>\$2,816</td></tr> </tbody> </table>		COM	\$1,744	A	\$1,771	B	\$1,824	COL/C	\$1,916	D	\$2,036	E	\$2,155	F	\$2,340	G	\$2,539	H	\$2,751	I	\$3,081	J	\$3,478	L1	\$2,577	L2	\$2,816
Dimensions	D	W	H																																																										
Overall	21 ¼	40 ⅝	32																																																										
Seat	17 ⅜	19	18 ½																																																										
Arm			26 ⅝																																																										
Upholstery		Shipping																																																											
COM Ydg	2 ¼	Ctn Wt	36																																																										
COL Sq Ft	45	Cu Ft	19																																																										
COM	\$1,744																																																												
A	\$1,771																																																												
B	\$1,824																																																												
COL/C	\$1,916																																																												
D	\$2,036																																																												
E	\$2,155																																																												
F	\$2,340																																																												
G	\$2,539																																																												
H	\$2,751																																																												
I	\$3,081																																																												
J	\$3,478																																																												
L1	\$2,577																																																												
L2	\$2,816																																																												

KNOX

To Order, Specify:

- ① Model Number
- ② Fabric Selection - vendor, pattern and color
 Visit www.jsifurniture.com/finishes-and-materials/textiles for our textiles program.
 See selection of standard and graded in manufacturers and patterns.
- ③ Plastic Color or Wood Finish - See [Plastic Color or Wood Finish Options](#)
 - a. Plastic Back - standard
 - b. Maple Back - standard
 - c. Walnut Back - add \$30 list per back
 - d. Double Cut Back - add \$32 list per back
- ④ Handle Cut Out - add \$22 list per veneer back
- ⑦ Metal Frame Finish - See [Metal Frame Options](#)

Description

Model

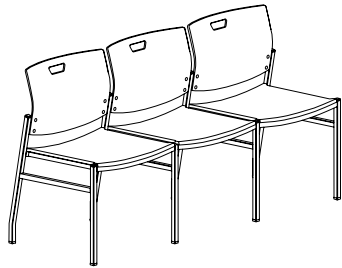
Specifications

List Price Per Grade

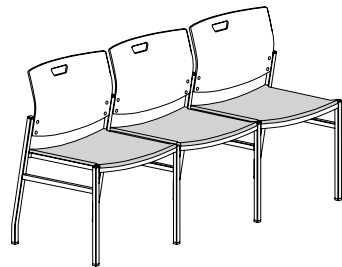
Armless Three Seat Unit

KN3093PP - All Plastic
KN3093PU - Uph. Seat

- shipped assembled
- wall saver



KN3093PP
plastic seat



KN3093PU
uph. seat

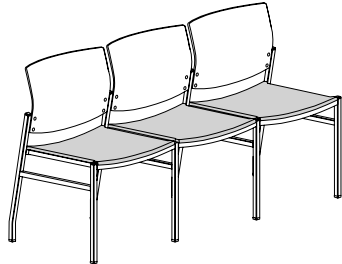
Dimensions	D	W	H
Overall	21 ¼	60	32
Seat	17 ¾	19	18 ½
Upholstery		Shipping	
COM Ydg	1 ¼	Ctn Wt	39
COL Sq Ft	25	Cu Ft	28

All Plastic	\$1,530
COM	\$1,933
A	\$1,948
B	\$1,978
COL/C	\$2,030
D	\$2,095
E	\$2,161
F	\$2,264
G	\$2,375
H	\$2,492
I	\$2,675
J	\$2,896
L1	\$2,397
L2	\$2,529

Armless Three Seat Unit -
Wood Back/Upholstered Seat

KN3093WU

- shipped assembled
- standard maple veneer back available in maple finishes
- optional walnut veneer back available in walnut finishes; add \$90 list
- optional horizontal double cut; add \$96 list
- optional handle cut out; add \$66 list
- wall saver



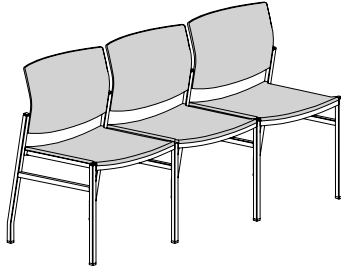
Dimensions	D	W	H
Overall	21 ¼	60	32
Seat	17 ¾	19	18 ½
Upholstery		Shipping	
COM Ydg	1 ¼	Ctn Wt	39
COL Sq Ft	25	Cu Ft	28

COM	\$2,475
A	\$2,491
B	\$2,519
COL/C	\$2,571
D	\$2,637
E	\$2,703
F	\$2,806
G	\$2,917
H	\$3,033
I	\$3,217
J	\$3,437
L1	\$2,938
L2	\$3,070

KNOX

Description

Armless Three Seat Unit -
All Upholstered



① Model

KN3093UU

- shipped assembled
- multiple fabrics, see page [KN5](#)
- wall saver

Specifications

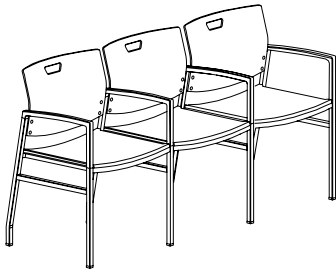
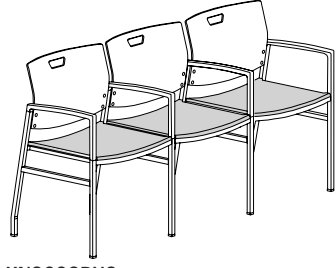
Dimensions	D	W	H
Overall	21 ¼	60	32
Seat	17 ¾	19	18 ½
Upholstery		Shipping	
COM Ydg	3 ¼	Ctn Wt	42
COL Sq Ft	65	Cu Ft	28

List Price Per Grade

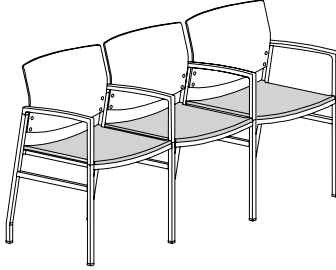
COM	\$2,398
A	\$2,436
B	\$2,514
COL/C	\$2,647
D	\$2,819
E	\$2,991
F	\$3,259
G	\$3,546
H	\$3,850
I	\$4,330
J	\$4,903
L1	\$3,603
L2	\$3,946

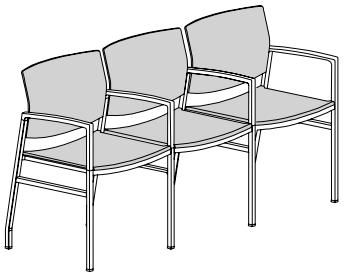
To Order, Specify:

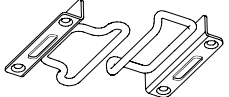
- ① Model Number
- ② Fabric Selection - vendor, pattern and color
Visit www.jsifurniture.com/finishes-and-materials/textiles for our textiles program.
See selection of standard and graded in manufacturers and patterns.
- ③ Plastic Color or Wood Finish - See [Plastic Color or Wood Finish Options](#)
 - a. Plastic Back - standard
 - b. Maple Back - standard
 - c. Walnut Back - add \$30 list per back
 - d. Double Cut Back - add \$32 list per back
- ④ Handle Cut Out - add \$22 list per veneer back
- ⑦ Metal Frame Finish - See [Metal Frame Options](#)

Description	Model	Specifications	List Price Per Grade																
Straight Arm Three Seat Unit  KN3093PPS plastic seat	KN3093PPS - All Plastic KN3093PUS - Seat Uph. <ul style="list-style-type: none"> · shipped assembled · maple wood trim arm caps available on standard nylon arms; add \$389 list · linking bracket available, order separately, see page KN33 · wall saver 	<table border="1"> <thead> <tr> <th>Dimensions</th> <th>D</th> <th>W</th> <th>H</th> </tr> </thead> <tbody> <tr> <td>Overall</td> <td>21 ¼</td> <td>62</td> <td>32</td> </tr> <tr> <td>Seat</td> <td>17 ¾</td> <td>19</td> <td>18 ½</td> </tr> <tr> <td>Arm</td> <td></td> <td></td> <td>26 ⅝</td> </tr> </tbody> </table>	Dimensions	D	W	H	Overall	21 ¼	62	32	Seat	17 ¾	19	18 ½	Arm			26 ⅝	All Plastic \$1,704 COM \$2,121 A \$2,140 B \$2,176 COL/C \$2,237 D \$2,316 E \$2,397 F \$2,520 G \$2,651 H \$2,794 I \$3,013 J \$3,278 L1 \$2,678 L2 \$2,838
		Dimensions	D	W	H														
Overall	21 ¼	62	32																
Seat	17 ¾	19	18 ½																
Arm			26 ⅝																
<table border="1"> <thead> <tr> <th>Upholstery</th> <th colspan="3">Shipping</th> </tr> </thead> <tbody> <tr> <td>COM Ydg</td> <td>1 ½</td> <td>Ctn Wt</td> <td>42</td> </tr> <tr> <td>COL Sq Ft</td> <td>30</td> <td>Cu Ft</td> <td>28</td> </tr> </tbody> </table>	Upholstery	Shipping			COM Ydg	1 ½	Ctn Wt	42	COL Sq Ft	30	Cu Ft	28							
Upholstery	Shipping																		
COM Ydg	1 ½	Ctn Wt	42																
COL Sq Ft	30	Cu Ft	28																
 KN3093PUS uph. seat																			

KNOX

Description	Model	Specifications	List Price Per Grade																
Straight Arm Three Seat Unit - Wood Back/Upholstered Seat  KN3093WUS	<ul style="list-style-type: none"> · shipped assembled · standard maple veneer back available in maple finishes · optional walnut veneer back available in walnut finishes; add \$90 list · optional horizontal double cut; add \$96 list · optional handle cut out; add \$66 list · maple wood trim arm caps available on standard nylon arms; add \$389 list · linking bracket available, order separately, see page KN33 · wall saver 	<table border="1"> <thead> <tr> <th>Dimensions</th> <th>D</th> <th>W</th> <th>H</th> </tr> </thead> <tbody> <tr> <td>Overall</td> <td>21 ¼</td> <td>62</td> <td>32</td> </tr> <tr> <td>Seat</td> <td>17 ¾</td> <td>19</td> <td>18 ½</td> </tr> <tr> <td>Arm</td> <td></td> <td></td> <td>26 ⅝</td> </tr> </tbody> </table>	Dimensions	D	W	H	Overall	21 ¼	62	32	Seat	17 ¾	19	18 ½	Arm			26 ⅝	COM \$2,663 A \$2,682 B \$2,717 COL/C \$2,778 D \$2,858 E \$2,938 F \$3,061 G \$3,192 H \$3,335 I \$3,555 J \$3,821 L1 \$3,219 L2 \$3,379
		Dimensions	D	W	H														
Overall	21 ¼	62	32																
Seat	17 ¾	19	18 ½																
Arm			26 ⅝																
<table border="1"> <thead> <tr> <th>Upholstery</th> <th colspan="3">Shipping</th> </tr> </thead> <tbody> <tr> <td>COM Ydg</td> <td>1 ½</td> <td>Ctn Wt</td> <td>45</td> </tr> <tr> <td>COL Sq Ft</td> <td>30</td> <td>Cu Ft</td> <td>28</td> </tr> </tbody> </table>	Upholstery	Shipping			COM Ydg	1 ½	Ctn Wt	45	COL Sq Ft	30	Cu Ft	28							
Upholstery	Shipping																		
COM Ydg	1 ½	Ctn Wt	45																
COL Sq Ft	30	Cu Ft	28																

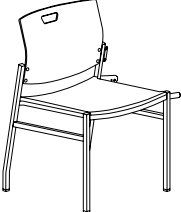
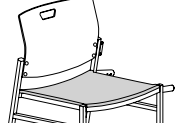
Description	Model	Specifications				List Price Per Grade	
Straight Arm Three Seat Unit - All Upholstered 	KN3093UUS • shipped assembled • maple wood trim arm caps available on standard nylon arms; add \$389 list • multiple fabrics, see page KN5 • linking bracket available, order separately, see page KN33 • wall saver	Dimensions	D	W	H	COM	\$2,579
		Overall	21 ¼	62	32	A	\$2,619
		Seat	17 ¾	19	18 ½	B	\$2,695
		Arm			26 ½	COL/C	\$2,828
		Upholstery		Shipping		D	\$3,002
		COM Ydg	3 ¼	Ctn Wt	51	E	\$3,175
		COL Sq Ft	65	Cu Ft	28	F	\$3,441
						G	\$3,727
						H	\$4,034
						I	\$4,513
						J	\$5,084
						L1	\$3,786
						L2	\$4,129

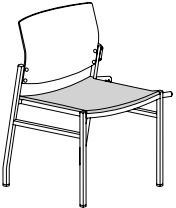
Description	D	W	H	CTN WT	CU FT	Model	List Price
Linking Bracket 				1	1	KN30BRKT	\$68

• matte black wire loop ganging bracket set

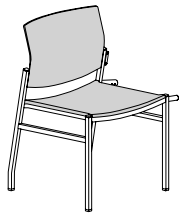
To Order, Specify:

- 1 Model Number
- 2 Fabric Selection - vendor, pattern and color
 Visit www.jsifurniture.com/finishes-and-materials/textiles for our textiles program.
 See selection of standard and graded in manufacturers and patterns.
- 3 Plastic Color or Wood Finish - See [Plastic Color or Wood Finish Options](#)
 - a. Plastic Back - standard
 - b. Maple Back - standard
 - c. Walnut Back - add \$30 list per back
 - d. Double Cut Back - add \$32 list per back
- 4 Handle Cut Out - add \$22 list per veneer back
- 7 Metal Frame Finish - See [Metal Frame Options](#)

Description	Model	Specifications	List Price Per Grade																								
Armless Starter Module  KN3092PPS plastic seat	KN3003PPS - All Plastic KN3003PUS - Seat Uph. <ul style="list-style-type: none"> · starts the run of multiple seating groups, requires additional components · requires setup with other modules, instructions included · connecting rods extend past leg, see page KN8 for details · wall saver 	<table border="1"> <thead> <tr> <th>Dimensions</th> <th>D</th> <th>W</th> <th>H</th> </tr> </thead> <tbody> <tr> <td>Overall</td> <td>21 ¼</td> <td>21 ¼</td> <td>32</td> </tr> <tr> <td>Seat</td> <td>17 ¾</td> <td>19</td> <td>18 ½</td> </tr> <tr> <th colspan="2">Upholstery</th> <th colspan="2">Shipping</th> </tr> <tr> <td>COM Ydg</td> <td>¾</td> <td>Ctn Wt</td> <td>17</td> </tr> <tr> <td>COL Sq Ft</td> <td>14</td> <td>Cu Ft</td> <td>11</td> </tr> </tbody> </table>	Dimensions	D	W	H	Overall	21 ¼	21 ¼	32	Seat	17 ¾	19	18 ½	Upholstery		Shipping		COM Ydg	¾	Ctn Wt	17	COL Sq Ft	14	Cu Ft	11	All Plastic \$595 COM \$722 A \$730 B \$749 COL/C \$778 D \$819 E \$860 F \$921 G \$988 H \$1,058 I \$1,168 J \$1,301 L1 \$1,000 L2 \$1,080
		Dimensions	D	W	H																						
Overall	21 ¼	21 ¼	32																								
Seat	17 ¾	19	18 ½																								
Upholstery		Shipping																									
COM Ydg	¾	Ctn Wt	17																								
COL Sq Ft	14	Cu Ft	11																								
 KN3092PUS uph. seat																											

Description	Model	Specifications	List Price Per Grade																								
Armless Starter Module - Wood Back/Upholstered Seat 	KN3003WUS <ul style="list-style-type: none"> · starts the run of multiple seating groups, requires additional components · requires setup with other modules, instructions included · connecting rods extend past leg, see page KN8 for details · standard maple veneer back available in maple finishes · optional walnut veneer back available in walnut finishes; add \$30 list · optional horizontal double cut; add \$32 list · optional handle cut out; add \$22 list · wall saver 	<table border="1"> <thead> <tr> <th>Dimensions</th> <th>D</th> <th>W</th> <th>H</th> </tr> </thead> <tbody> <tr> <td>Overall</td> <td>21 ¼</td> <td>21 ¼</td> <td>32</td> </tr> <tr> <td>Seat</td> <td>17 ¾</td> <td>19</td> <td>18 ½</td> </tr> <tr> <th colspan="2">Upholstery</th> <th colspan="2">Shipping</th> </tr> <tr> <td>COM Ydg</td> <td>¾</td> <td>Ctn Wt</td> <td>17</td> </tr> <tr> <td>COL Sq Ft</td> <td>14</td> <td>Cu Ft</td> <td>11</td> </tr> </tbody> </table>	Dimensions	D	W	H	Overall	21 ¼	21 ¼	32	Seat	17 ¾	19	18 ½	Upholstery		Shipping		COM Ydg	¾	Ctn Wt	17	COL Sq Ft	14	Cu Ft	11	COM \$959 A \$968 B \$986 COL/C \$1,016 D \$1,057 E \$1,096 F \$1,159 G \$1,225 H \$1,296 I \$1,406 J \$1,539 L1 \$1,238 L2 \$1,317
Dimensions	D	W	H																								
Overall	21 ¼	21 ¼	32																								
Seat	17 ¾	19	18 ½																								
Upholstery		Shipping																									
COM Ydg	¾	Ctn Wt	17																								
COL Sq Ft	14	Cu Ft	11																								

KN34

Description	① Model	Specifications			List Price Per Grade	
Armless Starter Module - All Upholstered	KN3003UUS <ul style="list-style-type: none"> · starts the run of multiple seating groups, requires additional components · requires setup with other modules, instructions included · connecting rods extend past leg, see page KN8 for details · screw cap cover will be provided to back attachment · wall saver 	Dimensions	D	W	H	COM \$887
		Overall	21 ¼	21 ¼	32	A \$902
		Seat	17 ¾	19	18 ½	B \$931
		Upholstery	Shipping		COL/C \$983	
		COM Ydg	1 ¼	Ctn Wt	18	D \$1,048
		COL Sq Ft	23	Cu Ft	11	E \$1,116
						F \$1,217
						G \$1,329
						H \$1,446
						I \$1,629
						J \$1,851
						L1 \$1,350
						L2 \$1,483

KNOX

To Order, Specify:

- ① Model Number
- ② Fabric Selection - vendor, pattern and color
 Visit www.jsifurniture.com/finishes-and-materials/textiles for our textiles program.
 See selection of standard and graded in manufacturers and patterns.
- ③ Plastic Color or Wood Finish - See [Plastic Color or Wood Finish Options](#)
 - a. Plastic Back - standard
 - b. Maple Back - standard
 - c. Walnut Back - add \$30 list per back
 - d. Double Cut Back - add \$32 list per back
- ④ Handle Cut Out - add \$22 list per veneer back
- ⑦ Metal Frame Finish - See [Metal Frame Options](#)

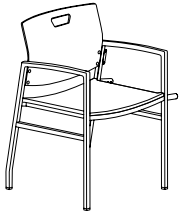
Description

Model

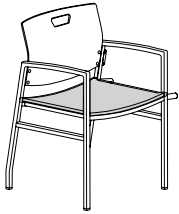
Specifications

List Price Per Grade

Straight Arm Starter Module



KN3001PPSS
plastic seat



KN3001PUSS
uph. seat

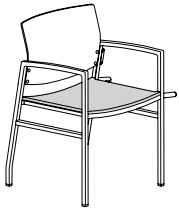
KN3001PPSS - All Plastic
KN3001PUSS - Seat Uph.

- non-stacking
- starts the run of multiple seating groups, requires additional components
- requires setup with other modules, instructions included
- connecting rods extend past leg, see page [KN8](#) for details
- maple wood trim arm caps available on standard nylon arms; add \$195 list
- wall saver

Dimensions	D	W	H
Overall	21 ¼	21 ¼	32
Seat	17 ¾	19	18 ½
Arm			26 ⅝
Upholstery		Shipping	
COM Ydg	¾	Ctn Wt	18
COL Sq Ft	14	Cu Ft	11

All Plastic	\$692
COM	\$817
A	\$826
B	\$844
COL/C	\$874
D	\$915
E	\$956
F	\$1,016
G	\$1,083
H	\$1,154
I	\$1,263
J	\$1,397
L1	\$1,095
L2	\$1,175

Straight Arm Starter Module -
Wood Back/Upholstered Seat

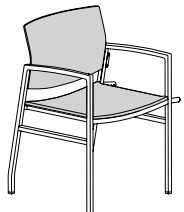


KN3001WUSS

- non-stacking
- starts the run of multiple seating groups, requires additional components
- requires setup with other modules, instructions included
- connecting rods extend past leg, see page [KN8](#) for details
- standard maple veneer back available in maple finishes
- optional walnut veneer back available in walnut finishes; add \$30 list
- optional horizontal double cut; add \$32 list
- optional handle cut out; add \$22 list
- maple wood trim arm caps available on standard nylon arms; add \$195 list
- wall saver

Dimensions	D	W	H
Overall	21 ¼	21 ¼	32
Seat	17 ¾	19	18 ½
Arm			26 ⅝
Upholstery		Shipping	
COM Ydg	¾	Ctn Wt	19
COL Sq Ft	14	Cu Ft	11

COM	\$1,054
A	\$1,063
B	\$1,081
COL/C	\$1,112
D	\$1,153
E	\$1,192
F	\$1,254
G	\$1,321
H	\$1,390
I	\$1,501
J	\$1,633
L1	\$1,333
L2	\$1,412

Description	① Model	Specifications				List Price Per Grade																		
Straight Arm Starter Module - All Upholstered	KN3001UUSS <ul style="list-style-type: none"> · non-stacking · starts the run of multiple seating groups, requires additional components · requires setup with other modules, instructions included · connecting rods extend past leg, see page KN8 for details · screw cap cover will be provided to back attachment · maple wood trim arm caps available on standard nylon arms; add \$195 list · multiple fabrics, see page KN5 · wall saver 	<table border="1"> <thead> <tr> <th data-bbox="836 210 1015 241">Dimensions</th> <th data-bbox="1015 210 1096 241">D</th> <th data-bbox="1096 210 1209 241">W</th> <th data-bbox="1209 210 1339 241">H</th> </tr> </thead> <tbody> <tr> <td data-bbox="836 241 1015 273">Overall</td> <td data-bbox="1015 241 1096 273">21 ¼</td> <td data-bbox="1096 241 1209 273">21 ¼</td> <td data-bbox="1209 241 1339 273">32</td> </tr> <tr> <td data-bbox="836 273 1015 304">Seat</td> <td data-bbox="1015 273 1096 304">17 ¾</td> <td data-bbox="1096 273 1209 304">19</td> <td data-bbox="1209 273 1339 304">18 ½</td> </tr> <tr> <td data-bbox="836 304 1015 336">Arm</td> <td colspan="2" data-bbox="1015 304 1209 336"></td> <td data-bbox="1209 304 1339 336">26 ½</td> </tr> </tbody> </table>				Dimensions	D	W	H	Overall	21 ¼	21 ¼	32	Seat	17 ¾	19	18 ½	Arm			26 ½	COM \$982		
Dimensions	D	W	H																					
Overall	21 ¼	21 ¼	32																					
Seat	17 ¾	19	18 ½																					
Arm			26 ½																					
					A \$998																			
						B \$1,027																		
						COL/C \$1,079																		
						D \$1,143																		
						E \$1,211																		
						F \$1,312																		
						G \$1,424																		
						H \$1,541																		
						I \$1,725																		
						J \$1,946																		
						L1 \$1,446																		
						L2 \$1,578																		
		<table border="1"> <thead> <tr> <th data-bbox="836 367 1096 399">Upholstery</th> <th colspan="3" data-bbox="1096 367 1339 399">Shipping</th> </tr> </thead> <tbody> <tr> <td data-bbox="836 399 1096 430">COM Ydg</td> <td data-bbox="1096 399 1209 430">1 ¼</td> <td data-bbox="1209 399 1339 430">Ctn Wt</td> <td data-bbox="1339 399 1557 430">21</td> </tr> <tr> <td data-bbox="836 430 1096 462">COL Sq Ft</td> <td data-bbox="1096 430 1209 462">23</td> <td data-bbox="1209 430 1339 462">Cu Ft</td> <td data-bbox="1339 430 1557 462">11</td> </tr> </tbody> </table>				Upholstery	Shipping			COM Ydg	1 ¼	Ctn Wt	21	COL Sq Ft	23	Cu Ft	11							
Upholstery	Shipping																							
COM Ydg	1 ¼	Ctn Wt	21																					
COL Sq Ft	23	Cu Ft	11																					

KNOX

To Order, Specify:

- ① Model Number
- ② Fabric Selection - vendor, pattern and color
Visit www.jsifurniture.com/finishes-and-materials/textiles for our textiles program.
See selection of standard and graded in manufacturers and patterns.
- ③ Plastic Color or Wood Finish - See [Plastic Color or Wood Finish Options](#)
 - a. Plastic Back - standard
 - b. Maple Back - standard
 - c. Walnut Back - add \$30 list per back
 - d. Double Cut Back - add \$32 list per back
- ④ Handle Cut Out - add \$22 list per veneer back
- ⑦ Metal Frame Finish - See [Metal Frame Options](#)

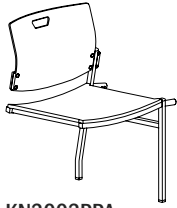
Description

Model

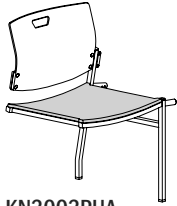
Specifications

List Price Per Grade

Armless Adder Module



KN3003PPA plastic seat



KN3003PUA uph. seat

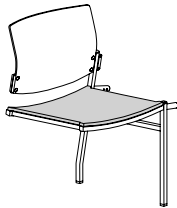
KN3003PPA - All Plastic
KN3003PUA - Seat Uph.

- connects to starter section and additional adder sections or an end section to a multiple seating run
- requires setup with other modules, instructions included
- connecting rods extend past leg, see page [KN8](#) for details
- wall saver

Dimensions	D	W	H
Overall	21 ¼	19 ¾	32
Seat	17 ¾	19	18 ½
Upholstery		Shipping	
COM Ydg	¾	Ctn Wt	11
COL Sq Ft	14	Cu Ft	10

All Plastic	\$470
COM	\$593
A	\$602
B	\$620
COL/C	\$650
D	\$691
E	\$730
F	\$793
G	\$858
H	\$930
I	\$1,040
J	\$1,173
L1	\$872
L2	\$951

Armless Adder Module - Wood Back/Upholstered Seat



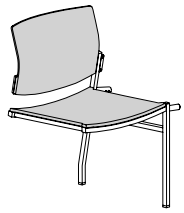
KN3003WUA

- connects to starter section and additional adder sections or an end section to a multiple seating run
- requires setup with other modules, instructions included
- connecting rods extend past leg, see page [KN8](#) for details
- standard maple veneer back available in maple finishes
- optional walnut veneer back available in walnut finishes; add \$30 list
- optional horizontal double cut; add \$32 list
- optional handle cut out; add \$22 list
- linking bracket available, order separately, see page [KN33](#)
- wall saver

Dimensions	D	W	H
Overall	21 ¼	19 ¾	32
Seat	17 ¾	19	18 ½
Upholstery		Shipping	
COM Ydg	¾	Ctn Wt	11
COL Sq Ft	14	Cu Ft	10

COM	\$815
A	\$825
B	\$842
COL/C	\$873
D	\$914
E	\$954
F	\$1,015
G	\$1,081
H	\$1,153
I	\$1,262
J	\$1,396
L1	\$1,094
L2	\$1,174

KNOX

Description	① Model	Specifications				List Price Per Grade	
Armless Adder Module - All Upholstered	KN3003UUA • connects to starter section and additional adder sections or an end section to a multiple seating run • requires setup with other modules, instructions included • connecting rods extend past leg, see page KN8 for details • wall saver	Dimensions			COM \$759		
		Overall	D 21 ¼	W 19 ¾	H 32	A \$773	
		Seat	17 ¾	19	18 ½	B \$802	
		Upholstery		Shipping		COL/C \$854	
		COM Ydg	1 ¼	Ctn Wt	12	D \$920	
		COL Sq Ft	23	Cu Ft	10	E \$988	
						F \$1,089	
						G \$1,201	
						H \$1,317	
						I \$1,501	
						J \$1,721	
						L1 \$1,222	
						L2 \$1,355	

KNOX

To Order, Specify:

- ① Model Number
- ② Fabric Selection - vendor, pattern and color
Visit www.jsifurniture.com/finishes-and-materials/textiles for our textiles program.
See selection of standard and graded in manufacturers and patterns.
- ③ Plastic Color or Wood Finish - See [Plastic Color or Wood Finish Options](#)
 - a. Plastic Back - standard
 - b. Maple Back - standard
 - c. Walnut Back - add \$30 list per back
 - d. Double Cut Back - add \$32 list per back
- ④ Handle Cut Out - add \$22 list per veneer back
- ⑦ Metal Frame Finish - See [Metal Frame Options](#)

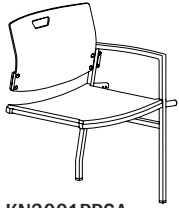
Description

Model

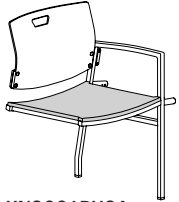
Specifications

List Price Per Grade

Arm Adder Module



KN3001PPSA plastic seat



KN3001PUSA uph. seat

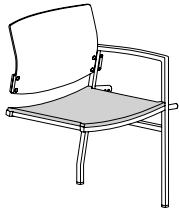
KN3001PPSA- All Plastic
KN3001PUSA - Seat Uph.

- connects to starter section and additional adder sections or an end section to a multiple seating run
- requires setup with other modules, instructions included
- connecting rods extend past leg, see page [KN8](#) for details
- maple wood trim arm caps available on standard nylon arms; add \$98 list
- wall saver

Dimensions	D	W	H
Overall	21 ¼	19 ¾	32
Seat	17 ¾	19	18 ½
Arm			26 ¾
Upholstery		Shipping	
COM Ydg	¾	Ctn Wt	12
COL Sq Ft	14	Cu Ft	10

All Plastic	\$518
COM	\$640
A	\$649
B	\$667
COL/C	\$697
D	\$738
E	\$777
F	\$840
G	\$906
H	\$976
I	\$1,086
J	\$1,218
L1	\$919
L2	\$998

Straight Arm Adder Module - Wood Back/Upholstered Seat



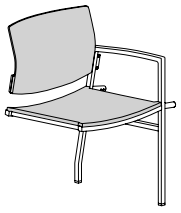
KN3001WUSA

- connects to starter section and additional adder sections or an end section to a multiple seating run
- requires setup with other modules, instructions included
- connecting rods extend past leg, see page [KN8](#) for details
- standard maple veneer back available in maple finishes
- optional walnut veneer back available in walnut finishes; add \$30 list
- optional horizontal double cut; add \$32 list
- optional handle cut out; add \$22 list
- maple wood trim arm caps available on standard nylon arms; add \$98 list
- wall saver

Dimensions	D	W	H
Overall	21 ¼	19 ¾	32
Seat	17 ¾	19	18 ½
Arm			26 ¾
Upholstery		Shipping	
COM Ydg	¾	Ctn Wt	13
COL Sq Ft	14	Cu Ft	10

COM	\$878
A	\$888
B	\$906
COL/C	\$936
D	\$976
E	\$1,016
F	\$1,079
G	\$1,143
H	\$1,215
I	\$1,326
J	\$1,458
L1	\$1,158
L2	\$1,237

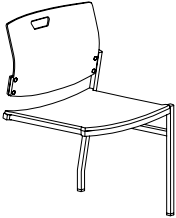
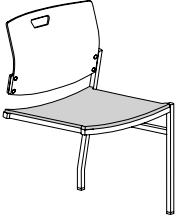
KNOX

Description	① Model	Specifications				List Price Per Grade	
Straight Arm Adder Module - All Upholstered 	KN3001UUSA <ul style="list-style-type: none"> • connects to starter section and additional adder sections or an end section to a multiple seating run • requires setup with other modules, instructions included • connecting rods extend past leg, see page KN8 for details • maple wood trim arm caps available on standard nylon arms; add \$98 list • multiple fabrics, see page KN5 • wall saver 	Dimensions				COM \$805	
		Overall	D 21 ¼	W 19 ¾	H 32	A \$823	
		Seat	17 ¾	19	18 ½	B \$850	
		Arm				COL/C \$902	
		Upholstery		Shipping		D \$968	
		COM Ydg	1 ¼	Ctn Wt	15	E \$1,036	
		COL Sq Ft	23	Cu Ft	10	F \$1,137	
						G \$1,249	
						H \$1,365	
						I \$1,549	
						J \$1,771	
						L1 \$1,270	
						L2 \$1,403	

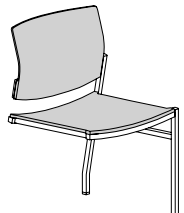
KNOX

To Order, Specify:

- ① Model Number
- ② Fabric Selection - vendor, pattern and color
Visit www.jsifurniture.com/finishes-and-materials/textiles for our textiles program.
See selection of standard and graded in manufacturers and patterns.
- ③ Plastic Color or Wood Finish - See [Plastic Color or Wood Finish Options](#)
 - a. Plastic Back - standard
 - b. Maple Back - standard
 - c. Walnut Back - add \$30 list per back
 - d. Double Cut Back - add \$32 list per back
- ④ Handle Cut Out - add \$22 list per veneer back
- ⑦ Metal Frame Finish - See [Metal Frame Options](#)

Description	Model	Specifications	List Price Per Grade																												
Armless Ender Module  KN3001PPE plastic seat	KN3003PPE - All Plastic KN3003PUE - Seat Uph. <ul style="list-style-type: none"> connect to a starter section or adder sections to end a multiple seating run requires setup with other modules, instructions included connecting rods extend past leg, see page KN8 for details wall saver 	<table border="1"> <thead> <tr> <th>Dimensions</th> <th>D</th> <th>W</th> <th>H</th> </tr> </thead> <tbody> <tr> <td>Overall</td> <td>21 ¼</td> <td>19 ¾</td> <td>32</td> </tr> <tr> <td>Seat</td> <td>17 ¾</td> <td>19</td> <td>18 ½</td> </tr> <tr> <th colspan="2">Upholstery</th> <th colspan="2">Shipping</th> </tr> <tr> <td>COM Ydg</td> <td>¾</td> <td>Ctn Wt</td> <td>11</td> </tr> <tr> <td>COL Sq Ft</td> <td>14</td> <td>Cu Ft</td> <td>10</td> </tr> </tbody> </table>	Dimensions	D	W	H	Overall	21 ¼	19 ¾	32	Seat	17 ¾	19	18 ½	Upholstery		Shipping		COM Ydg	¾	Ctn Wt	11	COL Sq Ft	14	Cu Ft	10	All Plastic \$449 COM \$570 A \$580 B \$597 COL/C \$628 D \$668 E \$708 F \$770 G \$836 H \$908 I \$1,016 J \$1,150 L1 \$849 L2 \$929				
		Dimensions	D	W	H																										
Overall	21 ¼	19 ¾	32																												
Seat	17 ¾	19	18 ½																												
Upholstery		Shipping																													
COM Ydg	¾	Ctn Wt	11																												
COL Sq Ft	14	Cu Ft	10																												
Armless Ender Module - Wood Back / Upholstered Seat  KN3001PUE uph. seat	KN3003WUE <ul style="list-style-type: none"> connect to a starter section or adder sections to end a multiple seating run requires setup with other modules, instructions included connecting rods extend past leg, see page KN8 for details standard maple veneer back available in maple finishes optional walnut veneer back available in walnut finishes; add \$30 list optional horizontal double cut; add \$32 list optional handle cut out; add \$22 list wall saver 	<table border="1"> <thead> <tr> <th>Dimensions</th> <th>D</th> <th>W</th> <th>H</th> </tr> </thead> <tbody> <tr> <td>Overall</td> <td>21 ¼</td> <td>19 ¾</td> <td>32</td> </tr> <tr> <td>Seat</td> <td>17 ¾</td> <td>19</td> <td>18 ½</td> </tr> <tr> <td>Arm</td> <td></td> <td></td> <td>n/a</td> </tr> <tr> <th colspan="2">Upholstery</th> <th colspan="2">Shipping</th> </tr> <tr> <td>COM Ydg</td> <td>¾</td> <td>Ctn Wt</td> <td>11</td> </tr> <tr> <td>COL Sq Ft</td> <td>14</td> <td>Cu Ft</td> <td>10</td> </tr> </tbody> </table>	Dimensions	D	W	H	Overall	21 ¼	19 ¾	32	Seat	17 ¾	19	18 ½	Arm			n/a	Upholstery		Shipping		COM Ydg	¾	Ctn Wt	11	COL Sq Ft	14	Cu Ft	10	COM \$808 A \$817 B \$835 COL/C \$866 D \$906 E \$946 F \$1,008 G \$1,073 H \$1,143 I \$1,254 J \$1,386 L1 \$1,086 L2 \$1,165
Dimensions	D	W	H																												
Overall	21 ¼	19 ¾	32																												
Seat	17 ¾	19	18 ½																												
Arm			n/a																												
Upholstery		Shipping																													
COM Ydg	¾	Ctn Wt	11																												
COL Sq Ft	14	Cu Ft	10																												

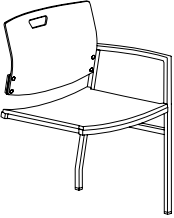
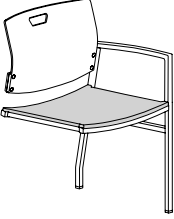
KNOX

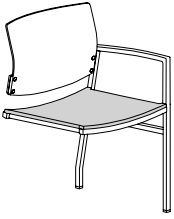
Description	① Model	Specifications				List Price Per Grade	
Armless Ender Module - All Upholstered	KN3003UUE • connect to a starter section or adder sections to end a multiple seating run • requires setup with other modules, instructions included • connecting rods extend past leg, see page KN8 for details • wall saver	Dimensions				COM \$715	
		Overall	21 ¼	19 ¾	32	A \$730	
		Seat	17 ¾	19	18 ½	B \$760	
		Upholstery		Shipping		COL/C \$812	
		COM Ydg	1 ¼	Ctn Wt	12	D \$877	
		COL Sq Ft	23	Cu Ft	10	E \$945	
						F \$1,046	
						G \$1,158	
						H \$1,275	
						I \$1,458	
						J \$1,678	
						L1 \$1,179	
						L2 \$1,311	

KNOX

To Order, Specify:

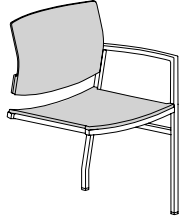
- ① Model Number
- ② Fabric Selection - vendor, pattern and color
 Visit www.jsifurniture.com/finishes-and-materials/textiles for our textiles program.
 See selection of standard and graded in manufacturers and patterns.
- ③ Plastic Color or Wood Finish - See [Plastic Color or Wood Finish Options](#)
 - a. Plastic Back - standard
 - b. Maple Back - standard
 - c. Walnut Back - add \$30 list per back
 - d. Double Cut Back - add \$32 list per back
- ④ Handle Cut Out - add \$22 list per veneer back
- ⑦ Metal Frame Finish - See [Metal Frame Options](#)

Description	Model	Specifications	List Price Per Grade																
Straight Arm Ender Module  KN3001PPSE plastic seat	KN3001PPSE - All Plastic KN3001PUSE - Seat Uph. <ul style="list-style-type: none"> connect to a starter section or adder sections to end a multiple seating run requires setup with other modules, instructions included connecting rods extend past leg, see page KN8 for details maple wood trim arm caps available on standard nylon arms; add \$98 list wall saver 	<table border="1"> <thead> <tr> <th>Dimensions</th> <th>D</th> <th>W</th> <th>H</th> </tr> </thead> <tbody> <tr> <td>Overall</td> <td>21 ¼</td> <td>19 ¾</td> <td>32</td> </tr> <tr> <td>Seat</td> <td>17 ¾</td> <td>19</td> <td>18 ½</td> </tr> <tr> <td>Arm</td> <td></td> <td></td> <td>26 ¾</td> </tr> </tbody> </table>	Dimensions	D	W	H	Overall	21 ¼	19 ¾	32	Seat	17 ¾	19	18 ½	Arm			26 ¾	All Plastic \$495 COM \$618 A \$627 B \$644 COL/C \$675 D \$715 E \$755 F \$817 G \$883 H \$954 I \$1,063 J \$1,197 L1 \$895 L2 \$974
		Dimensions	D	W	H														
Overall	21 ¼	19 ¾	32																
Seat	17 ¾	19	18 ½																
Arm			26 ¾																
<table border="1"> <thead> <tr> <th colspan="2">Upholstery</th> <th colspan="2">Shipping</th> </tr> </thead> <tbody> <tr> <td>COM Ydg</td> <td>¾</td> <td>Ctn Wt</td> <td>12</td> </tr> <tr> <td>COL Sq Ft</td> <td>14</td> <td>Cu Ft</td> <td>10</td> </tr> </tbody> </table>	Upholstery		Shipping		COM Ydg	¾	Ctn Wt	12	COL Sq Ft	14	Cu Ft	10							
Upholstery		Shipping																	
COM Ydg	¾	Ctn Wt	12																
COL Sq Ft	14	Cu Ft	10																
 KN3001PUSE uph. seat																			

Straight Arm Ender Module - Wood Back/Upholstered Seat 	KN3001WUSE <ul style="list-style-type: none"> connect to a starter section or adder sections to end a multiple seating run requires setup with other modules, instructions included connecting rods extend past leg, see page KN8 for details standard maple veneer back available in maple finishes optional walnut veneer back available in walnut finishes; add \$30 list optional horizontal double cut; add \$32 list optional handle cut out; add \$22 list maple wood trim arm caps available on standard nylon arms; add \$98 list wall saver 	<table border="1"> <thead> <tr> <th>Dimensions</th> <th>D</th> <th>W</th> <th>H</th> </tr> </thead> <tbody> <tr> <td>Overall</td> <td>21 ¼</td> <td>19 ¾</td> <td>32</td> </tr> <tr> <td>Seat</td> <td>17 ¾</td> <td>19</td> <td>18 ½</td> </tr> <tr> <td>Arm</td> <td></td> <td></td> <td>26 ¾</td> </tr> </tbody> </table>	Dimensions	D	W	H	Overall	21 ¼	19 ¾	32	Seat	17 ¾	19	18 ½	Arm			26 ¾	COM \$856 A \$866 B \$883 COL/C \$914 D \$954 E \$994 F \$1,056 G \$1,121 H \$1,192 I \$1,302 J \$1,434 L1 \$1,135 L2 \$1,213
		Dimensions	D	W	H														
Overall	21 ¼	19 ¾	32																
Seat	17 ¾	19	18 ½																
Arm			26 ¾																
<table border="1"> <thead> <tr> <th colspan="2">Upholstery</th> <th colspan="2">Shipping</th> </tr> </thead> <tbody> <tr> <td>COM Ydg</td> <td>¾</td> <td>Ctn Wt</td> <td>13</td> </tr> <tr> <td>COL Sq Ft</td> <td>14</td> <td>Cu Ft</td> <td>10</td> </tr> </tbody> </table>	Upholstery		Shipping		COM Ydg	¾	Ctn Wt	13	COL Sq Ft	14	Cu Ft	10							
Upholstery		Shipping																	
COM Ydg	¾	Ctn Wt	13																
COL Sq Ft	14	Cu Ft	10																

KNOX

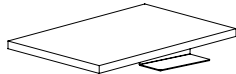
Description	① Model	Specifications				List Price Per Grade																																																						
Straight Arm Ender Module - All Upholstered	KN3001UUSE <ul style="list-style-type: none"> • connect to a starter section or adder sections to end a multiple seating run • requires setup with other modules, instructions included • connecting rods extend past leg, see page KN8 for details • maple wood trim arm caps available on standard nylon arms; add \$98 list • multiple fabrics, see page KN5 • wall saver 	<table border="1"> <thead> <tr> <th data-bbox="836 210 1088 241">Dimensions</th> <th data-bbox="1088 210 1161 241">D</th> <th data-bbox="1161 210 1242 241">W</th> <th data-bbox="1242 210 1339 241">H</th> </tr> </thead> <tbody> <tr> <td data-bbox="836 241 1088 283">Overall</td> <td data-bbox="1088 241 1161 283">21 ¼</td> <td data-bbox="1161 241 1242 283">19 ¾</td> <td data-bbox="1242 241 1339 283">32</td> </tr> <tr> <td data-bbox="836 283 1088 325">Seat</td> <td data-bbox="1088 283 1161 325">17 ¾</td> <td data-bbox="1161 283 1242 325">19</td> <td data-bbox="1242 283 1339 325">18 ½</td> </tr> <tr> <td data-bbox="836 325 1088 367">Arm</td> <td colspan="2" data-bbox="1088 325 1242 367"></td> <td data-bbox="1242 325 1339 367">26 ½</td> </tr> <tr> <th data-bbox="836 367 1088 409">Upholstery</th> <th colspan="3" data-bbox="1088 367 1339 409">Shipping</th> </tr> <tr> <td data-bbox="836 409 1088 451">COM Ydg</td> <td data-bbox="1088 409 1161 451">1 ¼</td> <td data-bbox="1161 409 1242 451">Ctn Wt</td> <td data-bbox="1242 409 1339 451">15</td> </tr> <tr> <td data-bbox="836 451 1088 483">COL Sq Ft</td> <td data-bbox="1088 451 1161 483">23</td> <td data-bbox="1161 451 1242 483">Cu Ft</td> <td data-bbox="1242 451 1339 483">10</td> </tr> </tbody> </table>				Dimensions	D	W	H	Overall	21 ¼	19 ¾	32	Seat	17 ¾	19	18 ½	Arm			26 ½	Upholstery	Shipping			COM Ydg	1 ¼	Ctn Wt	15	COL Sq Ft	23	Cu Ft	10	<table border="0"> <tr><td>COM</td><td>\$783</td></tr> <tr><td>A</td><td>\$798</td></tr> <tr><td>B</td><td>\$826</td></tr> <tr><td>COL/C</td><td>\$878</td></tr> <tr><td>D</td><td>\$945</td></tr> <tr><td>E</td><td>\$1,011</td></tr> <tr><td>F</td><td>\$1,113</td></tr> <tr><td>G</td><td>\$1,225</td></tr> <tr><td>H</td><td>\$1,340</td></tr> <tr><td>I</td><td>\$1,525</td></tr> <tr><td>J</td><td>\$1,746</td></tr> <tr><td>L1</td><td>\$1,247</td></tr> <tr><td>L2</td><td>\$1,379</td></tr> </table>	COM	\$783	A	\$798	B	\$826	COL/C	\$878	D	\$945	E	\$1,011	F	\$1,113	G	\$1,225	H	\$1,340	I	\$1,525	J	\$1,746	L1	\$1,247	L2	\$1,379
Dimensions	D	W	H																																																									
Overall	21 ¼	19 ¾	32																																																									
Seat	17 ¾	19	18 ½																																																									
Arm			26 ½																																																									
Upholstery	Shipping																																																											
COM Ydg	1 ¼	Ctn Wt	15																																																									
COL Sq Ft	23	Cu Ft	10																																																									
COM	\$783																																																											
A	\$798																																																											
B	\$826																																																											
COL/C	\$878																																																											
D	\$945																																																											
E	\$1,011																																																											
F	\$1,113																																																											
G	\$1,225																																																											
H	\$1,340																																																											
I	\$1,525																																																											
J	\$1,746																																																											
L1	\$1,247																																																											
L2	\$1,379																																																											



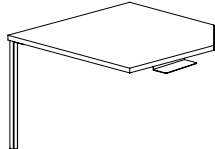
KNOX

To Order, Specify:

- ① Model Number
- ② Fabric Selection - vendor, pattern and color
Visit www.jsifurniture.com/finishes-and-materials/textiles for our textiles program.
See selection of standard and graded in manufacturers and patterns.
- ③ Plastic Color or Wood Finish - See [Plastic Color or Wood Finish Options](#)
 - a. Plastic Back - standard
 - b. Maple Back - standard
 - c. Walnut Back - add \$30 list per back
 - d. Double Cut Back - add \$32 list per back
- ④ Handle Cut Out - add \$22 list per veneer back
- ⑦ Metal Frame Finish - See [Metal Frame Options](#)

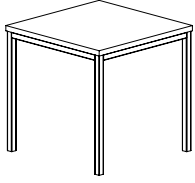
Description	D	W	H	CTN WT	CU FT	① Model	Laminate	Veneer
	18	12	3/4	6	1	KNI1218L	\$506	
	18	12	3/4	6	1	KNI1218V		\$759
	18	18	3/4	9	1	KNI1818L	\$528	
	18	18	3/4	9	1	KNI1818V		\$776

- attaches to multiple unit chair, armless guest or straight arm guest with bracket that wraps bottom of chair; brackets included
- 14 gauge 6" connector bracket
- specify bracket color arctic silver or matte black

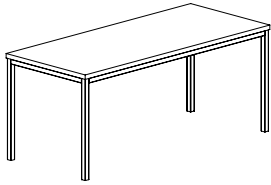
	26	26	3/4	12	1	KNC2626L	\$636	
	26	26	3/4	12	1	KNC2626V		\$884

- attaches to multiple unit chair, armless guest or straight arm guest with bracket that wraps bottom of chair; brackets included
- tubular corner leg 1 7/8" square 12 gauge with nylon tube glide
- 14 gauge 6" connector bracket

Description	D	W	H	CTN WT	CU FT	① Model	Laminate	Veneer
Side Table	18	18	18	15	5	KNF1818L	\$665	
	18	18	18	15	5	KNF1818V		\$913



Magazine Table	18	42	18	24	10	KNF1842L	\$810	
	18	42	18	24	10	KNF1842V		\$1,047



KNOX

To Order, Specify:

- ① Model Number
- ② Laminate or Wood Finish - [See Laminate or Wood Finish Options](#)
- ③ Metal Frame Finish - [See Metal Frame Options](#)

Description

Model

Specifications

List Price Per Grade

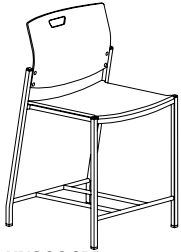
38³/₈"h Armless Counter Stool

KN3004PP - All Plastic
KN3004PU - Seat Uph.

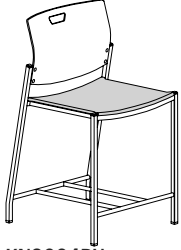
- foot rail for 5³/₄" high from floor
- wall saver

Dimensions	D	W	H
Overall	23 ³ / ₈	21 ¹ / ₄	38 ³ / ₈
Seat	17 ³ / ₈	19	24 ¹ / ₂
Upholstery		Shipping	
COM Ydg	³ / ₄	Ctn Wt	24
COL Sq Ft	14	Cu Ft	15

All Plastic	\$755
COM	\$898
A	\$909
B	\$925
COL/C	\$957
D	\$996
E	\$1,037
F	\$1,098
G	\$1,164
H	\$1,236
I	\$1,345
J	\$1,478
L1	\$1,178
L2	\$1,257



KN3004PP
plastic seat



KN3004PU
uph. seat

KNOX

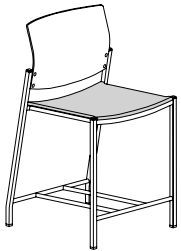
38³/₈"h Armless Counter Stool -
Wood Back/Upholstered Seat

KN3004WU

- foot rail for 5³/₄" high from floor
- standard maple veneer back available in maple finishes
- optional walnut veneer back available in walnut finishes; add \$30 list
- optional horizontal double cut; add \$32 list
- optional handle cut out; add \$22 list
- wall saver

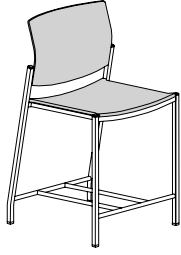
Dimensions	D	W	H
Overall	23 ³ / ₈	21 ¹ / ₄	38 ³ / ₈
Seat	17 ³ / ₈	19	24 ¹ / ₂
Upholstery		Shipping	
COM Ydg	³ / ₄	Ctn Wt	25
COL Sq Ft	14	Cu Ft	15

COM	\$1,121
A	\$1,131
B	\$1,148
COL/C	\$1,179
D	\$1,218
E	\$1,259
F	\$1,322
G	\$1,386
H	\$1,458
I	\$1,568
J	\$1,700
L1	\$1,401
L2	\$1,480



Description

38 3/8" h Armless Counter Stool -
All Upholstered



① Model

KN3004UU

- foot rail for 5 3/4" high from floor
- multiple fabrics, see page [KN5](#)
- wall saver

Specifications

Dimensions	D	W	H
Overall	23 3/8	21 1/4	38 3/8
Seat	17 3/8	19	24 1/2
Upholstery		Shipping	
COM Ydg	1 1/4	Ctn Wt	26
COL Sq Ft	23	Cu Ft	15

List Price Per Grade

COM	\$1,037
A	\$1,053
B	\$1,081
COL/C	\$1,133
D	\$1,200
E	\$1,265
F	\$1,369
G	\$1,480
H	\$1,596
I	\$1,779
J	\$2,001
L1	\$1,501
L2	\$1,633

To Order, Specify:

- ① Model Number
- ② Fabric Selection - vendor, pattern and color
Visit www.jsifurniture.com/finishes-and-materials/textiles for our textiles program.
See selection of standard and graded in manufacturers and patterns.
- ③ Plastic Color or Wood Finish - See [Plastic Color or Wood Finish Options](#)
 - a. Plastic Back - standard
 - b. Maple Back - standard
 - c. Walnut Back - add \$30 list per back
 - d. Double Cut Back - add \$32 list per back
- ④ Handle Cut Out - add \$22 list per veneer back
- ⑦ Metal Frame Finish - See [Metal Frame Options](#)

Description

Model

Specifications

List Price Per Grade

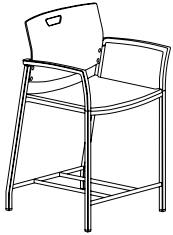
38³/₈"h Flared Arm Counter Stool

KN3004PPF - All Plastic
KN3004PUF - Seat Uph.

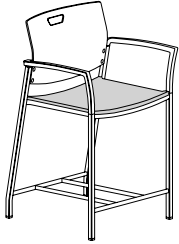
- foot rail for 5³/₄" high from floor
- maple wood trim arm caps available on standard nylon arms; add \$195 list
- wall saver

Dimensions	D	W	H
Overall	23 ³ / ₈	24 ¹ / ₈	38 ³ / ₈
Seat	17 ³ / ₈	21 ¹ / ₂	24 ¹ / ₂
Arm			32 ⁵ / ₈
Upholstery		Shipping	
COM Ydg	¾	Ctn Wt	25
COL Sq Ft	14	Cu Ft	17

All Plastic	\$845
COM	\$999
A	\$1,009
B	\$1,027
COL/C	\$1,057
D	\$1,096
E	\$1,137
F	\$1,200
G	\$1,264
H	\$1,335
I	\$1,446
J	\$1,578
L1	\$1,279
L2	\$1,358



KN3004PPF
plastic seat



KN3004PUF
uph. seat

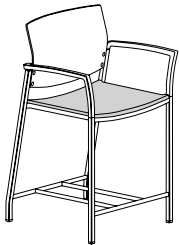
38³/₈"h Flared Arm Counter Stool -
Wood Back/Upholstered Seat

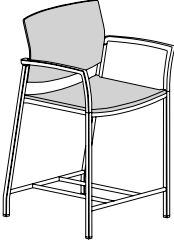
KN3004WUF

- foot rail for 5³/₄" high from floor
- standard maple veneer back available in maple finishes
- optional walnut veneer back available in walnut finishes; add \$30 list
- optional horizontal double cut; add \$32 list
- optional handle cut out; add \$22 list
- maple wood trim arm caps available on standard nylon arms; add \$195 list
- wall saver

Dimensions	D	W	H
Overall	23 ³ / ₈	24 ¹ / ₈	38 ³ / ₈
Seat	17 ³ / ₈	21 ¹ / ₂	24 ¹ / ₂
Arm			32 ⁵ / ₈
Upholstery		Shipping	
COM Ydg	¾	Ctn Wt	26
COL Sq Ft	14	Cu Ft	17

COM	\$1,217
A	\$1,227
B	\$1,244
COL/C	\$1,276
D	\$1,316
E	\$1,356
F	\$1,418
G	\$1,483
H	\$1,554
I	\$1,665
J	\$1,797
L1	\$1,497
L2	\$1,576



Description	① Model	Specifications				List Price Per Grade	
38³/₈"h Flared Arm Counter Stool - All Upholstered 	KN3004UUF · foot rail for 5 ³ / ₄ " high from floor · maple wood trim arm caps available on standard nylon arms; add \$195 list · multiple fabrics, see page KN5 · wall saver	Dimensions		D	W	H	COM \$1,132
		Overall	23 ³ / ₈	24 ¹ / ₈	38 ³ / ₈	A \$1,148	
		Seat	17 ³ / ₈	21 ¹ / ₂	24 ¹ / ₂	B \$1,176	COL/C \$1,228
		Arm			32 ⁵ / ₈	D \$1,295	
		Upholstery		Shipping		E \$1,361	
		COM Ydg	1 ¹ / ₄	Ctn Wt	27	F \$1,462	
		COL Sq Ft	23	Cu Ft	17	G \$1,575	
						H \$1,692	
						I \$1,874	
						J \$2,096	
						L1 \$1,596	
						L2 \$1,729	

KNOX

To Order, Specify:

- ① Model Number
- ② Fabric Selection - vendor, pattern and color
 Visit www.jsifurniture.com/finishes-and-materials/textiles for our textiles program.
 See selection of standard and graded in manufacturers and patterns.
- ③ Plastic Color or Wood Finish - See [Plastic Color or Wood Finish Options](#)
 - a. Plastic Back - standard
 - b. Maple Back - standard
 - c. Walnut Back - add \$30 list per back
 - d. Double Cut Back - add \$32 list per back
- ④ Handle Cut Out - add \$22 list per veneer back
- ⑦ Metal Frame Finish - See [Metal Frame Options](#)

Description

Model

Specifications

List Price Per Grade

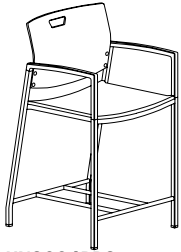
38³/₈"h Straight Arm Counter Stool

KN3004PPS
KN3004PUS

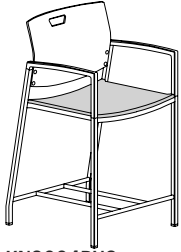
- foot rail for 5³/₄" high from floor
- maple wood trim arm caps available on standard nylon arms; add \$195 list
- wall saver

Dimensions	D	W	H
Overall	23 ³ / ₈	21 ¹ / ₄	38 ³ / ₈
Seat	17 ³ / ₈	21 ¹ / ₂	24 ¹ / ₂
Arm			32 ⁵ / ₈
Shipping			
	Ctn Wt	24	
	Cu Ft	15	

All Plastic	\$849
COM	\$998
A	\$1,008
B	\$1,024
COL/C	\$1,056
D	\$1,095
E	\$1,136
F	\$1,199
G	\$1,263
H	\$1,334
I	\$1,445
J	\$1,577
L1	\$1,277
L2	\$1,356



KN3004PPS
plastic seat



KN3004PUS
uph. seat

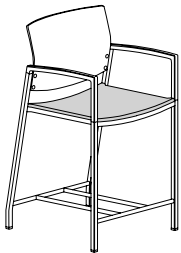
38³/₈"h Straight Arm Counter Stool - Wood Back Seat/Upholstered Seat

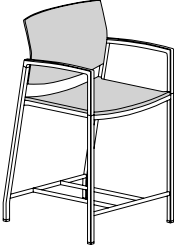
KN3004WUS

- foot rail for 5³/₄" high from floor
- standard maple veneer back available in maple finishes
- optional walnut veneer back available in walnut finishes; add \$30 list
- optional horizontal double cut; add \$32 list
- optional handle cut out; add \$22 list
- maple wood trim arm caps available on standard nylon arms; add \$195 list
- wall saver

Dimensions	D	W	H
Overall	23 ³ / ₈	21 ¹ / ₄	38 ³ / ₈
Seat	17 ³ / ₈	19 ³ / ₈	24 ¹ / ₂
Arm			32 ⁵ / ₈
Upholstery		Shipping	
COM Ydg	³ / ₄	Ctn Wt	26
COL Sq Ft	14	Cu Ft	15

COM	\$1,215
A	\$1,225
B	\$1,242
COL/C	\$1,274
D	\$1,312
E	\$1,353
F	\$1,414
G	\$1,481
H	\$1,551
I	\$1,662
J	\$1,794
L1	\$1,494
L2	\$1,573

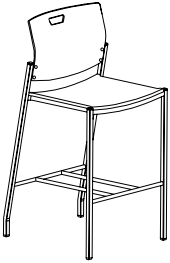
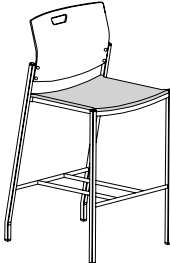


Description	① Model	Specifications				List Price Per Grade	
38³/₈"h Straight Arm Counter Stool - All Upholstered 	KN3004UUS · foot rail for 5 ³ / ₄ " high from floor · maple wood trim arm caps available on standard nylon arms; add \$195 list · multiple fabrics, see page KN5 · wall saver	Dimensions		D	W	H	COM \$1,130
		Overall	23 ³ / ₈	21 ¹ / ₄	38 ³ / ₈	A \$1,144	
		Seat	17 ³ / ₈	19 ³ / ₈	24 ¹ / ₂	B \$1,174	COL/C \$1,226
		Arm			32 ⁵ / ₈	D \$1,291	E \$1,359
		Upholstery		Shipping		F \$1,460	G \$1,572
		COM Ydg	1 ¹ / ₄	Ctn Wt	27	H \$1,689	I \$1,872
		COL Sq Ft	23	Cu Ft	15	J \$2,094	L1 \$1,593
						L2 \$1,726	

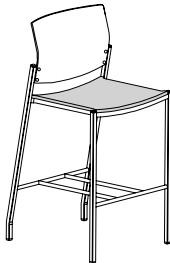
KNOX

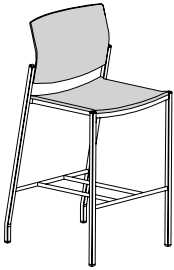
To Order, Specify:

- ① Model Number
- ② Fabric Selection - vendor, pattern and color
 Visit www.jsifurniture.com/finishes-and-materials/textiles for our textiles program.
 See selection of standard and graded in manufacturers and patterns.
- ③ Plastic Color or Wood Finish - See [Plastic Color or Wood Finish Options](#)
 - a. Plastic Back - standard
 - b. Maple Back - standard
 - c. Walnut Back - add \$30 list per back
 - d. Double Cut Back - add \$32 list per back
- ④ Handle Cut Out - add \$22 list per veneer back
- ⑦ Metal Frame Finish - See [Metal Frame Options](#)

Description	Model	Specifications	List Price Per Grade												
44 ³ / ₈ "h Armless Bar Stool	KN3008PP - All Plastic KN3008PU - Seat Uph. · foot rail for 11 ³ / ₄ " high from floor · wall saver	<table border="1"> <thead> <tr> <th>Dimensions</th> <th>D</th> <th>W</th> <th>H</th> </tr> </thead> <tbody> <tr> <td>Overall</td> <td>23³/₄</td> <td>21¹/₄</td> <td>44³/₈</td> </tr> <tr> <td>Seat</td> <td>17³/₈</td> <td>19</td> <td>30¹/₂</td> </tr> </tbody> </table>	Dimensions	D	W	H	Overall	23 ³ / ₄	21 ¹ / ₄	44 ³ / ₈	Seat	17 ³ / ₈	19	30 ¹ / ₂	All Plastic \$835 COM \$979 A \$989 B \$1,006 COL/C \$1,037 D \$1,078 E \$1,117 F \$1,179 G \$1,244 H \$1,316 I \$1,426 J \$1,557 L1 \$1,258 L2 \$1,337
		Dimensions	D	W	H										
Overall	23 ³ / ₄	21 ¹ / ₄	44 ³ / ₈												
Seat	17 ³ / ₈	19	30 ¹ / ₂												
<table border="1"> <thead> <tr> <th>Upholstery</th> <th colspan="3">Shipping</th> </tr> </thead> <tbody> <tr> <td>COM Ydg</td> <td>³/₄</td> <td>Ctn Wt</td> <td>26</td> </tr> <tr> <td>COL Sq Ft</td> <td>14</td> <td>Cu Ft</td> <td>16</td> </tr> </tbody> </table>	Upholstery	Shipping			COM Ydg	³ / ₄	Ctn Wt	26	COL Sq Ft	14	Cu Ft	16			
Upholstery	Shipping														
COM Ydg	³ / ₄	Ctn Wt	26												
COL Sq Ft	14	Cu Ft	16												
 <p>KN3008PP plastic seat</p>															
 <p>KN3008PU uph. seat</p>															

KNOX

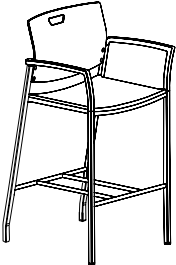
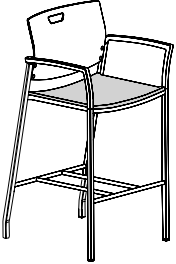
44 ³ / ₈ "h Armless Bar Stool - Wood Back/Upholstered Seat	KN3008WU · foot rail for 11 ³ / ₄ " high from floor · standard maple veneer back available in maple finishes · optional walnut veneer back available in walnut finishes; add \$30 list · optional horizontal double cut; add \$32 list · optional handle cut out; add \$22 list · wall saver	<table border="1"> <thead> <tr> <th>Dimensions</th> <th>D</th> <th>W</th> <th>H</th> </tr> </thead> <tbody> <tr> <td>Overall</td> <td>23³/₄</td> <td>21¹/₄</td> <td>44³/₈</td> </tr> <tr> <td>Seat</td> <td>17³/₈</td> <td>19</td> <td>30¹/₂</td> </tr> </tbody> </table>	Dimensions	D	W	H	Overall	23 ³ / ₄	21 ¹ / ₄	44 ³ / ₈	Seat	17 ³ / ₈	19	30 ¹ / ₂	COM \$1,195 A \$1,205 B \$1,222 COL/C \$1,253 D \$1,292 E \$1,333 F \$1,396 G \$1,460 H \$1,531 I \$1,642 J \$1,774 L1 \$1,474 L2 \$1,553
Dimensions	D	W	H												
Overall	23 ³ / ₄	21 ¹ / ₄	44 ³ / ₈												
Seat	17 ³ / ₈	19	30 ¹ / ₂												
		<table border="1"> <thead> <tr> <th>Upholstery</th> <th colspan="3">Shipping</th> </tr> </thead> <tbody> <tr> <td>COM Ydg</td> <td>³/₄</td> <td>Ctn Wt</td> <td>27</td> </tr> <tr> <td>COL Sq Ft</td> <td>14</td> <td>Cu Ft</td> <td>16</td> </tr> </tbody> </table>	Upholstery	Shipping			COM Ydg	³ / ₄	Ctn Wt	27	COL Sq Ft	14	Cu Ft	16	
Upholstery	Shipping														
COM Ydg	³ / ₄	Ctn Wt	27												
COL Sq Ft	14	Cu Ft	16												

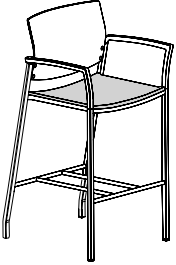
Description	① Model	Specifications				List Price Per Grade	
44 ³ / ₈ "h Armless Bar Stool - All Upholstered 	KN3008UU · foot rail for 11 ³ / ₄ " high from floor · multiple fabrics, see page KN5 · wall saver	Dimensions		D	W	H	COM \$1,121
		Overall	23 ³ / ₄	21 ¹ / ₄	44 ³ / ₈	A \$1,137	
		Seat	17 ³ / ₈	19	30 ¹ / ₂	B \$1,165	
		Upholstery		Shipping		COL/C \$1,217	
		COM Ydg	1 ¹ / ₄	Ctn Wt	27	D \$1,284	
		COL Sq Ft	23	Cu Ft	16	E \$1,350	
						F \$1,453	
						G \$1,565	
						H \$1,680	
						I \$1,864	
						J \$2,085	
						L1 \$1,585	
						L2 \$1,718	

KNOX

To Order, Specify:

- ① Model Number
- ② Fabric Selection - vendor, pattern and color
 Visit www.jsifurniture.com/finishes-and-materials/textiles for our textiles program.
 See selection of standard and graded in manufacturers and patterns.
- ③ Plastic Color or Wood Finish - See [Plastic Color or Wood Finish Options](#)
 - a. Plastic Back - standard
 - b. Maple Back - standard
 - c. Walnut Back - add \$30 list per back
 - d. Double Cut Back - add \$32 list per back
- ④ Handle Cut Out - add \$22 list per veneer back
- ⑦ Metal Frame Finish - See [Metal Frame Options](#)

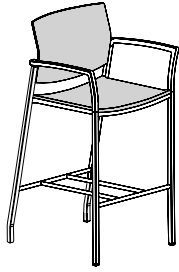
Description	Model	Specifications				List Price Per Grade	
44 ³ / ₈ "h Flared Arm Bar Stool	KN3008PPF - All Plastic KN3008PUF - Seat Uph. <ul style="list-style-type: none"> · foot rail for 11³/₄" high from floor · maple wood trim arm caps available on standard nylon arms; add \$195 list · wall saver 	Dimensions	D	W	H	All Plastic	\$936
		Overall	23 ³ / ₄	24 ¹ / ₈	44 ³ / ₈	COM	\$1,078
	KN3008PPF plastic seat	Seat	17 ³ / ₈	21 ¹ / ₂	30 ¹ / ₂	A	\$1,086
		Arm			38 ⁵ / ₈	B	\$1,104
	KN3008PUF uph. seat	Upholstery	Shipping			COL/C	\$1,135
		COM Ydg	³ / ₄	Ctn Wt	25	D	\$1,175
		COL Sq Ft	14	Cu Ft	18	E	\$1,215
						F	\$1,277
						G	\$1,342
						H	\$1,413
						I	\$1,524
						J	\$1,656
						L1	\$1,356
						L2	\$1,434

44 ³ / ₈ "h Flared Arm Bar Stool - Wood Back/Upholstered Seat	KN3008WUF <ul style="list-style-type: none"> · foot rail for 11³/₄" high from floor · standard maple veneer back available in maple finishes · optional walnut veneer back available in walnut finishes; add \$30 list · optional horizontal double cut; add \$32 list · optional handle cut out; add \$22 list · maple wood trim arm caps available on standard nylon arms; add \$195 list · wall saver 	Dimensions	D	W	H	COM	\$1,295
		Overall	23 ³ / ₄	24 ¹ / ₈	44 ³ / ₈	A	\$1,303
		Seat	17 ³ / ₈	21 ¹ / ₂	30 ¹ / ₂	B	\$1,322
		Arm			38 ⁵ / ₈	COL/C	\$1,352
		Upholstery	Shipping			D	\$1,392
		COM Ydg	³ / ₄	Ctn Wt	25	E	\$1,432
		COL Sq Ft	14	Cu Ft	18	F	\$1,494
						G	\$1,560
						H	\$1,630
						I	\$1,741
						J	\$1,873
						L1	\$1,573
						L2	\$1,652

KNOX

Description

44³/₈"h Flared Arm Bar Stool -
All Upholstered



① Model

KN3008UUF

- foot rail for 11³/₄" high from floor
- maple wood trim arm caps
available on standard nylon arms;
add \$195 list
- multiple fabrics, see page [KN5](#)
- wall saver

Specifications

Dimensions	D	W	H
Overall	23 ³ / ₄	24 ¹ / ₈	44 ³ / ₈
Seat	17 ³ / ₈	21 ¹ / ₂	30 ¹ / ₂
Arm			38 ⁵ / ₈
Upholstery		Shipping	
COM Ydg	1 ¹ / ₄	Ctn Wt	27
COL Sq Ft	23	Cu Ft	18

List Price Per Grade

COM	\$1,208
A	\$1,225
B	\$1,253
COL/C	\$1,305
D	\$1,371
E	\$1,438
F	\$1,540
G	\$1,651
H	\$1,768
I	\$1,951
J	\$2,173
L1	\$1,672
L2	\$1,804

KNOX

To Order, Specify:

- ① Model Number
- ② Fabric Selection - vendor, pattern and color
Visit www.jsifurniture.com/finishes-and-materials/textiles for our textiles program.
See selection of standard and graded in manufacturers and patterns.
- ③ Plastic Color or Wood Finish - See [Plastic Color or Wood Finish Options](#)
 - a. Plastic Back - standard
 - b. Maple Back - standard
 - c. Walnut Back - add \$30 list per back
 - d. Double Cut Back - add \$32 list per back
- ④ Handle Cut Out - add \$22 list per veneer back
- ⑦ Metal Frame Finish - See [Metal Frame Options](#)

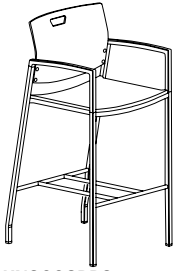
Description

Model

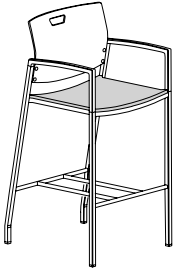
Specifications

List Price Per Grade

44³/₈"h Arm Bar Stool



KN3008PPS
plastic seat



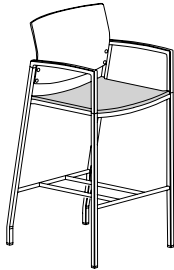
KN3008PUS
uph. seat

- KN3008PPS - All Plastic**
KN3008PUS - Seat Uph.
- foot rail for 11³/₄" high from floor
 - maple wood trim arm caps available on standard nylon arms; add \$195 list
 - wall saver

Dimensions	D	W	H
Overall	23 ³ / ₄	21 ¹ / ₄	44 ³ / ₈
Seat	17 ³ / ₈	19 ³ / ₈	30 ¹ / ₂
Arm			38 ⁵ / ₈
Upholstery		Shipping	
COM Ydg	³ / ₄	Ctn Wt	26
COL Sq Ft	14	Cu Ft	16

All Plastic	\$934
COM	\$1,074
A	\$1,084
B	\$1,101
COL/C	\$1,132
D	\$1,173
E	\$1,212
F	\$1,275
G	\$1,339
H	\$1,411
I	\$1,522
J	\$1,653
L1	\$1,353
L2	\$1,432

44³/₈"h Straight Arm Bar Stool -
Wood Back /Upholstered Seat



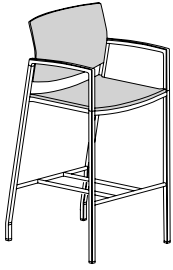
- KN3008WUS**
- foot rail for 11³/₄" high from floor
 - standard maple veneer back available in maple finishes
 - optional walnut veneer back available in walnut finishes; add \$30 list
 - optional horizontal double cut; add \$32 list
 - optional handle cut out; add \$22 list
 - maple wood trim arm caps available on standard nylon arms; add \$195 list
 - wall saver

Dimensions	D	W	H
Overall	23 ³ / ₄	21 ¹ / ₄	44 ³ / ₈
Seat	17 ³ / ₈	19 ³ / ₈	30 ¹ / ₂
Arm			38 ⁵ / ₈
Upholstery		Shipping	
COM Ydg	³ / ₄	Ctn Wt	27
COL Sq Ft	14	Cu Ft	16

COM	\$1,292
A	\$1,302
B	\$1,321
COL/C	\$1,350
D	\$1,390
E	\$1,430
F	\$1,493
G	\$1,557
H	\$1,629
I	\$1,740
J	\$1,872
L1	\$1,572
L2	\$1,651

Description

44³/₈"h Straight Arm Bar Stool - All Upholstered



① Model

KN3008UUS

- foot rail for 11³/₄" high from floor
- maple wood trim arm caps available on standard nylon arms; add \$195 list
- multiple fabrics, see page [KN5](#)
- wall saver

Specifications

Dimensions	D	W	H
Overall	23 ³ / ₄	21 ¹ / ₄	44 ³ / ₈
Seat	17 ³ / ₈	19 ³ / ₈	30 ¹ / ₂
Arm			38 ⁵ / ₈
Upholstery		Shipping	
COM Ydg	1 ¹ / ₄	Ctn Wt	28
COL Sq Ft	23	Cu Ft	16

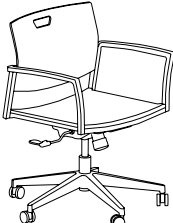

List Price Per Grade


COM	\$1,207
A	\$1,223
B	\$1,252
COL/C	\$1,303
D	\$1,370
E	\$1,435
F	\$1,539
G	\$1,650
H	\$1,767
I	\$1,949
J	\$2,170
L1	\$1,671
L2	\$1,803

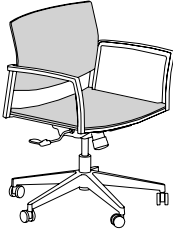
KNOX

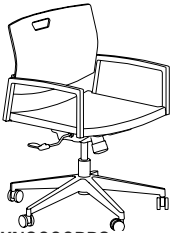

To Order, Specify:

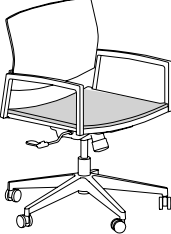
- ① Model Number
- ② Fabric Selection - vendor, pattern and color
Visit www.jsifurniture.com/finishes-and-materials/textiles for our textiles program.
See selection of standard and graded in manufacturers and patterns.
- ③ Plastic Color or Wood Finish - See [Plastic Color or Wood Finish Options](#)
 - a. Plastic Back - standard
 - b. Maple Back - standard
 - c. Walnut Back - add \$30 list per back
 - d. Double Cut Back - add \$32 list per back
- ④ Handle Cut Out - add \$22 list per veneer back
- ⑦ Metal Frame Finish - See [Metal Frame Options](#)

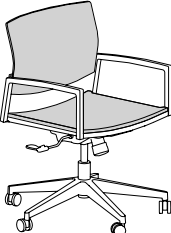
Description	Model	Specifications	List Price Per Grade																
Flared Arm Swivel Chair  KN3000PPF plastic seat	KN3000PPF - All Plastic KN3000PUF - Seat Uph. <ul style="list-style-type: none"> standard black nylon base with hard tread dual casters polished aluminum base; add \$103 list maple wood trim arm caps available on standard nylon arms; add \$195 list overall height range 31 1/2" - 36 3/4" seat height range 16 1/2" - 22 1/4" arm height range 30 3/8" - 24 5/8" 	<table border="1"> <thead> <tr> <th>Dimensions</th> <th>D</th> <th>W</th> <th>H</th> </tr> </thead> <tbody> <tr> <td>Overall</td> <td>28 1/2</td> <td>28 1/2</td> <td>36 3/4</td> </tr> <tr> <td>Seat</td> <td>17 3/8</td> <td>21 1/2</td> <td>22 1/4</td> </tr> <tr> <td>Arm</td> <td></td> <td></td> <td>30 3/8</td> </tr> </tbody> </table>	Dimensions	D	W	H	Overall	28 1/2	28 1/2	36 3/4	Seat	17 3/8	21 1/2	22 1/4	Arm			30 3/8	All Plastic \$841 COM \$989 A \$998 B \$1,015 COL/C \$1,046 D \$1,086 E \$1,127 F \$1,188 G \$1,254 H \$1,326 I \$1,434 J \$1,568 L1 \$1,267 L2 \$1,347
		Dimensions	D	W	H														
Overall	28 1/2	28 1/2	36 3/4																
Seat	17 3/8	21 1/2	22 1/4																
Arm			30 3/8																
<table border="1"> <thead> <tr> <th>Upholstery</th> <th colspan="3">Shipping</th> </tr> </thead> <tbody> <tr> <td>COM Ydg</td> <td>3/4</td> <td>Ctn Wt</td> <td>30</td> </tr> <tr> <td>COL Sq Ft</td> <td>14</td> <td>Cu Ft</td> <td>20</td> </tr> </tbody> </table>	Upholstery	Shipping			COM Ydg	3/4	Ctn Wt	30	COL Sq Ft	14	Cu Ft	20							
Upholstery	Shipping																		
COM Ydg	3/4	Ctn Wt	30																
COL Sq Ft	14	Cu Ft	20																
 KN3000PUF uph. seat																			

Flared Arm Swivel Chair - Wood Back/Upholstered Seat 	KN3000WUF <ul style="list-style-type: none"> standard black nylon base with hard tread dual casters polished aluminum base; add \$103 list standard maple veneer back available in maple finishes optional walnut veneer back available in walnut finishes; add \$30 list optional horizontal double cut; add \$32 list optional handle cut out; add \$22 list maple wood trim arm caps available on standard nylon arms; add \$195 list overall height range 31 1/2" - 36 3/4" seat height range 16 1/2" - 22 1/4" arm height range 30 3/8" - 24 5/8" 	<table border="1"> <thead> <tr> <th>Dimensions</th> <th>D</th> <th>W</th> <th>H</th> </tr> </thead> <tbody> <tr> <td>Overall</td> <td>28 1/2</td> <td>28 1/2</td> <td>36 3/4</td> </tr> <tr> <td>Seat</td> <td>17 3/8</td> <td>21 1/2</td> <td>22 1/4</td> </tr> <tr> <td>Arm</td> <td></td> <td></td> <td>30 3/8</td> </tr> </tbody> </table>	Dimensions	D	W	H	Overall	28 1/2	28 1/2	36 3/4	Seat	17 3/8	21 1/2	22 1/4	Arm			30 3/8	COM \$1,206 A \$1,215 B \$1,233 COL/C \$1,263 D \$1,303 E \$1,344 F \$1,406 G \$1,471 H \$1,543 I \$1,652 J \$1,785 L1 \$1,485 L2 \$1,565
		Dimensions	D	W	H														
Overall	28 1/2	28 1/2	36 3/4																
Seat	17 3/8	21 1/2	22 1/4																
Arm			30 3/8																
<table border="1"> <thead> <tr> <th>Upholstery</th> <th colspan="3">Shipping</th> </tr> </thead> <tbody> <tr> <td>COM Ydg</td> <td>3/4</td> <td>Ctn Wt</td> <td>30</td> </tr> <tr> <td>COL Sq Ft</td> <td>14</td> <td>Cu Ft</td> <td>20</td> </tr> </tbody> </table>	Upholstery	Shipping			COM Ydg	3/4	Ctn Wt	30	COL Sq Ft	14	Cu Ft	20							
Upholstery	Shipping																		
COM Ydg	3/4	Ctn Wt	30																
COL Sq Ft	14	Cu Ft	20																

Flared Arm Swivel Chair - All Upholstered. 	KN3000UUF <ul style="list-style-type: none"> standard black nylon base with hard tread dual casters polished aluminum base; add \$103 list maple wood trim arm caps available on standard nylon arms; add \$195 list multiple fabrics, see page KN5 overall height range 31 1/2" - 36 3/4" seat height range 16 1/2" - 22 1/4" arm height range 30 3/8" - 24 5/8" 	<table border="1"> <thead> <tr> <th>Dimensions</th> <th>D</th> <th>W</th> <th>H</th> </tr> </thead> <tbody> <tr> <td>Overall</td> <td>58 1/2</td> <td>28 1/2</td> <td>36 3/4</td> </tr> <tr> <td>Seat</td> <td>17 3/8</td> <td>21 1/2</td> <td>22 1/4</td> </tr> <tr> <td>Arm</td> <td></td> <td></td> <td>30 3/8</td> </tr> </tbody> </table>	Dimensions	D	W	H	Overall	58 1/2	28 1/2	36 3/4	Seat	17 3/8	21 1/2	22 1/4	Arm			30 3/8	COM \$1,132 A \$1,148 B \$1,176 COL/C \$1,228 D \$1,295 E \$1,361 F \$1,462 G \$1,575 H \$1,692 I \$1,874 J \$2,096 L1 \$1,596 L2 \$1,729
		Dimensions	D	W	H														
Overall	58 1/2	28 1/2	36 3/4																
Seat	17 3/8	21 1/2	22 1/4																
Arm			30 3/8																
<table border="1"> <thead> <tr> <th>Upholstery</th> <th colspan="3">Shipping</th> </tr> </thead> <tbody> <tr> <td>COM Ydg</td> <td>1 1/4</td> <td>Ctn Wt</td> <td>31</td> </tr> <tr> <td>COL Sq Ft</td> <td>23</td> <td>Cu Ft</td> <td>20</td> </tr> </tbody> </table>	Upholstery	Shipping			COM Ydg	1 1/4	Ctn Wt	31	COL Sq Ft	23	Cu Ft	20							
Upholstery	Shipping																		
COM Ydg	1 1/4	Ctn Wt	31																
COL Sq Ft	23	Cu Ft	20																

Description	Model	Specifications	List Price Per Grade																									
Straight Arm Swivel Chair  KN3000PPS plastic seat  KN3000PUS uph. seat	KN3000PPS - All Plastic KN3000PUS - Seat Uph. <ul style="list-style-type: none"> standard black nylon base with hard tread dual casters polished aluminum base; add \$103 list maple wood trim arm caps available on standard nylon arms; add \$195 list overall height range 31 1/2" - 36 3/4" seat height range 16 1/2" - 22 1/4" arm height range 30 3/8" - 24 5/8" 	<table border="1"> <thead> <tr> <th>Dimensions</th> <th>D</th> <th>W</th> <th>H</th> </tr> </thead> <tbody> <tr> <td>Overall</td> <td>28 1/2</td> <td>28 1/2</td> <td>36 3/4</td> </tr> <tr> <td>Seat</td> <td>17 3/8</td> <td>19 3/8</td> <td>22 1/4</td> </tr> <tr> <td>Arm</td> <td></td> <td></td> <td>30 3/8</td> </tr> </tbody> </table> <table border="1"> <thead> <tr> <th>Upholstery</th> <th colspan="2">Shipping</th> </tr> </thead> <tbody> <tr> <td>COM Ydg</td> <td>3/4</td> <td>Ctn Wt 30</td> </tr> <tr> <td>COL Sq Ft</td> <td>14</td> <td>Cu Ft 20</td> </tr> </tbody> </table>	Dimensions	D	W	H	Overall	28 1/2	28 1/2	36 3/4	Seat	17 3/8	19 3/8	22 1/4	Arm			30 3/8	Upholstery	Shipping		COM Ydg	3/4	Ctn Wt 30	COL Sq Ft	14	Cu Ft 20	All Plastic \$839 COM \$988 A \$996 B \$1,014 COL/C \$1,045 D \$1,085 E \$1,126 F \$1,186 G \$1,253 H \$1,324 I \$1,433 J \$1,567 L1 \$1,265 L2 \$1,345
		Dimensions	D	W	H																							
Overall	28 1/2	28 1/2	36 3/4																									
Seat	17 3/8	19 3/8	22 1/4																									
Arm			30 3/8																									
Upholstery	Shipping																											
COM Ydg	3/4	Ctn Wt 30																										
COL Sq Ft	14	Cu Ft 20																										

Straight Arm Swivel Chair - Wood Back/Upholstered Seat 	KN3000WUS <ul style="list-style-type: none"> standard black nylon base with hard tread dual casters polished aluminum base; add \$103 list standard maple veneer back available in maple finishes optional walnut veneer back available in walnut finishes; add \$30 list optional horizontal double cut; add \$32 list optional handle cut out; add \$22 list maple wood trim arm caps available on standard nylon arms; add \$195 list overall height range 31 1/2" - 36 3/4" seat height range 16 1/2" - 22 1/4" arm height range 30 3/8" - 24 5/8" 	<table border="1"> <thead> <tr> <th>Dimensions</th> <th>D</th> <th>W</th> <th>H</th> </tr> </thead> <tbody> <tr> <td>Overall</td> <td>28 1/2</td> <td>28 1/2</td> <td>36 3/4</td> </tr> <tr> <td>Seat</td> <td>17 3/8</td> <td>19 3/8</td> <td>22 1/4</td> </tr> <tr> <td>Arm</td> <td></td> <td></td> <td>30 3/8</td> </tr> </tbody> </table> <table border="1"> <thead> <tr> <th>Upholstery</th> <th colspan="2">Shipping</th> </tr> </thead> <tbody> <tr> <td>COM Ydg</td> <td>3/4</td> <td>Ctn Wt 30</td> </tr> <tr> <td>COL Sq Ft</td> <td>14</td> <td>Cu Ft 20</td> </tr> </tbody> </table>	Dimensions	D	W	H	Overall	28 1/2	28 1/2	36 3/4	Seat	17 3/8	19 3/8	22 1/4	Arm			30 3/8	Upholstery	Shipping		COM Ydg	3/4	Ctn Wt 30	COL Sq Ft	14	Cu Ft 20	COM \$1,205 A \$1,213 B \$1,232 COL/C \$1,262 D \$1,302 E \$1,342 F \$1,404 G \$1,470 H \$1,541 I \$1,651 J \$1,784 L1 \$1,483 L2 \$1,563
		Dimensions	D	W	H																							
Overall	28 1/2	28 1/2	36 3/4																									
Seat	17 3/8	19 3/8	22 1/4																									
Arm			30 3/8																									
Upholstery	Shipping																											
COM Ydg	3/4	Ctn Wt 30																										
COL Sq Ft	14	Cu Ft 20																										

Straight Arm Swivel Chair - All Upholstered 	KN3000UUS <ul style="list-style-type: none"> standard black nylon base with hard tread dual casters polished aluminum base; add \$103 list maple wood trim arm caps available on standard nylon arms; add \$195 list multiple fabrics, see page KN5 overall height range 31 1/2" - 36 3/4" seat height range 16 1/2" - 22 1/4" arm height range 30 3/8" - 24 5/8" 	<table border="1"> <thead> <tr> <th>Dimensions</th> <th>D</th> <th>W</th> <th>H</th> </tr> </thead> <tbody> <tr> <td>Overall</td> <td>28 1/2</td> <td>28 1/2</td> <td>36 3/4</td> </tr> <tr> <td>Seat</td> <td>17 3/8</td> <td>19 3/8</td> <td>22 1/4</td> </tr> <tr> <td>Arm</td> <td></td> <td></td> <td>30 3/8</td> </tr> </tbody> </table> <table border="1"> <thead> <tr> <th>Upholstery</th> <th colspan="2">Shipping</th> </tr> </thead> <tbody> <tr> <td>COM Ydg</td> <td>1 1/4</td> <td>Ctn Wt 31</td> </tr> <tr> <td>COL Sq Ft</td> <td>23</td> <td>Cu Ft 20</td> </tr> </tbody> </table>	Dimensions	D	W	H	Overall	28 1/2	28 1/2	36 3/4	Seat	17 3/8	19 3/8	22 1/4	Arm			30 3/8	Upholstery	Shipping		COM Ydg	1 1/4	Ctn Wt 31	COL Sq Ft	23	Cu Ft 20	COM \$1,131 A \$1,146 B \$1,175 COL/C \$1,227 D \$1,292 E \$1,360 F \$1,461 G \$1,573 H \$1,690 I \$1,873 J \$2,095 L1 \$1,594 L2 \$1,727
		Dimensions	D	W	H																							
Overall	28 1/2	28 1/2	36 3/4																									
Seat	17 3/8	19 3/8	22 1/4																									
Arm			30 3/8																									
Upholstery	Shipping																											
COM Ydg	1 1/4	Ctn Wt 31																										
COL Sq Ft	23	Cu Ft 20																										

To Order, Specify:

- 1 Model Number
- 2 Plastic Color or Wood Finish - See Plastic Color or Wood Finish Options
 - a. Plastic Back - standard
 - b. Maple Back - standard
 - c. Walnut Back - add \$30 list per back
 - d. Double Cut Back - add \$32 list per back
- 3 Fabric Selection - vendor, pattern and color
 Visit www.jsifurniture.com/finishes-and-materials/textiles for our textiles program. See selection of standard and graded in manufacturers and patterns.
- 4 Handle Cut Out - add \$22 list per veneer back
- 5 Arm Option - Arctic Silver (ASP) or Matte Black (MBK)
- 6 Optional Wood Cap - add \$98 list per arm
- 7 Metal Frame Finish - See Metal Frame Options
 - a. Arctic Silver (ASL)
 - b. Chrome (CHR) - add \$100 list
 - c. Matte Black (MBK)
 - d. Pewter (PEW)
- 8 Base Finish -
 - a. Black (BL)
 - b. Polished Aluminum (PA) - add \$103 list

Kyla Order Check List:



Specify:

- 1. Model Number
- 2. Fabric Selection - vendor, pattern and color
- 3. Wood Finish/Color
- 4. Plastic Color
- 5. Metal Frame Tier/Color:
 - A. Tier 1 - no upcharge
 - B. Tier 2 - add \$150 list
 - C. Tier 3 - add \$170 list

Example:

KY29CP | **MOMENTUM** | **VOX** | **MYSTIC** | **EWM** | **PEW**
 (model #) | (fabric vendor) | (pattern name) | (pattern color) | (plastic) | (metal frame)

1. Model Number

2. Fabric Selection - Please supply the following:
 Fabric vendor/Pattern name/Pattern color

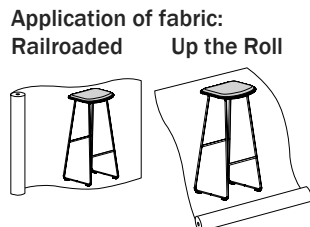
For a complete list of JSI Standard and Graded-In Textiles click here

- Indicate direction of fabric - Railroaded or Up the Roll
- Please provide illustration, if available

All COM orders must include the following:

- Vendor's name, pattern name and color
- Sample of the fabric attached to order
- Model numbers of items for fabric application
- Special application instructions (e.g., all stripes will be applied front to back unless specified otherwise)
- Customer and purchase order number

Ship prepaid COM material to:
 JSI
 Attn: COM Dept
 201 East Martin Street
 Receiving B, Dock 71
 Orleans, IN 47452



All COM orders will ship at standard lead time from receipt of COM except for orders requiring special custom matched finishes.

3. Wood Finish/Color:

ACR	Acorn	MIN	Mineral
BAR	Barrel	POR	Porter
BUF	Buff	RAV	Raven
BUR	Burlap	RYE	Rye
CHE	Chestnut	SAB	Sable
CND	Cinder	SAD	Saddle
EGR	Egret	WWO	Whitewash

4. Plastic Color:

EWM	Extra White	TBM	Tricorn Black
KGR	Kiwi Green	TRD	Tolie Red

5. Metal Frame Tier/Color:

Tier 1:

MBK Matte Black

Tier 2: add \$150 list

ABZ	Aged Bronze	PEW	Pewter
ASL	Arctic Silver	SBZ	Soft Bronze
BWH	Bright White	SNK	Soft Nickel
GLD	Gold		

Tier 3: add \$170 list

BRD	Beige Red (RAL3012)	SAL	Salmon Orange (RAL2012)
CAR	Carmine Red (RAL3002)	SPB	Sapphire Blue (RAL4007)
COP	Copper Brown (RAL8004)	SGR	Signal Green (RAL6032)
HYL	Honey Yellow (RAL1005)	SIG	Signal Orange (RAL2010)
LGR	Leaf Green (RAL6002)	SGY	Silk Grey (RAL7044)
MHB	Mahogany Brown (RAL8016)	SKY	Sky Blue (RAL5015)
MTQ	Mint Turquoise (RAL6033)	TBL	Traffic Blue (RAL5017)
OGR	Olive Green (RAL6003)	TRD	Traffic Red (RAL3020)
PPV	Purple Violet (RAL4007)	TQP	Turquoise Pastel (RAL6034)
QZG	Quartz Grey (RAL7039)	ZYL	Zinc Yellow (RAL1018)

Description

28¾" h Barstool with Plastic Seat



KY29AP
plastic seat



KY29CP
uph. seat pad

1 Model

KY29AP
KY29CP - Uph. Pad.
· tiered pricing for metal finish options, see pg [KY2](#)

Specifications

Dimensions	D	W	H
Overall	13	14	28¾
Seat	11½	14	28¾
Upholstery		Shipping	
COM Ydg	½	Ctn Wt	16
COL Sq Ft		Cu Ft	7

List Price Per Grade

Plastic Seat	\$444
COM	\$550
A	\$558
B	\$570
COL/C	\$590
D	\$619
E	\$646
F	\$689
G	\$735
H	\$785
I	\$860
J	\$953
L1	\$818
L2	\$892

28¾" h Barstool with Wood Seat



KY29AW
wood seat



KY29CP
uph. seat pad

KY29AW
KY29CW - Uph. Pad
· tiered pricing for metal finish options, see pg [KY2](#)

Dimensions	D	W	H
Overall	13	14	28¾
Seat	11½	14	28¾
Upholstery		Shipping	
COM Ydg	½	Ctn Wt	14
COL Sq Ft		Cu Ft	6


Wood Seat	\$697
COM	\$802
A	\$809
B	\$821
COL/C	\$843
D	\$870
E	\$899
F	\$939
G	\$986
H	\$1,036
I	\$1,115
J	\$1,205
L1	\$1,069
L2	\$1,144


To Order, Specify:

- 1 Model Number
- 2 Fabric Selection - vendor, pattern and color
Visit www.jsifurniture.com/finishes-and-materials/textiles for our textiles program. See selection of standard and graded in manufacturers and patterns.
- 3 Wood Finish/Color See [Wood Finish/Color Options](#)
- 4 Plastic Color See [Plastic Color Options](#)
- 5 Metal Frame Tier/Color See [Metal Frame Tier Color Options](#)

Specifications

- Powder coat metal frame.
- Seat ¾" thick polypropylene or ¾" thick solid ash.
- Standard with screw-on black glides.

Description	Model	Specifications	List Price Per Grade												
25¼" h Counter Height Stool with Plastic Seat  KY25AP plastic seat KY25CP uph. seat pad	KY25AP KY25CP - Uph. Pad · tiered pricing for metal finish options, see pg KY2	<table border="1"> <thead> <tr> <th>Dimensions</th> <th>D</th> <th>W</th> <th>H</th> </tr> </thead> <tbody> <tr> <td>Overall</td> <td>13</td> <td>14</td> <td>25 ¼</td> </tr> <tr> <td>Seat</td> <td>11 ½</td> <td>14</td> <td>25 ¼</td> </tr> </tbody> </table>	Dimensions	D	W	H	Overall	13	14	25 ¼	Seat	11 ½	14	25 ¼	Plastic Seat \$437 COM \$545 A \$550 B \$563 COL/C \$584 D \$613 E \$640 F \$683 G \$729 H \$779 I \$856 J \$949 L1 \$812 L2 \$886
		Dimensions	D	W	H										
Overall	13	14	25 ¼												
Seat	11 ½	14	25 ¼												
<table border="1"> <thead> <tr> <th>Upholstery</th> <th colspan="2">Shipping</th> </tr> </thead> <tbody> <tr> <td>COM Ydg</td> <td>½</td> <td>Ctn Wt 14</td> </tr> <tr> <td>COL Sq Ft</td> <td></td> <td>Cu Ft 6</td> </tr> </tbody> </table>	Upholstery	Shipping		COM Ydg	½	Ctn Wt 14	COL Sq Ft		Cu Ft 6						
Upholstery	Shipping														
COM Ydg	½	Ctn Wt 14													
COL Sq Ft		Cu Ft 6													

Description	Model	Specifications	List Price Per Grade												
25¼" h Counter Height Stool with Wood Seat  KY25AW wood seat KY25CW uph. seat pad	KY25AW KY25CW - Uph. Pad · tiered pricing for metal finish options, see pg KY2	<table border="1"> <thead> <tr> <th>Dimensions</th> <th>D</th> <th>W</th> <th>H</th> </tr> </thead> <tbody> <tr> <td>Overall</td> <td>13</td> <td>14</td> <td>25 ¼</td> </tr> <tr> <td>Seat</td> <td>11 ½</td> <td>14</td> <td>25 ¼</td> </tr> </tbody> </table>	Dimensions	D	W	H	Overall	13	14	25 ¼	Seat	11 ½	14	25 ¼	Wood Seat \$691 COM \$797 A \$802 B \$814 COL/C \$837 D \$864 E \$892 F \$935 G \$980 H \$1,029 I \$1,105 J \$1,199 L1 \$1,065 L2 \$1,139
		Dimensions	D	W	H										
Overall	13	14	25 ¼												
Seat	11 ½	14	25 ¼												
<table border="1"> <thead> <tr> <th>Upholstery</th> <th colspan="2">Shipping</th> </tr> </thead> <tbody> <tr> <td>COM Ydg</td> <td></td> <td>Ctn Wt 14</td> </tr> <tr> <td>COL Sq Ft</td> <td></td> <td>Cu Ft 6</td> </tr> </tbody> </table>	Upholstery	Shipping		COM Ydg		Ctn Wt 14	COL Sq Ft		Cu Ft 6						
Upholstery	Shipping														
COM Ydg		Ctn Wt 14													
COL Sq Ft		Cu Ft 6													

To Order, Specify:

- 1 Model Number
- 2 Fabric Selection - vendor, pattern and color
 Visit www.jsifurniture.com/finishes-and-materials/textiles for our textiles program. See selection of standard and graded in manufacturers and patterns.
- 3 Wood Finish/Color See [Wood Finish/Color Options](#)
- 4 Plastic Color See [Plastic Color Options](#)
- 5 Metal Frame Tier/Color See [Metal Frame Tier Color Options](#)

Specifications

- Powder coat metal frame.
- Seat ¾" thick polypropylene or ¾" thick solid ash.
- Standard with screw-on black glides.

Laurel Order Check List:



Specify:

- 1. Model Number
- 2. Wood Species - Beech (B) (chairs) or Maple (M) (tables)
- 3. Wood Finish
- 4. Fabric Selection - vendor, pattern and color
- 5. Optional Anti-Microbial Arm Cap - add \$93 list per arm cap
- 6. Optional Rubber Cushion Nylon Glides - no upcharge; chairs only
- 7. Optional Coordinating Wood Grain Laminate Table Tops - no upcharge; tables only

Example:

LA1281 (model #)	B (wood species)	HRV (finish)	MOMENTUM (fabric vendor)	VOX (pattern name)	MYSTIC (pattern color)
----------------------------	----------------------------	------------------------	------------------------------------	------------------------------	----------------------------------

1. Model Number

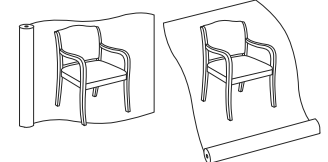
front to back unless specified otherwise)
 - Customer and purchase order number

2. Wood Species - Beech (B) (chairs) and Maple (M) (tables)

Ship prepaid COM material to:

Application of fabric:
 Railroaded Up the Roll

JSI
 Attn: COM Dept
 201 East Martin Street
 Receiving B, Dock 71
 Orleans, IN 47452



All COM orders will ship at standard lead time from receipt of COM except for orders requiring special custom matched finishes.

3. Wood Finish Options:

ALM Ale Medium	HRV Harvest*
CAL Ale Light Coordinate	CKC Khaki Coordinate
BBM Bourbon Medium	MINC Mineral Coordinate
CBZ Brazilwood Coordinate	MCH Mocha*
BARC Barrel Coordinate	CPI Pinnacle Walnut Coordinate
CBO Bourbon Light Coordinate	PRL Praline*
CBG Brighton Light Coordinate	RAVC Raven Coordinate
BRM Brighton Medium	SABC Sable Coordinate
BUT Butterscotch	SIE Sienna*
CNDC Cinder Coordinate	CST Studio Teak Coordinate
CLA Classic	TRF Truffle*
CLL Collectors*	UMB Umber*
EGRC Egret Coordinate	VALC Valley Coordinate
ESP Espresso	VEN Venetian
FAW Fawn Coordinate	CWE Weathered Ash Coordinate
FLX Flax	
CGR Graphite Coordinate	

5. Optional Anti-Microbial Arm Cap - add \$93 list per arm cap. Available on any Laurel model.



4. Fabric Selection - Please supply the following:
 Fabric vendor/Pattern name/Pattern color

For a complete list of JSI Standard and Graded-In Textiles click here

When specifying contrasting upholstery, indicate clearly which upholstery is to be applied to the seat, back and arms. Use higher grade pricing.

- Indicate direction of fabric - Railroaded or Up the Roll
- Please provide illustration, if available


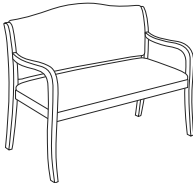

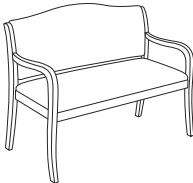
6. Optional Rubber Cushion Nylon Glides - no upcharge; chairs only

***7. Optional Coordinating Wood Grain Laminate Table Top - no upcharge; tables only. Finishes with an asterisk (*) have a coordinating laminate available.**


All COM orders must include the following:

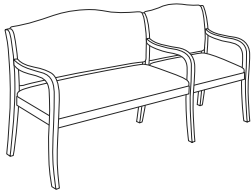
- Fabric vendor's name, pattern name and color
- Sample of the fabric attached to order
- Model numbers of items for fabric application
- Special application instructions (e.g., all stripes will be applied

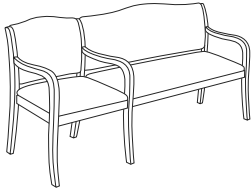
LAUREL

Description	① Model	Specifications	List Price Per Grade																
30" Bariatric 	LA1281B · meets BIFMA x5.11 large occupant standard (253-400 lb individual) · optional anti-microbial arm cap - add \$186 list	<table border="1"> <thead> <tr> <th>Dimensions</th> <th>D</th> <th>W</th> <th>H</th> </tr> </thead> <tbody> <tr> <td>Overall</td> <td>26</td> <td>32 ½</td> <td>34 ½</td> </tr> <tr> <td>Seat</td> <td>18 ¼</td> <td>30</td> <td>18</td> </tr> <tr> <td>Arm</td> <td></td> <td></td> <td>27 ½</td> </tr> </tbody> </table>	Dimensions	D	W	H	Overall	26	32 ½	34 ½	Seat	18 ¼	30	18	Arm			27 ½	COM \$2,240 A \$2,271 B \$2,331 COL/C \$2,439 D \$2,573 E \$2,709 F \$2,852 G \$3,058 H \$3,273 I \$3,615 J \$4,020 L1 \$3,098 L2 \$3,314
		Dimensions	D	W	H														
Overall	26	32 ½	34 ½																
Seat	18 ¼	30	18																
Arm			27 ½																
<table border="1"> <thead> <tr> <th>Upholstery</th> <th colspan="3">Shipping</th> </tr> </thead> <tbody> <tr> <td>COM Ydg</td> <td>2 ¼</td> <td>Ctn Wt</td> <td>43</td> </tr> <tr> <td>COL Sq Ft</td> <td>41</td> <td>Cu Ft</td> <td>23</td> </tr> </tbody> </table>	Upholstery	Shipping			COM Ydg	2 ¼	Ctn Wt	43	COL Sq Ft	41	Cu Ft	23							
Upholstery	Shipping																		
COM Ydg	2 ¼	Ctn Wt	43																
COL Sq Ft	41	Cu Ft	23																
42" Bariatric 	LA1282B · meets BIFMA x5.11 large occupant standard (253-400 lb individual) · optional anti-microbial arm cap - add \$186 list	<table border="1"> <thead> <tr> <th>Dimensions</th> <th>D</th> <th>W</th> <th>H</th> </tr> </thead> <tbody> <tr> <td>Overall</td> <td>26</td> <td>43 ½</td> <td>34 ½</td> </tr> <tr> <td>Seat</td> <td>18 ¼</td> <td>41</td> <td>18</td> </tr> <tr> <td>Arm</td> <td></td> <td></td> <td>27 ½</td> </tr> </tbody> </table>	Dimensions	D	W	H	Overall	26	43 ½	34 ½	Seat	18 ¼	41	18	Arm			27 ½	COM \$2,447 A \$2,476 B \$2,536 COL/C \$2,643 D \$2,776 E \$2,913 F \$3,059 G \$3,261 H \$3,477 I \$3,817 J \$4,226 L1 \$3,411 L2 \$3,653
		Dimensions	D	W	H														
Overall	26	43 ½	34 ½																
Seat	18 ¼	41	18																
Arm			27 ½																
<table border="1"> <thead> <tr> <th>Upholstery</th> <th colspan="3">Shipping</th> </tr> </thead> <tbody> <tr> <td>COM Ydg</td> <td>2 ¼</td> <td>Ctn Wt</td> <td>51</td> </tr> <tr> <td>COL Sq Ft</td> <td>45</td> <td>Cu Ft</td> <td>30</td> </tr> </tbody> </table>	Upholstery	Shipping			COM Ydg	2 ¼	Ctn Wt	51	COL Sq Ft	45	Cu Ft	30							
Upholstery	Shipping																		
COM Ydg	2 ¼	Ctn Wt	51																
COL Sq Ft	45	Cu Ft	30																
Guest Chair 	LA1281 · optional anti-microbial arm cap - add \$186 list	<table border="1"> <thead> <tr> <th>Dimensions</th> <th>D</th> <th>W</th> <th>H</th> </tr> </thead> <tbody> <tr> <td>Overall</td> <td>26</td> <td>22 ½</td> <td>34 ½</td> </tr> <tr> <td>Seat</td> <td>18 ¼</td> <td>20</td> <td>18</td> </tr> <tr> <td>Arm</td> <td></td> <td></td> <td>27 ½</td> </tr> </tbody> </table>	Dimensions	D	W	H	Overall	26	22 ½	34 ½	Seat	18 ¼	20	18	Arm			27 ½	COM \$1,149 A \$1,169 B \$1,212 COL/C \$1,278 D \$1,370 E \$1,461 F \$1,557 G \$1,692 H \$1,836 I \$2,065 J \$2,335 L1 \$1,719 L2 \$1,865
		Dimensions	D	W	H														
Overall	26	22 ½	34 ½																
Seat	18 ¼	20	18																
Arm			27 ½																
<table border="1"> <thead> <tr> <th>Upholstery</th> <th colspan="3">Shipping</th> </tr> </thead> <tbody> <tr> <td>COM Ydg</td> <td>1 ½</td> <td>Ctn Wt</td> <td>22</td> </tr> <tr> <td>COL Sq Ft</td> <td>27</td> <td>Cu Ft</td> <td>15</td> </tr> </tbody> </table>	Upholstery	Shipping			COM Ydg	1 ½	Ctn Wt	22	COL Sq Ft	27	Cu Ft	15							
Upholstery	Shipping																		
COM Ydg	1 ½	Ctn Wt	22																
COL Sq Ft	27	Cu Ft	15																
Loveseat 	LA1282 · optional anti-microbial arm cap - add \$186 list	<table border="1"> <thead> <tr> <th>Dimensions</th> <th>D</th> <th>W</th> <th>H</th> </tr> </thead> <tbody> <tr> <td>Overall</td> <td>26</td> <td>43 ½</td> <td>34 ½</td> </tr> <tr> <td>Seat</td> <td>18 ¼</td> <td>41</td> <td>18</td> </tr> <tr> <td>Arm</td> <td></td> <td></td> <td>27 ½</td> </tr> </tbody> </table>	Dimensions	D	W	H	Overall	26	43 ½	34 ½	Seat	18 ¼	41	18	Arm			27 ½	COM \$1,988 A \$2,020 B \$2,076 COL/C \$2,184 D \$2,317 E \$2,454 F \$2,598 G \$2,802 H \$3,018 I \$3,358 J \$3,765 L1 \$2,949 L2 \$3,197
		Dimensions	D	W	H														
Overall	26	43 ½	34 ½																
Seat	18 ¼	41	18																
Arm			27 ½																
<table border="1"> <thead> <tr> <th>Upholstery</th> <th colspan="3">Shipping</th> </tr> </thead> <tbody> <tr> <td>COM Ydg</td> <td>2 ¼</td> <td>Ctn Wt</td> <td>46</td> </tr> <tr> <td>COL Sq Ft</td> <td>45</td> <td>Cu Ft</td> <td>30</td> </tr> </tbody> </table>	Upholstery	Shipping			COM Ydg	2 ¼	Ctn Wt	46	COL Sq Ft	45	Cu Ft	30							
Upholstery	Shipping																		
COM Ydg	2 ¼	Ctn Wt	46																
COL Sq Ft	45	Cu Ft	30																

LAUREL

Description	Model	Specifications				List Price Per Grade			
Guest Chair 	LA1301 • optional anti-microbial arm cap - add \$186 list • full back • no exposed wood rails	Dimensions		D	W	H	COM \$1,152 A \$1,178 B \$1,223 COL/C \$1,308 D \$1,412 E \$1,518 F \$1,630 G \$1,785 H \$1,956 I \$2,221 J \$2,537 L1 \$1,820 L2 \$1,989		
		Overall		26	22 1/2	34 1/2			
		Seat		18 1/4	20	18			
		Arm		27 1/2					
		Upholstery		Shipping					
		COM Ydg		1 3/4	Ctn Wt	22			
		COL Sq Ft		32	Cu Ft	15			

Description	Model	Specifications				List Price Per Grade			
Loveseat/Chair Unit 	LA1283 • sequence facing unit • optional anti-microbial arm cap - add \$279 list	Dimensions		D	W	H	COM \$2,901 A \$2,952 B \$3,053 COL/C \$3,228 D \$3,455 E \$3,682 F \$3,921 G \$4,259 H \$4,622 I \$5,187 J \$5,864 L1 \$4,508 L2 \$4,914		
		Overall		26	64 1/2	34 1/2			
		Seat		18 1/4	41/20	18			
		Arm		27 1/2					
		Upholstery		Shipping					
		COM Ydg		3 3/4	Ctn Wt	64			
		COL Sq Ft		75	Cu Ft	44			

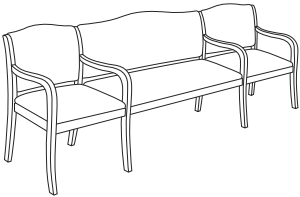
Description	Model	Specifications				List Price Per Grade			
Chair Unit/Loveseat 	LA1284 • sequence facing unit • optional anti-microbial arm cap - add \$279 list	Dimensions		D	W	H	COM \$2,901 A \$2,952 B \$3,053 COL/C \$3,228 D \$3,455 E \$3,682 F \$3,921 G \$4,259 H \$4,622 I \$5,187 J \$5,864 L1 \$4,508 L2 \$4,914		
		Overall		26	64 1/2	34 1/2			
		Seat		18 1/4	20/41	18			
		Arm		27 1/2					
		Upholstery		Shipping					
		COM Ydg		3 3/4	Ctn Wt	64			
		COL Sq Ft		75	Cu Ft	44			

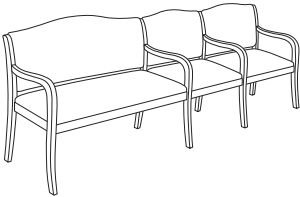
To Order, Specify:

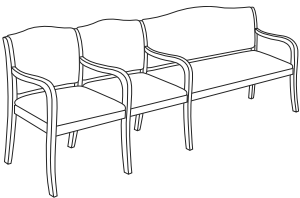
- 1 Model Number
- 2 Wood Species - Beech (B) (chairs)
- 3 Wood Finish See [Wood Finish Options](#)
- 4 Fabric Selection - vendor, pattern and color
 Visit www.jsifurniture.com/finishes-and-materials/textiles for our textiles program. See selection of standard and graded in manufacturers and patterns.
- 5 Optional Anti-Microbial Arm Cap - add \$93 list per arm cap
- 6 Optional Rubber Cushion Nylon Glides - no upcharge; chairs only

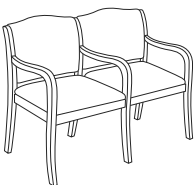
Specifications

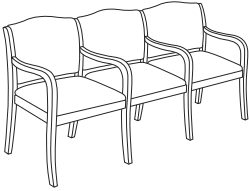
- Wood species - Beech (chairs).
- Seat has synthetic sheet webbing and 2" high density polyurethane foam.
- Back has polypropylene webbing and 1 1/2" polyurethane foam.
- Mortise and tenon construction with corner blocks, glue and screws.
- Solid one piece steam bent arms with front leg assembly.
- Standard with rubber cushion metal glides.

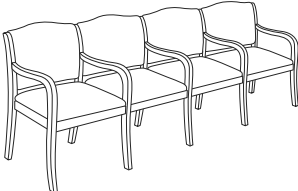
Description	① Model	Specifications			List Price Per Grade	
		Dimensions	D	W		H
Chair/Loveseat/Chair Unit 	LA1285 · optional anti-microbial arm cap - add \$372 list	Overall	26	85 ¾	34 ½	COM \$3,809
		Seat	18 ¼	20/41/20	18	A \$3,880
		Arm			27 ½	B \$4,022
		Upholstery		Shipping		COL/C \$4,268
		COM Ydg	5 ¼	Ctn Wt	82	D \$4,587
		COL Sq Ft	105	Cu Ft	58	E \$4,902
						F \$5,236
						G \$5,710
						H \$6,218
						I \$7,012
						J \$7,962
						L1 \$6,058
						L2 \$6,630

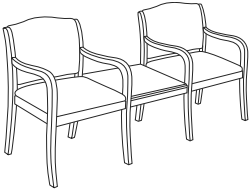
Description	① Model	Specifications			List Price Per Grade	
		Dimensions	D	W		H
Loveseat/Chair/Chair Unit 	LA1286 · sequence facing unit · optional anti-microbial arm cap - add \$372 list	Overall	26	85 ¾	34 ½	COM \$3,809
		Seat	18 ¼	41/20/20	18	A \$3,880
		Arm			27 ½	B \$4,022
		Upholstery		Shipping		COL/C \$4,268
		COM Ydg	5 ¼	Ctn Wt	82	D \$4,587
		COL Sq Ft	105	Cu Ft	58	E \$4,902
						F \$5,236
						G \$5,710
						H \$6,218
						I \$7,012
						J \$7,962
						L1 \$6,058
						L2 \$6,630

Description	① Model	Specifications			List Price Per Grade	
		Dimensions	D	W		H
Chair/Chair/Loveseat Unit 	LA1287 · sequence facing unit · optional anti-microbial arm cap - add \$372 list	Overall	26	85 ¾	34 ½	COM \$3,809
		Seat	18 ¼	20/20/41	18	A \$3,880
		Arm			27 ½	B \$4,022
		Upholstery		Shipping		COL/C \$4,268
		COM Ydg	5 ¼	Ctn Wt	82	D \$4,587
		COL Sq Ft	105	Cu Ft	58	E \$4,902
						F \$5,236
						G \$5,710
						H \$6,218
						I \$7,012
						J \$7,962
						L1 \$6,058
						L2 \$6,630

Description	① Model	Specifications			List Price Per Grade	
		Dimensions	D	W		H
Two Seat Unit 	LA1292 · optional anti-microbial arm cap - add \$279 list	Overall	26	43 ½	34 ½	COM \$2,063
		Seat	18 ¼	20	18	A \$2,102
		Arm			27 ½	B \$2,184
		Upholstery		Shipping		COL/C \$2,327
		COM Ydg	3	Ctn Wt	42	D \$2,506
		COL Sq Ft	54	Cu Ft	30	E \$2,687
						F \$2,876
						G \$3,149
						H \$3,438
						I \$3,891
						J \$4,435
						L1 \$3,203
						L2 \$3,494

Description	Model	Specifications				List Price Per Grade	
		Dimensions	D	W	H	COM	
Three Seat Unit 	LA1293 • optional anti-microbial arm cap - add \$372 list	Overall	26	64 7/8	34 1/2	COM	\$2,972
		Seat	18 1/4	20	18	A	\$3,034
		Arm			27 1/2	B	\$3,155
		Upholstery		Shipping		COL/C	\$3,368
		COM Ydg	4 1/2	Ctn Wt	60	D	\$3,639
		COL Sq Ft	81	Cu Ft	44	E	\$3,910
						F	\$4,196
						G	\$4,604
						H	\$5,038
						I	\$5,719
				J	\$6,531		
				L1	\$4,685		
				L2	\$5,119		

Description	Model	Specifications				List Price Per Grade	
		Dimensions	D	W	H	COM	
Four Seat Unit 	LA1294 • optional anti-microbial arm cap - add \$465 list	Overall	26	86 1/8	34 1/2	COM	\$3,881
		Seat	18 1/4	20	18	A	\$3,962
		Arm			27 1/2	B	\$4,126
		Upholstery		Shipping		COL/C	\$4,404
		COM Ydg	6	Ctn Wt	78	D	\$4,769
		COL Sq Ft	108	Cu Ft	58	E	\$5,131
						F	\$5,513
						G	\$6,055
						H	\$6,633
						I	\$7,544
				J	\$8,625		
				L1	\$6,162		
				L2	\$6,741		

Description	Model	Specifications				List Price Per Grade	
		Dimensions	D	W	H	COM	
Chair/Table/Chair Unit 	LA1295 • optional anti-microbial arm cap - add \$372 list • table - optional coordinating wood grain laminate - no upcharge	Overall	26	64 1/2	34 1/2	COM	\$2,775
		Seat	18 1/4	20	18	A	\$2,814
		Arm			27 1/2	B	\$2,896
		Upholstery		Shipping		COL/C	\$3,036
		COM Ydg	3	Ctn Wt	58	D	\$3,222
		COL Sq Ft	54	Cu Ft	44	E	\$3,398
						F	\$3,589
						G	\$3,861
						H	\$4,150
						I	\$4,605
				J	\$5,148		
				L1	\$3,918		
				L2	\$4,206		

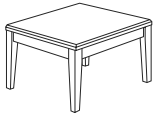
To Order, Specify:

- 1 Model Number
- 2 Wood Species - Beech (B) - chairs; Maple (M) - tables
- 3 Wood Finish [See Wood Finish Options](#)
- 4 Fabric Selection - vendor, pattern and color
Visit www.jsifurniture.com/finishes-and-materials/textiles for our textiles program. See selection of standard and graded in manufacturers and patterns.
- 5 Optional Anti-Microbial Arm Cap - add \$93 list per arm cap
- 6 Optional Rubber Cushion Nylon Glides - no upcharge; chairs only
- 7 Optional Coordinating Wood Grain Laminate
Table Tops - no upcharge; tables only. Finishes with an asterisk (*) have a coordinating laminate available.

Specifications

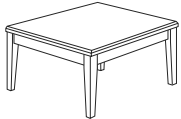
- Wood species - Maple veneer (tables).
- Top core material is 1 1/8" thick with 45 lb. density industrial grade particle board.
- Face is wood veneer or .050 horizontal grade HPL.
- Backer is bonded to bottom side to ensure balanced construction.
- All tops have internal solid lumber bands with overlay laminate or veneer.

Description	D	W	H	CTN WT	CU FT	① Model	List Price
End Table	24	24	17	25	4	LA2424ET	\$987



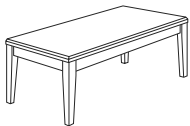
- maple veneer top
- ships KD

End Table	30	30	17	40	6	LA3030ET	\$1,155
-----------	----	----	----	----	---	----------	---------



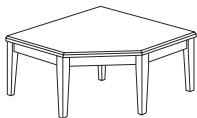
- maple veneer top
- ships KD

Magazine Table	20	42	17	45	6	LA2042MT	\$1,168
----------------	----	----	----	----	---	----------	---------



- maple veneer top
- ships KD

Corner Table	36	36	17	50	8	LA3636CT	\$1,360
--------------	----	----	----	----	---	----------	---------



- maple veneer top
- ships KD

LAUREL

To Order, Specify:

- ① Model Number
- ② Wood Species - Beech (B) - chairs; Maple (M) - tables
- ③ Wood Finish [See Wood Finish Options](#)
- ④ Optional Anti-Microbial Arm Cap - add \$93 list per arm cap
- ⑤ Optional Rubber Cushion Nylon Glides - no upcharge; chairs only
- ⑥ Optional Coordinating Wood Grain Laminate
Table Tops - no upcharge; tables only. Finishes with an asterisk (*) have a coordinating laminate available.

Specifications

- Wood species - Maple veneer (tables).
- Top core material is 1 1/8" thick with 45 lb. density industrial grade particle board.
- Face is wood veneer or .050 horizontal grade HPL.
- Backer is bonded to bottom side to ensure balanced construction.
- All tops have internal solid lumber bands with overlay laminate or veneer.

Mackey Order Check List:



Specify:

- 1. Model Number
- 2. Fabric Selection - vendor, pattern and color
- 3. Wood Species/Finish/Color
 - A. Maple (M) - no upcharge
 - B. White Oak (WO)- add \$94 list
- 4. Metal Frame Tier/Color:
 - A. Tier 1 - no upcharge
 - B. Tier 2 - add \$150 list
 - C. Tier 3 - add \$170 list

Example:

MY24C | MOMENTUM | VOX | MYSTIC | HRV | PEW
 (model #) | (fabric vendor) | (pattern name) | (pattern color) | (wood finish) | (metal frame)

1. Model Number

2. Fabric Selection - Please supply the following:
 Fabric vendor/Pattern name/Pattern color

For a complete list of JSI Standard and Graded-In Textiles click here

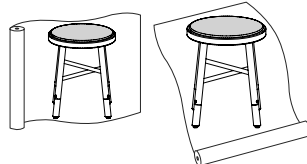
- Indicate direction of fabric - Railroaded or Up the Roll
- Please provide illustration, if available

All COM orders must include the following:

- Vendor's name, pattern name and color
- Sample of the fabric attached to order
- Model numbers of items for fabric application
- Special application instructions (e.g., all stripes will be applied front to back unless specified otherwise)
- Customer and purchase order number

Ship prepaid COM material to:
 JSI
 Attn: COM Dept
 201 East Martin Street
 Receiving B, Dock 71
 Orleans, IN 47452

Application of fabric:
 Railroaded Up the Roll



All COM orders will ship at standard lead time from receipt of COM except for orders requiring special custom matched finishes.

3. Wood Base/Color Options:

Maple (M)

ALM	Ale Medium	HRV	Harvest
CAL	Ale Light Coordinate	CKC	Khaki Coordinate
BBM	Bourbon Medium	MINC	Mineral Coordinate
CBZ	Brazilwood Coordinate	MCH	Mocha
BARC	Barrel Coordinate	CPI	Pinnacle Walnut Coordinate
CBO	Bourbon Light Coordinate	PRL	Praline
CBG	Brighton Light Coordinate	RAVC	Raven Coordinate
BRM	Brighton Medium	SABC	Sable Coordinate
BUT	Butterscotch	SIE	Sienna
CNDC	Cinder Coordinate	CST	Studio Teak Coordinate
CLA	Classic	TRF	Truffle
CLL	Collectors	UMB	Umber
EGRC	Egret Coordinate	VALC	Valley Coordinate
ESP	Espresso	VEN	Venetian
FAWC	Fawn Coordinate	CWE	Weathered Ash Coordinate
FLX	Flax		
CGR	Graphite Coordinate		

3. Wood Finish/Color: (cont)**White Oak (WO), add \$94 list**

ACR	Acorn	MIN	Mineral
BAR	Barrel	POR	Porter
BUF	Buff	RAV	Raven
BUR	Burlap	RYE	Rye
CHE	Chestnut	SAB	Sable
CND	Cinder	SAD	Saddle
EGR	Egret	WVO	Whitewash

4. Metal Frame Tier/Color:**Tier 1:**

MBK	Matte Black	RML	Raw
-----	-------------	-----	-----

Tier 2: add \$150 list

ABZ	Aged Bronze	PEW	Pewter
ASL	Arctic Silver	SBZ	Soft Bronze
BWH	Bright White	SNK	Soft Nickel
GLD	Gold		

Tier 3: add \$170 list

BRD	Beige Red (RAL3012)	SAL	Salmon Orange (RAL2012)
CAR	Carmine Red (RAL3002)	SPB	Sapphire Blue (RAL4007)
COP	Copper Brown (RAL8004)	SGR	Signal Green (RAL6032)
HYL	Honey Yellow (RAL1005)	SIG	Signal Orange (RAL2010)
LGR	Leaf Green (RAL6002)	SGY	Silk Grey (RAL7044)
MHB	Mahogany Brown (RAL8016)	SKY	Sky Blue (RAL5015)
MTQ	Mint Turquoise (RAL6033)	TBL	Traffic Blue (RAL5017)
OGR	Olive Green (RAL6003)	TRD	Traffic Red (RAL3020)
PPV	Purple Violet (RAL4007)	TQP	Turquoise Pastel (RAL6034)
QZG	Quartz Grey (RAL7039)	ZYL	Zinc Yellow (RAL1018)

Specifications:

- Powder coat or raw metal frame.
- Metal stretcher rails.
- 1 3/4" solid maple or white oak seat.
- 4" solid maple or white oak foot with exposed bolts.
- 3/4" upholstered seat pad.
- Metal nail in glide.

Description

1 Model

Specifications

List Price Per Grade

30" h Barstool



MY30A
wood seat

MY30C
uph. seat pad

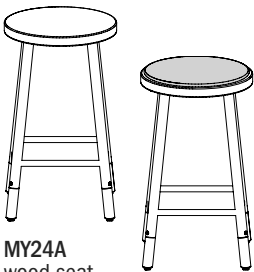
MY30A
MY30C - Uph. Pad

- tiered pricing for metal finish options, see pg [MY2](#)
- 4" wood foot with exposed bolts
- metal stretcher rails on sides and front and back

Dimensions	D	W	H
Overall	19½	19½	30
Seat	16	16	30
Upholstery		Shipping	
COM Ydg	½	Ctn Wt	22
COL Sq Ft	14	Cu Ft	8

Wood Seat	\$823
COM	\$910
A	\$917
B	\$933
COL/C	\$957
D	\$990
E	\$1,021
F	\$1,072
G	\$1,126
H	\$1,183
I	\$1,275
J	\$1,382
L1	\$1,224
L2	\$1,309

24" h Counter Height Stool



MY24A
wood seat

MY24C
uph. seat pad

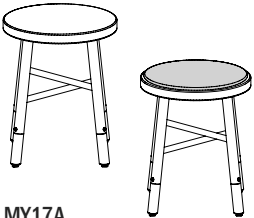
MY24A
MY24C - Uph. Pad

- tiered pricing for metal finish options, see pg [MY2](#)
- 4" wood foot with exposed bolts
- metal stretcher rails on sides and front and back

Dimensions	D	W	H
Overall	19½	19½	24
Seat	16	16	24
Upholstery		Shipping	
COM Ydg	½	Ctn Wt	20
COL Sq Ft	14	Cu Ft	6

Wood Seat	\$823
COM	\$910
A	\$917
B	\$933
COL/C	\$957
D	\$990
E	\$1,021
F	\$1,072
G	\$1,126
H	\$1,183
I	\$1,275
J	\$1,382
L1	\$1,224
L2	\$1,309

17" h Seated Height Stool



MY17A
wood seat

MY17C
uph. seat pad

MY17A
MY17C - Uph. Pad

- tiered pricing for metal finish options, see pg [MY2](#)
- 4" wood foot with exposed bolts
- cross rails

Dimensions	D	W	H
Overall	19½	19½	17
Seat	16	16	17
Upholstery		Shipping	
COM Ydg	½	Ctn Wt	18
COL Sq Ft	14	Cu Ft	4

Wood Seat	\$795
COM	\$887
A	\$893
B	\$908
COL/C	\$934
D	\$965
E	\$999
F	\$1,049
G	\$1,102
H	\$1,161
I	\$1,251
J	\$1,360
L1	\$1,200
L2	\$1,286

To Order, Specify:

- 1 Model Number
- 2 Fabric Selection - vendor, pattern and color
Visit www.jsifurniture.com/finishes-and-materials/textiles for our textiles program. See selection of standard and graded in manufacturers and patterns.
- 3 Wood Species/Finish/Color See [Wood Species/Finish Color Options](#)
- 4 Metal Frame Tier/Color See [Metal Frame Tier/Color Options](#)

Madison Order Check List:



Specify:

- 1. Model Number
- 2. Wood Species - Maple (M)
- 3. Wood Base/Arm Detail Finish
- 4. Fabric Selection - vendor, pattern and color
- 5. Optional Black Pneumatic or Mechanical Jury Base - add \$203 list; wood base standard
- 6. Optional Knee-Tilt - add \$139 list
- 7. Optional Black Antique Trim Nails - no upcharge
(Replaces standard antique brass trim nails)
- 6. Optional Plastic Bumper Guard - add \$25 list

Example:

MA1500F (model #)	M (wood species)	HRV (finish) wood base/arm detail	MOMENTUM (fabric vendor)	VOX (pattern name)	MYSTIC (pattern color)
-----------------------------	----------------------------	--	------------------------------------	------------------------------	----------------------------------

1. Model Number

2. Wood Species - Maple (M)

3. Wood Base/Arm Detail Finish Options:

ALM Ale Medium	HRV Harvest
CAL Ale Light Coordinate	CKC Khaki Coordinate
BBM Bourbon Medium	MINC Mineral Coordinate
CBZ Brazilwood Coordinate	MCH Mocha
BARC Barrel Coordinate	CPI Pinnacle Walnut Coordinate
CBO Bourbon Light Coordinate	PRL Praline
CBG Brighton Light Coordinate	RAVC Raven Coordinate
BRM Brighton Medium	SABC Sable Coordinate
BUT Butterscotch	SIE Sienna
CNDC Cinder Coordinate	CST Studio Teak Coordinate
CLA Classic	TRF Truffle
CLL Collectors	UMB Umber
EGRC Egret Coordinate	VALC Valley Coordinate
ESP Espresso	VEN Venetian
FAWC Fawn Coordinate	CWE Weathered Ash Coordinate
FLX Flax	
CGR Graphite Coordinate	

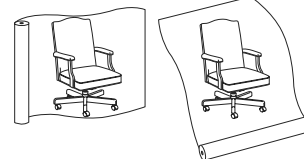
All COM orders must include the following:

- Vendor's name, pattern name and color
- Sample of the fabric attached to order
- Model numbers of items for fabric application
- Special application instructions (e.g., all stripes will be applied front to back unless specified otherwise)
- Customer and purchase order number

Ship prepaid COM material to:

JSI
Attn: COM Dept
201 East Martin Street
Receiving B, Dock 71
Orleans, IN 47452

Application of fabric:
Railroaded Up the Roll



All COM orders will ship at standard lead time from receipt of COM except for orders requiring special custom matched finishes.

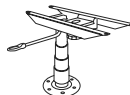
4. Fabric Selection - Please supply the following:
Fabric vendor/Pattern name/Pattern color

For a complete list of JSI Standard and Graded-In Textiles click here

When specifying contrasting upholstery, indicate clearly which upholstery is to be applied to the seat, back and arms. Use higher grade pricing.

- Indicate direction of fabric - Railroaded or Up the Roll
- Please provide illustration, if available

5. Base Black Jury Base - add \$203 list



Pneumatic lift-
NOT self-centering -
Standard





Mechanical
self-centering lift -
MUST BE SPECIFIED

6. Optional Knee-Tilt - add \$139 list

7. Optional Black Antique Trim Nails - no upcharge
(Replaces standard antique brass trim nails)

8. Optional Plastic Bumper Guard - add \$25 list

Description	Model	Specifications				List Price Per Grade	
Executive Swivel 	MA1500F · plain seat and back · upholstered arm cap · overall height range is 40 ½ - 44 · seat height range is 19 - 22 ½ · arm height range is 25 ½ - 29	Dimensions	D	W	H	COM	\$1,615
		Overall	25	26 ½	44	A	\$1,648
		Seat	18 ½	21 ½	22 ½	B	\$1,708
		Arm			29	COL/C	\$1,818
		Upholstery	Shipping			D	\$1,958
		COM Ydg	2 ½	Ctn Wt	58	E	\$2,098
		COL Sq Ft	45	Cu Ft	15	F	\$2,246
						G	\$2,457
						H	\$2,681
						I	\$3,032
				J	\$3,454		
				L1	\$2,499		
				L2	\$2,724		





Description	Model	Specifications				List Price Per Grade	
Executive Swivel with Trim Nails 	MA1500J · plain seat and back · upholstered arm cap · Antique Brass trim nails · overall height range is 40 ½ - 44 · seat height range is 19 - 22 ½ · arm height range is 25 ½ - 29	Dimensions	D	W	H	COM	\$1,768
		Overall	25	26 ½	44	A	\$1,800
		Seat	18 ½	21 ½	22 ½	B	\$1,861
		Arm			29	COL/C	\$1,972
		Upholstery	Shipping			D	\$2,110
		COM Ydg	2 ½	Ctn Wt	58	E	\$2,249
		COL Sq Ft	45	Cu Ft	15	F	\$2,399
						G	\$2,610
						H	\$2,835
						I	\$3,184
				J	\$3,606		
				L1	\$2,651		
				L2	\$2,879		

To Order, Specify:

- 1 Model Number
- 2 Wood Species - Maple (M)
- 3 Wood Base/Arm Detail Finish [See Wood Base/Arm Detail Finish Options](#)
- 4 Fabric Selection - vendor, pattern and color
 Visit www.jsifurniture.com/finishes-and-materials/textiles for our textiles program.
 See selection of standard and graded in manufacturers and patterns.
- 5 Optional Black Jury Base - add \$203 list; wood base standard (self-centering manual available - specify when ordering)
- 6 Optional Knee-Tilt - add \$139 list
- 7 Optional Black Antique Trim Nails - replaces standard antique brass - no upcharge
- 8 Optional Plastic Bumper Guard - add \$25 list

Specifications

- Wood species - Maple.
- Seat has synthetic sheet webbing and 3" polyurethane foam.
- Back has polypropylene webbing and 2" polyurethane foam.
- Arms have 1 ½" polyurethane foam.
- Swivels revolve, tilt, a wood base with antique brass hood over dual wheel casters and a pneumatic lift.
- Mortise and tenon construction with corner blocks, glue and screws.

Description	① Model	Specifications	List Price Per Grade																																										
Executive Swivel 	MA1530F · plain seat and back · upholstered arm rest · overall height range is 40½ - 44 · seat height range is 19 - 22½ · arm height range is 25½ - 29	<table border="1"> <thead> <tr> <th>Dimensions</th> <th>D</th> <th>W</th> <th>H</th> </tr> </thead> <tbody> <tr> <td>Overall</td> <td>25</td> <td>26½</td> <td>44</td> </tr> <tr> <td>Seat</td> <td>18½</td> <td>21½</td> <td>22½</td> </tr> <tr> <td>Arm</td> <td></td> <td></td> <td>29</td> </tr> </tbody> </table>	Dimensions	D	W	H	Overall	25	26½	44	Seat	18½	21½	22½	Arm			29	<table border="1"> <tbody> <tr><td>COM</td><td>\$1,763</td></tr> <tr><td>A</td><td>\$1,791</td></tr> <tr><td>B</td><td>\$1,856</td></tr> <tr><td>COL/C</td><td>\$1,966</td></tr> <tr><td>D</td><td>\$2,105</td></tr> <tr><td>E</td><td>\$2,244</td></tr> <tr><td>F</td><td>\$2,392</td></tr> <tr><td>G</td><td>\$2,605</td></tr> <tr><td>H</td><td>\$2,827</td></tr> <tr><td>I</td><td>\$3,179</td></tr> <tr><td>J</td><td>\$3,600</td></tr> <tr><td>L1</td><td>\$2,645</td></tr> <tr><td>L2</td><td>\$2,870</td></tr> </tbody> </table>	COM	\$1,763	A	\$1,791	B	\$1,856	COL/C	\$1,966	D	\$2,105	E	\$2,244	F	\$2,392	G	\$2,605	H	\$2,827	I	\$3,179	J	\$3,600	L1	\$2,645	L2	\$2,870
		Dimensions	D	W	H																																								
Overall	25	26½	44																																										
Seat	18½	21½	22½																																										
Arm			29																																										
COM	\$1,763																																												
A	\$1,791																																												
B	\$1,856																																												
COL/C	\$1,966																																												
D	\$2,105																																												
E	\$2,244																																												
F	\$2,392																																												
G	\$2,605																																												
H	\$2,827																																												
I	\$3,179																																												
J	\$3,600																																												
L1	\$2,645																																												
L2	\$2,870																																												
<table border="1"> <thead> <tr> <th>Upholstery</th> <th colspan="2">Shipping</th> </tr> </thead> <tbody> <tr> <td>COM Ydg</td> <td>2½</td> <td>Ctn Wt 58</td> </tr> <tr> <td>COL Sq Ft</td> <td>45</td> <td>Cu Ft 15</td> </tr> </tbody> </table>		Upholstery	Shipping		COM Ydg	2½	Ctn Wt 58	COL Sq Ft	45	Cu Ft 15																																			
Upholstery	Shipping																																												
COM Ydg	2½	Ctn Wt 58																																											
COL Sq Ft	45	Cu Ft 15																																											
Executive Swivel with Trim Nails 	MA1530J · plain seat and back · Antique Brass trim nails · upholstered arm rest · overall height range is 40½ - 44 · seat height range is 19 - 22½ · arm height range is 25½ - 29	<table border="1"> <thead> <tr> <th>Dimensions</th> <th>D</th> <th>W</th> <th>H</th> </tr> </thead> <tbody> <tr> <td>Overall</td> <td>25</td> <td>26½</td> <td>44</td> </tr> <tr> <td>Seat</td> <td>18½</td> <td>21½</td> <td>22½</td> </tr> <tr> <td>Arm</td> <td></td> <td></td> <td>29</td> </tr> </tbody> </table>	Dimensions	D	W	H	Overall	25	26½	44	Seat	18½	21½	22½	Arm			29	<table border="1"> <tbody> <tr><td>COM</td><td>\$1,913</td></tr> <tr><td>A</td><td>\$1,945</td></tr> <tr><td>B</td><td>\$2,006</td></tr> <tr><td>COL/C</td><td>\$2,117</td></tr> <tr><td>D</td><td>\$2,257</td></tr> <tr><td>E</td><td>\$2,398</td></tr> <tr><td>F</td><td>\$2,545</td></tr> <tr><td>G</td><td>\$2,756</td></tr> <tr><td>H</td><td>\$2,979</td></tr> <tr><td>I</td><td>\$3,330</td></tr> <tr><td>J</td><td>\$3,752</td></tr> <tr><td>L1</td><td>\$2,798</td></tr> <tr><td>L2</td><td>\$3,023</td></tr> </tbody> </table>	COM	\$1,913	A	\$1,945	B	\$2,006	COL/C	\$2,117	D	\$2,257	E	\$2,398	F	\$2,545	G	\$2,756	H	\$2,979	I	\$3,330	J	\$3,752	L1	\$2,798	L2	\$3,023
		Dimensions	D	W	H																																								
Overall	25	26½	44																																										
Seat	18½	21½	22½																																										
Arm			29																																										
COM	\$1,913																																												
A	\$1,945																																												
B	\$2,006																																												
COL/C	\$2,117																																												
D	\$2,257																																												
E	\$2,398																																												
F	\$2,545																																												
G	\$2,756																																												
H	\$2,979																																												
I	\$3,330																																												
J	\$3,752																																												
L1	\$2,798																																												
L2	\$3,023																																												
<table border="1"> <thead> <tr> <th>Upholstery</th> <th colspan="2">Shipping</th> </tr> </thead> <tbody> <tr> <td>COM Ydg</td> <td>2½</td> <td>Ctn Wt 58</td> </tr> <tr> <td>COL Sq Ft</td> <td>45</td> <td>Cu Ft 15</td> </tr> </tbody> </table>		Upholstery	Shipping		COM Ydg	2½	Ctn Wt 58	COL Sq Ft	45	Cu Ft 15																																			
Upholstery	Shipping																																												
COM Ydg	2½	Ctn Wt 58																																											
COL Sq Ft	45	Cu Ft 15																																											
Executive Swivel 	MA1500G · fold tufted back · plain seat · upholstered arm cap · overall height range is 40½ - 44 · seat height range is 19 - 22½ · arm height range is 25½ - 29	<table border="1"> <thead> <tr> <th>Dimensions</th> <th>D</th> <th>W</th> <th>H</th> </tr> </thead> <tbody> <tr> <td>Overall</td> <td>25</td> <td>26½</td> <td>44</td> </tr> <tr> <td>Seat</td> <td>18½</td> <td>21½</td> <td>22½</td> </tr> <tr> <td>Arm</td> <td></td> <td></td> <td>29</td> </tr> </tbody> </table>	Dimensions	D	W	H	Overall	25	26½	44	Seat	18½	21½	22½	Arm			29	<table border="1"> <tbody> <tr><td>COM</td><td>\$1,782</td></tr> <tr><td>A</td><td>\$1,819</td></tr> <tr><td>B</td><td>\$1,894</td></tr> <tr><td>COL/C</td><td>\$2,027</td></tr> <tr><td>D</td><td>\$2,196</td></tr> <tr><td>E</td><td>\$2,362</td></tr> <tr><td>F</td><td>\$2,540</td></tr> <tr><td>G</td><td>\$2,794</td></tr> <tr><td>H</td><td>\$3,061</td></tr> <tr><td>I</td><td>\$3,482</td></tr> <tr><td>J</td><td>\$3,989</td></tr> <tr><td>L1</td><td>\$2,844</td></tr> <tr><td>L2</td><td>\$3,113</td></tr> </tbody> </table>	COM	\$1,782	A	\$1,819	B	\$1,894	COL/C	\$2,027	D	\$2,196	E	\$2,362	F	\$2,540	G	\$2,794	H	\$3,061	I	\$3,482	J	\$3,989	L1	\$2,844	L2	\$3,113
		Dimensions	D	W	H																																								
Overall	25	26½	44																																										
Seat	18½	21½	22½																																										
Arm			29																																										
COM	\$1,782																																												
A	\$1,819																																												
B	\$1,894																																												
COL/C	\$2,027																																												
D	\$2,196																																												
E	\$2,362																																												
F	\$2,540																																												
G	\$2,794																																												
H	\$3,061																																												
I	\$3,482																																												
J	\$3,989																																												
L1	\$2,844																																												
L2	\$3,113																																												
<table border="1"> <thead> <tr> <th>Upholstery</th> <th colspan="2">Shipping</th> </tr> </thead> <tbody> <tr> <td>COM Ydg</td> <td>3</td> <td>Ctn Wt 58</td> </tr> <tr> <td>COL Sq Ft</td> <td>54</td> <td>Cu Ft 15</td> </tr> </tbody> </table>		Upholstery	Shipping		COM Ydg	3	Ctn Wt 58	COL Sq Ft	54	Cu Ft 15																																			
Upholstery	Shipping																																												
COM Ydg	3	Ctn Wt 58																																											
COL Sq Ft	54	Cu Ft 15																																											
Executive Swivel with Trim Nails 	MA1500K · fold tufted back · plain seat · upholstered arm cap · Antique Brass trim nails · overall height range is 40½ - 44 · seat height range is 19 - 22½ · arm height range is 25½ - 29	<table border="1"> <thead> <tr> <th>Dimensions</th> <th>D</th> <th>W</th> <th>H</th> </tr> </thead> <tbody> <tr> <td>Overall</td> <td>25</td> <td>26½</td> <td>44</td> </tr> <tr> <td>Seat</td> <td>18½</td> <td>21½</td> <td>22½</td> </tr> <tr> <td>Arm</td> <td></td> <td></td> <td>29</td> </tr> </tbody> </table>	Dimensions	D	W	H	Overall	25	26½	44	Seat	18½	21½	22½	Arm			29	<table border="1"> <tbody> <tr><td>COM</td><td>\$1,910</td></tr> <tr><td>A</td><td>\$1,947</td></tr> <tr><td>B</td><td>\$2,022</td></tr> <tr><td>COL/C</td><td>\$2,154</td></tr> <tr><td>D</td><td>\$2,322</td></tr> <tr><td>E</td><td>\$2,491</td></tr> <tr><td>F</td><td>\$2,667</td></tr> <tr><td>G</td><td>\$2,920</td></tr> <tr><td>H</td><td>\$3,188</td></tr> <tr><td>I</td><td>\$3,611</td></tr> <tr><td>J</td><td>\$4,115</td></tr> <tr><td>L1</td><td>\$2,971</td></tr> <tr><td>L2</td><td>\$3,241</td></tr> </tbody> </table>	COM	\$1,910	A	\$1,947	B	\$2,022	COL/C	\$2,154	D	\$2,322	E	\$2,491	F	\$2,667	G	\$2,920	H	\$3,188	I	\$3,611	J	\$4,115	L1	\$2,971	L2	\$3,241
		Dimensions	D	W	H																																								
Overall	25	26½	44																																										
Seat	18½	21½	22½																																										
Arm			29																																										
COM	\$1,910																																												
A	\$1,947																																												
B	\$2,022																																												
COL/C	\$2,154																																												
D	\$2,322																																												
E	\$2,491																																												
F	\$2,667																																												
G	\$2,920																																												
H	\$3,188																																												
I	\$3,611																																												
J	\$4,115																																												
L1	\$2,971																																												
L2	\$3,241																																												
<table border="1"> <thead> <tr> <th>Upholstery</th> <th colspan="2">Shipping</th> </tr> </thead> <tbody> <tr> <td>COM Ydg</td> <td>3</td> <td>Ctn Wt 58</td> </tr> <tr> <td>COL Sq Ft</td> <td>54</td> <td>Cu Ft 15</td> </tr> </tbody> </table>		Upholstery	Shipping		COM Ydg	3	Ctn Wt 58	COL Sq Ft	54	Cu Ft 15																																			
Upholstery	Shipping																																												
COM Ydg	3	Ctn Wt 58																																											
COL Sq Ft	54	Cu Ft 15																																											

Description

1 Model

Specifications

List Price Per Grade

Executive Swivel



MA1530G

- fold tufted back
- plain seat
- upholstered arm rest
- overall height range is 40 ½ - 44
- seat height range is 19 - 22 ½
- arm height range is 25 ½ - 29

Dimensions	D	W	H
Overall	25	26 ½	44
Seat	18 ½	21 ½	22 ½
Arm	29		
Upholstery		Shipping	
COM Ydg	3	Ctn Wt	58
COL Sq Ft	54	Cu Ft	15

- COM \$1,929
- A \$1,967
- B \$2,041
- COL/C \$2,172
- D \$2,341
- E \$2,508
- F \$2,686
- G \$2,938
- H \$3,208
- I \$3,631
- J \$4,135
- L1 \$2,991
- L2 \$3,258

Executive Swivel with Trim Nails



MA1530K

- fold tufted back
- plain seat
- upholstered arm rest
- Antique Brass trim nails
- overall height range is 40 ½ - 44
- seat height range is 19 - 22 ½
- arm height range is 25 ½ - 29

Dimensions	D	W	H
Overall	25	26 ½	44
Seat	18 ½	21 ½	22 ½
Arm	29		
Upholstery		Shipping	
COM Ydg	3	Ctn Wt	58
COL Sq Ft	54	Cu Ft	15

- COM \$2,057
- A \$2,094
- B \$2,169
- COL/C \$2,302
- D \$2,468
- E \$2,638
- F \$2,814
- G \$3,067
- H \$3,335
- I \$3,757
- J \$4,262
- L1 \$3,118
- L2 \$3,387

To Order, Specify:

- 1 Model Number
- 2 Wood Species - Maple (M)
- 3 Wood Base/Arm Detail Finish [See Wood Base/Arm Detail Finish Options](#)
- 4 Fabric Selection - vendor, pattern and color
Visit www.jsifurniture.com/finishes-and-materials/textiles for our textiles program.
See selection of standard and graded in manufacturers and patterns.
- 5 Optional Black Jury Base - add \$203 list; wood base standard (self-centering manual available - specify when ordering)
- 6 Optional Knee-Tilt - add \$139 list
- 7 Optional Black Antique Trim Nails - replaces standard antique brass - no upcharge
- 8 Optional Plastic Bumper Guard - add \$25 list

Specifications

- Wood species - Maple.
- Seat has synthetic sheet webbing and 3" polyurethane foam.
- Back has polypropylene webbing and 2" polyurethane foam.
- Arms have 1 ½" polyurethane foam.
- Swivels revolve, tilt, a wood base with antique brass hood over dual wheel casters and a pneumatic lift.
- Mortise and tenon construction with corner blocks, glue and screws.

Madison Order Check List:



Specify:

- 1. Model Number
- 2. Wood Species - Maple (M)
- 3. Wood Leg/Arm Detail Finish
- 4. Fabric Selection - vendor, pattern and color
- 5. Optional Black Antique Trim Nails - no upcharge
(Replaces standard antique brass trim nails)
- 6. Optional Casters - add \$123 list; specify color
- 7. Optional Rubber Cushion Nylon Glides - no upcharge

Example:

MA1501F (model #)	M (wood species)	HRV (finish) wood leg/arm detail	MOMENTUM (fabric vendor)	VOX (pattern name)	MYSTIC (pattern color)
-----------------------------	----------------------------	---	------------------------------------	------------------------------	----------------------------------

1. Model Number

2. Wood Species - Maple (M)

3. Wood Leg/Arm Detail Finish Options:

ALM Ale Medium	HRV Harvest
CAL Ale Light Coordinate	CKC Khaki Coordinate
BBM Bourbon Medium	MINC Mineral Coordinate
CBZ Brazilwood Coordinate	MCH Mocha
BARC Barrel Coordinate	CPI Pinnacle Walnut Coordinate
CBO Bourbon Light Coordinate	PRL Praline
CBG Brighton Light Coordinate	RAVC Raven Coordinate
BRM Brighton Medium	SABC Sable Coordinate
BUT Butterscotch	SIE Sienna
CNDC Cinder Coordinate	CST Studio Teak Coordinate
CLA Classic	TRF Truffle
CLL Collectors	UMB Umber
EGRC Egret Coordinate	VALC Valley Coordinate
ESP Espresso	VEN Venetian
FAWC Fawn Coordinate	CWE Weathered Ash Coordinate
FLX Flax	
CGR Graphite Coordinate	

4. Fabric Selection - Please supply the following:
Fabric vendor/Pattern name/Pattern color

For a complete list of JSI Standard and Graded-In Textiles click here

When specifying contrasting upholstery, indicate clearly which upholstery is to be applied to the seat, back and arms. Use higher grade pricing.

- Indicate direction of fabric - Railroaded or Up the Roll
- Please provide illustration, if available

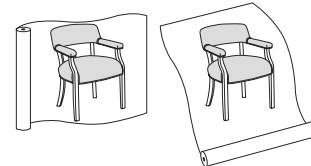
All COM orders must include the following:

- Vendor's name, pattern name and color
- Sample of the fabric attached to order
- Model numbers of items for fabric application
- Special application instructions (e.g., all stripes will be applied front to back unless specified otherwise)
- Customer and purchase order number

Ship prepaid COM material to:

JSI
Attn: COM Dept
201 East Martin Street
Receiving B, Dock 71
Orleans, IN 47452

Application of fabric:
Railroaded Up the Roll



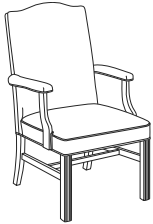
All COM orders will ship at standard lead time from receipt of COM except for orders requiring special custom matched finishes.

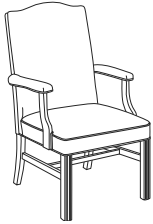
5. Optional Black Antique Trim Nails - no upcharge
(Replaces standard antique brass trim nails)

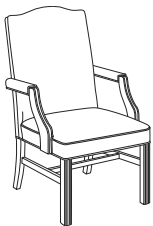
6. Optional Casters - add \$123 list; specify color.

- Color:**
- Black
 - Antique Brass

7. Optional Rubber Cushion Nylon Glides - no upcharge

Description	Model	Specifications			List Price Per Grade	
Guest Chair 	MA1501F · plain seat and back · upholstered arm cap	Dimensions	D	W	H	COM \$1,144
		Overall	27½	26½	40½	A \$1,177
		Seat	18½	21	18¾	B \$1,243
		Arm			25½	COL/C \$1,350
		Upholstery	Shipping			D \$1,492
		COM Ydg	2½	Ctn Wt	37	E \$1,629
		COL Sq Ft	45	Cu Ft	15	F \$1,778
						G \$1,989
						H \$2,212
						I \$2,564
				J \$2,984		
				L1 \$2,031		
				L2 \$2,255		

Description	Model	Specifications			List Price Per Grade	
Guest Chair with Trim Nails 	MA1501J · plain seat and back · upholstered arm cap · Antique Brass trim nails	Dimensions	D	W	H	COM \$1,292
		Overall	27½	26½	40½	A \$1,326
		Seat	18½	21	18¾	B \$1,387
		Arm			25½	COL/C \$1,498
		Upholstery	Shipping			D \$1,638
		COM Ydg	2½	Ctn Wt	37	E \$1,778
		COL Sq Ft	45	Cu Ft	15	F \$1,926
						G \$2,136
						H \$2,361
						I \$2,712
				J \$3,133		
				L1 \$2,180		
				L2 \$2,403		

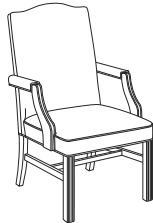
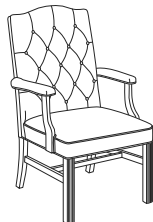

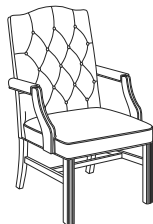
Description	Model	Specifications			List Price Per Grade	
Guest Chair 	MA1531F · plain seat and back · upholstered arm rest	Dimensions	D	W	H	COM \$1,318
		Overall	27½	26½	40½	A \$1,349
		Seat	18½	21	18¾	B \$1,411
		Arm			25½	COL/C \$1,521
		Upholstery	Shipping			D \$1,660
		COM Ydg	2½	Ctn Wt	37	E \$1,801
		COL Sq Ft	45	Cu Ft	15	F \$1,947
						G \$2,160
						H \$2,383
						I \$2,734
				J \$3,154		
				L1 \$2,200		
				L2 \$2,426		

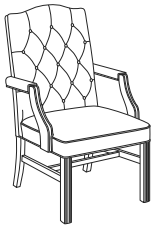
To Order, Specify:

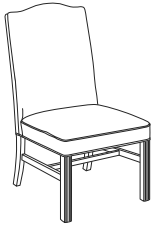
- 1 Model Number
- 2 Wood Species - Maple (M)
- 3 Wood Base/Arm Detail Finish See Wood Base/Arm Detail Finish Options
- 4 Fabric Selection - vendor, pattern and color
Visit www.jsifurniture.com/finishes-and-materials/textiles for our textiles program.
See selection of standard and graded in manufacturers and patterns.
- 5 Optional Black Antique Trim Nails - no upcharge
(Replaces standard antique brass trim nails)
- 6 Optional Casters - add \$123 list; specify color
- 7 Optional Rubber Cushion Nylon Glides - no upcharge

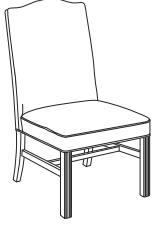
Specifications

- Wood species - Maple.
- Seat has synthetic sheet webbing and 3" polyurethane foam.
- Back has polypropylene webbing and 2" polyurethane foam.
- Arms have 1½" polyurethane foam.
- Mortise and tenon construction with corner blocks, glue and screws.
- Standard with rubber cushion metal glides.

Description	① Model	Specifications	List Price Per Grade																																										
Guest Chair with Trim Nails 	MA1531J · plain seat and back · upholstered arm rest · Antique Brass trim nails	<table border="1"> <thead> <tr> <th>Dimensions</th> <th>D</th> <th>W</th> <th>H</th> </tr> </thead> <tbody> <tr> <td>Overall</td> <td>27 ½</td> <td>26 ½</td> <td>40 ½</td> </tr> <tr> <td>Seat</td> <td>18 ½</td> <td>21</td> <td>18 ¾</td> </tr> <tr> <td>Arm</td> <td></td> <td></td> <td>25 ½</td> </tr> </tbody> </table>	Dimensions	D	W	H	Overall	27 ½	26 ½	40 ½	Seat	18 ½	21	18 ¾	Arm			25 ½	<table border="1"> <tbody> <tr><td>COM</td><td>\$1,464</td></tr> <tr><td>A</td><td>\$1,497</td></tr> <tr><td>B</td><td>\$1,560</td></tr> <tr><td>COL/C</td><td>\$1,668</td></tr> <tr><td>D</td><td>\$1,809</td></tr> <tr><td>E</td><td>\$1,947</td></tr> <tr><td>F</td><td>\$2,095</td></tr> <tr><td>G</td><td>\$2,308</td></tr> <tr><td>H</td><td>\$2,530</td></tr> <tr><td>I</td><td>\$2,883</td></tr> <tr><td>J</td><td>\$3,300</td></tr> <tr><td>L1</td><td>\$2,348</td></tr> <tr><td>L2</td><td>\$2,573</td></tr> </tbody> </table>	COM	\$1,464	A	\$1,497	B	\$1,560	COL/C	\$1,668	D	\$1,809	E	\$1,947	F	\$2,095	G	\$2,308	H	\$2,530	I	\$2,883	J	\$3,300	L1	\$2,348	L2	\$2,573
		Dimensions	D	W	H																																								
Overall	27 ½	26 ½	40 ½																																										
Seat	18 ½	21	18 ¾																																										
Arm			25 ½																																										
COM	\$1,464																																												
A	\$1,497																																												
B	\$1,560																																												
COL/C	\$1,668																																												
D	\$1,809																																												
E	\$1,947																																												
F	\$2,095																																												
G	\$2,308																																												
H	\$2,530																																												
I	\$2,883																																												
J	\$3,300																																												
L1	\$2,348																																												
L2	\$2,573																																												
<table border="1"> <thead> <tr> <th>Upholstery</th> <th colspan="2">Shipping</th> </tr> </thead> <tbody> <tr> <td>COM Ydg</td> <td>2 ½</td> <td>Ctn Wt 37</td> </tr> <tr> <td>COL Sq Ft</td> <td>45</td> <td>Cu Ft 15</td> </tr> </tbody> </table>		Upholstery	Shipping		COM Ydg	2 ½	Ctn Wt 37	COL Sq Ft	45	Cu Ft 15																																			
Upholstery	Shipping																																												
COM Ydg	2 ½	Ctn Wt 37																																											
COL Sq Ft	45	Cu Ft 15																																											
Guest Chair 	MA1501G · fold tufted back · plain seat · upholstered arm cap	<table border="1"> <thead> <tr> <th>Dimensions</th> <th>D</th> <th>W</th> <th>H</th> </tr> </thead> <tbody> <tr> <td>Overall</td> <td>27 ½</td> <td>26 ½</td> <td>40 ½</td> </tr> <tr> <td>Seat</td> <td>18 ½</td> <td>21</td> <td>18 ¾</td> </tr> <tr> <td>Arm</td> <td></td> <td></td> <td>25 ½</td> </tr> </tbody> </table>	Dimensions	D	W	H	Overall	27 ½	26 ½	40 ½	Seat	18 ½	21	18 ¾	Arm			25 ½	<table border="1"> <tbody> <tr><td>COM</td><td>\$1,318</td></tr> <tr><td>A</td><td>\$1,355</td></tr> <tr><td>B</td><td>\$1,429</td></tr> <tr><td>COL/C</td><td>\$1,561</td></tr> <tr><td>D</td><td>\$1,731</td></tr> <tr><td>E</td><td>\$1,897</td></tr> <tr><td>F</td><td>\$2,075</td></tr> <tr><td>G</td><td>\$2,326</td></tr> <tr><td>H</td><td>\$2,596</td></tr> <tr><td>I</td><td>\$3,015</td></tr> <tr><td>J</td><td>\$3,522</td></tr> <tr><td>L1</td><td>\$2,377</td></tr> <tr><td>L2</td><td>\$2,646</td></tr> </tbody> </table>	COM	\$1,318	A	\$1,355	B	\$1,429	COL/C	\$1,561	D	\$1,731	E	\$1,897	F	\$2,075	G	\$2,326	H	\$2,596	I	\$3,015	J	\$3,522	L1	\$2,377	L2	\$2,646
		Dimensions	D	W	H																																								
Overall	27 ½	26 ½	40 ½																																										
Seat	18 ½	21	18 ¾																																										
Arm			25 ½																																										
COM	\$1,318																																												
A	\$1,355																																												
B	\$1,429																																												
COL/C	\$1,561																																												
D	\$1,731																																												
E	\$1,897																																												
F	\$2,075																																												
G	\$2,326																																												
H	\$2,596																																												
I	\$3,015																																												
J	\$3,522																																												
L1	\$2,377																																												
L2	\$2,646																																												
<table border="1"> <thead> <tr> <th>Upholstery</th> <th colspan="2">Shipping</th> </tr> </thead> <tbody> <tr> <td>COM Ydg</td> <td>3</td> <td>Ctn Wt 37</td> </tr> <tr> <td>COL Sq Ft</td> <td>54</td> <td>Cu Ft 15</td> </tr> </tbody> </table>		Upholstery	Shipping		COM Ydg	3	Ctn Wt 37	COL Sq Ft	54	Cu Ft 15																																			
Upholstery	Shipping																																												
COM Ydg	3	Ctn Wt 37																																											
COL Sq Ft	54	Cu Ft 15																																											
Guest Chair with Trim Nails 	MA1501K · fold tufted back · plain seat · upholstered arm cap · Antique Brass trim nails	<table border="1"> <thead> <tr> <th>Dimensions</th> <th>D</th> <th>W</th> <th>H</th> </tr> </thead> <tbody> <tr> <td>Overall</td> <td>27 ½</td> <td>26 ½</td> <td>40 ½</td> </tr> <tr> <td>Seat</td> <td>18 ½</td> <td>21</td> <td>18 ¾</td> </tr> <tr> <td>Arm</td> <td></td> <td></td> <td>25 ½</td> </tr> </tbody> </table>	Dimensions	D	W	H	Overall	27 ½	26 ½	40 ½	Seat	18 ½	21	18 ¾	Arm			25 ½	<table border="1"> <tbody> <tr><td>COM</td><td>\$1,448</td></tr> <tr><td>A</td><td>\$1,486</td></tr> <tr><td>B</td><td>\$1,561</td></tr> <tr><td>COL/C</td><td>\$1,693</td></tr> <tr><td>D</td><td>\$1,860</td></tr> <tr><td>E</td><td>\$2,028</td></tr> <tr><td>F</td><td>\$2,206</td></tr> <tr><td>G</td><td>\$2,458</td></tr> <tr><td>H</td><td>\$2,726</td></tr> <tr><td>I</td><td>\$3,148</td></tr> <tr><td>J</td><td>\$3,654</td></tr> <tr><td>L1</td><td>\$2,508</td></tr> <tr><td>L2</td><td>\$2,778</td></tr> </tbody> </table>	COM	\$1,448	A	\$1,486	B	\$1,561	COL/C	\$1,693	D	\$1,860	E	\$2,028	F	\$2,206	G	\$2,458	H	\$2,726	I	\$3,148	J	\$3,654	L1	\$2,508	L2	\$2,778
		Dimensions	D	W	H																																								
Overall	27 ½	26 ½	40 ½																																										
Seat	18 ½	21	18 ¾																																										
Arm			25 ½																																										
COM	\$1,448																																												
A	\$1,486																																												
B	\$1,561																																												
COL/C	\$1,693																																												
D	\$1,860																																												
E	\$2,028																																												
F	\$2,206																																												
G	\$2,458																																												
H	\$2,726																																												
I	\$3,148																																												
J	\$3,654																																												
L1	\$2,508																																												
L2	\$2,778																																												
<table border="1"> <thead> <tr> <th>Upholstery</th> <th colspan="2">Shipping</th> </tr> </thead> <tbody> <tr> <td>COM Ydg</td> <td>3</td> <td>Ctn Wt 37</td> </tr> <tr> <td>COL Sq Ft</td> <td>54</td> <td>Cu Ft 15</td> </tr> </tbody> </table>		Upholstery	Shipping		COM Ydg	3	Ctn Wt 37	COL Sq Ft	54	Cu Ft 15																																			
Upholstery	Shipping																																												
COM Ydg	3	Ctn Wt 37																																											
COL Sq Ft	54	Cu Ft 15																																											
Guest Chair 	MA1531G · fold tufted back · plain seat · upholstered arm rest	<table border="1"> <thead> <tr> <th>Dimensions</th> <th>D</th> <th>W</th> <th>H</th> </tr> </thead> <tbody> <tr> <td>Overall</td> <td>27 ½</td> <td>26 ½</td> <td>40 ½</td> </tr> <tr> <td>Seat</td> <td>18 ½</td> <td>21</td> <td>18 ¾</td> </tr> <tr> <td>Arm</td> <td></td> <td></td> <td>25 ½</td> </tr> </tbody> </table>	Dimensions	D	W	H	Overall	27 ½	26 ½	40 ½	Seat	18 ½	21	18 ¾	Arm			25 ½	<table border="1"> <tbody> <tr><td>COM</td><td>\$1,489</td></tr> <tr><td>A</td><td>\$1,524</td></tr> <tr><td>B</td><td>\$1,601</td></tr> <tr><td>COL/C</td><td>\$1,732</td></tr> <tr><td>D</td><td>\$1,899</td></tr> <tr><td>E</td><td>\$2,068</td></tr> <tr><td>F</td><td>\$2,244</td></tr> <tr><td>G</td><td>\$2,497</td></tr> <tr><td>H</td><td>\$2,765</td></tr> <tr><td>I</td><td>\$3,187</td></tr> <tr><td>J</td><td>\$3,692</td></tr> <tr><td>L1</td><td>\$2,547</td></tr> <tr><td>L2</td><td>\$2,816</td></tr> </tbody> </table>	COM	\$1,489	A	\$1,524	B	\$1,601	COL/C	\$1,732	D	\$1,899	E	\$2,068	F	\$2,244	G	\$2,497	H	\$2,765	I	\$3,187	J	\$3,692	L1	\$2,547	L2	\$2,816
		Dimensions	D	W	H																																								
Overall	27 ½	26 ½	40 ½																																										
Seat	18 ½	21	18 ¾																																										
Arm			25 ½																																										
COM	\$1,489																																												
A	\$1,524																																												
B	\$1,601																																												
COL/C	\$1,732																																												
D	\$1,899																																												
E	\$2,068																																												
F	\$2,244																																												
G	\$2,497																																												
H	\$2,765																																												
I	\$3,187																																												
J	\$3,692																																												
L1	\$2,547																																												
L2	\$2,816																																												
<table border="1"> <thead> <tr> <th>Upholstery</th> <th colspan="2">Shipping</th> </tr> </thead> <tbody> <tr> <td>COM Ydg</td> <td>3</td> <td>Ctn Wt 37</td> </tr> <tr> <td>COL Sq Ft</td> <td>54</td> <td>Cu Ft 15</td> </tr> </tbody> </table>		Upholstery	Shipping		COM Ydg	3	Ctn Wt 37	COL Sq Ft	54	Cu Ft 15																																			
Upholstery	Shipping																																												
COM Ydg	3	Ctn Wt 37																																											
COL Sq Ft	54	Cu Ft 15																																											

Description	① Model	Specifications				List Price Per Grade	
Guest Chair with Trim Nails 	MA1531K · fold tufted back · plain seat · upholstered arm rest · Antique Brass trim nails	Dimensions	D	W	H	COM	\$1,617
		Overall	27½	26½	40½	A	\$1,656
		Seat	18½	21	18¾	B	\$1,732
		Arm			25½	COL/C	\$1,861
		Upholstery	Shipping		D	\$2,031	
		COM Ydg	3	Ctn Wt	37	E	\$2,198
		COL Sq Ft	54	Cu Ft	15	F	\$2,376
						G	\$2,629
						H	\$2,895
						I	\$3,318
				J	\$3,823		
				L1	\$2,679		
				L2	\$2,948		

Description	① Model	Specifications				List Price Per Grade	
Guest Chair 	MA1533F · plain seat and back · armless	Dimensions	D	W	H	COM	\$1,099
		Overall	27½	20½	40½	A	\$1,125
		Seat	18½	21	18¾	B	\$1,167
		Upholstery	Shipping		COL/C	\$1,244	
		COM Ydg	2½	Ctn Wt	34	D	\$1,341
		COL Sq Ft	50	Cu Ft	15	E	\$1,440
						F	\$1,543
						G	\$1,689
						H	\$1,848
						I	\$2,093
				J	\$2,386		
				L1	\$1,718		
				L2	\$1,878		





Description	① Model	Specifications				List Price Per Grade	
Guest Chair with Trim Nails 	MA1533J · plain seat and back · armless · Antique Brass trim nails	Dimensions	D	W	H	COM	\$1,248
		Overall	27½	20½	40½	A	\$1,269
		Seat	18½	21	18¾	B	\$1,314
		Upholstery	Shipping		COL/C	\$1,388	
		COM Ydg	2½	Ctn Wt	34	D	\$1,490
		COL Sq Ft	50	Cu Ft	15	E	\$1,587
						F	\$1,692
						G	\$1,838
						H	\$1,996
						I	\$2,241
				J	\$2,532		
				L1	\$1,864		
				L2	\$2,022		

To Order, Specify:

- ① Model Number
- ② Wood Species - Maple (M)
- ③ Wood Base/Arm Detail Finish [See Wood Base/Arm Detail Finish Options](#)
- ④ Fabric Selection - vendor, pattern and color
 Visit www.jsifurniture.com/finishes-and-materials/textiles for our textiles program.
 See selection of standard and graded in manufacturers and patterns.
- ⑤ Optional Black Antique Trim Nails - no upcharge
 (Replaces standard antique brass trim nails)
- ⑥ Optional Casters - add \$123 list; specify color
- ⑦ Optional Rubber Cushion Nylon Glides - no upcharge

Specifications

- Wood species - Maple.
- Seat has synthetic sheet webbing and 3" polyurethane foam.
- Back has polypropylene webbing and 2" polyurethane foam.
- Arms have 1½" polyurethane foam.
- Mortise and tenon construction with corner blocks, glue and screws.
- Standard with rubber cushion metal glides.

Description	① Model	Specifications	List Price Per Grade																												
Guest Chair 	MA1533G · fold tufted back · plain seat · armless	<table border="1"> <thead> <tr> <th>Dimensions</th> <th>D</th> <th>W</th> <th>H</th> </tr> </thead> <tbody> <tr> <td>Overall</td> <td>27 ½</td> <td>20 ½</td> <td>40 ½</td> </tr> <tr> <td>Seat</td> <td>18 ½</td> <td>21</td> <td>18 ¾</td> </tr> <tr> <th colspan="2">Upholstery</th> <th colspan="2">Shipping</th> </tr> <tr> <td>COM Ydg</td> <td>3</td> <td>Ctn Wt</td> <td>34</td> </tr> <tr> <td>COL Sq Ft</td> <td>60</td> <td>Cu Ft</td> <td>15</td> </tr> </tbody> </table>	Dimensions	D	W	H	Overall	27 ½	20 ½	40 ½	Seat	18 ½	21	18 ¾	Upholstery		Shipping		COM Ydg	3	Ctn Wt	34	COL Sq Ft	60	Cu Ft	15	COM \$1,269 A \$1,298 B \$1,355 COL/C \$1,455 D \$1,580 E \$1,705 F \$1,840 G \$2,028 H \$2,229 I \$2,546 J \$2,925 L1 \$2,066 L2 \$2,269				
		Dimensions	D	W	H																										
Overall	27 ½	20 ½	40 ½																												
Seat	18 ½	21	18 ¾																												
Upholstery		Shipping																													
COM Ydg	3	Ctn Wt	34																												
COL Sq Ft	60	Cu Ft	15																												
Guest Chair with Trim Nails 	MA1533K · fold tufted back · plain seat · armless · Antique Brass trim nails	<table border="1"> <thead> <tr> <th>Dimensions</th> <th>D</th> <th>W</th> <th>H</th> </tr> </thead> <tbody> <tr> <td>Overall</td> <td>27 ½</td> <td>20 ½</td> <td>40 ½</td> </tr> <tr> <td>Seat</td> <td>18 ½</td> <td>21</td> <td>18 ¾</td> </tr> <tr> <th colspan="2">Upholstery</th> <th colspan="2">Shipping</th> </tr> <tr> <td>COM Ydg</td> <td>3</td> <td>Ctn Wt</td> <td>34</td> </tr> <tr> <td>COL Sq Ft</td> <td>60</td> <td>Cu Ft</td> <td>15</td> </tr> </tbody> </table>	Dimensions	D	W	H	Overall	27 ½	20 ½	40 ½	Seat	18 ½	21	18 ¾	Upholstery		Shipping		COM Ydg	3	Ctn Wt	34	COL Sq Ft	60	Cu Ft	15	COM \$1,402 A \$1,429 B \$1,486 COL/C \$1,586 D \$1,709 E \$1,838 F \$1,972 G \$2,160 H \$2,361 I \$2,678 J \$3,056 L1 \$2,197 L2 \$2,399				
		Dimensions	D	W	H																										
Overall	27 ½	20 ½	40 ½																												
Seat	18 ½	21	18 ¾																												
Upholstery		Shipping																													
COM Ydg	3	Ctn Wt	34																												
COL Sq Ft	60	Cu Ft	15																												
Guest Chair 	MA1561F · plain seat and back	<table border="1"> <thead> <tr> <th>Dimensions</th> <th>D</th> <th>W</th> <th>H</th> </tr> </thead> <tbody> <tr> <td>Overall</td> <td>25 ¼</td> <td>24 ½</td> <td>30</td> </tr> <tr> <td>Seat</td> <td>20 ¼</td> <td>18 ¼</td> <td>19</td> </tr> <tr> <td>Arm</td> <td></td> <td></td> <td>25</td> </tr> <tr> <th colspan="2">Upholstery</th> <th colspan="2">Shipping</th> </tr> <tr> <td>COM Ydg</td> <td>2</td> <td>Ctn Wt</td> <td>32</td> </tr> <tr> <td>COL Sq Ft</td> <td>36</td> <td>Cu Ft</td> <td>14</td> </tr> </tbody> </table>	Dimensions	D	W	H	Overall	25 ¼	24 ½	30	Seat	20 ¼	18 ¼	19	Arm			25	Upholstery		Shipping		COM Ydg	2	Ctn Wt	32	COL Sq Ft	36	Cu Ft	14	COM \$883 A \$906 B \$955 COL/C \$1,045 D \$1,159 E \$1,268 F \$1,386 G \$1,555 H \$1,736 I \$2,017 J \$2,353 L1 \$1,589 L2 \$1,769
		Dimensions	D	W	H																										
Overall	25 ¼	24 ½	30																												
Seat	20 ¼	18 ¼	19																												
Arm			25																												
Upholstery		Shipping																													
COM Ydg	2	Ctn Wt	32																												
COL Sq Ft	36	Cu Ft	14																												
Guest Chair with Trim Nails 	MA1561J · plain seat and back · Antique Brass trim nails	<table border="1"> <thead> <tr> <th>Dimensions</th> <th>D</th> <th>W</th> <th>H</th> </tr> </thead> <tbody> <tr> <td>Overall</td> <td>25 ¼</td> <td>24 ½</td> <td>30</td> </tr> <tr> <td>Seat</td> <td>20 ¼</td> <td>18 ¼</td> <td>19</td> </tr> <tr> <td>Arm</td> <td></td> <td></td> <td>25</td> </tr> <tr> <th colspan="2">Upholstery</th> <th colspan="2">Shipping</th> </tr> <tr> <td>COM Ydg</td> <td>2</td> <td>Ctn Wt</td> <td>32</td> </tr> <tr> <td>COL Sq Ft</td> <td>36</td> <td>Cu Ft</td> <td>14</td> </tr> </tbody> </table>	Dimensions	D	W	H	Overall	25 ¼	24 ½	30	Seat	20 ¼	18 ¼	19	Arm			25	Upholstery		Shipping		COM Ydg	2	Ctn Wt	32	COL Sq Ft	36	Cu Ft	14	COM \$957 A \$984 B \$1,035 COL/C \$1,124 D \$1,234 E \$1,345 F \$1,464 G \$1,631 H \$1,811 I \$2,093 J \$2,428 L1 \$1,665 L2 \$1,847
		Dimensions	D	W	H																										
Overall	25 ¼	24 ½	30																												
Seat	20 ¼	18 ¼	19																												
Arm			25																												
Upholstery		Shipping																													
COM Ydg	2	Ctn Wt	32																												
COL Sq Ft	36	Cu Ft	14																												

Description

1 Model

Specifications

List Price Per Grade

Guest Chair



MA1563F

- plain seat and back
- Antique Brass casters

Dimensions	D	W	H
Overall	25 ¼	24 ½	30
Seat	20 ¼	18 ¼	19
Arm			25
Upholstery		Shipping	
COM Ydg	2	Ctn Wt	34
COL Sq Ft	36	Cu Ft	14

COM	\$1,025
A	\$1,053
B	\$1,102
COL/C	\$1,192
D	\$1,305
E	\$1,415
F	\$1,534
G	\$1,701
H	\$1,882
I	\$2,162
J	\$2,497
L1	\$1,737
L2	\$1,915

Guest Chair with Trim Nails



MA1563J

- plain seat and back
- Antique Brass casters
- Antique Brass trim nails

Dimensions	D	W	H
Overall	25 ¼	24 ½	30
Seat	20 ¼	18 ¼	19
Arm			25
Upholstery		Shipping	
COM Ydg	2	Ctn Wt	34
COL Sq Ft	36	Cu Ft	14

COM	\$1,104
A	\$1,130
B	\$1,178
COL/C	\$1,267
D	\$1,380
E	\$1,493
F	\$1,611
G	\$1,778
H	\$1,957
I	\$2,240
J	\$2,574
L1	\$1,812
L2	\$1,991

To Order, Specify:

- 1 Model Number
- 2 Wood Species - Maple (M)
- 3 Wood Base/Arm Detail Finish See Wood Base/Arm Detail Finish Options
- 4 Fabric Selection - vendor, pattern and color
Visit www.jsifurniture.com/finishes-and-materials/textiles for our textiles program.
See selection of standard and graded in manufacturers and patterns.
- 5 Optional Black Antique Trim Nails - no upcharge
(Replaces standard antique brass trim nails)
- 6 Optional Casters - add \$123 list; specify color
- 7 Optional Rubber Cushion Nylon Glides - no upcharge

Specifications

- Wood species - Maple.
- Seat has synthetic sheet webbing and 3" polyurethane foam.
- Back has polypropylene webbing and 2" polyurethane foam.
- Arms have 1 ½" polyurethane foam.
- Mortise and tenon construction with corner blocks, glue and screws.
- Standard with rubber cushion metal glides.

Melrose Order Check List:



Specify:

- 1. Model Number
- 2. Wood Species - Red Oak (RO) or Maple (M)
- 3. Wood Finish/Paint Color
- 4. Fabric Selection - vendor, pattern and color
- 5. Optional FRONT LEG Casters - add \$66 list; specify seat height
NOT AVAILABLE on BARSTOOLS
- 6. Optional Rubber Cushion Nylon Glides - no upcharge

Example:

383FC | **RO** | **HEN** | **MOMENTUM** | **VOX** | **MYSTIC**
 (model #) | (wood species) | (finish) | (fabric vendor) | (pattern name) | (pattern color)

1. Model Number

4. Fabric Selection - Please supply the following:
 Fabric vendor/Pattern name/Pattern color

2. Wood Species - Red Oak (RO) or Maple (M)

[For a complete list of JSI Standard and Graded-In Textiles click here](#)

3. Wood Finish/Color Options:

All COM orders must include the following:

Red Oak

BRW	Brownie	ECU	Ecu
CAN	Canyon	HEN	Henna
CIT	Citron	HNY	Honey
DES	Desert	NUT	Nut Brown

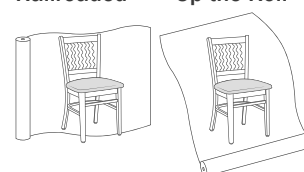
- Vendor's name, pattern name and color
- Sample of the fabric attached to order
- Model numbers of items for fabric application
- Special application instructions (e.g., all stripes will be applied front to back unless specified otherwise)
- Customer and purchase order number

Maple

ALM	Ale Medium	HRV	Harvest
CAL	Ale Light Coordinate	CKC	Khaki Coordinate
BBM	Bourbon Medium	MINC	Mineral Coordinate
CBZ	Brazilwood Coordinate	MCH	Mocha
BARC	Barrel Coordinate	CPI	Pinnacle Walnut Coordinate
CBO	Bourbon Light Coordinate	PRL	Praline
CBG	Brighton Light Coordinate	RAVC	Raven Coordinate
BRM	Brighton Medium	SABC	Sable Coordinate
BUT	Butterscotch	SIE	Sienna
CNDC	Cinder Coordinate	CST	Studio Teak Coordinate
CLA	Classic	TRF	Truffle
CLL	Collectors	UMB	Umber
EGRC	Egret Coordinate	VALC	Valley Coordinate
ESP	Espresso	VEN	Venetian
FAWC	Fawn Coordinate	CWE	Weathered Ash Coordinate
FLX	Flax		
CGR	Graphite Coordinate		

Ship prepaid COM material to:
 JSI
 Attn: COM Dept
 201 East Martin Street
 Receiving B, Dock 71
 Orleans, IN 47452

Application of fabric:
 Railroaded Up the Roll



All COM orders will ship at standard lead time from receipt of COM except for orders requiring special custom matched finishes.

Paint Color - Add \$45 list per item

BKD	Backdrop	GRV	Greek Villa
BFX	Black Fox	GLF	Gulf Stream
BWH	Bright White	HTB	Heartthrob
CGP	Cargo Pants	NET	Network Gray
CHT	Chatroom	NWH	Nonchalant White
DSY	Daisy	PAR	Paradise
DRG	Daring	QXP	Quixotic Plum
DYN	Dynamo	RBZ	Relic Bronze
ENG	Enigma	SND	Sandbank
FRR	French Roast	STM	Storm
GBY	Georgian Bay	TRC	Tricorn Black

Description

1 Model

Specifications

List Price Per Grade

Armless



383GA
all wood



383GC
uph. seat

- 383GA All Wood**
383GC Uph. Seat
- horizontal slat back
 - optional front leg casters available - add \$66 list for set of 2 casters

Dimensions	D	W	H
Overall	19 1/2	18 1/4	35
Seat	16	18 1/4	18 1/4
Upholstery		Shipping	
COM Ydg	3/4	Ctn Wt	28
COL Sq Ft	9	Cu Ft	9

- All Wood \$528
- COM \$586
- A \$604
- B \$624
- COL/C \$660
- D \$704
- E \$749
- F \$797
- G \$863
- H \$935
- I \$1,048
- J \$1,182
- L1 \$879
- L2 \$949

47" h Barstool

- 388GA All Wood**
388GC Uph. Seat
- horizontal slat back
 - casters not available
 - standard with brass scuff plate, also available in polished aluminum or matte black



388GA
all wood



388GC
uph. seat

Dimensions	D	W	H
Overall	19 1/2	18 1/4	47
Seat	16	18 1/4	30
Upholstery		Shipping	
COM Ydg	3/4	Ctn Wt	30
COL Sq Ft	9	Cu Ft	13





- All Wood \$620
- COM \$674
- A \$697
- B \$716
- COL/C \$752
- D \$794
- E \$840
- F \$887
- G \$954
- H \$1,027
- I \$1,140
- J \$1,272
- L1 \$970
- L2 \$1,042

To Order, Specify:


- 1 Model Number
- 2 Wood Species - Red Oak (RO) or Maple (M)
- 3 Wood Finish/Color See [Wood Finish/Color Options](#)
- 4 Fabric Selection - vendor, pattern and color
 Visit www.jsifurniture.com/finishes-and-materials/textiles for our textiles program. See selection of standard and graded in manufacturers and patterns.
- 5 Optional FRONT LEG Casters - add \$66 list; specify seat height.
NOT AVAILABLE on BARSTOOLS
- 6 Optional Rubber Cushion Nylon Glides - no upcharge


Specifications

- Wood species - Red Oak or Maple.
- Seat is upholstered with 1 1/2" high density polyurethane foam.
- Mortise and tenon construction with corner blocks, glue and screws.
- Standard with rubber cushion metal glides.

Description	Model	Specifications	List Price Per Grade												
Armless 	383HB Uph. Back/Wood Seat · optional front leg casters available - add \$66 list for set of 2 casters · when using contrasting upholstery, indicate application and use higher grade pricing	<table border="1"> <thead> <tr> <th>Dimensions</th> <th>D</th> <th>W</th> <th>H</th> </tr> </thead> <tbody> <tr> <td>Overall</td> <td>19 ½</td> <td>18 ¼</td> <td>35</td> </tr> <tr> <td>Seat</td> <td>16</td> <td>18 ¼</td> <td>18 ¼</td> </tr> </tbody> </table>	Dimensions	D	W	H	Overall	19 ½	18 ¼	35	Seat	16	18 ¼	18 ¼	COM \$612 A \$628 B \$643 COL/C \$665 D \$697 E \$725 F \$756 G \$803 H \$850 I \$924 J \$1,013 L1 \$811 L2 \$859
		Dimensions	D	W	H										
Overall	19 ½	18 ¼	35												
Seat	16	18 ¼	18 ¼												
<table border="1"> <thead> <tr> <th>Upholstery</th> <th colspan="3">Shipping</th> </tr> </thead> <tbody> <tr> <td>COM Ydg</td> <td>½</td> <td>Ctn Wt</td> <td>28</td> </tr> <tr> <td>COL Sq Ft</td> <td>6</td> <td>Cu Ft</td> <td>9</td> </tr> </tbody> </table>	Upholstery	Shipping			COM Ydg	½	Ctn Wt	28	COL Sq Ft	6	Cu Ft	9			
Upholstery	Shipping														
COM Ydg	½	Ctn Wt	28												
COL Sq Ft	6	Cu Ft	9												
Armless 	383HD Uph. Seat/Back · optional front leg casters available - add \$66 list for set of 2 casters · back is upholstered with ¾ of high density polyurethane · when using contrasting upholstery, indicate application and use higher grade pricing	<table border="1"> <thead> <tr> <th>Dimensions</th> <th>D</th> <th>W</th> <th>H</th> </tr> </thead> <tbody> <tr> <td>Overall</td> <td>19 ½</td> <td>18 ¼</td> <td>35</td> </tr> <tr> <td>Seat</td> <td>16</td> <td>18 ¼</td> <td>18 ¼</td> </tr> </tbody> </table>	Dimensions	D	W	H	Overall	19 ½	18 ¼	35	Seat	16	18 ¼	18 ¼	COM \$677 A \$702 B \$730 COL/C \$779 D \$835 E \$894 F \$957 G \$1,048 H \$1,144 I \$1,294 J \$1,470 L1 \$1,067 L2 \$1,163
		Dimensions	D	W	H										
Overall	19 ½	18 ¼	35												
Seat	16	18 ¼	18 ¼												
<table border="1"> <thead> <tr> <th>Upholstery</th> <th colspan="3">Shipping</th> </tr> </thead> <tbody> <tr> <td>COM Ydg</td> <td>1</td> <td>Ctn Wt</td> <td>28</td> </tr> <tr> <td>COL Sq Ft</td> <td>12</td> <td>Cu Ft</td> <td>9</td> </tr> </tbody> </table>	Upholstery	Shipping			COM Ydg	1	Ctn Wt	28	COL Sq Ft	12	Cu Ft	9			
Upholstery	Shipping														
COM Ydg	1	Ctn Wt	28												
COL Sq Ft	12	Cu Ft	9												
47" h Barstool 	388HB Uph. Back/Wood Seat · casters not available · when using contrasting upholstery, indicate application and use higher grade pricing · standard with brass scuff plate, also available in polished aluminum or matte black	<table border="1"> <thead> <tr> <th>Dimensions</th> <th>D</th> <th>W</th> <th>H</th> </tr> </thead> <tbody> <tr> <td>Overall</td> <td>19 ½</td> <td>18 ¼</td> <td>47</td> </tr> <tr> <td>Seat</td> <td>16</td> <td>18 ¼</td> <td>30</td> </tr> </tbody> </table>	Dimensions	D	W	H	Overall	19 ½	18 ¼	47	Seat	16	18 ¼	30	COM \$702 A \$721 B \$733 COL/C \$756 D \$787 E \$816 F \$849 G \$892 H \$941 I \$1,014 J \$1,106 L1 \$900 L2 \$950
		Dimensions	D	W	H										
Overall	19 ½	18 ¼	47												
Seat	16	18 ¼	30												
<table border="1"> <thead> <tr> <th>Upholstery</th> <th colspan="3">Shipping</th> </tr> </thead> <tbody> <tr> <td>COM Ydg</td> <td>½</td> <td>Ctn Wt</td> <td>30</td> </tr> <tr> <td>COL Sq Ft</td> <td>6</td> <td>Cu Ft</td> <td>13</td> </tr> </tbody> </table>	Upholstery	Shipping			COM Ydg	½	Ctn Wt	30	COL Sq Ft	6	Cu Ft	13			
Upholstery	Shipping														
COM Ydg	½	Ctn Wt	30												
COL Sq Ft	6	Cu Ft	13												
47" h Barstool 	388HD Uph. Seat/Back · casters not available · back is upholstered with ¾ of high density polyurethane · when using contrasting upholstery, indicate application and use higher grade pricing · standard with brass scuff plate, also available in polished aluminum or matte black	<table border="1"> <thead> <tr> <th>Dimensions</th> <th>D</th> <th>W</th> <th>H</th> </tr> </thead> <tbody> <tr> <td>Overall</td> <td>19 ½</td> <td>18 ¼</td> <td>47</td> </tr> <tr> <td>Seat</td> <td>16</td> <td>18 ¼</td> <td>30</td> </tr> </tbody> </table>	Dimensions	D	W	H	Overall	19 ½	18 ¼	47	Seat	16	18 ¼	30	COM \$768 A \$793 B \$822 COL/C \$866 D \$927 E \$987 F \$1,049 G \$1,140 H \$1,237 I \$1,384 J \$1,562 L1 \$1,157 L2 \$1,252
		Dimensions	D	W	H										
Overall	19 ½	18 ¼	47												
Seat	16	18 ¼	30												
<table border="1"> <thead> <tr> <th>Upholstery</th> <th colspan="3">Shipping</th> </tr> </thead> <tbody> <tr> <td>COM Ydg</td> <td>1</td> <td>Ctn Wt</td> <td>30</td> </tr> <tr> <td>COL Sq Ft</td> <td>12</td> <td>Cu Ft</td> <td>13</td> </tr> </tbody> </table>	Upholstery	Shipping			COM Ydg	1	Ctn Wt	30	COL Sq Ft	12	Cu Ft	13			
Upholstery	Shipping														
COM Ydg	1	Ctn Wt	30												
COL Sq Ft	12	Cu Ft	13												

MELROSE

Description	Model	Specifications	List Price Per Grade												
Armless  3831A all wood	3831A All Wood 3831C Uph. Seat · vertical slat back · optional front leg casters available - add \$66 list for set of 2 casters	<table border="1"> <thead> <tr> <th>Dimensions</th> <th>D</th> <th>W</th> <th>H</th> </tr> </thead> <tbody> <tr> <td>Overall</td> <td>19 ½</td> <td>18 ¼</td> <td>35</td> </tr> <tr> <td>Seat</td> <td>16</td> <td>18 ¼</td> <td>18 ¼</td> </tr> </tbody> </table>	Dimensions	D	W	H	Overall	19 ½	18 ¼	35	Seat	16	18 ¼	18 ¼	All Wood \$528 COM \$586 A \$604 B \$624 COL/C \$660 D \$704 E \$749 F \$797 G \$863 H \$935 I \$1,048 J \$1,182 L1 \$879 L2 \$949
		Dimensions	D	W	H										
Overall	19 ½	18 ¼	35												
Seat	16	18 ¼	18 ¼												
<table border="1"> <thead> <tr> <th>Upholstery</th> <th colspan="2">Shipping</th> </tr> </thead> <tbody> <tr> <td>COM Ydg ¾</td> <td>Ctn Wt</td> <td>28</td> </tr> <tr> <td>COL Sq Ft 9</td> <td>Cu Ft</td> <td>9</td> </tr> </tbody> </table>	Upholstery	Shipping		COM Ydg ¾	Ctn Wt	28	COL Sq Ft 9	Cu Ft	9						
Upholstery	Shipping														
COM Ydg ¾	Ctn Wt	28													
COL Sq Ft 9	Cu Ft	9													

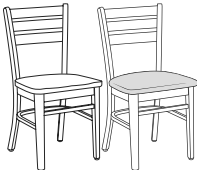
Description	Model	Specifications	List Price Per Grade												
47" h Barstool  3881A all wood	3881A All Wood 3881C Uph. Seat · vertical slat back · casters not available · standard with brass scuff plate, also available in polished aluminum or matte black	<table border="1"> <thead> <tr> <th>Dimensions</th> <th>D</th> <th>W</th> <th>H</th> </tr> </thead> <tbody> <tr> <td>Overall</td> <td>19 ½</td> <td>18 ¼</td> <td>47</td> </tr> <tr> <td>Seat</td> <td>16</td> <td>18 ¼</td> <td>30</td> </tr> </tbody> </table>	Dimensions	D	W	H	Overall	19 ½	18 ¼	47	Seat	16	18 ¼	30	All Wood \$620 COM \$674 A \$697 B \$716 COL/C \$752 D \$794 E \$840 F \$887 G \$954 H \$1,027 I \$1,140 J \$1,272 L1 \$970 L2 \$1,042
		Dimensions	D	W	H										
Overall	19 ½	18 ¼	47												
Seat	16	18 ¼	30												
<table border="1"> <thead> <tr> <th>Upholstery</th> <th colspan="2">Shipping</th> </tr> </thead> <tbody> <tr> <td>COM Ydg ¾</td> <td>Ctn Wt</td> <td>30</td> </tr> <tr> <td>COL Sq Ft 9</td> <td>Cu Ft</td> <td>13</td> </tr> </tbody> </table>	Upholstery	Shipping		COM Ydg ¾	Ctn Wt	30	COL Sq Ft 9	Cu Ft	13						
Upholstery	Shipping														
COM Ydg ¾	Ctn Wt	30													
COL Sq Ft 9	Cu Ft	13													

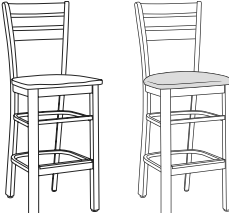
To Order, Specify:

- 1 Model Number
- 2 Wood Species - Red Oak (RO) or Maple (M)
- 3 Wood Finish/Color See [Wood Finish/Color Options](#)
- 4 Fabric Selection - vendor, pattern and color
 Visit www.jsifurniture.com/finishes-and-materials/textiles for our textiles program. See selection of standard and graded in manufacturers and patterns.
- 5 Optional FRONT LEG Casters - add \$66 list; specify seat height.
NOT AVAILABLE on BARSTOOLS
- 6 Optional Rubber Cushion Nylon Glides - no upcharge

Specifications

- Wood species - Red Oak or Maple.
- Seat is upholstered with 1 ½" high density polyurethane foam.
- Mortise and tenon construction with corner blocks, glue and screws.
- Standard with rubber cushion metal glides.

Description	Model	Specifications			List Price Per Grade	
Armless 	383KA All Wood 383KC Uph. Seat · horizontal slat back · optional front leg casters available - add \$66 list for set of 2 casters	Dimensions	D	W	H	All Wood \$528
		Overall	19 ½	18 ¼	35	COM \$586
		Seat	16	18 ¼	18 ¼	A \$604
		Upholstery	Shipping			B \$624
		COM Ydg	¾	Ctn Wt	28	COL/C \$660
		COL Sq Ft	9	Cu Ft	9	D \$704
						E \$749
						F \$797
						G \$863
						H \$935
						I \$1,048
						J \$1,182
						L1 \$879
						L2 \$949

Description	Model	Specifications			List Price Per Grade	
47" h Barstool 	388KA All Wood 388KC Uph. Seat · horizontal slat back · casters not available · standard with brass scuff plate, also available in polished aluminum or matte black	Dimensions	D	W	H	All Wood \$620
		Overall	19 ½	18 ¼	47	COM \$674
		Seat	16	18 ¼	30	A \$697
		Upholstery	Shipping			B \$716
		COM Ydg	¾	Ctn Wt	30	COL/C \$752
		COL Sq Ft	9	Cu Ft	13	D \$794
						E \$840
						F \$887
						G \$954
						H \$1,027
						I \$1,140
						J \$1,272
						L1 \$970
						L2 \$1,042

To Order, Specify:

- 1 Model Number
- 2 Wood Species - Red Oak (RO) or Maple (M)
- 3 Wood Finish/Color [See Wood Finish/Color Options](#)
- 4 Fabric Selection - vendor, pattern and color
 Visit www.jsifurniture.com/finishes-and-materials/textiles for our textiles program. See selection of standard and graded in manufacturers and patterns.
- 5 Optional FRONT LEG Casters - add \$66 list; specify seat height.
NOT AVAILABLE on BARSTOOLS
- 6 Optional Rubber Cushion Nylon Glides - no upcharge

Specifications

- Wood species - Red Oak or Maple.
- Seat is upholstered with 1 ½" high density polyurethane foam.
- Mortise and tenon construction with corner blocks, glue and screws.
- Standard with rubber cushion metal glides.

Millie Order Check List:



Specify:

- 1. Model Number
- 2. Wood Species - Maple (M)
- 3. Wood Finish
- 4. Fabric Selection - vendor, pattern and color
- 5. Optional Rubber Cushion Nylon Glides - no upcharge

Example:

MI853D | M | HRV | MOMENTUM | VOX | MYSTIC
 (model #) | (wood species) | (finish) | (fabric vendor) | (pattern name) | (pattern color)

1. Model Number

2. Wood Species - Maple (M)

3. Finish Options:

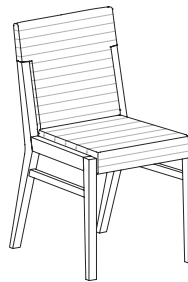
Maple Finish

ALM	Ale Medium	HRV	Harvest
CAL	Ale Light Coordinate	CKC	Khaki Coordinate
BBM	Bourbon Medium	MINC	Mineral Coordinate
CBZ	Brazilwood Coordinate	MCH	Mocha
BARC	Barrel Coordinate	CPI	Pinnacle Walnut Coordinate
CBO	Bourbon Light Coordinate	PRL	Praline
CBG	Brighton Light Coordinate	RAVC	Raven Coordinate
BRM	Brighton Medium	SABC	Sable Coordinate
BUT	Butterscotch	SIE	Sienna
CNDC	Cinder Coordinate	CST	Studio Teak Coordinate
CLA	Classic	TRF	Truffle
CLL	Collectors	UMB	Umber
EGRC	Egret Coordinate	VALC	Valley Coordinate
ESP	Espresso	VEN	Venetian
FAWC	Fawn Coordinate	CWE	Weathered Ash Coordinate
FLX	Flax		
CGR	Graphite Coordinate		

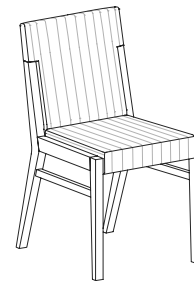
Ship prepaid COM material to:

JSI
 Attn: COM Dept
 201 East Martin Street
 Receiving B, Dock 71
 Orleans, IN 47452

Application of fabrics:



Railroaded



Up the Roll

All COM orders will ship at standard lead time from receipt of COM except for orders requiring special custom matched finishes.

4. Fabric Selection - Please supply the following:

Fabric vendor/Pattern name/Pattern color


For a complete list of JSI Standard and Graded-In Textiles click here

- Indicate direction of fabric - Railroaded or Up the Roll
- Please provide illustration, if available

All COM orders must include the following:

- Vendor's name, pattern name and color
- Sample of the fabric attached to the order
- Model numbers of items for fabric application
- Special application instructions (e.g., all stripes will be applied front to back unless specified otherwise)
- Customer and purchase order number

5. Optional Rubber Cushion Nylon Glides - no upcharge

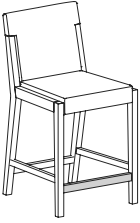
Description	① Model	Specifications			List Price Per Grade			
Guest Chair 	MI853D · upholstered seat and back · chair is a wallsaver	Dimensions			COM	\$1,059		
			D	W		H	A	\$1,073
		Overall	21 ½	18 ¼		33	B	\$1,102
						COL/C	\$1,154	
		Seat	15 ¾	16 ¼	18 ¾		D	\$1,219
		Upholstery		Shipping		E	\$1,284	
		COM Ydg	1 ¼	Ctn Wt	15	F	\$1,386	
COL Sq Ft	23	Cu Ft	10	G	\$1,495			
				H	\$1,612			
				I	\$1,793			
				J	\$2,012			
				L1	\$1,575			
				L2	\$1,720			

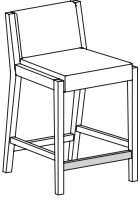
To Order, Specify:

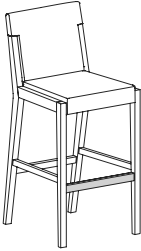
- ① Model Number
- ② Wood Species - Maple (M)
- ③ Wood Frame Finish [See Wood Frame Finish Options](#)
- ④ Fabric Selection - vendor, pattern and color
 Visit www.jsifurniture.com/finishes-and-materials/textiles for our textiles program. See selection of standard and graded in manufacturers and patterns.
- ⑤ Optional Rubber Cushion Nylon Glides - no upcharge

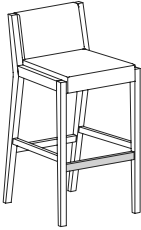
Specifications

- Wood Species - Maple.
- Seat is upholstered with 2 ½" high density polyurethane foam.
- Seat has single needle top stitch detail for added style and durability.
- Back is upholstered with 1" polyurethane foam.
- Mortise and tenon construction with corner blocks, glue and screws.
- Standard with rubber cushion metal glides.

Description	① Model	Specifications				List Price Per Grade
36¼" Counter Height Stool 	MI854D · upholstered seat and back · stainless steel foot rest	Dimensions				COM \$1,242
			D	W	H	A \$1,258
		Overall	20 ¾	18 ¼	36 ¼	B \$1,286
		Seat	15 ½	15 ¾	23 ¾	COL/C \$1,338
		Upholstery		Shipping		D \$1,405
		COM Ydg	1 ¼	Ctn Wt	17	E \$1,468
		COL Sq Ft	23	Cu Ft	12	F \$1,571
						G \$1,679
						H \$1,796
						I \$1,979
						J \$2,196
						L1 \$1,760
						L2 \$1,905

Description	① Model	Specifications				List Price Per Grade
31½" Mid-Back Counter Height Stool 	MI854E · upholstered seat and back · stainless steel foot rest	Dimensions				COM \$1,237
			D	W	H	A \$1,250
		Overall	20 ¾	18 ¼	31 ½	B \$1,276
		Seat	15 ½	15 ¾	23 ¾	COL/C \$1,322
		Upholstery		Shipping		D \$1,381
		COM Ydg	1 ¼	Ctn Wt	16	E \$1,440
		COL Sq Ft	23	Cu Ft	11	F \$1,495
						G \$1,629
						H \$1,734
						I \$1,897
						J \$2,094
						L1 \$1,701
						L2 \$1,833

Description	① Model	Specifications				List Price Per Grade	
42¼" h Barstool 	MI858D · upholstered seat and back · stainless steel foot rest	Dimensions		D	W	H	COM \$1,242
		Overall	20 ¾	18 ¼	42 ¼	A \$1,258	
		Seat	15 ½	15 ¾	29 ¾	B \$1,286	
		Upholstery		Shipping		COL/C \$1,338	
		COM Ydg	1 ¼	Ctn Wt	18	D \$1,405	
		COL Sq Ft	23	Cu Ft	12	E \$1,468	
						F \$1,571	
						G \$1,679	
						H \$1,796	
						I \$1,979	
				J \$2,196			
				L1 \$1,760			
				L2 \$1,905			

Description	① Model	Specifications				List Price Per Grade	
37½" h Mid-Back Barstool 	MI858E · upholstered seat and back · stainless steel foot rest	Dimensions		D	W	H	COM \$1,237
		Overall	20 ¾	18 ¼	37 ½	A \$1,250	
		Seat	15 ½	15 ¾	29 ¾	B \$1,276	
		Upholstery		Shipping		COL/C \$1,322	
		COM Ydg	1 ¼	Ctn Wt	17	D \$1,381	
		COL Sq Ft	23	Cu Ft	11	E \$1,440	
						F \$1,495	
						G \$1,629	
						H \$1,734	
						I \$1,897	
				J \$2,094			
				L1 \$1,701			
				L2 \$1,833			

To Order, Specify:

- ① Model Number
- ② Wood Species - Maple (M)
- ③ Wood Frame Finish [See Wood Frame Finish Options](#)
- ④ Fabric Selection - vendor, pattern and color
 Visit www.jsifurniture.com/finishes-and-materials/textiles for our textiles program. See selection of standard and graded in manufacturers and patterns.
- ⑤ Optional Rubber Cushion Nylon Glides - no upcharge

Specifications

- Wood Species - Maple.
- Seat is upholstered with 2 ½" high density polyurethane foam.
- Seat has single needle top stitch detail for added style and durability.
- Back is upholstered with 1" polyurethane foam.
- Mortise and tenon construction with corner blocks, glue and screws.
- Standard with rubber cushion metal glides.

Moto Lounge Order Check List:



Specify:

- 1. Model Number
- 2. Fabric Selection
 - A. Chair - vendor, pattern and color
 - B. Seat Cushion - vendor, pattern and color
 - C. Privacy Screen - vendor, pattern and color
- 3. Optional Casters; add \$111 list
- 4. Optional Wood Feet; specify finish; add \$71 list
- 5. Optional Tablet Arm; specify material, finish and add \$691 list per arm
- 6. Optional Arm Cap; specify wood species, finish or 3D Black Laminate and add \$313 list per arm
- 7. Optional Power Center - Flush Mount (EC22) - Black (B) or White (W)
 - Side of Seating; add \$583 list each and specify right or left
 - Side of Privacy Surround; add \$583 list each and specify right or left
 - Back of Work Shelf; add \$697 list each
- 8. Work Shelf Wood Species - Cherry (CH1), Maple (MA1) or Walnut (WA1)
- 9. Work Shelf Wood Finish
- 10. Work Shelf Laminate Color Selection
- 11. Optional Work Shelf Acrylic Screen; add \$246 list

Example:

MTL301UAR (model #)	MOMENTUM (fabric vendor)	VOX (pattern name)	MYSTIC (pattern color)	CASTERS	TABLET ARM	WA1 (tablet arm wood species)	MCH (tablet arm finish)
-------------------------------	------------------------------------	------------------------------	----------------------------------	----------------	-------------------	---	-----------------------------------

1. Model Number

2. Fabric Selection - Please supply the following:

- Fabric vendor
- Pattern name
- Pattern color

For a complete list of JSI Graded-In Fabric click here

When specifying contrasting upholstery, indicate clearly which upholstery is to be applied to the chair, seat and privacy screen. Use higher grade pricing.

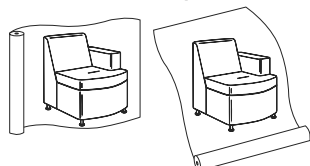
- Indicate direction of fabric - Railroaded or Up the Roll
- Please provide illustration, if available

All COM orders must include the following:

- Vendor's name, pattern name and color
- Sample of the fabric attached to the order
- Model numbers of items for fabric application
- Special application instructions (e.g., all stripes will be applied front to back unless specified otherwise)
- Customer and purchase order number

Ship prepaid COM material to:
 JSI
 Attn: COM Dept
 201 East Martin Street
 Receiving B, Dock 71
 Orleans, IN 47452

Application of fabric:
 Railroaded Up the Roll



All COM orders will ship at standard lead time from receipt of COM except for orders requiring special custom matched finishes.

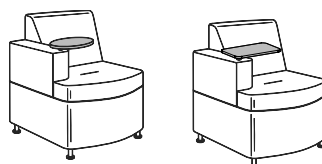
3. Casters - Add \$111 list

4. Wood Feet - Solid maple wood feet with leveling glide. Add \$71 list and specify finish.



5. Tablet Arm -

- Rotating 10" x 14" oval surface or 10" x 16" rectangular surface
- 300 lb maximum static weight rating
- Available on Inline or Convex units with arm
- Available in veneer or laminate
- Exposed plywood edge on veneer tablet is finished with veneer color. Laminate tablet will have a clear finish on the exposed plywood edge.
- Add \$691 list per arm and specify shape, material and finish



Tablet Arm Wood Finish Selection:

Cherry (CH1)		Maple (MA1)		Walnut (WA1)	
BBM	Bourbon Medium	ALM	Ale Medium	ESP	Espresso
BRM	Brighton Medium	BUT	Butterscotch	MCH	Mocha*
CLA	Classic	FLX	Flax	SIE	Sienna*
CLL	Collectors*	VEN	Venetian	TRF	Truffle*
HRV	Harvest*			UMB	Umber*
PRL	Praline*				
SAF	Saffron				

*finishes with coordinating laminate top option

Double Cut (DC1)

BAR	Barrell - Oak Pattern	KHK	Khaki
BUF	Buff - Oak Pattern	MIN	Mineral- Oak Pattern *
CND	Cinder - Oak Pattern	RYE	Rye - Oak Pattern
COF	Coffee	SAB	Sable - Oak Pattern
EGR	Egret - Oak Pattern	SAD	Saddle - Oak Pattern
FAW	Fawn *	STU	Studio Teak
GRH	Graphite	VAL	Valley *

Tablet Arm Laminate Selection:

Veneer Grain Pattern Laminates

ALL	Ale Light	OAT	Oatmeal Cookie
BOL	Bourbon Light	PIN	Pinnacle Walnut
BZW	Brazilwood	STU	Studio Teak
BGL	Brighton Light	UMB	Umber
CLL	Collectors	VAL	Valley
FAW	Fawn	VIN	Vintage
FLO	Florence Walnut	WEA	Weathered Ash
GRH	Graphite		

Solid Laminates

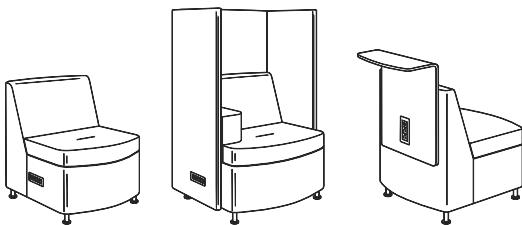
ALB	Alabaster	DWH	Designer White
BLK	Black	SHD	Shadow
BBL	Bridal Blanco	SLG	Slate Grey

6. Arm Cap -



- Available in Cherry (CH1), Maple (MA1), Walnut (WA1) or Black 3D Laminate (3BL).
- Add \$313 list per arm and specify wood species and finish.
- Arm cap can not be placed on same arm as Tablet Arm

7. Power Center - Flush Mount (EC22) - Specify Black (B) or White (W).



Power Center option can be specified on the sides of seating units and privacy surrounds, or in the back of work shelves. It features two waterproof 110 outlets and one dual USB port. Power is connected to the building supply with a 10' long standard three prong cord. A hook and loop chair bottom allows access to power cords in the base of the chair.

Power Center

- Side of Seating; add \$583 list each and specify right or left
- Side of Privacy Surround; add \$583 list each and specify right or left. Back of Work Shelf; add \$697 list each

8. Work Shelf Wood Species - Cherry (CH1), Maple (MA1) or Walnut (WA1)

9. Work Shelf Wood Finish Options:

Cherry (CH1)		Maple (MA1)	
BBM	Bourbon Medium	ALM	Ale Medium
BRM	Brighton Medium	BUT	Butterscotch
CLA	Classic	FLX	Flax
CLL	Collectors*	VEN	Venetian
HRV	Harvest*	PRL	Praline*
SAF	Saffron		

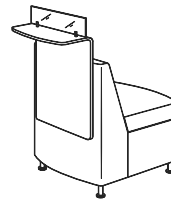
Walnut (WA1)	
ESP	Espresso
MCH	Mocha*
SIE	Sienna*
TRF	Truffle*
UMB	Umber*

*finishes with coordinating laminate top option

10. Work Shelf Laminate Color Selection

DWH	Designer White
SHD	Shadow
SLG	Slate Grey

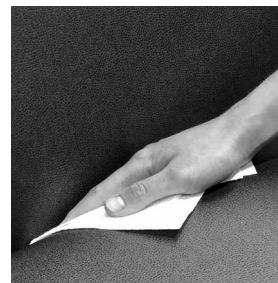
11. Work Shelf Acrylic Screen



Units with a work shelf can be specified with an acrylic screen. The frosted screen is on brushed aluminum standoffs and is 4 3/8" tall. Add \$246 list.

Discrete Clean Out

Select units with the suffix of -CO offer a discrete clean out for ease in cleaning. Clean out is incorporated in such a way as to not be noticeable from the approach, as well as provide sufficient pass through to an opening in the bottom of the chair.



Moto Casegoods Order Check List:



Specify:

- 1. Model Number
- 2. Wood Species - Cherry (CH1), Maple (MA1), Walnut (WA1) or Double Cut (DC1)
- 3. Wood Finish
- 4. Laminate Selection
- 5. Conical Base Finish
- 6. Optional Wood Feet; specify finish; add \$71 list
- 7. Optional Power Unit
 - Linking Drum Table - Node - Black (B) or White (w); see page MT64
 - Conical Work Table - Moire - Black (B) or White (W); see page MT64
 - Media Table - Ellora; see page MT64
- 8. Optional Markerboard Back Panel; for 24" unit add \$258 list, for 48" unit add \$501 list
- 9. Deduct TV Bracket; subtract \$186 list
- 10. Optional Door Locks; add \$142 list

Examples:

MT4878-30MACW (model #)	WA1 (wood species)	MCH (wood finish)	
MTF54R0UN (model #)	STU (top laminate)	BWH (base finish)	Moire - EC23 Power Unit

1. Model Number

2. Wood Species - Cherry (CH1), Maple (MA1) or Walnut (WA1)

3. Wood Finish Selection:

Veneer

		Flat Cut			
		Maple (MA1)		Walnut (WA1)	
Cherry (CH1)					
BBM Bourbon Medium	ALM Ale Medium	ESP Espresso			
BRM Brighton Medium	BUT Butterscotch	MCH Mocha*			
CLA Classic	FLX Flax	SIE Sienna*			
CLL Collectors*	VEN Venetian	TRF Truffle*			
HRV Harvest*		UMB Umber*			
PRL Praline*					
SAF Saffron					

Double Cut (DC1)

BAR Barrell - Oak Pattern	KHK Khaki
BUF Buff - Oak Pattern	MIN Mineral- Oak Pattern *
CND Cinder - Oak Pattern	RYE Rye - Oak Pattern
COF Coffee	SAB Sable - Oak Pattern
EGR Egret - Oak Pattern	SAD Saddle - Oak Pattern
FAW Fawn *	STU Studio Teak
GRH Graphite	VAL Valley *

*finishes with coordinating laminate top option

4. Laminate Selection:

Veneer Grain Pattern Laminates

ALL Ale Light	OAT Oatmeal Cookie
BOL Bourbon Light	PIN Pinnacle Walnut
BZW Brazilwood	STU Studio Teak
BGL Brighton Light	UMB Umber
CLL Collectors	VAL Valley
FAW Fawn	VIN Vintage
FLO Florence Walnut	WEA Weathered Ash
GRH Graphite	

Solid Laminates

ALB Alabaster	DWH Designer White
BLK Black	SHD Shadow
BBL Bridal Blanco	SLG Slate Grey

5. Paint Finish: Polystyrene table base available in wood finishes, laminate coordinate or paint colors.

BKD Backdrop	GRV Greek Villa
BFX Black Fox	NET Network Gray
BWH Bright White	NWH Nonchalant White
CGP Cargo Pants	STM Storm
CHT Chatroom	TRC Tricorn Black
FRR French Roast	

- 6. Wood Feet** - Solid maple wood feet with leveling glide.
Add \$71 list and specify finish.



- 7. Power Unit** - Power Units can be specified in Linking Drum Tables, Conical Work Tables, Media Tables and Media Credenzas. Specify the table to be fitted for power and order the power unit separately.

Linking Drum Table - Node - EC24

One 110 outlet and a dual USB port with 72" power cord - Black (B) or White (W); see page MT64.



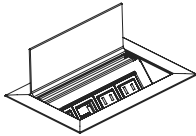
Conical Work Table - Moire - EC23

Three 110 outlets and a dual USB port with 72" power cord - Black (B) or White (W); see page MT64.



Media Table - Ellora - EC25

Two 110 power outlets, one dual powered USB port, and 1 opening for voice/data port with wire pass-through and 72" power cord anodized aluminum; see page MT64.



- 8. Markerboard Back Panel** - Dry-Erase markerboard laminate can be specified on the back panels of Media Tables, Media Credenzas and Bookcase units. When specified, the inside back of the cabinet will also be markerboard; for 24" unit add \$258 list, for 48" unit add \$501 list.

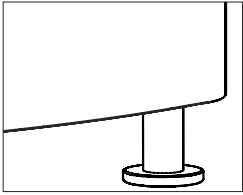
- 9. Deduct TV Bracket; subtract \$186 list**

- 10. Optional Door Locks; add \$142 list**

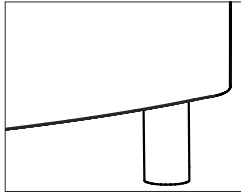
- 11. Optional Coordinating Wood Grain Laminate Table Top** - no upcharge; Drum Tables, Media Tables and Media Credenzas only. Finishes with an asterisk (*) have a coordinating laminate available.

Foot Options

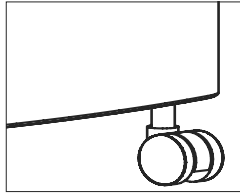
Moto offers two foot styles or casters. The metal foot is standard on seating, casegoods and linking drum tables. An optional wood foot is available at an additional upcharge on lounge, linking drum tables and casegoods. Casters are available on seating with an additional upcharge. Casters are non-locking.



Metal Foot - Standard
Fabricated Metal
Arctic Silver Powder Coat
Adjustable Glide



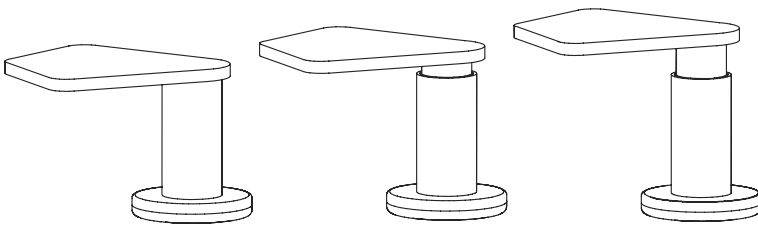
Wood Foot - Optional
Maple Species
Adjustable Glide



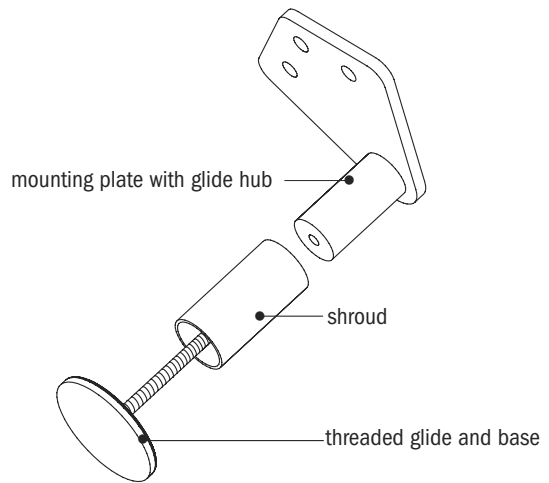
Casters - Optional
Black Dual Wheel
Four Caster Set
Non-locking

Adjustable Foot - Leveling

The standard foot has integrated leveling, which is beneficial when connecting units together in long runs on uneven floors. As the glide is turned to adjust leveling an attached shroud drops to hide the threads of the bolt.



The maximum recommended adjustment is no more than 1 3/4".

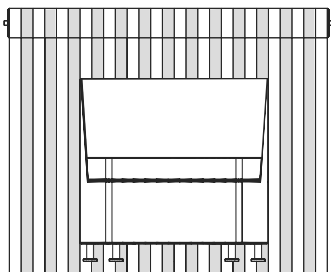


Upholstery Application

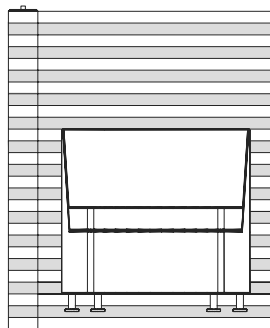
The fabric will be applied "up the roll" unless railroad is specified.

The Concave Corner unit will have a diagonal seam on all fabric applications. Shown below is an example of a directional textile on the Corner Club unit.

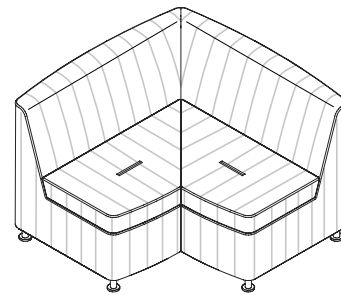
Additional seaming may be needed pending fabric width and fabric repeat match, contact Customer Service with questions. JSI will strive to match fabric patterns but cannot guarantee a match on repeats greater than 15" on the Moto product line.



up the roll



railroaded

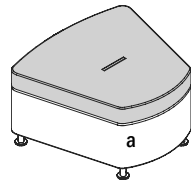


90° Concave Corner

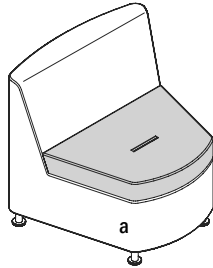
Contrasting Upholstery Specification

This form should accompany orders when specifying contrasting or complementary upholstery.

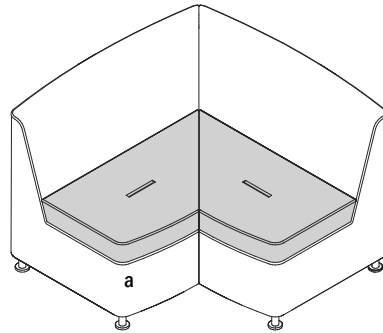
examples



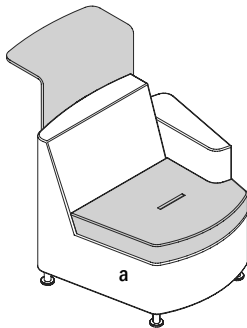
Benches - Inline - Concave- Convex



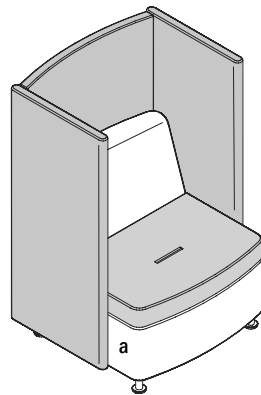
Club Chair - Inline - Concave - Convex



Corner - Concave - Convex



Club Chair with Shelf - Inline - Concave



Club Chair with Privacy - Screen - Surround

photo copy or scan

fill out for each model ordered

Code Explanation

- a = upholstered chassis, back and arm(s) - fabric choice required
- b = seat cushion (light gray) - fabric choice required
- c = work shelf either veneer or laminate
 - veneer - Cherry, Maple or Walnut - finish choice required
 - laminate - Designer White, Shadow or Slate Grey
- d= Privacy Screen/Surround - fabric choice required

Item 1

Model Number: _____

chassis, back and arms (a): _____

seat (b): _____

work shelf (c): _____

screen/surround (d): _____

Item 2

Model Number: _____

chassis, back and arms (a): _____

seat (b): _____

work shelf (c): _____

screen/surround (d): _____

Item 3

Model Number: _____

chassis, back and arms (a): _____

seat (b): _____

work shelf (c): _____

screen/surround (d): _____

Item 4

Model Number: _____

chassis, back and arms (a): _____

seat (b): _____

work shelf (c): _____

screen/surround (d): _____

Item 5

Model Number: _____

chassis, back and arms (a): _____

seat (b): _____

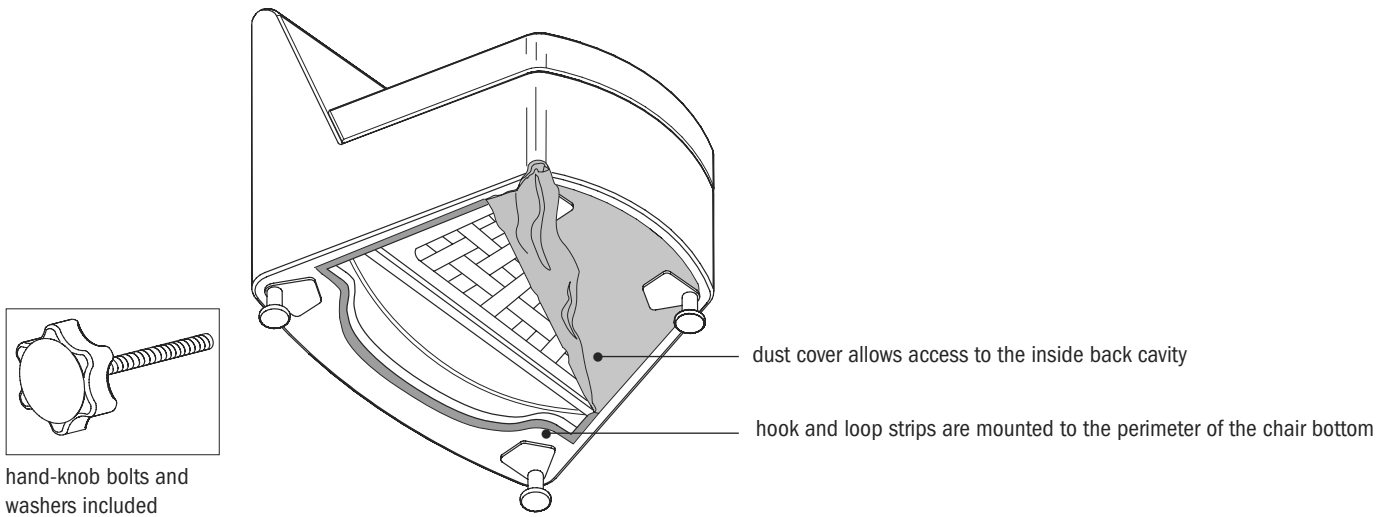
work shelf (c): _____

screen/surround (d): _____

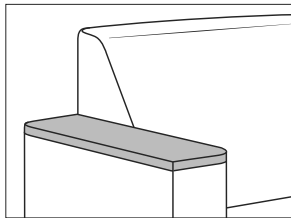
MOTO

Installation of Privacy Screen and Work Shelf

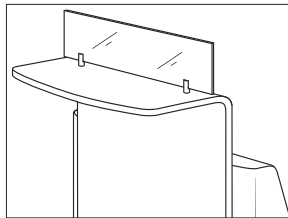
Simple field installation is required on club chairs when ordering units with privacy screens and work shelves. Instructions are included. Access to the back of the chair is through the chair bottom. Attaching knobs are included, no tools are required.



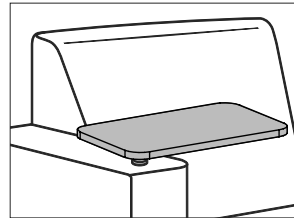
Moto Options for Lounge Seating



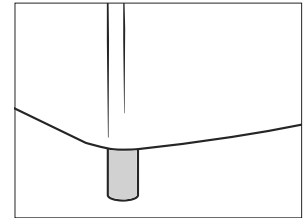
Arm Cap
 specify wood species and finish
 Cherry (CH1)
 Maple (MA1)
 Walnut (WA1)
 or 3D Laminate (B3L)
 add \$313 list per arm



Work Shelf Acrylic Screen
 frosted acrylic screens
 4 3/8" tall - from work shelf surface
 brushed aluminum standoffs
 add \$246 list.

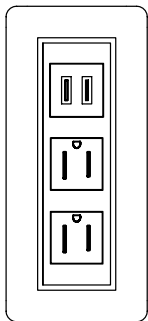


Tablet Arm
 rotating 10" x 16" rectangular surface or
 10" x 14" oval surface
 300 lb max. static weight rating
 for inline or convex units with arms
 specify surface finish and species
 veneer
 Cherry (CH1)
 Maple (MA1)
 Walnut (WA1)
 Double Cut (DC1)
 (stained plywood edge)
 laminate
 (clear coat plywood edge)
 add \$691 list per arm

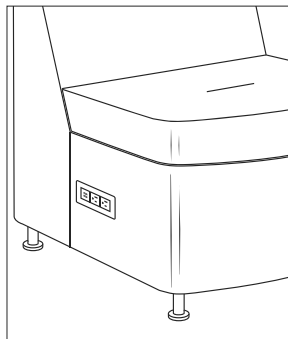


Wood Foot
 maple wood species
 adjustable glide - up to 3/4"
 specify finish
 add \$71 list per chair

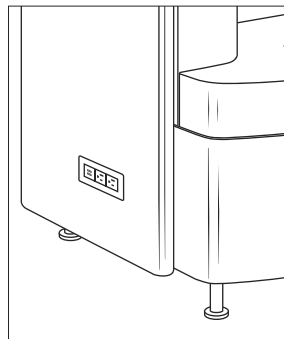
MOTO



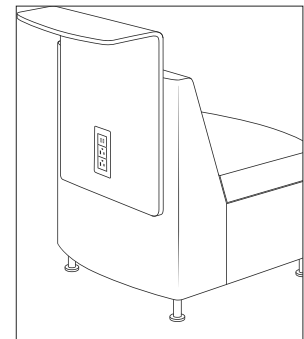
EC22 (3 installed locations)
 Flush Mount Power Center
 two 110 devices and
 one USB 2-Port Simplex for charging



side of seating
 specify right or left
 add \$583 list for each EC22



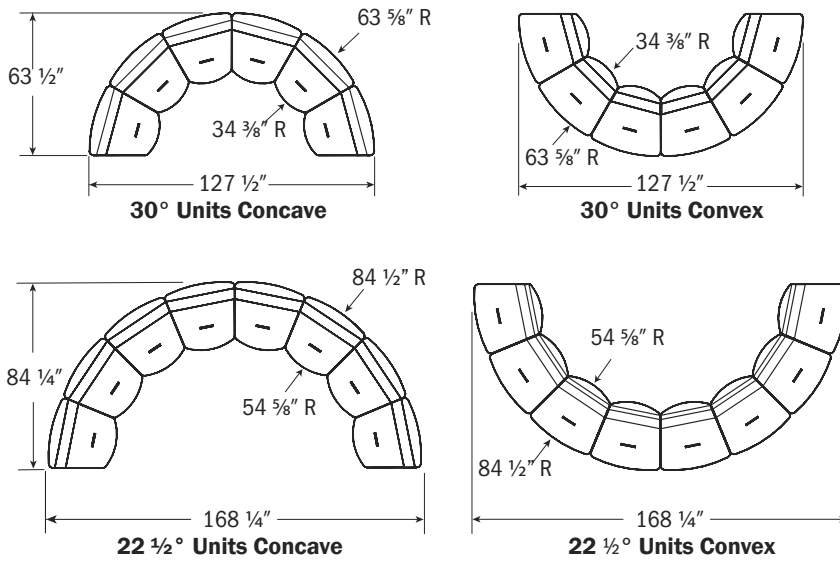
side of privacy surround
 specify right or left
 add \$583 list for each EC22



back of work shelf
 add \$697 list

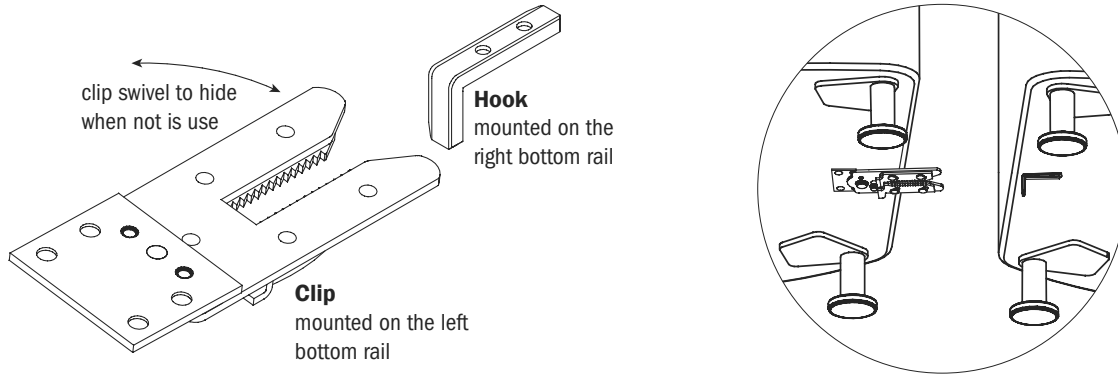
Additional Product Information

Half Round Dimensions



Modular Lounge and Linking Drum Tables

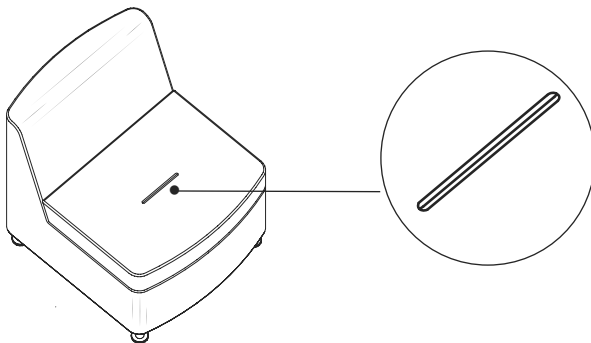
An Alligator Clip assembly is installed to connect lounge and linking drum tables. The clip is installed on the left bottom side rail and the hook is installed on the right bottom side rail. The bottom chair rails are bored to accept either the clip or hook for field re-configurations.



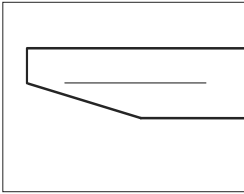
Note: Linking Table Tops are permanent bolt thru attachment and do not use the above clip.

Lounge Seating - Seam Detail

Seats have a seam detail in the center of the seat. This seam detail is standard and will help keep the tailored look of Moto. Please note that fabrics and leathers are all different (fiber content, yarn elasticity and yarn weight) which can affect the tailoring of the Moto Lounge. The aesthetic seam helps with variations in the upholstery cover. Contact Customer Service with fabric and leather information if a concern exists with a certain upholstery cover.

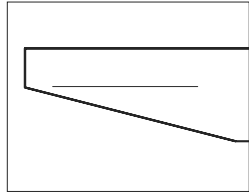


Casegood & Table Edge Details



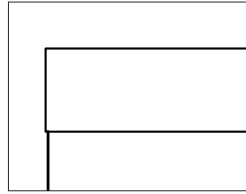
Bevel Edge

used on pull-up tables



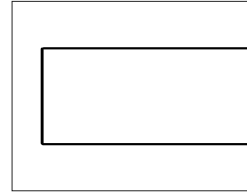
Bevel Edge

used on work tables



Straight Edge

used on linking tables



Straight Edge

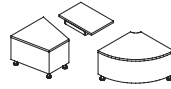
used on media table surfaces



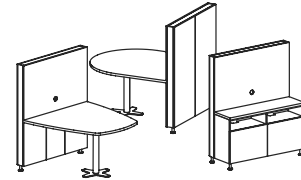
3/4" thick
available in
cherry veneer
maple veneer
walnut veneer
paint (base only)
standard laminate - HPL
(bevel underside MDF)



1 3/16" thick
available in
cherry veneer
maple veneer
walnut veneer
paint (base only)
standard laminate - HPL
(bevel underside MDF)

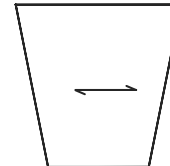
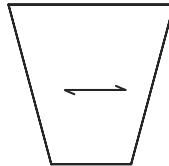
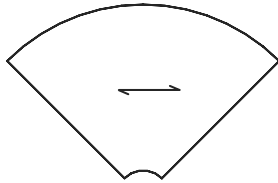
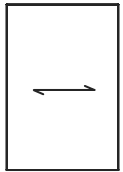


1" thick
available in
cherry veneer
maple veneer
walnut veneer



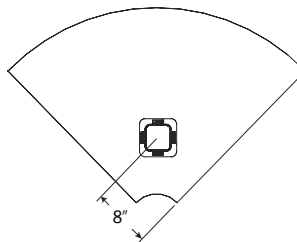
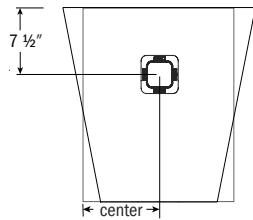
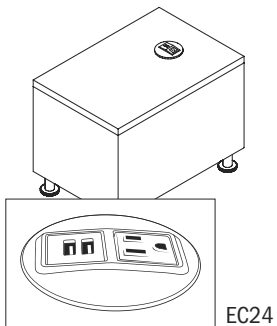
1 3/16" thick
available in
cherry veneer
maple veneer
walnut veneer
standard laminate - HPL

Linking Tables - Grain Direction



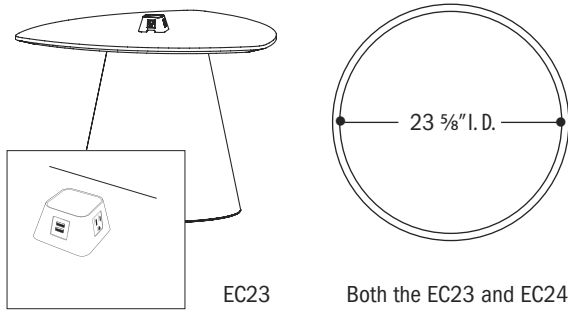
Linking Drum Tables - Power Location

The EC24 or EC23 are available on linking drum tables. Wire management moves through the bottom cavity. The location shown below is for all table shapes.



Work Tables - Power and Wire Management

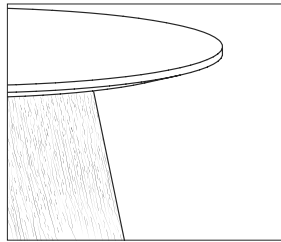
The optional EC23 or EC24 is recommended for the work tables. When electrical units are used on the work tables with a conical base, the base allows wires to run through to a floor outlet. The unrestricted opening at the bottom of the base allows the base to be placed over the floor electrical monument.



Both the EC23 and EC24 are centered on the top over the base.

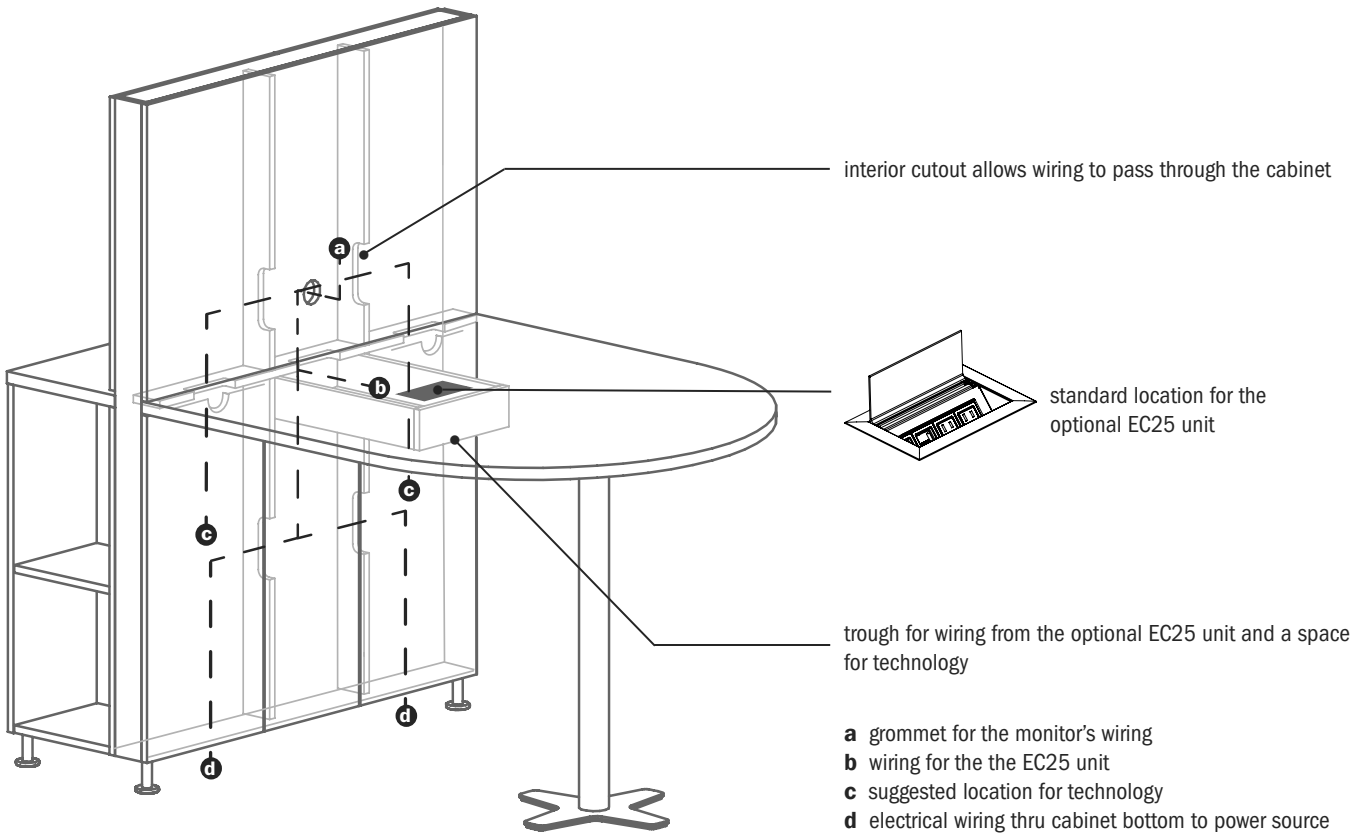
Conical Table Base - Material and Grain Direction

The conical base on the pull-up and work tables is polystyrene material with a wood grain texture. This base is available in wood finishes and paint colors. Color Coordinate Finishes are intended to coordinate with select laminates. Adjustable leveling glides are included.

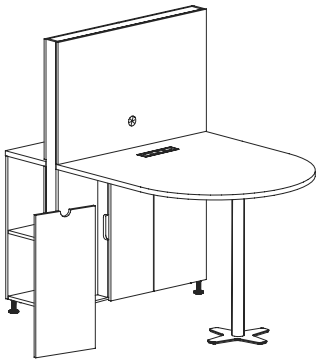


Media Tables and Media Credenzas - Wire Management and Power/Data

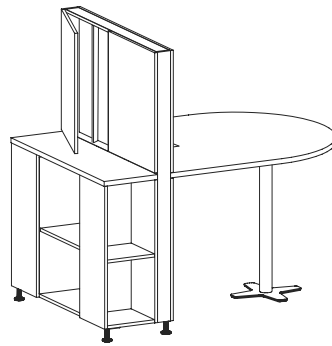
Easy access to wiring is provided in the Moto Media products. Well placed grommets, doors, and allowance inside the cabinets makes it easy to outfit these units quickly. The recommended EC25 brings power and data access to the top.



- a** grommet for the monitor's wiring
- b** wiring for the the EC25 unit
- c** suggested location for technology
- d** electrical wiring thru cabinet bottom to power source



removable panels

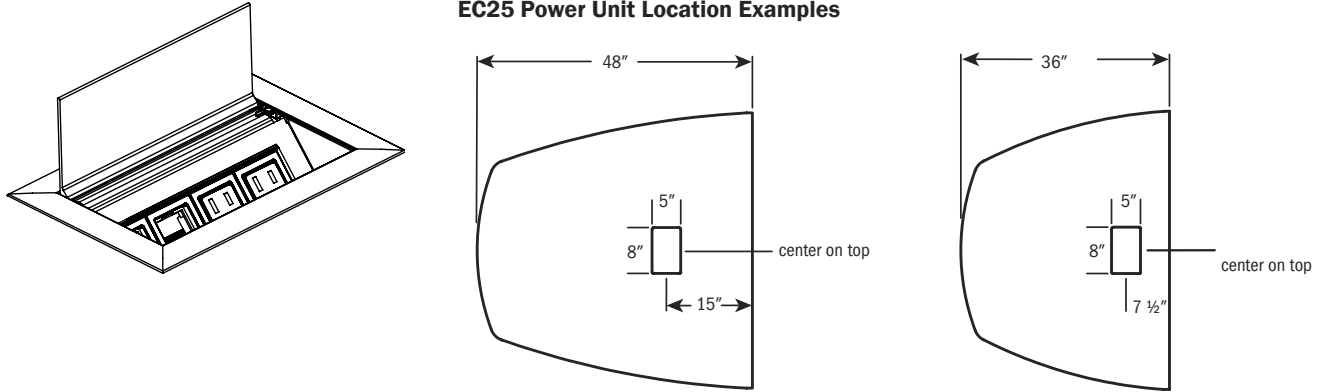


hinged doors

Media Tables - Power Location

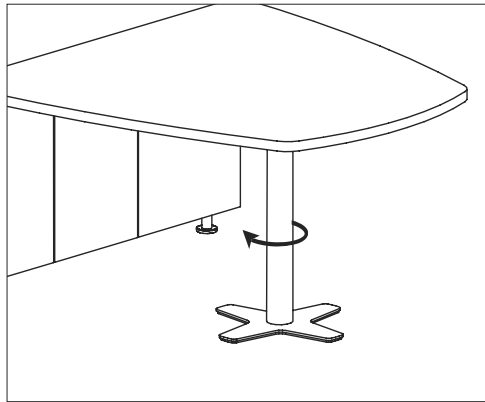
The EC25 is available on media tables. The location shown below is for all table wedge shape tops, location for EC25 on bullet shapes are similar.

EC25 Power Unit Location Examples



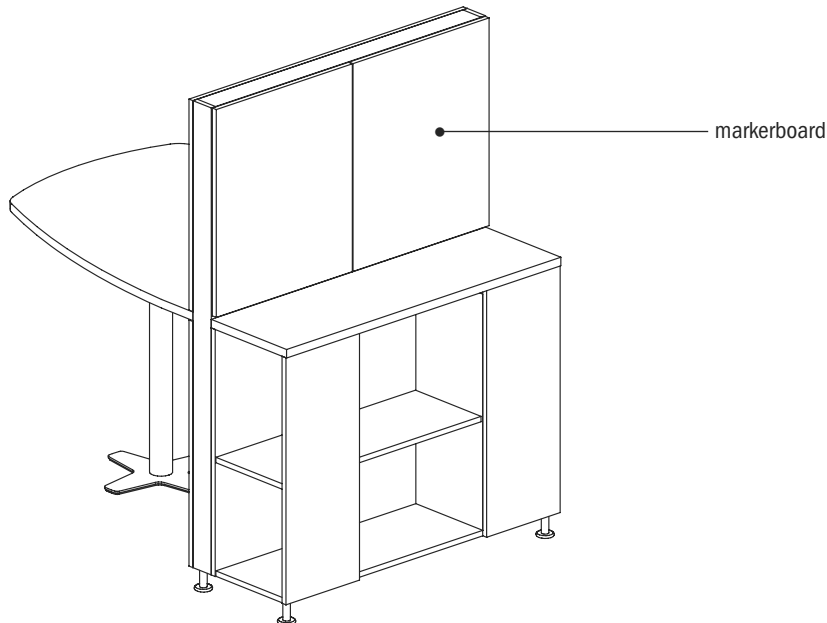
Media Tables - Leveling the Post Column

Leveling is made easy by turning the column.



Markerboard Back Panel Options

Markerboard back panels can be specified for the back panels on Media Tables, Media Credenzas and Bookcases.



Finish Codes & Availability Chart

		Casegoods Chassis	Casegoods Tops	Wood Feet	Tablet Arms	Arm Caps	Work Shelves	Conical Tops	Conical Bases
Material									
Cherry Veneer	CH1	●	●		●	● ⁰	●	●	polystyrene
Maple Veneer	MA1	●	●	● ⁰	●	● ⁰	●	●	
Walnut Veneer	WA1	●	●		●	● ⁰	●	●	
Laminate		●	●		●		●	●	
Finish (Cherry)									
Bourbon Medium	BBM	●	●	●	●	●	●	●	● ²
Brighton Medium	BRM	●	●	●	●	●	●	●	● ²
Classic	CLA	●	●	●	●	●	●	●	● ²
Collectors*	CLL	●	●	●	●	●	●	●	● ²
Harvest*	HRV	●	●	●	●	●	●	●	● ²
Praline*	PRL	●	●	●	●	●	●	●	● ²
Saffron	SAF	●	●	●	●	●	●	●	● ²
Finish (Maple)									
Ale Medium	ALM	●	●	●	●	●	●	●	● ²
Butterscotch	BUT	●	●	●	●	●	●	●	● ²
Flax	FLX	●	●	●	●	●	●	●	● ²
Venetian	VEN	●	●	●	●	●	●	●	● ²
Finish (Walnut)									
Espresso	ESP	●	●	●	●	●	●	●	● ²
Mocha*	MCH	●	●	●	●	●	●	●	● ²
Sienna*	SIE	●	●	●	●	●	●	●	● ²
Truffle	TRF	●	●	●	●	●	●	●	● ²
Umber*	UMB	●	●	●	●	●	●	●	● ²
Laminate									
Alabaster	ALB	●	●		●			●	● ^{1, 2}
Ale Light	ALL	●	●		●			●	● ^{1, 2}
Black	BLK	●	●		●			●	● ^{1, 2}
Bourbon Light	BOL	●	●		●			●	● ^{1, 2}
Brazilwood	BZW	●	●		●			●	● ^{1, 2}
Bridal Blanco	BBL	●	●		●			●	● ^{1, 2}
Brighton Light	BGL	●	●		●			●	● ^{1, 2}
Collectors	CLL	●	●		●			●	● ^{1, 2}
Designer White	DWH	●	●		●		●	●	● ^{1, 2}
Fawn	FAW	●	●		●			●	● ^{1, 2}
Florence Walnut	FLO	●	●		●			●	● ^{1, 2}
Graphite	GRH	●	●		●			●	● ^{1, 2}
Oatmeal Cookie	OAT	●	●		●			●	● ^{1, 2}
Pinnacle Walnut	PIN	●	●		●			●	● ^{1, 2}
Shadow	SHD	●	●		●		●	●	● ^{1, 2}
Slate Grey	SLG	●	●		●		●	●	● ^{1, 2}
Studio Teak	STU	●	●		●			●	● ^{1, 2}
Valley	VAL	●	●		●			●	● ^{1, 2}
Vintage	VIN	●	●		●			●	● ^{1, 2}
Weathered Ash	WEA	●	●		●			●	● ^{1, 2}
Paint Colors									
Backdrop	BKD								● ²
Black Fox	BFX								● ²
Bright White	BWH								● ²
Cargo Pants	CGP								● ²
Chatroom	CHT								● ²
French Roast	FRR								● ²
Greek Villa	GRV								● ²
Network Gray	NET								● ²
Nonchalant White	NWH								● ²
Storm	STM								● ²
Tricorn Black	TRC								● ²


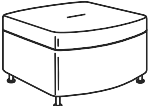
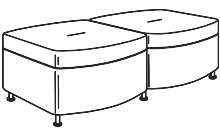
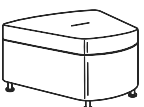
* coordinating laminate for tops available

⁰ solid lumber

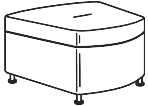
¹ coordinating laminate finishes

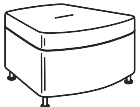
² finish on polystyrene material with imprinted wood grain

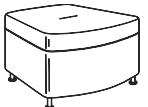


Description	Model	Specifications				List Price Per Grade
Narrow Inline Bench	MTL260	Dimensions	D	W	H	COM \$1,442
		Overall	30	26	17 ¾	A \$1,464
		Seat	30	26	17 ¾	B \$1,511
		Upholstery	Shipping			COL/C \$1,593
		COM Ydg	2 ¼	Ctn Wt	43	D \$1,698
		COL Sq Ft	45	Cu Ft	11	E \$1,803
				Chair Wt	38	F \$1,965
					G \$2,140	
					H \$2,326	
					I \$2,615	
					J \$2,966	
					L1 \$2,267	
					L2 \$2,500	
Inline Bench	MTL300	Dimensions	D	W	H	COM \$1,462
		Overall	30	30	17 ¾	A \$1,486
		Seat	30	30	17 ¾	B \$1,533
		Upholstery	Shipping			COL/C \$1,614
		COM Ydg	2 ¼	Ctn Wt	46	D \$1,719
		COL Sq Ft	45	Cu Ft	12	E \$1,824
				Chair Wt	40	F \$1,986
					G \$2,160	
					H \$2,347	
					I \$2,637	
					J \$2,987	
					L1 \$2,288	
					L2 \$2,522	
Two Seat Bench	MTL600 · casters not available	Dimensions	D	W	H	COM \$2,589
		Overall	30	60	17 ¾	A \$2,636
		Seat	30	60	17 ¾	B \$2,729
		Upholstery	Shipping			COL/C \$2,891
		COM Ydg	4 ½	Ctn Wt	90	D \$3,101
		COL Sq Ft	90	Cu Ft	23	E \$3,311
				Chair Wt	80	F \$3,636
					G \$3,985	
					H \$4,358	
					I \$4,939	
					J \$5,639	
					L1 \$4,241	
					L2 \$4,707	
30° Concave Bench	MTI300	Dimensions	D	W	H	COM \$1,476
		Overall	30	32	17 ¾	A \$1,500
		Seat	30		17 ¾	B \$1,548
		Upholstery	Shipping			COL/C \$1,629
		COM Ydg	2 ¼	Ctn Wt	42	D \$1,734
		COL Sq Ft	45	Cu Ft	13	E \$1,839
				Chair Wt	37	F \$2,002
					G \$2,177	
					H \$2,363	
					I \$2,652	
					J \$3,003	
					L1 \$2,304	
					L2 \$2,537	

MOTO

Description	1 Model	Specifications			List Price Per Grade	
22 1/2° Concave Bench	MTI220	Dimensions	D	W	H	COM \$1,478
		Overall	30	32	17 3/4	A \$1,502
		Seat	30		17 3/4	B \$1,549
		Upholstery	Shipping			COL/C \$1,631
		COM Ydg	2 1/4	Ctn Wt	43	D \$1,735
		COL Sq Ft	45	Cu Ft	13	E \$1,840
				Chair Wt	38	F \$2,003
						G \$2,178
						H \$2,364
						I \$2,653
						J \$3,004
						L1 \$2,305
						L2 \$2,538

30° Convex Bench	MTO300	Dimensions	D	W	H	COM \$1,476
		Overall	30	32	17 3/4	A \$1,500
		Seat	30		17 3/4	B \$1,548
		Upholstery	Shipping			COL/C \$1,629
		COM Ydg	2 1/4	Ctn Wt	42	D \$1,734
		COL Sq Ft	45	Cu Ft	13	E \$1,839
				Chair Wt	37	F \$2,002
						G \$2,177
						H \$2,363
						I \$2,652
						J \$3,003
						L1 \$2,304
						L2 \$2,537

22 1/2° Convex Bench	MTO220	Dimensions	D	W	H	COM \$1,478
		Overall	30	32	17 3/4	A \$1,502
		Seat	30		17 3/4	B \$1,549
		Upholstery	Shipping			COL/C \$1,631
		COM Ydg	2 1/4	Ctn Wt	43	D \$1,735
		COL Sq Ft	45	Cu Ft	13	E \$1,840
				Chair Wt	38	F \$2,003
						G \$2,178
						H \$2,364
						I \$2,653
						J \$3,004
						L1 \$2,305
						L2 \$2,538

To Order, Specify:

- 1 Model Number
- 2 Fabric Selection - vendor, pattern and color
 - A. Chair
 - B. Seat Cushion
 Visit www.jsifurniture.com/finishes-and-materials/textiles for our textiles program. See selection of standard and graded in manufacturers and patterns.
- 3 Optional Casters; add \$111 list
- 4 Optional Wood Feet; add \$71 list and specify finish
- 5 Optional Power Center - Flush Mount (EC22) - Black (B) or White (W); add \$583 list each and specify left or right

Specifications

- Metal leg standard with 2 3/8" diameter leveling disc.
- Frame is puzzle jointed plywood construction.
- Seat has synthetic sheet webbing with cross strap reinforcement and 3 1/4" multi-density high resilience polyurethane foam.
- Linking bracket included.

Description	Model	Specifications				List Price Per Grade
Narrow Inline Club Chair	MTL261	Dimensions				COM \$1,778
		D	W	H		A \$1,810
		Overall	30	26	31 1/2	B \$1,872
		Seat	20 1/2	26	17 3/4	COL/C \$1,981
		Upholstery		Shipping		D \$2,119
		COM Ydg	3	Ctn Wt	55	E \$2,260
		COL Sq Ft	60	Cu Ft	18	F \$2,477
				Chair Wt	48	G \$2,710
						H \$2,958
						I \$3,346
						J \$3,810
						L1 \$2,880
						L2 \$3,189



Description	Model	Specifications				List Price Per Grade
Narrow Inline Club Chair with Clean Out	MTL261-CO · discrete clean out	Dimensions				COM \$1,880
		D	W	H		A \$1,915
		Overall	30	26	31 1/2	B \$1,982
		Seat	20 1/2	26	17 3/4	COL/C \$2,100
		Upholstery		Shipping		D \$2,250
		COM Ydg	3 1/4	Ctn Wt	55	E \$2,403
		COL Sq Ft	65	Cu Ft	18	F \$2,637
				Chair Wt	48	G \$2,889
						H \$3,159
						I \$3,579
						J \$4,082
						L1 \$3,074
						L2 \$3,411



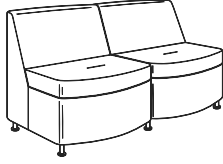
Description	Model	Specifications				List Price Per Grade
Inline Club Chair	MTL301	Dimensions				COM \$1,796
		D	W	H		A \$1,829
		Overall	30	30	31 1/2	B \$1,892
		Seat	20 1/2	30	17 3/4	COL/C \$2,000
		Upholstery		Shipping		D \$2,139
		COM Ydg	3	Ctn Wt	60	E \$2,279
		COL Sq Ft	60	Cu Ft	20	F \$2,495
				Chair Wt	52	G \$2,728
						H \$2,976
						I \$3,364
						J \$3,830
						L1 \$2,899
						L2 \$3,209

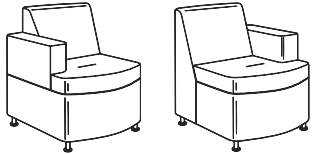


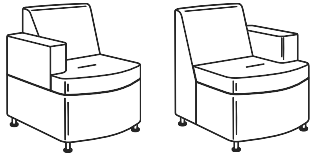
Description	Model	Specifications				List Price Per Grade
Inline Club Chair with Clean Out	MTL301-CO · discrete clean out	Dimensions				COM \$1,908
		D	W	H		A \$1,943
		Overall	30	30	31 1/2	B \$2,009
		Seat	20 1/2	30	17 3/4	COL/C \$2,128
		Upholstery		Shipping		D \$2,279
		COM Ydg	3 1/4	Ctn Wt	60	E \$2,431
		COL Sq Ft	65	Cu Ft	20	F \$2,665
				Chair Wt	52	G \$2,918
						H \$3,186
						I \$3,607
						J \$4,111
						L1 \$3,102
						L2 \$3,438



MOTO

Description	1 Model	Specifications	List Price Per Grade																																																						
Two Seat Club Chair 	MTL601 · casters not available	<table border="1"> <thead> <tr> <th>Dimensions</th> <th>D</th> <th>W</th> <th>H</th> </tr> </thead> <tbody> <tr> <td>Overall</td> <td>30</td> <td>60</td> <td>31 ½</td> </tr> <tr> <td>Seat</td> <td>20 ½</td> <td>60</td> <td>17 ¾</td> </tr> <tr> <th colspan="2">Upholstery</th> <th colspan="2">Shipping</th> </tr> <tr> <td>COM Ydg</td> <td>6</td> <td>Ctn Wt</td> <td>118</td> </tr> <tr> <td>COL Sq Ft</td> <td>120</td> <td>Cu Ft</td> <td>39</td> </tr> <tr> <td></td> <td></td> <td>Chair Wt</td> <td>104</td> </tr> </tbody> </table>	Dimensions	D	W	H	Overall	30	60	31 ½	Seat	20 ½	60	17 ¾	Upholstery		Shipping		COM Ydg	6	Ctn Wt	118	COL Sq Ft	120	Cu Ft	39			Chair Wt	104	<table border="1"> <tbody> <tr><td>COM</td><td>\$3,440</td></tr> <tr><td>A</td><td>\$3,503</td></tr> <tr><td>B</td><td>\$3,628</td></tr> <tr><td>COL/C</td><td>\$3,844</td></tr> <tr><td>D</td><td>\$4,124</td></tr> <tr><td>E</td><td>\$4,403</td></tr> <tr><td>F</td><td>\$4,836</td></tr> <tr><td>G</td><td>\$5,303</td></tr> <tr><td>H</td><td>\$5,799</td></tr> <tr><td>I</td><td>\$6,574</td></tr> <tr><td>J</td><td>\$7,506</td></tr> <tr><td>L1</td><td>\$5,643</td></tr> <tr><td>L2</td><td>\$6,264</td></tr> </tbody> </table>	COM	\$3,440	A	\$3,503	B	\$3,628	COL/C	\$3,844	D	\$4,124	E	\$4,403	F	\$4,836	G	\$5,303	H	\$5,799	I	\$6,574	J	\$7,506	L1	\$5,643	L2	\$6,264
		Dimensions	D	W	H																																																				
Overall	30	60	31 ½																																																						
Seat	20 ½	60	17 ¾																																																						
Upholstery		Shipping																																																							
COM Ydg	6	Ctn Wt	118																																																						
COL Sq Ft	120	Cu Ft	39																																																						
		Chair Wt	104																																																						
COM	\$3,440																																																								
A	\$3,503																																																								
B	\$3,628																																																								
COL/C	\$3,844																																																								
D	\$4,124																																																								
E	\$4,403																																																								
F	\$4,836																																																								
G	\$5,303																																																								
H	\$5,799																																																								
I	\$6,574																																																								
J	\$7,506																																																								
L1	\$5,643																																																								
L2	\$6,264																																																								

Description	1 Model	Specifications	List Price Per Grade																																																						
Narrow Inline Club Chair with Arm  right left	MTL261UAR MTL261UAL	<table border="1"> <thead> <tr> <th>Dimensions</th> <th>D</th> <th>W</th> <th>H</th> </tr> </thead> <tbody> <tr> <td>Overall</td> <td>30</td> <td>26</td> <td>31 ½</td> </tr> <tr> <td>Seat</td> <td>20 ½</td> <td>20</td> <td>17 ¾</td> </tr> <tr> <th colspan="2">Upholstery</th> <th colspan="2">Shipping</th> </tr> <tr> <td>COM Ydg</td> <td>3 ¼</td> <td>Ctn Wt</td> <td>67</td> </tr> <tr> <td>COL Sq Ft</td> <td>65</td> <td>Cu Ft</td> <td>18</td> </tr> <tr> <td></td> <td></td> <td>Chair Wt</td> <td>60</td> </tr> </tbody> </table>	Dimensions	D	W	H	Overall	30	26	31 ½	Seat	20 ½	20	17 ¾	Upholstery		Shipping		COM Ydg	3 ¼	Ctn Wt	67	COL Sq Ft	65	Cu Ft	18			Chair Wt	60	<table border="1"> <tbody> <tr><td>COM</td><td>\$1,945</td></tr> <tr><td>A</td><td>\$1,980</td></tr> <tr><td>B</td><td>\$2,046</td></tr> <tr><td>COL/C</td><td>\$2,164</td></tr> <tr><td>D</td><td>\$2,315</td></tr> <tr><td>E</td><td>\$2,468</td></tr> <tr><td>F</td><td>\$2,702</td></tr> <tr><td>G</td><td>\$2,954</td></tr> <tr><td>H</td><td>\$3,223</td></tr> <tr><td>I</td><td>\$3,643</td></tr> <tr><td>J</td><td>\$4,147</td></tr> <tr><td>L1</td><td>\$3,139</td></tr> <tr><td>L2</td><td>\$3,475</td></tr> </tbody> </table>	COM	\$1,945	A	\$1,980	B	\$2,046	COL/C	\$2,164	D	\$2,315	E	\$2,468	F	\$2,702	G	\$2,954	H	\$3,223	I	\$3,643	J	\$4,147	L1	\$3,139	L2	\$3,475
		Dimensions	D	W	H																																																				
Overall	30	26	31 ½																																																						
Seat	20 ½	20	17 ¾																																																						
Upholstery		Shipping																																																							
COM Ydg	3 ¼	Ctn Wt	67																																																						
COL Sq Ft	65	Cu Ft	18																																																						
		Chair Wt	60																																																						
COM	\$1,945																																																								
A	\$1,980																																																								
B	\$2,046																																																								
COL/C	\$2,164																																																								
D	\$2,315																																																								
E	\$2,468																																																								
F	\$2,702																																																								
G	\$2,954																																																								
H	\$3,223																																																								
I	\$3,643																																																								
J	\$4,147																																																								
L1	\$3,139																																																								
L2	\$3,475																																																								

Description	1 Model	Specifications	List Price Per Grade																																																						
Narrow Inline Club Chair with Arm and Clean Out  right left	MTL261UAR-CO MTL261UAL-CO · discrete clean out	<table border="1"> <thead> <tr> <th>Dimensions</th> <th>D</th> <th>W</th> <th>H</th> </tr> </thead> <tbody> <tr> <td>Overall</td> <td>30</td> <td>26</td> <td>31 ½</td> </tr> <tr> <td>Seat</td> <td>20 ½</td> <td>20</td> <td>17 ¾</td> </tr> <tr> <th colspan="2">Upholstery</th> <th colspan="2">Shipping</th> </tr> <tr> <td>COM Ydg</td> <td>3 ½</td> <td>Ctn Wt</td> <td>67</td> </tr> <tr> <td>COL Sq Ft</td> <td>70</td> <td>Cu Ft</td> <td>18</td> </tr> <tr> <td></td> <td></td> <td>Chair Wt</td> <td>60</td> </tr> </tbody> </table>	Dimensions	D	W	H	Overall	30	26	31 ½	Seat	20 ½	20	17 ¾	Upholstery		Shipping		COM Ydg	3 ½	Ctn Wt	67	COL Sq Ft	70	Cu Ft	18			Chair Wt	60	<table border="1"> <tbody> <tr><td>COM</td><td>\$2,048</td></tr> <tr><td>A</td><td>\$2,085</td></tr> <tr><td>B</td><td>\$2,158</td></tr> <tr><td>COL/C</td><td>\$2,284</td></tr> <tr><td>D</td><td>\$2,448</td></tr> <tr><td>E</td><td>\$2,611</td></tr> <tr><td>F</td><td>\$2,864</td></tr> <tr><td>G</td><td>\$3,136</td></tr> <tr><td>H</td><td>\$3,425</td></tr> <tr><td>I</td><td>\$3,877</td></tr> <tr><td>J</td><td>\$4,421</td></tr> <tr><td>L1</td><td>\$3,335</td></tr> <tr><td>L2</td><td>\$3,697</td></tr> </tbody> </table>	COM	\$2,048	A	\$2,085	B	\$2,158	COL/C	\$2,284	D	\$2,448	E	\$2,611	F	\$2,864	G	\$3,136	H	\$3,425	I	\$3,877	J	\$4,421	L1	\$3,335	L2	\$3,697
		Dimensions	D	W	H																																																				
Overall	30	26	31 ½																																																						
Seat	20 ½	20	17 ¾																																																						
Upholstery		Shipping																																																							
COM Ydg	3 ½	Ctn Wt	67																																																						
COL Sq Ft	70	Cu Ft	18																																																						
		Chair Wt	60																																																						
COM	\$2,048																																																								
A	\$2,085																																																								
B	\$2,158																																																								
COL/C	\$2,284																																																								
D	\$2,448																																																								
E	\$2,611																																																								
F	\$2,864																																																								
G	\$3,136																																																								
H	\$3,425																																																								
I	\$3,877																																																								
J	\$4,421																																																								
L1	\$3,335																																																								
L2	\$3,697																																																								

To Order, Specify:

- 1 Model Number
- 2 Fabric Selection - vendor, pattern and color
 - A. Chair
 - B. Seat Cushion
 Visit www.jsifurniture.com/finishes-and-materials/textiles for our textiles program. See selection of standard and graded in manufacturers and patterns.
- 3 Optional Casters; add \$111 list
- 4 Optional Wood Feet; add \$71 list and specify finish
- 5 Optional Tablet Arm, Oval or Rectangular; specify shape, material, finish and add \$691 list
- 6 Optional Arm Cap; specify wood species, finish or 3D Laminate and add \$313 list per arm
- 7 Optional Power Center - Flush Mount (EC22) - Black (B) or White (W); add \$583 list each and specify left or right

Specifications

- Metal leg standard with 2 ¾" diameter leveling disc.
- Frame is puzzle jointed plywood construction.
- Seat has synthetic sheet webbing with cross strap reinforcement and 3 ¼" multi-density high resilience polyurethane foam.
- Back has 1 ¾" multi-density high resilience polyurethane foam.
- Upholstered arms are standard.
- Arm tops have 1" high resilience polyurethane foam.
- Optional arm cap is available in Maple, Walnut or Cherry.
- Optional tablet arm is available in Maple, Walnut, Cherry veneer, or HPL with exposed plywood edges.
- Linking bracket included.

Description

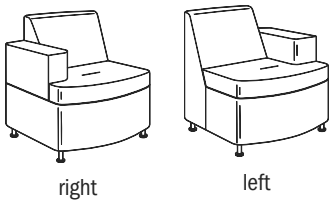
1 Model

Specifications

List Price Per Grade

Inline Club Chair with Arm

MTL301UAR
MTL301UAL

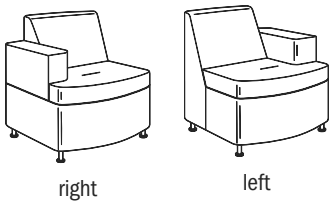


Dimensions	D	W	H
Overall	30	30	31 1/2
Seat	20 1/2	23	17 3/4
Upholstery		Shipping	
COM Ydg	3 3/4	Ctn Wt	75
COL Sq Ft	75	Cu Ft	20
		Chair Wt	67

COM	\$2,004
A	\$2,044
B	\$2,120
COL/C	\$2,258
D	\$2,432
E	\$2,606
F	\$2,878
G	\$3,169
H	\$3,479
I	\$3,963
J	\$4,546
L1	\$3,382
L2	\$3,769

Inline Club Chair with Arm with Clean Out

MTL301UAR-CO
MTL301UAL-CO
· discrete clean out

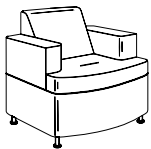


Dimensions	D	W	H
Overall	30	30	31 1/2
Seat	20 1/2	23	17 3/4
Upholstery		Shipping	
COM Ydg	4	Ctn Wt	75
COL Sq Ft	80	Cu Ft	20
		Chair Wt	67

COM	\$2,116
A	\$2,158
B	\$2,241
COL/C	\$2,387
D	\$2,572
E	\$2,759
F	\$3,048
G	\$3,357
H	\$3,689
I	\$4,206
J	\$4,826
L1	\$3,585
L2	\$3,999

Inline Club Chair with Both Arm

MTL301UA2



Dimensions	D	W	H
Overall	30	32	31 1/2
Seat	20 1/2	21	17 3/4
Upholstery		Shipping	
COM Ydg	4 1/2	Ctn Wt	87
COL Sq Ft	90	Cu Ft	21
		Chair Wt	79

COM	\$2,329
A	\$2,378
B	\$2,478
COL/C	\$2,650
D	\$2,870
E	\$3,093
F	\$3,435
G	\$3,804
H	\$4,196
I	\$4,811
J	\$5,547
L1	\$4,075
L2	\$4,565

Inline Club Chair with Both Arm and Clean Out

MTL301UA2-CO
· discrete clean out



Dimensions	D	W	H
Overall	30	32	31 1/2
Seat	20 1/2	21	17 3/4
Upholstery		Shipping	
COM Ydg	4 3/4	Ctn Wt	87
COL Sq Ft	95	Cu Ft	21
		Chair Wt	79

COM	\$2,440
A	\$2,493
B	\$2,597
COL/C	\$2,777
D	\$3,010
E	\$3,244
F	\$3,605
G	\$3,993
H	\$4,406
I	\$5,052
J	\$5,828
L1	\$4,277
L2	\$4,794

Description

1 Model

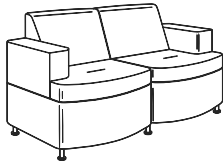
Specifications

List Price Per Grade

Two Seat Club Chair with Arms

MTL601UA

· casters not available



Dimensions	D	W	H
Overall	30	60	31 1/2
Seat	20 1/2	46	17 3/4
Upholstery		Shipping	
COM Ydg	6 1/2	Ctn Wt	148
COL Sq Ft	130	Cu Ft	39
		Chair Wt	134


COM	\$3,704
A	\$3,771
B	\$3,907
COL/C	\$4,141
D	\$4,444
E	\$4,747
F	\$5,218
G	\$5,721
H	\$6,259
I	\$7,100
J	\$8,108
L1	\$6,091
L2	\$6,762


To Order, Specify:

- 1 Model Number
- 2 Fabric Selection - vendor, pattern and color
 - A. Chair
 - B. Seat Cushion
 Visit www.jsifurniture.com/finishes-and-materials/textiles for our textiles program. See selection of standard and graded in manufacturers and patterns.
- 3 Optional Casters; add \$111 list
- 4 Optional Wood Feet; add \$71 list and specify finish
- 5 Optional Tablet Arm, Oval or Rectangular; specify shape, material, finish and add \$691 list
- 6 Optional Arm Cap; specify wood species, finish or 3D Laminate and add \$313 list per arm
- 7 Optional Power Center - Flush Mount (EC22) - Black (B) or White (W); add \$583 list each and specify left or right

Specifications

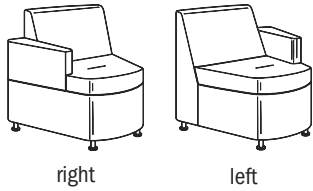
- Metal leg standard with 2 3/8" diameter leveling disc.
- Frame is puzzle jointed plywood construction.
- Seat has synthetic sheet webbing with cross strap reinforcement and 3 1/4" multi-density high resilience polyurethane foam.
- Back has 1 3/4" multi-density high resilience polyurethane foam.
- Upholstered arms are standard.
- Arm tops have 1" high resilience polyurethane foam.
- Optional arm cap is available in Maple, Walnut or Cherry.
- Optional tablet arm is available in Maple, Walnut, Cherry veneer, or HPL with exposed plywood edges.
- Linking bracket included.

Description	Model	Specifications				List Price Per Grade
30° Concave Club Chair	MTI301	Dimensions	D	W	H	COM \$1,806
		Overall	30	32	31 1/2	A \$1,836
		Seat	20 1/2		17 3/4	B \$1,899
		Upholstery	Shipping			COL/C \$2,007
		COM Ydg	3	Ctn Wt	57	D \$2,147
		COL Sq Ft	60	Cu Ft	22	E \$2,287
				Chair Wt	48	F \$2,504
						G \$2,736
					H \$2,985	
					I \$3,373	
					J \$3,839	
					L1 \$2,907	
					L2 \$3,218	

Description	Model	Specifications				List Price Per Grade
22 1/2° Concave Club Chair	MTI221	Dimensions	D	W	H	COM \$1,809
		Overall	30	32	31 1/2	A \$1,840
		Seat	20 1/2		17 3/4	B \$1,903
		Upholstery	Shipping			COL/C \$2,011
		COM Ydg	3	Ctn Wt	59	D \$2,151
		COL Sq Ft	60	Cu Ft	22	E \$2,290
				Chair Wt	50	F \$2,507
						G \$2,739
					H \$2,988	
					I \$3,376	
					J \$3,842	
					L1 \$2,910	
					L2 \$3,221	

Description

30° Concave Club Chair with Arm



1 Model

MTI301UAR
MTI301UAL
· tablet arm not available

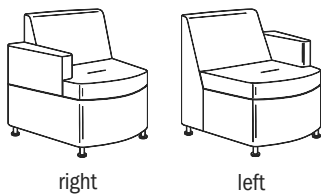
Specifications

Dimensions	D	W	H
Overall	30	32	31 1/2
Seat	20 1/2		17 3/4
Upholstery		Shipping	
COM Ydg	3 3/4	Ctn Wt	72
COL Sq Ft	75	Cu Ft	22
		Chair Wt	63

List Price Per Grade

COM	\$1,991
A	\$2,031
B	\$2,108
COL/C	\$2,244
D	\$2,418
E	\$2,593
F	\$2,864
G	\$3,156
H	\$3,466
I	\$3,951
J	\$4,533
L1	\$3,370
L2	\$3,757

22 1/2° Concave Club Chair with Arm



MTI221UAR
MTI221UAL
· tablet arm not available

Dimensions	D	W	H
Overall	30	32	31 1/2
Seat	20 1/2		17 3/4
Upholstery		Shipping	
COM Ydg	3 3/4	Ctn Wt	74
COL Sq Ft	75	Cu Ft	22
		Chair Wt	65

COM	\$1,998
A	\$2,039
B	\$2,115
COL/C	\$2,251
D	\$2,427
E	\$2,601
F	\$2,872
G	\$3,163
H	\$3,472
I	\$3,957
J	\$4,539
L1	\$3,376
L2	\$3,764

To Order, Specify:

- 1 Model Number
- 2 Fabric Selection - vendor, pattern and color
 - A. Chair
 - B. Seat Cushion
 Visit www.jsifurniture.com/finishes-and-materials/textiles for our textiles program. See selection of standard and graded in manufacturers and patterns.
- 3 Optional Casters; add \$111 list
- 4 Optional Wood Feet; add \$71 list and specify finish
- 5 Optional Arm Cap; specify wood species, finish or 3D Laminate and add \$313 list per arm
- 6 Optional Power Center - Flush Mount (EC22) - Black (B) or White (W); add \$583 list each and specify left or right

Specifications

- Metal leg standard with 2 3/8" diameter leveling disc.
- Frame is puzzle jointed plywood construction.
- Seat has synthetic sheet webbing with cross strap reinforcement and 3 1/4" multi-density high resilience polyurethane foam.
- Back has 1 3/4" multi-density high resilience polyurethane foam.
- Upholstered arms are standard.
- Arm tops have 1" high resilience polyurethane foam.
- Optional arm cap is available in Maple, Walnut or Cherry.
- Optional tablet arm is available in Maple, Walnut, Cherry veneer, or HPL with exposed plywood edges.
- Linking bracket included.

Description

1 Model

Specifications

List Price Per Grade

30° Convex Club Chair

MT0301



Dimensions	D	W	H
Overall	30	32	31 1/2
Seat	20 1/2		17 3/4
Upholstery		Shipping	
COM Ydg	3	Ctn Wt	56
COL Sq Ft	60	Cu Ft	22
		Chair Wt	47

COM	\$1,790
A	\$1,821
B	\$1,883
COL/C	\$1,992
D	\$2,131
E	\$2,271
F	\$2,489
G	\$2,721
H	\$2,970
I	\$3,357
J	\$3,823
L1	\$2,891
L2	\$3,202

22 1/2° Convex Club Chair

MT0221

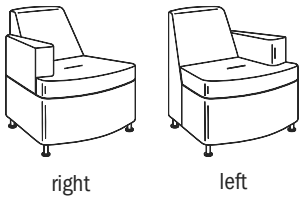


Dimensions	D	W	H
Overall	30	32	31 1/2
Seat	20 1/2		17 3/4
Upholstery		Shipping	
COM Ydg	3	Ctn Wt	57
COL Sq Ft	60	Cu Ft	22
		Chair Wt	48

COM	\$1,797
A	\$1,830
B	\$1,893
COL/C	\$2,001
D	\$2,140
E	\$2,280
F	\$2,497
G	\$2,729
H	\$2,977
I	\$3,365
J	\$3,831
L1	\$2,900
L2	\$3,210

30° Convex Club Chair with Arm

MT0301UAR
MT0301UAL



right

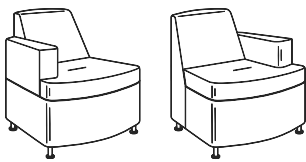
left

Dimensions	D	W	H
Overall	30	32	31 1/2
Seat	20 1/2		17 3/4
Upholstery		Shipping	
COM Ydg	3 1/4	Ctn Wt	71
COL Sq Ft	65	Cu Ft	22
		Chair Wt	62

COM	\$1,966
A	\$2,001
B	\$2,068
COL/C	\$2,185
D	\$2,336
E	\$2,489
F	\$2,723
G	\$2,975
H	\$3,245
I	\$3,665
J	\$4,168
L1	\$3,161
L2	\$3,497

22 1/2° Convex Club Chair with Arm

MT0221UAR
MT0221UAL



right

left

Dimensions	D	W	H
Overall	30	32	31 1/2
Seat	20 1/2		17 3/4
Upholstery		Shipping	
COM Ydg	3 1/4	Ctn Wt	71
COL Sq Ft	65	Cu Ft	22
		Chair Wt	62

COM	\$1,976
A	\$2,008
B	\$2,076
COL/C	\$2,194
D	\$2,345
E	\$2,497
F	\$2,731
G	\$2,984
H	\$3,252
I	\$3,673
J	\$4,176
L1	\$3,169
L2	\$3,505

Description

1 Model

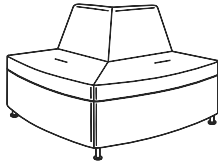
Specifications

List Price Per Grade

90° Convex Corner

MT0901

· casters not available



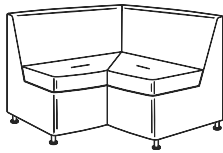
Dimensions	D	W	H
Overall	46	46	31½
Seat	20½		17¾
Upholstery		Shipping	
COM Ydg	5	Ctn Wt	122
COL Sq Ft	100	Cu Ft	45
		Chair Wt	107

COM	\$3,226
A	\$3,279
B	\$3,382
COL/C	\$3,564
D	\$3,796
E	\$4,029
F	\$4,391
G	\$4,778
H	\$5,193
I	\$5,839
J	\$6,614
L1	\$5,063
L2	\$5,581

90° Concave Corner

MTI901

· casters not available



Dimensions	D	W	H
Overall	46	46	31½
Seat	20½		17¾
Upholstery		Shipping	
COM Ydg	6¼	Ctn Wt	132
COL Sq Ft	125	Cu Ft	45
		Chair Wt	117

COM	\$3,333
A	\$3,398
B	\$3,528
COL/C	\$3,754
D	\$4,044
E	\$4,336
F	\$4,788
G	\$5,272
H	\$5,790
I	\$6,597
J	\$7,566
L1	\$5,628
L2	\$6,275

To Order, Specify:

- 1 Model Number
- 2 Fabric Selection - vendor, pattern and color
 - A. Chair
 - B. Seat Cushion
 Visit www.jsifurniture.com/finishes-and-materials/textiles for our textiles program. See selection of standard and graded in manufacturers and patterns.
- 3 Optional Casters; add \$111 list
- 4 Optional Wood Feet; add \$71 list and specify finish
- 5 Optional Tablet Arm, Oval or Rectangular; specify shape, material, finish and add \$691 list
- 6 Optional Arm Cap; specify wood species, finish or 3D Laminate and add \$313 list per arm
- 7 Optional Power Center - Flush Mount (EC22) - Black (B) or White (W); add \$583 list each and specify left or right

Specifications

- Metal leg standard with 2 3/8" diameter leveling disc.
- Frame is puzzle jointed plywood construction.
- Seat has synthetic sheet webbing with cross strap reinforcement and 3 1/4" multi-density high resilience polyurethane foam.
- Back has 1 3/4" multi-density high resilience polyurethane foam.
- Upholstered arms are standard.
- Arm tops have 1" high resilience polyurethane foam.
- Optional arm cap is available in Maple, Walnut or Cherry.
- Optional tablet arm is available in Maple, Walnut, Cherry veneer, or HPL with exposed plywood edges.
- Linking bracket included.

Description

1 Model

Specifications

List Price Per Grade

Narrow Inline Club Chair with Work Shelf

MTL264

· casters not available



Dimensions	D	W	H
Overall	41 ¼	26	39
Seat	20 ½	26	17 ¾
Upholstery		Shipping	
COM Ydg	3	Ctn Wt	93
COL Sq Ft	60	Cu Ft	23
		Chair Wt	83

COM	\$2,668
A	\$2,699
B	\$2,762
COL/C	\$2,870
D	\$3,010
E	\$3,149
F	\$3,368
G	\$3,598
H	\$3,847
I	\$4,236
J	\$4,701
L1	\$3,769
L2	\$4,080

Inline Club Chair with Work Shelf

MTL304

· casters not available

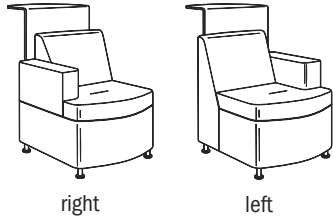


Dimensions	D	W	H
Overall	41 ¼	30	39
Seat	20 ½	30	17 ¾
Upholstery		Shipping	
COM Ydg	3	Ctn Wt	94
COL Sq Ft	60	Cu Ft	25
		Chair Wt	87

COM	\$2,690
A	\$2,722
B	\$2,784
COL/C	\$2,892
D	\$3,032
E	\$3,172
F	\$3,389
G	\$3,621
H	\$3,870
I	\$4,257
J	\$4,724
L1	\$3,792
L2	\$4,103

Description

Narrow Inline Club Chair with Arm and Work Shelf



1 Model

MTL264UAR
MTL264UAL

• casters not available

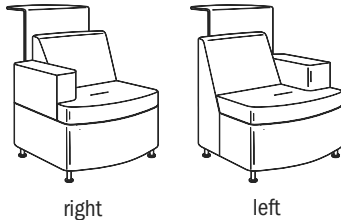
Specifications

Dimensions	D	W	H
Overall	41 ¼	26	39
Seat	20 ½	20	17 ¾
Upholstery		Shipping	
COM Ydg	3 ¾	Ctn Wt	106
COL Sq Ft	65	Cu Ft	23
		Chair Wt	95

List Price Per Grade

COM	\$2,837
A	\$2,870
B	\$2,938
COL/C	\$3,056
D	\$3,207
E	\$3,358
F	\$3,593
G	\$3,845
H	\$4,114
I	\$4,535
J	\$5,038
L1	\$4,030
L2	\$4,366

Inline Club Chair with Arm and Work Shelf



MTL304UAR
MTL304UAL

• casters not available

Dimensions	D	W	H
Overall	41 ¼	30	39
Seat	20 ½	23	17 ¾
Upholstery		Shipping	
COM Ydg	3 ¾	Ctn Wt	112
COL Sq Ft	75	Cu Ft	25
		Chair Wt	102

COM	\$2,896
A	\$2,935
B	\$3,012
COL/C	\$3,148
D	\$3,323
E	\$3,498
F	\$3,768
G	\$4,059
H	\$4,369
I	\$4,854
J	\$5,436
L1	\$4,274
L2	\$4,661

To Order, Specify:

- 1 Model Number
- 2 Fabric Selection - vendor, pattern and color
 - A. Chair
 - B. Seat Cushion
 Visit www.jsifurniture.com/finishes-and-materials/textiles for our textiles program. See selection of standard and graded in manufacturers and patterns.
- 3 Optional Wood Feet; add \$71 list and specify finish
- 4 Optional Tablet Arm, Oval or Rectangular; specify shape, material, finish and add \$691 list
- 5 Optional Arm Cap; specify wood species, finish or 3D Laminate and add \$313 list per arm
- 6 Optional Power Center - Flush Mount (EC22) - Black (B) or White (W);
 - Side of Seating; add \$583 list each and specify right or left
 - Back of Work Shelf; add \$697 list each
- 7 Work Shelf Wood Species - Cherry (CH1), Maple (MA1) or Walnut (WA1)
- 8 Work Shelf Wood Finish [See Work Shelf Wood Finish Options](#)
- 9 Work Shelf Laminate Color Selection [See Laminate Color Selection](#)
- 10 Optional Work Shelf Acrylic Screen; add \$246 list

Specifications

- Metal leg standard with 2 ¾" diameter leveling disc.
- Frame is puzzle jointed plywood construction.
- Seat has synthetic sheet webbing with cross strap reinforcement and 3 ¼" multi-density high resilience polyurethane foam.
- Back has 1 ¾" multi-density high resilience polyurethane foam.
- Upholstered arms are standard.
- Arm tops have 1" high resilience polyurethane foam.
- Optional arm cap is available in Maple, Walnut or Cherry.
- Optional tablet arm is available in Maple, Walnut, Cherry veneer, or HPL with exposed plywood edges.
- 39" high rear work shelf is available in Maple, Cherry, Walnut veneer or solid color HPL with exposed plywood edges.
- Work shelf is field installed.
- Work shelf dimensions 9 ½" x 22"
- Optional frosted acrylic screen with brushed aluminum standoffs is 4 ¾" tall
- Linking bracket included.

Description

1 Model

Specifications

List Price Per Grade

30° Concave Club Chair with Work Shelf

MTI304
· casters not available



Dimensions	D	W	H
Overall	41 ¼	32	39
Seat	20 ½		17 ¾
Upholstery		Shipping	
COM Ydg	3	Ctn Wt	95
COL Sq Ft	60	Cu Ft	27
		Chair Wt	83

COM	\$2,696
A	\$2,728
B	\$2,791
COL/C	\$2,899
D	\$3,038
E	\$3,178
F	\$3,395
G	\$3,628
H	\$3,876
I	\$4,263
J	\$4,729
L1	\$3,798
L2	\$4,108

22 ½° Concave Club Chair with Work Shelf

MTI224
· casters not available

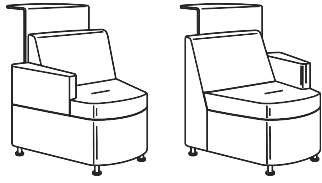


Dimensions	D	W	H
Overall	41 ¼	32	39
Seat	20 ½		17 ¾
Upholstery		Shipping	
COM Ydg	3	Ctn Wt	97
COL Sq Ft	60	Cu Ft	27
		Chair Wt	85

COM	\$2,711
A	\$2,741
B	\$2,804
COL/C	\$2,913
D	\$3,052
E	\$3,192
F	\$3,410
G	\$3,641
H	\$3,890
I	\$4,278
J	\$4,744
L1	\$3,811
L2	\$4,123

Description

30° Concave Club Chair with Arm and Work Shelf



right

left

1 Model

MTI304UAR
MTI304UAL

- casters not available
- tablet arm not available

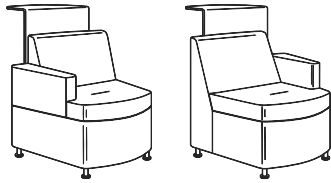
Specifications

Dimensions	D	W	H
Overall	41 ¼	32	39
Seat	20 ½		17 ¾
Upholstery		Shipping	
COM Ydg	3 ¾	Ctn Wt	110
COL Sq Ft	75	Cu Ft	27
		Chair Wt	98

List Price Per Grade

COM	\$2,886
A	\$2,926
B	\$3,003
COL/C	\$3,139
D	\$3,313
E	\$3,488
F	\$3,759
G	\$4,050
H	\$4,361
I	\$4,845
J	\$5,428
L1	\$4,263
L2	\$4,651

22 ½° Concave Club Chair with Arm and Work Shelf



right

left

MTI224UAR
MTI224UAL

- casters not available
- tablet arm not available

Dimensions	D	W	H
Overall	41 ¼	32	39
Seat	20 ½		17 ¾
Upholstery		Shipping	
COM Ydg	3 ¾	Ctn Wt	112
COL Sq Ft	75	Cu Ft	27
		Chair Wt	100

COM	\$2,890
A	\$2,930
B	\$3,008
COL/C	\$3,144
D	\$3,318
E	\$3,493
F	\$3,764
G	\$4,055
H	\$4,365
I	\$4,850
J	\$5,432
L1	\$4,269
L2	\$4,657

To Order, Specify:

- 1 Model Number
- 2 Fabric Selection - vendor, pattern and color
 - A. Chair
 - B. Seat Cushion
 Visit www.jsifurniture.com/finishes-and-materials/textiles for our textiles program. See selection of standard and graded in manufacturers and patterns.
- 3 Optional Wood Feet; add \$71 list and specify finish
- 4 Optional Arm Cap; specify wood species, finish or 3D Laminate and add \$313 list per arm
- 5 Optional Power Center - Flush Mount (EC22) - Black (B) or White (W);
 - Side of Seating; add \$583 list each and specify right or left
 - Back of Work Shelf; add \$697 list each
- 6 Work Shelf Wood Species - Cherry (CH1), Maple (MA1) or Walnut (WA1)
- 7 Work Shelf Wood Finish [See Work Shelf Wood Finish Options](#)
- 8 Work Shelf Laminate Color Selection [See Laminate Color Selection](#)
- 9 Optional Work Shelf Acrylic Screen; add \$246 list

Specifications

- Metal leg standard with 2 ¾" diameter leveling disc.
- Frame is puzzle jointed plywood construction.
- Seat has synthetic sheet webbing with cross strap reinforcement and 3 ¼" multi-density high resilience polyurethane foam.
- Back has 1 ¾" multi-density high resilience polyurethane foam.
- Upholstered arms are standard.
- Arm tops have 1" high resilience polyurethane foam.
- Optional arm cap is available in Maple, Walnut or Cherry.
- 39" high rear work shelf is available in Maple, Cherry, Walnut veneer or solid color HPL with exposed plywood edges.
- Work shelf is field installed.
- Work shelf dimensions 9 ½" x 22"
- Optional frosted acrylic screen with brushed aluminum standoffs is 4 ¾" tall
- Linking bracket included.

Description

1 Model

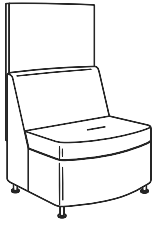
Specifications

List Price Per Grade

Inline Club Chair with Privacy Screen

MTL306

· casters not available



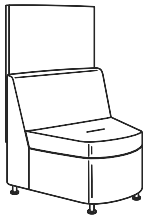
Dimensions	D	W	H
Overall	31 ¾	30	50
Seat	20 ½	30	17 ¾
Upholstery		Shipping	
COM Ydg	5 ¼	Ctn Wt	78
COL Sq Ft	105	Cu Ft	24
		Chair Wt	67

COM	\$2,410
A	\$2,465
B	\$2,574
COL/C	\$2,763
D	\$3,008
E	\$3,252
F	\$3,632
G	\$4,040
H	\$4,474
I	\$5,152
J	\$5,967
L1	\$4,338
L2	\$4,881

30° Concave Club Chair with Privacy Screen

MTI306

· casters not available



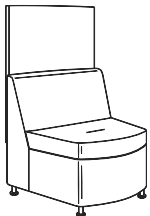
Dimensions	D	W	H
Overall	31 ¾	32	50
Seat	20 ½		17 ¾
Upholstery		Shipping	
COM Ydg	5 ¼	Ctn Wt	74
COL Sq Ft	105	Cu Ft	26
		Chair Wt	63

COM	\$2,414
A	\$2,470
B	\$2,578
COL/C	\$2,768
D	\$3,012
E	\$3,257
F	\$3,636
G	\$4,044
H	\$4,478
I	\$5,157
J	\$5,971
L1	\$4,342
L2	\$4,885

22 ½° Concave Club Chair with Privacy Screen

MTI226

· casters not available



Dimensions	D	W	H
Overall	31 ¾	32	50
Seat	20 ½		17 ¾
Upholstery		Shipping	
COM Ydg	5 ¼	Ctn Wt	76
COL Sq Ft	105	Cu Ft	26
		Chair Wt	65

COM	\$2,421
A	\$2,477
B	\$2,586
COL/C	\$2,775
D	\$3,019
E	\$3,264
F	\$3,643
G	\$4,051
H	\$4,486
I	\$5,163
J	\$5,978
L1	\$4,350
L2	\$4,893

Description

1 Model

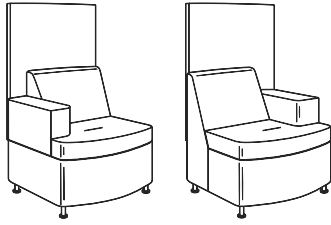
Specifications

List Price Per Grade

Inline Club Chair with Arm and Privacy Screen

MTL306UAR
MTL306UAL

• casters not available



right

left

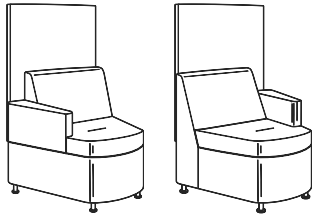
Dimensions	D	W	H
Overall	31 3/4	30	50
Seat	20 1/2	23	17 3/4
Upholstery		Shipping	
COM Ydg	6	Ctn Wt	93
COL Sq Ft	120	Cu Ft	24
		Chair Wt	82

COM	\$2,555
A	\$2,617
B	\$2,741
COL/C	\$2,959
D	\$3,238
E	\$3,518
F	\$3,952
G	\$4,417
H	\$4,913
I	\$5,689
J	\$6,620
L1	\$4,758
L2	\$5,379

30° Concave Club Chair with Arm and Privacy Screen

MTI306UAR
MTI306UAL

• casters not available
• tablet arm not available



right

left

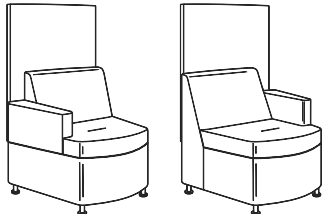
Dimensions	D	W	H
Overall	31 3/4	32	50
Seat	20 1/2		17 3/4
Upholstery		Shipping	
COM Ydg	6	Ctn Wt	89
COL Sq Ft	120	Cu Ft	26
		Chair Wt	78

COM	\$2,603
A	\$2,665
B	\$2,791
COL/C	\$3,008
D	\$3,287
E	\$3,566
F	\$4,000
G	\$4,465
H	\$4,961
I	\$5,737
J	\$6,669
L1	\$4,807
L2	\$5,428

22 1/2° Concave Club Chair with Arm and Privacy Screen

MTI226UAR
MTI226UAL

• casters not available
• tablet arm not available



right

left

Dimensions	D	W	H
Overall	31 3/4	32	50
Seat	20 1/2		17 3/4
Upholstery		Shipping	
COM Ydg	6	Ctn Wt	91
COL Sq Ft	120	Cu Ft	26
		Chair Wt	80

COM	\$2,610
A	\$2,673
B	\$2,798
COL/C	\$3,014
D	\$3,294
E	\$3,573
F	\$4,006
G	\$4,473
H	\$4,969
I	\$5,744
J	\$6,675
L1	\$4,813
L2	\$5,434

To Order, Specify:

- 1 Model Number
- 2 Fabric Selection - vendor, pattern and color
 - A. Chair
 - B. Seat Cushion
 - C. Privacy Screen

Visit www.jsifurniture.com/finishes-and-materials/textiles for our textiles program. See selection of standard and graded in manufacturers and patterns.
- 3 Optional Wood Feet; add \$71 list and specify finish
- 4 Optional Tablet Arm, Oval or Rectangular; specify shape, material, finish and add \$691 list
- 5 Optional Arm Cap; specify wood species, finish or 3D Laminate and add \$313 list per arm
- 6 Optional Power Center - Flush Mount (EC22) - Black (B) or White (W); add \$583 list each and specify left or right

Specifications

- Metal leg standard with 2 3/8" diameter leveling disc.
- Frame is puzzle jointed plywood construction.
- Seat has synthetic sheet webbing with cross strap reinforcement and 3 1/4" multi-density high resilience polyurethane foam.
- Back has 1 3/4" multi-density high resilience polyurethane foam.
- Upholstered arms are standard.
- Arm tops have 1" high resilience polyurethane foam.
- Optional arm cap is available in Maple, Walnut or Cherry.
- Optional tablet arm is available in Maple, Walnut, Cherry veneer, or HPL with exposed plywood edges.
- Upholstered privacy screen has polyurethane foam.
- Screen is field installed.
- Linking bracket included.

Description

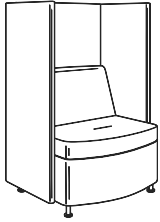
1 Model

Specifications

List Price Per Grade

Inline Club Chair with Privacy Surround

MTL305

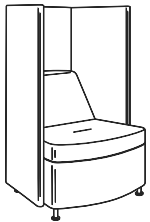


Dimensions	D	W	H
Overall	31 ¾	33 ½	50
Seat	20 ½	30	17 ¾
Upholstery		Shipping	
COM Ydg	8 ¼	Ctn Wt	118
COL Sq Ft	166	Cu Ft	37
		Chair Wt	107

COM	\$3,048
A	\$3,132
B	\$3,296
COL/C	\$3,586
D	\$3,958
E	\$4,331
F	\$4,910
G	\$5,529
H	\$6,191
I	\$7,227
J	\$8,468
L1	\$5,985
L2	\$6,812

22 ½° Convex Club Chair with Privacy Surround

MT0225

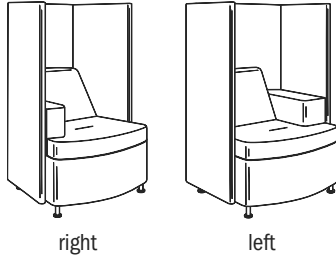


Dimensions	D	W	H
Overall	31 ¾	33 ½	50
Seat	20 ½		17 ¾
Upholstery		Shipping	
COM Ydg	8 ¼	Ctn Wt	115
COL Sq Ft	166	Cu Ft	37
		Chair Wt	102

COM	\$3,019
A	\$3,102
B	\$3,268
COL/C	\$3,557
D	\$3,930
E	\$4,302
F	\$4,882
G	\$5,502
H	\$6,164
I	\$7,197
J	\$8,438
L1	\$5,956
L2	\$6,784

Description

Inline Club Chair with Arm and Privacy Surround



1 Model

MTL305UAR
MTL305UAL
 · tablet arm not available

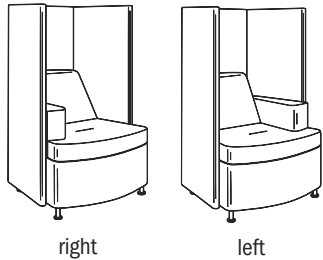
Specifications

Dimensions	D	W	H
Overall	31 ¾	33 ½	50
Seat	20 ½	23	17 ¾
Upholstery		Shipping	
COM Ydg	9	Ctn Wt	133
COL Sq Ft	181	Cu Ft	37
		Chair Wt	122

List Price Per Grade

COM	\$3,251
A	\$3,343
B	\$3,523
COL/C	\$3,841
D	\$4,248
E	\$4,655
F	\$5,287
G	\$5,967
H	\$6,691
I	\$7,821
J	\$9,179
L1	\$6,464
L2	\$7,369

22 ½° Convex Club Chair with Arm and Privacy Surround



MT0225UAR
MT0225UAL
 · tablet arm not available

Dimensions	D	W	H
Overall	31 ¾	33 ½	50
Seat	20 ½		17 ¾
Upholstery		Shipping	
COM Ydg	8 ½	Ctn Wt	130
COL Sq Ft	171	Cu Ft	37
		Chair Wt	117

COM	\$3,193
A	\$3,279
B	\$3,450
COL/C	\$3,748
D	\$4,132
E	\$4,517
F	\$5,113
G	\$5,754
H	\$6,436
I	\$7,503
J	\$8,783
L1	\$6,223
L2	\$7,076

To Order, Specify:

- 1 Model Number
- 2 Fabric Selection - vendor, pattern and color
 - A. Chair
 - B. Seat Cushion
 - C. Privacy Surround
 Visit www.jsifurniture.com/finishes-and-materials/textiles for our textiles program. See selection of standard and graded in manufacturers and patterns.
- 3 Optional Casters; add \$111 list
- 4 Optional Wood Feet; add \$71 list and specify finish
- 5 Optional Arm Cap; specify wood species, finish or 3D Laminate and add \$313 list per arm
- 6 Optional Power Center - Privacy Surround Flush Mount (EC22) - Black (B) or White (W); add \$583 list each and specify left or right.

Specifications

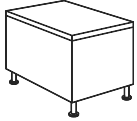
- Metal leg standard with 2 ¾" diameter leveling disc.
- Frame is puzzle jointed plywood construction.
- Seat has synthetic sheet webbing with cross strap reinforcement and 3 ¼" multi-density high resilience polyurethane foam.
- Back has 1 ¾" multi-density high resilience polyurethane foam.
- Upholstered arms are standard.
- Arm tops have 1" high resilience polyurethane foam.
- Optional arm cap is available in Maple, Walnut or Cherry.
- Upholstered privacy screen has polyurethane foam.

Description	D	W	H	CTN WT	CU FT	① Model	Flat Cut List Price	Double Cut List Price
Linking Drum Table	25 13/16	25 13/16	15	48	9	MTV2525DTC	\$3,243	\$3,566



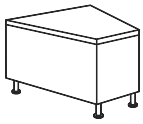
- quarter round
- power unit available, see page MT64

Linking Drum Table	22 1/4	15	15	40	5	MTV1522DTS	\$1,248	\$1,374
--------------------	--------	----	----	----	---	------------	---------	---------



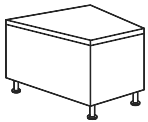
- rectangle
- power unit available, see page MT64

Linking Drum Table	22 1/4	22 1/4	15	47	6	MTV2230DTW	\$1,500	\$1,649
--------------------	--------	--------	----	----	---	------------	---------	---------



- 30° wedge
- power unit available, see page MT64

Linking Drum Table	22 1/4	22 1/4	15	49	6	MTV2222DTW	\$1,507	\$1,659
--------------------	--------	--------	----	----	---	------------	---------	---------




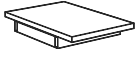
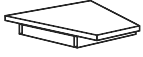
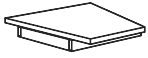
- 22 1/2° wedge
- power unit available, see page MT64

To Order, Specify:

- ① Model Number
- ② Wood Species - Cherry (CH1), Maple (MA1), Walnut (WA1) or Double Cut (DC1)
- ③ Wood Finish [See Wood Finish Options](#)
- ④ Optional Wood Feet; add \$71 list and specify finish
- ⑤ Power Unit
 - Linking Drum Table - Node; specify with EC24 and order separately, see page MT64.
- ⑥ Optional Wood Grain Laminate Top - no upcharge. Finishes with an asterisk (*) have a coordinating laminate available.

Specifications

- Metal leg standard with 2 3/8" diameter leveling disc.
- Plywood construction with glue, dowel, and metal fasteners.
- Linking bracket included to attach to lounge.

Description	D	W	H	CTN WT	CU FT	① Model	Laminate	Veneer	
							HPL	Flat Cut	Double Cut
Linking Table Top 	25 13/16	25 13/16	15	28	4	MTT2525LTC	\$1,178		
	25 13/16	25 13/16	15	28	4	MTV2525LTC		\$1,240	\$1,365
· quarter round									
Linking Table Top 	22 1/4	15	15	18	2	MTT1522LTS	\$1,066		
	22 1/4	15	15	18	2	MTV1522LTS		\$1,123	\$1,235
· rectangular									
Linking Table Top 	22 1/4	22 1/4	15	22	3	MTT2230LTW	\$1,123		
	22 1/4	22 1/4	15	22	3	MTV2230LTW		\$1,179	\$1,299
· 30° wedge									
Linking Table Top 	22 1/4	22 1/4	15	22	3	MTT2222LTW	\$1,123		
	22 1/4	22 1/4	15	22	3	MTV2222LTW		\$1,179	\$1,299
· 22 1/2° wedge									

To Order, Specify:

Veneer Models

- ① Model Number
- ② Wood Species - Cherry (CH1), Maple (MA1), Walnut (WA1) or Double Cut (DC1)
- ③ Wood Finish [See Wood Finish Options](#)

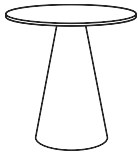
Laminate Models

- ① Model Number
- ② Laminate Color [See Laminate Color Options](#)

Specifications

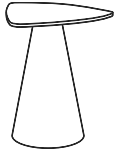
- 1" thick top with wood rim or PVC edge on silver metal frame.
- Permanent bolt attachment through side of adjacent lounge unit.

Description	D	W	H	CTN WT	CU FT	① Model	Flat Cut List Price	Double Cut List Price
Conical Base Pull-Up Table	22	22	26	48	7	MTVP22ROUN	\$1,517	\$1,670
	26	26	26	51	8	MTVP26ROUN	\$1,542	\$1,698
	30	30	26	52	9	MTVP30ROUN	\$1,571	\$1,731



- round top
- power unit not available

Conical Base Pull-Up Table	22	22	26	46	7	MTVP22TRI	\$1,517	\$1,670
	26	26	26	49	8	MTVP26TRI	\$1,542	\$1,698

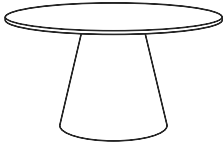


- triangle top
- power unit not available

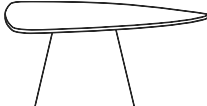
Conical Base Pull-Up Table	22	22	26	47	7	MTVP22SQCL	\$1,517	\$1,670
	26	26	26	50	8	MTVP26SQCL	\$1,542	\$1,698



- squircle top
- power unit not available

Description	D	W	H	CTN WT	CU FT	① Model	Flat Cut List Price	Double Cut List Price
	36	36	26	116	16	MTVF36ROUN	\$2,170	\$2,388
	42	42	26	127	17	MTVF42ROUN	\$2,242	\$2,468
	48	48	26	138	19	MTVF48ROUN	\$2,307	\$2,537
	54	54	26	152	21	MTVF54ROUN	\$2,390	\$2,629

- round top
- power unit available, see page MT64

	36	36	26	113	16	MTVF36TRI	\$2,197	\$2,416
	42	42	26	122	17	MTVF42TRI	\$2,255	\$2,481
	48	48	26	132	19	MTVF48TRI	\$2,307	\$2,537
	54	54	26	146	21	MTVF54TRI	\$2,390	\$2,629

- triangle top
- power unit available, see page MT64

	36	36	26	121	16	MTVF36SQCL	\$2,170	\$2,388
	42	42	26	134	17	MTVF42SQCL	\$2,242	\$2,468
	48	48	26	146	19	MTVF48SQCL	\$2,307	\$2,537
	54	54	26	162	21	MTVF54SQCL	\$2,390	\$2,629

- squircle top
- power unit available, see page MT64

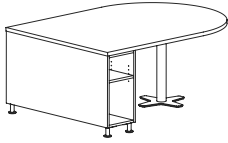
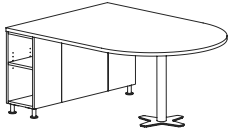
To Order, Specify:

- ① Model Number
- ② Top Material
 - A.) Veneer
 - 1.) Wood Species - Cherry (CH1), Maple (MA1) Walnut (WA1) or Double Cut (DC1)
 - 2.) Finish Color [See Top Wood Finish Options](#)
 - B.) Laminate
 - 1.) Laminate Color [See Laminate Color Options](#)
- ③ Conical Base Color [See Base Color Options](#)
- ④ Power Unit - Moire; specify with EC23 cut-out or Node; specify with EC24 cut-out. The EC23 and EC24 must be ordered separately, see page [MT64](#).

Moto

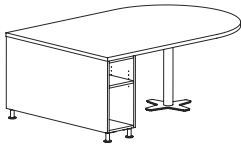
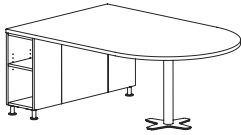


Description	D	W	H	CTN WT	CU FT	① Model	Laminate		Veneer	
							TFL Top	HPL Top	Flat Cut	Double Cut
Media Activity Center	48	66	28	245	24	MTT4866-28MATB	\$4,602	\$4,744		
	48	66	28	245	24	MTV4866-28MATB			\$5,728	\$6,300



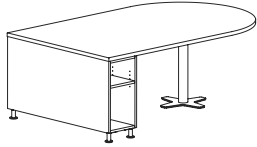
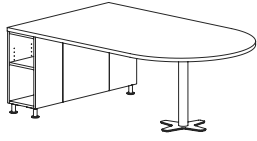
- bullet shape top
- 48" x 66" worksurface
- 28"h worksurface
- side access bookcase base; 12 ¼"w
- front center access panel

Media Activity Center	48	72	28	263	25	MTT4872-28MATB	\$4,664	\$4,809		
	48	72	28	263	25	MTV4872-28MATB			\$5,781	\$6,360



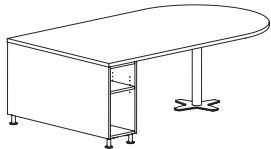
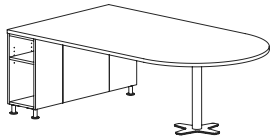
- bullet shape top
- 48" x 72" worksurface
- 28"h worksurface
- side access bookcase base; 12 ¼"w
- front center access panel

Description	D	W	H	CTN WT	CU FT	① Model	Laminate		Veneer	
							TFL Top	HPL Top	Flat Cut	Double Cut
Media Activity Center	48	78	28	281	26	MTT4878-28MATB	\$4,729	\$4,874		
	48	78	28	281	26	MTV4878-28MATB			\$5,806	\$6,387



- bullet shape top
- 48" x 78" worksurface
- 28"h worksurface
- side access bookcase base; 12 1/4"w
- front center access panel

Media Activity Center	48	84	28	299	27	MTT4884-28MATB	\$4,791	\$4,938		
	48	84	28	299	27	MTV4884-28MATB			\$5,893	\$6,484



- bullet shape top
- 48" x 84" worksurface
- 28"h worksurface
- side access bookcase base; 12 1/4"w
- front center access panel

To Order, Specify:

- ① Model Number
- ② Wood Species - Cherry (CH1), Maple (MA1), Walnut (WA1) or Double Cut (DC1)
- ③ Wood Finish [See Wood Finish Options](#)
- ④ Laminate Selection [See Laminate Options](#)
- ⑤ Optional Wood Feet; add \$71 list and specify finish
- ⑥ Optional Power Unit
 - Media Table - Ellora; specify with EC25 and order separately, see page MT64.
- ⑦ Optional Coordinating Wood Grain Laminate Table Top - no upcharge. Finishes with an asterisk (*) have a coordinating laminate available.

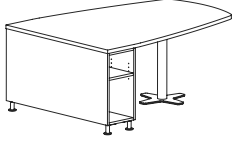
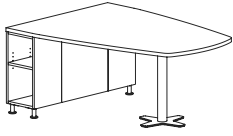
Specifications

- Metal leg standard with 2 3/8" diameter leveling disc.
- 3" diameter metal support post with integrated leveling and X-base with neoprene pads.
- Plywood construction with glue, dowel, and metal fasteners.
- 1 3/8" thick worksurface with radiused corners and a wood rim or PVC edge.
- Grommet in media panel
- Bookcase with side access and rear access. Each compartment has one adjustable shelf.
- Rear hinged doors for wire access.
- Removable lower panels for wire access.

Moto

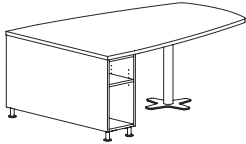
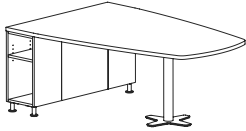


Description	D	W	H	CTN WT	CU FT	① Model	Laminate		Veneer	
							TFL Top	HPL Top	Flat Cut	Double Cut
Media Activity Center	48	66	28	240	24	MTT4866-28MATW	\$4,602	\$4,744		
	48	66	28	240	24	MTV4866-28MATW			\$5,728	\$6,300



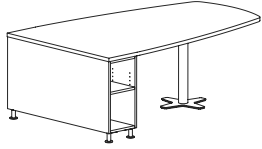
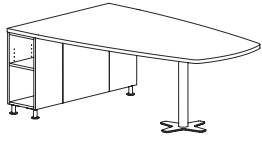
- wedge shape top
- 48" x 66" worksurface
- 28"h worksurface
- side access bookcase base; 12 1/4"w
- front center access panel

Media Activity Center	48	72	28	258	25	MTT4872-28MATW	\$4,664	\$4,809		
	48	72	28	258	25	MTV4872-28MATW			\$5,781	\$6,360



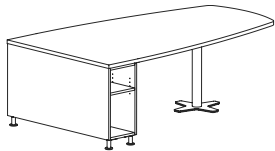
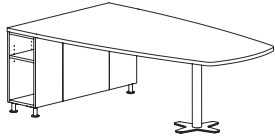
- wedge shape top
- 48" x 72" worksurface
- 28"h worksurface
- side access bookcase base; 12 1/4"w
- front center access panel

Description	D	W	H	CTN WT	CU FT	① Model	Laminate		Veneer	
							TFL Top	HPL Top	Flat Cut	Double Cut
Media Activity Center	48	78	28	276	26	MTT4878-28MATW	\$4,729	\$4,874		
	48	78	28	276	26	MTV4878-28MATW			\$5,806	\$6,387



- wedge shape top
- 48" x 78" worksurface
- 28"h worksurface
- side access bookcase base; 12 1/4"w
- front center access panel

Media Activity Center	48	84	28	294	27	MTT4884-28MATW	\$4,791	\$4,938		
	48	84	28	294	27	MTV4884-28MATW			\$5,893	\$6,484



- wedge shape top
- 48" x 84" worksurface
- 28"h worksurface
- side access bookcase base; 12 1/4"w
- front center access panel

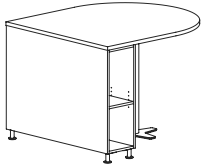
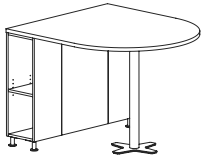
To Order, Specify:

- ① Model Number
- ② Wood Species - Cherry (CH1), Maple (MA1), Walnut (WA1) or Double Cut (DC1)
- ③ Wood Finish [See Wood Finish Options](#)
- ④ Laminate Selection [See Laminate Options](#)
- ⑤ Optional Wood Feet; add \$71 list and specify finish
- ⑥ Optional Power Unit
 - Media Table - Ellora; specify with EC25 and order separately, see page MT64.
- ⑦ Optional Coordinating Wood Grain Laminate Table Top - no upcharge. Finishes with an asterisk (*) have a coordinating laminate available.

Specifications

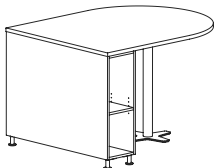
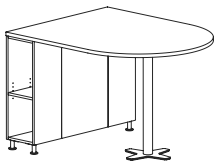
- Metal leg standard with 2 3/8" diameter leveling disc.
- 3" diameter metal support post with integrated leveling and X-base with neoprene pads.
- Plywood construction with glue, dowel, and metal fasteners.
- 1 3/8" thick worksurface with radiused corners and a wood rim or PVC edge.
- Grommet in media panel
- Bookcase with side access and rear access. Each compartment has one adjustable shelf.
- Rear hinged doors for wire access.
- Removable lower panels for wire access.

Description	D	W	H	CTN WT	CU FT	① Model	Laminate		Veneer	
							TFL Top	HPL Top	Flat Cut	Double Cut
Media Activity Center	48	54	39	241	27	MTT4854-39MATB	\$4,600	\$4,742		
	48	54	39	241	27	MTV4854-39MATB			\$5,788	\$6,368



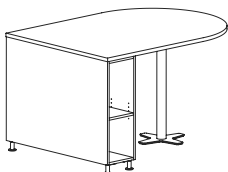
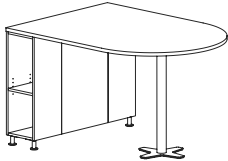
- bullet shape top
- 48" x 54" worksurface
- 39"h worksurface
- side access bookcase base; 12 ¼"w
- front center access panel

Media Activity Center	48	60	39	259	28	MTT4860-39MATB	\$4,651	\$4,796		
	48	60	39	259	28	MTV4860-39MATB			\$5,830	\$6,415



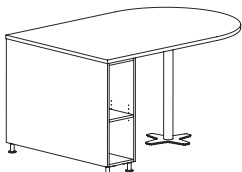
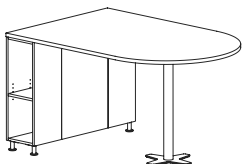
- bullet shape top
- 48" x 60" worksurface
- 39"h worksurface
- side access bookcase base; 12 ¼"w
- front center access panel

Media Activity Center	48	66	39	277	29	MTT4866-39MATB	\$4,777	\$4,924		
	48	66	39	277	29	MTV4866-39MATB			\$5,952	\$6,547



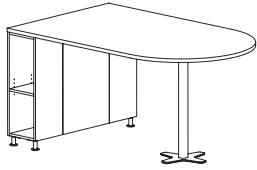
- bullet shape top
- 48" x 66" worksurface
- 39"h worksurface
- side access bookcase base; 12 ¼"w
- front center access panel

Media Activity Center	48	72	39	295	30	MTT4872-39MATB	\$4,838	\$4,988		
	48	72	39	295	30	MTV4872-39MATB			\$6,004	\$6,605

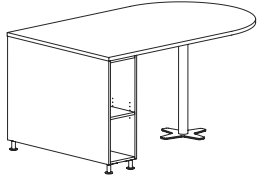


- bullet shape top
- 48" x 72" worksurface
- 39"h worksurface
- side access bookcase base; 12 ¼"w
- front center access panel

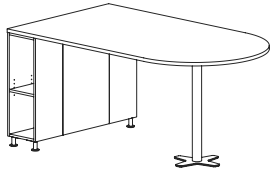
Description	D	W	H	CTN WT	CU FT	① Model	Laminate		Veneer	
							TFL Top	HPL Top	Flat Cut	Double Cut
Media Activity Center	48	78	39	313	31	MTT4878-39MATB	\$4,900	\$5,053		
	48	78	39	313	31	MTV4878-39MATB			\$6,057	\$6,665



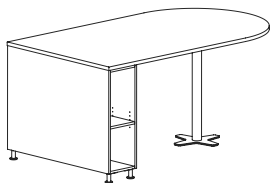
- bullet shape top
- 48" x 78" worksurface
- 39 h worksurface
- side access bookcase base; 12 1/4" w
- front center access panel



Media Activity Center	48	84	39	331	32	MTT4884-39MATB	\$4,964	\$5,116		
	48	84	39	331	32	MTV4884-39MATB			\$6,115	\$6,726



- bullet shape top
- 48" x 84" worksurface
- 39" h worksurface
- side access bookcase base; 12 1/4" w
- front center access panel



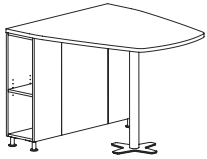
To Order, Specify:

- ① Model Number
- ② Wood Species - Cherry (CH1), Maple (MA1), Walnut (WA1) or Double Cut (DC1)
- ③ Wood Finish [See Wood Finish Options](#)
- ④ Laminate Selection [See Laminate Options](#)
- ⑤ Optional Wood Feet; add \$71 list and specify finish
- ⑥ Optional Power Unit
 - Media Table - Ellora; specify with EC25 and order separately, see page MT64.
- ⑦ Optional Coordinating Wood Grain Laminate Table Top - no upcharge. Finishes with an asterisk (*) have a coordinating laminate available.

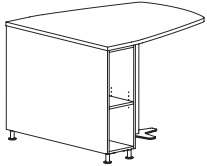
Specifications

- Metal leg standard with 2 3/8" diameter leveling disc.
- 3" diameter metal support post with integrated leveling and X-base with neoprene pads.
- Plywood construction with glue, dowel, and metal fasteners.
- 1 3/16" thick worksurface with radiused corners and a wood rim or PVC edge.
- Grommet in media panel
- Bookcase with side access and rear access. Each compartment has one adjustable shelf.
- Rear hinged doors for wire access.
- Removable lower panels for wire access.

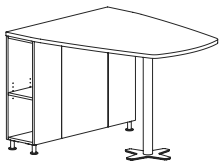
Description	D	W	H	CTN WT	CU FT	① Model	Laminate		Veneer	
							TFL Top	HPL Top	Flat Cut	Double Cut
Media Activity Center	48	54	39	236	27	MTT4854-39MATW	\$4,600	\$4,742		
	48	54	39	236	27	MTV4854-39MATW			\$5,788	\$6,368



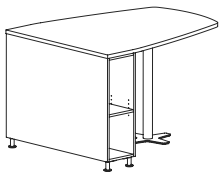
- wedge shape top
- 48" x 54" worksurface
- 39"h worksurface
- side access bookcase base; 12 ¼"w
- front center access panel



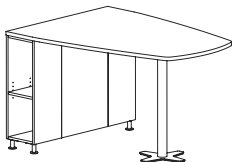
Media Activity Center	48	60	39	254	28	MTT4860-39MATW	\$4,651	\$4,796		
	48	60	39	254	28	MTV4860-39MATW			\$5,830	\$6,415



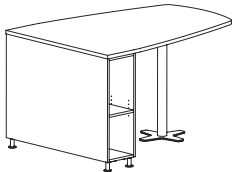
- wedge shape top
- 48" x 60" worksurface
- 39"h worksurface
- side access bookcase base; 12 ¼"w
- front center access panel



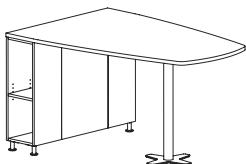
Media Activity Center	48	66	39	272	29	MTT4866-39MATW	\$4,777	\$4,924		
	48	66	39	272	29	MTV4866-39MATW			\$5,952	\$6,547



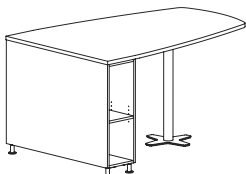
- wedge shape top
- 48" x 66" worksurface
- 39"h worksurface
- side access bookcase base; 12 ¼"w
- front center access panel



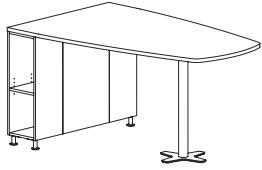
Media Activity Center	48	72	39	290	30	MTT4872-39MATW	\$4,838	\$4,988		
	48	72	39	290	30	MTV4872-39MATW			\$6,004	\$6,605



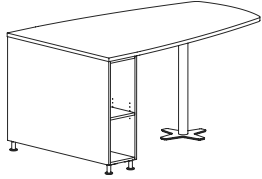
- wedge shape top
- 48" x 72" worksurface
- 39"h worksurface
- side access bookcase base; 12 ¼"w
- front center access panel



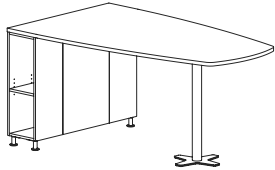
Description	D	W	H	CTN WT	CU FT	① Model	Laminate		Veneer	
							TFL Top	HPL Top	Flat Cut	Double Cut
Media Activity Center	48	78	39	308	31	MTT4878-39MATW	\$4,900	\$5,053		
	48	78	39	308	31	MTV4878-39MATW			\$6,057	\$6,665



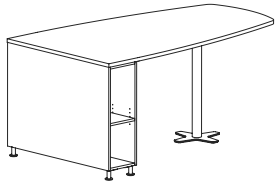
- wedge shape top
- 48" x 78" worksurface
- 39"h worksurface
- side access bookcase base; 12 1/4"w
- front center access panel



Media Activity Center	48	84	39	326	32	MTT4884-39MATW	\$4,964	\$5,116		
	48	84	39	326	32	MTV4884-39MATW			\$6,115	\$6,726



- wedge shape top
- 48" x 84" worksurface
- 39"h worksurface
- side access bookcase base; 12 1/4"w
- front center access panel



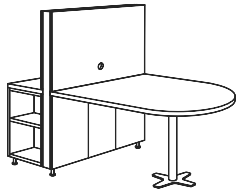
To Order, Specify:

- ① Model Number
- ② Wood Species - Cherry (CH1), Maple (MA1), Walnut (WA1) or Double Cut (DC1)
- ③ Wood Finish [See Wood Finish Options](#)
- ④ Laminate Selection [See Laminate Options](#)
- ⑤ Optional Wood Feet; add \$71 list and specify finish
- ⑥ Optional Power Unit
 - Media Table - Ellora; specify with EC25 and order separately, see page MT64.
- ⑦ Optional Coordinating Wood Grain Laminate Table Top - no upcharge. Finishes with an asterisk (*) have a coordinating laminate available.

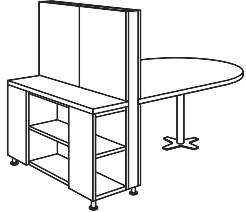
Specifications

- Metal leg standard with 2 3/8" diameter leveling disc.
- 3" diameter metal support post with integrated leveling and X-base with neoprene pads.
- Plywood construction with glue, dowel, and metal fasteners.
- 1 3/16" thick worksurface with radiused corners and a wood rim or PVC edge.
- Grommet in media panel
- Bookcase with side access and rear access. Each compartment has one adjustable shelf.
- Rear hinged doors for wire access.
- Removable lower panels for wire access.

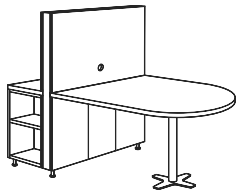
Description	D	W	H	CTN WT	CU FT	① Model	Laminate		Veneer	
							TFL Top	HPL Top	Flat Cut	Double Cut
Media Table	48	66	58	363	49	MTT4866-28MACB	\$5,507	\$5,677		
	48	66	58	363	49	MTV4866-28MACB			\$7,360	\$8,097



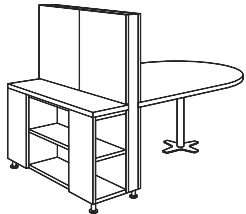
- bullet shape top
- 48" x 48" worksurface
- 28"h worksurface



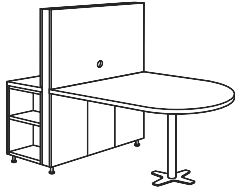
Media Table	48	72	58	381	52	MTT4872-28MACB	\$5,568	\$5,740		
	48	72	58	381	52	MTV4872-28MACB			\$7,413	\$8,155



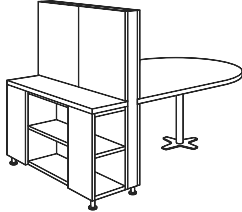
- bullet shape top
- 48" x 54" worksurface
- 28"h worksurface



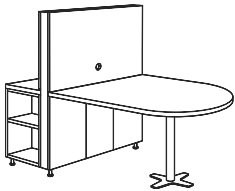
Description	D	W	H	CTN WT	CU FT	① Model	Laminate		Veneer	
							TFL Top	HPL Top	Flat Cut	Double Cut
Media Table	48	78	58	399	54	MTT4878-28MACB	\$5,632	\$5,805		
	48	78	58	399	54	MTV4878-28MACB			\$7,471	\$8,217



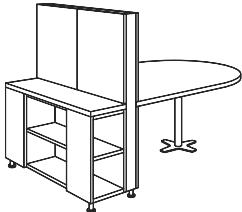
- bullet shape top
- 48" x 60" worksurface
- 28"h worksurface



Media Table	48	84	58	417	57	MTT4884-28MACB	\$5,693	\$5,869		
	48	84	58	417	57	MTV4884-28MACB			\$7,527	\$8,278



- bullet shape top
- 48" x 66" worksurface
- 28"h worksurface



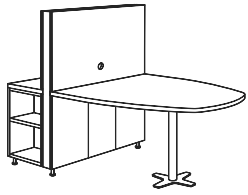
To Order, Specify:

- ① Model Number
 - ② Wood Species - Cherry (CH1), Maple (MA1), Walnut (WA1) or Double Cut (DC1)
 - ③ Wood Finish See [Wood Finish Options](#)
 - ④ Laminate Selection See [Laminate Options](#)
 - ⑤ Optional Wood Feet; add \$71 list and specify finish
 - ⑥ Optional Power Unit
 - Media Table - Ellora; specify with EC25 and order separately, see page MT64.
 - ⑦ Optional Markerboard Back Panel; for 24" unit add \$258 list, for 48" unit add \$501
 - ⑧ Deduct TV Bracket; subtract \$186 list
 - ⑨ Optional Door Locks; add \$142 list
- Optional Coordinating Wood Grain Laminate Table Top - no upcharge. Finishes with an asterisk (*) have a coordinating laminate available.

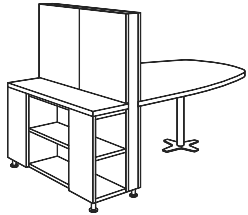
Specifications

- Metal leg standard with 2 3/8" diameter leveling disc.
- 3" diameter metal support post with integrated leveling and X-base with neoprene pads.
- Plywood construction with glue, dowel, and metal fasteners.
- 1 3/8" thick worksurface with radiused corners and a wood rim or PVC edge.
- Grommet in media panel
- TV bracket included. Recommended TV size 42".
- Bookcase with side access and rear access. Each compartment has one adjustable shelf.
- Rear hinged doors for wire access.
- Removable lower panels for wire access.

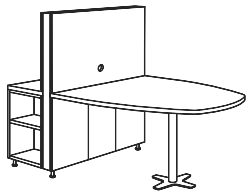
Description	D	W	H	CTN WT	CU FT	① Model	Laminate		Veneer	
							TFL Top	HPL Top	Flat Cut	Double Cut
Media Table	48	66	58	358	49	MTT4866-28MACW	\$5,507	\$5,677		
	48	66	58	358	49	MTV4866-28MACW			\$7,360	\$8,097



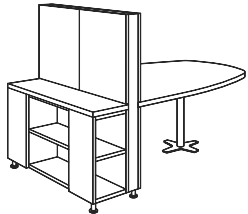
- wedge shape top
- 48" x 48" worksurface
- 28"h worksurface



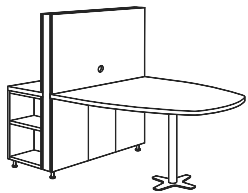
Media Table	48	72	58	374	51	MTT4872-28MACW	\$5,568	\$5,740		
	48	72	58	374	51	MTV4872-28MACW			\$7,413	\$8,155



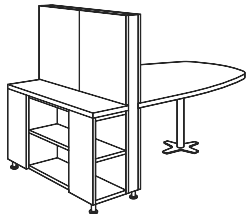
- wedge shape top
- 48" x 54" worksurface
- 28"h worksurface



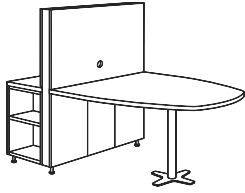
Media Table	48	78	58	391	53	MTT4878-28MACW	\$5,632	\$5,805		
	48	78	58	391	53	MTV4878-28MACW			\$7,471	\$8,217



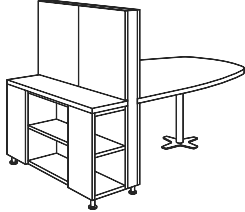
- wedge shape top
- 48" x 60" worksurface
- 28"h worksurface



Description	D	W	H	CTN WT	CU FT	① Model	Laminate		Veneer	
							TFL Top	HPL Top	Flat Cut	Double Cut
Media Table	48	84	58	407	56	MTT4884-28MACW	\$5,693	\$5,869		
	48	84	58	407	56	MTV4884-28MACW			\$7,527	\$8,278



- wedge shape top
- 48" x 66" worksurface
- 28"h worksurface



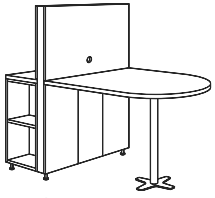
To Order, Specify:

- ① Model Number
 - ② Wood Species - Cherry (CH1), Maple (MA1), Walnut (WA1) or Double Cut (DC1)
 - ③ Wood Finish See [Wood Finish Options](#)
 - ④ Laminate Selection See [Laminate Options](#)
 - ⑤ Optional Wood Feet; add \$71 list and specify finish
 - ⑥ Optional Power Unit
 - Media Table - Ellora; specify with EC25 and order separately, see page MT64.
 - ⑦ Optional Markerboard Back Panel; for 24" unit add \$258 list, for 48" unit add \$501
 - ⑧ Deduct TV Bracket; subtract \$186 list
 - ⑨ Optional Door Locks; add \$142 list
- Optional Coordinating Wood Grain Laminate Table Top - no upcharge. Finishes with an asterisk (*) have a coordinating laminate available.

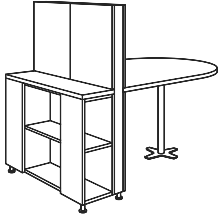
Specifications

- Metal leg standard with 2 3/8" diameter leveling disc.
- 3" diameter metal support post with integrated leveling and X-base with neoprene pads.
- Plywood construction with glue, dowel, and metal fasteners.
- 1 3/8" thick worksurface with radiused corners and a wood rim or PVC edge.
- Grommet in media panel
- TV bracket included. Recommended TV size 42".
- Bookcase with side access and rear access. Each compartment has one adjustable shelf.
- Rear hinged doors for wire access.
- Removable lower panels for wire access.

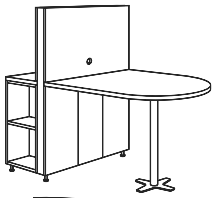
Description	D	W	H	CTN WT	CU FT	① Model	Laminate		Veneer	
							TFL Top	HPL Top	Flat Cut	Double Cut
Media Table	48	54	68	367	51	MTT4854-39MACB	\$5,496	\$5,664		
	48	54	68	367	51	MTV4854-39MACB			\$7,413	\$8,155



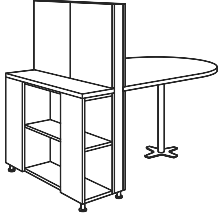
- bullet shape top
- 48" x 36" worksurface
- 39"h worksurface



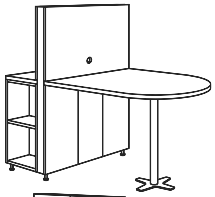
Media Table	48	60	68	385	54	MTT4860-39MACB	\$5,547	\$5,718		
	48	60	68	385	54	MTV4860-39MACB			\$7,458	\$8,204



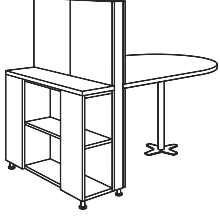
- bullet shape top
- 48" x 42" worksurface
- 39"h worksurface



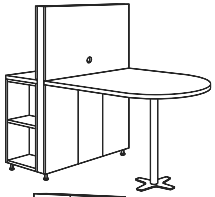
Media Table	48	66	68	403	56	MTT4866-39MACB	\$5,675	\$5,849		
	48	66	68	403	56	MTV4866-39MACB			\$7,577	\$8,335



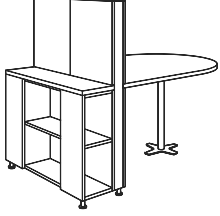
- bullet shape top
- 48" x 48" worksurface
- 39"h worksurface



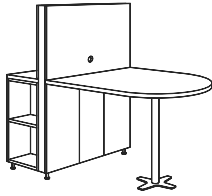
Media Table	48	72	68	421	59	MTT4872-39MACB	\$5,732	\$5,909		
	48	72	68	421	59	MTV4872-39MACB			\$7,630	\$8,394



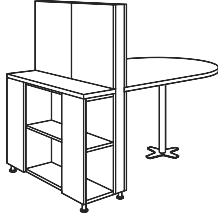
- bullet shape top
- 48" x 54" worksurface
- 39"h worksurface



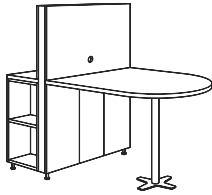
Description	D	W	H	CTN WT	CU FT	① Model	Laminate		Veneer	
							TFL Top	HPL Top	Flat Cut	Double Cut
Media Table	48	78	68	439	61	MTT4878-39MACB	\$5,797	\$5,976		
	48	78	68	439	61	MTV4878-39MACB			\$7,687	\$8,457



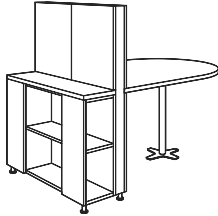
- bullet shape top
- 48" x 60" worksurface
- 39"h worksurface



Media Table	48	84	68	457	64	MTT4884-39MACB	\$5,861	\$6,042		
	48	84	68	457	64	MTV4884-39MACB			\$7,745	\$8,519



- bullet shape top
- 48" x 66" worksurface
- 39"h worksurface



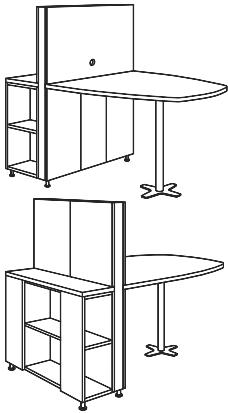
To Order, Specify:

- ① Model Number
 - ② Wood Species - Cherry (CH1), Maple (MA1), Walnut (WA1) or Double Cut (DC1)
 - ③ Wood Finish See [Wood Finish Options](#)
 - ④ Laminate Selection See [Laminate Options](#)
 - ⑤ Optional Wood Feet; add \$71 list and specify finish
 - ⑥ Optional Power Unit
 - Media Table - Ellora; specify with EC25 and order separately, see page MT64.
 - ⑦ Optional Markerboard Back Panel; for 24" unit add \$258 list, for 48" unit add \$501
 - ⑧ Deduct TV Bracket; subtract \$186 list
 - ⑨ Optional Door Locks; add \$142 list
- Optional Coordinating Wood Grain Laminate Table Top - no upcharge. Finishes with an asterisk (*) have a coordinating laminate available.

Specifications

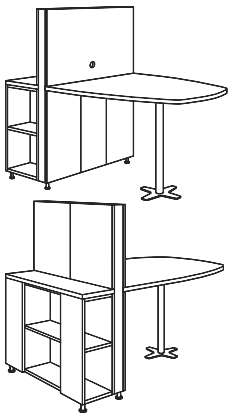
- Metal leg standard with 2 3/8" diameter leveling disc.
- 3" diameter metal support post with integrated leveling and X-base with neoprene pads.
- Plywood construction with glue, dowel, and metal fasteners.
- 1 3/8" thick worksurface with radiused corners and a wood rim or PVC edge.
- Grommet in media panel
- TV bracket included. Recommended TV size 42".
- Bookcase with side access and rear access. Each compartment has one adjustable shelf.
- Rear hinged doors for wire access.
- Removable lower panels for wire access.

Description	D	W	H	CTN WT	CU FT	① Model	Laminate		Veneer	
							TFL Top	HPL Top	Flat Cut	Double Cut
Media Table	48	54	68	365	51	MTT4854-39MACW	\$5,496	\$5,664		
	48	54	68	365	51	MTV4854-39MACW			\$7,413	\$8,155



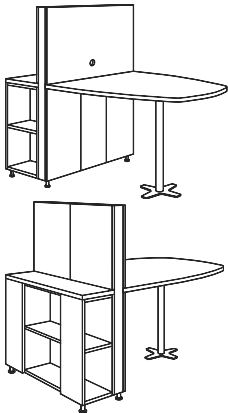
- wedge shape top
- 48" x 36" worksurface
- 39"h worksurface

Media Table	48	60	68	381	53	MTT4860-39MACW	\$5,547	\$5,718		
	48	60	68	381	53	MTV4860-39MACW			\$7,458	\$8,204



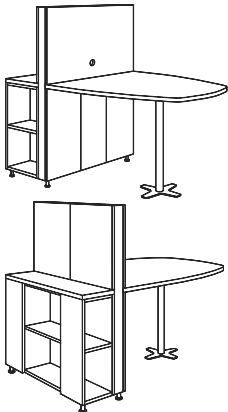
- wedge shape top
- 48" x 42" worksurface
- 39"h worksurface

Media Table	48	66	68	398	56	MTT4866-39MACW	\$5,675	\$5,849		
	48	66	68	398	56	MTV4866-39MACW			\$7,577	\$8,335



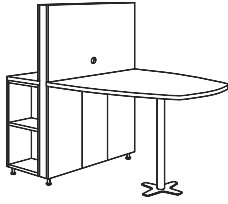
- wedge shape top
- 48" x 48" worksurface
- 39"h worksurface

Media Table	48	72	68	414	58	MTT4872-39MACW	\$5,732	\$5,909		
	48	72	68	414	58	MTV4872-39MACW			\$7,630	\$8,394

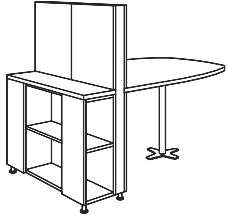


- wedge shape top
- 48" x 54" worksurface
- 39"h worksurface

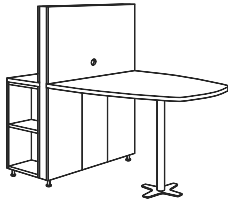
Description	D	W	H	CTN WT	CU FT	① Model	Laminate		Veneer	
							TFL Top	HPL Top	Flat Cut	Double Cut
Media Table	48	78	68	431	60	MTT4878-39MACW	\$5,797	\$5,976		
	48	78	68	431	60	MTV4878-39MACW			\$7,687	\$8,457



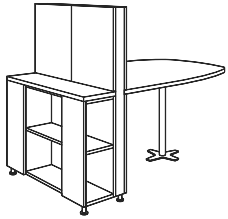
- wedge shape top
- 48" x 60" worksurface
- 39"h worksurface



Media Table	48	84	68	447	63	MTT4884-39MACW	\$5,861	\$6,042		
	48	84	68	447	63	MTV4884-39MACW			\$7,745	\$8,519



- wedge shape top
- 48" x 66" worksurface
- 39"h worksurface



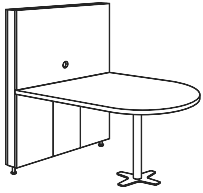
To Order, Specify:

- ① Model Number
- ② Wood Species - Cherry (CH1), Maple (MA1), Walnut (WA1) or Double Cut (DC1)
- ③ Wood Finish See [Wood Finish Options](#)
- ④ Laminate Selection See [Laminate Options](#)
- ⑤ Optional Wood Feet; add \$71 list and specify finish
- ⑥ Optional Power Unit
 - Media Table - Ellora; specify with EC25 and order separately, see page MT64.
- ⑦ Optional Markerboard Back Panel; for 24" unit add \$258 list, for 48" unit add \$501
- ⑧ Deduct TV Bracket; subtract \$186 list
- ⑨ Optional Door Locks; add \$142 list
 - Optional Coordinating Wood Grain Laminate Table Top - no upcharge. Finishes with an asterisk (*) have a coordinating laminate available.

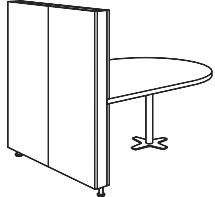
Specifications

- Metal leg standard with 2 3/8" diameter leveling disc.
- 3" diameter metal support post with integrated leveling and X-base with neoprene pads.
- Plywood construction with glue, dowel, and metal fasteners.
- 1 3/8" thick worksurface with radiused corners and a wood rim or PVC edge.
- Grommet in media panel
- TV bracket included. Recommended TV size 42".
- Bookcase with side access and rear access. Each compartment has one adjustable shelf.
- Rear hinged doors for wire access.
- Removable lower panels for wire access.

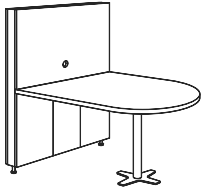
Description	D	W	H	CTN WT	CU FT	① Model	Laminate		Veneer	
							TFL Top	HPL Top	Flat Cut	Double Cut
Wall Dependent Media Table	48	54	58	217	20	MTT4854-28MAWB	\$4,398	\$4,531		
	48	54	58	217	20	MTV4854-28MAWB			\$5,447	\$5,993



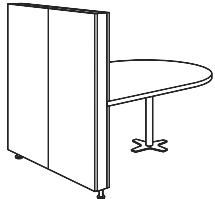
- bullet shape top
- 48" x 48" worksurface
- 28"h worksurface



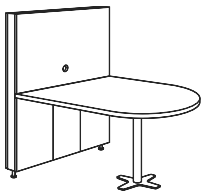
Wall Dependent Media Table	48	60	58	235	23	MTT4860-28MAWB	\$4,460	\$4,597		
	48	60	58	235	23	MTV4860-28MAWB			\$5,503	\$6,051



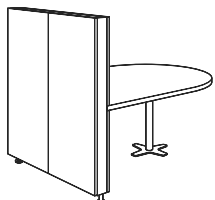
- bullet shape top
- 48" x 54" worksurface
- 28"h worksurface



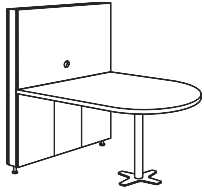
Wall Dependent Media Table	48	66	58	253	25	MTT4866-28MAWB	\$4,523	\$4,661		
	48	66	58	253	25	MTV4866-28MAWB			\$5,523	\$6,078



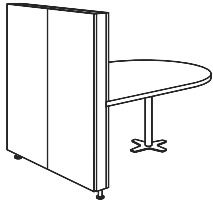
- bullet shape top
- 48" x 60" worksurface
- 28"h worksurface



Description	D	W	H	CTN WT	CU FT	① Model	Laminate		Veneer	
							TFL Top	HPL Top	Flat Cut	Double Cut
Wall Dependent Media Table	48	72	58	271	28	MTT4872-28MAWB	\$4,583	\$4,727		
	48	72	58	271	28	MTV4872-28MAWB			\$5,613	\$6,177



- bullet shape top
- 48" x 66" worksurface
- 28"h worksurface



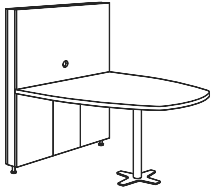
To Order, Specify:

- ① Model Number
- ② Wood Species - Cherry (CH1), Maple (MA1), Walnut (WA1) or Double Cut (DC1)
- ③ Wood Finish [See Wood Finish Options](#)
- ④ Laminate Selection [See Laminate Options](#)
- ⑤ Optional Wood Feet; add \$71 list and specify finish
- ⑥ Optional Power Unit
 - Media Table - Ellora; specify with EC25 and order separately, see page MT64.
- ⑦ Deduct TV Bracket; subtract \$186 list
- ⑧ Optional Door Locks; add \$142 list
- ⑨ Optional Coordinating Wood Grain Laminate Table Top - no upcharge. Finishes with an asterisk (*) have a coordinating laminate available.

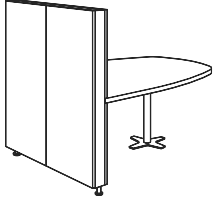
Specifications

- Metal leg standard with 2 3/8" diameter leveling disc.
- 3" diameter metal support post with integrated leveling and X-base with neoprene pads.
- Plywood construction with glue, dowel, and metal fasteners.
- 1 3/16" thick worksurface with radiused corners and a wood rim or PVC edge.
- Grommet in media panel
- TV bracket included. Recommended TV size 42".
- Rear hinged doors for wire access.
- Removable lower panels for wire access.
- Intended for use against a wall. Does not attach to the wall.

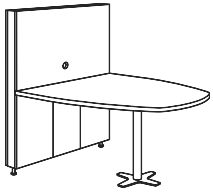
Description	D	W	H	CTN WT	CU FT	① Model	Laminate		Veneer	
							TFL Top	HPL Top	Flat Cut	Double Cut
Wall Dependent Media Table	48	54	58	212	20	MTT4854-28MAWW	\$4,398	\$4,531		
	48	54	58	212	20	MTV4854-28MAWW			\$5,447	\$5,993



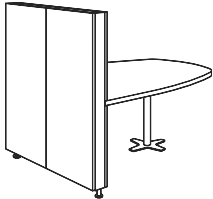
- wedge shape top
- 48" x 48" worksurface
- 28"h worksurface



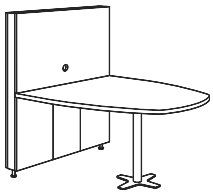
Wall Dependent Media Table	48	60	58	228	22	MTT4860-28MAWW	\$4,460	\$4,597		
	48	60	58	228	22	MTV4860-28MAWW			\$5,503	\$6,051



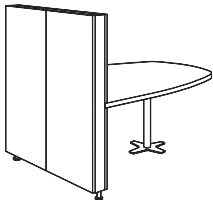
- wedge shape top
- 48" x 54" worksurface
- 28"h worksurface



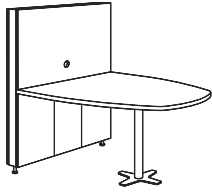
Wall Dependent Media Table	48	66	58	245	24	MTT4866-28MAWW	\$4,523	\$4,661		
	48	66	58	245	24	MTV4866-28MAWW			\$5,523	\$6,078



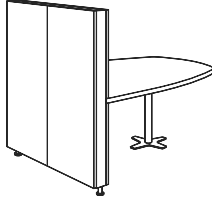
- wedge shape top
- 48" x 60" worksurface
- 28"h worksurface



Description	D	W	H	CTN WT	CU FT	① Model	Laminate		Veneer	
							TFL Top	HPL Top	Flat Cut	Double Cut
Wall Dependent Media Table	48	72	58	261	27	MTT4872-28MAWW	\$4,583	\$4,727		
	48	72	58	261	27	MTV4872-28MAWW			\$5,613	\$6,177



- wedge shape top
- 48" x 66" worksurface
- 28"h worksurface



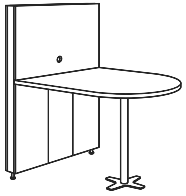
To Order, Specify:

- ① Model Number
- ② Wood Species - Cherry (CH1), Maple (MA1), Walnut (WA1) or Double Cut (DC1)
- ③ Wood Finish [See Wood Finish Options](#)
- ④ Laminate Selection [See Laminate Options](#)
- ⑤ Optional Wood Feet; add \$71 list and specify finish
- ⑥ Optional Power Unit
 - Media Table - Ellora; specify with EC25 and order separately, see page MT64.
- ⑦ Deduct TV Bracket; subtract \$186 list
- ⑧ Optional Door Locks; add \$142 list
- ⑨ Optional Coordinating Wood Grain Laminate Table Top - no upcharge. Finishes with an asterisk (*) have a coordinating laminate available.

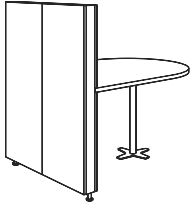
Specifications

- Metal leg standard with 2 3/8" diameter leveling disc.
- 3" diameter metal support post with integrated leveling and X-base with neoprene pads.
- Plywood construction with glue, dowel, and metal fasteners.
- 1 3/16" thick worksurface with radiused corners and a wood rim or PVC edge.
- Grommet in media panel
- TV bracket included. Recommended TV size 42".
- Rear hinged doors for wire access.
- Removable lower panels for wire access.
- Intended for use against a wall. Does not attach to the wall.

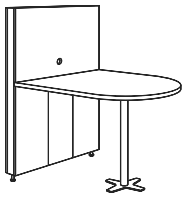
Description	D	W	H	CTN WT	CU FT	① Model	Laminate		Veneer	
							TFL Top	HPL Top	Flat Cut	Double Cut
Wall Dependent Media Table	48	42	68	204	17	MTT4842-39MAWB	\$4,394	\$4,528		
	48	42	68	204	17	MTV4842-39MAWB			\$5,494	\$6,044



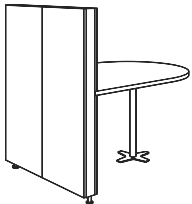
- bullet shape top
- 48" x 36" worksurface
- 39"h worksurface



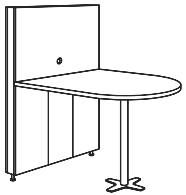
Wall Dependent Media Table	48	48	68	222	20	MTT4848-39MAWB	\$4,443	\$4,580		
	48	48	68	222	20	MTV4848-39MAWB			\$5,541	\$6,092



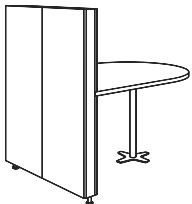
- bullet shape top
- 48" x 42" worksurface
- 39"h worksurface



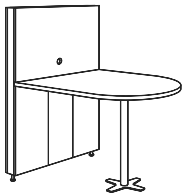
Wall Dependent Media Table	48	54	68	240	22	MTT4854-39MAWB	\$4,572	\$4,710		
	48	54	68	240	22	MTV4854-39MAWB			\$5,656	\$6,224



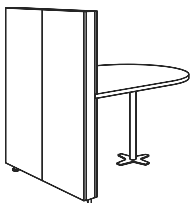
- bullet shape top
- 48" x 48" worksurface
- 39"h worksurface



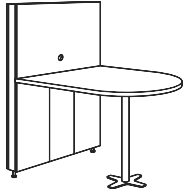
Wall Dependent Media Table	48	60	68	258	25	MTT4860-39MAWB	\$4,632	\$4,775		
	48	60	68	258	25	MTV4860-39MAWB			\$5,713	\$6,284



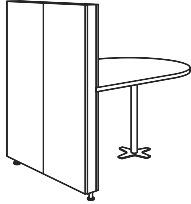
- bullet shape top
- 48" x 54" worksurface
- 39"h worksurface



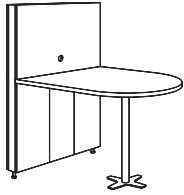
Description	D	W	H	CTN WT	CU FT	① Model	Laminate		Veneer	
							TFL Top	HPL Top	Flat Cut	Double Cut
Wall Dependent Media Table	48	66	68	276	27	MTT4866-39MAWB	\$4,696	\$4,838		
	48	66	68	276	27	MTV4866-39MAWB			\$5,767	\$6,343



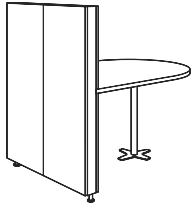
- bullet shape top
- 48" x 60" worksurface
- 39"h worksurface



Wall Dependent Media Table	48	72	68	294	30	MTT4872-39MAWB	\$4,756	\$4,905		
	48	72	68	294	30	MTV4872-39MAWB			\$5,821	\$6,404



- bullet shape top
- 48" x 66" worksurface
- 39" worksurface



To Order, Specify:

- ① Model Number
- ② Wood Species - Cherry (CH1), Maple (MA1), Walnut (WA1) or Double Cut (DC1)
- ③ Wood Finish [See Wood Finish Options](#)
- ④ Laminate Selection [See Laminate Options](#)
- ⑤ Optional Wood Feet; add \$71 list and specify finish
- ⑥ Optional Power Unit
 - Media Table - Ellora; specify with EC25 and order separately, see page MT64.
- ⑦ Deduct TV Bracket; subtract \$186 list
- ⑧ Optional Door Locks; add \$142 list
- ⑨ Optional Coordinating Wood Grain Laminate Table Top - no upcharge. Finishes with an asterisk (*) have a coordinating laminate available.

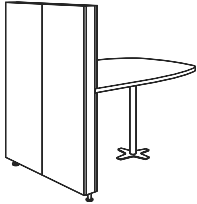
Specifications

- Metal leg standard with 2 3/8" diameter leveling disc.
- 3" diameter metal support post with integrated leveling and X-base with neoprene pads.
- Plywood construction with glue, dowel, and metal fasteners.
- 1 3/16" thick worksurface with radiused corners and a wood rim or PVC edge.
- Grommet in media panel
- TV bracket included. Recommended TV size 42".
- Rear hinged doors for wire access.
- Removable lower panels for wire access.
- Intended for use against a wall. Does not attach to the wall.

Description	D	W	H	CTN WT	CU FT	① Model	Laminate		Veneer	
							TFL Top	HPL Top	Flat Cut	Double Cut
Wall Dependent Media Table	48	42	68	202	17	MTT4842-39MAWW	\$4,394	\$4,528		
	48	42	68	202	17	MTV4842-39MAWW			\$5,494	\$6,044



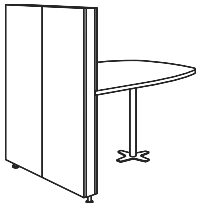
- wedge shape top
- 48" x 36" worksurface
- 39"h worksurface



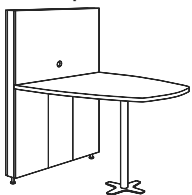
Wall Dependent Media Table	48	48	68	218	19	MTT4848-39MAWW	\$4,443	\$4,580		
	48	48	68	218	19	MTV4848-39MAWW			\$5,541	\$6,092



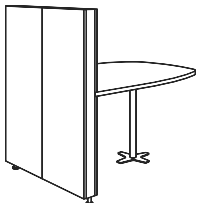
- wedge shape top
- 48" x 42" worksurface
- 39"h worksurface



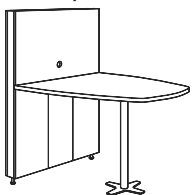
Wall Dependent Media Table	48	54	68	235	22	MTT4854-39MAWW	\$4,572	\$4,710		
	48	54	68	235	22	MTV4854-39MAWW			\$5,656	\$6,224



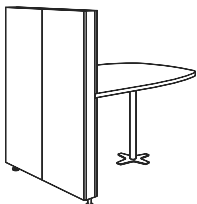
- wedge shape top
- 48" x 48" worksurface
- 39"h worksurface



Wall Dependent Media Table	48	60	68	251	24	MTT4860-39MAWW	\$4,632	\$4,775		
	48	60	68	251	24	MTV4860-39MAWW			\$5,713	\$6,284



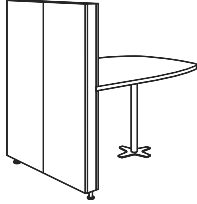
- wedge shape top
- 48" x 54" worksurface
- 39"h worksurface



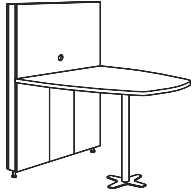
Description	D	W	H	CTN WT	CU FT	① Model	Laminate		Veneer	
							TFL Top	HPL Top	Flat Cut	Double Cut
Wall Dependent Media Table	48	66	68	268	26	MTT4866-39MAWW	\$4,696	\$4,838		
	48	66	68	268	26	MTV4866-39MAWW			\$5,767	\$6,343



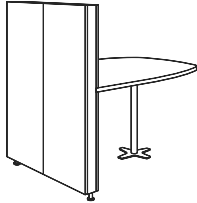
- wedge shape top
- 48" x 60" worksurface
- 39"h worksurface



Wall Dependent Media Table	48	72	68	284	29	MTT4872-39MAWW	\$4,756	\$4,905		
	48	72	68	284	29	MTV4872-39MAWW			\$5,821	\$6,404



- wedge shape top
- 48" x 66" worksurface
- 39"h worksurface



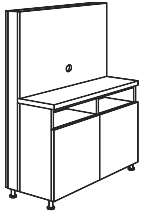
To Order, Specify:

- ① Model Number
- ② Wood Species - Cherry (CH1), Maple (MA1), Walnut (WA1) or Double Cut (DC1)
- ③ Wood Finish [See Wood Finish Options](#)
- ④ Laminate Selection [See Laminate Options](#)
- ⑤ Optional Wood Feet; add \$71 list and specify finish
- ⑥ Optional Power Unit
 - Media Table - Ellora; specify with EC25 and order separately, see page MT64.
- ⑦ Deduct TV Bracket; subtract \$186 list
- ⑧ Optional Door Locks; add \$142 list
- ⑨ Optional Coordinating Wood Grain Laminate Table Top - no upcharge. Finishes with an asterisk (*) have a coordinating laminate available.

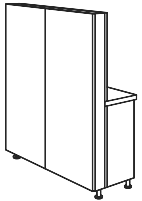
Specifications

- Metal leg standard with 2 3/8" diameter leveling disc.
- 3" diameter metal support post with integrated leveling and X-base with neoprene pads.
- Plywood construction with glue, dowel, and metal fasteners.
- 1 3/16" thick worksurface with radiused corners and a wood rim or PVC edge.
- Grommet in media panel
- TV bracket included. Recommended TV size 42".
- Rear hinged doors for wire access.
- Removable lower panels for wire access.
- Intended for use against a wall. Does not attach to the wall.

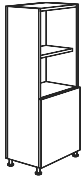
Description	D	W	H	CTN WT	CU FT	① Model	Laminate		Veneer	
							TFL Top	HPL Top	Flat Cut	Double Cut
Media Credenza	18	48	58	280	35	MTT1848MCW	\$3,740	\$3,853		
	18	48	58	280	35	MTV1848MCW			\$5,238	\$5,763



- 13" x 48" top surface
- 2 door cabinet

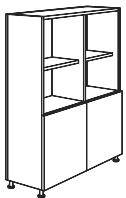


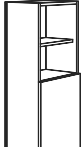
Description	D	W	H	CTN WT	CU FT	① Model	Laminate	Veneer	
								Flat Cut	Double Cut
Bookcase Storage	18	24	58	176	19	MTT1824-58SDR	\$1,450		
	18	24	58	176	19	MTV1824-58SDR		\$2,097	\$2,308
	18	24	58	176	19	MTT1824-58SDL	\$1,450		
	18	24	58	176	19	MTV1824-58SDL		\$2,097	\$2,308



- door hinge left or right

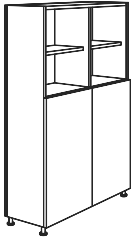
Bookcase Storage	18	48	58	227	35	MTT1848-58SDC	\$1,636		
	18	48	58	227	35	MTV1848-58SDC		\$2,293	\$2,525



Description	D	W	H	CTN WT	CU FT	① Model	Laminate	Veneer	
								Flat Cut	Double Cut
	18	24	68	199	22	MTT1824-68SDR	\$1,514		
	18	24	68	199	22	MTV1824-68SDR		\$2,178	\$2,394
	18	24	68	199	22	MTT1824-68SDL	\$1,514		
	18	24	68	199	22	MTV1824-68SDL		\$2,178	\$2,394

· door hinge left or right

Bookcase Storage	18	48	68	268	41	MTT1848-68SDC	\$1,811		
	18	48	68	268	41	MTV1848-68SDC		\$2,517	\$2,770



To Order, Specify:

- ① Model Number
- ② Wood Species - Cherry (CH1), Maple (MA1), Walnut (WA1) or Double Cut (DC1)
- ③ Wood Finish See [Wood Finish Options](#)
- ④ Laminate Selection See [Laminate Options](#)
- ⑤ Optional Wood Feet; add \$71 list and specify finish
- ⑥ Optional Power Unit
 - Media Credenza - Ellora; specify with EC25 and order separately, see page MT64.
- ⑦ Optional Markerboard Back Panel; for 24" unit add \$258 list, for 48" unit add \$501
- ⑧ Deduct TV Bracket; subtract \$186 list
- ⑨ Optional Door Locks; add \$142 list
 - Optional Coordinating Wood Grain Laminate Table
 - Top - no upcharge. Finishes with an asterisk (*) have a coordinating laminate available.

Specifications

Media Credenza

- Metal leg standard with 2 3/8" diameter leveling disc.
- Plywood construction with glue, dowel, and metal fasteners.
- Grommet in media panel
- TV bracket included. Recommended TV size 42".
- Open shelf with hinged door compartment below.
- Rear hinged doors for wire access.

Bookcase Storage

- Metal leg standard with 2 3/8" diameter leveling disc.
- Plywood construction with glue, dowel, and metal fasteners.
- Open shelf with hinged door compartment below.
- Adjustable shelves.

Description	D	W	H	CTN WT	CU FT	① Model	List Price
-------------	---	---	---	-----------	----------	---------	------------

Moire Power Unit	3 3/8	3 3/8	2	5	1	EC23	\$481
-------------------------	-------	-------	---	---	---	-------------	--------------



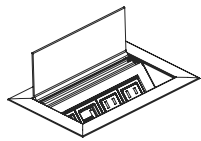
- used in Conical Work Tables
- 3 power & 1 Dual USB, 72" cord
- color: black or white

Node Power Unit	3 3/8	3 3/8	3/8	5	1	EC24	\$384
------------------------	-------	-------	-----	---	---	-------------	--------------



- used in Linking Drum Tables
- 1 power & 1 Dual USB, 72" cord
- color: black or white

Ellora Power Unit	5 1/2	8 1/2	3 1/2	5	1	EC25	\$736
--------------------------	-------	-------	-------	---	---	-------------	--------------



- used in Media Table or Media Credenza
- 2 power, 1 Dual USB & 1 opening for voice/data port, 72" power cord
- adapter kit provided to accept jacks for most port manufactures
- accepts one Type 3 telecom jack
- wire pass-through
- anodized aluminum

To Order, Specify:

- ① Model Number

Murphy Order Check List:



Specify:

- 1. Model Number
- 2. Wood Species - Maple (M)
- 3. Wood Finish/Paint Color
- 4. Fabric Selection - vendor, pattern and color
- 5. Optional Rubber Cushion Nylon Glides - no upcharge

Example:

373C | M | HRV | MOMENTUM | VOX | MYSTIC
 (model #) | (wood species) | (finish) | (fabric vendor) | (pattern name) | (pattern color)

1. Model Number

2. Wood Species - Maple (M)

3. Wood Finish/Color Options:

ALM Ale Medium	MINC Mineral Coordinate
CAL Ale Light Coordinate	MCH Mocha
BBM Bourbon Medium	CPI Pinnacle Walnut Coordinate
CBZ Brazilwood Coordinate	PRL Praline
BARC Barrel Coordinate	RAVC Raven Coordinate
CBO Bourbon Light Coordinate	SABC Sable Coordinate
CBG Brighton Light Coordinate	SIE Sienna
BRM Brighton Medium	CST Studio Teak Coordinate
BUT Butterscotch	TRF Truffle
CNDC Cinder Coordinate	UMB Umber
CLA Classic	VALC Valley Coordinate
CLL Collectors	VEN Venetian
EGRC Egret Coordinate	CWE Weathered Ash Coordinate
ESP Espresso	
FAWC Fawn Coordinate	
FLX Flax	
CGR Graphite Coordinate	
HRV Harvest	
CKC Khaki Coordinate	

Paint Color - Add \$45 list per item

BKD Backdrop	GRV Greek Villa
BFX Black Fox	GLF Gulf Stream
BWH Bright White	HTB Heartthrob
CGP Cargo Pants	NET Network Gray
CHT Chatroom	NWH Nonchalant White
DSY Daisy	PAR Paradise
DRG Daring	QXP Quixotic Plum
DYN Dynamo	RBZ Relic Bronze
ENG Enigma	SND Sandbank
FRR French Roast	STM Storm
GBY Georgian Bay	TRC Tricorn Black

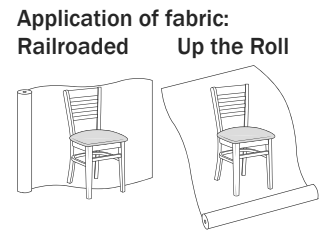
4. Fabric Selection - Please supply the following:
 Fabric vendor/Pattern name/Pattern color

For a complete list of JSI Standard and Graded-In Textiles click here



All COM orders must include the following:



- Vendor's name, pattern name and color
- Sample of the fabric attached to order
- Model numbers of items for fabric application
- Special application instructions (e.g., all stripes will be applied front to back unless specified otherwise)
- Customer and purchase order number

Ship prepaid COM material to:
 JSI
 Attn: COM Dept
 201 East Martin Street
 Receiving B, Dock 71
 Orleans, IN 47452



All COM orders will ship at standard lead time from receipt of COM except for orders requiring special custom matched finishes.

Description	Model	Specifications				List Price Per Grade	
Armless  373A all wood	373A All Wood 373C Uph. Seat · horizontal slat back	Dimensions	D	W	H	All Wood	\$470
		Overall	19 ¼	16 ¼	32 ¾	COM	\$530
 373C uph. seat		Seat	16	15 ½	18 ¼	A	\$546
		Upholstery		Shipping		B	\$567
		COM Ydg	¾	Ctn Wt	25	COL/C	\$603
		COL Sq Ft	9	Cu Ft	9	D	\$648
						E	\$693
						F	\$741
						G	\$806
						H	\$880
						I	\$990
						J	\$1,124
						L1	\$822
						L2	\$891

46¾" h Barstool	Model	Specifications				List Price Per Grade	
 378A all wood	378A All Wood 378C Uph. Seat · horizontal slat back · standard with brass scuff plate, also available in polished aluminum or matte black	Dimensions	D	W	H	All Wood	\$563
		Overall	22	19	43 ¾	COM	\$620
 378C uph. seat		Seat	16 ¼	19	29 ½	A	\$639
		Upholstery		Shipping		B	\$660
		COM Ydg	¾	Ctn Wt	30	COL/C	\$696
		COL Sq Ft	9	Cu Ft	13	D	\$737
						E	\$784
						F	\$831
						G	\$898
						H	\$970
						I	\$1,082
						J	\$1,215
						L1	\$912
						L2	\$985

To Order, Specify:

- 1 Model Number
- 2 Wood Species - Maple (M)
- 3 Wood Finish/Color [See Wood Finish/Color Options](#)
- 4 Fabric Selection - vendor, pattern and color
Visit www.jsifurniture.com/finishes-and-materials/textiles for our textiles program. See selection of standard and graded in manufacturers and patterns.
- 5 Optional Rubber Cushion Nylon Glides - no upcharge

Specifications

- Wood species - Maple.
- Seat is upholstered with 1 ½" polyurethane foam and synthetic sheet webbing for added comfort.
- Spiral grooved hardwood dowels with corner blocks, glue and screws.
- Standard with rubber cushion metal glides.

Newton Order Check List:



NEWTON

- Specify:**
- 1. Model Number
 - 2. Fabric Selection - vendor, pattern and color
 - 3. Arm Selection
 - A. Black polyurethane arm caps - standard
 - B. Aluminum Arm with black polyurethane arm caps - add \$188 list
 - 4. Control Selection
 - A. Swivel Tilt Mechanism - standard
 - B. Mid-Pivot Mechanism - add \$148 list
 - 5. Base Selection
 - A. Aluminum Base - add \$116 list
 - B. Black Polyurethane - standard
 - standard with casters
 - optional glides - add \$17 list
 - C. Black Pneumatic Jury Base - add \$203 list

Example:

NW5100 | MOMENTUM | VOX | MYSTIC
 (model #) | (fabric vendor) | (pattern name) | (pattern color)

1. Model Number

2. Fabric Selection - Please supply the following:
 Fabric vendor/Pattern name/Pattern color

For a complete list of JSI Standard and Graded-In Textiles click here

When specifying contrasting upholstery, indicate clearly which upholstery is to be applied to the seat, back and arms. Use higher grade pricing.

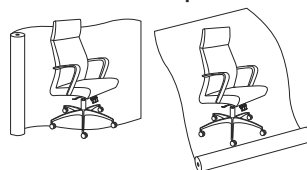
- Indicate direction of fabric - Railroaded or Up the Roll
- Please provide illustration, if available

All COM orders must include the following:

- Vendor's name, pattern name and color
- Sample of the fabric attached to order
- Model numbers of items for fabric application
- Special application instructions (e.g., all stripes will be applied front to back unless specified otherwise)
- Customer and purchase order number

Ship prepaid COM material to:
 JSI
 Attn: COM Dept
 201 East Martin Street
 Receiving B, Dock 71
 Orleans, IN 47452

Application of fabric:
 Railroaded Up the Roll



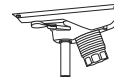
All COM orders will ship at standard lead time from receipt of COM except for orders requiring special custom matched finishes.

3. Arm Selection

- A. Black Polyurethane Arm Caps - standard
- B. Aluminum Arms with Black Polyurethane Arm Caps - add \$188 list

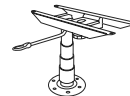
4. Control Selection

- A. Swivel Tilt Mechanism - standard
- B. Mid-Pivot Mechanism with tilt lock - add \$148 list



5. Base Selection

- A. Aluminum Base - add \$116 list
- B. Black Polyurethane - standard
 - standard with casters
 - optional glides - add \$17 list
- C. Black Pneumatic Jury Base - add \$203 list




Pneumatic lift- NOT self-centering - Standard


Newton


STANDARD SCALE




NEWTON


Description	① Model	Specifications				List Price Per Grade
		Dimensions	D	W	H	
Standard Scale Management Mid Back	NW5100 · armless · black polyurethane base · overall height range is 36 ½ - 40 ¼ · seat height range is 16 ¾ - 20 ½	Overall	26 ½	26 ½	40 ¼	COM \$1,205
		Seat	17 ½	20 ¼	20 ½	A \$1,224
		Upholstery		Shipping		B \$1,263
		COM Ydg	1 ¾	Ctn Wt	34	COL/C \$1,329
		COL Sq Ft	32	Cu Ft	17	D \$1,413
						E \$1,499
						F \$1,631
						G \$1,774
						H \$1,924
						I \$2,161
						J \$2,445
						L1 \$1,877
				L2 \$2,067		


Description	① Model	Specifications				List Price Per Grade
		Dimensions	D	W	H	
Standard Scale Management Mid Back	NW5110 · black polyurethane arms and base · overall height range is 36 ½ - 40 ¼ · seat height range is 16 ¾ - 20 ½ · arm height range is 25 ¼ - 29	Overall	26 ½	26 ½	40 ¼	COM \$1,360
		Seat	17 ½	20 ¼	20 ½	A \$1,380
		Arm			29	B \$1,418
		Upholstery		Shipping		COL/C \$1,484
		COM Ydg	1 ¾	Ctn Wt	38	D \$1,568
		COL Sq Ft	32	Cu Ft	17	E \$1,655
						F \$1,786
						G \$1,927
						H \$2,080
						I \$2,317
						J \$2,600
						L1 \$2,033
				L2 \$2,223		


Description	① Model	Specifications				List Price Per Grade
		Dimensions	D	W	H	
Standard Scale Executive High Back	NW5120 · armless · black polyurethane base · overall height range is 44 ¾ - 48 ½ · seat height range is 16 ¾ - 20 ½	Overall	26 ½	26 ½	48 ½	COM \$1,473
		Seat	17 ½	20 ¼	20 ½	A \$1,496
		Upholstery		Shipping		B \$1,539
		COM Ydg	2	Ctn Wt	42	COL/C \$1,615
		COL Sq Ft	36	Cu Ft	19	D \$1,713
						E \$1,810
						F \$1,960
						G \$2,123
						H \$2,295
						I \$2,567
						J \$2,891
						L1 \$2,241
				L2 \$2,458		

Description	① Model	Specifications				List Price Per Grade
		Dimensions	D	W	H	
Standard Scale Executive High Back	NW5121 · black polyurethane arms and base · overall height range is 44 ¾ - 48 ½ · seat height range is 16 ¾ - 20 ½ · arm height range is 25 ¼ - 29	Overall	26 ½	26 ½	48 ½	COM \$1,647
		Seat	17 ½	20 ¼	20 ½	A \$1,668
		Arm			29	B \$1,711
		Upholstery		Shipping		COL/C \$1,788
		COM Ydg	2	Ctn Wt	46	D \$1,885
		COL Sq Ft	36	Cu Ft	19	E \$1,983
						F \$2,134
						G \$2,295
						H \$2,469
						I \$2,740
						J \$3,063
						L1 \$2,414
				L2 \$2,632		

GRAND SCALE

Description	① Model	Specifications				List Price Per Grade	
		Dimensions	D	W	H	COM	
Grand Scale Management Mid Back	NW5130 · armless · black polyurethane base · overall height range is 37 ½ - 41 ¼ · seat height range is 16 ¾ - 20 ½	Overall	26 ½	26 ½	41 ¼	COM	\$1,252
		Seat	19 ¼	21 ¼	20 ½	COL/C	\$1,376
		Upholstery		Shipping		D	\$1,461
		COM Ydg	1 ¾	Ctn Wt	36	E	\$1,547
		COL Sq Ft	32	Cu Ft	17	F	\$1,679
					G	\$1,822	
					H	\$1,973	
					I	\$2,209	
					J	\$2,493	
					L1	\$1,925	
					L2	\$2,115	

Description	① Model	Specifications				List Price Per Grade	
		Dimensions	D	W	H	COM	
Grand Scale Management Mid Back	NW5140 · black polyurethane arms and base · overall height range is 37 ½ - 41 ¼ · seat height range is 16 ¾ - 20 ½ · arm height range is 25 ¼ - 29	Overall	26 ½	26 ½	41 ¼	COM	\$1,411
		Seat	19 ¼	21 ¼	20 ½	COL/C	\$1,535
		Arm			29	D	\$1,621
		Upholstery		Shipping		E	\$1,707
		COM Ydg	1 ¾	Ctn Wt	40	F	\$1,838
		COL Sq Ft	32	Cu Ft	17	G	\$1,981
					H	\$2,132	
					I	\$2,368	
					J	\$2,652	
					L1	\$2,084	
					L2	\$2,274	

Description	① Model	Specifications				List Price Per Grade	
		Dimensions	D	W	H	COM	
Grand Scale Executive High Back	NW5151 · black polyurethane arms and base · overall height range is 45 ¾ - 49 ½ · seat height range is 16 ¾ - 20 ½ · arm height range is 25 ¼ - 29	Overall	26 ½	26 ½	49 ½	COM	\$1,692
		Seat	19 ¼	21 ¼	20 ½	COL/C	\$1,851
		Arm			29	D	\$1,960
		Upholstery		Shipping		E	\$2,070
		COM Ydg	2 ¼	Ctn Wt	48	F	\$2,240
		COL Sq Ft	41	Cu Ft	19	G	\$2,424
					H	\$2,617	
					I	\$2,921	
					J	\$3,287	
					L1	\$2,556	
					L2	\$2,800	

To Order, Specify:

- ① Model Number
- ② Fabric Selection - vendor, pattern and color
 Visit www.jsifurniture.com/finishes-and-materials/textiles for our textiles program. See selection of standard and graded in manufacturers and patterns.
- ③ Arm Selection
 - A. Black Polyurethane Arm Caps - standard
 - B. Aluminum Arm with Black Polyurethane Arm Caps - add \$188 list

- ④ Control Selection
 - A. Swivel Tilt Mechanism - standard
 - B. Mid-Pivot Mechanism - add \$148 list
- ⑤ Base Selection
 - A. Aluminum Base - add \$116 list
 - B. Black Polyurethane Base - standard - standard with casters - optional glides - add \$17 list
 - C. Black Pneumatic Jury Base - add \$203 list

Specifications

- Wood species - Solid Birch plywood.
- Mortise and tenon construction with corner blocks, glue and screws.
- Seat has 3 ½" polyurethane foam with Dacron® wrap.
- Back has synthetic sheet webbing and 1" polyurethane foam.
- All models standard with swivel, tilt, pneumatic lift, tension adjustment and dual wheel casters.

Oxley Bench Order Check List:



Specify:

- 1. Model Number
- 2. Fabric Selection - vendor, pattern and color
- 3. Metal Frame Color - Arctic Silver (ASL), Matte Black (MBK), Pewter (PEW), Soft Nickel (SNK)

Example:

OX2178Q (model #)	MOMENTUM (fabric vendor)	BANGLE (pattern name)	CORK (pattern color)	ASL (metal frame color)
-----------------------------	------------------------------------	---------------------------------	--------------------------------	-----------------------------------

1. Model Number

2. Fabric Selection - Please supply the following:
Fabric vendor/Pattern name/Pattern color

JSI's full standard and graded in program is available on the standard "P" models.

For a complete list of JSI Standard and Graded-In Textiles click [here](#)

To ensure the best aesthetical and functional fit, a refined offering of upholsteries is being offered on the Quilted (Q) and Tufted (T) models. Leather NOT offered on Quilted (Q) models; contact Customer Service for availability

All COM orders must include the following:

- Vendor's name, pattern name and color
- Sample of the fabric attached to the order
- Model numbers of items for fabric application
- Special application instructions
- Customer and purchase order number

Ship prepaid COM

material to:

JSI
Attn: COM Dept
201 East Martin Street
Receiving B, Dock 71
Orleans, IN 47452

All COM orders will ship at standard lead time from receipt of COM except for orders requiring special custom matched finishes.

3. Metal Frame Color - specify color:

ABZ	Aged Bronze	PEW	Pewter
ASL	Arctic Silver	SBZ	Soft Bronze
GLD	Gold	SNK	Soft Nickel
MBK	Matte Black		

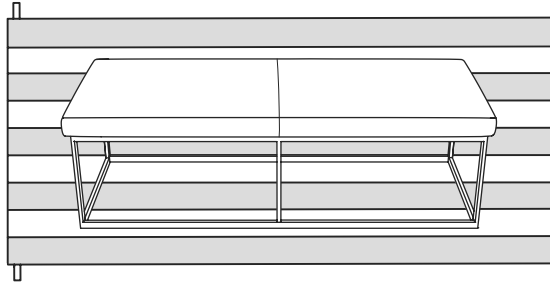
JSI's extended powdercoat program of bright colors is available, upon request, on Oxley. Contact Customer Service for a specific quote based on qty of units.

Upholstery Application

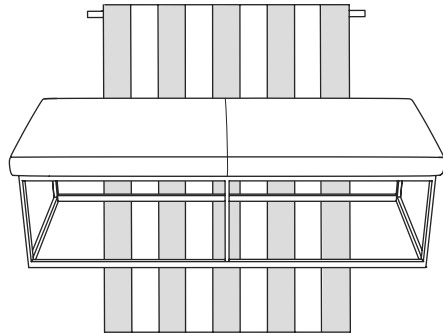
Fabric will be applied differently on the Oxley Benches dependent on style to best accommodate yardage use and aesthetics. Please see below graphics to help understand the different application methods. For **Plain (P)** models, the standard application will be “up the roll”, whereas for **Quilted (Q)** or **Tufted (T)** models, the standard application will be “railroaded”. Customers wanting fabric to be applied differently than stated above can be accommodated upon request. Additional seaming may be needed pending fabric width and textile repeat match, contact Customer Service with questions.

Leather not offered on Quilted (Q) models.

“Railroaded”



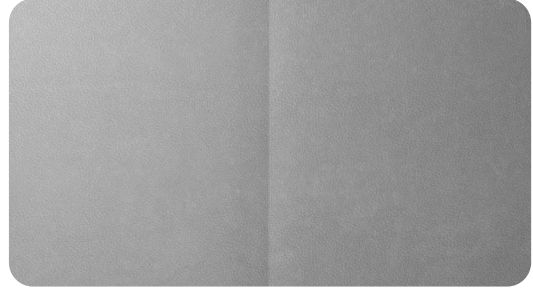
“Nap” or “Up the Roll”



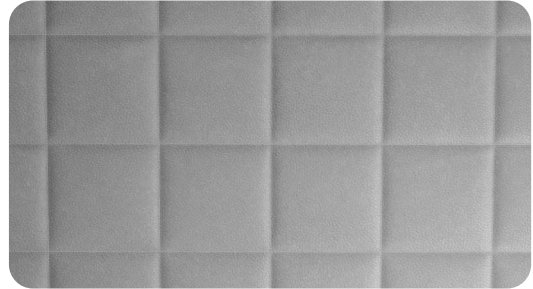
Upholstery Detail Selection

Oxley offers three types of upholstery detail: Plain, Quilted, and Tufted.

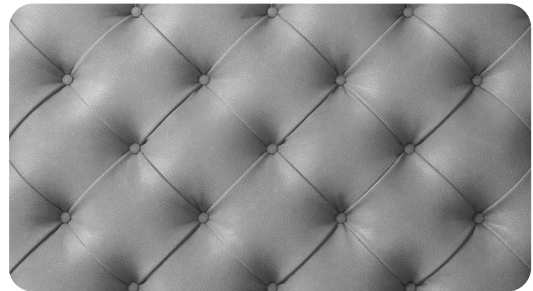
Plain



Quilted



Tufted

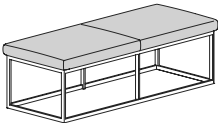
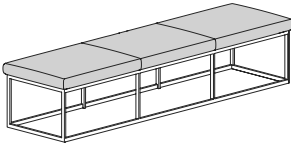
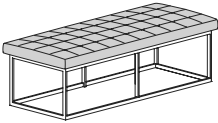
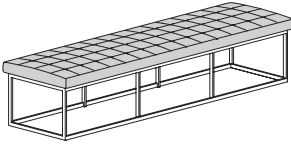


Metal Frame Construction

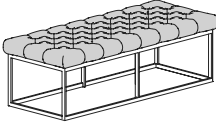
The frame is constructed of 1/2" x 1" rectangular fabricated steel. It is powdercoated with your choice of the following colors: Arctic Silver, Matte Black, Pewter, and Soft Nickel.

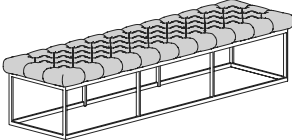


OXLEY

Description	Model	Specifications	List Price Per Grade												
Single Seat Bench 	OX2152P · upholstered seat · metal frame	<table border="1"> <thead> <tr> <th>Dimensions</th> <th>D</th> <th>W</th> <th>H</th> </tr> </thead> <tbody> <tr> <td>Overall</td> <td>20 ¾</td> <td>52 ½</td> <td>17</td> </tr> <tr> <td>Seat</td> <td>20 ¾</td> <td>52 ½</td> <td>17</td> </tr> </tbody> </table>	Dimensions	D	W	H	Overall	20 ¾	52 ½	17	Seat	20 ¾	52 ½	17	COM \$1,966 A \$1,995 B \$2,050 COL/C \$2,147 D \$2,272 E \$2,395 F \$2,590 G \$2,798 H \$3,020 I \$3,365 J \$3,782 L1 \$3,171 L2 \$3,504
		Dimensions	D	W	H										
Overall	20 ¾	52 ½	17												
Seat	20 ¾	52 ½	17												
<table border="1"> <thead> <tr> <th>Upholstery</th> <th colspan="3">Shipping</th> </tr> </thead> <tbody> <tr> <td>COM Ydg</td> <td>2 ¼</td> <td>Ctn Wt</td> <td>47</td> </tr> <tr> <td>COL Sq Ft</td> <td>54</td> <td>Cu Ft</td> <td>14</td> </tr> </tbody> </table>	Upholstery	Shipping			COM Ydg	2 ¼	Ctn Wt	47	COL Sq Ft	54	Cu Ft	14			
Upholstery	Shipping														
COM Ydg	2 ¼	Ctn Wt	47												
COL Sq Ft	54	Cu Ft	14												
Double Seat Bench 	OX2178P · upholstered seat · metal frame	<table border="1"> <thead> <tr> <th>Dimensions</th> <th>D</th> <th>W</th> <th>H</th> </tr> </thead> <tbody> <tr> <td>Overall</td> <td>20 ¾</td> <td>78 ½</td> <td>17</td> </tr> <tr> <td>Seat</td> <td>20 ¾</td> <td>78 ½</td> <td>17</td> </tr> </tbody> </table>	Dimensions	D	W	H	Overall	20 ¾	78 ½	17	Seat	20 ¾	78 ½	17	COM \$2,304 A \$2,344 B \$2,423 COL/C \$2,563 D \$2,742 E \$2,924 F \$3,203 G \$3,503 H \$3,824 I \$4,324 J \$4,924 L1 \$4,043 L2 \$4,525
		Dimensions	D	W	H										
Overall	20 ¾	78 ½	17												
Seat	20 ¾	78 ½	17												
<table border="1"> <thead> <tr> <th>Upholstery</th> <th colspan="3">Shipping</th> </tr> </thead> <tbody> <tr> <td>COM Ydg</td> <td>3 ¼</td> <td>Ctn Wt</td> <td>68</td> </tr> <tr> <td>COL Sq Ft</td> <td>78</td> <td>Cu Ft</td> <td>21</td> </tr> </tbody> </table>	Upholstery	Shipping			COM Ydg	3 ¼	Ctn Wt	68	COL Sq Ft	78	Cu Ft	21			
Upholstery	Shipping														
COM Ydg	3 ¼	Ctn Wt	68												
COL Sq Ft	78	Cu Ft	21												
Single Seat Quilted Bench 	OX2152Q · quilted seat · refined upholstery selection · metal frame · leather NOT available	<table border="1"> <thead> <tr> <th>Dimensions</th> <th>D</th> <th>W</th> <th>H</th> </tr> </thead> <tbody> <tr> <td>Overall</td> <td>20 ¾</td> <td>52 ½</td> <td>17</td> </tr> <tr> <td>Seat</td> <td>20 ¾</td> <td>52 ½</td> <td>17</td> </tr> </tbody> </table>	Dimensions	D	W	H	Overall	20 ¾	52 ½	17	Seat	20 ¾	52 ½	17	COM \$2,151 A \$2,179 B \$2,235 C \$2,330 D \$2,455 E \$2,579 F \$2,775 G \$2,983 H \$3,203 I \$3,549 J \$3,965
		Dimensions	D	W	H										
Overall	20 ¾	52 ½	17												
Seat	20 ¾	52 ½	17												
<table border="1"> <thead> <tr> <th>Upholstery</th> <th colspan="3">Shipping</th> </tr> </thead> <tbody> <tr> <td>COM Ydg</td> <td>2 ¼</td> <td>Ctn Wt</td> <td>47</td> </tr> <tr> <td></td> <td></td> <td>Cu Ft</td> <td>14</td> </tr> </tbody> </table>	Upholstery	Shipping			COM Ydg	2 ¼	Ctn Wt	47			Cu Ft	14			
Upholstery	Shipping														
COM Ydg	2 ¼	Ctn Wt	47												
		Cu Ft	14												
Double Seat Quilted Bench 	OX2178Q · quilted seat · refined upholstery selection · metal frame · leather NOT available	<table border="1"> <thead> <tr> <th>Dimensions</th> <th>D</th> <th>W</th> <th>H</th> </tr> </thead> <tbody> <tr> <td>Overall</td> <td>20 ¾</td> <td>78 ½</td> <td>17</td> </tr> <tr> <td>Seat</td> <td>20 ¾</td> <td>78 ½</td> <td>17</td> </tr> </tbody> </table>	Dimensions	D	W	H	Overall	20 ¾	78 ½	17	Seat	20 ¾	78 ½	17	COM \$2,561 A \$2,605 B \$2,691 C \$2,842 D \$3,034 E \$3,230 F \$3,531 G \$3,854 H \$4,199 I \$4,737 J \$5,384
		Dimensions	D	W	H										
Overall	20 ¾	78 ½	17												
Seat	20 ¾	78 ½	17												
<table border="1"> <thead> <tr> <th>Upholstery</th> <th colspan="3">Shipping</th> </tr> </thead> <tbody> <tr> <td>COM Ydg</td> <td>3 ½</td> <td>Ctn Wt</td> <td>68</td> </tr> <tr> <td></td> <td></td> <td>Cu Ft</td> <td>21</td> </tr> </tbody> </table>	Upholstery	Shipping			COM Ydg	3 ½	Ctn Wt	68			Cu Ft	21			
Upholstery	Shipping														
COM Ydg	3 ½	Ctn Wt	68												
		Cu Ft	21												

OXLEY

Description	① Model	Specifications			List Price Per Grade	
Single Seat Tufted Bench 	OX2152T · fold tufted seat · refined upholstery selection · metal frame	Dimensions	D	W	H	COM \$2,574
		Overall	21 ½	53 ¾	17 ¾	A \$2,621
		Seat	21 ½	53 ¾	17 ¾	B \$2,713
		Upholstery	Shipping			COL/C \$2,875
		COM Ydg	3 ¾	Ctn Wt	47	D \$3,082
		COL Sq Ft	98	Cu Ft	14	E \$3,289
						F \$3,613
						G \$3,958
						H \$4,327
						I \$4,905
						J \$5,597
						L1 \$4,580
						L2 \$5,136

Description	① Model	Specifications			List Price Per Grade	
Double Seat Tufted Bench 	OX2178T · fold tufted seat · refined upholstery selection · metal frame	Dimensions	D	W	H	COM \$3,114
		Overall	21 ½	79 ¾	17 ¾	A \$3,177
		Seat	21 ½	79 ¾	17 ¾	B \$3,298
		Upholstery	Shipping			COL/C \$3,517
		COM Ydg	5	Ctn Wt	68	D \$3,792
		COL Sq Ft	130	Cu Ft	21	E \$4,069
						F \$4,500
						G \$4,963
						H \$5,455
						I \$6,223
						J \$7,147
						L1 \$5,793
						L2 \$6,532

OXLEY

To Order, Specify:

- ① Model Number
- ② Fabric Selection - vendor, pattern and color
 Visit www.jsifurniture.com/finishes-and-materials/textiles for our textiles program. See selection of standard and graded in manufacturers and patterns.
- ③ Metal Frame Color See [Metal Frame Color Options](#)

Specifications

- Vented plywood seat board.
- Seat has high density high resilience polyurethane foam.
- Powdercoated fabricated steel frame.
- Standard with nylon glides.

Pillows Order Check List:



Specify:

- 1. Model Number
- 2. Fabric Selection - vendor, pattern and color
- 3. Optional Contrasting Welt or Button; add \$26 list
- 4. Optional Single Color Contrasting Welt and Button; add \$39 list

Example:

PW1414PW (model #)	MAHARAM (fabric vendor)	MESSENGER (pattern)	PERIDOT (color)
-----------------------	----------------------------	------------------------	--------------------

1. Model Number

- 2. Fabric Selection** - JSI offers Maharam carded and graded in fabric on our pillows. All other fabrics will need to be ordered as COM. Please supply the following:
 Pattern name Pattern color

For a complete list of JSI Graded-In Maharam Fabric suggested for Pillows, [click here](#)

All COM orders must include the following:

- Vendor's name, pattern name and color
- Sample of the fabric attached to the order
- Model numbers of items for fabric application
- Special application instructions (e.g., all stripes will be applied front to back unless specified otherwise)
- Customer and purchase order number

Ship prepaid COM

material to:

JSI
 Attn: COM Dept
 201 East Martin Street
 Receiving B, Dock 71
 Orleans, IN 47452

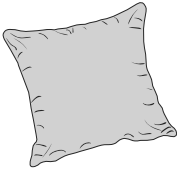
All COM orders will ship at standard lead time from receipt of COM except for orders requiring special custom matched finishes.

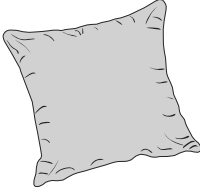
3. Optional Contrasting Welt or Button -

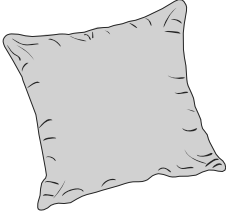
Maharam's Mode pattern is suggested. COM can also be selected. Please supply the following:
 Fabric vendor Pattern name Pattern color

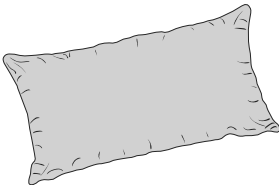
4. Optional Single Color Contrasting Welt and Button -

Maharam's Mode pattern is suggested. COM can also be selected. Please supply the following:
 Fabric vendor Pattern name Pattern color

Description	Model	Specifications			List Price Per Grade	
Pillow 	PW1414P · directional fabric is applied random and may not match from pillow to pillow	Dimensions	D	W	H	COM \$166
		Overall	14	14	5	C \$200
		Upholstery	Shipping			D \$224
		COM Ydg	½	Ctn Wt	3	E \$248
			Cu Ft	2	F \$284	
					G \$322	
					H \$364	
					I \$429	
					J \$508	

Pillow 	PW1616P · directional fabric is applied random and may not match from pillow to pillow	Dimensions	D	W	H	COM \$202
		Overall	16	16	5	C \$254
		Upholstery	Shipping			D \$290
		COM Ydg	½	Ctn Wt	3	E \$324
			Cu Ft	2	F \$380	
					G \$438	
					H \$502	
					I \$598	
					J \$717	

Pillow 	PW1818P · directional fabric is applied random and may not match from pillow to pillow	Dimensions	D	W	H	COM \$224
		Overall	18	18	5	C \$275
		Upholstery	Shipping			D \$311
		COM Ydg	¾	Ctn Wt	3	E \$346
			Cu Ft	2	F \$401	
					G \$460	
					H \$523	
					I \$620	
					J \$738	

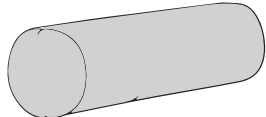
Pillow 	PW1221P · directional fabric is applied random and may not match from pillow to pillow	Dimensions	D	W	H	COM \$203
		Overall	12	21	5	C \$237
		Upholstery	Shipping			D \$263
		COM Ydg	½	Ctn Wt	3	E \$286
			Cu Ft	2	F \$321	
					G \$360	
					H \$402	
					I \$468	
					J \$547	

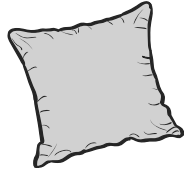
To Order, Specify:

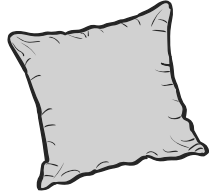
- 1 Model Number
- 2 Maharam Fabric Selection - pattern and color
 For a complete list of JSI Graded-In Maharam Fabric suggested for Pillows
- 3 Optional Single Color Contrasting Welt and Button, specify and add \$39 list for contrasting Maharam Mode or COM.

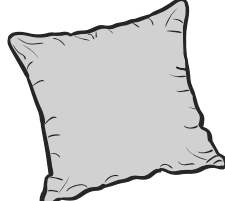
Specifications

- Pillows have Dacron fiber filled insert.
- Bolster has high resilience polyurethane foam insert.
- Hidden zipper allows for easy cleanability.
- Directional and pattern fabrics are applied random and may not match from pillow to pillow.

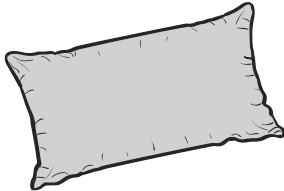
Description	① Model	Specifications				List Price Per Grade	
Bolster 	PW0618B · directional fabric is applied random and may not match from pillow to pillow	Dimensions		D	W	H	COM \$221
		Overall		6	18	6	C \$271
		Upholstery		Shipping			D \$308
		COM Ydg	¾	Ctn Wt	3½		E \$343
				Cu Ft	2		F \$398
						G \$457	
						H \$518	
						I \$617	
						J \$733	

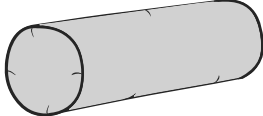
Description	① Model	Specifications				List Price Per Grade	
Pillow with Welt 	PW1414PW · directional fabric is applied random and may not match from pillow to pillow · optional contrasting welt add \$26 list for contrasting Maharam Mode or COM	Dimensions		D	W	H	COM \$222
		Overall		14	14	5	C \$273
		Upholstery		Shipping			D \$309
		COM Ydg	¾	Ctn Wt	3		E \$344
				Cu Ft	2		F \$399
						G \$458	
						H \$519	
						I \$618	
						J \$735	

Description	① Model	Specifications				List Price Per Grade	
Pillow with Welt 	PW1616PW · directional fabric is applied random and may not match from pillow to pillow · optional contrasting welt add \$26 list for contrasting Maharam Mode or COM	Dimensions		D	W	H	COM \$258
		Overall		16	16	5	C \$327
		Upholstery		Shipping			D \$375
		COM Ydg	¾	Ctn Wt	3		E \$422
				Cu Ft	2		F \$494
						G \$572	
						H \$656	
						I \$787	
						J \$942	

Description	① Model	Specifications				List Price Per Grade	
Pillow with Welt 	PW1818PW · directional fabric is applied random and may not match from pillow to pillow · optional contrasting welt add \$26 list for contrasting Maharam Mode or COM	Dimensions		D	W	H	COM \$280
		Overall		18	18	5	C \$350
		Upholstery		Shipping			D \$397
		COM Ydg	1	Ctn Wt	3		E \$444
				Cu Ft	2		F \$516
						G \$595	
						H \$679	
						I \$809	
						J \$965	

PILLOWS

Description	① Model	Specifications			List Price Per Grade	
Pillow with Welt 	PW1221PW · directional fabric is applied random and may not match from pillow to pillow · optional contrasting welt add \$26 list for contrasting Maharam Mode or COM	Dimensions	D	W	H	COM \$259
		Overall	12	21	5	C \$311
		Upholstery	Shipping		D \$346	E \$382
		COM Ydg	¾	Ctn Wt	3	F \$437
				Cu Ft	2	G \$495
						H \$558
						I \$656
						J \$773

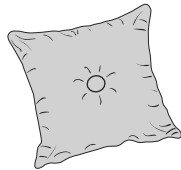
Description	① Model	Specifications			List Price Per Grade	
Bolster with Welt 	PW0618BW · directional fabric is applied random and may not match from pillow to pillow · optional contrasting welt add \$26 list for contrasting Maharam Mode or COM	Dimensions	D	W	H	COM \$276
		Overall	6	18	6	C \$345
		Upholstery	Shipping		D \$392	E \$439
		COM Ydg	1	Ctn Wt	3 ½	F \$512
				Cu Ft	2	G \$591
						H \$674
						I \$805
						J \$961

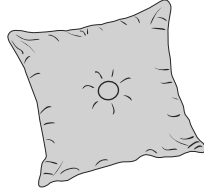
To Order, Specify:

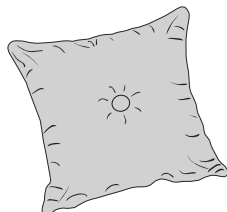
- ① Model Number
- ② Maharam Fabric Selection - pattern and color
 For a complete list of JSI Graded-In Maharam Fabric suggested for Pillows
- ③ Optional Single Color Contrasting Welt and Button, specify and add \$39 list for contrasting Maharam Mode or COM.

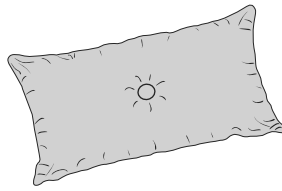
Specifications

- Pillows have Dacron fiber filled insert.
- Bolster has high resilience polyurethane foam insert.
- Hidden zipper allows for easy cleanability.
- Directional and pattern fabrics are applied random and may not match from pillow to pillow.

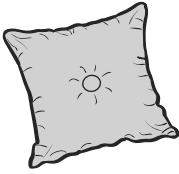
Description	① Model	Specifications			List Price Per Grade	
Pillow with Button 	PW1414PB · directional fabric is applied random and may not match from pillow to pillow · optional contrasting button add \$26 list for contrasting Maharam Mode or COM	Dimensions	D	W	H	COM \$197
		Overall	14	14	5	C \$231
		Upholstery	Shipping			D \$255
		COM Ydg	½	Ctn Wt	3	E \$278
				Cu Ft	2	F \$314
						G \$354
						H \$395
						I \$461
						J \$539

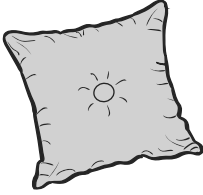
Pillow with Button 	PW1616PB · directional fabric is applied random and may not match from pillow to pillow · optional contrasting button add \$26 list for contrasting Maharam Mode or COM	Dimensions	D	W	H	COM \$233
		Overall	16	16	5	C \$285
		Upholstery	Shipping			D \$320
		COM Ydg	¾	Ctn Wt	3	E \$356
				Cu Ft	2	F \$410
						G \$469
						H \$532
						I \$630
						J \$748

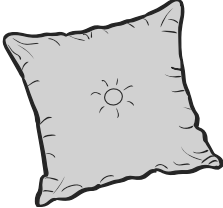
Pillow with Button 	PW1818PB · directional fabric is applied random and may not match from pillow to pillow · optional contrasting button add \$26 list for contrasting Maharam Mode or COM	Dimensions	D	W	H	COM \$256
		Overall	18	18	5	C \$308
		Upholstery	Shipping			D \$343
		COM Ydg	¾	Ctn Wt	3	E \$379
				Cu Ft	2	F \$433
						G \$491
						H \$555
						I \$652
						J \$770

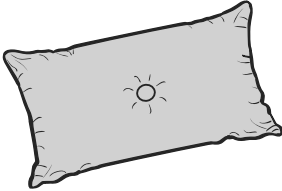
Pillow with Button 	PW1221PB · directional fabric is applied random and may not match from pillow to pillow · optional contrasting button add \$26 list for contrasting Maharam Mode or COM	Dimensions	D	W	H	COM \$234
		Overall	12	21	5	C \$269
		Upholstery	Shipping			D \$293
		COM Ydg	½	Ctn Wt	3	E \$316
				Cu Ft	2	F \$353
						G \$392
						H \$433
						I \$499
						J \$578

PILLOWS

Description	1 Model	Specifications			List Price Per Grade	
Pillow with Button and Welt 	PW1414PC · directional fabric is applied random and may not match from pillow to pillow · optional single color contrasting welt and button add \$39 list for contrasting Maharam Mode or COM	Dimensions	D	W	H	COM \$253
		Overall	14	14	5	C \$303
		Upholstery	Shipping			D \$339
		COM Ydg	¾	Ctn Wt	3	E \$376
				Cu Ft	2	F \$429
						G \$488
						H \$551
						I \$648
						J \$766

Pillow with Button and Welt 	PW1616PC · directional fabric is applied random and may not match from pillow to pillow · optional single color contrasting welt and button add \$39 list for contrasting Maharam Mode or COM	Dimensions	D	W	H	COM \$290
		Overall	16	16	5	C \$358
		Upholstery	Shipping			D \$404
		COM Ydg	1	Ctn Wt	3	E \$451
				Cu Ft	2	F \$525
						G \$603
						H \$686
						I \$817
						J \$973

Pillow with Button and Welt 	PW1818PC · directional fabric is applied random and may not match from pillow to pillow · optional single color contrasting welt and button add \$39 list for contrasting Maharam Mode or COM	Dimensions	D	W	H	COM \$313
		Overall	18	18	5	C \$382
		Upholstery	Shipping			D \$428
		COM Ydg	1	Ctn Wt	3	E \$476
				Cu Ft	2	F \$549
						G \$627
						H \$710
						I \$841
						J \$998

Pillow with Button and Welt 	PW1221PC · directional fabric is applied random and may not match from pillow to pillow · optional single color contrasting welt and button add \$39 list for contrasting Maharam Mode or COM	Dimensions	D	W	H	COM \$291
		Overall	12	21	5	C \$342
		Upholstery	Shipping			D \$378
		COM Ydg	¾	Ctn Wt	3	E \$414
				Cu Ft	2	F \$468
						G \$526
						H \$590
						I \$686
						J \$805

To Order, Specify:

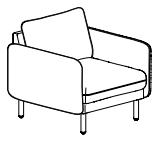
- 1 Model Number
- 2 Maharam Fabric Selection - pattern and color
 For a complete list of JSI Graded-In Maharam Fabric suggested for Pillows
- 3 Optional Single Color Contrasting Welt and Button, specify and add \$39 list for contrasting Maharam Mode or COM.

Specifications

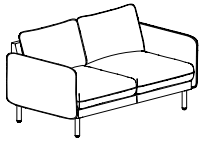
- Pillows have Dacron fiber filled insert.
- Bolster has high resilience polyurethane foam insert.
- Hidden zipper allows for easy cleanability.
- Directional and pattern fabrics are applied random and may not match from pillow to pillow.

Poet - Overview

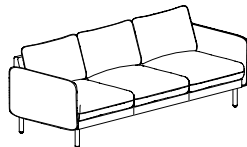
Peb Lounge Seating



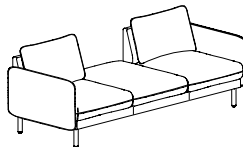
Single Seat
See page PL10



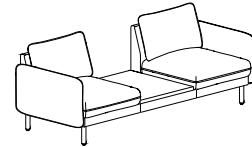
Two Seat
See page PL11



Three Seat
See page PL12

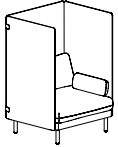


Three Seat Center Bench
See page PL13

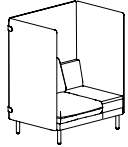


Three Seat Center Table
See page PL14

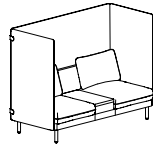
Peb Lounge with Privacy Surround



Single w/Bolster
See page PL15

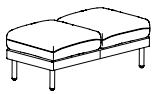


Single w/ Table
See page PL16

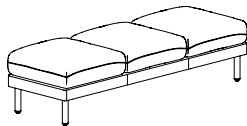


Two Seat w/ Table
See page PL17

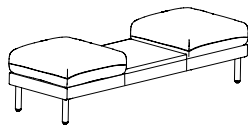
Peb Bench



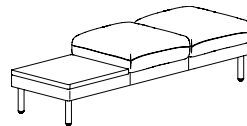
Two Seat
See page PL18



Three Seat
See page PL19

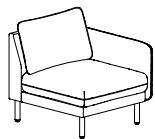


Two Seat w/ Table
See page PL20

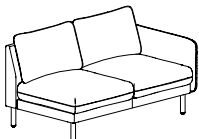


Single Modular
See page PL41

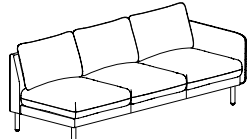
Peb Modular Seating - Arm



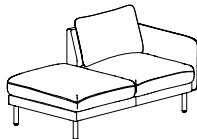
Two Seat
See page PL22



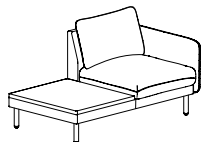
Two Seat
See page PL23



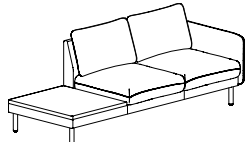
Three Seat
See page PL24



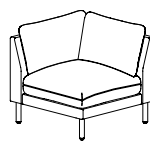
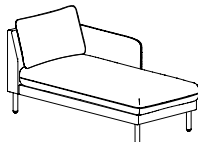
Single or Two Seat w/ Peninsula Arm
See page PL25



Single or Two Seat w/ Table
See page PL27

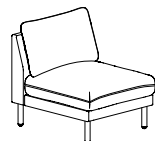


Chaise
See page PL29

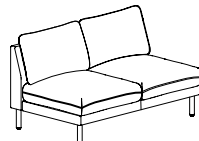


Corner
See page PL30

Peb Modular Seating - Armless



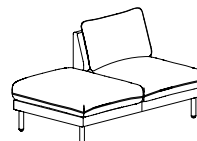
Two Seat
See page PL31



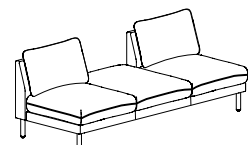
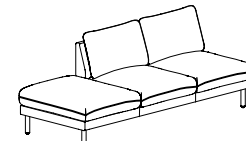
Two Seat
See page PL32



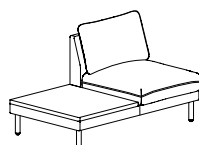
Three Seat
See page PL33



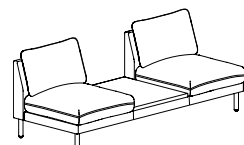
Single or Two Seat w/ Peninsula Arm
See page PL34



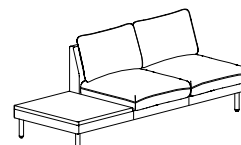
Two Seat w/ Bench
See page PL35



Single Seat w/ Table
See page PL37



Two Seat w/ Table
See page PL38



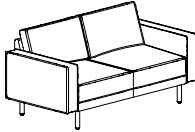
Two Seat w/ Two Tables
See page PL40

Poet - Overview

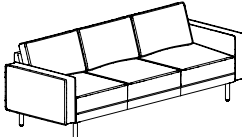
Cube Lounge Seating



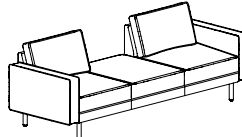
Single Seat
See page PL42



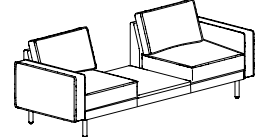
Two Seat
See page PL43



Three Seat
See page PL44

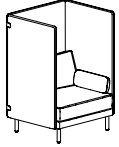


Three Seat Center Bench
See page PL45

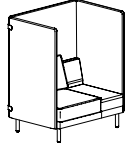


Three Seat Center Table
See page PL46

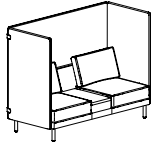
Cube Lounge with Privacy Surround



Single w/Bolster
See page PL47

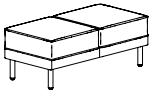


Single w/ Table
See page PL48

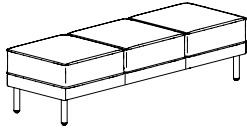


Two Seat w/ Table
See page PL49

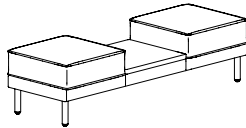
Cube Bench



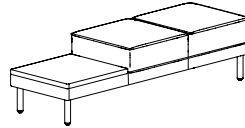
Two Seat
See page PL50



Three Seat
See page PL51



Two Seat w/ Table
See page PL52

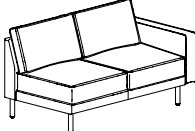


Single Modular
See page PL73

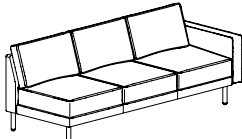
Cube Modular Seating - Arm



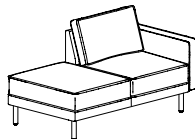
Two Seat
See page PL54



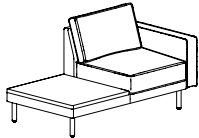
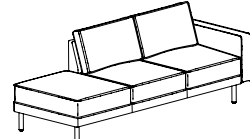
Two Seat
See page PL55



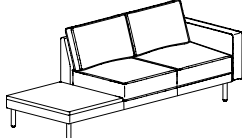
Three Seat
See page PL56



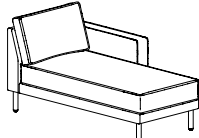
Single or Two Seat w/ Peninsula Arm
See page PL57



Single or Two Seat w/ Table
See page PL59

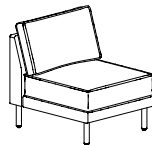


Chaise
See page PL61

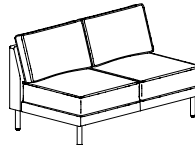


Corner
See page PL62

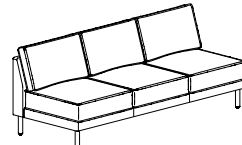
Cube Modular Seating - Armless



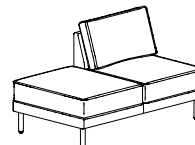
Two Seat
See page PL63



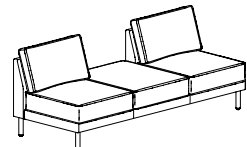
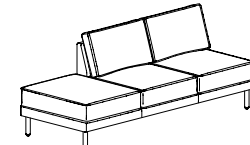
Two Seat
See page PL64



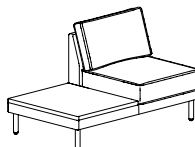
Three Seat
See page PL65



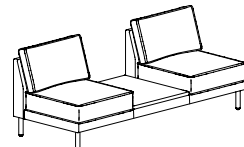
Single or Two Seat w/ Peninsula Arm
See page PL66



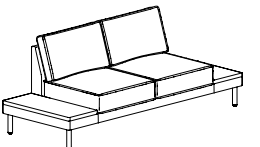
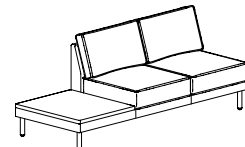
Two Seat w/ Bench
See page PL67



Single Seat w/ Table
See page PL69



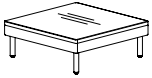
Two Seat w/ Table
See page PL70



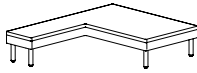
Two Seat w/ Two Tables
See page PL72

Poet - Overview

Modular Table

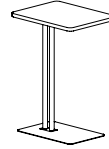


Corner Table
[See page PL74](#)



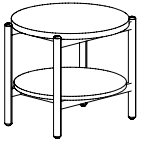
Wrap Table
[See page PL76](#)

Freestanding Table

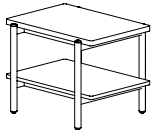


Pull Up Table
[See page PL77](#)

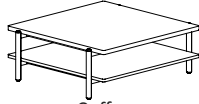
Wood Legs



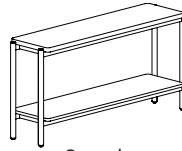
Round Side
[See page PL77](#)



Rectangular Side
[See page PL77](#)

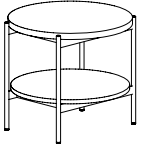


Coffee
[See page PL78](#)

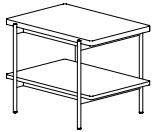


Console
[See page PL78](#)

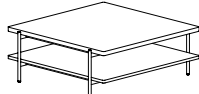
Metal Legs



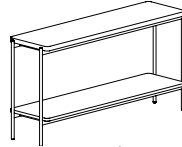
Round Side
[See page PL79](#)



Rectangular Side
[See page PL79](#)

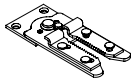
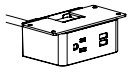


Coffee
[See page PL80](#)



Console
[See page PL80](#)

Accessories



[See page 81](#)

Poet Lounge Order Check List:



Specify:

- 1. Model Number
- 2. Upholstery Selection
 - A. Single Upholstery Models - Vendor, Pattern and Color
 - B. Multiple Upholstery Models (per zone as applicable per model) - Vendor, Pattern and Color
- 3. Pocket - select arm, leather accent color, upholstery
- 4. Accent Strap - fabric, brown leather or black leather
- 5. Top Surface Material - specify material and finish
- 6. Foot Option - specify wood or metal foot and finish
- 7. Leg Option - specify wood or metal foot and finish
- 8. Power Option - specify location and color
- 9. Ganging Option - specify yes or no

Example:

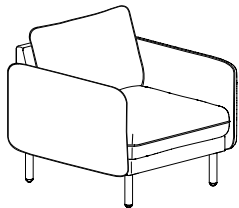
PLPF21 | Momentum | Fuse | Pepper | NP | MF | ASL
 (model #) | (fabric vendor) | (pattern name) | (pattern color) | (pocket) | (foot option) | (foot finish)

1. Model Number

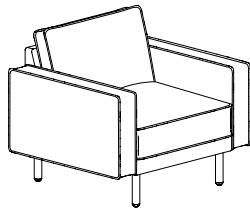
Poet offers two distinct looks combined into one series. Select Peb models for a relaxed style or Cube for tailored lines. All models are available in each style

Ship prepaid COM material to:

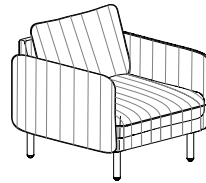
JSI
 Attn: COM Department
 201 East Martin Street
 Receiving B, Dock 71
 Orleans, IN 47452



Poet - Peb
PLP__



Poet - Cube
PLC__



Seating: Up the Roll

2a. Upholstery Selection

Please supply the following:

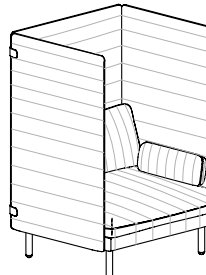
Upholstery vendor/Pattern name/Pattern color

For a complete list of JSI Graded-In Fabric click here

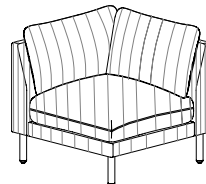
- Indicate direction of fabric - Railroaded or Up the Roll
- Please provide illustration, if available

All COM orders must include the following:

- Vendor's name, pattern name and color
- Sample of the fabric attached to the order
- Model numbers of items for fabric application
- Special application instructions
- Customer and purchase order number



Surround: Railroaded
*Leather unavailable



Corner Units: Seat surfaces run diagonal

All COM orders will ship at standard lead time from receipt of COM except for orders requiring special custom matched finishes.

Upholstery Application

Poet offers the ability to be specified with multiply upholsteries to create a unique look.

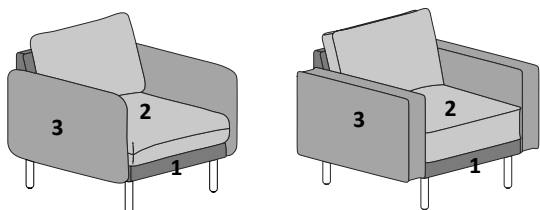
Models ending with a _M designate multiple upholstery zones will be specified. Refer to each product page for upholstery yardage for the complet unit as well as per zone.

Models not ending in a _M will be upholstered in the single upholstery for the complete unit.

Both uphosltery styles are presented in the price list and eTools.

Examples of uphosltery zones and how to calculate pricing is provided below. Upholstery zones are defined by the style of the unit and are called out on each product page. When specifying multiple upholstery, make sure to identify specific yardage per zone. This can be found at the top of each product page.

Lounge with Arms



Zone 1 = Frame
 Zone 2 = Seat and Back Cushion
 Zone 3 = Arms

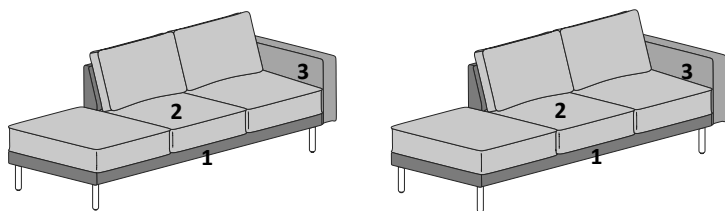
Lounge with Privacy Surround & Bolster



Zone 1 = Frame (Apron & Surround)
 Zone 2 = Seat and Back Cushion
 Zone 3 = Bolster

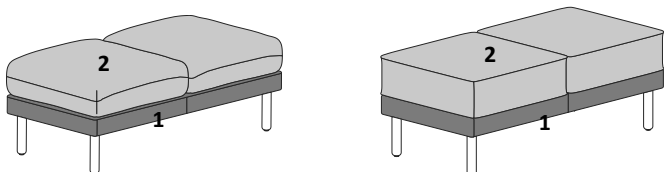
Zone 1 = Frame (Apron & Surround)
 Zone 2 = Seat and Back Cushion

Modular Three Seat with Cushion



Zone 1 = Frame
 Zone 2 = Seat and Back Cushion
 Zone 3 = Arms

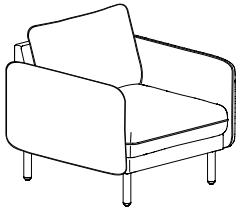
Bench



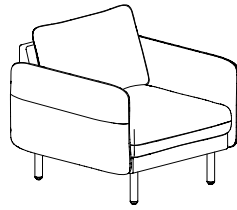
Zone 1 = Frame
 Zone 2 = Seat and Back Cushion

3. Pocket Option:

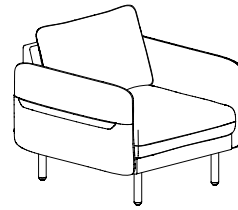
Select units offer an arm pocket, which are available with and without a leather accent along the top. Additional yardage is required with pocket upholstery matching that of the arm upholstery. Refer to each product page for upcharge for pockets based on the upholstery grade.



Poet Peb chair shown without pocket specified



Poet Peb chair shown with pocket specified



Poet Peb chair shown with pocket and leather accent specified

NP No Pockets

LP Left Pocket

RP Right Pocket

BP Both Pockets

LPX - Left Pocket no accent

RPX - Right Pocket no accent

BPX - Both Pockets no accent

LPAR - Left Pocket brown accent

RPAR - Right Pocket brown accent

BPAR - Both Pockets brown accent

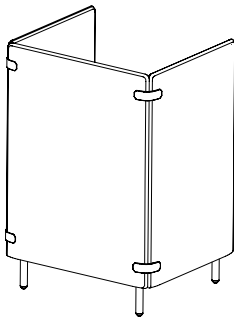
LPAK - Left Pocket black accent

RPAK - Right Pocket black accent

BPAK - Both Pockets black accent

4. Accent Strap:

Models with privacy surrounds have an accent straps at the top and bottom, where the back wraps around to the front. These accent straps are offered in upholstery or leather.



FA - Fabric Accent - *upholstery for accent strap matches surround upholstery*

LA - Leather Accent, add \$105 upcharge

BRO - Brown Leather Accent

BLK - Black Leather Accent

5. Top Surface:

V Veneer

MA1 - Maple

Flat Cut Veneer

ALM	Ale Medium	FLX	Flax
BUT	Butterscotch	VEN	Venetian

CH1 - Cherry

Flat Cut Veneer

BBM	Bourbon Medium	CLL	Collectors
BRM	Brighton Medium	HRV	Harvest
CLA	Classic	PRL	Praline

WA1 - Walnut

Flat Cut Veneer

ESP	Espresso	TRF	Truffle
MCH	Mocha	UMB	Umber
SIE	Sienna		

WO1 - White Oak

Flat Cut Veneer

ACR	Acorn	MIN	Mineral
BAR	Barrel	POR	Porter
BUF	Buff	RAV	Raven
BUR	Burlap	RYE	Rye
CHE	Chestnut	SAB	Sable
CND	Cinder	SAD	Saddle
EGR	Egret	WVO	Whitewash

DC1 - Double Cut

COF	Coffee	KHK	Khaki
FAW	Fawn	STU	Studio Teak
GRH	Graphite	VAL	Valley

S Solid Surface

ARM	Armadillo	PEB	Pebble Pearl
BLP	Black Pearl	PUR	Pure White

T

Laminate

ALB	Alabaster	GRH	Graphite
ALL	Ale Light	MIN	Mineral
BLK	Black	OAT	Oatmeal Cookie
BOL	Bourbon Light	PIN	Pinnacle Walnut
BZW	Brazilwood	SHD	Shadow
BBL	Bridal Blanco	SLG	Slate Grey
BGL	Brighton Light	STU	Studio Teak
CLL	Collectors	UMB	Umber
DWH	Designer White	VAL	Valley
FAW	Fawn	VIN	Vintage
FLO	Florence Walnut	WEA	Weathered Ash

6. Foot:

WF Wood Foot

MAF - Maple Wood Foot

ALM	Ale Medium	MINC	Mineral Coordinate
BBM	Bourbon Medium	MCH	Mocha
CBZ	Brazilwood Coordinate	CPI	Pinnacle Walnut Coordinate
BRM	Brighton Medium	PRL	Praline
BUT	Butterscotch	RAVC	Raven Coordinate
CNDC	Cinder Coordinate	SABC	Sable Coordinate
CLA	Classic	SADC	Saddle Coordinate
CLL	Collectors	SIE	Sienna
EGRC	Egret Coordinate	CST	Studio Teak Coordinate
ESP	Espresso	TRF	Truffle
FAWC	Fawn Coordinate	UMB	Umber
FLX	Flax	VALC	Valley Coordinate
CGR	Graphite Coordinate	VEN	Venetian
HRV	Harvest	CWE	Weathered Ash Coordinate
CKC	Khaki Coordinate		

MPF - Maple Paint Wood Foot, add \$45 list upcharge

BKD	Backdrop	GLF	Gulf Stream
BFX	Black Fox	HTB	Hearthrob
BWH	Bright White	NET	Network
CGP	Cargo Pants	NWH	Nonchalant White
CHT	Chatroom	PAR	Paradise
DSY	Daisy	QXP	Quixotic Plum
DRG	Daring	RBZ	Relic Bronze
ENG	Enigma	SND	Sandbank
FRR	Frech Roast	STM	Storm
GBY	Georgian Bay	TRC	Tricorn Black

WAF - Walnut Wood Foot, add \$85 list upcharge

ESP	Espresso	TRF	Truffle
MCH	Mocha	UMB	Umber
SIE	Sienna		

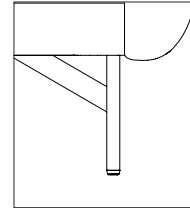
WOL - White Oak Wood Leg, add \$85 list upcharge

ACR	Acorn	MIN	Mineral
BAR	Barrel	POR	Porter
BUF	Buff	RAV	Raven
BUR	Burlap	RYE	Rye
CHE	Chestnut	SAB	Sable
CND	Cinder	SAD	Saddle
EGR	Egret	WWO	Whitewash

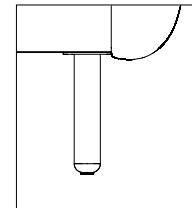
MF Metal Foot

ABZ	Aged Bronze
ASL	Arctic Silver
GLD	Gold
MBK	Matte Black
PEW	Pewter
SBZ	Soft Bronze
SNK	Soft Nickel

** JSI's extended powdercoat program of bright colors is available, upon request. Contact Customer Service for a specific quote based on qty of units.*



Metal (MF)



Wood (WF)

7a Wood Leg Model:

MAL - Maple Wood Leg

ALM	Ale Medium	MINC	Mineral Coordinate
BBM	Bourbon Medium	MCH	Mocha
CBZ	Brazilwood Coordinate	CPI	Pinnacle Walnut Coordinate
BRM	Brighton Medium	PRL	Praline
BUT	Butterscotch	RAVC	Raven Coordinate
CNDC	Cinder Coordinate	SABC	Sable Coordinate
CLA	Classic	SADC	Saddle Coordinate
CLL	Collectors	SIE	Sienna
EGRC	Egret Coordinate	CST	Studio Teak Coordinate
ESP	Espresso	TRF	Truffle
FAWC	Fawn Coordinate	UMB	Umber
FLX	Flax	VALC	Valley Coordinate
CGR	Graphite Coordinate	VEN	Venetian
HRV	Harvest	CWE	Weathered Ash Coordinate
CKC	Khaki Coordinate		

MPL - Maple Paint Wood Leg, add \$45 list upcharge

BKD	Backdrop	GLF	Gulf Stream
BFX	Black Fox	HTB	Hearthrob
BWH	Bright White	NET	Network
CGP	Cargo Pants	NWH	Nonchalant White
CHT	Chatroom	PAR	Paradise
DSY	Daisy	QXP	Quixotic Plum
DRG	Daring	RBZ	Relic Bronze
ENG	Enigma	SND	Sandbank
FRR	French Roast	STM	Storm
GBY	Georgian Bay	TRC	Tricorn Black

WAL - Walnut Wood Leg, add \$85 list upcharge

ESP	Espresso	TRF	Truffle
MCH	Mocha	UMB	Umber
SIE	Sienna		

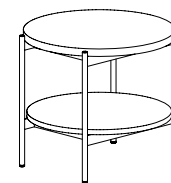
WOL - White Oak Wood Leg, add \$85 list upcharge

ACR	Acorn	MIN	Mineral
BAR	Barrel	POR	Porter
BUF	Buff	RAV	Raven
BUR	Burlap	RYE	Rye
CHE	Chestnut	SAB	Sable
CND	Cinder	SAD	Saddle
EGR	Egret	WWO	Whitewash

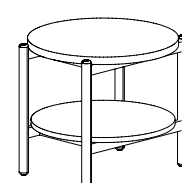
7b. Metal Leg Model:

ABZ	Aged Bronze
ASL	Arctic Silver
GLD	Gold
MBK	Matte Black
PEW	Pewter
SBZ	Soft Bronze
SNK	Soft Nickel

** JSI's extended powdercoat program of bright colors is available, upon request. Contact Customer Service for a specific quote based on qty of units.*



Metal Leg

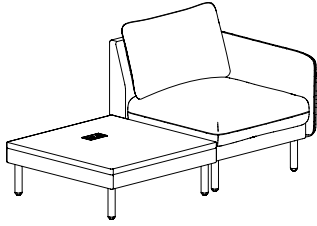


Wood Leg

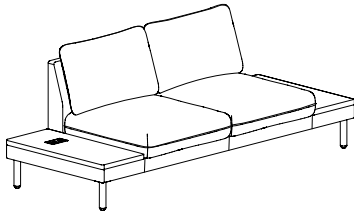
8. Power:

Power can be specified on the top of worksurfaces integrated with seating units and also the wrap table. Power can not be specified on freestanding occasional tables. The Two Seat/2 Table unit can have power specified on either table or both tables. All other units specify power in a single location.

Power units can be specified in black or white, with the option of a coordinating cord or a graphite accent cord at an upcharge.



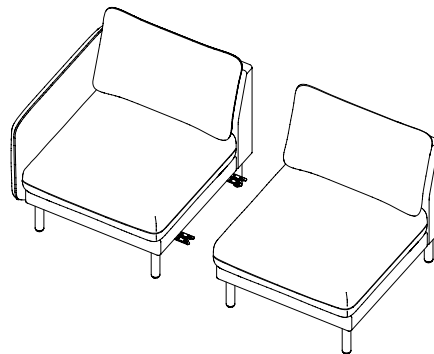
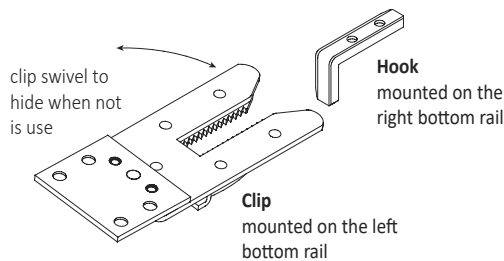
- NSP - No Surface Power
- YSP - Yes Surface Power
 - B - Black Power, add \$420 list upcharge
 - B - Black Cord
 - G - Graphite Cord, add an additional \$187 list upcharge
 - W - White Power, add \$420 list upcharge
 - W - White Cord
 - G - Graphite Cord, add an additional \$187 list upcharge



- NSP - No Surface Power
- LSP - Left Surface Power
 - B - Black Power, add \$420 list upcharge
 - B - Black Cord
 - G - Graphite Cord, add an additional \$187 list upcharge
 - W - White Power, add \$420 upcharge
 - W - White Cord
 - G - Graphite Cord, add an additional \$187 list upcharge
- RSP - Right Surface Power
 - B - Black Power, add \$420 list upcharge
 - B - Black Cord
 - G - Graphite Cord, add an additional \$187 list upcharge
 - W - White Power, add \$420 list upcharge
 - W - White Cord
 - G - Graphite Cord, add an additional \$187 list upcharge
- BSP - Both Surface Power
 - B - Black Power, add \$840 list upcharge
 - B - Black Cord
 - G - Graphite Cord, add an additional \$374 list upcharge
 - W - White Power, add \$840 list upcharge
 - W - White Cord
 - G - Graphite Cord, add an additional \$374 list upcharge

9. Ganging:

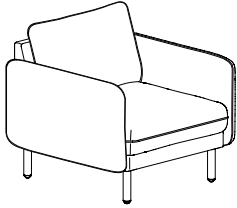
Modular units have the option to be ganged. Ganging brackets (GP-LINK) can also be ordered separately if the decision is made to gang at a later date. An Alligator Clip assembly is installed to connect lounge and linking drum tables. The clip is installed on the left bottom side rail and the hook is installed on the right bottom side rail. The bottom chair rails are bored to accept either the clip or hook for field re-configurations.



- NGB - No Ganging Bracket
- YGB - Yes Ganging Bracket, add \$50 list upcharge

Description + General Information

Single Seat



- arm pocket available - upholstery same as arm and requires additional yardage, see upcharges below per arm
- undermount power center available - order EC30 separately

Dimensions	D	W	H	Shipping	
Overall	33	35	32	Ctn Wt	82
Seat	22	26 ½	17 ½	Cu Ft	20
Arm			25 ¼		

	Single Upholstery	Frame Zone 1	Seat & Back Zone 2	Arm Zone 3	Pocket (per arm)
COM Ydg	7 ½	2	2 ¾	3	1
COL Sq Ft	150	40	55	60	18

Single Upholstery Specify: Model | Upholstery | Pocket | Foot Style

PLPF21														
	COM	COL	A	B	C	D	E	F	G	H	I	J	L1	L2
Single Uph	\$2,881	\$3,309	\$2,948	\$3,079	\$3,309	\$3,606	\$3,902	\$4,362	\$4,856	\$5,382	\$6,205	\$7,192	\$5,218	\$5,876

Multiple Upholstery Specify: Model | Frame Upholstery | Seat & Back Uph | Arm Uph | Pocket | Foot Style

PLPF21_M														
Base Price: \$2,881	To the Base Price, add the appropriate upcharges by grade, per zone													
	COM	COL	A	B	C	D	E	F	G	H	I	J	L1	L2
Frame - Zone 1	+ n/a	+\$115	+\$18	+\$53	+\$115	+\$194	+\$273	+\$395	+\$527	+\$667	+\$887	+\$1,150	+\$624	+\$799
Seat & Back - Zone 2	+ n/a	+\$157	+\$25	+\$73	+\$157	+\$266	+\$375	+\$544	+\$725	+\$918	+\$1,219	+\$1,581	+\$857	+\$1,099
Arm - Zone 3	+ n/a	+\$172	+\$27	+\$80	+\$172	+\$290	+\$409	+\$593	+\$790	+\$1,001	+\$1,330	+\$1,725	+\$935	+\$1,198

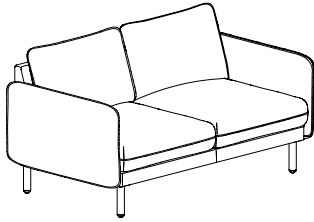
Optional Arm Pocket Available on both Single and Multiple Upholstery Units with Arm Pocket Upholstery matching the Arm.

Pocket Upcharge Pricing below represents upcharge for single arm pocket. For pockets on both arms, double the price.														
	COM	COL	A	B	C	D	E	F	G	H	I	J	L1	L2
No Leather Accent	\$131	\$188	\$140	\$158	\$188	\$228	\$267	\$329	\$395	\$465	\$574	\$706	\$443	\$531
With Leather Accent	\$174	\$231	\$183	\$200	\$231	\$271	\$310	\$371	\$437	\$507	\$617	\$749	\$485	\$573

Model	Upholstery	Pocket	Foot Style
PL10 POET	Grade Vendor Pattern Colorway	NP No Pocket LP Left Pocket LPX Right Pocket - No Accent LPAR Left Pocket with Brown Accent LPAK Left Pocket with Black Accent RP Right Pocket RPX Right Pocket - No Accent RPAR Right Pocket with Brown Accent RPAK Right Pocket with Black Accent BP Both Left & Right Pockets BPX Both Pockets - No Accent BPAR Both Pockets with Brown Accent BPAK Both Pockets with Black Accent see pocket for pricing	WF Wood Foot See Poet Wood Foot Finishes MF Metal Foot See Poet Metal Foot Finishes see foot finish style for pricing

Description + General Information

Two Seat



- arm pocket available - upholstery same as arm and requires additional yardage, see upcharges below per arm
- undermount power center available - order EC30 separately

Dimensions	D	W	H	Shipping	
Overall	33	62	32	Ctn Wt	129
Seat	22	53 ½	17 ½	Cu Ft	34
Arm			25 ¼		

	Single Upholstery	Frame Zone 1	Seat & Back Zone 2	Arm Zone 3	Pocket (per arm)
COM Ydg	11 ¼	3 ½	5 ½	3	1
COL Sq Ft	235	70	110	60	18

Single Upholstery Specify: Model | Upholstery | Pocket | Foot Style

PLPF22														
	COM	COL	A	B	C	D	E	F	G	H	I	J	L1	L2
Single Uph	\$4,034	\$4,705	\$4,138	\$4,344	\$4,705	\$5,168	\$5,632	\$6,354	\$7,127	\$7,952	\$9,240	\$10,787	\$7,694	\$8,725

Multiple Upholstery Specify: Model | Frame Upholstery | Seat & Back Uph | Arm Uph | Pocket | Foot Style

PLPF22_M														
Base Price: \$4,034	To the Base Price, add the appropriate upcharges by grade, per zone													
	COM	COL	A	B	C	D	E	F	G	H	I	J	L1	L2
Frame - Zone 1	+ n/a	+\$200	+ \$31	+ \$93	+\$200	+\$338	+ \$476	+ \$692	+ \$922	+ \$1,168	+ \$1,551	+ \$2,012	+ \$1,091	+ \$1,398
Seat & Back - Zone 2	+ n/a	+\$315	+ \$49	+\$146	+\$315	+\$531	+ \$748	+ \$1,086	+ \$1,448	+ \$1,834	+ \$2,437	+ \$3,161	+ \$1,714	+ \$2,196
Arm - Zone 3	+ n/a	+\$172	+ \$27	+\$80	+\$172	+\$290	+ \$408	+ \$593	+ \$790	+ \$1,001	+ \$1,330	+ \$1,725	+ \$935	+ \$1,198

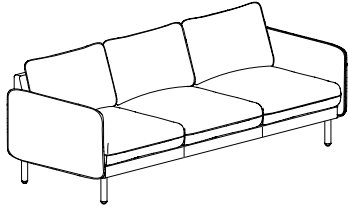
Optional Arm Pocket Available on both Single and Multiple Upholstery Units with Arm Pocket Upholstery matching the Arm.

Pocket Upcharge														
Pricing below represents upcharge for single arm pocket. For pockets on both arms, double the price.														
	COM	COL	A	B	C	D	E	F	G	H	I	J	L1	L2
No Leather Accent	\$131	\$188	\$140	\$158	\$188	\$228	\$267	\$329	\$395	\$465	\$574	\$706	\$443	\$531
With Leather Accent	\$174	\$231	\$183	\$200	\$231	\$271	\$310	\$371	\$437	\$507	\$617	\$749	\$485	\$573

Model	Upholstery	Pocket	Foot Style
	Grade Vendor Pattern Colorway	NP No Pocket LP Left Pocket LPX Right Pocket - No Accent LPAR Left Pocket with Brown Accent LPAK Left Pocket with Black Accent RP Right Pocket RPX Right Pocket - No Accent RPAR Right Pocket with Brown Accent RPAK Right Pocket with Black Accent BP Both Left & Right Pockets BPX Both Pockets - No Accent BPAR Both Pockets with Brown Accent BPAK Both Pockets with Black Accent see pocket for pricing	WF Wood Foot See Poet Wood Foot Finishes MF Metal Foot See Poet Metal Foot Finishes see foot finish style for pricing

Description + General Information

Three Seat



- arm pocket available - upholstery same as arm and requires additional yardage, see upcharges below per arm
- undermount power center available - order EC30 separately

Dimensions	D	W	H	Shipping	
Overall	33	89	32	Ctn Wt	174
Seat	22	80 ½	17 ½	Cu Ft	48
Arm			25 ¼		

	Single Upholstery	Frame Zone 1	Seat & Back Zone 2	Arm Zone 3	Pocket (per arm)
COM Ydg	16 ¼	5 ¼	8 ¼	3	1
COL Sq Ft	325	110	165	60	18

Single Upholstery Specify: Model | Upholstery | Pocket | Foot Style

PLPF23														
	COM	COL	A	B	C	D	E	F	G	H	I	J	L1	L2
Single Uph	\$5,320	\$6,247	\$5,463	\$5,748	\$6,247	\$6,888	\$7,530	\$8,528	\$9,597	\$10,738	\$12,520	\$14,658	\$10,381	\$11,807

Multiple Upholstery Specify: Model | Frame Upholstery | Seat & Back Uph | Arm Uph | Pocket | Foot Style

PLPF23_M														
Base Price: \$5,320	To the Base Price, add the appropriate upcharges by grade, per zone													
	COM	COL	A	B	C	D	E	F	G	H	I	J	L1	L2
Frame - Zone 1	+ n/a	+\$300	+\$47	+\$139	+\$300	+\$507	+\$714	+\$1,037	+\$1,382	+\$1,751	+\$2,327	+\$3,017	+\$1,636	+\$2,096
Seat & Back - Zone 2	+ n/a	+\$471	+\$73	+\$218	+\$471	+\$797	+\$1,122	+\$1,629	+\$2,172	+\$2,751	+\$3,656	+\$4,741	+\$2,570	+\$3,294
Arm - Zone 3	+ n/a	+\$172	+\$27	+\$80	+\$172	+\$290	+\$408	+\$593	+\$790	+\$1,001	+\$1,330	+\$1,724	+\$935	+\$1,198

Optional Arm Pocket Available on both Single and Multiple Upholstery Units with Arm Pocket Upholstery matching the Arm.

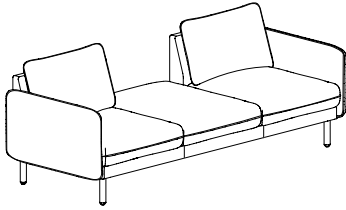
Pocket Upcharge Pricing below represents upcharge for single arm pocket. For pockets on both arms, double the price.														
	COM	COL	A	B	C	D	E	F	G	H	I	J	L1	L2
No Leather Accent	\$131	\$188	\$140	\$158	\$188	\$228	\$267	\$329	\$395	\$465	\$574	\$706	\$443	\$531
With Leather Accent	\$174	\$231	\$183	\$200	\$231	\$271	\$310	\$371	\$437	\$507	\$617	\$749	\$485	\$573

Model	Upholstery	Pocket	Foot Style
PL12 POET	Grade	NP No Pocket LP Left Pocket LPX Right Pocket - No Accent LPAR Left Pocket with Brown Accent LPAK Left Pocket with Black Accent RP Right Pocket RPX Right Pocket - No Accent RPAR Right Pocket with Brown Accent RPAK Right Pocket with Black Accent BP Both Left & Right Pockets BPX Both Pockets - No Accent BPAR Both Pockets with Brown Accent BPAK Both Pockets with Black Accent	WF Wood Foot See Poet Wood Foot Finishes MF Metal Foot See Poet Metal Foot Finishes see foot finish style for pricing
	Vendor		
	Pattern		
	Colorway		

see pocket for pricing

Description + General Information

Three Seat with Center Bench



- arm pocket available - upholstery same as arm and requires additional yardage, see upcharges below per arm
- undermount power center available - order EC30 separately

Dimensions	D	W	H	Shipping	
Overall	34	89	32	Ctn Wt	170
Seat	22 & 34	80 ½	17 ½	Cu Ft	50
Arm			25 ¼		

	Single Upholstery	Frame Zone 1	Seat & Back Zone 2	Arm Zone 3	Pocket (per arm)
COM Ydg	14 ½	4 ½	7 ¼	3	1
COL Sq Ft	290	85	145	60	18

Single Upholstery Specify: Model | Upholstery | Pocket | Foot Style

PLPF23B														
	COM	COL	A	B	C	D	E	F	G	H	I	J	L1	L2
Single Uph	\$5,007	\$5,835	\$5,135	\$5,390	\$5,835	\$6,407	\$6,980	\$7,870	\$8,824	\$9,842	\$11,432	\$13,340	\$9,524	\$10,796

Multiple Upholstery Specify: Model | Frame Upholstery | Seat & Back Uph | Arm Uph | Pocket | Foot Style

PLPF23B_M														
Base Price: \$5,007		To the Base Price, add the appropriate upcharges by grade, per zone												
	COM	COL	A	B	C	D	E	F	G	H	I	J	L1	L2
Frame - Zone 1	+ n/a	+\$257	+\$40	+\$119	+\$257	+\$435	+\$613	+\$889	+\$1,185	+\$1,501	+\$1,994	+\$2,587	+\$1,402	+\$1,797
Seat & Back - Zone 2	+ n/a	+\$414	+\$64	+\$192	+\$414	+\$700	+\$987	+\$1,432	+\$1,909	+\$2,418	+\$3,213	+\$4,167	+\$2,259	+\$2,895
Arm - Zone 3	+ n/a	+\$172	+\$27	+\$80	+\$172	+\$290	+\$409	+\$593	+\$790	+\$1,001	+\$1,330	+\$1,725	+\$935	+\$1,198

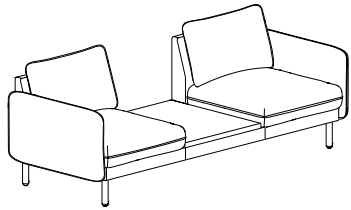
Optional Arm Pocket Available on both Single and Multiple Upholstery Units with Arm Pocket Upholstery matching the Arm.

Pocket Upcharge														
Pricing below represents upcharge for single arm pocket. For pockets on both arms, double the price.														
	COM	COL	A	B	C	D	E	F	G	H	I	J	L1	L2
No Leather Accent	\$131	\$188	\$140	\$158	\$188	\$228	\$267	\$329	\$395	\$465	\$574	\$706	\$443	\$531
With Leather Accent	\$174	\$231	\$183	\$200	\$231	\$271	\$310	\$371	\$437	\$507	\$617	\$749	\$485	\$573

Model	Upholstery	Pocket	Foot Style
	Grade Vendor Pattern Colorway	NP No Pocket LP Left Pocket LPX Right Pocket - No Accent LPAR Left Pocket with Brown Accent LPAK Left Pocket with Black Accent RP Right Pocket RPX Right Pocket - No Accent RPAR Right Pocket with Brown Accent RPAK Right Pocket with Black Accent BP Both Left & Right Pockets BPX Both Pockets - No Accent BPAR Both Pockets with Brown Accent BPAK Both Pockets with Black Accent see pocket for pricing	WF Wood Foot See Poet Wood Foot Finishes MF Metal Foot See Poet Metal Foot Finishes see foot finish style for pricing

Description + General Information

Two Seat with Center Table



- arm pocket available - upholstery same as arm and requires additional yardage, see upcharges below per arm
- undermount power center available - order EC30 separately

Dimensions	D	W	H	Shipping	
Overall	33	89	32	Ctn Wt	170
Seat	22	26 ½ ea	17 ½	Cu Ft	48
Arm			25 ¼		

	Single Upholstery	Frame Zone 1	Seat & Back Zone 2	Arm Zone 3	Pocket (per arm)
COM Ydg	12 ¼	4 ¼	5 ¼	3	1
COL Sq Ft	245	85	105	60	18

Single Upholstery Specify: Model | Single Uph | Pocket | Top Surface | Foot Style | Power

PLPF22T														
	COM	COL	A	B	C	D	E	F	G	H	I	J	L1	L2
Single Uph/Lam	\$4,472	\$5,171	\$4,580	\$4,795	\$5,171	\$5,655	\$6,138	\$6,891	\$7,697	\$8,556	\$9,900	\$11,512	\$8,288	\$9,362
Single Uph/Flat Cut	\$4,805	\$5,504	\$4,913	\$5,128	\$5,504	\$5,988	\$6,471	\$7,224	\$8,030	\$8,889	\$10,233	\$11,845	\$8,621	\$9,695
Single Uph/Dble Cut	\$4,831	\$5,530	\$4,939	\$5,154	\$5,530	\$6,014	\$6,497	\$7,250	\$8,056	\$8,915	\$10,259	\$11,871	\$8,647	\$9,721
Single Uph/Solid Surf	\$6,269	\$6,968	\$6,377	\$6,592	\$6,968	\$7,452	\$7,935	\$8,688	\$9,494	\$10,353	\$11,697	\$13,309	\$10,085	\$11,159

Multiple Upholstery Specify: Model | Frame Upholstery | Seat & Back Uph | Arm Uph | Pocket | Top Surface | Foot Style | Power

PLPF22T_M	Base Price Laminate: \$4,472							Base Price Flat Cut: \$4,805						
	Base Price Solid Surface: \$6,269							Base Price Double Cut: \$4,831						
To the Base Price, add the appropriate upcharges by grade, per zone														
	COM	COL	A	B	C	D	E	F	G	H	I	J	L1	L2
Frame - Zone 1	+n/a	+\$243	+\$38	+\$113	+\$243	+\$411	+\$578	+\$840	+\$1,119	+\$1,417	+\$1,884	+\$2,443	+\$1,324	+\$1,697
Seat & Back - Zone 2	+n/a	+\$300	+\$47	+\$139	+\$300	+\$507	+\$714	+\$1,037	+\$1,383	+\$1,751	+\$2,327	+\$3,018	+\$1,636	+\$2,096
Arm - Zone 3	+n/a	+\$172	+\$27	+\$80	+\$172	+\$290	+\$408	+\$593	+\$790	+\$1,001	+\$1,330	+\$1,725	+\$935	+\$1,198

Optional Arm Pocket Available on both Single and Multiple Upholstery Units with Arm Pocket Upholstery matching the Arm.

Pocket Upcharge Pricing below represents upcharge for single arm pocket. For pockets on both arms, double the price.														
	COM	COL	A	B	C	D	E	F	G	H	I	J	L1	L2
No Leather Accent	\$131	\$188	\$140	\$158	\$188	\$228	\$267	\$329	\$395	\$465	\$574	\$706	\$443	\$531
With Leather Accent	\$174	\$231	\$183	\$200	\$231	\$271	\$310	\$371	\$437	\$507	\$617	\$749	\$485	\$573

Model	Upholstery	Pocket	Top Surface	Foot Style	Power
	Grade Vendor Pattern Colorway	NP No Pocket LP Left Pocket LPX Right Pocket - No Accent LPAR Left Pocket with Brown Accent LPK Left Pocket with Black Accent RP Right Pocket RPX Right Pocket - No Accent RPAR Right Pocket with Brown Accent RPAK Right Pocket with Black Accent BP Both Left & Right Pocket BPX Both Pockets - No Accent BPAR Both Pockets with Brown Accent BPAK Both Pockets with Black Accent	T Laminate See Poet Laminate Finishes V Veneer See Poet Veneer Finishes S Solid Surface See Poet Solid Surface Finishes see top surface for pricing	WF Wood Foot See Poet Wood Foot Finishes MF Metal Foot See Poet Metal Foot Finishes see foot finish style for pricing	NSP No Surface Power YSP Surface Power (EC31) - add \$420 B Black Power Unit B Black Cord G Graphite Cord - add \$187 W White Power Unit G Graphite Cord - add \$187

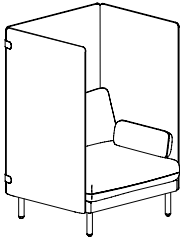
PL14 POET

see pocket for pricing

Description + General Information

Single Seat with Privacy Surround - Bolster

- leather not available on surround frame
- undermount power center available - order EC30 separately



left shown

Dimensions	D	W	H	Shipping	
Overall	34	37 ½	54	Ctn Wt	161
Seat	22	33	17 ½	Cu Ft	26

	Single Upholstery	Frame Zone 1	Seat & Back Zone 2	Bolster Zone 3
COM Ydg	12 ¾	8 ¾	3 ¾	¾
COL Sq Ft	80*	158	65	14

*seat/back/bolster only

Single Upholstery Specify: Model | Upholstery | Strap Accent | Foot Style

PLPFS31-PR PLPFS31-PL														
	COM	COL	A	B	C	D	E	F	G	H	I	J	L1	L2
Single Uph	\$5,209	n/a	\$5,321	\$5,545	\$5,936	\$6,440	\$6,943	\$7,726	\$8,565	\$9,460	\$10,858	\$12,536	n/a	n/a

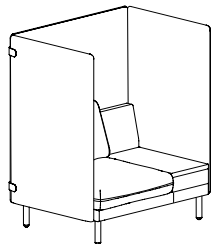
Multiple Upholstery Specify: Model | Frame Upholstery | Seat & Back Uph | Bolster Uph | Strap Accent | Foot Style

PLPFS31-PR_M PLPFS31-PL_M														
Base Price: \$5,209	To the Base Price, add the appropriate upcharges by grade, per zone													
	COM	COL	A	B	C	D	E	F	G	H	I	J	L1	L2
Frame - Zone 1	+n/a	+ n/a	+ \$77	+ \$231	+ \$499	+ \$845	+ \$1,190	+ \$1,728	+ \$2,304	+ \$2,918	+ \$3,877	+ \$5,029	+ n/a	+ n/a
Seat & Back - Zone 2	+n/a	+ \$200	+ \$31	+ \$93	+ \$200	+ \$338	+ \$476	+ \$691	+ \$922	+ \$1,167	+ \$1,551	+ \$2,012	+ \$1,091	+ \$1,398
Bolster - Zone 3	+n/a	+ \$43	+ \$7	+ \$20	+ \$43	+ \$73	+ \$102	+ \$149	+ \$198	+ \$251	+ \$333	+ \$431	+ \$234	+ \$300

Model	Upholstery	Strap Accent	Foot Style
	Grade Vendor Pattern Colorway	FA Fabric Accent LA Leather Accent - add \$105 BRO Brown BLK Black	WF Wood Foot See Poet Wood Foot Finishes MF Metal Foot See Poet Metal Foot Finishes see foot finish style for pricing

Description + General Information

Single Seat with Privacy Surround - Table



left shown

- leather not available on surround frame
- undermount power center available - order EC30 separately

Dimensions	D	W	H	Shipping	
Overall	34	51 ½	54	Ctn Wt	181
Seat	22	26 ½	17 ½	Cu Ft	31

	Single Upholstery	Frame Zone 1	Seat & Back Zone 2
COM Ydg	13 ¼	9 ¾	3 ¾
COL Sq Ft	65*	n/a	70

*seat/back only

Single Upholstery Specify: Model | Upholstery | Strap Accent | Top Surface | Foot Style

PLPFS31-TR PLPFS31-TL														
	COM	COL	A	B	C	D	E	F	G	H	I	J	L1	L2
Single Uph/Lam	\$5,532	n/a	\$5,649	\$5,881	\$6,288	\$6,811	\$7,335	\$8,148	\$9,020	\$9,950	\$11,403	\$13,147	n/a	n/a
Single Uph/Flat Cut	\$5,813	n/a	\$5,930	\$6,162	\$6,569	\$7,092	\$7,616	\$8,429	\$9,301	\$10,231	\$11,684	\$13,428	n/a	n/a
Single Uph/Dble Cut	\$5,825	n/a	\$5,942	\$6,174	\$6,581	\$7,104	\$7,628	\$8,441	\$9,313	\$10,243	\$11,696	\$13,440	n/a	n/a
Single Uph/Solid Surf	\$6,506	n/a	\$6,623	\$6,855	\$7,262	\$7,785	\$8,309	\$9,122	\$9,994	\$10,924	\$12,377	\$14,121	n/a	n/a

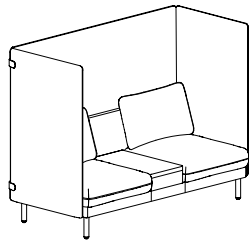
Multiple Upholstery Specify: Model | Frame Upholstery | Seat & Back Uph | Strap Accent | Top Surface | Foot Style

PLPFS31-TR_M PLPFS31-TL_M	Base Price Laminate: \$5,532							Base Price Flat Cut: \$5,813						
	Base Price Solid Surface: \$6,506							Base Price Double Cut: \$5,825						
To the Base Price, add the appropriate upcharges by grade, per zone														
	COM	COL	A	B	C	D	E	F	G	H	I	J	L1	L2
Frame - Zone 1	+n/a	+n/a	+\$87	+\$257	+\$557	+\$942	+\$1,327	+\$1,925	+\$2,567	+\$3,251	+\$4,321	+\$5,604	+n/a	+n/a
Seat & Back - Zone 2	+n/a	+\$214	+\$34	+\$99	+\$214	+\$362	+\$511	+\$741	+\$988	+\$1,251	+\$1,662	+\$2,156	+\$1,169	+\$1,498

Model	Upholstery	Strap Accent	Top Surface	Foot Style
	Grade Vendor Pattern Colorway	FA Fabric Accent LA Leather Accent - add \$105 BRO Brown BLK Black	T Laminate See Poet Laminate Finishes V Veneer See Poet Veneer Finishes S Solid Surface See Poet Solid Surface Finishes see top surface for pricing	WF Wood Foot See Poet Wood Foot Finishes MF Metal Foot See Poet Metal Foot Finishes see foot finish style for pricing

Description + General Information

Two Seat with Privacy Surround - Table



- leather not available on surround frame
- undermount power center available - order EC30 separately

Dimensions	D	W	H	Shipping	
Overall	34	78 ½	54	Ctn Wt	206
Seat	22	26 ½	17 ½	Cu Ft	51

	Single Upholstery	Frame Zone 1	Seat & Back Zone 2
COM Ydg	18 ¼	12 ¼	6 ¼
COL Sq Ft	115*	n/a	120

*seat/back only

Single Upholstery Specify: Model | Upholstery | Strap Accent | Top Surface | Foot Style | Power

PLPFS32-T														
	COM	COL	A	B	C	D	E	F	G	H	I	J	L1	L2
Single Uph/Lam	\$6,968	n/a	\$7,129	\$7,450	\$8,010	\$8,731	\$9,451	\$10,572	\$11,773	\$13,054	\$15,055	\$17,457	n/a	n/a
Single Uph/Flat Cut	\$7,249	n/a	\$7,410	\$7,731	\$8,291	\$9,012	\$9,732	\$10,853	\$12,054	\$13,335	\$15,336	\$17,738	n/a	n/a
Single Uph/Dble Cut	\$7,261	n/a	\$7,422	\$7,743	\$8,303	\$9,024	\$9,744	\$10,865	\$12,066	\$13,347	\$15,348	\$17,750	n/a	n/a
Single Uph/Solid Surf	\$7,942	n/a	\$8,103	\$8,424	\$8,984	\$9,705	\$10,425	\$11,546	\$12,747	\$14,028	\$16,029	\$18,431	n/a	n/a

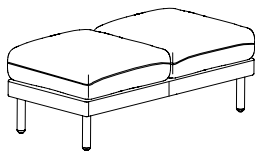
Multiple Upholstery Specify: Model | Frame Uph | Seat & Back Uph | Strap Accent | Top Surface | Foot Style | Power

PLPFS32-T_M														
	Base Price Laminate: \$6,968							Base Price Flat Cut: \$7,249						
	Base Price Solid Surface: \$7,942							Base Price Double Cut: \$7,261						
To the Base Price, add the appropriate upcharges by grade, per zone														
	COM	COL	A	B	C	D	E	F	G	H	I	J	L1	L2
Frame - Zone 1	+n/a	+ n/a	+ \$109	+ \$324	+ \$700	+ \$1,184	+ \$1,667	+ \$2,420	+ \$3,226	+ \$4,086	+ \$5,429	+ \$7,041	+ n/a	+ n/a
Seat & Back - Zone 2	+n/a	+ \$357	+ \$56	+ \$166	+ \$357	+ \$604	+ \$851	+ \$1,235	+ \$1,646	+ \$2,085	+ \$2,770	+ \$3,593	+ \$1,947	+ \$2,496

Model	Upholstery	Strap Accent	Top Surface	Foot Style	Power
	Grade Vendor Pattern Colorway	FA Fabric Accent LA Leather Accent - add \$105 BRO Brown BLK Black	T Laminate See Poet Laminate Finishes V Veneer See Poet Veneer Finishes S Solid Surface See Poet Solid Surface Finishes see top surface for pricing	WF Wood Foot See Poet Wood Foot Finishes MF Metal Foot See Poet Metal Foot Finishes see foot finish style for pricing	NSP No Surface Power YSP Surface Power (EC31) - add \$420 B Black Power Unit B Black Cord G Graphite Cord - add \$187 W White Power Unit G Graphite Cord - add \$187

Description + General Information

Two Seat Bench



- nylon glides (NYG) standard or metal glides (MTL) optional
- undermount power center available - order EC30 separately

Dimensions	D	W	H	Shipping	
Overall	23 ¾	43 ¾	17 ½	Ctn Wt	60
Seat	23 ¾	43 ¾	17 ½	Cu Ft	8

	Single Upholstery	Frame Zone 1	Seat & Back Zone 2
COM Ydg	3 ¾	¾	2 ¾
COL Sq Ft	59	15	55

Single Upholstery Specify: Model | Upholstery | Foot Style

PLPFB02														
	COM	COL	A	B	C	D	E	F	G	H	I	J	L1	L2
Single Uph	\$2,015	\$2,200	\$2,043	\$2,100	\$2,200	\$2,328	\$2,457	\$2,656	\$2,870	\$3,098	\$3,455	\$3,882	\$3,027	\$3,312

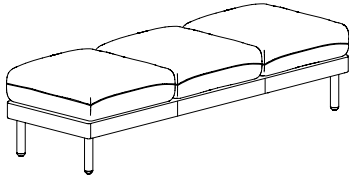
Multiple Upholstery Specify: Model | Frame Upholstery | Seat & Back Uph | Foot Style

PLPFB02_M														
Base Price: \$2,015	To the Base Price, add the appropriate upcharges by grade, per zone													
	COM	COL	A	B	C	D	E	F	G	H	I	J	L1	L2
Frame - Zone 1	+ n/a	+\$43	+\$7	+\$20	+\$43	+\$73	+\$102	+\$148	+\$198	+\$250	+\$333	+\$431	+\$234	+\$300
Seat - Zone 2	+ n/a	+\$157	+\$24	+\$72	+\$157	+\$265	+\$374	+\$543	+\$724	+\$917	+\$1,219	+\$1,580	+\$857	+\$1,098

Model	Upholstery	Foot Style
	Grade Vendor Pattern Colorway	WF Wood Foot See Poet Wood Foot Finishes MF Metal Foot See Poet Metal Foot Finishes see foot finish style for pricing

Description + General Information

Three Bench Seat



- nylon glides (NYG) standard or metal glides (MTL) optional
- undermount power center available - order EC30 separately

Dimensions	D	W	H	Shipping	
Overall	23 ¾	65 ½	17 ½	Ctn Wt	86
Seat	23 ¾	65 ½	17 ½	Cu Ft	12

	Single Upholstery	Frame Zone 1	Seat Zone 2
COM Ydg	4 ½	1	3 ¾
COL Sq Ft	81	15	75

Single Upholstery Specify: Model | Upholstery | Foot Style

PLPFB03														
	COM	COL	A	B	C	D	E	F	G	H	I	J	L1	L2
Single Uph	\$2,721	\$2,978	\$2,760	\$2,839	\$2,978	\$3,155	\$3,333	\$3,609	\$3,905	\$4,221	\$4,715	\$5,307	\$4,123	\$4,517

Multiple Upholstery Specify: Model | Frame Upholstery | Seat & Back Uph | Foot Style

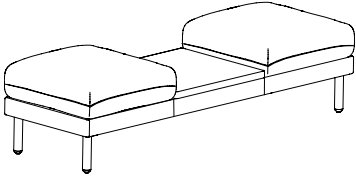
PLPFB03_M														
Base Price: \$2,721	To the Base Price, add the appropriate upcharges by grade, per zone													
	COM	COL	A	B	C	D	E	F	G	H	I	J	L1	L2
Frame - Zone 1	+ n/a	+\$58	+\$9	+\$27	+\$58	+\$97	+\$136	+\$198	+\$264	+\$334	+\$444	+\$575	+\$312	+\$400
Seat - Zone 2	+ n/a	+\$215	+\$33	+\$99	+\$215	+\$362	+\$510	+\$740	+\$987	+\$1,250	+\$1,662	+\$2,155	+\$1,169	+\$1,497

Model	Upholstery	Foot Style
	Grade Vendor Pattern Colorway	WF Wood Foot See Poet Wood Foot Finishes MF Metal Foot See Poet Metal Foot Finishes see foot finish style for pricing

Description + General Information

Two Seat Bench - Table

- undermount power center available - order EC30 separately



Dimensions	D	W	H	Shipping	
Overall	23 ¾	65 ½	17 ½	Ctn Wt	86
Seat	23 ¾	22 ea	17 ½	Cu Ft	12

	Single Upholstery	Frame Zone 1	Seat Zone 2
COM Ydg	3 ½	¾	3
COL Sq Ft	63	15	60

Single Upholstery Specify: Model | Single Uph | Top Surface | Foot Style | Power

PLPFB02T														
	COM	COL	A	B	C	D	E	F	G	H	I	J	L1	L2
Single Uph/Lam	\$2,333	\$2,532	\$2,363	\$2,425	\$2,532	\$2,670	\$2,809	\$3,024	\$3,254	\$3,500	\$3,883	\$4,344	\$3,423	\$3,730
Single Uph/Flat Cut	\$2,620	\$2,819	\$2,650	\$2,712	\$2,819	\$2,957	\$3,096	\$3,311	\$3,541	\$3,787	\$4,170	\$4,631	\$3,710	\$4,017
Single Uph/Dble Cut	\$2,635	\$2,834	\$2,665	\$2,727	\$2,834	\$2,972	\$3,111	\$3,326	\$3,556	\$3,802	\$4,185	\$4,646	\$3,725	\$4,032
Single Uph/Solid Surf	\$3,649	\$3,848	\$3,679	\$3,741	\$3,848	\$3,986	\$4,125	\$4,340	\$4,570	\$4,816	\$5,199	\$5,660	\$4,739	\$5,046

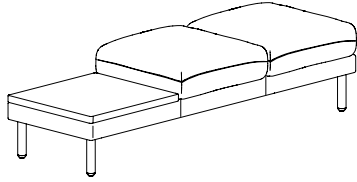
Multiple Upholstery Specify: Model | Frame Uph | Seat & Back Uph | Top Surface | Foot Style | Power

	Base Price Laminate: \$2,333							Base Price Flat Cut: \$2,620						
	Base Price Solid Surface: \$3,649							Base Price Double Cut: \$2,635						
To the Base Price, add the appropriate upcharges by grade, per zone														
	COM	COL	A	B	C	D	E	F	G	H	I	J	L1	L2
Frame - Zone 1	+n/a	+\$43	+\$7	+\$20	+\$43	+\$73	+\$102	+\$149	+\$198	+\$251	+\$333	+\$431	+\$234	+\$300
Seat - Zone 2	+n/a	+\$171	+\$26	+\$79	+\$171	+\$289	+\$408	+\$593	+\$790	+\$1,001	+\$1,329	+\$1,724	+\$935	+\$1,198

Model	Upholstery	Top Surface	Foot Style	Power
	Grade Vendor Pattern Colorway	T Laminate See Poet Laminate Finishes V Veneer See Poet Veneer Finishes S Solid Surface See Poet Solid Surface Finishes see top surface for pricing	WF Wood Foot See Poet Wood Foot Finishes MF Metal Foot See Poet Metal Foot Finishes see foot finish style for pricing	NSP No Surface Power YSP Surface Power (EC31) - add \$420 B Black Power Unit B Black Cord G Graphite Cord - add \$187 W White Power Unit G Graphite Cord - add \$187

Description + General Information

Two Seat Bench - Table



left shown

- undermount power center available - order EC30 separately

Dimensions	D	W	H	Shipping	
Overall	23 ¾	65 ½	17 ½	Ctn Wt	86
Seat	23 ¾	43 ¾	17 ½	Cu Ft	12

	Single Upholstery	Frame Zone 1	Seat Zone 2
COM Ydg	3 ½	¾	3
COL Sq Ft	63	15	60

Single Upholstery Specify: Model | Single Uph | Top Surface | Foot Style | Power

PLPFB02T-R
PLPFB02T-L

	COM	COL	A	B	C	D	E	F	G	H	I	J	L1	L2
Single Uph/Lam	\$2,333	\$2,532	\$2,363	\$2,425	\$2,532	\$2,670	\$2,809	\$3,024	\$3,254	\$3,500	\$3,883	\$4,344	\$3,423	\$3,730
Single Uph/Flat Cut	\$2,620	\$2,819	\$2,650	\$2,712	\$2,819	\$2,957	\$3,096	\$3,311	\$3,541	\$3,787	\$4,170	\$4,631	\$3,710	\$4,017
Single Uph/Dble Cut	\$2,635	\$2,834	\$2,665	\$2,727	\$2,834	\$2,972	\$3,111	\$3,326	\$3,556	\$3,802	\$4,185	\$4,646	\$3,725	\$4,032
Single Uph/Solid Surf	\$3,649	\$3,848	\$3,679	\$3,741	\$3,848	\$3,986	\$4,125	\$4,340	\$4,570	\$4,816	\$5,199	\$5,660	\$4,739	\$5,046

Multiple Upholstery Specify: Model | Frame Uph | Seat & Back Uph | Top Surface | Foot Style | Power

PLPFB02T-R_M
PLPFB02T-L_M

Base Price Laminate: \$2,333

Base Price Flat Cut: \$2,620

Base Price Solid Surface: \$3,649

Base Price Double Cut: \$2,635

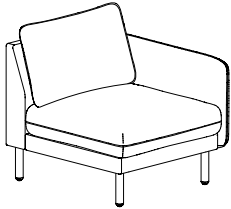
To the Base Price, add the appropriate upcharges by grade, per zone

	COM	COL	A	B	C	D	E	F	G	H	I	J	L1	L2
Frame - Zone 1	+n/a	+\$43	+\$7	+\$20	+\$43	+\$73	+\$102	+\$149	+\$198	+\$251	+\$333	+\$431	+\$234	+\$300
Seat - Zone 2	+n/a	+\$171	+\$26	+\$79	+\$171	+\$289	+\$408	+\$593	+\$790	+\$1,001	+\$1,329	+\$1,724	+\$935	+\$1,198

Model	Upholstery	Top Surface	Foot Style	Power
	Grade Vendor Pattern Colorway	T Laminate See Poet Laminate Finishes V Veneer See Poet Veneer Finishes S Solid Surface See Poet Solid Surface Finishes see top surface for pricing	WF Wood Foot See Poet Wood Foot Finishes MF Metal Foot See Poet Metal Foot Finishes see foot finish style for pricing	NSP No Surface Power YSP Surface Power (EC31) - add \$420 B Black Power Unit B Black Cord G Graphite Cord - add \$187 W White Power Unit G Graphite Cord - add \$187

Description + General Information

Single Seat with Arm



left shown

- arm pocket available - upholstery same as arm and requires additional yardage, see upcharges below per arm
- undermount power center available - order EC30 separately

Dimensions	D	W	H	Shipping	
Overall	33	31	32	Ctn Wt	68
Seat	22	26 ½	17 ½	Cu Ft	18
Arm			25 ¼		

	Single Upholstery	Frame Zone 1	Seat & Back Zone 2	Arm Zone 3	Pocket (per arm)
COM Ydg	6	2	2 ¾	1 ½	1
COL Sq Ft	120	40	55	30	18

Single Upholstery Specify: Model | Upholstery | Pocket | Foot Style | Ganging

PLPM11-R PLPM11-L

	COM	COL	A	B	C	D	E	F	G	H	I	J	L1	L2
Single Uph	\$2,508	\$2,850	\$2,561	\$2,666	\$2,850	\$3,087	\$3,324	\$3,692	\$4,087	\$4,508	\$5,166	\$5,956	\$4,377	\$4,903

Multiple Upholstery Specify: Model | Frame Upholstery | Seat & Back Uph | Arm Uph | Pocket | Foot Style | Ganging

PLPM11-R_M PLPM11-L_M

Base Price: \$2,508 To the Base Price, add the appropriate upcharges by grade, per zone

	COM	COL	A	B	C	D	E	F	G	H	I	J	L1	L2
Frame - Zone 1	+ n/a	+\$114	+\$18	+\$53	+\$114	+\$193	+\$272	+\$395	+\$527	+\$667	+\$886	+\$1,150	+\$623	+\$799
Seat & Back - Zone 2	+ n/a	+\$157	+\$25	+\$73	+\$157	+\$266	+\$374	+\$543	+\$724	+\$917	+\$1,219	+\$1,581	+\$857	+\$1,098
Arm - Zone 3	+ n/a	+\$86	+\$14	+\$40	+\$86	+\$145	+\$204	+\$296	+\$395	+\$500	+\$665	+\$862	+\$468	+\$599

Optional Arm Pocket Available on both Single and Multiple Upholstery Units with Arm Pocket Upholstery matching the Arm.

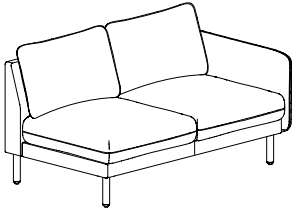
Pocket Upcharge Pricing below represents upcharge for single arm pocket. For pockets on both arms, double the price.

	COM	COL	A	B	C	D	E	F	G	H	I	J	L1	L2
No Leather Accent	\$131	\$188	\$140	\$158	\$188	\$228	\$267	\$329	\$395	\$465	\$574	\$706	\$443	\$531
With Leather Accent	\$174	\$231	\$183	\$200	\$231	\$271	\$310	\$371	\$437	\$507	\$617	\$749	\$485	\$573

Model	Upholstery	Pocket	Foot Style	Ganging
PL22 POET	Grade Vendor Pattern Colorway	NP No Pocket RP Right Pocket RPX Right Pocket - No Accent RPAR Right Pocket with Brown Accent RPAK Right Pocket with Black Accent LP Left Pocket LPX Left Pocket - No Accent LPAR Left Pocket with Brown Accent LPAK Left Pocket with Black Accent see pocket for pricing	WF Wood Foot See Poet Wood Foot Finishes MF Metal Foot See Poet Metal Foot Finishes see foot finish style for pricing	NGB No Ganging Brackets YGV Ganging Bracket - add \$50

Description + General Information

Two Seat with Arm



left shown

- arm pocket available - upholstery same as arm and requires additional yardage, see upcharges below per arm
- undermount power center available - order EC30 separately

Dimensions	D	W	H	Shipping	
Overall	33	58	32	Ctn Wt	115
Seat	22	53 ½	17 ½	Cu Ft	32
Arm			25 ¼		

	Single Upholstery	Frame Zone 1	Seat & Back Zone 2	Arm Zone 3	Pocket (per arm)
COM Ydg	10 ½	3 ¾	5 ½	1 ½	1
COL Sq Ft	210	70	110	30	18

Single Upholstery Specify: Model | Upholstery | Pocket | Foot Style | Ganging

PLPM12-R PLPM12-L														
	COM	COL	A	B	C	D	E	F	G	H	I	J	L1	L2
Single Uph	\$3,735	\$4,334	\$3,827	\$4,011	\$4,334	\$4,748	\$5,163	\$5,808	\$6,499	\$7,236	\$8,387	\$9,769	\$7,005	\$7,926

Multiple Upholstery Specify: Model | Frame Upholstery | Seat & Back Uph | Arm Uph | Pocket | Foot Style | Ganging

PLPM12-R_M PLPM12-L_M														
Base Price: \$3,735	To the Base Price, add the appropriate upcharges by grade, per zone													
	COM	COL	A	B	C	D	E	F	G	H	I	J	L1	L2
Frame - Zone 1	+ n/a	+\$214	+ \$33	+ \$99	+\$214	+\$362	+ \$510	+ \$741	+ \$988	+ \$1,251	+ \$1,662	+ \$2,155	+ \$1,168	+ \$1,497
Seat & Back - Zone 2	+ n/a	+\$314	+ \$49	+\$145	+\$314	+\$531	+ \$748	+ \$1,086	+ \$1,448	+ \$1,834	+ \$2,437	+ \$3,161	+ \$1,713	+ \$2,196
Arm - Zone 3	+ n/a	+\$86	+ \$14	+\$40	+\$86	+\$145	+ \$204	+ \$297	+ \$395	+ \$501	+ \$665	+ \$862	+ \$468	+ \$599

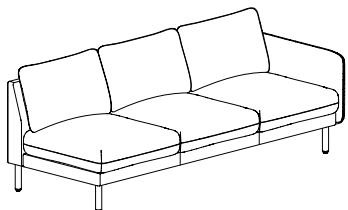
Optional Arm Pocket Available on both Single and Multiple Upholstery Units with Arm Pocket Upholstery matching the Arm.

Pocket Upcharge Pricing below represents upcharge for single arm pocket. For pockets on both arms, double the price.														
	COM	COL	A	B	C	D	E	F	G	H	I	J	L1	L2
No Leather Accent	\$131	\$188	\$140	\$158	\$188	\$228	\$267	\$329	\$395	\$465	\$574	\$706	\$443	\$531
With Leather Accent	\$174	\$231	\$183	\$200	\$231	\$271	\$310	\$371	\$437	\$507	\$617	\$749	\$485	\$573

Model	Upholstery	Pocket	Foot Style	Ganging
	Grade Vendor Pattern Colorway	NP No Pocket RP Right Pocket RPX Right Pocket - No Accent RPAR Right Pocket with Brown Accent RPAK Right Pocket with Black Accent LP Left Pocket LPX Left Pocket - No Accent LPAR Left Pocket with Brown Accent LPAK Left Pocket with Black Accent see pocket for pricing	WF Wood Foot See Poet Wood Foot Finishes MF Metal Foot See Poet Metal Foot Finishes see foot finish style for pricing	NGB No Ganging Brackets YGV Ganging Bracket - add \$50

Description + General Information

Three Seat with Arm



- arm pocket available - upholstery same as arm and requires additional yardage, see upcharges below per arm
- undermount power center available - order EC30 separately

Dimensions	D	W	H	Shipping	
Overall	33	85	32	Ctn Wt	160
Seat	22	80 ½	17 ½	Cu Ft	46
Arm			25 ¼		

	Single Upholstery	Frame Zone 1	Seat & Back Zone 2	Arm Zone 3	Pocket (per arm)
COM Ydg	14 ¾	5 ½	8	1 ½	1
COL Sq Ft	295	110	160	30	18

Single Upholstery Specify: Model | Upholstery | Pocket | Foot Style | Ganging

PLPM13-R PLPM13-L														
	COM	COL	A	B	C	D	E	F	G	H	I	J	L1	L2
Single Uph	\$5,085	\$5,927	\$5,215	\$5,474	\$5,927	\$6,509	\$7,092	\$7,997	\$8,968	\$10,003	\$11,621	\$13,562	\$9,680	\$10,974

Multiple Upholstery Specify: Model | Frame Upholstery | Seat & Back Uph | Arm Uph | Pocket | Foot Style | Ganging

PLPM13-R_M PLPM13-L_M														
Base Price: \$5,085	To the Base Price, add the appropriate upcharges by grade, per zone													
	COM	COL	A	B	C	D	E	F	G	H	I	J	L1	L2
Frame - Zone 1	+ n/a	+\$314	+\$49	+\$146	+\$314	+\$531	+\$749	+\$1,086	+\$1,448	+\$1,834	+\$2,438	+\$3,161	+\$1,714	+\$2,196
Seat & Back - Zone 2	+ n/a	+\$457	+\$71	+\$211	+\$457	+\$773	+\$1,089	+\$1,580	+\$2,107	+\$2,668	+\$3,545	+\$4,598	+\$2,493	+\$3,195
Arm - Zone 3	+ n/a	+\$86	+\$14	+\$40	+\$86	+\$145	+\$205	+\$297	+\$395	+\$501	+\$665	+\$863	+\$468	+\$599

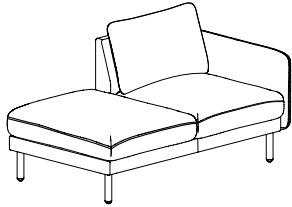
Optional Arm Pocket Available on both Single and Multiple Upholstery Units with Arm Pocket Upholstery matching the Arm.

Pocket Upcharge Pricing below represents upcharge for single arm pocket. For pockets on both arms, double the price.														
	COM	COL	A	B	C	D	E	F	G	H	I	J	L1	L2
No Leather Accent	\$131	\$188	\$140	\$158	\$188	\$228	\$267	\$329	\$395	\$465	\$574	\$706	\$443	\$531
With Leather Accent	\$174	\$231	\$183	\$200	\$231	\$271	\$310	\$371	\$437	\$507	\$617	\$749	\$485	\$573

Model	Upholstery	Pocket	Foot Style	Ganging
PL24 POET	Grade Vendor Pattern Colorway	NP No Pocket RP Right Pocket RPX Right Pocket - No Accent RPAR Right Pocket with Brown Accent RPAAK Right Pocket with Black Accent LP Left Pocket LPX Left Pocket - No Accent LPAR Left Pocket with Brown Accent LPAAK Left Pocket with Black Accent see pocket for pricing	WF Wood Foot See Poet Wood Foot Finishes MF Metal Foot See Poet Metal Foot Finishes see foot finish style for pricing	NGB No Ganging Brackets YGV Ganging Bracket - add \$50

Description + General Information

Two Seat with Peninsula Arm



left shown

- arm pocket available - upholstery same as arm and requires additional yardage, see upcharges below per arm
- undermount power center available - order EC30 separately

Dimensions	D	W	H	Shipping	
Overall	34	58	32	Ctn Wt	111
Seat	22 & 34	53 ½	17 ½	Cu Ft	33
Arm			25 ¼		

	Single Upholstery	Frame Zone 1	Seat & Back Zone 2	Arm Zone 3	Pocket (per arm)
COM Ydg	8 ½	2 ¼	5	1 ½	1
COL Sq Ft	170	45	100	30	18

Single Upholstery Specify: Model | Upholstery | Pocket | Foot Style | Ganging

PLPMP12B-R PLPMP12B-L														
	COM	COL	A	B	C	D	E	F	G	H	I	J	L1	L2
Single Uph	\$3,433	\$3,918	\$3,508	\$3,657	\$3,918	\$4,253	\$4,589	\$5,111	\$5,670	\$6,267	\$7,199	\$8,318	\$6,080	\$6,826

Multiple Upholstery Specify: Model | Frame Upholstery | Seat & Back Uph | Arm Uph | Pocket | Foot Style | Ganging

PLPMP12B-R_M PLPMP12B-L_M														
Base Price: \$3,433	To the Base Price, add the appropriate upcharges by grade, per zone													
	COM	COL	A	B	C	D	E	F	G	H	I	J	L1	L2
Frame - Zone 1	+ n/a	+\$129	+ \$20	+ \$60	+\$129	+\$218	+ \$306	+ \$445	+ \$593	+ \$751	+ \$997	+ \$1,294	+ \$701	+ \$899
Seat & Back - Zone 2	+ n/a	+\$286	+ \$45	+\$132	+\$286	+\$483	+ \$680	+ \$988	+ \$1,316	+ \$1,668	+ \$2,216	+ \$2,874	+ \$1,558	+ \$1,996
Arm - Zone 3	+ n/a	+\$86	+ \$14	+\$40	+\$86	+\$145	+ \$204	+ \$297	+ \$395	+ \$501	+ \$665	+ \$863	+ \$468	+ \$599

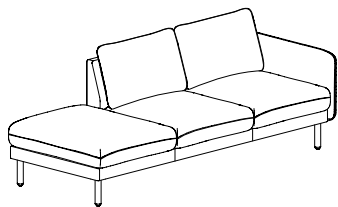
Optional Arm Pocket Available on both Single and Multiple Upholstery Units with Arm Pocket Upholstery matching the Arm.

Pocket Upcharge Pricing below represents upcharge for single arm pocket. For pockets on both arms, double the price.														
	COM	COL	A	B	C	D	E	F	G	H	I	J	L1	L2
No Leather Accent	\$131	\$188	\$140	\$158	\$188	\$228	\$267	\$329	\$395	\$465	\$574	\$706	\$443	\$531
With Leather Accent	\$174	\$231	\$183	\$200	\$231	\$271	\$310	\$371	\$437	\$507	\$617	\$749	\$485	\$573

Model	Upholstery	Pocket	Foot Style	Ganging
	Grade Vendor Pattern Colorway	NP No Pocket RP Right Pocket RPX Right Pocket - No Accent RPAR Right Pocket with Brown Accent RPAK Right Pocket with Black Accent LP Left Pocket LPX Left Pocket - No Accent LPAR Left Pocket with Brown Accent LPAK Left Pocket with Black Accent see pocket for pricing	WF Wood Foot See Poet Wood Foot Finishes MF Metal Foot See Poet Metal Foot Finishes see foot finish style for pricing	NGB No Ganging Brackets YGV Ganging Bracket - add \$50

Description + General Information

Two Seat Peninsula with Arm



left shown

- arm pocket available - upholstery same as arm and requires additional yardage, see upcharges below per arm
- undermount power center available - order EC30 separately

Dimensions	D	W	H	Shipping	
Overall	34	85	32	Ctn Wt	154
Seat	22 & 34	80 ½	17 ½	Cu Ft	48
Arm			25 ½		

	Single Upholstery	Frame Zone 1	Seat & Back Zone 2	Arm Zone 3	Pocket (per arm)
COM Ydg	13	4 ½	7 ¼	1 ½	1
COL Sq Ft	260	85	145	30	18

Single Upholstery Specify: Model | Upholstery | Pocket | Foot Style | Ganging

PLPMP13B-R PLPMP13B-L

	COM	COL	A	B	C	D	E	F	G	H	I	J	L1	L2
Single Uph	\$4,700	\$5,441	\$4,814	\$5,042	\$5,441	\$5,955	\$6,468	\$7,266	\$8,122	\$9,034	\$10,460	\$12,171	\$8,749	\$9,890

Multiple Upholstery Specify: Model | Frame Upholstery | Seat & Back Uph | Arm Uph | Pocket | Foot Style | Ganging

PLPMP13B-R_M PLPMP13B-L_M

Base Price: \$4,700 To the Base Price, add the appropriate upcharges by grade, per zone

	COM	COL	A	B	C	D	E	F	G	H	I	J	L1	L2
Frame - Zone 1	+ n/a	+\$257	+\$40	+\$119	+\$257	+\$435	+\$612	+\$889	+\$1,185	+\$1,501	+\$1,994	+\$2,587	+\$1,402	+\$1,797
Seat & Back - Zone 2	+ n/a	+\$414	+\$64	+\$191	+\$414	+\$700	+\$986	+\$1,432	+\$1,909	+\$2,418	+\$3,213	+\$4,167	+\$2,259	+\$2,895
Arm - Zone 3	+ n/a	+\$86	+\$14	+\$40	+\$86	+\$145	+\$204	+\$297	+\$395	+\$501	+\$665	+\$863	+\$468	+\$599

Optional Arm Pocket Available on both Single and Multiple Upholstery Units with Arm Pocket Upholstery matching the Arm.

Pocket Upcharge

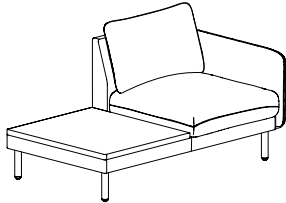
Pricing below represents upcharge for single arm pocket. For pockets on both arms, double the price.

	COM	COL	A	B	C	D	E	F	G	H	I	J	L1	L2
No Leather Accent	\$131	\$188	\$140	\$158	\$188	\$228	\$267	\$329	\$395	\$465	\$574	\$706	\$443	\$531
With Leather Accent	\$174	\$231	\$183	\$200	\$231	\$271	\$310	\$371	\$437	\$507	\$617	\$749	\$485	\$573

Model	Upholstery	Pocket	Foot Style	Ganging
PL26 POET	Grade Vendor Pattern Colorway	NP No Pocket RP Right Pocket RPX Right Pocket - No Accent RPAR Right Pocket with Brown Accent RPAP Right Pocket with Black Accent LP Left Pocket LPX Left Pocket - No Accent LPAR Left Pocket with Brown Accent LPAK Left Pocket with Black Accent see pocket for pricing	WF Wood Foot See Poet Wood Foot Finishes MF Metal Foot See Poet Metal Foot Finishes see foot finish style for pricing	NGB No Ganging Brackets YGV Ganging Bracket - add \$50

Description + General Information

Single Seat with Arm - Table



left shown

- arm pocket available - upholstery same as arm and requires additional yardage, see upcharges below per arm
- undermount power center available - order EC30 separately

Dimensions	D	W	H	Shipping	
Overall	34 ¾	58	32	Ctn Wt	111
Seat	22	26 ½	17 ½	Cu Ft	34
Arm			25 ¼		

	Single Upholstery	Frame Zone 1	Seat & Back Zone 2	Arm Zone 3	Pocket (per arm)
COM Ydg	6 ½	2 ½	2 ¾	1 ½	1
COL Sq Ft	130	45	55	30	18

Single Upholstery Specify: Model | Single Uph | Pocket | Top Surface | Foot Style | Power | Ganging

PLPMP11T-R PLPMP11T-L														
	COM	COL	A	B	C	D	E	F	G	H	I	J	L1	L2
Single Uph/Lam	\$2,868	\$3,239	\$2,925	\$3,039	\$3,239	\$3,496	\$3,752	\$4,151	\$4,579	\$5,035	\$5,748	\$6,604	\$4,893	\$5,463
Single Uph/Flat Cut	\$3,201	\$3,572	\$3,258	\$3,372	\$3,572	\$3,829	\$4,085	\$4,484	\$4,912	\$5,368	\$6,081	\$6,937	\$5,226	\$5,796
Single Uph/Dble Cut	\$3,227	\$3,598	\$3,284	\$3,398	\$3,598	\$3,855	\$4,111	\$4,510	\$4,938	\$5,394	\$6,107	\$6,963	\$5,252	\$5,822
Single Uph/Solid Surf	\$4,665	\$5,036	\$4,722	\$4,836	\$5,036	\$5,293	\$5,549	\$5,948	\$6,376	\$6,832	\$7,545	\$8,401	\$6,690	\$7,260

Multiple Upholstery Specify: Model | Frame Uph | Seat & Back Uph | Arm Uph | Pocket | Top Surface | Foot Style | Power | Ganging

PLPMP11T-R_M PLPMP11T-L_M														
	Base Price Laminate: \$2,868							Base Price Flat Cut: \$3,201						
	Base Price Solid Surface: \$4,665							Base Price Double Cut: \$3,227						
	To the Base Price, add the appropriate upcharges by grade, per zone													
	COM	COL	A	B	C	D	E	F	G	H	I	J	L1	L2
Frame - Zone 1	+n/a	+\$143	+\$22	+\$66	+\$143	+\$242	+\$340	+\$494	+\$659	+\$834	+\$1,108	+\$1,437	+\$779	+\$999
Seat & Back - Zone 2	+n/a	+\$157	+\$25	+\$73	+\$157	+\$266	+\$374	+\$543	+\$724	+\$917	+\$1,219	+\$1,581	+\$857	+\$1,098
Arm - Zone 3	+n/a	+\$86	+\$14	+\$40	+\$86	+\$145	+\$204	+\$297	+\$395	+\$501	+\$665	+\$863	+\$468	+\$599

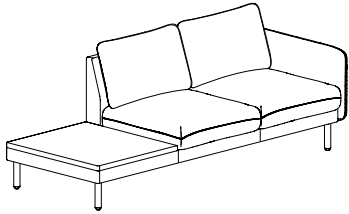
Optional Arm Pocket Available on both Single and Multiple Upholstery Units with Arm Pocket Upholstery matching the Arm.

Pocket Upcharge														
Pricing below represents upcharge for single arm pocket. For pockets on both arms, double the price.														
	COM	COL	A	B	C	D	E	F	G	H	I	J	L1	L2
No Leather Accent	\$131	\$188	\$140	\$158	\$188	\$228	\$267	\$329	\$395	\$465	\$574	\$706	\$443	\$531
With Leather Accent	\$174	\$231	\$183	\$200	\$231	\$271	\$310	\$371	\$437	\$507	\$617	\$749	\$485	\$573

Model	Upholstery	Pocket	Top Surface	Foot Style	Power	Ganging
	Grade Vendor Pattern Colorway	NP No Pocket RP Right Pocket RPX Right Pocket - No Accent RPAR Right Pocket with Brown Accent RPAK Right Pocket with Black Accent LP Left Pocket LPX Left Pocket - No Accent LPAR Left Pocket with Brown Accent LPAK Left Pocket with Black Accent see pocket for pricing	T Laminate See Poet Laminate Finishes V Veneer See Poet Veneer Finishes S Solid Surface See Poet Solid Surface Finishes see top surface for pricing	WF Wood Foot See Poet Wood Foot Finishes MF Metal Foot See Poet Metal Foot Finishes see foot finish style for pricing	NSP No Surface Power YSP Surface Power (EC31) - add \$420 B Black Power Unit B Black Cord G Graphite Cord - add \$187 W White Power Unit G Graphite Cord - add \$187	NGB No Ganging Brackets YGV Ganging Bracket - add \$50

Description + General Information

Two Seat with Arm - Table



left shown

- arm pocket available - upholstery same as arm and requires additional yardage, see upcharges below per arm
- undermount power center available - order EC30 separately

Dimensions	D	W	H	Shipping	
Overall	34 ¾	85	32	Ctn Wt	154
Seat	22	53 ½	17 ½	Cu Ft	49
Arm			25 ¼		

	Single Upholstery	Frame Zone 1	Seat & Back Zone 2	Arm Zone 3	Pocket (per arm)
COM Ydg	11	4 ½	5 ¼	1 ½	1
COL Sq Ft	220	85	105	30	18

Single Upholstery Specify: Model | Single Uph | Pocket | Top Surface | Foot Style | Power | Ganging

PLPMP12T-R PLPMP12T-L														
	COM	COL	A	B	C	D	E	F	G	H	I	J	L1	L2
Single Uph/Lam	\$4,055	\$4,683	\$4,152	\$4,345	\$4,683	\$5,117	\$5,552	\$6,227	\$6,951	\$7,723	\$8,929	\$10,377	\$7,482	\$8,447
Single Uph/Flat Cut	\$4,388	\$5,016	\$4,485	\$4,678	\$5,016	\$5,450	\$5,885	\$6,560	\$7,284	\$8,056	\$9,262	\$10,710	\$7,815	\$8,780
Single Uph/Dble Cut	\$4,414	\$5,042	\$4,511	\$4,704	\$5,042	\$5,476	\$5,911	\$6,586	\$7,310	\$8,082	\$9,288	\$10,736	\$7,841	\$8,806
Single Uph/Solid Surf	\$5,852	\$6,480	\$5,949	\$6,142	\$6,480	\$6,914	\$7,349	\$8,024	\$8,748	\$9,520	\$10,726	\$12,174	\$9,279	\$10,244

Multiple Upholstery Specify: Model | Frame Uph | Seat & Back Uph | Arm Uph | Pocket | Top Surface | Foot Style | Power | Ganging

PLPMP12T-R_M PLPMP12T-L_M														
Base Price Laminate: \$4,055 Base Price Flat Cut: \$4,388														
Base Price Solid Surface: \$5,852 Base Price Double Cut: \$4,414														
To the Base Price, add the appropriate upcharges by grade, per zone														
	COM	COL	A	B	C	D	E	F	G	H	I	J	L1	L2
Frame - Zone 1	+n/a	+\$261	+\$40	+\$119	+\$257	+\$435	+\$613	+\$889	+\$1,185	+\$1,501	+\$1,994	+\$2,587	+\$1,402	+\$1,797
Seat & Back - Zone 2	+n/a	+\$305	+\$47	+\$139	+\$300	+\$507	+\$715	+\$1,037	+\$1,383	+\$1,751	+\$2,327	+\$3,018	+\$1,636	+\$2,097
Arm - Zone 3	+ n/a	+\$86	+\$14	+\$40	+\$86	+\$145	+\$205	+\$297	+\$395	+\$501	+\$665	+\$863	+\$468	+\$599

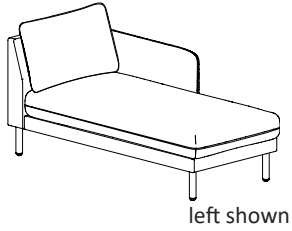
Optional Arm Pocket Available on both Single and Multiple Upholstery Units with Arm Pocket Upholstery matching the Arm.

Pocket Upcharge Pricing below represents upcharge for single arm pocket. For pockets on both arms, double the price.														
	COM	COL	A	B	C	D	E	F	G	H	I	J	L1	L2
No Leather Accent	\$131	\$188	\$140	\$158	\$188	\$228	\$267	\$329	\$395	\$465	\$574	\$706	\$443	\$531
With Leather Accent	\$174	\$231	\$183	\$200	\$231	\$271	\$310	\$371	\$437	\$507	\$617	\$749	\$485	\$573

Model	Upholstery	Pocket	Top Surface	Foot Style	Power	Ganging
	Grade Vendor Pattern Colorway	NP No Pocket RP Right Pocket RPX Right Pocket - No Accent RPAR Right Pocket with Brown Accent RPAK Right Pocket with Black Accent LP Left Pocket LPX Left Pocket - No Accent LPAR Left Pocket with Brown Accent LPAK Left Pocket with Black Accent see pocket for pricing	T Laminate See Poet Laminate Finishes V Veneer See Poet Veneer Finishes S Solid Surface See Poet Solid Surface Finishes see top surface for pricing	WF Wood Foot See Poet Wood Foot Finishes MF Metal Foot See Poet Metal Foot Finishes see foot finish style for pricing	NSP No Surface Power YSP Surface Power (EC31) - add \$420 B Black Power Unit B Black Cord G Graphite Cord - add \$187 W White Power Unit G Graphite Cord - add \$187	NGB No Ganging Brackets YGV Ganging Bracket - add \$50

Description + General Information

Chaise



- arm pocket available - upholstery same as arm and requires additional yardage, see upcharges below per arm
- undermount power center available - order EC30 separately

Dimensions	D	W	H	Shipping	
Overall	60	31	32	Ctn Wt	82
Seat	49	26 ½	17 ½	Cu Ft	31
Arm			25 ¼		

	Single Upholstery	Frame Zone 1	Seat & Back Zone 2	Arm Zone 3	Pocket (per arm)
COM Ydg	7	2	2 ¾	1 ½	1
COL Sq Ft	140	40	75	30	18

Single Upholstery Specify: Model | Single Uph | Pocket | Foot Style | Ganging

PLPM16-R PLPM16-L														
	COM	COL	A	B	C	D	E	F	G	H	I	J	L1	L2
Single Uph	\$3,204	\$3,603	\$3,265	\$3,388	\$3,603	\$3,879	\$4,156	\$4,586	\$5,046	\$5,538	\$6,305	\$7,226	\$5,384	\$5,998

Multiple Upholstery Specify: Model | Frame Upholstery | Seat & Back Uph | Arm Uph | Pocket | Foot Style | Ganging

PLPM16-R_M PLPM16-L_M														
Base Price: \$3,204	To the Base Price, add the appropriate upcharges by grade, per zone													
	COM	COL	A	B	C	D	E	F	G	H	I	J	L1	L2
Frame - Zone 1	+ n/a	+\$114	+ \$18	+ \$53	+\$114	+\$193	+ \$272	+ \$395	+ \$527	+ \$667	+ \$886	+ \$1,150	+ \$623	+ \$799
Seat & Back - Zone 2	+ n/a	+\$214	+ \$33	+\$99	+\$214	+\$362	+ \$510	+ \$741	+ \$987	+ \$1,251	+ \$1,662	+ \$2,155	+ \$1,168	+ \$1,497
Arm - Zone 3	+ n/a	+\$86	+ \$14	+\$40	+\$86	+\$145	+ \$204	+ \$297	+ \$395	+ \$501	+ \$665	+ \$862	+ \$468	+ \$599

Optional Arm Pocket Available on both Single and Multiple Upholstery Units with Arm Pocket Upholstery matching the Arm.

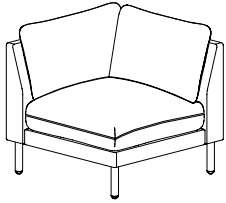
Pocket Upcharge Pricing below represents upcharge for single arm pocket. For pockets on both arms, double the price.														
	COM	COL	A	B	C	D	E	F	G	H	I	J	L1	L2
No Leather Accent	\$131	\$188	\$140	\$158	\$188	\$228	\$267	\$329	\$395	\$465	\$574	\$706	\$443	\$531
With Leather Accent	\$174	\$231	\$183	\$200	\$231	\$271	\$310	\$371	\$437	\$507	\$617	\$749	\$485	\$573

Model	Upholstery	Pocket	Foot Style	Ganging
	Grade Vendor Pattern Colorway	NP No Pocket RP Right Pocket RPX Right Pocket - No Accent RPAR Right Pocket with Brown Accent RPAK Right Pocket with Black Accent LP Left Pocket LPX Left Pocket - No Accent LPAR Left Pocket with Brown Accent LPAK Left Pocket with Black Accent see pocket for pricing	WF Wood Foot See Poet Wood Foot Finishes MF Metal Foot See Poet Metal Foot Finishes see foot finish style for pricing	NGB No Ganging Brackets YGV Ganging Bracket - add \$50

Description + General Information

Corner

- undermount power center available - order EC30 separately



Dimensions	D	W	H	Shipping	
Overall	31 ½	31 ½	32	Ctn Wt	66
Seat	20 ½	20 ½	17 ½	Cu Ft	17

	Single Upholstery	Frame Zone 1	Seat & Back Zone 2
COM Ydg	7	3 ¼	4 ¼
COL Sq Ft	140	65	85

Single Upholstery Specify: Model | Single Uph | Foot Style | Ganging

PLPMC01-R PLPMC01-L														
	COM	COL	A	B	C	D	E	F	G	H	I	J	L1	L2
Single Uph	\$2,631	\$3,030	\$2,693	\$2,815	\$3,030	\$3,307	\$3,583	\$4,013	\$4,474	\$4,965	\$5,732	\$6,654	\$4,811	\$5,425

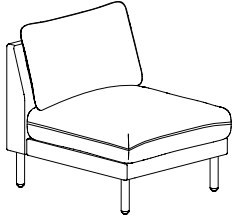
Multiple Upholstery Specify: Model | Frame Upholstery | Seat & Back Uph | Foot Style | Ganging

PLPMC01-R_M PLPMC01-L_M														
Base Price: \$2,631	To the Base Price, add the appropriate upcharges by grade, per zone													
	COM	COL	A	B	C	D	E	F	G	H	I	J	L1	L2
Frame - Zone 1	+ n/a	+\$186	+\$29	+\$86	+\$186	+\$314	+\$442	+\$642	+\$856	+\$1,084	+\$1,440	+\$1,868	+\$1,013	+\$1,298
Seat & Back - Zone 2	+ n/a	+\$243	+\$38	+\$112	+\$243	+\$411	+\$578	+\$840	+\$1,119	+\$1,418	+\$1,883	+\$2,443	+\$1,324	+\$1,697

Model	Upholstery	Foot Style	Ganging
	Grade Vendor Pattern Colorway	WF Wood Foot See Poet Wood Foot Finishes MF Metal Foot See Poet Metal Foot Finishes see foot finish style for pricing	NGB No Ganging Brackets YGV Ganging Bracket - add \$50

Description + General Information

Single Seat - Armless



- undermount power center available - order EC30 separately

Dimensions	D	W	H	Shipping	
Overall	33	27	32	Ctn Wt	54
Seat	22	27	17 ½	Cu Ft	16

	Single Upholstery	Frame Zone 1	Seat & Back Zone 2
COM Ydg	4 ½	2	2 ¾
COL Sq Ft	90	40	55

Single Upholstery Specify: Model | Upholstery | Foot Style | Ganging

PLPM01														
	COM	COL	A	B	C	D	E	F	G	H	I	J	L1	L2
Single Uph	\$2,113	\$2,370	\$2,153	\$2,232	\$2,370	\$2,547	\$2,725	\$3,001	\$3,298	\$3,613	\$4,107	\$4,699	\$3,515	\$3,909

Multiple Upholstery Specify: Model | Frame Upholstery | Seat & Back Uph | Foot Style | Ganging

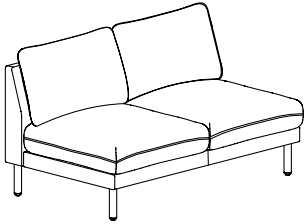
PLPM01_M														
Base Price: \$2,113	To the Base Price, add the appropriate upcharges by grade, per zone													
	COM	COL	A	B	C	D	E	F	G	H	I	J	L1	L2
Frame - Zone 1	+ n/a	+\$115	+ \$18	+ \$53	+\$115	+\$193	+ \$272	+ \$395	+ \$527	+ \$667	+ \$887	+ \$1,150	+ \$624	+ \$799
Seat & Back - Zone 2	+ n/a	+\$158	+ \$25	+\$73	+\$158	+\$266	+ \$374	+ \$543	+ \$725	+ \$917	+ \$1,219	+ \$1,581	+ \$857	+ \$1,098

Model	Upholstery	Foot Style	Ganging
	Grade Vendor Pattern Colorway	WF Wood Foot See Poet Wood Foot Finishes MF Metal Foot See Poet Metal Foot Finishes see foot finish style for pricing	NGB No Ganging Brackets YGV Ganging Bracket - add \$50

Description + General Information

Two Seat - Armless

- undermount power center available - order EC30 separately



Dimensions	D	W	H	Shipping	
Overall	33	54 ¼	32	Ctn Wt	101
Seat	22	54 ¼	17 ½	Cu Ft	30

	Single Upholstery	Frame Zone 1	Seat & Back Zone 2
COM Ydg	9	3 ¾	5 ½
COL Sq Ft	180	70	110

Single Upholstery Specify: Model | Upholstery | Foot Style | Ganging

PLPM02

	COM	COL	A	B	C	D	E	F	G	H	I	J	L1	L2
Single Uph	\$3,283	\$3,797	\$3,363	\$3,521	\$3,797	\$4,152	\$4,508	\$5,060	\$5,652	\$6,284	\$7,271	\$8,456	\$6,087	\$6,876

Multiple Upholstery Specify: Model | Frame Upholstery | Seat & Back Uph | Foot Style | Ganging

PLPM02_M

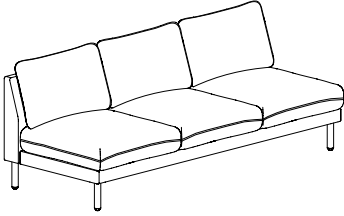
Base Price: \$3,283	To the Base Price, add the appropriate upcharges by grade, per zone													
	COM	COL	A	B	C	D	E	F	G	H	I	J	L1	L2
Frame - Zone 1	+ n/a	+\$215	+ \$34	+ \$100	+\$215	+\$363	+ \$511	+ \$741	+ \$988	+ \$1,251	+ \$1,662	+ \$2,156	+ \$1,169	+ \$1,498
Seat & Back - Zone 2	+ n/a	+\$315	+ \$49	+\$146	+\$315	+\$532	+ \$749	+ \$1,086	+ \$1,448	+ \$1,834	+ \$2,438	+ \$3,162	+ \$1,714	+ \$2,196

Model	Upholstery	Foot Style	Ganging
PL32 POET	Grade Vendor Pattern Colorway	WF Wood Foot See Poet Wood Foot Finishes MF Metal Foot See Poet Metal Foot Finishes see foot finish style for pricing	NGB No Ganging Brackets YGV Ganging Bracket - add \$50

Description + General Information

Three Seat - Armless

- undermount power center available - order EC30 separately



Dimensions	D	W	H	Shipping	
Overall	33	81 ½	32	Ctn Wt	146
Seat	22	81 ½	17 ½	Cu Ft	44

	Single Upholstery	Frame Zone 1	Seat & Back Zone 2
COM Ydg	13 ½	5 ½	8 ¼
COL Sq Ft	270	110	160

Single Upholstery Specify: Model | Upholstery | Foot Style | Ganging

PLPM03														
	COM	COL	A	B	C	D	E	F	G	H	I	J	L1	L2
Single Uph	\$4,506	\$5,277	\$4,625	\$4,862	\$5,277	\$5,810	\$6,343	\$7,172	\$8,060	\$9,008	\$10,488	\$12,265	\$8,712	\$9,896

Multiple Upholstery Specify: Model | Frame Upholstery | Seat & Back Uph | Foot Style | Ganging

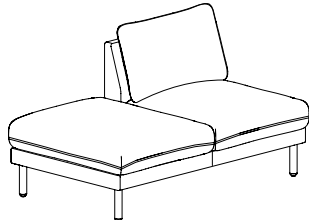
PLPM03_M														
Base Price: \$4,506	To the Base Price, add the appropriate upcharges by grade, per zone													
	COM	COL	A	B	C	D	E	F	G	H	I	J	L1	L2
Frame - Zone 1	+ n/a	+\$315	+\$49	+\$146	+\$315	+\$532	+\$749	+\$1,087	+\$1,448	+\$1,835	+\$2,438	+\$3,162	+\$1,714	+\$2,196
Seat & Back - Zone 2	+ n/a	+\$472	+\$73	+\$218	+\$472	+\$797	+\$1,123	+\$1,630	+\$2,172	+\$2,752	+\$3,656	+\$4,742	+\$2,571	+\$3,294

Model	Upholstery	Foot Style	Ganging
	Grade Vendor Pattern Colorway	WF Wood Foot See Poet Wood Foot Finishes MF Metal Foot See Poet Metal Foot Finishes see foot finish style for pricing	NGB No Ganging Brackets YGV Ganging Bracket - add \$50

Description + General Information

Two Seat Peninsula - Armless

- undermount power center available - order EC30 separately



left shown

Dimensions	D	W	H	Shipping	
Overall	34	54 ¼	32	Ctn Wt	97
Seat	22 & 34	54 ¼	17 ½	Cu Ft	31

	Single Upholstery	Frame Zone 1	Seat & Back Zone 2
COM Ydg	7 ¼	2 ½	5
COL Sq Ft	145	45	100

Single Upholstery Specify: Model | Upholstery | Foot Style | Ganging

PLPMP02B-R PLPMP02B-L														
	COM	COL	A	B	C	D	E	F	G	H	I	J	L1	L2
Single Uph	\$2,927	\$3,341	\$2,991	\$3,118	\$3,341	\$3,627	\$3,914	\$4,359	\$4,836	\$5,345	\$6,140	\$7,094	\$5,186	\$5,822

Multiple Upholstery Specify: Model | Frame Upholstery | Seat & Back Uph | Foot Style | Ganging

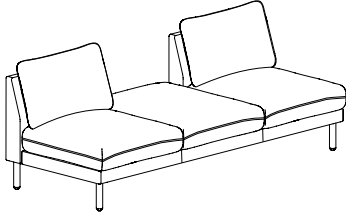
PLPMP02B-R_M PLPMP02B-L_M														
Base Price: \$2,927	To the Base Price, add the appropriate upcharges by grade, per zone													
	COM	COL	A	B	C	D	E	F	G	H	I	J	L1	L2
Frame - Zone 1	+ n/a	+\$143	+\$23	+\$66	+\$143	+\$242	+\$341	+\$494	+\$659	+\$834	+\$1,108	+\$1,437	+\$779	+\$999
Seat & Back - Zone 2	+ n/a	+\$286	+\$45	+\$132	+\$286	+\$483	+\$681	+\$988	+\$1,317	+\$1,668	+\$2,216	+\$2,874	+\$1,558	+\$1,997

Model	Upholstery	Foot Style	Ganging
	Grade Vendor Pattern Colorway	WF Wood Foot See Poet Wood Foot Finishes MF Metal Foot See Poet Metal Foot Finishes see foot finish style for pricing	NGB No Ganging Brackets YGV Ganging Bracket - add \$50

Description + General Information

Two Seat with Center Bench - Armless

- undermount power center available - order EC30 separately



Dimensions	D	W	H	Shipping	
Overall	34	81 ½	32	Ctn Wt	142
Seat	22 & 34	81 ½	17 ½	Cu Ft	46

	Single Upholstery	Frame Zone 1	Seat & Back Zone 2
COM Ydg	11 ½	4 ½	7 ¼
COL Sq Ft	230	85	145

Single Upholstery Specify: Model | Upholstery | Foot Style | Ganging

PLPMP03B														
	COM	COL	A	B	C	D	E	F	G	H	I	J	L1	L2
Single Uph	\$4,274	\$4,930	\$4,375	\$4,577	\$4,930	\$5,384	\$5,838	\$6,545	\$7,301	\$8,108	\$9,370	\$10,883	\$7,856	\$8,865

Multiple Upholstery Specify: Model | Frame Upholstery | Seat & Back Uph | Foot Style | Ganging

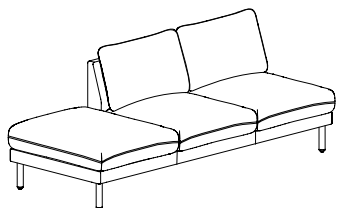
PLPMP03B_M														
Base Price: \$4,274	To the Base Price, add the appropriate upcharges by grade, per zone													
	COM	COL	A	B	C	D	E	F	G	H	I	J	L1	L2
Frame - Zone 1	+ n/a	+\$257	+ \$40	+ \$119	+\$257	+\$435	+ \$612	+ \$889	+ \$1,185	+ \$1,501	+ \$1,995	+ \$2,587	+ \$1,402	+ \$1,797
Seat & Back - Zone 2	+ n/a	+\$414	+ \$64	+\$192	+\$414	+\$700	+ \$986	+ \$1,432	+ \$1,909	+ \$2,418	+ \$3,213	+ \$4,167	+ \$2,259	+ \$2,895

Model	Upholstery	Foot Style	Ganging
	Grade Vendor Pattern Colorway	WF Wood Foot See Poet Wood Foot Finishes MF Metal Foot See Poet Metal Foot Finishes see foot finish style for pricing	NGB No Ganging Brackets YGV Ganging Bracket - add \$50

Description + General Information

Two Seat with Bench - Armless

- undermount power center available - order EC30 separately



left shown

Dimensions	D	W	H	Shipping	
Overall	34	81 ½	32	Ctn Wt	142
Seat	22 & 34	81 ½	17 ½	Cu Ft	46

	Single Upholstery	Frame Zone 1	Seat & Back Zone 2
COM Ydg	11 ½	4 ½	7 ¼
COL Sq Ft	230	85	145

Single Upholstery Specify: Model | Upholstery | Foot Style | Ganging

PLPMP03B-R PLPMP03B-L														
	COM	COL	A	B	C	D	E	F	G	H	I	J	L1	L2
Single Uph	\$4,303	\$4,959	\$4,404	\$4,606	\$4,959	\$5,413	\$5,867	\$6,573	\$7,330	\$8,137	\$9,398	\$10,912	\$7,885	\$8,894

Multiple Upholstery Specify: Model | Frame Upholstery | Seat & Back Uph | Foot Style | Ganging

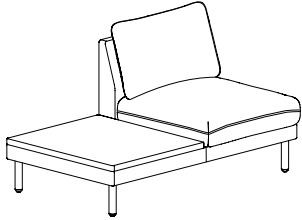
PLPMP03B-R_M PLPMP03B-L_M														
Base Price: \$4,303	To the Base Price, add the appropriate upcharges by grade, per zone													
	COM	COL	A	B	C	D	E	F	G	H	I	J	L1	L2
Frame - Zone 1	+ n/a	+\$257	+\$40	+\$119	+\$257	+\$435	+\$612	+\$889	+\$1,185	+\$1,501	+\$1,994	+\$2,587	+\$1,402	+\$1,797
Seat & Back - Zone 2	+ n/a	+\$414	+\$64	+\$192	+\$414	+\$700	+\$986	+\$1,432	+\$1,909	+\$2,418	+\$3,213	+\$4,167	+\$2,259	+\$2,895

Model	Upholstery	Foot Style	Ganging
PL36 POET	Grade Vendor Pattern Colorway	WF Wood Foot See Poet Wood Foot Finishes MF Metal Foot See Poet Metal Foot Finishes see foot finish style for pricing	NGB No Ganging Brackets YGV Ganging Bracket - add \$50

Description + General Information

Single Seat with Table - Armless

- undermount power center available - order EC30 separately



left shown

Dimensions	D	W	H	Shipping	
Overall	33	54 ¼	32	Ctn Wt	97
Seat	22	27	17 ½	Cu Ft	30

	Single Upholstery	Frame Zone 1	Seat & Back Zone 2
COM Ydg	5	2 ½	2 ¾
COL Sq Ft	100	45	55

Single Upholstery Specify: Model | Single Uph | Top Surface | Foot Style | Power | Ganging

PLPMP01T-R
PLPMP01T-L

	COM	COL	A	B	C	D	E	F	G	H	I	J	L1	L2
Single Uph/Lam	\$2,405	\$2,691	\$2,449	\$2,537	\$2,691	\$2,888	\$3,086	\$3,393	\$3,722	\$4,073	\$4,621	\$5,279	\$3,963	\$4,402
Single Uph/Flat Cut	\$2,738	\$3,024	\$2,782	\$2,870	\$3,024	\$3,221	\$3,419	\$3,726	\$4,055	\$4,406	\$4,954	\$5,612	\$4,296	\$4,735
Single Uph/Dble Cut	\$2,764	\$3,050	\$2,808	\$2,896	\$3,050	\$3,247	\$3,445	\$3,752	\$4,081	\$4,432	\$4,980	\$5,638	\$4,322	\$4,761
Single Uph/Solid Surf	\$4,202	\$4,488	\$4,246	\$4,334	\$4,488	\$4,685	\$4,883	\$5,190	\$5,519	\$5,870	\$6,418	\$7,076	\$5,760	\$6,199

Multiple Upholstery Specify: Model | Frame Uph | Seat & Back Uph | Top Surface | Foot Style | Power | Ganging

PLPMP01T-R_M
PLPMP01T-L_M

Base Price Laminate: \$2,405

Base Price Flat Cut: \$2,738

Base Price Solid Surface: \$4,202

Base Price Double Cut: \$2,764

To the Base Price, add the appropriate upcharges by grade, per zone

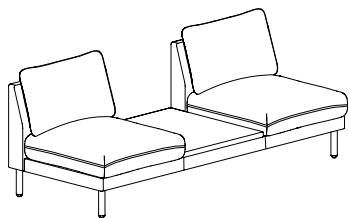
	COM	COL	A	B	C	D	E	F	G	H	I	J	L1	L2
Frame - Zone 1	+n/a	+\$143	+\$22	+\$66	+\$143	+\$242	+\$341	+\$494	+\$659	+\$834	+\$1,108	+\$1,437	+\$779	+\$999
Seat & Back - Zone 2	+n/a	+\$158	+\$25	+\$73	+\$158	+\$266	+\$375	+\$544	+\$725	+\$918	+\$1,219	+\$1,581	+\$857	+\$1,099

Model	Upholstery	Top Surface	Foot Style	Power	Ganging
	Grade Vendor Pattern Colorway	T Laminate See Poet Laminate Finishes V Veneer See Poet Veneer Finishes S Solid Surface See Poet Solid Surface Finishes see top surface for pricing	WF Wood Foot See Poet Wood Foot Finishes MF Metal Foot See Poet Metal Foot Finishes see foot finish style for pricing	NSP No Surface Power YSP Surface Power (EC31) - add \$420 B Black Power Unit B Black Cord G Graphite Cord - add \$187 W White Power Unit G Graphite Cord - add \$187	NGB No Ganging Brackets YGV Ganging Bracket - add \$50

Description + General Information

Two Seat with Center Table - Armless

- undermount power center available - order EC30 separately



Dimensions	D	W	H	Shipping	
Overall	33	81 ½	32	Ctn Wt	142
Seat	22	27 ea	17 ½	Cu Ft	44

	Single Upholstery	Frame Zone 1	Seat & Back Zone 2
COM Ydg	9 ½	4 ¼	5 ½
COL Sq Ft	190	85	110

Single Upholstery Specify: Model | Single Uph | Top Surface | Foot Style | Power | Ganging

PLPMP02T														
	COM	COL	A	B	C	D	E	F	G	H	I	J	L1	L2
Single Uph/Lam	\$3,842	\$4,384	\$3,926	\$4,092	\$4,384	\$4,759	\$5,134	\$5,717	\$6,343	\$7,009	\$8,051	\$9,301	\$6,801	\$7,634
Single Uph/Flat Cut	\$4,175	\$4,717	\$4,259	\$4,425	\$4,717	\$5,092	\$5,467	\$6,050	\$6,676	\$7,342	\$8,384	\$9,634	\$7,134	\$7,967
Single Uph/Dble Cut	\$4,201	\$4,743	\$4,285	\$4,451	\$4,743	\$5,118	\$5,493	\$6,076	\$6,702	\$7,368	\$8,410	\$9,660	\$7,160	\$7,993
Single Uph/Solid Surf	\$5,639	\$6,181	\$5,723	\$5,889	\$6,181	\$6,556	\$6,931	\$7,514	\$8,140	\$8,806	\$9,848	\$11,098	\$8,598	\$9,431

Multiple Upholstery Specify: Model | Frame Uph | Seat & Back Uph | Top Surface | Foot Style | Power | Ganging

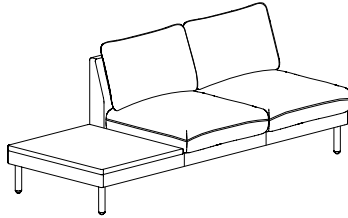
PLPMP02T_M	Base Price Laminate: \$3,842							Base Price Flat Cut: \$4,175						
	Base Price Solid Surface: \$5,639							Base Price Double Cut: \$4,201						
To the Base Price, add the appropriate upcharges by grade, per zone														
	COM	COL	A	B	C	D	E	F	G	H	I	J	L1	L2
Frame - Zone 1	+n/a	+\$243	+\$38	+\$112	+\$243	+\$411	+\$578	+\$839	+\$1,119	+\$1,417	+\$1,883	+\$2,443	+\$1,324	+\$1,697
Seat & Back - Zone 2	+n/a	+\$314	+\$49	+\$145	+\$314	+\$531	+\$748	+\$1,086	+\$1,448	+\$1,834	+\$2,437	+\$3,161	+\$1,714	+\$2,196

Model	Upholstery	Top Surface	Foot Style	Power	Ganging
	Grade Vendor Pattern Colorway	T Laminate See Poet Laminate Finishes V Veneer See Poet Veneer Finishes S Solid Surface See Poet Solid Surface Finishes see top surface for pricing	WF Wood Foot See Poet Wood Foot Finishes MF Metal Foot See Poet Metal Foot Finishes see foot finish style for pricing	NSP No Surface Power YSP Surface Power (EC31) - add \$420 B Black Power Unit B Black Cord G Graphite Cord - add \$187 W White Power Unit G Graphite Cord - add \$187	NGB No Ganging Brackets YGV Ganging Bracket - add \$50

Description + General Information

Two Seat with Table - Armless

- undermount power center available - order EC30 separately



left shown

Dimensions	D	W	H	Shipping	
Overall	33	81 ½	32	Ctn Wt	142
Seat	22	54 ¼	17 ½	Cu Ft	44

	Single Upholstery	Frame Zone 1	Seat & Back Zone 2
COM Ydg	9 ½	4 ¼	5 ½
COL Sq Ft	190	85	110

Single Upholstery Specify: Model | Single Uph | Top Surface | Foot Style | Power | Ganging

PLPMP02T-R
PLPMP02T-L

	COM	COL	A	B	C	D	E	F	G	H	I	J	L1	L2
Single Uph/Lam	\$3,664	\$4,206	\$3,748	\$3,915	\$4,206	\$4,582	\$4,957	\$5,540	\$6,165	\$6,832	\$7,874	\$9,124	\$6,624	\$7,457
Single Uph/Flat Cut	\$3,997	\$4,539	\$4,081	\$4,248	\$4,539	\$4,915	\$5,290	\$5,873	\$6,498	\$7,165	\$8,207	\$9,457	\$6,957	\$7,790
Single Uph/Dble Cut	\$4,023	\$4,565	\$4,107	\$4,274	\$4,565	\$4,941	\$5,316	\$5,899	\$6,524	\$7,191	\$8,233	\$9,483	\$6,983	\$7,816
Single Uph/Solid Surf	\$5,461	\$6,003	\$5,545	\$5,712	\$6,003	\$6,379	\$6,754	\$7,337	\$7,962	\$8,629	\$9,671	\$10,921	\$8,421	\$9,254

Multiple Upholstery Specify: Model | Frame Uph | Seat & Back Uph | Top Surface | Foot Style | Power | Ganging

PLPMP02T-R_M
PLPMP02T-L_M

Base Price Laminate: \$3,664

Base Price Flat Cut: \$3,997

Base Price Solid Surface: \$5,461

Base Price Double Cut: \$4,023

To the Base Price, add the appropriate upcharges by grade, per zone

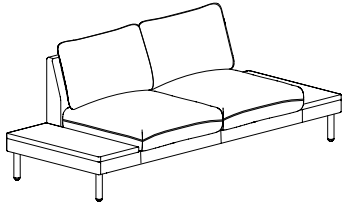
	COM	COL	A	B	C	D	E	F	G	H	I	J	L1	L2
Frame - Zone 1	+n/a	+ \$243	+ \$38	+ \$113	+ \$243	+ \$411	+ \$579	+ \$840	+ \$1,119	+ \$1,418	+ \$1,884	+ \$2,443	+ \$1,325	+ \$1,697
Seat & Back - Zone 2	+n/a	+ \$314	+ \$49	+ \$146	+ \$314	+ \$532	+ \$749	+ \$1,087	+ \$1,448	+ \$1,835	+ \$2,438	+ \$3,162	+ \$1,714	+ \$2,196

Model	Upholstery	Top Surface	Foot Style	Power	Ganging
	Grade Vendor Pattern Colorway	T Laminate See Poet Laminate Finishes V Veneer See Poet Veneer Finishes S Solid Surface See Poet Solid Surface Finishes see top surface for pricing	WF Wood Foot See Poet Wood Foot Finishes MF Metal Foot See Poet Metal Foot Finishes see foot finish style for pricing	NSP No Surface Power YSP Surface Power (EC31) - add \$420 B Black Power Unit B Black Cord G Graphite Cord - add \$187 W White Power Unit G Graphite Cord - add \$187	NGB No Ganging Brackets YGV Ganging Bracket - add \$50

Description + General Information

Two Seat with Two Tables - Armless

- undermount power center available - order EC30 separately



Dimensions	D	W	H	Shipping	
Overall	33	81 ½	32	Ctn Wt	142
Seat	22	27 ea	17 ½	Cu Ft	44

	Single Upholstery	Frame Zone 1	Seat & Back Zone 2
COM Ydg	9 ½	4 ¼	5 ½
COL Sq Ft	190	85	110

Single Upholstery Specify: Model | Single Uph | Top Surface | Foot Style | Power | Ganging

PLPM02T-D														
	COM	COL	A	B	C	D	E	F	G	H	I	J	L1	L2
Single Uph/Lam	\$3,721	\$4,263	\$3,805	\$3,972	\$4,263	\$4,638	\$5,013	\$5,597	\$6,222	\$6,889	\$7,931	\$9,181	\$6,680	\$7,514
Single Uph/Flat Cut	\$4,117	\$4,659	\$4,201	\$4,368	\$4,659	\$5,034	\$5,409	\$5,993	\$6,618	\$7,285	\$8,327	\$9,577	\$7,076	\$7,910
Single Uph/Dbble Cut	\$4,145	\$4,687	\$4,229	\$4,396	\$4,687	\$5,062	\$5,437	\$6,021	\$6,646	\$7,313	\$8,355	\$9,605	\$7,104	\$7,938
Single Uph/Solid Surf	\$5,847	\$6,389	\$5,931	\$6,098	\$6,389	\$6,764	\$7,139	\$7,723	\$8,348	\$9,015	\$10,057	\$11,307	\$8,806	\$9,640

Multiple Upholstery Specify: Model | Frame Uph | Seat & Back Uph | Top Surface | Foot Style | Power | Ganging

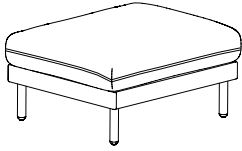
PLPM02T-D_M		Base Price Laminate: \$3,721					Base Price Flat Cut: \$4,117							
		Base Price Solid Surface: \$5,847					Base Price Double Cut: \$4,145							
To the Base Price, add the appropriate upcharges by grade, per zone														
	COM	COL	A	B	C	D	E	F	G	H	I	J	L1	L2
Frame - Zone 1	+n/a	+\$243	+\$38	+\$113	+\$243	+\$411	+\$578	+\$840	+\$1,119	+\$1,418	+\$1,884	+\$2,443	+\$1,324	+\$1,697
Seat & Back - Zone 2	+n/a	+\$314	+\$49	+\$146	+\$314	+\$531	+\$748	+\$1,087	+\$1,448	+\$1,835	+\$2,438	+\$3,162	+\$1,714	+\$2,196

Model	Upholstery	Top Surface	Foot Style	Power	Ganging
	Grade Vendor Pattern Colorway	T Laminate See Poet Laminate Finishes V Veneer See Poet Veneer Finishes S Solid Surface See Poet Solid Surface Finishes see top surface for pricing	WF Wood Foot See Poet Wood Foot Finishes MF Metal Foot See Poet Metal Foot Finishes see foot finish style for pricing	NSP No Surface Power YSP Surface Power (EC31) - add \$420 B Black Power Unit B Black Cord G Graphite Cord - add \$187 W White Power Unit G Graphite Cord - add \$187	NGB No Ganging Brackets YGV Ganging Bracket - add \$50

Description + General Information

Modular Single Seat Bench

- undermount power center available - order EC30 separately



Dimensions	D	W	H	Shipping	
Overall	34	27	17 ½	Ctn Wt	50
Seat	34	27	17 ½	Cu Ft	8

	Single Upholstery	Frame Zone 1	Seat Zone 2
COM Ydg	2 ¾	¾	2
COL Sq Ft	50	15	40

Single Upholstery Specify: Model | Upholstery | Foot Style | Ganging

PLPMB01														
	COM	COL	A	B	C	D	E	F	G	H	I	J	L1	L2
Single Uph	\$1,450	\$1,607	\$1,474	\$1,523	\$1,607	\$1,716	\$1,824	\$1,993	\$2,174	\$2,367	\$2,669	\$3,031	\$2,307	\$2,548

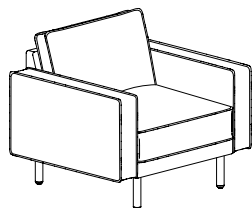
Multiple Upholstery Specify: Model | Frame Upholstery | Seat & Back Uph | Foot Style | Ganging

PLPMB01_M														
Base Price: \$1,450	To the Base Price, add the appropriate upcharges by grade, per zone													
	COM	COL	A	B	C	D	E	F	G	H	I	J	L1	L2
Frame - Zone 1	+ n/a	+\$43	+ \$7	+ \$20	+\$43	+\$73	+\$102	+\$149	+\$198	+\$251	+\$333	+\$432	+\$234	+\$300
Seat - Zone 2	+ n/a	+\$115	+ \$18	+\$54	+\$115	+\$194	+\$272	+\$395	+\$527	+\$667	+\$887	+\$1,150	+\$624	+\$799

Model	Upholstery	Foot Style	Ganging
	Grade Vendor Pattern Colorway	WF Wood Foot See Poet Wood Foot Finishes MF Metal Foot See Poet Metal Foot Finishes see foot finish style for pricing	NGB No Ganging Brackets YGV Ganging Bracket - add \$50

Description + General Information

Single Seat



- arm pocket available - upholstery same as arm and requires additional yardage, see upcharges below per arm
- undermount power center available - order EC30 separately

Dimensions	D	W	H	Shipping	
Overall	32	37 ½	32	Ctn Wt	82
Seat	21	26 ½	17 ½	Cu Ft	21
Arm			24 ¾		

	Single Upholstery	Frame Zone 1	Seat & Back Zone 2	Arm Zone 3	Pocket (per arm)
COM Ydg	7 ½	2	3	2 ¾	1
COL Sq Ft	150	40	60	55	18

Single Upholstery Specify: Model | Upholstery | Pocket | Foot Style

PLCF21														
	COM	COL	A	B	C	D	E	F	G	H	I	J	L1	L2
Single Uph	\$2,798	\$3,226	\$2,864	\$2,995	\$3,226	\$3,522	\$3,818	\$4,278	\$4,772	\$5,298	\$6,121	\$7,108	\$5,134	\$5,792

Multiple Upholstery Specify: Model | Frame Upholstery | Seat & Back Uph | Arm Uph | Pocket | Foot Style

PLCF21_M														
Base Price: \$2,798	To the Base Price, add the appropriate upcharges by grade, per zone													
	COM	COL	A	B	C	D	E	F	G	H	I	J	L1	L2
Frame - Zone 1	+ n/a	+\$115	+\$18	+\$53	+\$115	+\$194	+\$272	+\$395	+\$527	+\$667	+\$887	+\$1,150	+\$623	+\$799
Seat & Back - Zone 2	+ n/a	+\$172	+\$27	+\$79	+\$172	+\$290	+\$408	+\$592	+\$790	+\$1,000	+\$1,330	+\$1,724	+\$935	+\$1,198
Arm - Zone 3	+ n/a	+\$157	+\$25	+\$73	+\$157	+\$266	+\$374	+\$543	+\$724	+\$917	+\$1,219	+\$1,581	+\$857	+\$1,098

Optional Arm Pocket Available on both Single and Multiple Upholstery Units with Arm Pocket Upholstery matching the Arm.

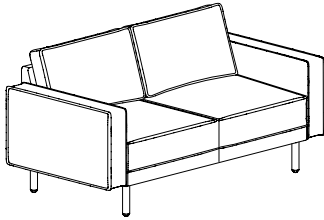
Pocket Upcharge Pricing below represents upcharge for single arm pocket. For pockets on both arms, double the price.														
	COM	COL	A	B	C	D	E	F	G	H	I	J	L1	L2
No Leather Accent	\$131	\$188	\$140	\$158	\$188	\$228	\$267	\$329	\$395	\$465	\$574	\$706	\$443	\$531
With Leather Accent	\$174	\$231	\$183	\$200	\$231	\$271	\$310	\$371	\$437	\$507	\$617	\$749	\$485	\$573

Model	Upholstery	Pocket	Foot Style
PL42 POET	Grade	NP No Pocket LP Left Pocket LPX Right Pocket - No Accent LPAR Left Pocket with Brown Accent LPAK Left Pocket with Black Accent RP Right Pocket RPX Right Pocket - No Accent RPAR Right Pocket with Brown Accent RPAK Right Pocket with Black Accent BP Both Left & Right Pockets BPX Both Pockets - No Accent BPAR Both Pockets with Brown Accent BPAK Both Pockets with Black Accent	WF Wood Foot See Poet Wood Foot Finishes MF Metal Foot See Poet Metal Foot Finishes see foot finish style for pricing
	Vendor		
	Pattern		
	Colorway		

see pocket for pricing

Description + General Information

Two Seat



- arm pocket available - upholstery same as arm and requires additional yardage, see upcharges below per arm
- undermount power center available - order EC30 separately

Dimensions	D	W	H	Shipping	
Overall	32	64 ¾	32	Ctn Wt	129
Seat	21	53 ½	17 ½	Cu Ft	35
Arm			24 ¾		

	Single Upholstery	Frame Zone 1	Seat & Back Zone 2	Arm Zone 3	Pocket (per arm)
COM Ydg	11 ¾	3 ¾	5 ¾	2 ¾	1
COL Sq Ft	235	75	115	55	18

Single Upholstery Specify: Model | Upholstery | Pocket | Foot Style

PLCF22														
	COM	COL	A	B	C	D	E	F	G	H	I	J	L1	L2
Single Uph	\$3,917	\$4,587	\$4,020	\$4,226	\$4,587	\$5,051	\$5,515	\$6,237	\$7,010	\$7,834	\$9,123	\$10,669	\$7,577	\$8,607

Multiple Upholstery Specify: Model | Frame Upholstery | Seat & Back Uph | Arm Uph | Pocket | Foot Style

PLCF22_M														
Base Price:	To the Base Price, add the appropriate upcharges by grade, per zone													
	COM	COL	A	B	C	D	E	F	G	H	I	J	L1	L2
Frame - Zone 1	+ n/a	+\$214	+ \$33	+ \$99	+\$214	+\$362	+ \$510	+ \$741	+ \$988	+ \$1,251	+ \$1,662	+ \$2,155	+ \$1,169	+ \$1,497
Seat & Back - Zone 2	+ n/a	+\$328	+ \$51	+\$152	+\$328	+\$555	+ \$782	+ \$1,136	+ \$1,514	+ \$1,917	+ \$2,548	+ \$3,305	+ \$1,792	+ \$2,296
Arm - Zone 3	+ n/a	+\$157	+ \$25	+\$73	+\$157	+\$266	+ \$374	+ \$543	+ \$724	+ \$917	+ \$1,219	+ \$1,581	+ \$857	+ \$1,098

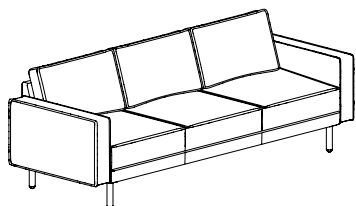
Optional Arm Pocket Available on both Single and Multiple Upholstery Units with Arm Pocket Upholstery matching the Arm.

Pocket Upcharge														
Pricing below represents upcharge for single arm pocket. For pockets on both arms, double the price.														
	COM	COL	A	B	C	D	E	F	G	H	I	J	L1	L2
No Leather Accent	\$131	\$188	\$140	\$158	\$188	\$228	\$267	\$329	\$395	\$465	\$574	\$706	\$443	\$531
With Leather Accent	\$174	\$231	\$183	\$200	\$231	\$271	\$310	\$371	\$437	\$507	\$617	\$749	\$485	\$573

Model	Upholstery	Pocket	Foot Style
	Grade Vendor Pattern Colorway	NP No Pocket LP Left Pocket LPX Right Pocket - No Accent LPAR Left Pocket with Brown Accent LPAK Left Pocket with Black Accent RP Right Pocket RPX Right Pocket - No Accent RPAR Right Pocket with Brown Accent RPAK Right Pocket with Black Accent BP Both Left & Right Pockets BPX Both Pockets - No Accent BPAR Both Pockets with Brown Accent BPAK Both Pockets with Black Accent see pocket for pricing	WF Wood Foot See Poet Wood Foot Finishes MF Metal Foot See Poet Metal Foot Finishes see foot finish style for pricing

Description + General Information

Three Seat



- arm pocket available - upholstery same as arm and requires additional yardage, see upcharges below per arm
- undermount power center available - order EC30 separately

Dimensions	D	W	H	Shipping	
Overall	32	92	32	Ctn Wt	174
Seat	21	80 ½	17 ½	Cu Ft	49
Arm			24 ¾		

	Single Upholstery	Frame Zone 1	Seat & Back Zone 2	Arm Zone 3	Pocket (per arm)
COM Ydg	17	5 ½	9	2 ¾	1
COL Sq Ft	340	105	180	60	18

Single Upholstery Specify: Model | Upholstery | Pocket | Foot Style

PLCF23														
	COM	COL	A	B	C	D	E	F	G	H	I	J	L1	L2
Single Uph	\$5,165	\$6,135	\$5,314	\$5,613	\$6,135	\$6,806	\$7,477	\$8,521	\$9,640	\$10,833	\$12,697	\$14,934	\$10,460	\$11,952

Multiple Upholstery Specify: Model | Frame Upholstery | Seat & Back Uph | Arm Uph | Pocket | Foot Style

PLCF23_M														
Base Price: \$5,165	To the Base Price, add the appropriate upcharges by grade, per zone													
	COM	COL	A	B	C	D	E	F	G	H	I	J	L1	L2
Frame - Zone 1	+ n/a	+\$314	+\$49	+\$145	+\$314	+\$531	+\$748	+\$1,086	+\$1,448	+\$1,834	+\$2,437	+\$3,161	+\$1,714	+\$2,196
Seat & Back - Zone 2	+ n/a	+\$514	+\$79	+\$238	+\$514	+\$869	+\$1,224	+\$1,777	+\$2,370	+\$3,001	+\$3,988	+\$5,172	+\$2,804	+\$3,594
Arm - Zone 3	+ n/a	+\$157	+\$25	+\$73	+\$157	+\$266	+\$374	+\$543	+\$724	+\$917	+\$1,219	+\$1,581	+\$857	+\$1,098

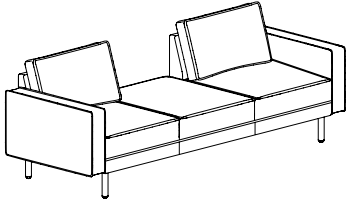
Optional Arm Pocket Available on both Single and Multiple Upholstery Units with Arm Pocket Upholstery matching the Arm.

Pocket Upcharge Pricing below represents upcharge for single arm pocket. For pockets on both arms, double the price.														
	COM	COL	A	B	C	D	E	F	G	H	I	J	L1	L2
No Leather Accent	\$131	\$188	\$140	\$158	\$188	\$228	\$267	\$329	\$395	\$465	\$574	\$706	\$443	\$531
With Leather Accent	\$174	\$231	\$183	\$200	\$231	\$271	\$310	\$371	\$437	\$507	\$617	\$749	\$485	\$573

Model	Upholstery	Pocket	Foot Style
PL44 POET	Grade Vendor Pattern Colorway	NP No Pocket LP Left Pocket LPX Right Pocket - No Accent LPAR Left Pocket with Brown Accent LPAK Left Pocket with Black Accent RP Right Pocket RPX Right Pocket - No Accent RPAR Right Pocket with Brown Accent RPAK Right Pocket with Black Accent BP Both Left & Right Pockets BPX Both Pockets - No Accent BPAR Both Pockets with Brown Accent BPAK Both Pockets with Black Accent see pocket for pricing	WF Wood Foot See Poet Wood Foot Finishes MF Metal Foot See Poet Metal Foot Finishes see foot finish style for pricing

Description + General Information

Three Seat with Center Bench



- arm pocket available - upholstery same as arm and requires additional yardage, see upcharges below per arm
- undermount power center available - order EC30 separately

Dimensions	D	W	H	Shipping	
Overall	33	92	32	Ctn Wt	170
Seat	22 & 34	80 ½	17 ½	Cu Ft	50
Arm			24 ¾		

	Single Upholstery	Frame Zone 1	Seat & Back Zone 2	Arm Zone 3	Pocket (per arm)
COM Ydg	15	4 ¼	8 ¼	2 ¾	1
COL Sq Ft	300	85	165	60	18

Single Upholstery Specify: Model | Upholstery | Pocket | Foot Style

PLCF23B														
	COM	COL	A	B	C	D	E	F	G	H	I	J	L1	L2
Single Uph	\$4,861	\$5,718	\$4,994	\$5,257	\$5,718	\$6,310	\$6,902	\$7,823	\$8,810	\$9,863	\$11,508	\$13,482	\$9,534	\$10,850

Multiple Upholstery Specify: Model | Frame Upholstery | Seat & Back Uph | Arm Uph | Pocket | Foot Style

PLCF23B_M														
Base Price: \$4,861	To the Base Price, add the appropriate upcharges by grade, per zone													
	COM	COL	A	B	C	D	E	F	G	H	I	J	L1	L2
Frame - Zone 1	+ n/a	+\$243	+\$38	+\$113	+\$243	+\$411	+\$579	+\$840	+\$1,119	+\$1,418	+\$1,884	+\$2,443	+\$1,325	+\$1,697
Seat & Back - Zone 2	+ n/a	+\$472	+\$74	+\$218	+\$472	+\$797	+\$1,123	+\$1,630	+\$2,172	+\$2,752	+\$3,656	+\$4,742	+\$2,571	+\$3,294
Arm - Zone 3	+ n/a	+\$158	+\$25	+\$73	+\$158	+\$266	+\$375	+\$544	+\$724	+\$918	+\$1,219	+\$1,581	+\$857	+\$1,098

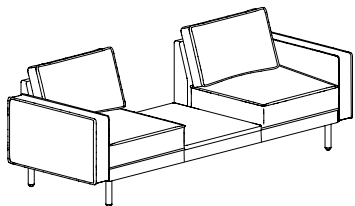
Optional Arm Pocket Available on both Single and Multiple Upholstery Units with Arm Pocket Upholstery matching the Arm.

Pocket Upcharge Pricing below represents upcharge for single arm pocket. For pockets on both arms, double the price.														
	COM	COL	A	B	C	D	E	F	G	H	I	J	L1	L2
No Leather Accent	\$131	\$188	\$140	\$158	\$188	\$228	\$267	\$329	\$395	\$465	\$574	\$706	\$443	\$531
With Leather Accent	\$174	\$231	\$183	\$200	\$231	\$271	\$310	\$371	\$437	\$507	\$617	\$749	\$485	\$573

Model	Upholstery	Pocket	Foot Style
	Grade Vendor Pattern Colorway	NP No Pocket LP Left Pocket LPX Right Pocket - No Accent LPAR Left Pocket with Brown Accent LPAK Left Pocket with Black Accent RP Right Pocket RPX Right Pocket - No Accent RPAR Right Pocket with Brown Accent RPAK Right Pocket with Black Accent BP Both Left & Right Pockets BPX Both Pockets - No Accent BPAR Both Pockets with Brown Accent BPAK Both Pockets with Black Accent see pocket for pricing	WF Wood Foot See Poet Wood Foot Finishes MF Metal Foot See Poet Metal Foot Finishes see foot finish style for pricing

Description + General Information

Two Seat with Center Table



- arm pocket available - upholstery same as arm and requires additional yardage, see upcharges below per arm
- undermount power center available - order EC30 separately

Dimensions	D	W	H	Shipping	
Overall	32	92	32	Ctn Wt	170
Seat	21	26 ½ ea	17 ½	Cu Ft	49
Arm			24 ¾		

	Single Upholstery	Frame Zone 1	Seat & Back Zone 2	Arm Zone 3	Pocket (per arm)
COM Ydg	13	4 ½	6	2 ¾	1
COL Sq Ft	260	85	120	55	18

Single Upholstery Specify: Model | Single Uph | Pocket | Top Surface | Foot Style | Power

PLCF22T														
	COM	COL	A	B	C	D	E	F	G	H	I	J	L1	L2
Single Uph/Lam	\$4,342	\$5,084	\$4,456	\$4,684	\$5,084	\$5,597	\$6,110	\$6,908	\$7,764	\$8,676	\$10,102	\$11,813	\$8,391	\$9,532
Single Uph/Flat Cut	\$4,675	\$5,417	\$4,789	\$5,017	\$5,417	\$5,930	\$6,443	\$7,241	\$8,097	\$9,009	\$10,435	\$12,146	\$8,724	\$9,865
Single Uph/Dbble Cut	\$4,701	\$5,443	\$4,815	\$5,043	\$5,443	\$5,956	\$6,469	\$7,267	\$8,123	\$9,035	\$10,461	\$12,172	\$8,750	\$9,891
Single Uph/Solid Surf	\$6,139	\$6,881	\$6,253	\$6,481	\$6,881	\$7,394	\$7,907	\$8,705	\$9,561	\$10,473	\$11,899	\$13,610	\$10,188	\$11,329

Multiple Upholstery Specify: Model | Frame Upholstery | Seat & Back Uph | Arm Uph | Pocket | Top Surface | Foot Style | Power

PLCF22T_M														
Base Price Laminate: \$4,342					Base Price Flat Cut: \$4,675									
Base Price Solid Surface: \$6,139					Base Price Double Cut: \$4,701									
To the Base Price, add the appropriate upcharges by grade, per zone														
	COM	COL	A	B	C	D	E	F	G	H	I	J	L1	L2
Frame - Zone 1	+n/a	+\$257	+\$40	+\$119	+\$257	+\$435	+\$612	+\$889	+\$1,185	+\$1,501	+\$1,994	+\$2,587	+\$1,402	+\$1,797
Seat & Back - Zone 2	+n/a	+\$343	+\$53	+\$158	+\$343	+\$580	+\$816	+\$1,185	+\$1,580	+\$2,001	+\$2,659	+\$3,449	+\$1,869	+\$2,396
Arm - Zone 3	+n/a	+\$157	+\$25	+\$73	+\$157	+\$266	+\$374	+\$543	+\$724	+\$917	+\$1,219	+\$1,581	+\$857	+\$1,098

Optional Arm Pocket Available on both Single and Multiple Upholstery Units with Arm Pocket Upholstery matching the Arm.

Pocket Upcharge														
Pricing below represents upcharge for single arm pocket. For pockets on both arms, double the price.														
	COM	COL	A	B	C	D	E	F	G	H	I	J	L1	L2
No Leather Accent	\$131	\$188	\$140	\$158	\$188	\$228	\$267	\$329	\$395	\$465	\$574	\$706	\$443	\$531
With Leather Accent	\$174	\$231	\$183	\$200	\$231	\$271	\$310	\$371	\$437	\$507	\$617	\$749	\$485	\$573

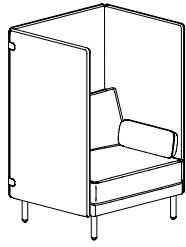
Model	Upholstery	Pocket	Top Surface	Foot Style	Power
	Grade Vendor Pattern Colorway	NP No Pocket LP Left Pocket LFX Right Pocket - No Accent LPAR Left Pocket with Brown Accent LPAK Left Pocket with Black Accent RP Right Pocket RPX Right Pocket - No Accent RPAR Right Pocket with Brown Accent RPAK Right Pocket with Black Accent BP Both Left & Right Pocket BPX Both Pockets - No Accent BPAR Both Pockets with Brown Accent BPAK Both Pockets with Black Accent	T Laminate See Poet Laminate Finishes V Veneer See Poet Veneer Finishes S Solid Surface See Poet Solid Surface Finishes see top surface for pricing	WF Wood Foot See Poet Wood Foot Finishes MF Metal Foot See Poet Metal Foot Finishes see foot finish style for pricing	NSP No Surface Power YSP Surface Power (EC31) - add \$420 B Black Power Unit B Black Cord G Graphite Cord - add \$187 W White Power Unit G Graphite Cord - add \$187

PL46 POET

see pocket for pricing

Description + General Information

Single Seat with Privacy Surround - Bolster



left shown

- leather not available on surround frame
- undermount power center available - order EC30 separately

Dimensions	D	W	H	Shipping	
Overall	33	37 ½	54	Ctn Wt	161
Seat	21	33	17 ½	Cu Ft	26

	Single Upholstery	Frame Zone 1	Seat & Back Zone 2	Bolster Zone 3
COM Ydg	13 ½	8 ¾	4 ¼	¾
COL Sq Ft	100*	158	85	14

*back/ bolster only

Single Upholstery Specify: Model | Upholstery | Strap Accent | Foot Style

PLCFS31-PR PLCFS31-PL

	COM	COL	A	B	C	D	E	F	G	H	I	J	L1	L2
Single Uph	\$5,057	n/a	\$5,176	\$5,413	\$5,828	\$6,361	\$6,893	\$7,723	\$8,611	\$9,558	\$11,039	\$12,815	n/a	n/a

Multiple Upholstery Specify: Model | Frame Upholstery | Seat & Back Uph | Bolster Uph | Strap Accent | Foot Style

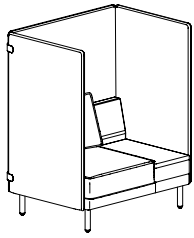
PLCFS31-PR_M PLCFS31-PL_M

Base Price: \$5,057	To the Base Price, add the appropriate upcharges by grade, per zone													
	COM	COL	A	B	C	D	E	F	G	H	I	J	L1	L2
Frame - Zone 1	+ n/a	+n/a	+\$78	+\$231	+\$500	+\$846	+\$1,190	+\$1,728	+\$2,304	+\$2,918	+\$3,878	+\$5,029	+ n/a	+ n/a
Seat & Back - Zone 2	+ n/a	+\$243	+\$38	+\$113	+\$243	+\$411	+\$578	+\$840	+\$1,119	+\$1,417	+\$1,884	+\$2,443	+\$1,324	+\$1,697
Bolster - Zone 3	+ n/a	+\$43	+\$7	+\$20	+\$43	+\$73	+\$102	+\$149	+\$198	+\$251	+\$333	+\$431	+\$234	+\$300

Model	Upholstery	Strap Accent	Foot Style
	Grade Vendor Pattern Colorway	FA Fabric Accent LA Leather Accent - add \$105 BRO Brown BLK Black	WF Wood Foot See Poet Wood Foot Finishes MF Metal Foot See Poet Metal Foot Finishes see foot finish style for pricing

Description + General Information

Single Seat with Privacy Surround - Table



left shown

- leather not available on surround frame
- undermount power center available - order EC30 separately

Dimensions	D	W	H	Shipping	
Overall	33	51 ½	54	Ctn Wt	181
Seat	21	26 ½	17 ½	Cu Ft	31

	Single Upholstery	Frame Zone 1	Seat & Back Zone 2
COM Ydg	13 ¾	9 ¾	4 ½
COL Sq Ft	90*	n/a	90

*seat/back only

Single Upholstery Specify: Model | Upholstery | Strap Accent | Top Surface | Foot Style

PLCFS31-TR PLCFS31-TL

	COM	COL	A	B	C	D	E	F	G	H	I	J	L1	L2
Single Uph/Lam	\$5,371	n/a	\$5,492	\$5,734	\$6,156	\$6,699	\$7,241	\$8,086	\$8,991	\$9,956	\$11,464	\$13,273	n/a	n/a
Single Uph/Flat Cut	\$5,652	n/a	\$5,773	\$6,015	\$6,437	\$6,980	\$7,522	\$8,367	\$9,272	\$10,237	\$11,745	\$13,554	n/a	n/a
Single Uph/Dble Cut	\$5,664	n/a	\$5,785	\$6,027	\$6,449	\$6,992	\$7,534	\$8,379	\$9,284	\$10,249	\$11,757	\$13,566	n/a	n/a
Single Uph/Solid Surf	\$6,345	n/a	\$6,466	\$6,708	\$7,130	\$7,673	\$8,215	\$9,060	\$9,965	\$10,930	\$12,438	\$14,247	n/a	n/a

Multiple Upholstery Specify: Model | Frame Upholstery | Seat & Back Uph | Strap Accent | Top Surface | Foot Style

PLCFS31-TR_M PLCFS31-TL_M

Base Price Laminate: \$5,371

Base Price Flat Cut: \$5,652

Base Price Solid Surface: \$6,345

Base Price Double Cut: \$5,664

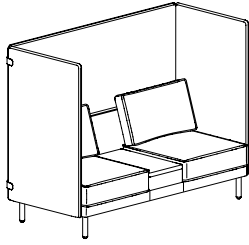
To the Base Price, add the appropriate upcharges by grade, per zone

	COM	COL	A	B	C	D	E	F	G	H	I	J	L1	L2
Frame - Zone 1	+n/a	+ n/a	+ \$86	+ \$258	+ \$557	+ \$942	+ \$1,326	+ \$1,926	+ \$2,567	+ \$3,252	+ \$4,321	+ \$5,604	+ n/a	+ n/a
Seat & Back - Zone 2	+n/a	+ \$257	+ \$40	+ \$119	+ \$257	+ \$435	+ \$612	+ \$889	+ \$1,185	+ \$1,501	+ \$1,995	+ \$2,587	+ \$1,402	+ \$1,797

Model	Upholstery	Strap Accent	Top Surface	Foot Style
	Grade Vendor Pattern Colorway	FA Fabric Accent LA Leather Accent - add \$105 BRO Brown BLK Black	T Laminate See Poet Laminate Finishes V Veneer See Poet Veneer Finishes S Solid Surface See Poet Solid Surface Finishes see top surface for pricing	WF Wood Foot See Poet Wood Foot Finishes MF Metal Foot See Poet Metal Foot Finishes see foot finish style for pricing

Description + General Information

Two Seat with Privacy Surround - Table



- leather not available on surround frame
- undermount power center available - order EC30 separately

Dimensions	D	W	H	Shipping	
Overall	33	78 ½	54	Ctn Wt	206
Seat	21	26 ½	17 ½	Cu Ft	31

	Single Upholstery	Frame Zone 1	Seat & Back Zone 2
COM Ydg	18 ¾	12 ¼	7
COL Sq Ft	140*	n/a	140

*seat/back only

Single Upholstery Specify: Model | Upholstery | Strap Accent | Top Surface | Foot Style | Power

PLCFS32-T														
	COM	COL	A	B	C	D	E	F	G	H	I	J	L1	L2
Single Uph/Lam	\$6,766	n/a	\$6,931	\$7,260	\$7,836	\$8,576	\$9,316	\$10,468	\$11,701	\$13,017	\$15,074	\$17,541	n/a	n/a
Single Uph/Flat Cut	\$7,047	n/a	\$7,212	\$7,541	\$8,117	\$8,857	\$9,597	\$10,749	\$11,982	\$13,298	\$15,355	\$17,822	n/a	n/a
Single Uph/Dble Cut	\$7,059	n/a	\$7,224	\$7,553	\$8,129	\$8,869	\$9,609	\$10,761	\$11,994	\$13,310	\$15,367	\$17,834	n/a	n/a
Single Uph/Solid Surf	\$7,740	n/a	\$7,905	\$8,234	\$8,810	\$9,550	\$10,290	\$11,442	\$12,675	\$13,991	\$16,048	\$18,515	n/a	n/a

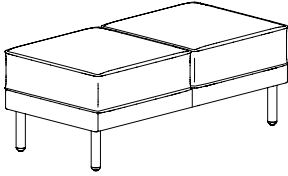
Multiple Upholstery Specify: Model | Frame Uph | Seat & Back Uph | Strap Accent | Top Surface | Foot Style | Power

	Base Price Laminate: \$6,766							Base Price Flat Cut: \$7,047						
	Base Price Solid Surface: \$7,740							Base Price Double Cut: \$7,059						
To the Base Price, add the appropriate upcharges by grade, per zone														
	COM	COL	A	B	C	D	E	F	G	H	I	J	L1	L2
Frame - Zone 1	+n/a	+ n/a	+ \$108	+ \$323	+ \$700	+ \$1,183	+ \$1,666	+ \$2,419	+ \$3,225	+ \$4,084	+ \$5,428	+ \$7,040	+ n/a	+ n/a
Seat & Back - Zone 2	+n/a	+ \$400	+ \$62	+ \$185	+ \$400	+ \$676	+ \$952	+ \$1,383	+ \$1,843	+ \$2,334	+ \$3,102	+ \$4,023	+ \$2,181	+ \$2,795

Model	Upholstery	Strap Accent	Top Surface	Foot Style	Power
	Grade Vendor Pattern Colorway	FA Fabric Accent LA Leather Accent - add \$105 BRO Brown BLK Black	T Laminate See Poet Laminate Finishes V Veneer See Poet Veneer Finishes S Solid Surface See Poet Solid Surface Finishes see top surface for pricing	WF Wood Foot See Poet Wood Foot Finishes MF Metal Foot See Poet Metal Foot Finishes see foot finish style for pricing	NSP No Surface Power YSP Surface Power (EC31) - add \$420 B Black Power Unit B Black Cord G Graphite Cord - add \$187 W White Power Unit G Graphite Cord - add \$187

Description + General Information

Two Seat Bench



- undermount power center available - order EC30 separately

Dimensions	D	W	H	Shipping	
Overall	22 ½	43 ¾	17 ½	Ctn Wt	60
Seat	22 ½	43 ¾	17 ½	Cu Ft	8

	Single Upholstery	Frame Zone 1	Seat Zone 2
COM Ydg	3 ¼	1	2 ½
COL Sq Ft	59	15	50

Single Upholstery Specify: Model | Upholstery | Foot Style

PLCFB02														
	COM	COL	A	B	C	D	E	F	G	H	I	J	L1	L2
Single Uph	\$1,956	\$2,141	\$1,985	\$2,042	\$2,141	\$2,270	\$2,398	\$2,598	\$2,812	\$3,040	\$3,396	\$3,824	\$2,968	\$3,253

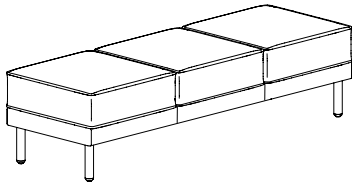
Multiple Upholstery Specify: Model | Frame Upholstery | Seat & Back Uph | Foot Style

PLCFB02_M														
Base Price: \$1,956	To the Base Price, add the appropriate upcharges by grade, per zone													
	COM	COL	A	B	C	D	E	F	G	H	I	J	L1	L2
Frame - Zone 1	+ n/a	+\$57	+\$9	+\$27	+\$57	+\$97	+\$136	+\$198	+\$264	+\$334	+\$444	+\$575	+\$312	+\$400
Seat - Zone 2	+ n/a	+\$143	+\$23	+\$67	+\$143	+\$242	+\$340	+\$494	+\$659	+\$834	+\$1,108	+\$1,437	+\$779	+\$998

Model	Upholstery	Foot Style
PL50 POET	Grade Vendor Pattern Colorway	WF Wood Foot See Poet Wood Foot Finishes MF Metal Foot See Poet Metal Foot Finishes see foot finish style for pricing

Description + General Information

Three Bench Seat



- undermount power center available - order EC30 separately

Dimensions	D	W	H	Shipping	
Overall	22 ½	65 ½	17 ½	Ctn Wt	86
Seat	22 ½	65 ½	17 ½	Cu Ft	12

	Single Upholstery	Frame Zone 1	Seat Zone 2
COM Ydg	5	1	4 ¼
COL Sq Ft	90	20	85

Single Upholstery Specify: Model Upholstery Foot Style

PLCFB03														
	COM	COL	A	B	C	D	E	F	G	H	I	J	L1	L2
Single Uph	\$2,642	\$2,927	\$2,686	\$2,773	\$2,927	\$3,124	\$3,322	\$3,629	\$3,958	\$4,309	\$4,857	\$5,515	\$4,199	\$4,638

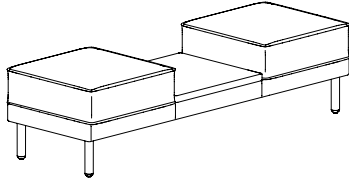
Multiple Upholstery Specify: Model | Frame Upholstery | Seat & Back Uph | Foot Style

PLCFB03_M														
Base Price: \$2,642	To the Base Price, add the appropriate upcharges by grade, per zone													
	COM	COL	A	B	C	D	E	F	G	H	I	J	L1	L2
Frame - Zone 1	+ n/a	+\$57	+\$9	+\$27	+\$57	+\$97	+\$136	+\$198	+\$264	+\$334	+\$443	+\$575	+\$312	+\$400
Seat - Zone 2	+ n/a	+\$243	+\$38	+\$112	+\$243	+\$410	+\$578	+\$839	+\$1,119	+\$1,417	+\$1,883	+\$2,443	+\$1,324	+\$1,697

Model	Upholstery	Foot Style
	Grade Vendor Pattern Colorway	WF Wood Foot See Poet Wood Foot Finishes MF Metal Foot See Poet Metal Foot Finishes see foot finish style for pricing

Description + General Information

Two Seat Bench - Table



- undermount power center available - order EC30 separately

Dimensions	D	W	H	Shipping	
Overall	22 ½	65 ½	17 ½	Ctn Wt	86
Seat	22 ½	22 ea	17 ½	Cu Ft	12

	Single Upholstery	Frame Zone 1	Seat Zone 2
COM Ydg	3 ½	1	2 ¾
COL Sq Ft	63	20	55

Single Upholstery Specify: Model | Single Uph | Top Surface | Foot Style | Power

PLCFB02T														
	COM	COL	A	B	C	D	E	F	G	H	I	J	L1	L2
Single Uph/Lam	\$2,265	\$2,464	\$2,295	\$2,357	\$2,464	\$2,603	\$2,741	\$2,956	\$3,186	\$3,432	\$3,815	\$4,276	\$3,355	\$3,662
Single Uph/Flat Cut	\$2,552	\$2,751	\$2,582	\$2,644	\$2,751	\$2,890	\$3,028	\$3,243	\$3,473	\$3,719	\$4,102	\$4,563	\$3,642	\$3,949
Single Uph/Dble Cut	\$2,567	\$2,766	\$2,597	\$2,659	\$2,766	\$2,905	\$3,043	\$3,258	\$3,488	\$3,734	\$4,117	\$4,578	\$3,657	\$3,964
Single Uph/Solid Surf	\$3,581	\$3,780	\$3,611	\$3,673	\$3,780	\$3,919	\$4,057	\$4,272	\$4,502	\$4,748	\$5,131	\$5,592	\$4,671	\$4,978

Multiple Upholstery Specify: Model | Frame Uph | Seat & Back Uph | Top Surface | Foot Style | Power

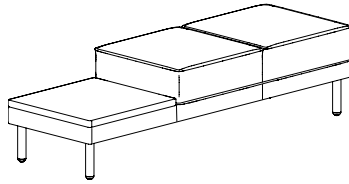
	PLCFB02T_M													
	COM	COL	A	B	C	D	E	F	G	H	I	J	L1	L2
Base Price Laminate: \$2,265 Base Price Flat Cut: \$2,552 Base Price Solid Surface: \$3,581 Base Price Double Cut: \$2,567 To the Base Price, add the appropriate upcharges by grade, per zone														
Frame - Zone 1	+n/a	+\$57	+\$9	+\$27	+\$57	+\$97	+\$136	+\$198	+\$264	+\$334	+\$443	+\$575	+\$312	+\$400
Seat - Zone 2	+n/a	+\$157	+\$24	+\$73	+\$157	+\$266	+\$374	+\$543	+\$724	+\$917	+\$1,218	+\$1,581	+\$857	+\$1,098

Model	Upholstery	Top Surface	Foot Style	Power
	Grade Vendor Pattern Colorway	T Laminate See Poet Laminate Finishes V Veneer See Poet Veneer Finishes S Solid Surface See Poet Solid Surface Finishes see top surface for pricing	WF Wood Foot See Poet Wood Foot Finishes MF Metal Foot See Poet Metal Foot Finishes see foot finish style for pricing	NSP No Surface Power YSP Surface Power (EC31) - add \$420 B Black Power Unit B Black Cord G Graphite Cord - add \$187 W White Power Unit G Graphite Cord - add \$187

Description + General Information

Two Seat Bench - Table

- undermount power center available - order EC30 separately



left shown

Dimensions	D	W	H	Shipping	
Overall	22 ½	65 ½	17 ½	Ctn Wt	86
Seat	22 ½	43 ¾	17 ½	Cu Ft	12

	Single Upholstery	Frame Zone 1	Seat Zone 2
COM Ydg	3 ½	1	2 ¾
COL Sq Ft	63	20	55

Single Upholstery Specify: Model | Single Uph | Top Surface | Foot Style | Power

PLCFB02T-R PLCFB02T-L														
	COM	COL	A	B	C	D	E	F	G	H	I	J	L1	L2
Single Uph/Lam	\$2,265	\$2,464	\$2,295	\$2,357	\$2,464	\$2,603	\$2,741	\$2,956	\$3,186	\$3,432	\$3,815	\$4,276	\$3,355	\$3,662
Single Uph/Flat Cut	\$2,552	\$2,751	\$2,582	\$2,644	\$2,751	\$2,890	\$3,028	\$3,243	\$3,473	\$3,719	\$4,102	\$4,563	\$3,642	\$3,949
Single Uph/Dble Cut	\$2,567	\$2,766	\$2,597	\$2,659	\$2,766	\$2,905	\$3,043	\$3,258	\$3,488	\$3,734	\$4,117	\$4,578	\$3,657	\$3,964
Single Uph/Solid Surf	\$3,581	\$3,780	\$3,611	\$3,673	\$3,780	\$3,919	\$4,057	\$4,272	\$4,502	\$4,748	\$5,131	\$5,592	\$4,671	\$4,978

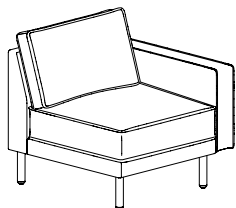
Multiple Upholstery Specify: Model | Frame Uph | Seat & Back Uph | Top Surface | Foot Style | Power

PLCFB02T-R_M Base Price Laminate: \$2,265 Base Price Flat Cut: \$2,552 PLCFB02T-L_M Base Price Solid Surface: \$3,581 Base Price Double Cut: \$2,567 To the Base Price, add the appropriate upcharges by grade, per zone														
	COM	COL	A	B	C	D	E	F	G	H	I	J	L1	L2
Frame - Zone 1	+n/a	+\$57	+\$9	+\$27	+\$57	+\$97	+\$136	+\$198	+\$264	+\$334	+\$443	+\$575	+\$312	+\$400
Seat - Zone 2	+n/a	+\$157	+\$24	+\$73	+\$157	+\$266	+\$374	+\$543	+\$724	+\$917	+\$1,218	+\$1,581	+\$857	+\$1,098

Model	Upholstery	Top Surface	Foot Style	Power
	Grade Vendor Pattern Colorway	T Laminate See Poet Laminate Finishes V Veneer See Poet Veneer Finishes S Solid Surface See Poet Solid Surface Finishes see top surface for pricing	WF Wood Foot See Poet Wood Foot Finishes MF Metal Foot See Poet Metal Foot Finishes see foot finish style for pricing	NSP No Surface Power YSP Surface Power (EC31) - add \$420 B Black Power Unit B Black Cord G Graphite Cord - add \$187 W White Power Unit G Graphite Cord - add \$187

Description + General Information

Single Seat with Arm



left shown

- arm pocket available - upholstery same as arm and requires additional yardage, see upcharges below per arm
- undermount power center available - order EC30 separately

Dimensions	D	W	H	Shipping	
Overall	32	31 ½	32	Ctn Wt	68
Seat	21	26 ½	17 ½	Cu Ft	17
Arm			24 ¾		

	Single Upholstery	Frame Zone 1	Seat & Back Zone 2	Arm Zone 3	Pocket (per arm)
COM Ydg	6 ¼	2	3	1 ¾	1
COL Sq Ft	125	40	60	35	18

Single Upholstery Specify: Model | Upholstery | Pocket | Foot Style | Ganging

PLCM11-R PLCM11-L														
	COM	COL	A	B	C	D	E	F	G	H	I	J	L1	L2
Single Uph	\$2,435	\$2,791	\$2,490	\$2,600	\$2,791	\$3,038	\$3,285	\$3,669	\$4,080	\$4,519	\$5,204	\$6,027	\$4,382	\$4,930

Multiple Upholstery Specify: Model | Frame Upholstery | Seat & Back Uph | Arm Uph | Pocket | Foot Style | Ganging

PLCM11-R_M PLCM11-L_M														
Base Price: \$2,435	To the Base Price, add the appropriate upcharges by grade, per zone													
	COM	COL	A	B	C	D	E	F	G	H	I	J	L1	L2
Frame - Zone 1	+ n/a	+\$114	+\$18	+\$53	+\$114	+\$193	+\$272	+\$395	+\$527	+\$667	+\$887	+\$1,150	+\$624	+\$799
Seat & Back - Zone 2	+ n/a	+\$171	+\$27	+\$80	+\$171	+\$290	+\$408	+\$593	+\$790	+\$1,001	+\$1,330	+\$1,725	+\$935	+\$1,198
Arm - Zone 3	+ n/a	+\$100	+\$16	+\$47	+\$100	+\$169	+\$238	+\$346	+\$461	+\$584	+\$776	+\$1,006	+\$546	+\$699

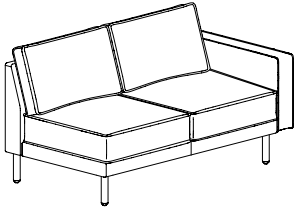
Optional Arm Pocket Available on both Single and Multiple Upholstery Units with Arm Pocket Upholstery matching the Arm.

Pocket Upcharge Pricing below represents upcharge for single arm pocket. For pockets on both arms, double the price.														
	COM	COL	A	B	C	D	E	F	G	H	I	J	L1	L2
No Leather Accent	\$131	\$188	\$140	\$158	\$188	\$228	\$267	\$329	\$395	\$465	\$574	\$706	\$443	\$531
With Leather Accent	\$174	\$231	\$183	\$200	\$231	\$271	\$310	\$371	\$437	\$507	\$617	\$749	\$485	\$573

Model	Upholstery	Pocket	Foot Style	Ganging
PL54 POET	Grade Vendor Pattern Colorway	NP No Pocket RP Right Pocket RPX Right Pocket - No Accent RPAR Right Pocket with Brown Accent RPBK Right Pocket with Black Accent LP Left Pocket LPX Left Pocket - No Accent LPAR Left Pocket with Brown Accent LPBK Left Pocket with Black Accent see pocket for pricing	WF Wood Foot See Poet Wood Foot Finishes MF Metal Foot See Poet Metal Foot Finishes see foot finish style for pricing	NGB No Ganging Brackets YGV Ganging Bracket - add \$50

Description + General Information

Two Seat with Arm



left shown

- arm pocket available - upholstery same as arm and requires additional yardage, see upcharges below per arm
- undermount power center available - order EC30 separately

Dimensions	D	W	H	Shipping	
Overall	32	58 ½	32	Ctn Wt	115
Seat	21	53 ½	17 ½	Cu Ft	31
Arm			24 ¾		

	Single Upholstery	Frame Zone 1	Seat & Back Zone 2	Arm Zone 3	Pocket (per arm)
COM Ydg	11	3 ½	6	1 ¾	1
COL Sq Ft	220	70	120	35	18

Single Upholstery Specify: Model | Upholstery | Pocket | Foot Style | Ganging

PLCM12-R PLCM12-L														
	COM	COL	A	B	C	D	E	F	G	H	I	J	L1	L2
Single Uph	\$3,626	\$4,254	\$3,723	\$3,916	\$4,254	\$4,688	\$5,122	\$5,798	\$6,521	\$7,294	\$8,500	\$9,947	\$7,052	\$8,017

Multiple Upholstery Specify: Model | Frame Upholstery | Seat & Back Uph | Arm Uph | Pocket | Foot Style | Ganging

PLCM12-R_M PLCM12-L_M														
Base Price: \$3,626	To the Base Price, add the appropriate upcharges by grade, per zone													
	COM	COL	A	B	C	D	E	F	G	H	I	J	L1	L2
Frame - Zone 1	+ n/a	+\$200	+ \$31	+ \$93	+\$200	+\$338	+ \$476	+ \$692	+ \$922	+ \$1,168	+ \$1,551	+ \$2,012	+ \$1,091	+ \$1,398
Seat & Back - Zone 2	+ n/a	+\$343	+ \$53	+\$159	+\$343	+\$580	+ \$816	+ \$1,185	+ \$1,580	+ \$2,001	+ \$2,659	+ \$3,448	+ \$1,869	+ \$2,396
Arm - Zone 3	+ n/a	+\$100	+ \$16	+\$47	+\$100	+\$169	+ \$238	+ \$346	+ \$461	+ \$584	+ \$776	+ \$1,006	+ \$546	+ \$699

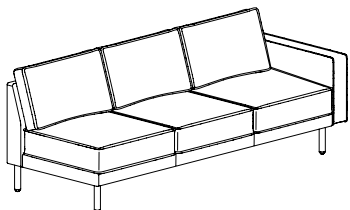
Optional Arm Pocket Available on both Single and Multiple Upholstery Units with Arm Pocket Upholstery matching the Arm.

Pocket Upcharge Pricing below represents upcharge for single arm pocket. For pockets on both arms, double the price.														
	COM	COL	A	B	C	D	E	F	G	H	I	J	L1	L2
No Leather Accent	\$131	\$188	\$140	\$158	\$188	\$228	\$267	\$329	\$395	\$465	\$574	\$706	\$443	\$531
With Leather Accent	\$174	\$231	\$183	\$200	\$231	\$271	\$310	\$371	\$437	\$507	\$617	\$749	\$485	\$573

Model	Upholstery	Pocket	Foot Style	Ganging
	Grade Vendor Pattern Colorway	NP No Pocket RP Right Pocket RPX Right Pocket - No Accent RPAR Right Pocket with Brown Accent RPAK Right Pocket with Black Accent LP Left Pocket LPX Left Pocket - No Accent LPAR Left Pocket with Brown Accent LPAK Left Pocket with Black Accent see pocket for pricing	WF Wood Foot See Poet Wood Foot Finishes MF Metal Foot See Poet Metal Foot Finishes see foot finish style for pricing	NGB No Ganging Brackets YGV Ganging Bracket - add \$50

Description + General Information

Three Seat with Arm



- arm pocket available - upholstery same as arm and requires additional yardage, see upcharges below per arm
- undermount power center available - order EC30 separately

Dimensions	D	W	H	Shipping	
Overall	32	85 ½	32	Ctn Wt	160
Seat	21	80 ½	17 ½	Cu Ft	45
Arm			24 ¾		

	Single Upholstery	Frame Zone 1	Seat & Back Zone 2	Arm Zone 3	Pocket (per arm)
COM Ydg	15 ½	5 ¼	9	1 ¾	1
COL Sq Ft	310	105	180	35	18

Single Upholstery Specify: Model | Upholstery | Pocket | Foot Style | Ganging

PLCM13-R PLCM13-L

	COM	COL	A	B	C	D	E	F	G	H	I	J	L1	L2
Single Uph	\$4,937	\$5,822	\$5,074	\$5,346	\$5,822	\$6,433	\$7,045	\$7,997	\$9,017	\$10,105	\$11,805	\$13,845	\$9,765	\$11,125

Multiple Upholstery Specify: Model | Frame Upholstery | Seat & Back Uph | Arm Uph | Pocket | Foot Style | Ganging

PLCM13-R_M PLCM13-L_M

Base Price: \$4,937	To the Base Price, add the appropriate upcharges by grade, per zone													
	COM	COL	A	B	C	D	E	F	G	H	I	J	L1	L2
Frame - Zone 1	+ n/a	+\$300	+\$47	+\$139	+\$300	+\$507	+\$714	+\$1,037	+\$1,382	+\$1,751	+\$2,327	+\$3,018	+\$1,636	+\$2,096
Seat & Back - Zone 2	+ n/a	+\$514	+\$80	+\$238	+\$514	+\$869	+\$1,224	+\$1,777	+\$2,370	+\$3,001	+\$3,988	+\$5,173	+\$2,804	+\$3,594
Arm - Zone 3	+ n/a	+\$100	+\$16	+\$47	+\$100	+\$169	+\$238	+\$346	+\$461	+\$584	+\$776	+\$1,006	+\$546	+\$699

Optional Arm Pocket Available on both Single and Multiple Upholstery Units with Arm Pocket Upholstery matching the Arm.

Pocket Upcharge

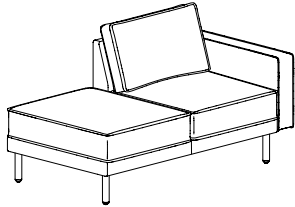
Pricing below represents upcharge for single arm pocket. For pockets on both arms, double the price.

	COM	COL	A	B	C	D	E	F	G	H	I	J	L1	L2
No Leather Accent	\$131	\$188	\$140	\$158	\$188	\$228	\$267	\$329	\$395	\$465	\$574	\$706	\$443	\$531
With Leather Accent	\$174	\$231	\$183	\$200	\$231	\$271	\$310	\$371	\$437	\$507	\$617	\$749	\$485	\$573

Model	Upholstery	Pocket	Foot Style	Ganging
PL56 POET	Grade Vendor Pattern Colorway	NP No Pocket RP Right Pocket RPX Right Pocket - No Accent RPAR Right Pocket with Brown Accent RPBK Right Pocket with Black Accent LP Left Pocket LPX Left Pocket - No Accent LPAR Left Pocket with Brown Accent LPBK Left Pocket with Black Accent see pocket for pricing	WF Wood Foot See Poet Wood Foot Finishes MF Metal Foot See Poet Metal Foot Finishes see foot finish style for pricing	NGB No Ganging Brackets YGV Ganging Bracket - add \$50

Description + General Information

Two Seat with Peninsula Arm



left shown

- arm pocket available - upholstery same as arm and requires additional yardage, see upcharges below per arm
- undermount power center available - order EC30 separately

Dimensions	D	W	H	Shipping	
Overall	33	58 ½	32	Ctn Wt	111
Seat	22 & 34	53 ½	17 ½	Cu Ft	32
Arm			24 ¾		

	Single Upholstery	Frame Zone 1	Seat & Back Zone 2	Arm Zone 3	Pocket (per arm)
COM Ydg	8 ¾	2 ¼	5 ¼	1 ¾	1
COL Sq Ft	175	45	105	35	18

Single Upholstery Specify: Model | Upholstery | Pocket | Foot Style | Ganging

PLCMP12B-R PLCMP12B-L														
	COM	COL	A	B	C	D	E	F	G	H	I	J	L1	L2
Single Uph	\$3,333	\$3,832	\$3,410	\$3,563	\$3,832	\$4,178	\$4,523	\$5,060	\$5,636	\$6,250	\$7,210	\$8,361	\$6,058	\$6,826

Multiple Upholstery Specify: Model | Frame Upholstery | Seat & Back Uph | Arm Uph | Pocket | Foot Style | Ganging

PLCMP12B-R_M PLCMP12B-L_M														
Base Price: \$3,333	To the Base Price, add the appropriate upcharges by grade, per zone													
	COM	COL	A	B	C	D	E	F	G	H	I	J	L1	L2
Frame - Zone 1	+ n/a	+\$129	+\$20	+\$60	+\$129	+\$218	+\$306	+\$445	+\$593	+\$751	+\$997	+\$1,293	+\$701	+\$899
Seat & Back - Zone 2	+ n/a	+\$300	+\$47	+\$138	+\$300	+\$507	+\$714	+\$1,037	+\$1,382	+\$1,751	+\$2,327	+\$3,017	+\$1,635	+\$2,096
Arm - Zone 3	+ n/a	+\$100	+\$16	+\$46	+\$100	+\$169	+\$238	+\$346	+\$461	+\$584	+\$776	+\$1,006	+\$545	+\$699

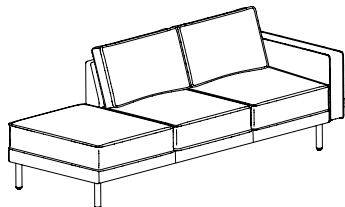
Optional Arm Pocket Available on both Single and Multiple Upholstery Units with Arm Pocket Upholstery matching the Arm.

Pocket Upcharge Pricing below represents upcharge for single arm pocket. For pockets on both arms, double the price.														
	COM	COL	A	B	C	D	E	F	G	H	I	J	L1	L2
No Leather Accent	\$131	\$188	\$140	\$158	\$188	\$228	\$267	\$329	\$395	\$465	\$574	\$706	\$443	\$531
With Leather Accent	\$174	\$231	\$183	\$200	\$231	\$271	\$310	\$371	\$437	\$507	\$617	\$749	\$485	\$573

Model	Upholstery	Pocket	Foot Style	Ganging
	Grade Vendor Pattern Colorway	NP No Pocket RP Right Pocket RPX Right Pocket - No Accent RPAR Right Pocket with Brown Accent RPAK Right Pocket with Black Accent LP Left Pocket LPX Left Pocket - No Accent LPAR Left Pocket with Brown Accent LPAK Left Pocket with Black Accent see pocket for pricing	WF Wood Foot See Poet Wood Foot Finishes MF Metal Foot See Poet Metal Foot Finishes see foot finish style for pricing	NGB No Ganging Brackets YGV Ganging Bracket - add \$50

Description + General Information

Two Seat Peninsula with Arm



left shown

- arm pocket available - upholstery same as arm and requires additional yardage, see upcharges below per arm
- undermount power center available - order EC30 separately

Dimensions	D	W	H	Shipping	
Overall	33	85 ½	32	Ctn Wt	154
Seat	22 & 34	80 ½	17 ½	Cu Ft	47
Arm			24 ¾		

	Single Upholstery	Frame Zone 1	Seat & Back Zone 2	Arm Zone 3	Pocket (per arm)
COM Ydg	13 ½	4 ¼	8 ¼	1 ¾	1
COL Sq Ft	270	85	165	35	18

Single Upholstery Specify: Model | Upholstery | Pocket | Foot Style | Ganging

PLCMP13B-R PLCMP13B-L

	COM	COL	A	B	C	D	E	F	G	H	I	J	L1	L2
Single Uph	\$4,563	\$5,333	\$4,682	\$4,919	\$5,333	\$5,866	\$6,399	\$7,228	\$8,117	\$9,064	\$10,545	\$12,321	\$8,768	\$9,952

Multiple Upholstery Specify: Model | Frame Upholstery | Seat & Back Uph | Arm Uph | Pocket | Foot Style | Ganging

PLCMP13B-R_M PLCMP13B-L_M

Base Price: \$4,563

To the Base Price, add the appropriate upcharges by grade, per zone

	COM	COL	A	B	C	D	E	F	G	H	I	J	L1	L2
Frame - Zone 1	+ n/a	+\$243	+\$38	+\$113	+\$243	+\$411	+\$578	+\$839	+\$1,119	+\$1,417	+\$1,884	+\$2,443	+\$1,324	+\$1,697
Seat & Back - Zone 2	+ n/a	+\$471	+\$73	+\$218	+\$471	+\$797	+\$1,122	+\$1,629	+\$2,172	+\$2,751	+\$3,656	+\$4,741	+\$2,570	+\$3,294
Arm - Zone 3	+ n/a	+\$100	+\$16	+\$47	+\$100	+\$169	+\$238	+\$346	+\$461	+\$584	+\$776	+\$1,006	+\$546	+\$699

Optional Arm Pocket Available on both Single and Multiple Upholstery Units with Arm Pocket Upholstery matching the Arm.

Pocket Upcharge

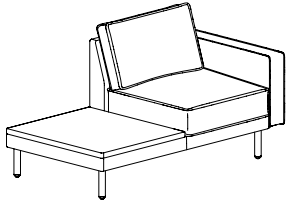
Pricing below represents upcharge for single arm pocket. For pockets on both arms, double the price.

	COM	COL	A	B	C	D	E	F	G	H	I	J	L1	L2
No Leather Accent	\$131	\$188	\$140	\$158	\$188	\$228	\$267	\$329	\$395	\$465	\$574	\$706	\$443	\$531
With Leather Accent	\$174	\$231	\$183	\$200	\$231	\$271	\$310	\$371	\$437	\$507	\$617	\$749	\$485	\$573

Model	Upholstery	Pocket	Foot Style	Ganging
PL58 POET	Grade Vendor Pattern Colorway	NP No Pocket RP Right Pocket RPX Right Pocket - No Accent RPAR Right Pocket with Brown Accent RPAP Right Pocket with Black Accent LP Left Pocket LPX Left Pocket - No Accent LPAR Left Pocket with Brown Accent LPAK Left Pocket with Black Accent see pocket for pricing	WF Wood Foot See Poet Wood Foot Finishes MF Metal Foot See Poet Metal Foot Finishes see foot finish style for pricing	NGB No Ganging Brackets YGV Ganging Bracket - add \$50

Description + General Information

Single Seat with Arm - Table



left shown

- arm pocket available - upholstery same as arm and requires additional yardage, see upcharges below per arm
- undermount power center available - order EC30 separately

Dimensions	D	W	H	Shipping	
Overall	32	58 ½	32	Ctn Wt	111
Seat	21	26 ½	17 ½	Cu Ft	31
Arm			24 ¾		

	Single Upholstery	Frame Zone 1	Seat & Back Zone 2	Arm Zone 3	Pocket (per arm)
COM Ydg	6 ½	2 ¼	3	1 ¾	1
COL Sq Ft	130	45	60	35	18

Single Upholstery Specify: Model | Single Uph | Pocket | Top Surface | Foot Style | Power | Ganging

PLCMP11T-R PLCMP11T-L														
	COM	COL	A	B	C	D	E	F	G	H	I	J	L1	L2
Single Uph/Lam	\$2,785	\$3,156	\$2,842	\$2,956	\$3,156	\$3,412	\$3,669	\$4,068	\$4,496	\$4,952	\$5,665	\$6,520	\$4,809	\$5,380
Single Uph/Flat Cut	\$3,118	\$3,489	\$3,175	\$3,289	\$3,489	\$3,745	\$4,002	\$4,401	\$4,829	\$5,285	\$5,998	\$6,853	\$5,142	\$5,713
Single Uph/Dble Cut	\$3,144	\$3,515	\$3,201	\$3,315	\$3,515	\$3,771	\$4,028	\$4,427	\$4,855	\$5,311	\$6,024	\$6,879	\$5,168	\$5,739
Single Uph/Solid Surf	\$4,582	\$4,953	\$4,639	\$4,753	\$4,953	\$5,209	\$5,466	\$5,865	\$6,293	\$6,749	\$7,462	\$8,317	\$6,606	\$7,177

Multiple Upholstery Specify: Model | Frame Uph | Seat & Back Uph | Arm Uph | Pocket | Top Surface | Foot Style | Power | Ganging

PLCMP11T-R_M PLCMP11T-L_M														
Base Price Laminate: \$2,785 Base Price Solid Surface: \$4,582 To the Base Price, add the appropriate upcharges by grade, per zone														
	COM	COL	A	B	C	D	E	F	G	H	I	J	L1	L2
Frame - Zone 1	+n/a	+\$129	+\$20	+\$60	+\$129	+\$218	+\$306	+\$445	+\$593	+\$751	+\$997	+\$1,293	+\$701	+\$899
Seat & Back - Zone 2	+n/a	+\$172	+\$27	+\$79	+\$172	+\$290	+\$408	+\$593	+\$790	+\$1,001	+\$1,330	+\$1,724	+\$935	+\$1,198
Arm - Zone 3	+n/a	+\$100	+\$16	+\$47	+\$100	+\$169	+\$238	+\$346	+\$461	+\$584	+\$776	+\$1,006	+\$545	+\$699

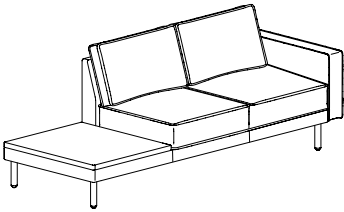
Optional Arm Pocket Available on both Single and Multiple Upholstery Units with Arm Pocket Upholstery matching the Arm.

Pocket Upcharge Pricing below represents upcharge for single arm pocket. For pockets on both arms, double the price.														
	COM	COL	A	B	C	D	E	F	G	H	I	J	L1	L2
No Leather Accent	\$131	\$188	\$140	\$158	\$188	\$228	\$267	\$329	\$395	\$465	\$574	\$706	\$443	\$531
With Leather Accent	\$174	\$231	\$183	\$200	\$231	\$271	\$310	\$371	\$437	\$507	\$617	\$749	\$485	\$573

Model	Upholstery	Pocket	Top Surface	Foot Style	Power	Ganging
	Grade Vendor Pattern Colorway	NP No Pocket RP Right Pocket RPX Right Pocket - No Accent RPAR Right Pocket with Brown Accent RPAK Right Pocket with Black Accent LP Left Pocket LPX Left Pocket - No Accent LPAR Left Pocket with Brown Accent LPAK Left Pocket with Black Accent see pocket for pricing	T Laminate See Poet Laminate Finishes V Veneer See Poet Veneer Finishes S Solid Surface See Poet Solid Surface Finishes see top surface for pricing	WF Wood Foot See Poet Wood Foot Finishes MF Metal Foot See Poet Metal Foot Finishes see foot finish style for pricing	NSP No Surface Power YSP Surface Power (EC31) - add \$420 B Black Power Unit B Black Cord G Graphite Cord - add \$187 W White Power Unit G Graphite Cord - add \$187	NGB No Ganging Brackets YGV Ganging Bracket - add \$50

Description + General Information

Two Seat with Arm - Table



left shown

- arm pocket available - upholstery same as arm and requires additional yardage, see upcharges below per arm
- undermount power center available - order EC30 separately

Dimensions	D	W	H	Shipping	
Overall	32	85 ½	32	Ctn Wt	154
Seat	21	53 ½	17 ½	Cu Ft	45
Arm			24 ¾		

	Single Upholstery	Frame Zone 1	Seat & Back Zone 2	Arm Zone 3	Pocket (per arm)
COM Ydg	11 ¼	4 ¼	6	1 ¾	1
COL Sq Ft	225	85	120	35	18

Single Upholstery Specify: Model | Single Uph | Pocket | Top Surface | Foot Style | Power | Ganging

	COM	COL	A	B	C	D	E	F	G	H	I	J	L1	L2
PLCMP12T-R PLCMP12T-L														
Single Uph/Lam	\$3,937	\$4,579	\$4,036	\$4,234	\$4,579	\$5,023	\$5,467	\$6,158	\$6,899	\$7,688	\$8,922	\$10,402	\$7,441	\$8,428
Single Uph/Flat Cut	\$4,270	\$4,912	\$4,369	\$4,567	\$4,912	\$5,356	\$5,800	\$6,491	\$7,232	\$8,021	\$9,255	\$10,735	\$7,774	\$8,761
Single Uph/Dble Cut	\$4,296	\$4,938	\$4,395	\$4,593	\$4,938	\$5,382	\$5,826	\$6,517	\$7,258	\$8,047	\$9,281	\$10,761	\$7,800	\$8,787
Single Uph/Solid Surf	\$5,734	\$6,376	\$5,833	\$6,031	\$6,376	\$6,820	\$7,264	\$7,955	\$8,696	\$9,485	\$10,719	\$12,199	\$9,238	\$10,225

Multiple Upholstery Specify: Model | Frame Uph | Seat & Back Uph | Arm Uph | Pocket | Top Surface | Foot Style | Power | Ganging

	COM	COL	A	B	C	D	E	F	G	H	I	J	L1	L2
PLCMP12T-R_M PLCMP12T-L_M														
	Base Price Laminate: \$3,937							Base Price Flat Cut: \$4,270						
	Base Price Solid Surface: \$5,734							Base Price Double Cut: \$4,296						
	To the Base Price, add the appropriate upcharges by grade, per zone													
Frame - Zone 1	+n/a	+\$243	+\$38	+\$113	+\$243	+\$411	+\$578	+\$840	+\$1,119	+\$1,418	+\$1,884	+\$2,443	+\$1,324	+\$1,697
Seat & Back - Zone 2	+n/a	+\$343	+\$53	+\$159	+\$343	+\$580	+\$816	+\$1,185	+\$1,580	+\$2,001	+\$2,659	+\$3,448	+\$1,869	+\$2,396
Arm - Zone 3	+ n/a	+\$100	+\$16	+\$47	+\$100	+\$169	+\$238	+\$346	+\$461	+\$584	+\$776	+\$1,006	+\$546	+\$699

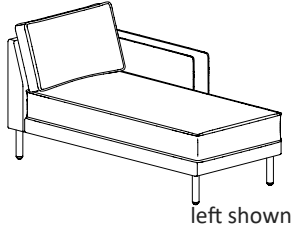
Optional Arm Pocket Available on both Single and Multiple Upholstery Units with Arm Pocket Upholstery matching the Arm.

Pocket Upcharge	Pricing below represents upcharge for single arm pocket. For pockets on both arms, double the price.													
	COM	COL	A	B	C	D	E	F	G	H	I	J	L1	L2
No Leather Accent	\$131	\$188	\$140	\$158	\$188	\$228	\$267	\$329	\$395	\$465	\$574	\$706	\$443	\$531
With Leather Accent	\$174	\$231	\$183	\$200	\$231	\$271	\$310	\$371	\$437	\$507	\$617	\$749	\$485	\$573

Model	Upholstery	Pocket	Top Surface	Foot Style	Power	Ganging
	Grade Vendor Pattern Colorway	NP No Pocket RP Right Pocket RPX Right Pocket - No Accent RPAR Right Pocket with Brown Accent RPAK Right Pocket with Black Accent LP Left Pocket LPX Left Pocket - No Accent LPAR Left Pocket with Brown Accent LPAK Left Pocket with Black Accent see pocket for pricing	T Laminate See Poet Laminate Finishes V Veneer See Poet Veneer Finishes S Solid Surface See Poet Solid Surface Finishes see top surface for pricing	WF Wood Foot See Poet Wood Foot Finishes MF Metal Foot See Poet Metal Foot Finishes see foot finish style for pricing	NSP No Surface Power YSP Surface Power (EC31) - add \$420 B Black Power Unit B Black Cord G Graphite Cord - add \$187 W White Power Unit G Graphite Cord - add \$187	NGB No Ganging Brackets YGV Ganging Bracket - add \$50

Description + General Information

Chaise



- arm pocket available - upholstery same as arm and requires additional yardage, see upcharges below per arm
- undermount power center available - order EC30 separately

Dimensions	D	W	H	Shipping	
Overall	59	31 ½	32	Ctn Wt	82
Seat	48	26 ½	17 ½	Cu Ft	31
Arm			24 ¾		

	Single Upholstery	Frame Zone 1	Seat & Back Zone 2	Arm Zone 3	Pocket (per arm)
COM Ydg	7 ½	2	4 ½	1 ¾	1
COL Sq Ft	150	40	90	35	18

Single Upholstery Specify: Model | Single Uph | Pocket | Foot Style | Ganging

PLCM16-R PLCM16-L														
	COM	COL	A	B	C	D	E	F	G	H	I	J	L1	L2
Single Uph	\$3,110	\$3,538	\$3,176	\$3,308	\$3,538	\$3,834	\$4,130	\$4,591	\$5,085	\$5,611	\$6,433	\$7,420	\$5,446	\$6,104

Multiple Upholstery Specify: Model | Frame Upholstery | Seat & Back Uph | Arm Uph | Pocket | Foot Style | Ganging

PLCM16-R_M PLCM16-L_M														
Base Price: \$3,110	To the Base Price, add the appropriate upcharges by grade, per zone													
	COM	COL	A	B	C	D	E	F	G	H	I	J	L1	L2
Frame - Zone 1	+ n/a	+\$115	+\$18	+\$53	+\$115	+\$194	+\$272	+\$395	+\$527	+\$667	+\$887	+\$1,150	+\$623	+\$799
Seat & Back - Zone 2	+ n/a	+\$257	+\$40	+\$119	+\$257	+\$435	+\$612	+\$889	+\$1,185	+\$1,501	+\$1,994	+\$2,586	+\$1,402	+\$1,797
Arm - Zone 3	+ n/a	+\$100	+\$16	+\$47	+\$100	+\$169	+\$238	+\$346	+\$461	+\$584	+\$776	+\$1,006	+\$546	+\$699

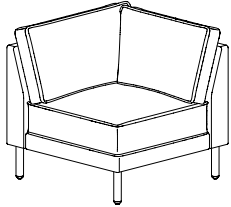
Optional Arm Pocket Available on both Single and Multiple Upholstery Units with Arm Pocket Upholstery matching the Arm.

Pocket Upcharge Pricing below represents upcharge for single arm pocket. For pockets on both arms, double the price.														
	COM	COL	A	B	C	D	E	F	G	H	I	J	L1	L2
No Leather Accent	\$131	\$188	\$140	\$158	\$188	\$228	\$267	\$329	\$395	\$465	\$574	\$706	\$443	\$531
With Leather Accent	\$174	\$231	\$183	\$200	\$231	\$271	\$310	\$371	\$437	\$507	\$617	\$749	\$485	\$573

Model	Upholstery	Pocket	Foot Style	Ganging
	Grade Vendor Pattern Colorway	NP No Pocket RP Right Pocket RPX Right Pocket - No Accent RPAR Right Pocket with Brown Accent RPAK Right Pocket with Black Accent LP Left Pocket LPX Left Pocket - No Accent LPAR Left Pocket with Brown Accent LPAK Left Pocket with Black Accent see pocket for pricing	WF Wood Foot See Poet Wood Foot Finishes MF Metal Foot See Poet Metal Foot Finishes see foot finish style for pricing	NGB No Ganging Brackets YGV Ganging Bracket - add \$50

Description + General Information

Corner



left shown

- undermount power center available - order EC30 separately

Dimensions	D	W	H	Shipping	
Overall	31 ½	31 ½	32	Ctn Wt	66
Seat	20 ½	20 ½	17 ½	Cu Ft	17

	Single Upholstery	Frame Zone 1	Seat & Back Zone 2
COM Ydg	7	3 ¼	4 ¼
COL Sq Ft	140	65	85

Single Upholstery Specify: Model | Single Uph | Foot Style | Ganging

PLCMC01-R PLCMC01-L														
	COM	COL	A	B	C	D	E	F	G	H	I	J	L1	L2
Single Uph	\$2,554	\$2,954	\$2,616	\$2,739	\$2,954	\$3,230	\$3,506	\$3,936	\$4,397	\$4,888	\$5,656	\$6,577	\$4,735	\$5,349

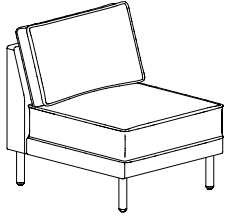
Multiple Upholstery Specify: Model | Frame Upholstery | Seat & Back Uph | Foot Style | Ganging

PLCMC01-R_M PLCMC01-L_M														
Base Price: \$2,554	To the Base Price, add the appropriate upcharges by grade, per zone													
	COM	COL	A	B	C	D	E	F	G	H	I	J	L1	L2
Frame - Zone 1	+ n/a	+\$186	+\$29	+\$86	+\$186	+\$314	+\$442	+\$642	+\$856	+\$1,084	+\$1,441	+\$1,868	+\$1,013	+\$1,298
Seat & Back - Zone 2	+ n/a	+\$243	+\$38	+\$113	+\$243	+\$411	+\$578	+\$840	+\$1,119	+\$1,418	+\$1,884	+\$2,443	+\$1,325	+\$1,697

Model	Upholstery	Foot Style	Ganging
PL62 POET	Grade Vendor Pattern Colorway	WF Wood Foot See Poet Wood Foot Finishes MF Metal Foot See Poet Metal Foot Finishes see foot finish style for pricing	NGB No Ganging Brackets YGV Ganging Bracket - add \$50

Description + General Information

Single Seat - Armless



- undermount power center available - order EC30 separately

Dimensions	D	W	H	Shipping	
Overall	32	27	32	Ctn Wt	54
Seat	21	27	17 ½	Cu Ft	15

	Single Upholstery	Frame Zone 1	Seat & Back Zone 2
COM Ydg	5	2 ¼	3
COL Sq Ft	100	40	60

Single Upholstery Specify: Model | Upholstery | Foot Style | Ganging

PLCM01														
	COM	COL	A	B	C	D	E	F	G	H	I	J	L1	L2
Single Uph	\$2,051	\$2,337	\$2,095	\$2,183	\$2,337	\$2,534	\$2,732	\$3,039	\$3,368	\$3,719	\$4,267	\$4,925	\$3,609	\$4,048

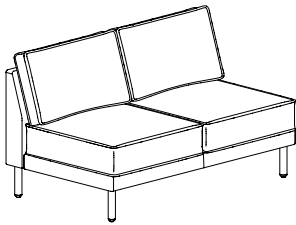
Multiple Upholstery Specify: Model | Frame Upholstery | Seat & Back Uph | Foot Style | Ganging

PLCM01_M														
Base Price: \$2,051	To the Base Price, add the appropriate upcharges by grade, per zone													
	COM	COL	A	B	C	D	E	F	G	H	I	J	L1	L2
Frame - Zone 1	+ n/a	+\$129	+ \$20	+ \$60	+\$129	+\$218	+ \$307	+ \$445	+ \$593	+ \$751	+ \$998	+ \$1,294	+ \$702	+ \$899
Seat & Back - Zone 2	+ n/a	+\$172	+ \$27	+ \$80	+\$172	+\$290	+ \$409	+ \$593	+ \$791	+ \$1,001	+ \$1,330	+ \$1,725	+ \$935	+ \$1,199

Model	Upholstery	Foot Style	Ganging
	Grade Vendor Pattern Colorway	WF Wood Foot See Poet Wood Foot Finishes MF Metal Foot See Poet Metal Foot Finishes see foot finish style for pricing	NGB No Ganging Brackets YGV Ganging Bracket - add \$50

Description + General Information

Two Seat - Armless



- undermount power center available - order EC30 separately

Dimensions	D	W	H	Shipping	
Overall	32	54 ¼	32	Ctn Wt	101
Seat	21	54 ¼	17 ½	Cu Ft	29

	Single Upholstery	Frame Zone 1	Seat & Back Zone 2
COM Ydg	9 ½	3 ¾	6
COL Sq Ft	190	70	120

Single Upholstery Specify: Model | Upholstery | Foot Style | Ganging

PLCM02														
	COM	COL	A	B	C	D	E	F	G	H	I	J	L1	L2
Single Uph	\$3,188	\$3,730	\$3,271	\$3,438	\$3,730	\$4,105	\$4,480	\$5,063	\$5,688	\$6,355	\$7,397	\$8,647	\$6,147	\$6,980

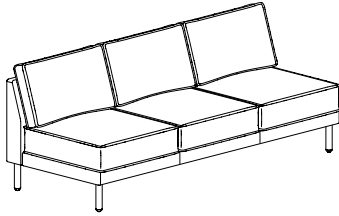
Multiple Upholstery Specify: Model | Frame Upholstery | Seat & Back Uph | Foot Style | Ganging

PLCM02_M														
Base Price: \$3,188	To the Base Price, add the appropriate upcharges by grade, per zone													
	COM	COL	A	B	C	D	E	F	G	H	I	J	L1	L2
Frame - Zone 1	+ n/a	+\$214	+ \$33	+ \$99	+\$214	+\$362	+ \$510	+ \$741	+ \$987	+ \$1,251	+ \$1,662	+ \$2,155	+ \$1,169	+ \$1,497
Seat & Back - Zone 2	+ n/a	+\$343	+ \$53	+\$158	+\$343	+\$580	+ \$816	+ \$1,185	+ \$1,579	+ \$2,001	+ \$2,659	+ \$3,448	+ \$1,869	+ \$2,395

Model	Upholstery	Foot Style	Ganging
PL64 POET	Grade Vendor Pattern Colorway	WF Wood Foot See Poet Wood Foot Finishes MF Metal Foot See Poet Metal Foot Finishes see foot finish style for pricing	NGB No Ganging Brackets YGV Ganging Bracket - add \$50

Description + General Information

Three Seat - Armless



- undermount power center available - order EC30 separately

Dimensions	D	W	H	Shipping	
Overall	32	81 ½	32	Ctn Wt	146
Seat	21	81 ½	17 ½	Cu Ft	43

	Single Upholstery	Frame Zone 1	Seat & Back Zone 2
COM Ydg	14 ¼	5 ½	9
COL Sq Ft	285	105	180

Single Upholstery Specify: Model | Upholstery | Foot Style | Ganging

PLCM03														
	COM	COL	A	B	C	D	E	F	G	H	I	J	L1	L2
Single Uph	\$4,375	\$5,188	\$4,501	\$4,751	\$5,188	\$5,751	\$6,314	\$7,189	\$8,126	\$9,127	\$10,689	\$12,565	\$8,814	\$10,064

Multiple Upholstery Specify: Model | Frame Upholstery | Seat & Back Uph | Foot Style | Ganging

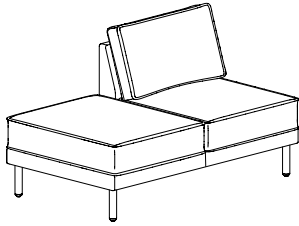
PLCM03_M														
Base Price: \$4,375	To the Base Price, add the appropriate upcharges by grade, per zone													
	COM	COL	A	B	C	D	E	F	G	H	I	J	L1	L2
Frame - Zone 1	+ n/a	+\$314	+\$49	+\$146	+\$314	+\$532	+\$749	+\$1,087	+\$1,448	+\$1,835	+\$2,437	+\$3,162	+\$1,714	+\$2,196
Seat & Back - Zone 2	+ n/a	+\$514	+\$80	+\$238	+\$514	+\$870	+\$1,225	+\$1,778	+\$2,370	+\$3,002	+\$3,988	+\$5,173	+\$2,804	+\$3,594

Model	Upholstery	Foot Style	Ganging
	Grade Vendor Pattern Colorway	WF Wood Foot See Poet Wood Foot Finishes MF Metal Foot See Poet Metal Foot Finishes see foot finish style for pricing	NGB No Ganging Brackets YGV Ganging Bracket - add \$50

Description + General Information

Two Seat Peninsula - Armless

- undermount power center available - order EC30 separately



left shown

Dimensions	D	W	H	Shipping	
Overall	33	54 ¼	32	Ctn Wt	97
Seat	22 & 34	54 ¼	17 ½	Cu Ft	30

	Single Upholstery	Frame Zone 1	Seat & Back Zone 2
COM Ydg	7 ½	2 ½	5 ¼
COL Sq Ft	150	45	105

Single Upholstery Specify: Model | Upholstery | Foot Style | Ganging

PLCMP02B-R PLCMP02B-L

	COM	COL	A	B	C	D	E	F	G	H	I	J	L1	L2
Single Uph	\$2,842	\$3,270	\$2,908	\$3,040	\$3,270	\$3,566	\$3,862	\$4,323	\$4,816	\$5,343	\$6,165	\$7,152	\$5,178	\$5,836

Multiple Upholstery Specify: Model | Frame Upholstery | Seat & Back Uph | Foot Style | Ganging

PLCMP02B-R_M PLCMP02B-L_M

Base Price: \$2,842

To the Base Price, add the appropriate upcharges by grade, per zone

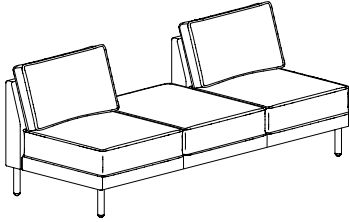
	COM	COL	A	B	C	D	E	F	G	H	I	J	L1	L2
Frame - Zone 1	+ n/a	+\$143	+\$22	+\$66	+\$143	+\$242	+\$340	+\$494	+\$658	+\$834	+\$1,108	+\$1,437	+\$779	+\$998
Seat & Back - Zone 2	+ n/a	+\$300	+\$47	+\$139	+\$300	+\$507	+\$714	+\$1,037	+\$1,382	+\$1,751	+\$2,327	+\$3,017	+\$1,636	+\$2,096

Model	Upholstery	Foot Style	Ganging
PL66 POET	Grade Vendor Pattern Colorway	WF Wood Foot See Poet Wood Foot Finishes MF Metal Foot See Poet Metal Foot Finishes see foot finish style for pricing	NGB No Ganging Brackets YGV Ganging Bracket - add \$50

Description + General Information

Two Seat with Center Bench - Armless

- undermount power center available - order EC30 separately



Dimensions	D	W	H	Shipping	
Overall	33	81 ½	32	Ctn Wt	142
Seat	22 & 34	81 ½	17 ½	Cu Ft	44

	Single Upholstery	Frame Zone 1	Seat & Back Zone 2
COM Ydg	12 ½	4 ½	8 ½
COL Sq Ft	250	85	165

Single Upholstery Specify: Model | Upholstery | Foot Style | Ganging

PLCMP03B														
	COM	COL	A	B	C	D	E	F	G	H	I	J	L1	L2
Single Uph	\$4,149	\$4,863	\$4,260	\$4,479	\$4,863	\$5,356	\$5,850	\$6,617	\$7,440	\$8,317	\$9,688	\$11,333	\$8,043	\$9,140

Multiple Upholstery Specify: Model | Frame Upholstery | Seat & Back Uph | Foot Style | Ganging

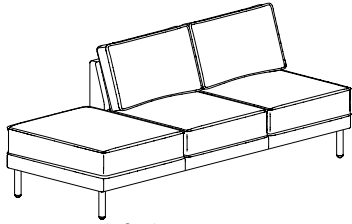
PLCMP03B_M														
Base Price: \$4,149	To the Base Price, add the appropriate upcharges by grade, per zone													
	COM	COL	A	B	C	D	E	F	G	H	I	J	L1	L2
Frame - Zone 1	+ n/a	+\$258	+\$40	+\$119	+\$258	+\$435	+\$613	+\$889	+\$1,185	+\$1,501	+\$1,995	+\$2,587	+\$1,402	+\$1,797
Seat & Back - Zone 2	+ n/a	+\$472	+\$74	+\$218	+\$472	+\$797	+\$1,123	+\$1,629	+\$2,173	+\$2,751	+\$3,656	+\$4,742	+\$2,571	+\$3,295

Model	Upholstery	Foot Style	Ganging
	Grade Vendor Pattern Colorway	WF Wood Foot See Poet Wood Foot Finishes MF Metal Foot See Poet Metal Foot Finishes see foot finish style for pricing	NGB No Ganging Brackets YGV Ganging Bracket - add \$50

Description + General Information

Two Seat with Bench - Armless

- undermount power center available - order EC30 separately



left shown

Dimensions	D	W	H	Shipping	
Overall	34	81 ½	32	Ctn Wt	142
Seat	22 & 34	81 ½	17 ½	Cu Ft	46

	Single Upholstery	Frame Zone 1	Seat & Back Zone 2
COM Ydg	12 ¼	4 ¼	8 ¼
COL Sq Ft	245	85	165

Single Upholstery Specify: Model | Upholstery | Foot Style | Ganging

PLCMP03B-R PLCMP03B-L														
	COM	COL	A	B	C	D	E	F	G	H	I	J	L1	L2
Single Uph	\$4,177	\$4,877	\$4,285	\$4,500	\$4,877	\$5,360	\$5,844	\$6,596	\$7,402	\$8,262	\$9,605	\$11,217	\$7,993	\$9,068

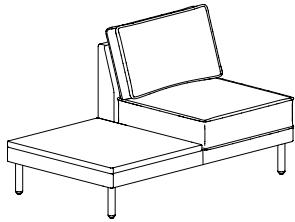
Multiple Upholstery Specify: Model | Frame Upholstery | Seat & Back Uph | Foot Style | Ganging

PLCMP03B-R_M PLCMP03B-L_M														
Base Price: \$4,177	To the Base Price, add the appropriate upcharges by grade, per zone													
	COM	COL	A	B	C	D	E	F	G	H	I	J	L1	L2
Frame - Zone 1	+ n/a	+\$243	+\$38	+\$113	+\$243	+\$411	+\$579	+\$840	+\$1,119	+\$1,418	+\$1,884	+\$2,443	+\$1,324	+\$1,697
Seat & Back - Zone 2	+ n/a	+\$472	+\$73	+\$218	+\$472	+\$797	+\$1,123	+\$1,630	+\$2,172	+\$2,752	+\$3,656	+\$4,742	+\$2,570	+\$3,294

Model	Upholstery	Foot Style	Ganging
PL68 POET	Grade Vendor Pattern Colorway	WF Wood Foot See Poet Wood Foot Finishes MF Metal Foot See Poet Metal Foot Finishes see foot finish style for pricing	NGB No Ganging Brackets YGV Ganging Bracket - add \$50

Description + General Information

Single Seat with Table - Armless



left shown

- undermount power center available - order EC30 separately

Dimensions	D	W	H	Shipping	
Overall	32	54 ¼	32	Ctn Wt	97
Seat	21	27	17 ½	Cu Ft	29

	Single Upholstery	Frame Zone 1	Seat & Back Zone 2
COM Ydg	5 ¼	2 ½	3
COL Sq Ft	105	45	60

Single Upholstery Specify: Model | Single Uph | Top Surface | Foot Style | Power | Ganging

PLCMP01T-R PLCMP01T-L														
	COM	COL	A	B	C	D	E	F	G	H	I	J	L1	L2
Single Uph/Lam	\$2,335	\$2,635	\$2,382	\$2,474	\$2,635	\$2,842	\$3,049	\$3,372	\$3,717	\$4,086	\$4,662	\$5,352	\$3,971	\$4,431
Single Uph/Flat Cut	\$2,668	\$2,968	\$2,715	\$2,807	\$2,968	\$3,175	\$3,382	\$3,705	\$4,050	\$4,419	\$4,995	\$5,685	\$4,304	\$4,764
Single Uph/Dble Cut	\$2,694	\$2,994	\$2,741	\$2,833	\$2,994	\$3,201	\$3,408	\$3,731	\$4,076	\$4,445	\$5,021	\$5,711	\$4,330	\$4,790
Single Uph/Solid Surf	\$4,132	\$4,432	\$4,179	\$4,271	\$4,432	\$4,639	\$4,846	\$5,169	\$5,514	\$5,883	\$6,459	\$7,149	\$5,768	\$6,228

Multiple Upholstery Specify: Model | Frame Uph | Seat & Back Uph | Top Surface | Foot Style | Power | Ganging

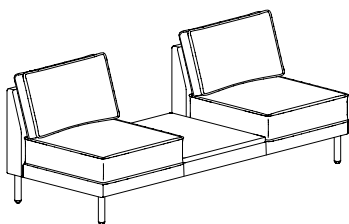
PLCMP01T-R_M PLCMP01T-L_M		Base Price Laminate: \$2,335					Base Price Flat Cut: \$2,668							
		Base Price Solid Surface: \$4,132					Base Price Double Cut: \$2,694							
To the Base Price, add the appropriate upcharges by grade, per zone														
	COM	COL	A	B	C	D	E	F	G	H	I	J	L1	L2
Frame - Zone 1	+n/a	+\$143	+\$23	+\$67	+\$143	+\$242	+\$340	+\$494	+\$659	+\$834	+\$1,109	+\$1,437	+\$780	+\$999
Seat & Back - Zone 2	+n/a	+\$172	+\$27	+\$80	+\$172	+\$290	+\$408	+\$593	+\$790	+\$1,001	+\$1,330	+\$1,724	+\$935	+\$1,198

Model	Upholstery	Top Surface	Foot Style	Power	Ganging
	Grade Vendor Pattern Colorway	T Laminate See Poet Laminate Finishes V Veneer See Poet Veneer Finishes S Solid Surface See Poet Solid Surface Finishes see top surface for pricing	WF Wood Foot See Poet Wood Foot Finishes MF Metal Foot See Poet Metal Foot Finishes see foot finish style for pricing	NSP No Surface Power YSP Surface Power (EC31) - add \$420 B Black Power Unit B Black Cord G Graphite Cord - add \$187 W White Power Unit G Graphite Cord - add \$187	NGB No Ganging Brackets YGV Ganging Bracket - add \$50

Description + General Information

Two Seat with Center Table - Armless

- undermount power center available - order EC30 separately



Dimensions	D	W	H	Shipping	
Overall	32	81 ½	32	Ctn Wt	142
Seat	21	27 ea	17 ½	Cu Ft	43

	Single Upholstery	Frame Zone 1	Seat & Back Zone 2
COM Ydg	10	4 ¼	6
COL Sq Ft	200	85	120

Single Upholstery Specify: Model | Single Uph | Top Surface | Foot Style | Power | Ganging

PLCMP02T														
	COM	COL	A	B	C	D	E	F	G	H	I	J	L1	L2
Single Uph/Lam	\$3,730	\$4,301	\$3,818	\$3,994	\$4,301	\$4,695	\$5,090	\$5,704	\$6,362	\$7,064	\$8,161	\$9,477	\$6,845	\$7,722
Single Uph/Flat Cut	\$4,063	\$4,634	\$4,151	\$4,327	\$4,634	\$5,028	\$5,423	\$6,037	\$6,695	\$7,397	\$8,494	\$9,810	\$7,178	\$8,055
Single Uph/Dble Cut	\$4,089	\$4,660	\$4,177	\$4,353	\$4,660	\$5,054	\$5,449	\$6,063	\$6,721	\$7,423	\$8,520	\$9,836	\$7,204	\$8,081
Single Uph/Solid Surf	\$5,527	\$6,098	\$5,615	\$5,791	\$6,098	\$6,492	\$6,887	\$7,501	\$8,159	\$8,861	\$9,958	\$11,274	\$8,642	\$9,519

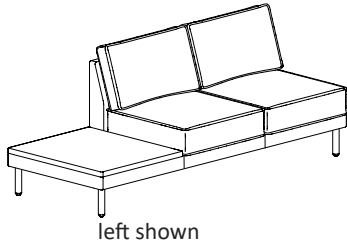
Multiple Upholstery Specify: Model | Frame Uph | Seat & Back Uph | Top Surface | Foot Style | Power | Ganging

PLCMP02T_M	Base Price Laminate: \$3,730							Base Price Flat Cut: \$4,063						
	Base Price Solid Surface: \$5,527							Base Price Double Cut: \$4,089						
To the Base Price, add the appropriate upcharges by grade, per zone														
	COM	COL	A	B	C	D	E	F	G	H	I	J	L1	L2
Frame - Zone 1	+n/a	+\$243	+\$38	+\$113	+\$243	+\$411	+\$578	+\$839	+\$1,119	+\$1,417	+\$1,884	+\$2,443	+\$1,324	+\$1,697
Seat & Back - Zone 2	+n/a	+\$343	+\$53	+\$159	+\$343	+\$579	+\$816	+\$1,185	+\$1,580	+\$2,001	+\$2,659	+\$3,449	+\$1,869	+\$2,396

Model	Upholstery	Top Surface	Foot Style	Power	Ganging
	Grade Vendor Pattern Colorway	T Laminate See Poet Laminate Finishes V Veneer See Poet Veneer Finishes S Solid Surface See Poet Solid Surface Finishes see top surface for pricing	WF Wood Foot See Poet Wood Foot Finishes MF Metal Foot See Poet Metal Foot Finishes see foot finish style for pricing	NSP No Surface Power YSP Surface Power (EC31) - add \$420 B Black Power Unit B Black Cord G Graphite Cord - add \$187 W White Power Unit G Graphite Cord - add \$187	NGB No Ganging Brackets YGV Ganging Bracket - add \$50

Description + General Information

Two Seat with Table - Armless



- undermount power center available - order EC30 separately

Dimensions	D	W	H	Shipping	
Overall	32	81 ½	32	Ctn Wt	142
Seat	21	54 ¼	17 ½	Cu Ft	43

	Single Upholstery	Frame Zone 1	Seat & Back Zone 2
COM Ydg	9 ¾	4 ¼	6
COL Sq Ft	195	85	120

Single Upholstery Specify: Model | Single Uph | Top Surface | Foot Style | Power | Ganging

PLCMP02T-R PLCMP02T-L														
	COM	COL	A	B	C	D	E	F	G	H	I	J	L1	L2
Single Uph/Lam	\$3,558	\$4,114	\$3,644	\$3,815	\$4,114	\$4,499	\$4,884	\$5,483	\$6,124	\$6,809	\$7,878	\$9,161	\$6,595	\$7,450
Single Uph/Flat Cut	\$3,891	\$4,447	\$3,977	\$4,148	\$4,447	\$4,832	\$5,217	\$5,816	\$6,457	\$7,142	\$8,211	\$9,494	\$6,928	\$7,783
Single Uph/Dble Cut	\$3,917	\$4,473	\$4,003	\$4,174	\$4,473	\$4,858	\$5,243	\$5,842	\$6,483	\$7,168	\$8,237	\$9,520	\$6,954	\$7,809
Single Uph/Solid Surf	\$5,355	\$5,911	\$5,441	\$5,612	\$5,911	\$6,296	\$6,681	\$7,280	\$7,921	\$8,606	\$9,675	\$10,958	\$8,392	\$9,247

Multiple Upholstery Specify: Model | Frame Uph | Seat & Back Uph | Top Surface | Foot Style | Power | Ganging

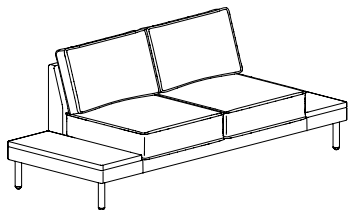
PLCMP02T-R_M PLCMP02T-L_M														
	Base Price Laminate: \$3,558							Base Price Flat Cut: \$3,891						
	Base Price Solid Surface: \$5,355							Base Price Double Cut: \$3,917						
To the Base Price, add the appropriate upcharges by grade, per zone														
	COM	COL	A	B	C	D	E	F	G	H	I	J	L1	L2
Frame - Zone 1	+n/a	+\$243	+\$38	+\$113	+\$243	+\$411	+\$578	+\$840	+\$1,119	+\$1,418	+\$1,884	+\$2,443	+\$1,324	+\$1,697
Seat & Back - Zone 2	+n/a	+\$343	+\$53	+\$159	+\$343	+\$580	+\$816	+\$1,185	+\$1,580	+\$2,001	+\$2,659	+\$3,448	+\$1,869	+\$2,396

Model	Upholstery	Top Surface	Foot Style	Power	Ganging
	Grade Vendor Pattern Colorway	T Laminate See Poet Laminate Finishes V Veneer See Poet Veneer Finishes S Solid Surface See Poet Solid Surface Finishes see top surface for pricing	WF Wood Foot See Poet Wood Foot Finishes MF Metal Foot See Poet Metal Foot Finishes see foot finish style for pricing	NSP No Surface Power YSP Surface Power (EC31) - add \$420 B Black Power Unit B Black Cord G Graphite Cord - add \$187 W White Power Unit G Graphite Cord - add \$187	NGB No Ganging Brackets YGV Ganging Bracket - add \$50

Description + General Information

Two Seat with Two Tables - Armless

- undermount power center available - order EC30 separately



Dimensions	D	W	H	Shipping	
Overall	32	81 ½	32	Ctn Wt	140
Seat	21	54 ¼	17 ½	Cu Ft	43

	Single Upholstery	Frame Zone 1	Seat & Back Zone 2
COM Ydg	9 ¾	4 ¼	6
COL Sq Ft	195	85	120

Single Upholstery Specify: Model | Single Uph | Top Surface | Foot Style | Power | Ganging

PLCM02T-D														
	COM	COL	A	B	C	D	E	F	G	H	I	J	L1	L2
Single Uph/Lam	\$3,613	\$4,169	\$3,699	\$3,870	\$4,169	\$4,554	\$4,939	\$5,538	\$6,179	\$6,864	\$7,933	\$9,216	\$6,650	\$7,505
Single Uph/Flat Cut	\$4,009	\$4,565	\$4,095	\$4,266	\$4,565	\$4,950	\$5,335	\$5,934	\$6,575	\$7,260	\$8,329	\$9,612	\$7,046	\$7,901
Single Uph/Dble Cut	\$4,037	\$4,593	\$4,123	\$4,294	\$4,593	\$4,978	\$5,363	\$5,962	\$6,603	\$7,288	\$8,357	\$9,640	\$7,074	\$7,929
Single Uph/Solid Surf	\$5,739	\$6,295	\$5,825	\$5,996	\$6,295	\$6,680	\$7,065	\$7,664	\$8,305	\$8,990	\$10,059	\$11,342	\$8,776	\$9,631

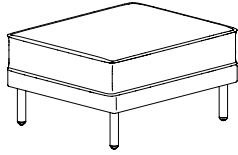
Multiple Upholstery Specify: Model | Frame Uph | Seat & Back Uph | Top Surface | Foot Style | Power | Ganging

PLCM02T-D_M														
Base Price Laminate: \$3,613					Base Price Flat Cut: \$4,009									
Base Price Solid Surface: \$5,739					Base Price Double Cut: \$4,037									
To the Base Price, add the appropriate upcharges by grade, per zone														
	COM	COL	A	B	C	D	E	F	G	H	I	J	L1	L2
Frame - Zone 1	+n/a	+\$243	+\$38	+\$113	+\$243	+\$411	+\$578	+\$840	+\$1,119	+\$1,418	+\$1,884	+\$2,443	+\$1,324	+\$1,697
Seat & Back - Zone 2	+n/a	+\$343	+\$53	+\$159	+\$343	+\$580	+\$816	+\$1,185	+\$1,580	+\$2,001	+\$2,659	+\$3,448	+\$1,869	+\$2,396

Model	Upholstery	Top Surface	Foot Style	Power	Ganging
	Grade Vendor Pattern Colorway	T Laminate See Poet Laminate Finishes V Veneer See Poet Veneer Finishes S Solid Surface See Poet Solid Surface Finishes see top surface for pricing	WF Wood Foot See Poet Wood Foot Finishes MF Metal Foot See Poet Metal Foot Finishes see foot finish style for pricing	NSP No Surface Power YSP Surface Power (EC31) - add \$420 B Black Power Unit B Black Cord G Graphite Cord - add \$187 W White Power Unit G Graphite Cord - add \$187	NGB No Ganging Brackets YGV Ganging Bracket - add \$50

Description + General Information

Modular Single Seat Bench



- undermount power center available - order EC30 separately

Dimensions	D	W	H	Shipping	
Overall	33	27	17 ½	Ctn Wt	50
Seat	33	27	17 ½	Cu Ft	7

	Single Upholstery	Frame Zone 1	Seat Zone 2
COM Ydg	3	1	2 ¼
COL Sq Ft	54	15	45

Single Upholstery Specify: Model | Upholstery | Foot Style | Ganging

PLCMB01														
	COM	COL	A	B	C	D	E	F	G	H	I	J	L1	L2
Single Uph	\$1,408	\$1,579	\$1,434	\$1,487	\$1,579	\$1,698	\$1,816	\$2,000	\$2,198	\$2,408	\$2,737	\$3,132	\$2,342	\$2,606

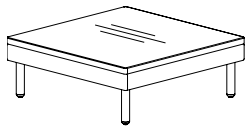
Multiple Upholstery Specify: Model | Frame Upholstery | Seat & Back Uph | Foot Style | Ganging

PLCMB01_M														
Base Price: \$1,408	To the Base Price, add the appropriate upcharges by grade, per zone													
	COM	COL	A	B	C	D	E	F	G	H	I	J	L1	L2
Frame - Zone 1	+ n/a	+\$57	+\$9	+\$27	+\$57	+\$97	+\$136	+\$198	+\$264	+\$334	+\$443	+\$575	+\$312	+\$400
Seat - Zone 2	+ n/a	+\$129	+\$20	+\$60	+\$129	+\$218	+\$306	+\$444	+\$593	+\$750	+\$997	+\$1,293	+\$701	+\$899

Model	Upholstery	Foot Style	Ganging
	Grade Vendor Pattern Colorway	WF Wood Foot See Poet Wood Foot Finishes MF Metal Foot See Poet Metal Foot Finishes see foot finish style for pricing	NGB No Ganging Brackets YGV Ganging Bracket - add \$50

Description + General Information

Modular Corner Table - Straight Grain



- undermount power center available - order EC30 separately

Dimensions	D	W	H	Shipping	
Overall	30 ¾	30 ¾	11 ½	Ctn Wt	50
				Cu Ft	4

Apron Upholstery	
COM Ydg	1
COL Sq Ft	18

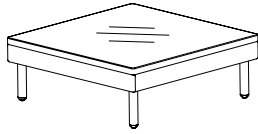
Single Upholstery Specify: Model | Apron Uph | Top Surface | Foot Style | Power | Ganging

PLMCT														
	COM	COL	A	B	C	D	E	F	G	H	I	J	L1	L2
Single Uph/Lam	\$1,073	\$1,130	\$1,082	\$1,100	\$1,130	\$1,170	\$1,209	\$1,271	\$1,336	\$1,407	\$1,516	\$1,648	\$1,385	\$1,472
Single Uph/Flat Cut	\$1,413	\$1,470	\$1,422	\$1,440	\$1,470	\$1,510	\$1,549	\$1,611	\$1,676	\$1,747	\$1,856	\$1,988	\$1,725	\$1,812
Single Uph/Dble Cut	\$1,443	\$1,500	\$1,452	\$1,470	\$1,500	\$1,540	\$1,579	\$1,641	\$1,706	\$1,777	\$1,886	\$2,018	\$1,755	\$1,842
Single Uph/Solid Surf	\$3,118	\$3,175	\$3,127	\$3,145	\$3,175	\$3,215	\$3,254	\$3,316	\$3,381	\$3,452	\$3,561	\$3,693	\$3,430	\$3,517

Model	Upholstery	Top Surface	Foot Style	Power	Ganging
	Grade Vendor Pattern Colorway	T Laminate See Poet Laminate Finishes V Veneer See Poet Veneer Finishes S Solid Surface See Poet Solid Surface Finishes see top surface for pricing	WF Wood Foot See Poet Wood Foot Finishes MF Metal Foot See Poet Metal Foot Finishes see foot finish style for pricing	NSP No Surface Power YSP Surface Power (EC31) - add \$420 B Black Power Unit B Black Cord G Graphite Cord - add \$187 W White Power Unit G Graphite Cord - add \$187	NGB No Ganging Brackets YGV Ganging Bracket - add \$50

Description + General Information

Modular Corner Table - Diagonal Grain



- undermount power center available - order EC30 separately

Dimensions	D	W	H	Shipping	
Overall	30 ¾	30 ¾	11 ½	Ctn Wt	50
				Cu Ft	4

Apron Upholstery	
COM Ydg	1
COL Sq Ft	18

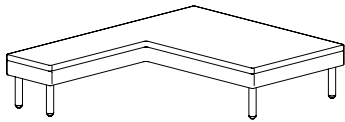
Single Upholstery Specify: Model | Apron Uph | Top Surface | Foot Style | Power | Ganging

PLMCT-D														
	COM	COL	A	B	C	D	E	F	G	H	I	J	L1	L2
Single Uph/Lam	\$1,175	\$1,232	\$1,183	\$1,201	\$1,232	\$1,271	\$1,311	\$1,372	\$1,438	\$1,508	\$1,618	\$1,749	\$1,486	\$1,574
Single Uph/Flat Cut	\$1,456	\$1,513	\$1,464	\$1,482	\$1,513	\$1,552	\$1,592	\$1,653	\$1,719	\$1,789	\$1,899	\$2,030	\$1,767	\$1,855
Single Uph/Dble Cut	\$1,493	\$1,550	\$1,501	\$1,519	\$1,550	\$1,589	\$1,629	\$1,690	\$1,756	\$1,826	\$1,936	\$2,067	\$1,804	\$1,892
Single Uph/Solid Surf	\$3,220	\$3,277	\$3,228	\$3,246	\$3,277	\$3,316	\$3,356	\$3,417	\$3,483	\$3,553	\$3,663	\$3,794	\$3,531	\$3,619

Model	Upholstery	Top Surface	Foot Style	Power	Ganging
	Grade Vendor Pattern Colorway	T Laminate See Poet Laminate Finishes V Veneer See Poet Veneer Finishes S Solid Surface See Poet Solid Surface Finishes see top surface for pricing	WF Wood Foot See Poet Wood Foot Finishes MF Metal Foot See Poet Metal Foot Finishes see foot finish style for pricing	NSP No Surface Power YSP Surface Power (EC31) - add \$420 B Black Power Unit B Black Cord G Graphite Cord - add \$187 W White Power Unit G Graphite Cord - add \$187	NGB No Ganging Brackets YGV Ganging Bracket - add \$50

Description + General Information

Modular Table Wrap



- undermount power center available - order EC30 separately

Dimensions	D	W	H	Shipping	
Overall	44 ¾"	55 ¾"	11 ½"	Ctn Wt	90
				Cu Ft	10

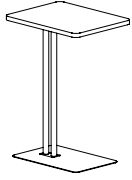
Apron Upholstery	
COM Ydg	1 ¼"
COL Sq Ft	23

Single Upholstery Specify: Model | Apron Uph | Top Surface | Foot Style | Power | Ganging

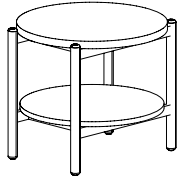
	COM	COL	A	B	C	D	E	F	G	H	I	J	L1	L2
Single Uph/Lam	\$1,905	\$1,976	\$1,916	\$1,938	\$1,976	\$2,026	\$2,075	\$2,152	\$2,234	\$2,322	\$2,459	\$2,623	\$2,294	\$2,404
Single Uph/Flat Cut	\$2,308	\$2,379	\$2,319	\$2,341	\$2,379	\$2,429	\$2,478	\$2,555	\$2,637	\$2,725	\$2,862	\$3,026	\$2,697	\$2,807
Single Uph/Dble Cut	\$2,385	\$2,456	\$2,396	\$2,418	\$2,456	\$2,506	\$2,555	\$2,632	\$2,714	\$2,802	\$2,939	\$3,103	\$2,774	\$2,884

Model	Upholstery	Top Surface	Foot Style	Power	Ganging
	Grade Vendor Pattern Colorway	T Laminate See Poet Laminate Finishes V Veneer See Poet Veneer Finishes see top surface for pricing	WF Wood Foot See Poet Wood Foot Finishes MF Metal Foot See Poet Metal Foot Finishes see foot finish style for pricing	NSP No Surface Power YSP Surface Power (EC31) - add \$528 B Black Power Unit B Black Cord G Graphite Cord - add \$196 W White Power Unit W White Cord G Graphite Cord - add \$196	NGB No Ganging Brackets YGV Ganging Bracket - add \$50

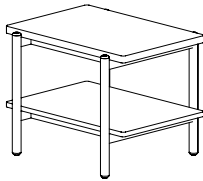
Description	D	W	H	CTN WT	CU FT	① Model	Laminate	Flat Cut Veneer	Double Cut Veneer
Freestanding Pull Up Table	14	18	26 ¼	26	2	PLT26	\$643	\$843	\$848



Round Side Table - Wood Legs	22	22	20	30	7	PLRD20-22W	\$1,131	\$1,489	n/a
-------------------------------------	----	----	----	----	---	-------------------	---------	---------	-----

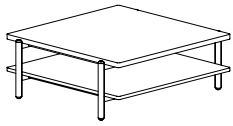


Rectangular Side Table - Wood Legs	26	20 ¾	20	35	8	PLTT20-2026W	\$1,171	\$1,529	n/a
---	----	------	----	----	---	---------------------	---------	---------	-----

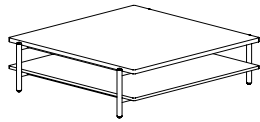


Model	Top Surface
T	Laminate See Poet Laminate Finishes
V	Veneer See Poet Veneer Finishes
	see top surface for pricing

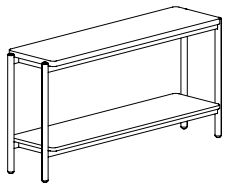
Description	D	W	H	CTN WT	CU FT	① Model	Laminate	Flat Cut Veneer	Double Cut Veneer
Coffee Table - Wood Legs	36	38 7/8	14	80	14	PLTT14-3638W	\$1,305	\$1,747	n/a



Coffee Table - Wood Legs	48	50 7/8	14	135	24	PLTT14-4850W	\$1,563	\$2,090	n/a
---------------------------------	----	--------	----	-----	----	---------------------	---------	---------	-----

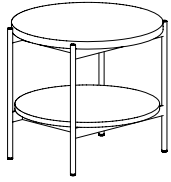


Console Table - Wood Legs	14	54 1/8	27	47	14	PLTT27-1454W	\$1,374	\$1,765	n/a
----------------------------------	----	--------	----	----	----	---------------------	---------	---------	-----

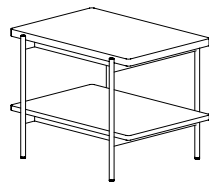


Model	Top Surface	Leg Style
	T Laminate See Poet Laminate Finishes V Veneer See Poet Veneer Finishes see top surface for pricing	ML Metal Leg See Poet Metal Leg Finishes see leg finish style for pricing

Description	D	W	H	CTN WT	CU FT	① Model	Laminate	Flat Cut Veneer	Double Cut Veneer
Round Side Table - Metal Legs	22	22	20	41	7	PLRD20-22M	\$1,556	\$1,914	\$1,935



Rectangular Side Table - Metal Legs	26	19 ½	20	46	8	PLTT20-2026M	\$1,675	\$2,033	\$2,054
--	----	------	----	----	---	---------------------	----------------	----------------	----------------



Model

Top Surface

T Laminate
See Poet Laminate Finishes

V Veneer
See Poet Veneer Finishes

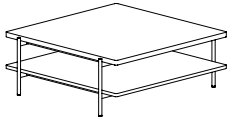
[see top surface for pricing](#)

Leg Style

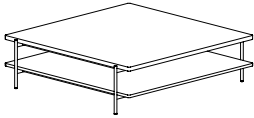
ML Metal Leg
See Poet Metal Leg Finishes

[see leg finish style for pricing](#)

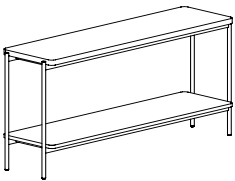
Description	D	W	H	CTN WT	CU FT	① Model	Laminate	Flat Cut Veneer	Double Cut Veneer
Coffee Table - Metal Legs	36	37 ½	14	96	14	PLTT14-3638M	\$1,774	\$2,216	\$2,274



Coffee Table - Metal Legs	48	49 ½	14	148	23	PLTT14-4850M	\$2,189	\$2,716	\$2,818
----------------------------------	----	------	----	-----	----	---------------------	---------	---------	---------

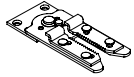


Console Table - Metal Legs	14	52 ¾	27	57	14	PLTT27-1454M	\$2,028	\$2,419	\$2,451
-----------------------------------	----	------	----	----	----	---------------------	---------	---------	---------



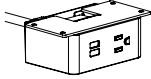
Model	Top Surface	Leg Style
	T Laminate See Poet Laminate Finishes V Veneer See Poet Veneer Finishes see top surface for pricing	ML Metal Leg See Poet Metal Leg Finishes see leg finish style for pricing

Description	D	W	H	CTN WT	CU FT	① Model	List Price
Linking Brackets						GP-LINK	\$50



- links two modular units
- set of 2 with attachment hardware
- field installed

Power Center - Under Mount						EC30	\$363
-----------------------------------	--	--	--	--	--	-------------	--------------



- front frame mount - field installed
- simplex receptacle and two USB/10' - three prong plug power cord
- 10' cord
- specify black or white - cord color will match unit
- optional graphite fabric cord available, specify and add \$187 list
- overall mounting bracket tabs: 5"w

To Order, Specify:
 ① Model number

Protocol Order Check List:



Specify:

- 1. Model Number
- 2. Wood Species - Maple (M)
- 3. Arm Wood Cap/Crown Finish
- 4. Fabric Selection - vendor, pattern and color
- 5. Optional Aluminum Base (A) - add \$116 list, or Optional Wood Base (W) - add \$111 list
- 6. Optional Premium Polished Trim Grey Dual Wheel Soft Urethane Caster - add \$366 list
- 7. Optional Mid-Pivot Mechanism Upgrade - add \$148 list (swivel tilt models only)
- 8. Optional Seat Depth Slide - add \$44 (synchro tilt models only)
- 9. Optional Conference Preset Height Cylinder - add \$31 list (swivel tilt chair models only)
- 10. Optional T Arm Wood Cap - add \$49 list (adjustable T arm models only)
- 11. Optional Aluminum Cantilever Arm - Black Cap - add \$127 list, Grey Cap - add \$157 list (cantilever arm models only)

Example:

PT5600 (model #)	M (wood species)	HRV (finish) arm wood cap/crown	MOMENTUM (fabric vendor)	VOX (pattern name)	MYSTIC (pattern color)
----------------------------	----------------------------	--	------------------------------------	------------------------------	----------------------------------

1. Model Number

2. Wood Species - Maple (M)

3. Arm Wood Cap/Crown Finish Options

ALM Ale Medium	HRV Harvest
CAL Ale Light Coordinate	CKC Khaki Coordinate
BBM Bourbon Medium	MINC Mineral Coordinate
CBZ Brazilwood Coordinate	MCH Mocha
BARC Barrel Coordinate	CPI Pinnacle Walnut Coordinate
CBO Bourbon Light Coordinate	PRL Praline
CBG Brighton Light Coordinate	RAVC Raven Coordinate
BRM Brighton Medium	SABC Sable Coordinate
BUT Butterscotch	SIE Sienna
CNDC Cinder Coordinate	CST Studio Teak Coordinate
CLA Classic	TRF Truffle
CLL Collectors	UMB Umber
EGRC Egret Coordinate	VALC Valley Coordinate
ESP Espresso	VEN Venetian
FAWC Fawn Coordinate	CWE Weathered Ash Coordinate
FLXC Flax	
CGR Graphite Coordinate	

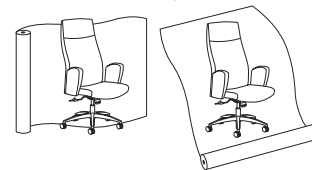
All COM orders must include the following:

- Vendor's name, pattern name and color
- Sample of the fabric attached to order
- Model numbers of items for fabric application
- Special application instructions (e.g., all stripes will be applied front to back unless specified otherwise)
- Customer and purchase order number

Ship prepaid COM material to:

JSI
Attn: COM Dept
201 East Martin Street
Receiving B, Dock 71
Orleans, IN 47452

Application of fabric:
Railroaded Up the Roll



All COM orders will ship at standard lead time from receipt of COM except for orders requiring special custom matched finishes.

4. Fabric Selection - Please supply the following:

Fabric vendor/Pattern name/Pattern color

For a complete list of JSI Standard and Graded-In Textiles click here

When specifying contrasting upholstery, indicate clearly which upholstery is to be applied to the seat, back and arms. Use higher grade pricing.

- Indicate direction of fabric - Railroaded or Up the Roll
- Please provide illustration, if available

5. Optional Aluminum Base (A) or Wood Base (W) - add \$116 list



10. Optional T Arm Wood Cap - add \$49 list
(adjustable T arm models only)



6. Optional Premium Polished Trim Grey Dual Wheel Soft Urethane Caster - add \$366 list.



11. Optional Aluminum Cantilever Arm - Black Cap - add \$127 list,
or Grey Cap - add \$157 list
(cantilever arm models only)







7. Optional Mid-Pivot Mechanism Upgrade - add \$148 list
(swivel tilt models only)

8. Optional Seat Depth Slide - add \$44 list
(synchro models only)

9. Optional Conference Preset Height Cylinder - add \$31 list
(swivel tilt chair models only)



Description	① Model	Specifications	List Price Per Grade																
Management Mid Back 	PT5600 · swivel tilt/fixed back · armless · polyurethane base · overall height range is 41 ½ - 47 · seat height range is 17 ½ - 22 ½	<table border="1"> <thead> <tr> <th>Dimensions</th> <th>D</th> <th>W</th> <th>H</th> </tr> </thead> <tbody> <tr> <td>Overall</td> <td>26</td> <td>26</td> <td>47</td> </tr> <tr> <td>Seat</td> <td>19 ¼</td> <td>19 ¼</td> <td>22 ½</td> </tr> </tbody> </table>	Dimensions	D	W	H	Overall	26	26	47	Seat	19 ¼	19 ¼	22 ½	COM \$1,633 A \$1,660 B \$1,711 COL/C \$1,807 D \$1,921 E \$2,041 F \$2,168 G \$2,345 H \$2,535 I \$2,828 J \$3,186 L1 \$2,378 L2 \$2,569				
		Dimensions	D	W	H														
Overall	26	26	47																
Seat	19 ¼	19 ¼	22 ½																
<table border="1"> <thead> <tr> <th>Upholstery</th> <th colspan="3">Shipping</th> </tr> </thead> <tbody> <tr> <td>COM Ydg</td> <td>2 ¼</td> <td>Ctn Wt</td> <td>58</td> </tr> <tr> <td>COL Sq Ft</td> <td>41</td> <td>Cu Ft</td> <td>18</td> </tr> </tbody> </table>	Upholstery	Shipping			COM Ydg	2 ¼	Ctn Wt	58	COL Sq Ft	41	Cu Ft	18							
Upholstery	Shipping																		
COM Ydg	2 ¼	Ctn Wt	58																
COL Sq Ft	41	Cu Ft	18																
Mid Back 	PT5600L · swivel tilt/fixed back · black urethane loop arms · black polyurethane base · overall height range is 41 ½ - 47 · seat height range is 17 ½ - 22 ½ · arm height range is 26 ⅝ - 31 ⅞	<table border="1"> <thead> <tr> <th>Dimensions</th> <th>D</th> <th>W</th> <th>H</th> </tr> </thead> <tbody> <tr> <td>Overall</td> <td>26</td> <td>26</td> <td>47</td> </tr> <tr> <td>Seat</td> <td>19 ¼</td> <td>19 ¼</td> <td>22 ½</td> </tr> <tr> <td>Arm</td> <td></td> <td></td> <td>31 ⅞</td> </tr> </tbody> </table>	Dimensions	D	W	H	Overall	26	26	47	Seat	19 ¼	19 ¼	22 ½	Arm			31 ⅞	COM \$1,817 A \$1,845 B \$1,897 COL/C \$1,990 D \$2,107 E \$2,226 F \$2,352 G \$2,528 H \$2,718 I \$3,016 J \$3,373 L1 \$2,564 L2 \$2,754
		Dimensions	D	W	H														
Overall	26	26	47																
Seat	19 ¼	19 ¼	22 ½																
Arm			31 ⅞																
<table border="1"> <thead> <tr> <th>Upholstery</th> <th colspan="3">Shipping</th> </tr> </thead> <tbody> <tr> <td>COM Ydg</td> <td>2 ¼</td> <td>Ctn Wt</td> <td>64</td> </tr> <tr> <td>COL Sq Ft</td> <td>41</td> <td>Cu Ft</td> <td>18</td> </tr> </tbody> </table>	Upholstery	Shipping			COM Ydg	2 ¼	Ctn Wt	64	COL Sq Ft	41	Cu Ft	18							
Upholstery	Shipping																		
COM Ydg	2 ¼	Ctn Wt	64																
COL Sq Ft	41	Cu Ft	18																
Mid Back 	PT5600S · swivel tilt/fixed back · adjustable black urethane T arm · arm post matches base color · black polyurethane base · overall height range is 41 ½ - 47 · seat height range is 17 ½ - 22 ½ · arm height range is 25 ½ - 31	<table border="1"> <thead> <tr> <th>Dimensions</th> <th>D</th> <th>W</th> <th>H</th> </tr> </thead> <tbody> <tr> <td>Overall</td> <td>26</td> <td>26</td> <td>47</td> </tr> <tr> <td>Seat</td> <td>19 ¼</td> <td>19 ¼</td> <td>22 ½</td> </tr> <tr> <td>Arm</td> <td></td> <td></td> <td>31</td> </tr> </tbody> </table>	Dimensions	D	W	H	Overall	26	26	47	Seat	19 ¼	19 ¼	22 ½	Arm			31	COM \$1,915 A \$1,942 B \$1,995 COL/C \$2,087 D \$2,203 E \$2,323 F \$2,450 G \$2,627 H \$2,816 I \$3,113 J \$3,468 L1 \$2,662 L2 \$2,851
		Dimensions	D	W	H														
Overall	26	26	47																
Seat	19 ¼	19 ¼	22 ½																
Arm			31																
<table border="1"> <thead> <tr> <th>Upholstery</th> <th colspan="3">Shipping</th> </tr> </thead> <tbody> <tr> <td>COM Ydg</td> <td>2 ¼</td> <td>Ctn Wt</td> <td>65</td> </tr> <tr> <td>COL Sq Ft</td> <td>41</td> <td>Cu Ft</td> <td>18</td> </tr> </tbody> </table>	Upholstery	Shipping			COM Ydg	2 ¼	Ctn Wt	65	COL Sq Ft	41	Cu Ft	18							
Upholstery	Shipping																		
COM Ydg	2 ¼	Ctn Wt	65																
COL Sq Ft	41	Cu Ft	18																
Management Mid Back 	PT5600T · swivel tilt/fixed back · adjustable urethane T arm · polyurethane base · arm post matches base color · overall height range is 41 ½ - 47 · seat height range is 17 ½ - 22 ½ · arm height range is 25 ½ - 31	<table border="1"> <thead> <tr> <th>Dimensions</th> <th>D</th> <th>W</th> <th>H</th> </tr> </thead> <tbody> <tr> <td>Overall</td> <td>26</td> <td>26</td> <td>47</td> </tr> <tr> <td>Seat</td> <td>19 ¼</td> <td>19 ¼</td> <td>22 ½</td> </tr> <tr> <td>Arm</td> <td></td> <td></td> <td>31</td> </tr> </tbody> </table>	Dimensions	D	W	H	Overall	26	26	47	Seat	19 ¼	19 ¼	22 ½	Arm			31	COM \$1,915 A \$1,942 B \$1,995 COL/C \$2,087 D \$2,203 E \$2,323 F \$2,450 G \$2,627 H \$2,816 I \$3,113 J \$3,468 L1 \$2,662 L2 \$2,851
		Dimensions	D	W	H														
Overall	26	26	47																
Seat	19 ¼	19 ¼	22 ½																
Arm			31																
<table border="1"> <thead> <tr> <th>Upholstery</th> <th colspan="3">Shipping</th> </tr> </thead> <tbody> <tr> <td>COM Ydg</td> <td>2 ¼</td> <td>Ctn Wt</td> <td>65</td> </tr> <tr> <td>COL Sq Ft</td> <td>41</td> <td>Cu Ft</td> <td>18</td> </tr> </tbody> </table>	Upholstery	Shipping			COM Ydg	2 ¼	Ctn Wt	65	COL Sq Ft	41	Cu Ft	18							
Upholstery	Shipping																		
COM Ydg	2 ¼	Ctn Wt	65																
COL Sq Ft	41	Cu Ft	18																

PROTOCOL

Description

1 Model

Specifications

List Price Per Grade

Mid Back



PT5600C

- swivel tilt/fixed back
- black urethane cantilever arm
- black polyurethane base
- overall height range is 41 ½ - 47
- seat height range is 17 ½ - 22 ½
- arm height range is 26 ½ - 31 ⅜

Dimensions	D	W	H
Overall	26	26	47
Seat	19 ¼	19 ¼	22 ½
Arm			31 ⅜
Upholstery		Shipping	
COM Ydg	2 ¼	Ctn Wt	64
COL Sq Ft	41	Cu Ft	18

COM	\$1,861
A	\$1,890
B	\$1,942
COL/C	\$2,034
D	\$2,151
E	\$2,270
F	\$2,398
G	\$2,574
H	\$2,763
I	\$3,060
J	\$3,418
L1	\$2,609
L2	\$2,798

Management Mid Back



PT5600U

- swivel tilt/fixed back
- fixed height upholstered arm
- polyurethane base
- overall height range is 41 ½ - 47
- seat height range is 17 ½ - 22 ½
- arm height range is 27 - 32 ½

Dimensions	D	W	H
Overall	26	26	47
Seat	19 ¼	19 ¼	22 ½
Arm			32 ½
Upholstery		Shipping	
COM Ydg	3 ⅝	Ctn Wt	64
COL Sq Ft	57	Cu Ft	18





COM	\$1,944
A	\$1,980
B	\$2,054
COL/C	\$2,182
D	\$2,347
E	\$2,513
F	\$2,685
G	\$2,933
H	\$3,197
I	\$3,608
J	\$4,103
L1	\$2,984
L2	\$3,247

To Order, Specify:


- 1 Model Number
- 2 Wood Species - Maple (M)
- 3 Arm Wood Cap Finish
- 4 Fabric Selection - vendor, pattern and color
Visit www.jsifurniture.com/finishes-and-materials/textiles for our textiles program.
See selection of standard and graded in manufacturers and patterns.
- 5 Optional Aluminum (A) or Wood Base (W)- add \$116 list
- 6 Optional Premium Polished Trim Grey Dual Wheel Soft Urethane Casters - add \$366
- 7 Optional Mid-Pivot Mechanism Upgrade - add \$148 list
(swivel tilt models only)
- 8 Optional Seat Depth Slide - add \$44 list
(synchro tilt models only)
- 9 Optional Conference Preset Height Cylinder - add \$31 list
(swivel tilt chair models only)
- 10 Optional T Arm Wood Cap - add \$49 list
(adjustable T arm models only)
Optional Aluminum Cantilever Arm - Black Cap - add \$127 list,
Grey Cap - add \$157 list
(cantilever arm models only)


Specifications

- Wood species - Maple.
- Two piece molded plywood seat and back.
- Seat has 3 ½" high density polyurethane foam.
- Back has 2" to 1" tapered high density polyurethane foam with ¼" overlay.
- Swivel tilt models are standard with tilt, lock, pneumatic lift, tension adjustment.
- Synchro models are standard with synchronized independent seat and back recline, lock pneumatic lift, tensions adjustment, 6 positions, 2 ½" back height adjustment.
- Polyurethane base, glass reinforced nylon/5 prong/grip ring caster insertion.
- All models standard with 60 mm dual wheel non-hooded black nylon plastic casters.

Description	① Model	Specifications	List Price Per Grade																
Management Mid Back 	PT5650 · solid maple crown · swivel tilt/ fixed back · armless · polyurethane base · overall height range is 41 ½ - 47 · seat height range is 17 ½ - 22 ½	<table border="1"> <thead> <tr> <th>Dimensions</th> <th>D</th> <th>W</th> <th>H</th> </tr> </thead> <tbody> <tr> <td>Overall</td> <td>26</td> <td>26</td> <td>47</td> </tr> <tr> <td>Seat</td> <td>19 ¼</td> <td>19 ¼</td> <td>22 ½</td> </tr> </tbody> </table>	Dimensions	D	W	H	Overall	26	26	47	Seat	19 ¼	19 ¼	22 ½	COM \$1,821 A \$1,849 B \$1,897 COL/C \$1,984 D \$2,096 E \$2,207 F \$2,327 G \$2,493 H \$2,675 I \$2,954 J \$3,290 L1 \$2,528 L2 \$2,710				
		Dimensions	D	W	H														
Overall	26	26	47																
Seat	19 ¼	19 ¼	22 ½																
<table border="1"> <thead> <tr> <th>Upholstery</th> <th colspan="3">Shipping</th> </tr> </thead> <tbody> <tr> <td>COM Ydg</td> <td>2 ⅛</td> <td>Ctn Wt</td> <td>59</td> </tr> <tr> <td>COL Sq Ft</td> <td>39</td> <td>Cu Ft</td> <td>18</td> </tr> </tbody> </table>	Upholstery	Shipping			COM Ydg	2 ⅛	Ctn Wt	59	COL Sq Ft	39	Cu Ft	18							
Upholstery	Shipping																		
COM Ydg	2 ⅛	Ctn Wt	59																
COL Sq Ft	39	Cu Ft	18																
Mid Back - Wood Crown 	PT5650L · solid maple crown · swivel tilt/ fixed back · black urethane loop arms · black polyurethane base · overall height range is 41 ½ - 47 · seat height range is 17 ½ - 22 ½ · arm height range is 26 ⅝ - 31 ⅞	<table border="1"> <thead> <tr> <th>Dimensions</th> <th>D</th> <th>W</th> <th>H</th> </tr> </thead> <tbody> <tr> <td>Overall</td> <td>26</td> <td>26</td> <td>47</td> </tr> <tr> <td>Seat</td> <td>19 ¼</td> <td>19 ¼</td> <td>22 ½</td> </tr> <tr> <td>Arm</td> <td></td> <td></td> <td>31 ⅞</td> </tr> </tbody> </table>	Dimensions	D	W	H	Overall	26	26	47	Seat	19 ¼	19 ¼	22 ½	Arm			31 ⅞	COM \$2,001 A \$2,028 B \$2,076 COL/C \$2,164 D \$2,276 E \$2,388 F \$2,505 G \$2,674 H \$2,854 I \$3,133 J \$3,468 L1 \$2,709 L2 \$2,888
		Dimensions	D	W	H														
Overall	26	26	47																
Seat	19 ¼	19 ¼	22 ½																
Arm			31 ⅞																
<table border="1"> <thead> <tr> <th>Upholstery</th> <th colspan="3">Shipping</th> </tr> </thead> <tbody> <tr> <td>COM Ydg</td> <td>2 ⅛</td> <td>Ctn Wt</td> <td>67</td> </tr> <tr> <td>COL Sq Ft</td> <td>39</td> <td>Cu Ft</td> <td>18</td> </tr> </tbody> </table>	Upholstery	Shipping			COM Ydg	2 ⅛	Ctn Wt	67	COL Sq Ft	39	Cu Ft	18							
Upholstery	Shipping																		
COM Ydg	2 ⅛	Ctn Wt	67																
COL Sq Ft	39	Cu Ft	18																
Mid Back - Wood Crown 	PT5650S · solid maple crown · swivel tilt/ fixed back · adjustable black urethane T arm · arm post matches base color · black polyurethane base · overall height range is 41 ½ - 47 · seat height range is 17 ½ - 22 ½ · arm height range is 25 ½ - 31	<table border="1"> <thead> <tr> <th>Dimensions</th> <th>D</th> <th>W</th> <th>H</th> </tr> </thead> <tbody> <tr> <td>Overall</td> <td>26</td> <td>26</td> <td>47</td> </tr> <tr> <td>Seat</td> <td>19 ¼</td> <td>19 ¼</td> <td>22 ½</td> </tr> <tr> <td>Arm</td> <td></td> <td></td> <td>31</td> </tr> </tbody> </table>	Dimensions	D	W	H	Overall	26	26	47	Seat	19 ¼	19 ¼	22 ½	Arm			31	COM \$2,097 A \$2,122 B \$2,175 COL/C \$2,262 D \$2,373 E \$2,485 F \$2,603 G \$2,771 H \$2,950 I \$3,230 J \$3,566 L1 \$2,804 L2 \$2,985
		Dimensions	D	W	H														
Overall	26	26	47																
Seat	19 ¼	19 ¼	22 ½																
Arm			31																
<table border="1"> <thead> <tr> <th>Upholstery</th> <th colspan="3">Shipping</th> </tr> </thead> <tbody> <tr> <td>COM Ydg</td> <td>2 ⅛</td> <td>Ctn Wt</td> <td>68</td> </tr> <tr> <td>COL Sq Ft</td> <td>39</td> <td>Cu Ft</td> <td>18</td> </tr> </tbody> </table>	Upholstery	Shipping			COM Ydg	2 ⅛	Ctn Wt	68	COL Sq Ft	39	Cu Ft	18							
Upholstery	Shipping																		
COM Ydg	2 ⅛	Ctn Wt	68																
COL Sq Ft	39	Cu Ft	18																
Management Mid Back 	PT5650T · solid maple crown · swivel tilt/ fixed back · adjustable urethane T arm · polyurethane base · arm post matches base color · overall height range is 41 ½ - 47 · seat height range is 17 ½ - 22 ½ · arm height range is 25 ½ - 31	<table border="1"> <thead> <tr> <th>Dimensions</th> <th>D</th> <th>W</th> <th>H</th> </tr> </thead> <tbody> <tr> <td>Overall</td> <td>26</td> <td>26</td> <td>47</td> </tr> <tr> <td>Seat</td> <td>19 ¼</td> <td>19 ¼</td> <td>22 ½</td> </tr> <tr> <td>Arm</td> <td></td> <td></td> <td>31</td> </tr> </tbody> </table>	Dimensions	D	W	H	Overall	26	26	47	Seat	19 ¼	19 ¼	22 ½	Arm			31	COM \$2,097 A \$2,122 B \$2,175 COL/C \$2,262 D \$2,373 E \$2,485 F \$2,603 G \$2,771 H \$2,950 I \$3,230 J \$3,566 L1 \$2,804 L2 \$2,985
		Dimensions	D	W	H														
Overall	26	26	47																
Seat	19 ¼	19 ¼	22 ½																
Arm			31																
<table border="1"> <thead> <tr> <th>Upholstery</th> <th colspan="3">Shipping</th> </tr> </thead> <tbody> <tr> <td>COM Ydg</td> <td>2 ⅛</td> <td>Ctn Wt</td> <td>68</td> </tr> <tr> <td>COL Sq Ft</td> <td>39</td> <td>Cu Ft</td> <td>18</td> </tr> </tbody> </table>	Upholstery	Shipping			COM Ydg	2 ⅛	Ctn Wt	68	COL Sq Ft	39	Cu Ft	18							
Upholstery	Shipping																		
COM Ydg	2 ⅛	Ctn Wt	68																
COL Sq Ft	39	Cu Ft	18																

PROTOCOL

Description	Model	Specifications			List Price Per Grade	
Mid Back - Wood Crown 	PT5650C • solid maple crown • swivel tilt/fixed back • black urethane cantilever arm • black polyurethane base • overall height range is 41 ½ - 47 • seat height range is 17 ½ - 22 ½ • arm height range is 26 ½ - 31 ¾	Dimensions	D	W	H	COM \$2,044
		Overall	26	26	47	A \$2,071
		Seat	19 ¼	19 ¼	22 ½	B \$2,120
		Arm			31 ¾	COL/C \$2,207
		Upholstery	Shipping			D \$2,319
		COM Ydg	2 ⅞	Ctn Wt	67	E \$2,432
		COL Sq Ft	39	Cu Ft	18	F \$2,551
						G \$2,717
						H \$2,898
						I \$3,177
				J \$3,512		
				L1 \$2,752		
				L2 \$2,932		

Description	Model	Specifications			List Price Per Grade	
Management Mid Back 	PT5650U • solid maple crown • swivel tilt/fixed back • fixed height upholstered arm • polyurethane base • overall height range is 41 ½ - 47 • seat height range is 17 ½ - 22 ½ • arm height range is 27 - 32 ½	Dimensions	D	W	H	COM \$2,275
		Overall	26	26	47	A \$2,309
		Seat	19 ¼	19 ¼	22 ½	B \$2,378
		Arm			32 ½	COL/C \$2,503
		Upholstery	Shipping			D \$2,662
		COM Ydg	3	Ctn Wt	67	E \$2,818
		COL Sq Ft	54	Cu Ft	18	F \$2,986
						G \$3,223
						H \$3,474
						I \$3,871
				J \$4,346		
				L1 \$3,270		
				L2 \$3,524		

To Order, Specify:

- 1 Model Number
- 2 Wood Species - Maple (M)
- 3 Arm Wood Cap Finish
- 4 Fabric Selection - vendor, pattern and color
Visit www.jsifurniture.com/finishes-and-materials/textiles for our textiles program.
See selection of standard and graded in manufacturers and patterns.
- 5 Optional Aluminum (A) or Wood Base (W)- add \$116 list
- 6 Optional Premium Polished Trim Grey Dual Wheel Soft Urethane Casters - add \$366
- 7 Optional Mid-Pivot Mechanism Upgrade - add \$148 list
(swivel tilt models only)
- 8 Optional Seat Depth Slide - add \$44 list
(synchro tilt models only)
- 9 Optional Conference Preset Height Cylinder - add \$31 list
(swivel tilt chair models only)
- 10 Optional T Arm Wood Cap - add \$49 list
(adjustable T arm models only)
Optional Aluminum Cantilever Arm - Black Cap - add \$127 list,
Grey Cap - add \$157 list
(cantilever arm models only)

Specifications

- Wood species - Maple.
- Two piece molded plywood seat and back.
- Seat has 3 ½" high density polyurethane foam.
- Back has 2" to 1" tapered high density polyurethane foam with ¼" overlay.
- Swivel tilt models are standard with tilt, lock, pneumatic lift, tension adjustment.
- Synchro models are standard with synchronized independent seat and back recline, lock pneumatic lift, tensions adjustment, 6 positions, 2 ½" back height adjustment.
- Polyurethane base, glass reinforced nylon/5 prong/grip ring caster insertion.
- All models standard with 60 mm dual wheel non-hooded black nylon plastic casters.

Description	① Model	Specifications	List Price Per Grade																												
High Back	PT5605L <ul style="list-style-type: none"> · swivel tilt/fixed back · black urethane loop arm · black polyurethane base · overall height range is 46 ½ - 52 · seat height range is 17 ½ - 22 ½ · arm height range is 26 ⅝ - 31 ⅞ 	<table border="1"> <thead> <tr> <th>Dimensions</th> <th>D</th> <th>W</th> <th>H</th> </tr> </thead> <tbody> <tr> <td>Overall</td> <td>26</td> <td>26</td> <td>52</td> </tr> <tr> <td>Seat</td> <td>19 ¼</td> <td>19 ¼</td> <td>22 ½</td> </tr> <tr> <td>Arm</td> <td></td> <td></td> <td>31 ⅞</td> </tr> <tr> <th colspan="2">Upholstery</th> <th colspan="2">Shipping</th> </tr> <tr> <td>COM Ydg</td> <td>2 ½</td> <td>Ctn Wt</td> <td>67</td> </tr> <tr> <td>COL Sq Ft</td> <td>45</td> <td>Cu Ft</td> <td>18</td> </tr> </tbody> </table>	Dimensions	D	W	H	Overall	26	26	52	Seat	19 ¼	19 ¼	22 ½	Arm			31 ⅞	Upholstery		Shipping		COM Ydg	2 ½	Ctn Wt	67	COL Sq Ft	45	Cu Ft	18	COM \$1,914 A \$1,943 B \$2,002 COL/C \$2,105 D \$2,237 E \$2,367 F \$2,505 G \$2,705 H \$2,915 I \$3,246 J \$3,640 L1 \$2,746 L2 \$2,954
		Dimensions	D	W	H																										
Overall	26	26	52																												
Seat	19 ¼	19 ¼	22 ½																												
Arm			31 ⅞																												
Upholstery		Shipping																													
COM Ydg	2 ½	Ctn Wt	67																												
COL Sq Ft	45	Cu Ft	18																												



High Back	PT5605S <ul style="list-style-type: none"> · swivel tilt/fixed back · adjustable black urethane T arm · arm post matches base color · black polyurethane base · overall height range is 46 ½ - 52 · seat height range is 17 ½ - 22 ½ · arm height range is 25 ½ - 31 	<table border="1"> <thead> <tr> <th>Dimensions</th> <th>D</th> <th>W</th> <th>H</th> </tr> </thead> <tbody> <tr> <td>Overall</td> <td>26</td> <td>26</td> <td>52</td> </tr> <tr> <td>Seat</td> <td>19 ¼</td> <td>19 ¼</td> <td>22 ½</td> </tr> <tr> <td>Arm</td> <td></td> <td></td> <td>31</td> </tr> <tr> <th colspan="2">Upholstery</th> <th colspan="2">Shipping</th> </tr> <tr> <td>COM Ydg</td> <td>2 ½</td> <td>Ctn Wt</td> <td>68</td> </tr> <tr> <td>COL Sq Ft</td> <td>45</td> <td>Cu Ft</td> <td>18</td> </tr> </tbody> </table>	Dimensions	D	W	H	Overall	26	26	52	Seat	19 ¼	19 ¼	22 ½	Arm			31	Upholstery		Shipping		COM Ydg	2 ½	Ctn Wt	68	COL Sq Ft	45	Cu Ft	18	COM \$2,008 A \$2,040 B \$2,100 COL/C \$2,201 D \$2,333 E \$2,463 F \$2,603 G \$2,801 H \$3,012 I \$3,343 J \$3,737 L1 \$2,842 L2 \$3,052
		Dimensions	D	W	H																										
Overall	26	26	52																												
Seat	19 ¼	19 ¼	22 ½																												
Arm			31																												
Upholstery		Shipping																													
COM Ydg	2 ½	Ctn Wt	68																												
COL Sq Ft	45	Cu Ft	18																												



Executive High Back	PT5605T <ul style="list-style-type: none"> · swivel tilt/fixed back · adjustable urethane T arm · polyurethane base · arm post matches base color · overall height range is 46 ½ - 52 · seat height range is 17 ½ - 22 ½ · arm height range is 25 ½ - 31 	<table border="1"> <thead> <tr> <th>Dimensions</th> <th>D</th> <th>W</th> <th>H</th> </tr> </thead> <tbody> <tr> <td>Overall</td> <td>26</td> <td>26</td> <td>52</td> </tr> <tr> <td>Seat</td> <td>19 ¼</td> <td>19 ¼</td> <td>22 ½</td> </tr> <tr> <td>Arm</td> <td></td> <td></td> <td>31</td> </tr> <tr> <th colspan="2">Upholstery</th> <th colspan="2">Shipping</th> </tr> <tr> <td>COM Ydg</td> <td>2 ½</td> <td>Ctn Wt</td> <td>68</td> </tr> <tr> <td>COL Sq Ft</td> <td>45</td> <td>Cu Ft</td> <td>18</td> </tr> </tbody> </table>	Dimensions	D	W	H	Overall	26	26	52	Seat	19 ¼	19 ¼	22 ½	Arm			31	Upholstery		Shipping		COM Ydg	2 ½	Ctn Wt	68	COL Sq Ft	45	Cu Ft	18	COM \$2,008 A \$2,040 B \$2,100 COL/C \$2,201 D \$2,333 E \$2,463 F \$2,603 G \$2,801 H \$3,012 I \$3,343 J \$3,737 L1 \$2,842 L2 \$3,052
		Dimensions	D	W	H																										
Overall	26	26	52																												
Seat	19 ¼	19 ¼	22 ½																												
Arm			31																												
Upholstery		Shipping																													
COM Ydg	2 ½	Ctn Wt	68																												
COL Sq Ft	45	Cu Ft	18																												



PROTOCOL

Description

1 Model

Specifications

List Price Per Grade

High Back



PT5605C

- swivel tilt/fixed back
- black urethane cantilever arm
- black polyurethane base
- overall height range is 46 ½ - 52
- seat height range is 17 ½ - 22 ½
- arm height range is 26 ½ - 31 ⅜

Dimensions	D	W	H
Overall	26	26	52
Seat	19 ¼	19 ¼	22 ½
Arm			31 ⅜
Upholstery		Shipping	
COM Ydg	2 ½	Ctn Wt	67
COL Sq Ft	45	Cu Ft	18

COM	\$1,957
A	\$1,988
B	\$2,046
COL/C	\$2,148
D	\$2,280
E	\$2,412
F	\$2,551
G	\$2,750
H	\$2,961
I	\$3,289
J	\$3,684
L1	\$2,790
L2	\$2,999

Executive High Back



PT5605U

- swivel tilt/fixed back
- upholstered arm
- polyurethane base
- overall height range is 46 ½ - 52
- seat height range is 17 ½ - 22 ½
- arm height range is 27 - 32 ½

Dimensions	D	W	H
Overall	26	26	52
Seat	19 ¼	19 ¼	22 ½
Arm			32 ½
Upholstery		Shipping	
COM Ydg	3 ¼	Ctn Wt	67
COL Sq Ft	59	Cu Ft	18




COM	\$2,193
A	\$2,233
B	\$2,308
COL/C	\$2,442
D	\$2,612
E	\$2,783
F	\$2,964
G	\$3,222
H	\$3,496
I	\$3,925
J	\$4,437
L1	\$3,272
L2	\$3,546


To Order, Specify:


- 1 Model Number
- 2 Wood Species - Maple (M)
- 3 Arm Wood Cap Finish
- 4 Fabric Selection - vendor, pattern and color
Visit www.jsifurniture.com/finishes-and-materials/textiles for our textiles program.
See selection of standard and graded in manufacturers and patterns.
- 5 Optional Aluminum (A) or Wood Base (W)- add \$116 list
- 6 Optional Premium Polished Trim Grey Dual Wheel Soft Urethane Casters - add \$366
- 7 Optional Mid-Pivot Mechanism Upgrade - add \$148 list
(swivel tilt models only)
- 8 Optional Seat Depth Slide - add \$44 list
(synchro tilt models only)
- 9 Optional Conference Preset Height Cylinder - add \$31 list
(swivel tilt chair models only)
- 10 Optional T Arm Wood Cap - add \$49 list
(adjustable T arm models only)
Optional Aluminum Cantilever Arm - Black Cap - add \$127 list,
Grey Cap - add \$157 list
(cantilever arm models only)

Specifications

- Wood species - Maple.
- Two piece molded plywood seat and back.
- Seat has 3 ½" high density polyurethane foam.
- Back has 2" to 1" tapered high density polyurethane foam with ¼" overlay.
- Swivel tilt models are standard with tilt, lock, pneumatic lift, tension adjustment.
- Synchro models are standard with synchronized independent seat and back recline, lock pneumatic lift, tensions adjustment, 6 positions, 2 ½" back height adjustment.
- Polyurethane base, glass reinforced nylon/5 prong/grip ring caster insertion.
- All models standard with 60 mm dual wheel non-hooded black nylon plastic casters.

Description	① Model	Specifications	List Price Per Grade																
High Back - Wood Crown 	PT5655L · solid maple crown · swivel tilt/fixed back · black urethane loop arm · black polyurethane base · overall height range is 46½ - 52 · seat height range is 17½ - 22½ · arm height range is 26⅝ - 31⅞	<table border="1"> <thead> <tr> <th>Dimensions</th> <th>D</th> <th>W</th> <th>H</th> </tr> </thead> <tbody> <tr> <td>Overall</td> <td>26</td> <td>26</td> <td>52</td> </tr> <tr> <td>Seat</td> <td>19¼</td> <td>19¼</td> <td>22½</td> </tr> <tr> <td>Arm</td> <td></td> <td></td> <td>31⅞</td> </tr> </tbody> </table>	Dimensions	D	W	H	Overall	26	26	52	Seat	19¼	19¼	22½	Arm			31⅞	COM \$2,113 A \$2,142 B \$2,203 COL/C \$2,305 D \$2,437 E \$2,567 F \$2,706 G \$2,903 H \$3,115 I \$3,446 J \$3,840 L1 \$2,945 L2 \$3,155
		Dimensions	D	W	H														
Overall	26	26	52																
Seat	19¼	19¼	22½																
Arm			31⅞																
<table border="1"> <thead> <tr> <th>Upholstery</th> <th colspan="3">Shipping</th> </tr> </thead> <tbody> <tr> <td>COM Ydg</td> <td>2½</td> <td>Ctn Wt</td> <td>68</td> </tr> <tr> <td>COL Sq Ft</td> <td>45</td> <td>Cu Ft</td> <td>18</td> </tr> </tbody> </table>	Upholstery	Shipping			COM Ydg	2½	Ctn Wt	68	COL Sq Ft	45	Cu Ft	18							
Upholstery	Shipping																		
COM Ydg	2½	Ctn Wt	68																
COL Sq Ft	45	Cu Ft	18																
High Back - Wood Crown 	PT5655S · solid maple crown · swivel tilt/fixed back · adjustable black urethane T arm · arm post matches base color · black polyurethane base · overall height range is 46½ - 52 · seat height range is 17½ - 22½ · arm height range is 25½ - 31	<table border="1"> <thead> <tr> <th>Dimensions</th> <th>D</th> <th>W</th> <th>H</th> </tr> </thead> <tbody> <tr> <td>Overall</td> <td>26</td> <td>26</td> <td>52</td> </tr> <tr> <td>Seat</td> <td>19¼</td> <td>19¼</td> <td>22½</td> </tr> <tr> <td>Arm</td> <td></td> <td></td> <td>31</td> </tr> </tbody> </table>	Dimensions	D	W	H	Overall	26	26	52	Seat	19¼	19¼	22½	Arm			31	COM \$2,211 A \$2,239 B \$2,302 COL/C \$2,401 D \$2,534 E \$2,664 F \$2,803 G \$3,000 H \$3,212 I \$3,541 J \$3,935 L1 \$3,041 L2 \$3,251
		Dimensions	D	W	H														
Overall	26	26	52																
Seat	19¼	19¼	22½																
Arm			31																
<table border="1"> <thead> <tr> <th>Upholstery</th> <th colspan="3">Shipping</th> </tr> </thead> <tbody> <tr> <td>COM Ydg</td> <td>2½</td> <td>Ctn Wt</td> <td>69</td> </tr> <tr> <td>COL Sq Ft</td> <td>45</td> <td>Cu Ft</td> <td>18</td> </tr> </tbody> </table>	Upholstery	Shipping			COM Ydg	2½	Ctn Wt	69	COL Sq Ft	45	Cu Ft	18							
Upholstery	Shipping																		
COM Ydg	2½	Ctn Wt	69																
COL Sq Ft	45	Cu Ft	18																
Executive High Back 	PT5655T · solid maple crown · swivel tilt/fixed back · adjustable urethane T arm · polyurethane base · arm post matches base color · overall height range is 46½ - 52 · seat height range is 17½ - 22½ · arm height range is 25½ - 31	<table border="1"> <thead> <tr> <th>Dimensions</th> <th>D</th> <th>W</th> <th>H</th> </tr> </thead> <tbody> <tr> <td>Overall</td> <td>26</td> <td>26</td> <td>52</td> </tr> <tr> <td>Seat</td> <td>19¼</td> <td>19¼</td> <td>22½</td> </tr> <tr> <td>Arm</td> <td></td> <td></td> <td>31</td> </tr> </tbody> </table>	Dimensions	D	W	H	Overall	26	26	52	Seat	19¼	19¼	22½	Arm			31	COM \$2,211 A \$2,239 B \$2,302 COL/C \$2,401 D \$2,534 E \$2,664 F \$2,803 G \$3,000 H \$3,212 I \$3,541 J \$3,935 L1 \$3,041 L2 \$3,251
		Dimensions	D	W	H														
Overall	26	26	52																
Seat	19¼	19¼	22½																
Arm			31																
<table border="1"> <thead> <tr> <th>Upholstery</th> <th colspan="3">Shipping</th> </tr> </thead> <tbody> <tr> <td>COM Ydg</td> <td>2½</td> <td>Ctn Wt</td> <td>69</td> </tr> <tr> <td>COL Sq Ft</td> <td>45</td> <td>Cu Ft</td> <td>18</td> </tr> </tbody> </table>	Upholstery	Shipping			COM Ydg	2½	Ctn Wt	69	COL Sq Ft	45	Cu Ft	18							
Upholstery	Shipping																		
COM Ydg	2½	Ctn Wt	69																
COL Sq Ft	45	Cu Ft	18																

Description	① Model	Specifications			List Price Per Grade	
High Back - Wood Crown 	PT5655C • solid maple crown • swivel tilt/fixed back • black urethane cantilever arm • black polyurethane base • overall height range is 46 ½ - 52 • seat height range is 17 ½ - 22 ½ • arm height range is 26 ½ - 31 ¾	Dimensions	D	W	H	COM \$2,157
		Overall	26	26	52	A \$2,185
		Seat	19 ¼	19 ¼	22 ½	B \$2,247
		Arm			31 ¾	COL/C \$2,349
		Upholstery	Shipping			D \$2,481
		COM Ydg	2 ½	Ctn Wt	68	E \$2,611
		COL Sq Ft	45	Cu Ft	18	F \$2,751
						G \$2,948
						H \$3,161
						I \$3,489
				J \$3,884		
				L1 \$2,988		
				L2 \$3,200		





Description	① Model	Specifications			List Price Per Grade	
Executive High Back 	PT5655U • solid maple crown • swivel tilt/fixed back • fixed height upholstered arm • polyurethane base • overall height range is 46 ½ - 52 • seat height range is 17 ½ - 22 ½ • arm height range is 27 - 32 ½	Dimensions	D	W	H	COM \$2,394
		Overall	26	26	52	A \$2,436
		Seat	19 ¼	19 ¼	22 ½	B \$2,511
		Arm			32 ½	COL/C \$2,643
		Upholstery	Shipping			D \$2,815
		COM Ydg	3 ¼	Ctn Wt	68	E \$2,986
		COL Sq Ft	59	Cu Ft	18	F \$3,166
						G \$3,424
						H \$3,698
						I \$4,127
				J \$4,641		
				L1 \$3,474		
				L2 \$3,749		

To Order, Specify:

- ① Model Number
- ② Wood Species - Maple (M)
- ③ Arm Wood Cap Finish
- ④ Fabric Selection - vendor, pattern and color
 Visit www.jsifurniture.com/finishes-and-materials/textiles for our textiles program.
 See selection of standard and graded in manufacturers and patterns.
- ⑤ Optional Aluminum (A) or Wood Base (W)- add \$116 list
- ⑥ Optional Premium Polished Trim Grey Dual Wheel Soft Urethane Casters - add \$366
- ⑦ Optional Mid-Pivot Mechanism Upgrade - add \$148 list
 (swivel tilt models only)
- ⑧ Optional Seat Depth Slide - add \$44 list
 (synchro tilt models only)
- ⑨ Optional Conference Preset Height Cylinder - add \$31 list
 (swivel tilt chair models only)
- ⑩ Optional T Arm Wood Cap - add \$49 list
 (adjustable T arm models only)
 Optional Aluminum Cantilever Arm - Black Cap - add \$127 list,
 Grey Cap - add \$157 list
 (cantilever arm models only)

Specifications

- Wood species - Maple.
- Two piece molded plywood seat and back.
- Seat has 3 ½" high density polyurethane foam.
- Back has 2" to 1" tapered high density polyurethane foam with ¼" overlay.
- Swivel tilt models are standard with tilt, lock, pneumatic lift, tension adjustment.
- Synchro models are standard with synchronized independent seat and back recline, lock pneumatic lift, tensions adjustment, 6 positions, 2 ½" back height adjustment.
- Polyurethane base, glass reinforced nylon/5 prong/grip ring caster insertion.
- All models standard with 60 mm dual wheel non-hooded black nylon plastic casters.

Description	① Model	Specifications	List Price Per Grade																
Management Mid Back 	PT5610 · synchro/adjustable height back · armless · polyurethane base · overall height range is 41 ½ - 47 · seat height range is 18 ½ - 23 ½	<table border="1"> <thead> <tr> <th>Dimensions</th> <th>D</th> <th>W</th> <th>H</th> </tr> </thead> <tbody> <tr> <td>Overall</td> <td>26</td> <td>26</td> <td>47</td> </tr> <tr> <td>Seat</td> <td>19 ¼</td> <td>19 ¼</td> <td>23 ½</td> </tr> </tbody> </table>	Dimensions	D	W	H	Overall	26	26	47	Seat	19 ¼	19 ¼	23 ½	COM \$1,765 A \$1,786 B \$1,840 COL/C \$1,934 D \$2,052 E \$2,170 F \$2,293 G \$2,474 H \$2,663 I \$2,961 J \$3,314 L1 \$2,507 L2 \$2,698				
		Dimensions	D	W	H														
Overall	26	26	47																
Seat	19 ¼	19 ¼	23 ½																
<table border="1"> <thead> <tr> <th>Upholstery</th> <th colspan="3">Shipping</th> </tr> </thead> <tbody> <tr> <td>COM Ydg</td> <td>2 ¼</td> <td>Ctn Wt</td> <td>58</td> </tr> <tr> <td>COL Sq Ft</td> <td>41</td> <td>Cu Ft</td> <td>18</td> </tr> </tbody> </table>	Upholstery	Shipping			COM Ydg	2 ¼	Ctn Wt	58	COL Sq Ft	41	Cu Ft	18							
Upholstery	Shipping																		
COM Ydg	2 ¼	Ctn Wt	58																
COL Sq Ft	41	Cu Ft	18																
Mid Back 	PT5610L · synchro tilt/adjustable height back · black urethane loop arms · black polyurethane base · overall height range is 41 ½ - 47 · seat height range is 18 ½ - 23 ½ · arm height range is 27 ¾ - 32 ¾	<table border="1"> <thead> <tr> <th>Dimensions</th> <th>D</th> <th>W</th> <th>H</th> </tr> </thead> <tbody> <tr> <td>Overall</td> <td>26</td> <td>26</td> <td>47</td> </tr> <tr> <td>Seat</td> <td>19 ¼</td> <td>19 ¼</td> <td>23 ½</td> </tr> <tr> <td>Arm</td> <td></td> <td></td> <td>32 ¾</td> </tr> </tbody> </table>	Dimensions	D	W	H	Overall	26	26	47	Seat	19 ¼	19 ¼	23 ½	Arm			32 ¾	COM \$1,942 A \$1,967 B \$2,021 COL/C \$2,114 D \$2,233 E \$2,351 F \$2,478 G \$2,652 H \$2,843 I \$3,140 J \$3,496 L1 \$2,688 L2 \$2,879
		Dimensions	D	W	H														
Overall	26	26	47																
Seat	19 ¼	19 ¼	23 ½																
Arm			32 ¾																
<table border="1"> <thead> <tr> <th>Upholstery</th> <th colspan="3">Shipping</th> </tr> </thead> <tbody> <tr> <td>COM Ydg</td> <td>2 ¼</td> <td>Ctn Wt</td> <td>64</td> </tr> <tr> <td>COL Sq Ft</td> <td>41</td> <td>Cu Ft</td> <td>18</td> </tr> </tbody> </table>	Upholstery	Shipping			COM Ydg	2 ¼	Ctn Wt	64	COL Sq Ft	41	Cu Ft	18							
Upholstery	Shipping																		
COM Ydg	2 ¼	Ctn Wt	64																
COL Sq Ft	41	Cu Ft	18																
Mid Back 	PT5610S · synchro tilt/adjustable height back · adjustable black urethane T arm · arm post matches base color · black polyurethane base · overall height range is 41 ½ - 47 · seat height range is 18 ½ - 23 ½ · arm height range is 26 ½ - 32	<table border="1"> <thead> <tr> <th>Dimensions</th> <th>D</th> <th>W</th> <th>H</th> </tr> </thead> <tbody> <tr> <td>Overall</td> <td>26</td> <td>26</td> <td>47</td> </tr> <tr> <td>Seat</td> <td>19 ¼</td> <td>19 ¼</td> <td>23 ½</td> </tr> <tr> <td>Arm</td> <td></td> <td></td> <td>32</td> </tr> </tbody> </table>	Dimensions	D	W	H	Overall	26	26	47	Seat	19 ¼	19 ¼	23 ½	Arm			32	COM \$2,039 A \$2,066 B \$2,118 COL/C \$2,212 D \$2,328 E \$2,449 F \$2,574 G \$2,751 H \$2,940 I \$3,236 J \$3,592 L1 \$2,785 L2 \$2,975
		Dimensions	D	W	H														
Overall	26	26	47																
Seat	19 ¼	19 ¼	23 ½																
Arm			32																
<table border="1"> <thead> <tr> <th>Upholstery</th> <th colspan="3">Shipping</th> </tr> </thead> <tbody> <tr> <td>COM Ydg</td> <td>2 ¼</td> <td>Ctn Wt</td> <td>65</td> </tr> <tr> <td>COL Sq Ft</td> <td>41</td> <td>Cu Ft</td> <td>18</td> </tr> </tbody> </table>	Upholstery	Shipping			COM Ydg	2 ¼	Ctn Wt	65	COL Sq Ft	41	Cu Ft	18							
Upholstery	Shipping																		
COM Ydg	2 ¼	Ctn Wt	65																
COL Sq Ft	41	Cu Ft	18																
Management Mid Back 	PT5610T · synchro/adjustable height back · adjustable urethane T arm · polyurethane base · arm post matches base color · overall height range is 41 ½ - 47 · seat height range is 18 ½ - 23 ½ · arm height range is 25 ½ - 31	<table border="1"> <thead> <tr> <th>Dimensions</th> <th>D</th> <th>W</th> <th>H</th> </tr> </thead> <tbody> <tr> <td>Overall</td> <td>26</td> <td>26</td> <td>47</td> </tr> <tr> <td>Seat</td> <td>19 ¼</td> <td>19 ¼</td> <td>23 ½</td> </tr> <tr> <td>Arm</td> <td></td> <td></td> <td>31</td> </tr> </tbody> </table>	Dimensions	D	W	H	Overall	26	26	47	Seat	19 ¼	19 ¼	23 ½	Arm			31	COM \$2,039 A \$2,066 B \$2,118 COL/C \$2,212 D \$2,328 E \$2,449 F \$2,574 G \$2,751 H \$2,940 I \$3,236 J \$3,592 L1 \$2,785 L2 \$2,975
		Dimensions	D	W	H														
Overall	26	26	47																
Seat	19 ¼	19 ¼	23 ½																
Arm			31																
<table border="1"> <thead> <tr> <th>Upholstery</th> <th colspan="3">Shipping</th> </tr> </thead> <tbody> <tr> <td>COM Ydg</td> <td>2 ¼</td> <td>Ctn Wt</td> <td>65</td> </tr> <tr> <td>COL Sq Ft</td> <td>41</td> <td>Cu Ft</td> <td>18</td> </tr> </tbody> </table>	Upholstery	Shipping			COM Ydg	2 ¼	Ctn Wt	65	COL Sq Ft	41	Cu Ft	18							
Upholstery	Shipping																		
COM Ydg	2 ¼	Ctn Wt	65																
COL Sq Ft	41	Cu Ft	18																

PROTOCOL

Description

1 Model

Specifications

List Price Per Grade

Mid Back



PT5610C

- synchro tilt/adjustable height back
- black urethane cantilever arm
- black polyurethane base
- overall height range is 41 ½ - 47
- seat height range is 18 ½ - 23 ½
- arm height range is 27 ½ - 32 ¾

Dimensions	D	W	H
Overall	26	26	47
Seat	19 ¼	19 ¼	23 ½
Arm			32 ¾
Upholstery		Shipping	
COM Ydg	2 ¼	Ctn Wt	64
COL Sq Ft	41	Cu Ft	18

- COM \$1,986
- A \$2,012
- B \$2,067
- COL/C \$2,158
- D \$2,277
- E \$2,394
- F \$2,522
- G \$2,698
- H \$2,888
- I \$3,185
- J \$3,540
- L1 \$2,734
- L2 \$2,924

Management Mid Back



PT5610U

- synchro/adjustable height back
- fixed height upholstered arm
- polyurethane base
- overall height range is 41 ½ - 47
- seat height range is 18 ½ - 23 ½
- arm height range is 28 - 33 ½

Dimensions	D	W	H
Overall	26	26	47
Seat	19 ¼	19 ¼	23 ½
Arm			33 ½
Upholstery		Shipping	
COM Ydg	3 ¾	Ctn Wt	64
COL Sq Ft	57	Cu Ft	18

- COM \$2,217
- A \$2,253
- B \$2,325
- COL/C \$2,454
- D \$2,618
- E \$2,783
- F \$2,957
- G \$3,206
- H \$3,468
- I \$3,879
- J \$4,373
- L1 \$3,253
- L2 \$3,520

To Order, Specify:





- 1 Model Number
- 2 Wood Species - Maple (M)
- 3 Arm Wood Cap Finish
- 4 Fabric Selection - vendor, pattern and color
Visit www.jsifurniture.com/finishes-and-materials/textiles for our textiles program.
See selection of standard and graded in manufacturers and patterns.
- 5 Optional Aluminum (A) or Wood Base (W)- add \$116 list
- 6 Optional Premium Polished Trim Grey Dual Wheel Soft Urethane Casters - add \$366
- 7 Optional Mid-Pivot Mechanism Upgrade - add \$148 list
(swivel tilt models only)
- 8 Optional Seat Depth Slide - add \$44 list
(synchro tilt models only)
- 9 Optional Conference Preset Height Cylinder - add \$31 list
(swivel tilt chair models only)
- 10 Optional T Arm Wood Cap - add \$49 list
(adjustable T arm models only)
Optional Aluminum Cantilever Arm - Black Cap - add \$127 list,
Grey Cap - add \$157 list
(cantilever arm models only)

Specifications


- Wood species - Maple.
- Two piece molded plywood seat and back.
- Seat has 3 ½" high density polyurethane foam.
- Back has 2" to 1" tapered high density polyurethane foam with ¼" overlay.
- Swivel tilt models are standard with tilt, lock, pneumatic lift, tension adjustment.
- Synchro models are standard with synchronized independent seat and back recline, lock pneumatic lift, tensions adjustment, 6 positions, 2 ½" back height adjustment.
- Polyurethane base, glass reinforced nylon/5 prong/grip ring caster insertion.
- All models standard with 60 mm dual wheel non-hooded black nylon plastic casters.


SWIVEL

PROTOCOL

Description	① Model	Specifications	List Price Per Grade																
Management Mid Back 	PT5660 · solid maple crown · synchro/adjustable height back · armless · polyurethane base · overall height range is 41 ½ - 47 · seat height range is 18 ½ - 23 ½	<table border="1"> <thead> <tr> <th>Dimensions</th> <th>D</th> <th>W</th> <th>H</th> </tr> </thead> <tbody> <tr> <td>Overall</td> <td>26</td> <td>26</td> <td>47</td> </tr> <tr> <td>Seat</td> <td>19 ¼</td> <td>19 ¼</td> <td>23 ½</td> </tr> </tbody> </table>	Dimensions	D	W	H	Overall	26	26	47	Seat	19 ¼	19 ¼	23 ½	COM \$1,951 A \$1,977 B \$2,026 COL/C \$2,113 D \$2,226 E \$2,339 F \$2,455 G \$2,624 H \$2,803 I \$3,083 J \$3,419 L1 \$2,656 L2 \$2,839				
		Dimensions	D	W	H														
Overall	26	26	47																
Seat	19 ¼	19 ¼	23 ½																
<table border="1"> <thead> <tr> <th>Upholstery</th> <th colspan="3">Shipping</th> </tr> </thead> <tbody> <tr> <td>COM Ydg</td> <td>2 ⅞</td> <td>Ctn Wt</td> <td>59</td> </tr> <tr> <td>COL Sq Ft</td> <td>39</td> <td>Cu Ft</td> <td>18</td> </tr> </tbody> </table>	Upholstery	Shipping			COM Ydg	2 ⅞	Ctn Wt	59	COL Sq Ft	39	Cu Ft	18							
Upholstery	Shipping																		
COM Ydg	2 ⅞	Ctn Wt	59																
COL Sq Ft	39	Cu Ft	18																
Mid Back - Wood Crown 	PT5660L · solid maple crown · synchro tilt/adjustable height back · black urethane loop arms · black polyurethane base · overall height range is 41 ½ - 47 · seat height range is 18 ½ - 23 ½ · arm height range is 27 ⅝ - 32 ⅞	<table border="1"> <thead> <tr> <th>Dimensions</th> <th>D</th> <th>W</th> <th>H</th> </tr> </thead> <tbody> <tr> <td>Overall</td> <td>26</td> <td>26</td> <td>47</td> </tr> <tr> <td>Seat</td> <td>19 ¼</td> <td>19 ¼</td> <td>23 ½</td> </tr> <tr> <td>Arm</td> <td></td> <td></td> <td>32 ⅞</td> </tr> </tbody> </table>	Dimensions	D	W	H	Overall	26	26	47	Seat	19 ¼	19 ¼	23 ½	Arm			32 ⅞	COM \$2,132 A \$2,158 B \$2,207 COL/C \$2,299 D \$2,408 E \$2,520 F \$2,639 G \$2,805 H \$2,985 I \$3,265 J \$3,600 L1 \$2,840 L2 \$3,019
		Dimensions	D	W	H														
Overall	26	26	47																
Seat	19 ¼	19 ¼	23 ½																
Arm			32 ⅞																
<table border="1"> <thead> <tr> <th>Upholstery</th> <th colspan="3">Shipping</th> </tr> </thead> <tbody> <tr> <td>COM Ydg</td> <td>2 ⅞</td> <td>Ctn Wt</td> <td>67</td> </tr> <tr> <td>COL Sq Ft</td> <td>39</td> <td>Cu Ft</td> <td>18</td> </tr> </tbody> </table>	Upholstery	Shipping			COM Ydg	2 ⅞	Ctn Wt	67	COL Sq Ft	39	Cu Ft	18							
Upholstery	Shipping																		
COM Ydg	2 ⅞	Ctn Wt	67																
COL Sq Ft	39	Cu Ft	18																
Mid Back - Wood Crown 	PT5660S · solid maple crown · synchro tilt/adjustable height back · adjustable black urethane T arm · arm post matches base color · black polyurethane base · overall height range is 41 ½ - 47 · seat height range is 18 ½ - 23 ½ · arm height range is 26 ½ - 32	<table border="1"> <thead> <tr> <th>Dimensions</th> <th>D</th> <th>W</th> <th>H</th> </tr> </thead> <tbody> <tr> <td>Overall</td> <td>26</td> <td>26</td> <td>47</td> </tr> <tr> <td>Seat</td> <td>19 ¼</td> <td>19 ¼</td> <td>23 ½</td> </tr> <tr> <td>Arm</td> <td></td> <td></td> <td>32</td> </tr> </tbody> </table>	Dimensions	D	W	H	Overall	26	26	47	Seat	19 ¼	19 ¼	23 ½	Arm			32	COM \$2,231 A \$2,255 B \$2,306 COL/C \$2,392 D \$2,504 E \$2,615 F \$2,736 G \$2,901 H \$3,082 I \$3,360 J \$3,698 L1 \$2,935 L2 \$3,115
		Dimensions	D	W	H														
Overall	26	26	47																
Seat	19 ¼	19 ¼	23 ½																
Arm			32																
<table border="1"> <thead> <tr> <th>Upholstery</th> <th colspan="3">Shipping</th> </tr> </thead> <tbody> <tr> <td>COM Ydg</td> <td>2 ⅞</td> <td>Ctn Wt</td> <td>68</td> </tr> <tr> <td>COL Sq Ft</td> <td>39</td> <td>Cu Ft</td> <td>18</td> </tr> </tbody> </table>	Upholstery	Shipping			COM Ydg	2 ⅞	Ctn Wt	68	COL Sq Ft	39	Cu Ft	18							
Upholstery	Shipping																		
COM Ydg	2 ⅞	Ctn Wt	68																
COL Sq Ft	39	Cu Ft	18																
Management Mid Back 	PT5660T · solid maple crown · synchro/adjustable height back · adjustable urethane T arm · polyurethane base · arm post matches base color · overall height range is 41 ½ - 47 · seat height range is 18 ½ - 23 ½ · arm height range is 25 ½ - 31	<table border="1"> <thead> <tr> <th>Dimensions</th> <th>D</th> <th>W</th> <th>H</th> </tr> </thead> <tbody> <tr> <td>Overall</td> <td>26</td> <td>26</td> <td>47</td> </tr> <tr> <td>Seat</td> <td>19 ¼</td> <td>19 ¼</td> <td>23 ½</td> </tr> <tr> <td>Arm</td> <td></td> <td></td> <td>31</td> </tr> </tbody> </table>	Dimensions	D	W	H	Overall	26	26	47	Seat	19 ¼	19 ¼	23 ½	Arm			31	COM \$2,231 A \$2,255 B \$2,306 COL/C \$2,392 D \$2,504 E \$2,615 F \$2,736 G \$2,901 H \$3,082 I \$3,360 J \$3,698 L1 \$2,935 L2 \$3,115
		Dimensions	D	W	H														
Overall	26	26	47																
Seat	19 ¼	19 ¼	23 ½																
Arm			31																
<table border="1"> <thead> <tr> <th>Upholstery</th> <th colspan="3">Shipping</th> </tr> </thead> <tbody> <tr> <td>COM Ydg</td> <td>2 ⅞</td> <td>Ctn Wt</td> <td>68</td> </tr> <tr> <td>COL Sq Ft</td> <td>39</td> <td>Cu Ft</td> <td>18</td> </tr> </tbody> </table>	Upholstery	Shipping			COM Ydg	2 ⅞	Ctn Wt	68	COL Sq Ft	39	Cu Ft	18							
Upholstery	Shipping																		
COM Ydg	2 ⅞	Ctn Wt	68																
COL Sq Ft	39	Cu Ft	18																

PROTOCOL

Description	Model	Specifications				List Price Per Grade	
Mid Back - Wood Crown 	PT5660C • solid maple crown • synchro tilt/adjustable height back • black urethane cantilever arm • black polyurethane base • overall height range is 41 ½ - 47 • seat height range is 18 ½ - 23 ½ • arm height range is 27 ½ - 32 ¾	Dimensions		D	W	H	COM \$2,178
		Overall	26	26	47	A \$2,203	
		Seat	19 ¼	19 ¼	23 ½	B \$2,253	
		Arm			32 ¾	COL/C \$2,342	
		Upholstery		Shipping		D \$2,452	
		COM Ydg	2 ⅞	Ctn Wt	67	E \$2,564	
		COL Sq Ft	39	Cu Ft	18	F \$2,682	
						G \$2,850	
						H \$3,028	
						I \$3,310	
				J \$3,646			
				L1 \$2,885			
				L2 \$3,062			

Description	Model	Specifications				List Price Per Grade	
Management Mid Back 	PT5660U • solid maple crown • synchro/adjustable height back • fixed height upholstered arm • polyurethane base • overall height range is 41 ½ - 47 • seat height range is 18 ½ - 23 ½ • arm height range is 28 - 33 ½	Dimensions		D	W	H	COM \$2,407
		Overall	26	26	47	A \$2,443	
		Seat	19 ¼	19 ¼	23 ½	B \$2,514	
		Arm			33 ½	COL/C \$2,636	
		Upholstery		Shipping		D \$2,794	
		COM Ydg	3	Ctn Wt	67	E \$2,951	
		COL Sq Ft	54	Cu Ft	18	F \$3,119	
						G \$3,356	
						H \$3,608	
						I \$4,005	
				J \$4,478			
				L1 \$3,401			
				L2 \$3,656			

To Order, Specify:

- 1 Model Number
- 2 Wood Species - Maple (M)
- 3 Arm Wood Cap Finish
- 4 Fabric Selection - vendor, pattern and color
 Visit www.jsifurniture.com/finishes-and-materials/textiles for our textiles program.
 See selection of standard and graded in manufacturers and patterns.
- 5 Optional Aluminum (A) or Wood Base (W)- add \$116 list
- 6 Optional Premium Polished Trim Grey Dual Wheel Soft Urethane Casters - add \$366
- 7 Optional Mid-Pivot Mechanism Upgrade - add \$148 list
 (swivel tilt models only)
- 8 Optional Seat Depth Slide - add \$44 list
 (synchro tilt models only)
- 9 Optional Conference Preset Height Cylinder - add \$31 list
 (swivel tilt chair models only)
- 10 Optional T Arm Wood Cap - add \$49 list
 (adjustable T arm models only)
 Optional Aluminum Cantilever Arm - Black Cap - add \$127 list,
 Grey Cap - add \$157 list
 (cantilever arm models only)

Specifications

- Wood species - Maple.
- Two piece molded plywood seat and back.
- Seat has 3 ½" high density polyurethane foam.
- Back has 2" to 1" tapered high density polyurethane foam with ¼" overlay.
- Swivel tilt models are standard with tilt, lock, pneumatic lift, tension adjustment.
- Synchro models are standard with synchronized independent seat and back recline, lock pneumatic lift, tensions adjustment, 6 positions, 2 ½" back height adjustment.
- Polyurethane base, glass reinforced nylon/5 prong/grip ring caster insertion.
- All models standard with 60 mm dual wheel non-hooded black nylon plastic casters.

Description	① Model	Specifications	List Price Per Grade																
High Back	PT5615L · synchro tilt/adjustable height back · black urethane loop arms · black polyurethane base · overall height range is 46 ½ - 52 · seat height range is 18 ½ - 23 ½ · arm height range is 27 ⅝ - 32 ⅞	<table border="1"> <thead> <tr> <th>Dimensions</th> <th>D</th> <th>W</th> <th>H</th> </tr> </thead> <tbody> <tr> <td>Overall</td> <td>26</td> <td>26</td> <td>52</td> </tr> <tr> <td>Seat</td> <td>19 ¼</td> <td>19 ¼</td> <td>23 ½</td> </tr> <tr> <td>Arm</td> <td></td> <td></td> <td>32 ⅞</td> </tr> </tbody> </table>	Dimensions	D	W	H	Overall	26	26	52	Seat	19 ¼	19 ¼	23 ½	Arm			32 ⅞	COM \$2,031 A \$2,063 B \$2,120 COL/C \$2,221 D \$2,353 E \$2,486 F \$2,624 G \$2,821 H \$3,033 I \$3,361 J \$3,757 L1 \$2,861 L2 \$3,073
		Dimensions	D	W	H														
Overall	26	26	52																
Seat	19 ¼	19 ¼	23 ½																
Arm			32 ⅞																
<table border="1"> <thead> <tr> <th>Upholstery</th> <th colspan="3">Shipping</th> </tr> </thead> <tbody> <tr> <td>COM Ydg</td> <td>2 ½</td> <td>Ctn Wt</td> <td>67</td> </tr> <tr> <td>COL Sq Ft</td> <td>45</td> <td>Cu Ft</td> <td>18</td> </tr> </tbody> </table>	Upholstery	Shipping			COM Ydg	2 ½	Ctn Wt	67	COL Sq Ft	45	Cu Ft	18							
Upholstery	Shipping																		
COM Ydg	2 ½	Ctn Wt	67																
COL Sq Ft	45	Cu Ft	18																




High Back	PT5615S · synchro tilt/adjustable height back · adjustable black urethane T arm · arm post matches base color · black polyurethane base · overall height range is 46 ½ - 52 · seat height range is 18 ½ - 23 ½ · arm height range is 26 ½ - 32	<table border="1"> <thead> <tr> <th>Dimensions</th> <th>D</th> <th>W</th> <th>H</th> </tr> </thead> <tbody> <tr> <td>Overall</td> <td>26</td> <td>26</td> <td>52</td> </tr> <tr> <td>Seat</td> <td>19 ¼</td> <td>19 ¼</td> <td>23 ½</td> </tr> <tr> <td>Arm</td> <td></td> <td></td> <td>32</td> </tr> </tbody> </table>	Dimensions	D	W	H	Overall	26	26	52	Seat	19 ¼	19 ¼	23 ½	Arm			32	COM \$2,127 A \$2,157 B \$2,218 COL/C \$2,318 D \$2,451 E \$2,581 F \$2,719 G \$2,918 H \$3,129 I \$3,460 J \$3,853 L1 \$2,959 L2 \$3,169
		Dimensions	D	W	H														
Overall	26	26	52																
Seat	19 ¼	19 ¼	23 ½																
Arm			32																
<table border="1"> <thead> <tr> <th>Upholstery</th> <th colspan="3">Shipping</th> </tr> </thead> <tbody> <tr> <td>COM Ydg</td> <td>2 ½</td> <td>Ctn Wt</td> <td>68</td> </tr> <tr> <td>COL Sq Ft</td> <td>45</td> <td>Cu Ft</td> <td>18</td> </tr> </tbody> </table>	Upholstery	Shipping			COM Ydg	2 ½	Ctn Wt	68	COL Sq Ft	45	Cu Ft	18							
Upholstery	Shipping																		
COM Ydg	2 ½	Ctn Wt	68																
COL Sq Ft	45	Cu Ft	18																




Executive High Back	PT5615T · synchro/adjustable height back · adjustable urethane T arm · polyurethane base · arm post matches base color · overall height range is 46 ½ - 52 · seat height range is 18 ½ - 23 ½ · arm height range is 25 ½ - 31	<table border="1"> <thead> <tr> <th>Dimensions</th> <th>D</th> <th>W</th> <th>H</th> </tr> </thead> <tbody> <tr> <td>Overall</td> <td>26</td> <td>26</td> <td>52</td> </tr> <tr> <td>Seat</td> <td>19 ¼</td> <td>19 ¼</td> <td>23 ½</td> </tr> <tr> <td>Arm</td> <td></td> <td></td> <td>31</td> </tr> </tbody> </table>	Dimensions	D	W	H	Overall	26	26	52	Seat	19 ¼	19 ¼	23 ½	Arm			31	COM \$2,127 A \$2,157 B \$2,218 COL/C \$2,318 D \$2,451 E \$2,581 F \$2,719 G \$2,918 H \$3,129 I \$3,460 J \$3,853 L1 \$2,959 L2 \$3,169
		Dimensions	D	W	H														
Overall	26	26	52																
Seat	19 ¼	19 ¼	23 ½																
Arm			31																
<table border="1"> <thead> <tr> <th>Upholstery</th> <th colspan="3">Shipping</th> </tr> </thead> <tbody> <tr> <td>COM Ydg</td> <td>2 ½</td> <td>Ctn Wt</td> <td>68</td> </tr> <tr> <td>COL Sq Ft</td> <td>45</td> <td>Cu Ft</td> <td>18</td> </tr> </tbody> </table>	Upholstery	Shipping			COM Ydg	2 ½	Ctn Wt	68	COL Sq Ft	45	Cu Ft	18							
Upholstery	Shipping																		
COM Ydg	2 ½	Ctn Wt	68																
COL Sq Ft	45	Cu Ft	18																



PROTOCOL

Description	① Model	Specifications			List Price Per Grade	
High Back 	PT5615C • synchro tilt/adjustable height back • black urethane cantilever arm • black polyurethane base • overall height range is 46 ½ - 52 • seat height range is 18 ½ - 23 ½ • arm height range is 27 ½ - 32 ¾	Dimensions	D	W	H	COM \$2,075
		Overall	26	26	52	A \$2,106
		Seat	19 ¼	19 ¼	23 ½	B \$2,165
		Arm			32 ¾	COL/C \$2,267
		Upholstery	Shipping			D \$2,399
		COM Ydg	2 ½	Ctn Wt	67	E \$2,529
		COL Sq Ft	45	Cu Ft	18	F \$2,669
						G \$2,864
						H \$3,078
						I \$3,407
				J \$3,801		
				L1 \$2,907		
				L2 \$3,118		




Description	① Model	Specifications			List Price Per Grade	
Executive High Back 	PT5615U • synchro/adjustable height back • upholstered arm • polyurethane base • overall height range is 46 ½ - 52 • seat height range is 18 ½ - 23 ½ • arm height range is 28 - 33 ½	Dimensions	D	W	H	COM \$2,300
		Overall	26	26	52	A \$2,339
		Seat	19 ¼	19 ¼	23 ½	B \$2,413
		Arm			33 ½	COL/C \$2,544
		Upholstery	Shipping			D \$2,716
		COM Ydg	3 ¼	Ctn Wt	67	E \$2,888
		COL Sq Ft	59	Cu Ft	18	F \$3,070
						G \$3,326
						H \$3,599
						I \$4,029
				J \$4,542		
				L1 \$3,380		
				L2 \$3,652		


To Order, Specify:


- ① Model Number
- ② Wood Species - Maple (M)
- ③ Arm Wood Cap Finish
- ④ Fabric Selection - vendor, pattern and color
Visit www.jsifurniture.com/finishes-and-materials/textiles for our textiles program.
See selection of standard and graded in manufacturers and patterns.
- ⑤ Optional Aluminum (A) or Wood Base (W)- add \$116 list
- ⑥ Optional Premium Polished Trim Grey Dual Wheel Soft Urethane Casters - add \$366
- ⑦ Optional Mid-Pivot Mechanism Upgrade - add \$148 list
(swivel tilt models only)
- ⑧ Optional Seat Depth Slide - add \$44 list
(synchro tilt models only)
- ⑨ Optional Conference Preset Height Cylinder - add \$31 list
(swivel tilt chair models only)
- ⑩ Optional T Arm Wood Cap - add \$49 list
(adjustable T arm models only)
Optional Aluminum Cantilever Arm - Black Cap - add \$127 list,
Grey Cap - add \$157 list
(cantilever arm models only)

Specifications

- Wood species - Maple.
- Two piece molded plywood seat and back.
- Seat has 3 ½" high density polyurethane foam.
- Back has 2" to 1" tapered high density polyurethane foam with ¼" overlay.
- Swivel tilt models are standard with tilt, lock, pneumatic lift, tension adjustment.
- Synchro models are standard with synchronized independent seat and back recline, lock pneumatic lift, tensions adjustment, 6 positions, 2 ½" back height adjustment.
- Polyurethane base, glass reinforced nylon/5 prong/grip ring caster insertion.
- All models standard with 60 mm dual wheel non-hooded black nylon plastic casters.

Description	① Model	Specifications	List Price Per Grade																
High Back - Wood Crown 	PT5665L · solid maple crown · synchro tilt/adjustable height back · black urethane loop arms · black polyurethane base · overall height range is 46½ - 52 · seat height range is 18½ - 23½ · arm height range is 27⅝ - 32⅞	<table border="1"> <thead> <tr> <th>Dimensions</th> <th>D</th> <th>W</th> <th>H</th> </tr> </thead> <tbody> <tr> <td>Overall</td> <td>26</td> <td>26</td> <td>52</td> </tr> <tr> <td>Seat</td> <td>19¼</td> <td>19¼</td> <td>23½</td> </tr> <tr> <td>Arm</td> <td></td> <td></td> <td>32⅞</td> </tr> </tbody> </table>	Dimensions	D	W	H	Overall	26	26	52	Seat	19¼	19¼	23½	Arm			32⅞	COM \$2,216 A \$2,244 B \$2,305 COL/C \$2,407 D \$2,537 E \$2,671 F \$2,810 G \$3,007 H \$3,215 I \$3,546 J \$3,941 L1 \$3,046 L2 \$3,257
		Dimensions	D	W	H														
		Overall	26	26	52														
		Seat	19¼	19¼	23½														
		Arm			32⅞														
		<table border="1"> <thead> <tr> <th>Upholstery</th> <th colspan="3">Shipping</th> </tr> </thead> <tbody> <tr> <td>COM Ydg</td> <td>2½</td> <td>Ctn Wt</td> <td>68</td> </tr> <tr> <td>COL Sq Ft</td> <td>45</td> <td>Cu Ft</td> <td>18</td> </tr> </tbody> </table>	Upholstery	Shipping			COM Ydg	2½	Ctn Wt	68	COL Sq Ft	45	Cu Ft	18					
		Upholstery	Shipping																
		COM Ydg	2½	Ctn Wt	68														
		COL Sq Ft	45	Cu Ft	18														
		High Back - Wood Crown 	PT5665S · solid maple crown · synchro tilt/adjustable height back · adjustable black urethane T arm · arm post matches base color · black polyurethane base · overall height range is 46½ - 52 · seat height range is 18½ - 23½ · arm height range is 26½ - 32	<table border="1"> <thead> <tr> <th>Dimensions</th> <th>D</th> <th>W</th> <th>H</th> </tr> </thead> <tbody> <tr> <td>Overall</td> <td>26</td> <td>26</td> <td>52</td> </tr> <tr> <td>Seat</td> <td>19¼</td> <td>19¼</td> <td>23½</td> </tr> <tr> <td>Arm</td> <td></td> <td></td> <td>32</td> </tr> </tbody> </table>	Dimensions	D	W	H	Overall	26	26	52	Seat	19¼	19¼	23½	Arm		
Dimensions	D			W	H														
Overall	26			26	52														
Seat	19¼			19¼	23½														
Arm					32														
<table border="1"> <thead> <tr> <th>Upholstery</th> <th colspan="3">Shipping</th> </tr> </thead> <tbody> <tr> <td>COM Ydg</td> <td>2½</td> <td>Ctn Wt</td> <td>69</td> </tr> <tr> <td>COL Sq Ft</td> <td>45</td> <td>Cu Ft</td> <td>18</td> </tr> </tbody> </table>	Upholstery			Shipping			COM Ydg	2½	Ctn Wt	69	COL Sq Ft	45	Cu Ft	18					
Upholstery	Shipping																		
COM Ydg	2½			Ctn Wt	69														
COL Sq Ft	45			Cu Ft	18														
Executive High Back 	PT5665T · solid maple crown · synchro/adjustable height back · adjustable urethane T arm · polyurethane base · arm post matches base color · overall height range is 46½ - 52 · seat height range is 18½ - 23½ · arm height range is 25½ - 31			<table border="1"> <thead> <tr> <th>Dimensions</th> <th>D</th> <th>W</th> <th>H</th> </tr> </thead> <tbody> <tr> <td>Overall</td> <td>26</td> <td>26</td> <td>52</td> </tr> <tr> <td>Seat</td> <td>19¼</td> <td>19¼</td> <td>23½</td> </tr> <tr> <td>Arm</td> <td></td> <td></td> <td>31</td> </tr> </tbody> </table>	Dimensions	D	W	H	Overall	26	26	52	Seat	19¼	19¼	23½	Arm		
		Dimensions	D	W	H														
		Overall	26	26	52														
		Seat	19¼	19¼	23½														
		Arm			31														
		<table border="1"> <thead> <tr> <th>Upholstery</th> <th colspan="3">Shipping</th> </tr> </thead> <tbody> <tr> <td>COM Ydg</td> <td>2½</td> <td>Ctn Wt</td> <td>69</td> </tr> <tr> <td>COL Sq Ft</td> <td>45</td> <td>Cu Ft</td> <td>18</td> </tr> </tbody> </table>	Upholstery	Shipping			COM Ydg	2½	Ctn Wt	69	COL Sq Ft	45	Cu Ft	18					
		Upholstery	Shipping																
		COM Ydg	2½	Ctn Wt	69														
		COL Sq Ft	45	Cu Ft	18														

Description	① Model	Specifications				List Price Per Grade	
High Back - Wood Crown 	PT5665C • solid maple crown • synchro tilt/adjustable height back • black urethane cantilever arm • black polyurethane base • overall height range is 46 ½ - 52 • seat height range is 18 ½ - 23 ½ • arm height range is 27 ½ - 32 ¾	Dimensions		D	W	H	COM \$2,259
		Overall		26	26	52	A \$2,289
		Seat		19 ¼	19 ¼	23 ½	B \$2,349
		Arm				32 ¾	COL/C \$2,451
		Upholstery		Shipping			D \$2,580
		COM Ydg		2 ½	Ctn Wt	68	E \$2,714
		COL Sq Ft		45	Cu Ft	18	F \$2,853
							G \$3,051
							H \$3,261
							I \$3,591
					J \$3,987		
					L1 \$3,090		
					L2 \$3,301		

Description	① Model	Specifications				List Price Per Grade	
Executive High Back 	PT5665U • solid maple crown • synchro/adjustable height back • fixed height upholstered arm • polyurethane base • overall height range is 46 ½ - 52 • seat height range is 18 ½ - 23 ½ • arm height range is 28 - 33 ½	Dimensions		D	W	H	COM \$2,483
		Overall		26	26	52	A \$2,523
		Seat		19 ¼	19 ¼	23 ½	B \$2,598
		Arm				33 ½	COL/C \$2,730
		Upholstery		Shipping			D \$2,901
		COM Ydg		3 ¼	Ctn Wt	68	E \$3,074
		COL Sq Ft		59	Cu Ft	18	F \$3,253
							G \$3,511
							H \$3,786
							I \$4,213
					J \$4,728		
					L1 \$3,564		
					L2 \$3,835		

To Order, Specify:

- ① Model Number
- ② Wood Species - Maple (M)
- ③ Arm Wood Cap Finish
- ④ Fabric Selection - vendor, pattern and color
 Visit www.jsifurniture.com/finishes-and-materials/textiles for our textiles program.
 See selection of standard and graded in manufacturers and patterns.
- ⑤ Optional Aluminum (A) or Wood Base (W)- add \$116 list
- ⑥ Optional Premium Polished Trim Grey Dual Wheel Soft Urethane Casters - add \$366
- ⑦ Optional Mid-Pivot Mechanism Upgrade - add \$148 list
 (swivel tilt models only)
- ⑧ Optional Seat Depth Slide - add \$44 list
 (synchro tilt models only)
- ⑨ Optional Conference Preset Height Cylinder - add \$31 list
 (swivel tilt chair models only)
- ⑩ Optional T Arm Wood Cap - add \$49 list
 (adjustable T arm models only)
 Optional Aluminum Cantilever Arm - Black Cap - add \$127 list,
 Grey Cap - add \$157 list
 (cantilever arm models only)

Specifications

- Wood species - Maple.
- Two piece molded plywood seat and back.
- Seat has 3 ½" high density polyurethane foam.
- Back has 2" to 1" tapered high density polyurethane foam with ¼" overlay.
- Swivel tilt models are standard with tilt, lock, pneumatic lift, tension adjustment.
- Synchro models are standard with synchronized independent seat and back recline, lock pneumatic lift, tensions adjustment, 6 positions, 2 ½" back height adjustment.
- Polyurethane base, glass reinforced nylon/5 prong/grip ring caster insertion.
- All models standard with 60 mm dual wheel non-hooded black nylon plastic casters.

Proxy Order Check List:



Specify:

- 1. Model Number
- 2. Fabric Selection - vendor, pattern and color
- 3. Knit Back Color Selection (knit back models only)
- 4. Optional Aluminum Base - add \$116 list,
- 5. Optional Premium Polished Trim Grey Dual Wheel Soft Urethane Caster - add \$366 list
- 6. Optional Aluminum Cantilever Arm - Black Cap add \$127 list, Grey Cap add \$157 list (cantilever arm models only)
- 7. Optional Seat Depth Slide - add \$44 list (synchro tilt models only)
- 8. Optional Metal Handle - Matte Black (MBK) add \$62 list, Nearly Chrome (NCH) add \$81 list
- 9. Optional Back Zipper Detail - add \$78 list (upholstered back models only)
- 10. Optional Conference Preset Height Cylinder - add \$31 list (swivel tilt chair models only)

Example:

PX810T | **MOMENTUM** | **VOX** | **MYSTIC** | **WR**
 (model #) | (fabric vendor) | (pattern name) | (pattern color) | (knit color)

1. Model Number

2. Fabric Selection - Please supply the following:
 Fabric vendor/Pattern name/Pattern color

For a complete list of JSI Standard and Graded-In Textiles click here

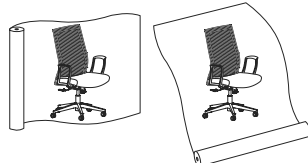
- When specifying contrasting upholstery, indicate clearly which upholstery is to be applied to the seat, back and arms. Use higher grade pricing.
- Indicate direction of fabric - Railroaded or Up the Roll
- Please provide illustration, if available.

All COM orders must include the following:

- Vendor's name, pattern name and color
- Sample of the fabric attached to order
- Model numbers of items for fabric application
- Special application instructions (e.g., all stripes will be applied front to back unless specified otherwise)
- Customer and purchase order number

Ship prepaid COM material to:
 JSI
 Attn: COM Dept
 201 East Martin Street
 Receiving B, Dock 71
 Orleans, IN 47452

Application of fabric:
 Railroaded Up the Roll



All COM orders will ship at standard lead time from receipt of COM.

3. Knit Back Color Selection:

BA	Barely Blue	RR	Rockin' Red
DA	Dancing Silver	SB	Sandy Beige
JB	Jet Black	WR	White River

4. Optional Aluminum Base - add \$116 list



5. Optional Premium Polished Trim Grey Dual Wheel Soft Urethane Caster - add \$366 list



6. Optional Aluminum Cantilever Arm - Black Cap add \$127 list, Grey Cap add \$157 list (cantilever arm models only)



7. Optional Seat Depth Slide - add \$44 list (synchro tilt models only)

8. Optional Metal Handle - Matte Black (MBK) add \$62 list or Nearly Chrome (NCH) add \$81 list





9. Back Zipper Detail - add \$78 list (upholstered back models only)




10. Optional Conference Preset Height Cylinder - add \$31 list (swivel tilt chair models only)



Description	① Model	Specifications	List Price Per Grade												
Mid Back 	PX800 · knit back · armless · swivel tilt · black polyurethane base · overall height range is 40 - 45 ¾ · seat height range is 17 ¼ - 22 ½	<table border="1"> <thead> <tr> <th>Dimensions</th> <th>D</th> <th>W</th> <th>H</th> </tr> </thead> <tbody> <tr> <td>Overall</td> <td>28 ½</td> <td>28 ½</td> <td>45 ¾</td> </tr> <tr> <td>Seat</td> <td>16 ⅝</td> <td>20 ¾</td> <td>17 ¼</td> </tr> </tbody> </table>	Dimensions	D	W	H	Overall	28 ½	28 ½	45 ¾	Seat	16 ⅝	20 ¾	17 ¼	COM \$1,077 A \$1,085 B \$1,100 COL/C \$1,127 D \$1,163 E \$1,198 F \$1,252 G \$1,310 H \$1,372 I \$1,469 J \$1,585 L1 \$1,322 L2 \$1,390
		Dimensions	D	W	H										
Overall	28 ½	28 ½	45 ¾												
Seat	16 ⅝	20 ¾	17 ¼												
<table border="1"> <thead> <tr> <th>Upholstery</th> <th colspan="3">Shipping</th> </tr> </thead> <tbody> <tr> <td>COM Ydg</td> <td>¾</td> <td>Ctn Wt</td> <td>41</td> </tr> <tr> <td>COL Sq Ft</td> <td>15</td> <td>Cu Ft</td> <td>20</td> </tr> </tbody> </table>	Upholstery	Shipping			COM Ydg	¾	Ctn Wt	41	COL Sq Ft	15	Cu Ft	20			
Upholstery	Shipping														
COM Ydg	¾	Ctn Wt	41												
COL Sq Ft	15	Cu Ft	20												

Mid Back 	PX800L · knit back · arm · swivel tilt · black urethane loop arms · black polyurethane base · overall height range is 40 - 45 ¾ · seat height range is 17 ¼ - 22 ½	<table border="1"> <thead> <tr> <th>Dimensions</th> <th>D</th> <th>W</th> <th>H</th> </tr> </thead> <tbody> <tr> <td>Overall</td> <td>28 ½</td> <td>28 ½</td> <td>45 ¾</td> </tr> <tr> <td>Seat</td> <td>16 ⅝</td> <td>20 ¾</td> <td>17 ¼</td> </tr> <tr> <td>Arm</td> <td></td> <td></td> <td>31 ½</td> </tr> </tbody> </table>	Dimensions	D	W	H	Overall	28 ½	28 ½	45 ¾	Seat	16 ⅝	20 ¾	17 ¼	Arm			31 ½	COM \$1,240 A \$1,249 B \$1,263 COL/C \$1,291 D \$1,326 E \$1,362 F \$1,415 G \$1,473 H \$1,536 I \$1,633 J \$1,749 L1 \$1,486 L2 \$1,555
		Dimensions	D	W	H														
Overall	28 ½	28 ½	45 ¾																
Seat	16 ⅝	20 ¾	17 ¼																
Arm			31 ½																
<table border="1"> <thead> <tr> <th>Upholstery</th> <th colspan="3">Shipping</th> </tr> </thead> <tbody> <tr> <td>COM Ydg</td> <td>¾</td> <td>Ctn Wt</td> <td>46</td> </tr> <tr> <td>COL Sq Ft</td> <td>15</td> <td>Cu Ft</td> <td>20</td> </tr> </tbody> </table>	Upholstery	Shipping			COM Ydg	¾	Ctn Wt	46	COL Sq Ft	15	Cu Ft	20							
Upholstery	Shipping																		
COM Ydg	¾	Ctn Wt	46																
COL Sq Ft	15	Cu Ft	20																

Mid Back 	PX800S · knit back · arm · swivel tilt · adjustable black urethane, slim profile T arm · black polyurethane base · overall height range is 40 - 45 ¾ · seat height range is 17 ¼ - 22 ½	<table border="1"> <thead> <tr> <th>Dimensions</th> <th>D</th> <th>W</th> <th>H</th> </tr> </thead> <tbody> <tr> <td>Overall</td> <td>28 ½</td> <td>28 ½</td> <td>45 ¾</td> </tr> <tr> <td>Seat</td> <td>16 ⅝</td> <td>20 ¾</td> <td>17 ¼</td> </tr> <tr> <td>Arm</td> <td></td> <td></td> <td>33 ¾</td> </tr> </tbody> </table>	Dimensions	D	W	H	Overall	28 ½	28 ½	45 ¾	Seat	16 ⅝	20 ¾	17 ¼	Arm			33 ¾	COM \$1,302 A \$1,311 B \$1,326 COL/C \$1,353 D \$1,388 E \$1,424 F \$1,478 G \$1,536 H \$1,598 I \$1,696 J \$1,812 L1 \$1,548 L2 \$1,618
		Dimensions	D	W	H														
Overall	28 ½	28 ½	45 ¾																
Seat	16 ⅝	20 ¾	17 ¼																
Arm			33 ¾																
<table border="1"> <thead> <tr> <th>Upholstery</th> <th colspan="3">Shipping</th> </tr> </thead> <tbody> <tr> <td>COM Ydg</td> <td>¾</td> <td>Ctn Wt</td> <td>47</td> </tr> <tr> <td>COL Sq Ft</td> <td>15</td> <td>Cu Ft</td> <td>20</td> </tr> </tbody> </table>	Upholstery	Shipping			COM Ydg	¾	Ctn Wt	47	COL Sq Ft	15	Cu Ft	20							
Upholstery	Shipping																		
COM Ydg	¾	Ctn Wt	47																
COL Sq Ft	15	Cu Ft	20																

PROXY

Description

1 Model

Specifications

List Price Per Grade

Mid Back



PX800C

- knit back
- arm
- swivel tilt
- black urethane cantilever arm
- black polyurethane base
- overall height range is 40 - 45 ¾
- seat height range is 17 ¼ - 22 ½
- arm height range is 26 ½ - 31 ¾

Dimensions	D	W	H
Overall	28 ½	28 ½	45 ¾
Seat	16 5/8	20 ¾	17 ¼
Arm			31 ¾
Upholstery		Shipping	
COM Ydg	¾	Ctn Wt	46
COL Sq Ft	15	Cu Ft	20


COM	\$1,275
A	\$1,283
B	\$1,298
COL/C	\$1,325
D	\$1,361
E	\$1,397
F	\$1,450
G	\$1,508
H	\$1,571
I	\$1,667
J	\$1,784
L1	\$1,520
L2	\$1,589


To Order, Specify:


- 1 Model Number
- 2 Seat Fabric Selection - vendor, pattern and color
Visit www.jsifurniture.com/finishes-and-materials/textiles for our textiles program.
See selection of standard and graded in manufacturers and patterns.
- 3 Knit Back Color Selection
- 4 Optional Aluminum Base - add \$116 list
- 5 Optional Premium Polished Trim Grey Dual Wheel
Soft Urethane Caster add \$366 list
- 6 Optional Aluminum Cantilever Arm - Black Cap add \$127 list,
Grey Cap add \$157 (cantilever arm models only)
- 7 Optional Metal Handle - Matte Black (MBK) add \$62 list,
Nearly Chrome (NCH) add \$81 list
- 8 Optional Conference Preset Height Cylinder - add \$31 list (swivel tilt chairs only)

Specifications


- Knit back with molded plywood seat.
- Seat has 2 ½" high density polyurethane foam.
- Knit back conforms to shape for optimal comfort.
- Swivel tilt models are standard with 20 degree tilt, lock, pneumatic lift, tension adjustment.
- Polyurethane base, glass reinforced nylon/5-prong/grip ring caster insertion.
- All models standard with 60 mm dual wheel non-hooded black nylon plastic casters.

Description	① Model	Specifications				List Price Per Grade	
Mid Back 	PX810 · knit back · armless · synchro tilt · black polyurethane base · overall height range is 41 ½ - 47 ¼ · seat height range is 18 ¾ - 24	Dimensions		D	W	H	COM \$1,172
		Overall	28 ½	28 ½	47 ¼	A \$1,179	
		Seat	16 ⅝	20 ¾	18 ¾	B \$1,196	
		Upholstery		Shipping		COL/C \$1,222	
		COM Ydg	¾	Ctn Wt	46	D \$1,258	
		COL Sq Ft	15	Cu Ft	20	E \$1,294	
						F \$1,347	
						G \$1,406	
						H \$1,468	
						I \$1,564	

Mid Back 	PX810L · knit back · arm · synchro tilt · black urethane loop arms · black polyurethane base · overall height range is 41 ½ - 47 ¼ · seat height range is 18 ¾ - 24 · arm height range is 27 ¾ - 33	Dimensions		D	W	H	COM \$1,334
		Overall	28 ½	28 ½	47 ¼	A \$1,341	
		Seat	16 ⅝	20 ¾	18 ¾	B \$1,358	
		Arm			33	COL/C \$1,384	
		Upholstery		Shipping		D \$1,420	
		COM Ydg	¾	Ctn Wt	51	E \$1,455	
		COL Sq Ft	15	Cu Ft	20	F \$1,509	
						G \$1,568	
						H \$1,629	
						I \$1,726	

Mid Back 	PX810S · knit back · arm · synchro tilt · adjustable black urethane, slim profile T arm · black polyurethane base · overall height range is 41 ½ - 47 ¼ · seat height range is 18 ¾ - 24	Dimensions		D	W	H	COM \$1,399
		Overall	28 ½	28 ½	47 ¼	A \$1,407	
		Seat	16 ⅝	20 ¾	18 ¾	B \$1,422	
		Arm			35	COL/C \$1,449	
		Upholstery		Shipping		D \$1,485	
		COM Ydg	¾	Ctn Wt	52	E \$1,520	
		COL Sq Ft	15	Cu Ft	20	F \$1,574	
						G \$1,632	
						H \$1,694	
						I \$1,791	

PROXY


Description	Model	Specifications				List Price Per Grade	
		Dimensions	D	W	H	COM	
Mid Back 	PX810C • knit back • arm • synchro tilt • black urethane cantilever arm • black polyurethane base • overall height range is 41 ½ - 47 ¼ • seat height range is 18 ¾ - 24 • arm height range is 27 ⅝ - 32 ⅞	Overall	28 ½	28 ½	47 ¼	COM	\$1,370
		Seat	16 ⅝	20 ¾	18 ¾	A	\$1,378
		Arm			32 ⅞	B	\$1,393
						COL/C	\$1,421
						D	\$1,456
						E	\$1,492
						F	\$1,546
						G	\$1,604
						H	\$1,666
						I	\$1,762
				J	\$1,879		
				L1	\$1,616		
				L2	\$1,685		


To Order, Specify:


- 1 Model Number
- 2 Seat Fabric Selection - vendor, pattern and color
Visit www.jsifurniture.com/finishes-and-materials/textiles for our textiles program.
See selection of standard and graded in manufacturers and patterns.
- 3 Knit Back Color Selection
- 4 Optional Aluminum Base - add \$116 list
- 5 Optional Premium Polished Trim Grey Dual Wheel
Soft Urethane Caster add \$366 list
- 6 Optional Aluminum Cantilever Arm - Black Cap add \$127 list,
Grey Cap add \$157 (cantilever arm models only)
- 7 Optional Seat Depth Slide - add \$44 list (synchro tilt models only)
- 8 Optional Metal Handle - Matte Black (MBK) add \$62 list,
Nearly Chrome (NCH) add \$81 list

Specifications


- Knit back with molded plywood seat.
- Seat has 2 ½" high density polyurethane foam.
- Knit back conforms to shape for optimal comfort.
- Synchro models are standard with synchronized independent seat and back recline, lock, pneumatic lift, tensions adjustment.
- Polyurethane base, glass reinforced nylon/5-prong/grip ring caster insertion.
- All models standard with 60 mm dual wheel non-hooded black nylon plastic casters.

Description	① Model	Specifications				List Price Per Grade	
Mid Back Sit-to-Stand 	PX805 · knit back · armless · swivel limited tilt · black polyurethane base · overall height range is 42 ¾ - 50 ¼ · seat height range is 20 - 27 ½	Dimensions		D	W	H	COM \$1,384
		Overall		29 ½	29 ½	50 ¾	A \$1,392
		Seat		16 ⅝	20 ¾	20	B \$1,408
		Upholstery		Shipping			COL/C \$1,434
		COM Ydg		¾	Ctn Wt	50	D \$1,470
		COL Sq Ft		15	Cu Ft	25	E \$1,506
							F \$1,560
							G \$1,618
							H \$1,680
							I \$1,777

Mid Back Sit-to-Stand 	PX805L · knit back · arm · swivel limited tilt · black urethane loop arms · black polyurethane base · overall height range is 42 ¾ - 50 ¼ · seat height range is 20 - 27 ½ · arm height range is 29 - 34 ¼	Dimensions		D	W	H	COM \$1,544
		Overall		29 ½	29 ½	50 ¾	A \$1,553
		Seat		16 ⅝	20 ¾	20	B \$1,569
		Arm				34 ¼	COL/C \$1,595
		Upholstery		Shipping			D \$1,631
		COM Ydg		¾	Ctn Wt	55	E \$1,666
		COL Sq Ft		15	Cu Ft	25	F \$1,720
							G \$1,778
							H \$1,840
							I \$1,937

Mid Back Sit-to-Stand 	PX805S · knit back · arm · swivel limited tilt · adjustable black urethane, slim profile T arm · black polyurethane base · overall height range is 42 ¾ - 50 ¼ · seat height range is 20 - 27 ½ · arm height range is 27 ⅞ - 36 ½	Dimensions		D	W	H	COM \$1,606
		Overall		29 ½	29 ½	50 ¾	A \$1,614
		Seat		16 ⅝	20 ¾	20	B \$1,629
		Arm				36	COL/C \$1,657
		Upholstery		Shipping			D \$1,692
		COM Ydg		¾	Ctn Wt	56	E \$1,728
		COL Sq Ft		15	Cu Ft	25	F \$1,782
							G \$1,839
							H \$1,902
							I \$1,998

PROXY

Description	Model	Specifications				List Price Per Grade			
Mid Back Sit-to-Stand 	PX805C • knit back • arm • swivel limited tilt • black urethane cantilever arm • black polyurethane base • overall height range is 42 ¾ - 50 ¼ • seat height range is 20 - 27 ½ • arm height range is 28 ⅞ - 34 ⅞	Dimensions		D	W	H	COM \$1,584		
		Overall	29 ½	29 ½	50 ¾	A \$1,593			
		Seat	16 ⅞	20 ¾	20	B \$1,608			
		Arm				34 ⅞	COL/C \$1,635		
		Upholstery		Shipping			D \$1,670		
		COM Ydg	¾	Ctn Wt	55	E \$1,706			
		COL Sq Ft	15	Cu Ft	25	F \$1,760			
									G \$1,818
									H \$1,880
									I \$1,978
							J \$2,094		
							L1 \$1,830		
							L2 \$1,899		


PROXY


To Order, Specify:


- ① Model Number
- ② Seat Fabric Selection - vendor, pattern and color
Visit www.jsifurniture.com/finishes-and-materials/textiles for our textiles program.
See selection of standard and graded in manufacturers and patterns.
- ③ Knit Back Color Selection
- ④ Optional Aluminum Base - add \$116 list
- ⑤ Optional Premium Polished Trim Grey Dual Wheel
Soft Urethane Caster add \$366 list
- ⑥ Optional Aluminum Cantilever Arm - Black Cap add \$127 list,
Grey Cap add \$157 (cantilever arm models only)
- ⑦ Optional Metal Handle - Matte Black (MBK) add \$62 list,
Nearly Chrome (NCH) add \$81 list

Specifications


- Knit back with molded plywood seat.
- Seat has 2 ½" high density polyurethane foam.
- Knit back conforms to shape for optimal comfort.
- Sit-to Stand models are standard with 10 degree tilt, lock, pneumatic lift, tension adjustment.
- Foot ring 9" from floor, reposition with adjustment knob.
- Polyurethane base, glass reinforced nylon/5-prong/grip ring caster insertion.
- All models standard with 60 mm dual wheel non-hooded black nylon plastic casters.

Description	① Model	Specifications				List Price Per Grade	
Mid Back Stool 	PX808 · knit back · armless · swivel limited tilt · black polyurethane base · overall height range is 44 ¾ - 52 ¼ · seat height range is 22 - 29 ½	Dimensions		D	W	H	COM \$1,307
		Overall	28 ½	28 ½	52 ¾	A \$1,316	
		Seat	16 ⅝	20 ¾	22	B \$1,332	
		Upholstery		Shipping		COL/C \$1,359	
		COM Ydg	¾	Ctn Wt	49	D \$1,393	
		COL Sq Ft	15	Cu Ft	25	E \$1,429	
		F \$1,484					
		G \$1,541					
		H \$1,604					
		I \$1,700					

Mid Back Stool 	PX808L · knit back · arm · swivel limited tilt · black urethane loop arms · black polyurethane base · overall height range is 44 ¾ - 52 ¼ · seat height range is 22 - 29 ½ · arm height range is 31 - 36 ¼	Dimensions		D	W	H	COM \$1,464
		Overall	28 ½	28 ½	52 ¾	A \$1,472	
		Seat	16 ⅝	20 ¾	22	B \$1,488	
		Arm			36 ¼	COL/C \$1,514	
		Upholstery		Shipping		D \$1,550	
		COM Ydg	¾	Ctn Wt	54	E \$1,585	
		COL Sq Ft	15	Cu Ft	25	F \$1,640	
		G \$1,698					
		H \$1,760					
		I \$1,857					

Mid Back Stool 	PX808S · knit back · arm · swivel limited tilt · adjustable black urethane, slim profile T arm · black polyurethane base · overall height range is 44 ¾ - 52 ¼ · seat height range is 22 - 29 ½ · arm height range is 29 ⅞ - 38 ½	Dimensions		D	W	H	COM \$1,525
		Overall	28 ½	28 ½	52 ¾	A \$1,533	
		Seat	16 ⅝	20 ¾	22	B \$1,548	
		Arm			38	COL/C \$1,575	
		Upholstery		Shipping		D \$1,611	
		COM Ydg	¾	Ctn Wt	55	E \$1,646	
		COL Sq Ft	15	Cu Ft	25	F \$1,700	
		G \$1,757					
		H \$1,820					
		I \$1,917					

PROXY


Description	① Model	Specifications				List Price Per Grade	
Mid Back Stool 	PX808C • knit back • arm • swivel limited tilt • black urethane cantilever arm • black polyurethane base • overall height range is 44 ¾ - 52 ¼ • seat height range is 22 - 29 ½ • arm height range is 30 ⅞ - 36 ⅞	Dimensions				COM \$1,579	
		Overall	D 28 ½	W 28 ½	H 52 ¾	A \$1,586	
		Seat	16 ⅞	20 ¾	22	B \$1,602	
		Arm	36 ⅞			COL/C \$1,629	
		Upholstery		Shipping		D \$1,665	
		COM Ydg	¾	Ctn Wt	54	E \$1,700	
		COL Sq Ft	15	Cu Ft	25	F \$1,754	
						G \$1,812	
						H \$1,874	
						I \$1,971	
						J \$2,088	
						L1 \$1,824	
						L2 \$1,894	


To Order, Specify:


- ① Model Number
- ② Seat Fabric Selection - vendor, pattern and color
Visit www.jsifurniture.com/finishes-and-materials/textiles for our textiles program.
See selection of standard and graded in manufacturers and patterns.
- ③ Knit Back Color Selection
- ④ Optional Aluminum Base - add \$116 list
- ⑤ Optional Premium Polished Trim Grey Dual Wheel
Soft Urethane Caster add \$366 list
- ⑥ Optional Aluminum Cantilever Arm - Black Cap add \$127 list,
Grey Cap add \$157 (cantilever arm models only)
- ⑦ Optional Metal Handle - Matte Black (MBK) add \$62 list,
Nearly Chrome (NCH) add \$81 list


Specifications

- Knit back with molded plywood seat.
- Seat has 2 ½" high density polyurethane foam.
- Knit back conforms to shape for optimal comfort.
- Stool models are standard with 10 degree tilt, lock, pneumatic lift, tension adjustment.
- Foot ring 13" from floor, reposition with adjustment knob.
- Polyurethane base, glass reinforced nylon/5-prong/grip ring caster insertion.
- All models standard with 60 mm dual wheel non-hooded black nylon plastic casters.

Description	① Model	Specifications				List Price Per Grade	
Low Back 	PX821 · upholstered back · armless · swivel tilt · double stitch outer back detail · black polyurethane base · overall height range is 34 - 39 ¼ · seat height range is 17 ¼ - 22 ½	Dimensions		D	W	H	COM \$1,215 A \$1,237 B \$1,278 COL/C \$1,350 D \$1,445 E \$1,537 F \$1,681 G \$1,836 H \$2,002 I \$2,262 J \$2,570 L1 \$1,949 L2 \$2,157
		Overall	28 ½	28 ½	39 ¼		
		Seat	16 ⅝	20 ¾	17 ¼		
		Upholstery		Shipping			
		COM Ydg	2	Ctn Wt	37		
		COL Sq Ft	40	Cu Ft	16		

Low Back 	PX821L · upholstered back · arm · swivel tilt · black urethane loop arms · double stitch outer back detail · black polyurethane base · overall height range is 34 - 39 ¼ · seat height range is 17 ¼ - 22 ½ · arm height range is 26 ¼ - 31 ½	Dimensions		D	W	H	COM \$1,388 A \$1,410 B \$1,451 COL/C \$1,525 D \$1,618 E \$1,710 F \$1,855 G \$2,009 H \$2,176 I \$2,435 J \$2,743 L1 \$2,122 L2 \$2,330
		Overall	28 ½	28 ½	39 ¼		
		Seat	16 ⅝	20 ¾	17 ¼		
		Arm			31 ½		
		Upholstery		Shipping			
		COM Ydg	2	Ctn Wt	42		
		COL Sq Ft	40	Cu Ft	16		

Low Back 	PX821S · upholstered back · arm · swivel tilt · adjustable black urethane, slim profile T arm · double stitch outer back detail · black polyurethane base · overall height range is 34 - 39 ¼ · seat height range is 17 ¼ - 22 ½ · arm height range is 25 ⅝ - 33 ¾	Dimensions		D	W	H	COM \$1,486 A \$1,507 B \$1,548 COL/C \$1,621 D \$1,713 E \$1,808 F \$1,951 G \$2,107 H \$2,271 I \$2,531 J \$2,841 L1 \$2,220 L2 \$2,428
		Overall	28 ½	28 ½	39 ¼		
		Seat	16 ⅝	20 ¾	17 ¼		
		Arm			33 ¾		
		Upholstery		Shipping			
		COM Ydg	2	Ctn Wt	43		
		COL Sq Ft	40	Cu Ft	16		


Description	Model	Specifications			List Price Per Grade	
Low Back 	PX821C · upholstered back · arm · swivel tilt · black urethane cantilever arm · double stitch outer back detail · black polyurethane base · overall height range is 34 - 39 ¼ · seat height range is 17 ¼ - 22 ½ · arm height range is 26 ½ - 31 ¾	Dimensions	D	W	H	COM \$1,434
		Overall	28 ½	28 ½	39 ¼	A \$1,456
		Seat	16 ¾	20 ¾	17 ¼	B \$1,497
		Arm			31 ¾	COL/C \$1,571
		Upholstery	Shipping			D \$1,663
		COM Ydg	2	Ctn Wt	42	E \$1,756
		COL Sq Ft	40	Cu Ft	16	F \$1,900
						G \$2,056
						H \$2,221
						I \$2,480
						J \$2,791
						L1 \$2,169
						L2 \$2,376


To Order, Specify:


- 1 Model Number
- 2 Fabric Selection - vendor, pattern and color
 Visit www.jsifurniture.com/finishes-and-materials/textiles for our textiles program.
 See selection of standard and graded in manufacturers and patterns.
- 3 Optional Aluminum Base - add \$116 list
- 4 Optional Premium Polished Trim Grey Dual Wheel
 Soft Urethane Caster add \$366 list
- 5 Optional Aluminum Cantilever Arm - Black Cap add \$127 list,
 Grey Cap add \$157 (cantilever arm models only)
- 6 Optional Metal Handle - Matte Black (MBK) add \$62 list,
 Nearly Chrome (NCH) add \$81 list
- 7 Optional Back Zipper Detail - add \$78 list (upholstered back models only)
- 8 Optional Conference Preset Height Cylinder - add \$31 list (swivel tilt chairs only)


Specifications

- One piece molded plywood shell.
- Seat has 2 ½" high density polyurethane foam.
- Back has ¾" high density polyurethane foam.
- Upholstered back models are standard with double stitch outer back detail.
- Swivel tilt models are standard with 20 degree tilt, lock, pneumatic lift, tension adjustment.
- Polyurethane base, glass reinforced nylon/5-prong/grip ring caster insertion.
- All models standard with 60 mm dual wheel non-hooded black nylon plastic casters.

Description	① Model	Specifications				List Price Per Grade	
Mid Back 	PX822 · upholstered back · armless · swivel tilt · double stitch outer back detail · black polyurethane base · overall height range is 39 3/8" - 44 5/8" · seat height range is 17 1/4" - 22 1/2"	Dimensions		D	W	H	COM \$1,269 A \$1,293 B \$1,339 COL/C \$1,421 D \$1,526 E \$1,631 F \$1,793 G \$1,967 H \$2,154 I \$2,443 J \$2,794 L1 \$2,095 L2 \$2,328
		Overall		28 1/2"	28 1/2"	44 5/8"	
		Seat		16 5/8"	20 3/4"	17 1/4"	
		Upholstery		Shipping			
		COM Ydg		2 1/4"	Ctn Wt	41	
		COL Sq Ft		45	Cu Ft	20	

Mid Back 	PX822L · upholstered back · arm · swivel tilt · black urethane loop arms · double stitch outer back detail · black polyurethane base · overall height range is 39 3/8" - 44 5/8" · seat height range is 17 1/4" - 22 1/2" · arm height range is 26 1/4" - 31 1/2"	Dimensions		D	W	H	COM \$1,422 A \$1,446 B \$1,493 COL/C \$1,574 D \$1,679 E \$1,784 F \$1,946 G \$2,120 H \$2,307 I \$2,598 J \$2,947 L1 \$2,247 L2 \$2,481
		Overall		28 1/2"	28 1/2"	44 5/8"	
		Seat		16 5/8"	20 3/4"	17 1/4"	
		Arm		31 1/2"			
		Upholstery		Shipping			
		COM Ydg		2 1/4"	Ctn Wt	46	
		COL Sq Ft		45	Cu Ft	20	

Mid Back 	PX822S · upholstered back · arm · swivel tilt · adjustable black urethane, slim profile T arm · double stitch outer back detail · black polyurethane base · overall height range is 39 3/8" - 44 5/8" · seat height range is 17 1/4" - 22 1/2" · arm height range is 25 1/8" - 33 3/4"	Dimensions		D	W	H	COM \$1,520 A \$1,543 B \$1,591 COL/C \$1,671 D \$1,777 E \$1,881 F \$2,044 G \$2,219 H \$2,405 I \$2,694 J \$3,046 L1 \$2,346 L2 \$2,579
		Overall		28 1/2"	28 1/2"	44 5/8"	
		Seat		16 5/8"	20 3/4"	17 1/4"	
		Arm		33 3/4"			
		Upholstery		Shipping			
		COM Ydg		2 1/4"	Ctn Wt	47	
		COL Sq Ft		45	Cu Ft	20	




Description	Model	Specifications				List Price Per Grade			
Mid Back 	PX822C · upholstered back · arm · swivel tilt · black urethane cantilever arm · double stitch outer back detail · black polyurethane base · overall height range is 39 3/8 - 44 5/8 · seat height range is 17 1/4 - 22 1/2 · arm height range is 26 1/8 - 31 3/8	Dimensions		D	W	H	COM \$1,468		
		Overall	28 1/2	28 1/2	44 5/8	A \$1,492			
		Seat	16 5/8	20 3/4	17 1/4	B \$1,538			
		Arm				31 3/8	COL/C \$1,620		
		Upholstery		Shipping			D \$1,725		
		COM Ydg	2 1/4	Ctn Wt	46	E \$1,830			
		COL Sq Ft	45	Cu Ft	20	F \$1,992			
									G \$2,167
									H \$2,353
									I \$2,643
							J \$2,993		
							L1 \$2,293		
							L2 \$2,527		


To Order, Specify:

- 1 Model Number
- 2 Fabric Selection - vendor, pattern and color
Visit www.jsifurniture.com/finishes-and-materials/textiles for our textiles program.
See selection of standard and graded in manufacturers and patterns.
- 3 Optional Aluminum Base - add \$116 list
- 4 Optional Premium Polished Trim Grey Dual Wheel
Soft Urethane Caster add \$366 list
- 5 Optional Aluminum Cantilever Arm - Black Cap add \$127 list,
Grey Cap add \$157 (cantilever arm models only)
- 6 Optional Metal Handle - Matte Black (MBK) add \$62 list,
Nearly Chrome (NCH) add \$81 list
- 7 Optional Back Zipper Detail - add \$78 list (upholstered back models only)
- 8 Optional Conference Preset Height Cylinder - add \$31 list (swivel tilt chairs only)

Specifications

- One piece molded plywood shell.
- Seat has 2 1/2" high density polyurethane foam.
- Back has 3/4" high density polyurethane foam.
- Upholstered back models are standard with double stitch outer back detail.
- Swivel tilt models are standard with 20 degree tilt, lock, pneumatic lift, tension adjustment.
- Polyurethane base, glass reinforced nylon/5-prong/grip ring caster insertion.
- All models standard with 60 mm dual wheel non-hooded black nylon plastic casters.

Description	① Model	Specifications				List Price Per Grade				
High Back 	PX823 · upholstered back · armless · swivel tilt · double stitch outer back detail · black polyurethane base · overall height range is 45 ⁷ / ₈ - 51 ¹ / ₈ · seat height range is 17 ¹ / ₄ - 22 ¹ / ₂	Dimensions		D	W	H	COM \$1,334 A \$1,361 B \$1,411 COL/C \$1,502 D \$1,619 E \$1,735 F \$1,916 G \$2,110 H \$2,317 I \$2,640 J \$3,027 L1 \$2,251 L2 \$2,512			
		Overall		28 ¹ / ₂	28 ¹ / ₂	51 ¹ / ₈				
		Seat		16 ⁵ / ₈	20 ³ / ₄	17 ¹ / ₄				
		Upholstery		Shipping						
		COM Ydg		2 ¹ / ₂	Ctn Wt	45				
		COL Sq Ft		50	Cu Ft	25				
		High Back 	PX823L · upholstered back · arm · swivel tilt · black urethane loop arm · double stitch outer back detail · black polyurethane base · overall height range is 45 ⁷ / ₈ - 51 ¹ / ₈ · seat height range is 17 ¹ / ₄ - 22 ¹ / ₂ · arm height range is 26 ¹ / ₄ - 31 ¹ / ₂	Dimensions		D		W	H	COM \$1,487 A \$1,513 B \$1,564 COL/C \$1,656 D \$1,772 E \$1,890 F \$2,069 G \$2,264 H \$2,470 I \$2,793 J \$3,181 L1 \$2,405 L2 \$2,664
				Overall		28 ¹ / ₂		28 ¹ / ₂	51 ¹ / ₈	
				Seat		16 ⁵ / ₈		20 ³ / ₄	17 ¹ / ₄	
				Arm					31 ¹ / ₂	
Upholstery				Shipping						
COM Ydg				2 ¹ / ₂	Ctn Wt	50				
COL Sq Ft				50	Cu Ft	25				
High Back 	PX823S · upholstered back · arm · swivel tilt · adjustable black urethane, slim profile T arm · double stitch outer back detail · black polyurethane base · overall height range is 45 ⁷ / ₈ - 51 ¹ / ₈ · seat height range is 17 ¹ / ₄ - 22 ¹ / ₂ · arm height range is 25 ¹ / ₈ - 33 ³ / ₄			Dimensions		D	W	H	COM \$1,585 A \$1,613 B \$1,663 COL/C \$1,754 D \$1,871 E \$1,988 F \$2,168 G \$2,363 H \$2,568 I \$2,891 J \$3,279 L1 \$2,504 L2 \$2,763	
				Overall		28 ¹ / ₂	28 ¹ / ₂	51 ¹ / ₈		
				Seat		16 ⁵ / ₈	20 ³ / ₄	17 ¹ / ₄		
		Arm				33 ³ / ₄				
		Upholstery		Shipping						
		COM Ydg		2 ¹ / ₂	Ctn Wt	51				
		COL Sq Ft		50	Cu Ft	25				


Description	Model	Specifications				List Price Per Grade			
High Back 	PX823C · upholstered back · arm · swivel tilt · black urethane cantilever arm · double stitch outer back detail · black polyurethane base · overall height range is 45 7/8" - 51 1/8" · seat height range is 17 1/4" - 22 1/2" · arm height range is 26 1/8" - 31 3/8"	Dimensions		D	W	H	COM \$1,533		
		Overall	28 1/2"	28 1/2"	51 1/8"	A \$1,560			
		Seat	16 5/8"	20 3/4"	17 1/4"	B \$1,611			
		Arm				31 3/8"	COL/C \$1,701		
		Upholstery		Shipping			D \$1,818		
		COM Ydg	2 1/2"	Ctn Wt	50	E \$1,935			
		COL Sq Ft	50	Cu Ft	25	F \$2,115			
									G \$2,309
									H \$2,516
									I \$2,839
							J \$3,226		
							L1 \$2,451		
							L2 \$2,711		


To Order, Specify:


- 1 Model Number
- 2 Fabric Selection - vendor, pattern and color
Visit www.jsifurniture.com/finishes-and-materials/textiles for our textiles program.
See selection of standard and graded in manufacturers and patterns.
- 3 Optional Aluminum Base - add \$116 list
- 4 Optional Premium Polished Trim Grey Dual Wheel
Soft Urethane Caster add \$366 list
- 5 Optional Aluminum Cantilever Arm - Black Cap add \$127 list,
Grey Cap add \$157 (cantilever arm models only)
- 6 Optional Metal Handle - Matte Black (MBK) add \$62 list,
Nearly Chrome (NCH) add \$81 list
- 7 Optional Back Zipper Detail - add \$78 list (upholstered back models only)
- 8 Optional Conference Preset Height Cylinder - add \$31 list (swivel tilt chairs only)


Specifications

- One piece molded plywood shell.
- Seat has 2 1/2" high density polyurethane foam.
- Back has 3/4" high density polyurethane foam.
- Upholstered back models are standard with double stitch outer back detail.
- Swivel tilt models are standard with 20 degree tilt, lock, pneumatic lift, tension adjustment.
- High back models standard with back pull - stitch detail.
- Polyurethane base, glass reinforced nylon/5-prong/grip ring caster insertion.
- All models standard with 60 mm dual wheel non-hooded black nylon plastic casters.

Description	① Model	Specifications				List Price Per Grade	
Mid Back 	PX812 · upholstered back · armless · synchro tilt · double stitch outer back detail · black polyurethane base · overall height range is 40 ⁷ / ₈ - 46 ¹ / ₈ · seat height range is 18 ³ / ₄ - 24	Dimensions		D	W	H	COM \$1,539 A \$1,563 B \$1,611 COL/C \$1,692 D \$1,796 E \$1,902 F \$2,065 G \$2,239 H \$2,426 I \$2,715 J \$3,064 L1 \$2,366 L2 \$2,600
		Overall		28 ¹ / ₂	28 ¹ / ₂	46 ¹ / ₈	
		Seat		16 ⁵ / ₈	20 ³ / ₄	18 ³ / ₄	
		Upholstery		Shipping			
		COM Ydg		2 ¹ / ₄	Ctn Wt	46	
		COL Sq Ft		45	Cu Ft	20	

Mid Back 	PX812L · upholstered back · arm · synchro tilt · black urethane loop arms · double stitch outer back detail · black polyurethane base · overall height range is 40 ⁷ / ₈ - 46 ¹ / ₈ · seat height range is 18 ³ / ₄ - 24 · arm height range is 27 ³ / ₄ - 33	Dimensions		D	W	H	COM \$1,693 A \$1,717 B \$1,765 COL/C \$1,845 D \$1,949 E \$2,055 F \$2,218 G \$2,392 H \$2,578 I \$2,867 J \$3,219 L1 \$2,519 L2 \$2,753
		Overall		28 ¹ / ₂	28 ¹ / ₂	46 ¹ / ₈	
		Seat		16 ⁵ / ₈	20 ³ / ₄	18 ³ / ₄	
		Arm				33	
		Upholstery		Shipping			
		COM Ydg		2 ¹ / ₄	Ctn Wt	51	
		COL Sq Ft		45	Cu Ft	20	

Mid Back 	PX812S · upholstered back · arm · synchro tilt · adjustable black urethane, slim profile T arm · double stitch outer back detail · black polyurethane base · overall height range is 40 ⁷ / ₈ - 46 ¹ / ₈ · seat height range is 18 ³ / ₄ - 24 · arm height range is 26 ⁵ / ₈ - 35	Dimensions		D	W	H	COM \$1,791 A \$1,815 B \$1,861 COL/C \$1,943 D \$2,047 E \$2,153 F \$2,315 G \$2,490 H \$2,676 I \$2,966 J \$3,316 L1 \$2,617 L2 \$2,850
		Overall		28 ¹ / ₂	28 ¹ / ₂	46 ¹ / ₈	
		Seat		16 ⁵ / ₈	20 ³ / ₄	18 ³ / ₄	
		Arm				35	
		Upholstery		Shipping			
		COM Ydg		2 ¹ / ₄	Ctn Wt	52	
		COL Sq Ft		45	Cu Ft	20	


Description	Model	Specifications			List Price Per Grade		
Mid Back 	PX812C · upholstered back · arm · synchro tilt · black urethane cantilever arm · double stitch outer back detail · black polyurethane base · overall height range is 40 7/8 - 46 1/8 · seat height range is 18 3/4 - 24 · arm height range is 27 5/8 - 32 7/8	Dimensions					
			D	W	H		
		Overall	28 1/2	28 1/2	46 1/8		
		Seat	16 5/8	20 3/4	18 3/4		
		Arm			32 7/8		
		Upholstery		Shipping			
		COM Ydg	2 1/4	Ctn Wt	51		
		COL Sq Ft	45	Cu Ft	20		
						COM	\$1,740
						A	\$1,762
				B	\$1,810		
				COL/C	\$1,892		
				D	\$1,996		
				E	\$2,101		
				F	\$2,264		
				G	\$2,438		
				H	\$2,624		
				I	\$2,914		
				J	\$3,264		
				L1	\$2,565		
				L2	\$2,799		


To Order, Specify:


- 1 Model Number
- 2 Fabric Selection - vendor, pattern and color
Visit www.jsifurniture.com/finishes-and-materials/textiles for our textiles program.
See selection of standard and graded in manufacturers and patterns.
- 3 Optional Aluminum Base - add \$116 list
- 4 Optional Premium Polished Trim Grey Dual Wheel
Soft Urethane Caster add \$366 list
- 5 Optional Aluminum Cantilever Arm - Black Cap add \$127 list,
Grey Cap add \$157 (cantilever arm models only)
- 6 Optional Metal Handle - Matte Black (MBK) add \$62 list,
Nearly Chrome (NCH) add \$81 list
- 7 Optional Back Zipper Detail - add \$78 list (upholstered back models only)
- 8 Optional Conference Preset Height Cylinder - add \$31 list (swivel tilt chairs only)

Specifications

- One piece molded plywood shell.
- Seat has 2 1/2" high density polyurethane foam.
- Back has 3/4" high density polyurethane foam.
- Upholstered back models are standard with double stitch outer back detail.
- Swivel tilt models are standard with 20 degree tilt, lock, pneumatic lift, tension adjustment.
- High back models standard with back pull - stitch detail.
- Polyurethane base, glass reinforced nylon/5-prong/grip ring caster insertion.
- All models standard with 60 mm dual wheel non-hooded black nylon plastic casters.

Description	① Model	Specifications				List Price Per Grade	
High Back 	PX813 · upholstered back · armless · synchro tilt · double stitch outer back detail · black polyurethane base · overall height range is 47 3/8 - 52 5/8 · seat height range is 18 3/4 - 24	Dimensions		D	W	H	COM \$1,564 A \$1,592 B \$1,643 COL/C \$1,733 D \$1,850 E \$1,966 F \$2,147 G \$2,342 H \$2,548 I \$2,870 J \$3,258 L1 \$2,482 L2 \$2,741
		Overall		28 1/2	28 1/2	52 5/8	
		Seat		16 5/8	20 3/4	18 3/4	
		Upholstery		Shipping			
		COM Ydg		2 1/2	Ctn Wt	50	
		COL Sq Ft		50	Cu Ft	25	

High Back 	PX813L · upholstered back · arm · synchro tilt · black urethane loop arms · double stitch outer back detail · black polyurethane base · overall height range is 47 3/8 - 52 5/8 · seat height range is 18 3/4 - 24 · arm height range is 27 3/4 - 33	Dimensions		D	W	H	COM \$1,718 A \$1,745 B \$1,795 COL/C \$1,885 D \$2,003 E \$2,119 F \$2,301 G \$2,494 H \$2,700 I \$3,024 J \$3,412 L1 \$2,636 L2 \$2,896
		Overall		28 1/2	28 1/2	52 5/8	
		Seat		16 5/8	20 3/4	18 3/4	
		Arm		33			
		Upholstery		Shipping			
		COM Ydg		2 1/2	Ctn Wt	55	
		COL Sq Ft		50	Cu Ft	25	

High Back 	PX813S · upholstered back · arm · synchro tilt · adjustable black urethane, slim profile T arm · double stitch outer back detail · black polyurethane base · overall height range is 47 3/8 - 52 5/8 · seat height range is 18 3/4 - 24 · arm height range is 26 5/8 - 35	Dimensions		D	W	H	COM \$1,816 A \$1,842 B \$1,894 COL/C \$1,984 D \$2,101 E \$2,218 F \$2,398 G \$2,592 H \$2,799 I \$3,122 J \$3,509 L1 \$2,734 L2 \$2,993
		Overall		28 1/2	28 1/2	52 5/8	
		Seat		16 5/8	20 3/4	18 3/4	
		Arm		35			
		Upholstery		Shipping			
		COM Ydg		2 1/2	Ctn Wt	56	
		COL Sq Ft		50	Cu Ft	25	

PROXY

Description

1 Model

Specifications

List Price Per Grade

High Back



PX813C

- upholstered back
- arm
- synchro tilt
- black urethane cantilever arm
- double stitch outer back detail
- black polyurethane base
- overall height range is 47 3/8 - 52 5/8
- seat height range is 18 3/4 - 24
- arm height range is 27 5/8 - 32 7/8

Dimensions	D	W	H
Overall	28 1/2	28 1/2	52 5/8
Seat	16 5/8	20 3/4	18 3/4
Arm			32 7/8
Upholstery		Shipping	
COM Ydg	2 1/2	Ctn Wt	55
COL Sq Ft	50	Cu Ft	25


- COM \$1,762
- A \$1,790
- B \$1,840
- COL/C \$1,932
- D \$2,047
- E \$2,164
- F \$2,345
- G \$2,539
- H \$2,746
- I \$3,069
- J \$3,457
- L1 \$2,681
- L2 \$2,940


To Order, Specify:


- 1 Model Number
- 2 Fabric Selection - vendor, pattern and color
Visit www.jsifurniture.com/finishes-and-materials/textiles for our textiles program.
See selection of standard and graded in manufacturers and patterns.
- 3 Optional Aluminum Base - add \$116 list
- 4 Optional Premium Polished Trim Grey Dual Wheel
Soft Urethane Caster add \$366 list
- 5 Optional Aluminum Cantilever Arm - Black Cap add \$127 list,
Grey Cap add \$157 (cantilever arm models only)
- 6 Optional Seat Depth Slide - add \$44 list (synchro tilt models only)
- 7 Optional Metal Handle - Matte Black (MBK) add \$62 list,
Nearly Chrome (NCH) add \$81 list
- 8 Optional Back Zipper Detail - add \$78 list (upholstered back models only)

Specifications


- Two piece molded plywood seat and back.
- Seat has 2 1/2" high density polyurethane foam.
- Back has 3/4" high density polyurethane foam.
- Upholstered back models are standard with double stitch outer back detail.
- Synchro models are standard with synchronized independent seat and back recline, lock pneumatic lift, tension adjustment, 6 position, 2 1/2" back height adjustment.
- High back models standard with back pull - stitch detail.
- Polyurethane base, glass reinforced nylon/5-prong/grip ring caster insertion.
- All models standard with 60 mm dual wheel non-hooded black nylon plastic casters.

Description	① Model	Specifications				List Price Per Grade	
Low Back Sit-to-Stand	PX824 · upholstered back · armless · swivel limited tilt · double stitch outer back detail · black polyurethane base · overall height range is 36¾ - 44¼ · seat height range is 20 - 27½	Dimensions		D	W	H	COM \$1,555
		Overall	29½	29½	44¼		A \$1,576
		Seat		16⅝	20¾	20	B \$1,618
		Upholstery		Shipping			COL/C \$1,691
		COM Ydg	2	Ctn Wt	46		D \$1,784
		COL Sq Ft	40	Cu Ft	21		E \$1,877
							F \$2,021
							G \$2,177
							H \$2,342
							I \$2,601
							J \$2,910
							L1 \$2,289
							L2 \$2,497

Low Back Sit-to-Stand	PX824L · upholstered back · arm · swivel limited tilt · black urethane loop arms · double stitch outer back detail · black polyurethane base · overall height range is 36¾ - 44¼ · seat height range is 20 - 27½ · arm height range is 29 - 34¼	Dimensions		D	W	H	COM \$1,729
		Overall	29½	29½	44¼		A \$1,749
		Seat		16⅝	20¾	20	B \$1,791
		Arm				34¼	COL/C \$1,864
		Upholstery		Shipping			D \$1,957
		COM Ydg	2	Ctn Wt	51		E \$2,050
		COL Sq Ft	40	Cu Ft	21		F \$2,194
							G \$2,350
							H \$2,515
							I \$2,774
							J \$3,084
							L1 \$2,463
							L2 \$2,671

Low Back Sit-to-Stand	PX824S · upholstered back · arm · swivel limited tilt · adjustable black urethane, slim profile T arm · double stitch outer back detail · black polyurethane base · overall height range is 36¾ - 44¼ · seat height range is 20 - 27½ · arm height range is 27⅞ - 36½	Dimensions		D	W	H	COM \$1,827
		Overall	29½	29½	44¼		A \$1,848
		Seat		16⅝	20¾	20	B \$1,890
		Arm				36	COL/C \$1,961
		Upholstery		Shipping			D \$2,055
		COM Ydg	2	Ctn Wt	52		E \$2,148
		COL Sq Ft	40	Cu Ft	21		F \$2,291
							G \$2,448
							H \$2,612
							I \$2,872
							J \$3,182
							L1 \$2,561
							L2 \$2,768

PROXY


Description	Model	Specifications			List Price Per Grade																							
Low Back Sit-to-Stand 	PX824C · upholstered back · arm · swivel limited tilt · black urethane cantilever arm · double stitch outer back detail · black polyurethane base · overall height range is 36 ¾ - 44 ¼ · seat height range is 20 - 27 ½ · arm height range is 28 ⅞ - 34 ⅞	<table border="1"> <thead> <tr> <th>Dimensions</th> <th>D</th> <th>W</th> <th>H</th> </tr> </thead> <tbody> <tr> <td>Overall</td> <td>29 ½</td> <td>29 ½</td> <td>44 ¼</td> </tr> <tr> <td>Seat</td> <td>16 ⅝</td> <td>20 ¾</td> <td>20</td> </tr> <tr> <td>Arm</td> <td></td> <td></td> <td>34 ⅞</td> </tr> </tbody> </table>			Dimensions	D	W	H	Overall	29 ½	29 ½	44 ¼	Seat	16 ⅝	20 ¾	20	Arm			34 ⅞	<table border="1"> <thead> <tr> <th>Upholstery</th> <th>Shipping</th> </tr> </thead> <tbody> <tr> <td>COM Ydg</td> <td>Ctn Wt 51</td> </tr> <tr> <td>COL Sq Ft</td> <td>Cu Ft 21</td> </tr> </tbody> </table>		Upholstery	Shipping	COM Ydg	Ctn Wt 51	COL Sq Ft	Cu Ft 21
		Dimensions	D	W	H																							
Overall	29 ½	29 ½	44 ¼																									
Seat	16 ⅝	20 ¾	20																									
Arm			34 ⅞																									
Upholstery	Shipping																											
COM Ydg	Ctn Wt 51																											
COL Sq Ft	Cu Ft 21																											
					COM	\$1,774																						
					A	\$1,795																						
					B	\$1,836																						
					COL/C	\$1,910																						
					D	\$2,003																						
					E	\$2,096																						
					F	\$2,240																						
					G	\$2,395																						
					H	\$2,561																						
					I	\$2,820																						
					J	\$3,129																						
					L1	\$2,508																						
					L2	\$2,716																						


To Order, Specify:


- ① Model Number
- ② Fabric Selection - vendor, pattern and color
Visit www.jsifurniture.com/finishes-and-materials/textiles for our textiles program.
See selection of standard and graded in manufacturers and patterns.
- ③ Optional Aluminum Base - add \$116 list
- ④ Optional Premium Polished Trim Grey Dual Wheel
Soft Urethane Caster add \$366 list
- ⑤ Optional Aluminum Cantilever Arm - Black Cap add \$127 list,
Grey Cap add \$157 (cantilever arm models only)
- ⑥ Optional Metal Handle - Matte Black (MBK) add \$62 list,
Nearly Chrome (NCH) add \$81 list
- ⑦ Optional Back Zipper Detail - add \$78 list (upholstered back models only)

Specifications


- One piece molded plywood shell.
- Seat has 2 ½" high density polyurethane foam.
- Back has ¾" high density polyurethane foam.
- Upholstered back models are standard with double stitch outer back detail.
- Sit-to-Stand models are standard with 10 degree tilt, lock, pneumatic lift, tension adjustment.
- Foot ring 9" from floor, reposition with adjustment knob.
- Polyurethane base, glass reinforced nylon/5-prong/grip ring caster insertion.
- All models standard with 60 mm dual wheel non-hooded black nylon plastic casters.

Description	① Model	Specifications				List Price Per Grade	
Mid Back Sit-to-Stand 	PX825 · upholstered back · armless · swivel limited tilt · double stitch outer back detail · black polyurethane base · overall height range is 42 1/8 - 49 5/8 · seat height range is 20 - 27 1/2	Dimensions		D	W	H	COM \$1,608 A \$1,632 B \$1,679 COL/C \$1,760 D \$1,865 E \$1,970 F \$2,132 G \$2,307 H \$2,493 I \$2,783 J \$3,134 L1 \$2,435 L2 \$2,668
		Overall		29 1/2	29 1/2	49 5/8	
		Seat		16 5/8	20 3/4	20	
		Upholstery		Shipping			
		COM Ydg		2 1/4	Ctn Wt	50	
		COL Sq Ft		45	Cu Ft	25	

Mid Back Sit-to-Stand 	PX825L · upholstered back · arm · swivel limited tilt · black urethane loop arms · double stitch outer back detail · black polyurethane base · overall height range is 42 1/8 - 49 5/8 · seat height range is 20 - 27 1/2 · arm height range is 29 - 34 1/4	Dimensions		D	W	H	COM \$1,762 A \$1,786 B \$1,833 COL/C \$1,915 D \$2,020 E \$2,125 F \$2,287 G \$2,462 H \$2,648 I \$2,938 J \$3,288 L1 \$2,589 L2 \$2,822
		Overall		29 1/2	29 1/2	49 5/8	
		Seat		16 5/8	20 3/4	20	
		Arm		34 1/4			
		Upholstery		Shipping			
		COM Ydg		2 1/4	Ctn Wt	55	
		COL Sq Ft		45	Cu Ft	25	

Mid Back Sit-to-Stand 	PX825S · upholstered back · arm · swivel limited tilt · adjustable black urethane, slim profile T arm · double stitch outer back detail · black polyurethane base · overall height range is 42 1/8 - 49 5/8 · seat height range is 20 - 27 1/2 · arm height range is 27 1/8 - 36 1/2	Dimensions		D	W	H	COM \$1,859 A \$1,882 B \$1,930 COL/C \$2,011 D \$2,116 E \$2,221 F \$2,384 G \$2,559 H \$2,743 I \$3,034 J \$3,384 L1 \$2,686 L2 \$2,920
		Overall		29 1/2	29 1/2	49 5/8	
		Seat		16 5/8	20 3/4	20	
		Arm		36			
		Upholstery		Shipping			
		COM Ydg		2 1/4	Ctn Wt	56	
		COL Sq Ft		45	Cu Ft	25	

PROXY


Description	Model	Specifications				List Price Per Grade	
Mid Back Sit-to-Stand 	PX825C · upholstered back · arm · swivel limited tilt · black urethane cantilever arm · double stitch outer back detail · black polyurethane base · overall height range is 42 1/8 - 49 5/8 · seat height range is 20 - 27 1/2 · arm height range is 28 7/8 - 34 1/8	Dimensions		D	W	H	COM \$1,809
		Overall	29 1/2	29 1/2	49 5/8	A \$1,832	
		Seat	16 5/8	20 3/4	20	B \$1,879	
		Arm	34 1/8			COL/C \$1,960	
		Upholstery		Shipping		D \$2,066	
		COM Ydg	2 1/4	Ctn Wt	55	E \$2,170	
		COL Sq Ft	45	Cu Ft	25	F \$2,332	
						G \$2,507	
						H \$2,693	
						I \$2,984	
						J \$3,334	
						L1 \$2,635	
						L2 \$2,867	


To Order, Specify:


- 1 Model Number
- 2 Fabric Selection - vendor, pattern and color
Visit www.jsifurniture.com/finishes-and-materials/textiles for our textiles program.
See selection of standard and graded in manufacturers and patterns.
- 3 Optional Aluminum Base - add \$116 list
- 4 Optional Premium Polished Trim Grey Dual Wheel
Soft Urethane Caster add \$366 list
- 5 Optional Aluminum Cantilever Arm - Black Cap add \$127 list,
Grey Cap add \$157 (cantilever arm models only)
- 6 Optional Metal Handle - Matte Black (MBK) add \$62 list,
Nearly Chrome (NCH) add \$81 list
- 7 Optional Back Zipper Detail - add \$78 list (upholstered back models only)

Specifications

- One piece molded plywood shell.
- Seat has 2 1/2" high density polyurethane foam.
- Back has 3/4" high density polyurethane foam.
- Upholstered back models are standard with double stitch outer back detail.
- Sit-to-Stand models are standard with 10 degree tilt, lock, pneumatic lift, tension adjustment.
- Foot ring 9" from floor, reposition with adjustment knob.
- Polyurethane base, glass reinforced nylon/5-prong/grip ring caster insertion.
- All models standard with 60 mm dual wheel non-hooded black nylon plastic casters.

Description	① Model	Specifications				List Price Per Grade		
Low Back Stool 	PX827 · upholstered back · armless · swivel limited tilt · double stitch outer back detail · black polyurethane base · overall height range is 38¾ - 46¼ · seat height range is 22 - 29½	Dimensions		D	W	H	COM \$1,489 A \$1,510 B \$1,551 COL/C \$1,624 D \$1,718 E \$1,811 F \$1,955 G \$2,110 H \$2,276 I \$2,535 J \$2,845 L1 \$2,224 L2 \$2,431	
		Overall		28 ½	28 ½	46 ¼		
		Seat		16 ⅝	20 ¾	22		
		Upholstery		Shipping				
		COM Ydg		2	Ctn Wt	45		
		COL Sq Ft		40	Cu Ft	21		

Low Back Stool 	PX827L · upholstered back · arm · swivel limited tilt · black urethane loop arms · double stitch outer back detail · black polyurethane base · overall height range is 38¾ - 46¼ · seat height range is 22 - 29½ · arm height range is 31 - 36¼	Dimensions		D	W	H	COM \$1,665 A \$1,686 B \$1,728 COL/C \$1,799 D \$1,894 E \$1,986 F \$2,130 G \$2,286 H \$2,451 I \$2,711 J \$3,020 L1 \$2,399 L2 \$2,606	
		Overall		28 ½	28 ½	46 ¼		
		Seat		16 ⅝	20 ¾	22		
		Arm		36 ¼				
		Upholstery		Shipping				
		COM Ydg		2	Ctn Wt	50		
		COL Sq Ft		40	Cu Ft	21		

Low Back Stool 	PX827S · upholstered back · arm · swivel limited tilt · adjustable black urethane, slim profile T arm · double stitch outer back detail · black polyurethane base · overall height range is 38¾ - 46¼ · seat height range is 22 - 29½ · arm height range is 29⅞ - 38½	Dimensions		D	W	H	COM \$1,760 A \$1,782 B \$1,822 COL/C \$1,896 D \$1,989 E \$2,082 F \$2,226 G \$2,382 H \$2,547 I \$2,805 J \$3,115 L1 \$2,494 L2 \$2,702	
		Overall		28 ½	28 ½	46 ¼		
		Seat		16 ⅝	20 ¾	22		
		Arm		38				
		Upholstery		Shipping				
		COM Ydg		2	Ctn Wt	51		
		COL Sq Ft		40	Cu Ft	21		

Description

1 Model

Specifications

List Price Per Grade

Low Back Stool



PX827C

- upholstered back
- arm
- swivel limited tilt
- black urethane cantilever arm
- double stitch outer back detail
- black polyurethane base
- overall height range is 38 ¾ - 46 ¼
- seat height range is 22 - 29 ½
- arm height range is 30 ⅞ - 36 ⅞

Dimensions	D	W	H
Overall	28 ½	28 ½	46 ¼
Seat	16 ⅝	20 ¾	22
Arm			36 ⅞
Upholstery		Shipping	
COM Ydg	2	Ctn Wt	50
COL Sq Ft	40	Cu Ft	21


- COM \$1,708
- A \$1,730
- B \$1,771
- COL/C \$1,843
- D \$1,937
- E \$2,030
- F \$2,175
- G \$2,329
- H \$2,494
- I \$2,754
- J \$3,063
- L1 \$2,442
- L2 \$2,650


To Order, Specify:


- 1 Model Number
- 2 Fabric Selection - vendor, pattern and color
Visit www.jsifurniture.com/finishes-and-materials/textiles for our textiles program.
See selection of standard and graded in manufacturers and patterns.
- 3 Optional Aluminum Base - add \$116 list
- 4 Optional Premium Polished Trim Grey Dual Wheel
Soft Urethane Caster add \$366 list
- 5 Optional Aluminum Cantilever Arm - Black Cap add \$127 list,
Grey Cap add \$157 (cantilever arm models only)
- 6 Optional Metal Handle - Matte Black (MBK) add \$62 list,
Nearly Chrome (NCH) add \$81 list
- 7 Optional Back Zipper Detail - add \$78 list (upholstered back models only)

Specifications

- One piece molded plywood shell.
- Seat has 2 ½" high density polyurethane foam.
- Back has ¾" high density polyurethane foam.
- Upholstered back models are standard with double stitch outer back detail.
- Sit-to-Stand models are standard with 10 degree tilt, lock, pneumatic lift, tension adjustment.
- Foot ring 9" from floor, reposition with adjustment knob.
- Polyurethane base, glass reinforced nylon/5-prong/grip ring caster insertion.
- All models standard with 60 mm dual wheel non-hooded black nylon plastic casters.

Description	① Model	Specifications				List Price Per Grade	
Mid Back Stool 	PX828 · upholstered back · armless · swivel limited tilt · double stitch outer back detail · black polyurethane base · overall height range is 44 1/8 - 51 5/8 · seat height range is 22 - 29 1/2	Dimensions		D	W	H	COM \$1,543
		Overall	28 1/2	28 1/2	51 5/8	A \$1,568	
		Seat	16 5/8	20 3/4	22	B \$1,614	
		Upholstery		Shipping		COL/C \$1,696	
		COM Ydg	2 1/4	Ctn Wt	49	D \$1,799	
		COL Sq Ft	45	Cu Ft	25	E \$1,905	
		F \$2,068					
		G \$2,242					
		H \$2,429					
		I \$2,718					

Mid Back Stool 	PX828L · upholstered back · arm · swivel limited tilt · black urethane loop arms · double stitch outer back detail · black polyurethane base · overall height range is 44 1/8 - 51 5/8 · seat height range is 22 - 29 1/2 · arm height range is 31 - 36 1/4	Dimensions		D	W	H	COM \$1,699
		Overall	28 1/2	28 1/2	51 5/8	A \$1,722	
		Seat	16 5/8	20 3/4	22	B \$1,770	
		Arm			36 1/4	COL/C \$1,852	
		Upholstery		Shipping		D \$1,956	
		COM Ydg	2 1/4	Ctn Wt	54	E \$2,061	
		COL Sq Ft	45	Cu Ft	25	F \$2,224	
		G \$2,398					
		H \$2,585					
		I \$2,875					

Mid Back Stool 	PX828S · upholstered back · arm · swivel limited tilt · adjustable black urethane, slim profile T arm · double stitch outer back detail · black polyurethane base · overall height range is 44 1/8 - 51 5/8 · seat height range is 22 - 29 1/2	Dimensions		D	W	H	COM \$1,794
		Overall	28 1/2	28 1/2	51 5/8	A \$1,818	
		Seat	16 5/8	20 3/4	22	B \$1,865	
		Arm			38	COL/C \$1,946	
		Upholstery		Shipping		D \$2,052	
		COM Ydg	2 1/4	Ctn Wt	55	E \$2,156	
		COL Sq Ft	45	Cu Ft	25	F \$2,319	
		G \$2,493					
		H \$2,679					
		I \$2,970					

PROXY

Description

1 Model

Specifications

List Price Per Grade

Mid Back Stool



PX828C

- upholstered back
- arm
- swivel limited tilt
- black urethane cantilever arm
- double stitch outer back detail
- black polyurethane base
- overall height range is 44 1/8 - 51 5/8
- seat height range is 22 - 29 1/2
- arm height range is 30 7/8 - 36 1/8

Dimensions	D	W	H
Overall	28 1/2	28 1/2	51 5/8
Seat	16 5/8	20 3/4	22
Arm			36 1/8
Upholstery		Shipping	
COM Ydg	2 1/4	Ctn Wt	54
COL Sq Ft	45	Cu Ft	25

- COM \$1,743
- A \$1,767
- B \$1,813
- COL/C \$1,895
- D \$2,000
- E \$2,105
- F \$2,267
- G \$2,441
- H \$2,628
- I \$2,918
- J \$3,268
- L1 \$2,568
- L2 \$2,802

To Order, Specify:

- 1 Model Number
- 2 Fabric Selection - vendor, pattern and color
Visit www.jsifurniture.com/finishes-and-materials/textiles for our textiles program.
See selection of standard and graded in manufacturers and patterns.
- 3 Optional Aluminum Base - add \$116 list
- 4 Optional Premium Polished Trim Grey Dual Wheel
Soft Urethane Caster add \$366 list
- 5 Optional Aluminum Cantilever Arm - Black Cap add \$127 list,
Grey Cap add \$157 (cantilever arm models only)
- 6 Optional Metal Handle - Matte Black (MBK) add \$62 list,
Nearly Chrome (NCH) add \$81 list
- 7 Optional Back Zipper Detail - add \$78 list (upholstered back models only)

Specifications

- One piece molded plywood shell.
- Seat has 2 1/2" high density polyurethane foam.
- Back has 3/4" high density polyurethane foam.
- Upholstered back models are standard with double stitch outer back detail.
- Sit-to-Stand models are standard with 10 degree tilt, lock, pneumatic lift, tension adjustment.
- Foot ring 9" from floor, reposition with adjustment knob.
- Polyurethane base, glass reinforced nylon/5-prong/grip ring caster insertion.
- All models standard with 60 mm dual wheel non-hooded black nylon plastic casters.

Ramona Order Check List:



Specify:

- 1. Model Number
- 2. Wood Species - Maple (M)
- 3. Wood Finish
- 4. Fabric Selection - vendor, pattern and color
- 5. Optional Rubber Cushion Nylon Glides - no upcharge

Example:

RA2581C | **M** | **HRV** | **MOMENTUM** | **VOX** | **MYSTIC**
 (model #) | (wood species) | (finish) | (fabric vendor) | (pattern name) | (pattern color)

1. Model Number

2. Wood Species - Maple (M)

3. Wood Finish Options:

ALM	Ale Medium	HRV	Harvest
CAL	Ale Light Coordinate	CKC	Khaki Coordinate
BBM	Bourbon Medium	MINC	Mineral Coordinate
CBZ	Brazilwood Coordinate	MCH	Mocha
BARC	Barrel Coordinate	CPI	Pinnacle Walnut Coordinate
CBO	Bourbon Light Coordinate	PRL	Praline
CBG	Brighton Light Coordinate	RAVC	Raven Coordinate
BRM	Brighton Medium	SABC	Sable Coordinate
BUT	Butterscotch	SIE	Sienna
CNDC	Cinder Coordinate	CST	Studio Teak Coordinate
CLA	Classic	TRF	Truffle
CLL	Collectors	UMB	Umber
EGRC	Egret Coordinate	VALC	Valley Coordinate
ESP	Espresso	VEN	Venetian
FAWC	Fawn Coordinate	CWE	Weathered Ash Coordinate
FLX	Flax		
CGR	Graphite Coordinate		

4. Fabric Selection - Please supply the following:
 Fabric vendor/Pattern name/Pattern color

For a complete list of JSI Standard and Graded-In Textiles [click here](#)

When specifying contrasting upholstery, indicate clearly which upholstery is to be applied to the seat and back. Use higher grade pricing.

- Indicate direction of fabric - Railroaded or Up the Roll
- Please provide illustration, if available

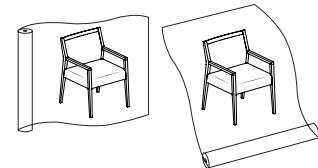
All COM orders must include the following:

- Vendor's name, pattern name and color
- Sample of the fabric attached to order
- Model numbers of items for fabric application
- Special application instructions (e.g., all stripes will be applied front to back unless specified otherwise)
- Customer and purchase order number

Ship prepaid COM material to:

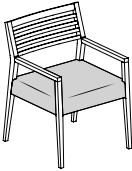
JSI
 Attn: COM Dept
 201 East Martin Street
 Receiving B, Dock 71
 Orleans, IN 47452

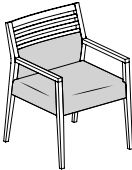
Application of fabric:
 Railroaded Up the Roll



All COM orders will ship at standard lead time from receipt of COM except for orders requiring special custom matched finishes.

5. Optional Rubber Cushion Nylon Glides - no upcharge

Description	① Model	Specifications			List Price Per Grade	
Guest Chair 	RA2581C · upholstered seat · wood back slats	Dimensions	D	W	H	COM \$996
		Overall	25 ¼	22 ½	32 ¼	A \$1,014
		Seat	19 ¾	19 ¾	18	B \$1,038
		Arm			24 ¾	COL/C \$1,082
		Upholstery	Shipping			D \$1,135
		COM Ydg	1	Ctn Wt	22	E \$1,191
		COL Sq Ft	18	Cu Ft	14	F \$1,274
						G \$1,365
						H \$1,461
						I \$1,612
						J \$1,793
						L1 \$1,430
						L2 \$1,551

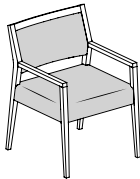
Guest Chair 	RA2581F · upholstered seat · ½ upholstered lower back with wood slats	Dimensions	D	W	H	COM \$1,123
		Overall	25 ¼	22 ½	32 ¼	A \$1,140
		Seat	19 ¾	19 ¾	18	B \$1,171
		Arm			24 ¾	COL/C \$1,224
		Upholstery	Shipping			D \$1,291
		COM Ydg	1 ¼	Ctn Wt	23	E \$1,360
		COL Sq Ft	14	Cu Ft	14	F \$1,464
						G \$1,577
						H \$1,699
						I \$1,885
						J \$2,113
						L1 \$1,661
						L2 \$1,812

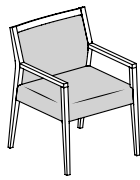
To Order, Specify:

- ① Model Number
- ② Wood Species - Maple (M)
- ③ Wood Finish [See Wood Finish Options](#)
- ④ Fabric Selection - vendor, pattern and color
 Visit www.jsifurniture.com/finishes-and-materials/textiles for our textiles program. See selection of standard and graded in manufacturers and patterns.
- ⑤ Optional Rubber Cushion Nylon Glides - no upcharge

Specifications

- Wood species - Maple.
- Solid Maple lumber exterior frame.
- Solid lumber interior frame.
- Seat has synthetic sheet webbing and 2" high density polyurethane foam.
- Solid hardwood back frame with synthetic sheet webbing and ¾" polyurethane foam.
- Wall saver feature.
- Mortise and tenon construction with corner blocks, glue and screws.
- Standard with rubber cushion metal glides.

Description	① Model	Specifications			List Price Per Grade	
Guest Chair 	RA2581E · upholstered seat · ¾ upholstered back	Dimensions	D	W	H	COM \$1,061
		Overall	25 ¼	22 ½	32 ¼	A \$1,076
		Seat	19 ¾	19 ¾	18	B \$1,106
		Arm			24 ¾	COL/C \$1,161
		Upholstery	Shipping			D \$1,228
		COM Ydg	1 ¼	Ctn Wt	23	E \$1,296
		COL Sq Ft	23	Cu Ft	14	F \$1,402
				G \$1,513		
				H \$1,635		
				I \$1,822		
				J \$2,050		
				L1 \$1,597		
				L2 \$1,747		

Description	① Model	Specifications			List Price Per Grade	
Guest Chair 	RA2581D · upholstered seat · fully upholstered back	Dimensions	D	W	H	COM \$1,090
		Overall	25 ¼	22 ½	32 ¼	A \$1,109
		Seat	19 ¾	19 ¾	18	B \$1,144
		Arm			24 ¾	COL/C \$1,208
		Upholstery	Shipping			D \$1,290
		COM Ydg	1 ½	Ctn Wt	23	E \$1,371
		COL Sq Ft	27	Cu Ft	14	F \$1,497
				G \$1,634		
				H \$1,778		
				I \$2,004		
				J \$2,277		
				L1 \$1,734		
				L2 \$1,915		

To Order, Specify:

- ① Model Number
- ② Wood Species - Maple (M)
- ③ Wood Finish [See Wood Finish Options](#)
- ④ Fabric Selection - vendor, pattern and color
 Visit www.jsifurniture.com/finishes-and-materials/textiles for our textiles program. See selection of standard and graded in manufacturers and patterns.
- ⑤ Optional Rubber Cushion Nylon Glides - no upcharge

Specifications

- Wood species - Maple.
- Solid Maple lumber exterior frame.
- Solid lumber interior frame.
- Seat has synthetic sheet webbing and 2" high density polyurethane foam.
- Solid hardwood back frame with synthetic sheet webbing and ¾" polyurethane foam.
- Wall saver feature.
- Mortise and tenon construction with corner blocks, glue and screws.
- Standard with rubber cushion metal glides.

Ria Order Check List:



Specify:

- 1. Model Number
- 2. Wood Species - Maple (M)
- 3. Wood Finish
- 4. Fabric Selection - vendor, pattern and color
- 5. Optional Rubber Cushion Nylon Glides - no upcharge

Example:

RI2571 | **M** | **HRV** | **MOMENTUM** | **VOX** | **MYSTIC**
 (model #) | (wood species) | (finish) | (fabric vendor) | (pattern name) | (pattern color)

1. Model Number

- Special application instructions (e.g., all stripes will be applied front to back unless specified otherwise)
- Customer and purchase order number

2. Wood Species - Maple (M)

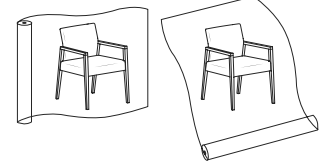
3. Wood Finish Options:

ALM Ale Medium	HRV Harvest
CAL Ale Light Coordinate	CKC Khaki Coordinate
BBM Bourbon Medium	MINC Mineral Coordinate
CBZ Brazilwood Coordinate	MCH Mocha
BARC Barrel Coordinate	CPI Pinnacle Walnut Coordinate
CBO Bourbon Light Coordinate	PRL Praline
CBG Brighton Light Coordinate	RAVC Raven Coordinate
BRM Brighton Medium	SABC Sable Coordinate
BUT Butterscotch	SIE Sienna
CNDC Cinder Coordinate	CST Studio Teak Coordinate
CLA Classic	TRF Truffle
CLL Collectors	UMB Umber
EGRC Egret Coordinate	VALC Valley Coordinate
ESP Espresso	VEN Venetian
FAWC Fawn Coordinate	CWE Weathered Ash Coordinate
FLX Flax	
CGR Graphite Coordinate	

Ship prepaid COM material to:
 JSI

Attn: COM Dept
 201 East Martin Street
 Receiving B, Dock 71
 Orleans, IN 47452

Application of fabric:
 Railroaded Up the Roll



All COM orders will ship at standard lead time from receipt of COM except for orders requiring special custom matched finishes.

5. Optional Rubber Cushion Nylon Glides - no upcharge

4. Fabric Selection - Please supply the following:
 Fabric vendor/Pattern name/Pattern color


For a complete list of JSI Standard and Graded-In Textiles click here

When specifying contrasting upholstery, indicate clearly which upholstery is to be applied to the seat and back. Use higher grade pricing.

- Indicate direction of fabric - Railroaded or Up the Roll
- Please provide illustration, if available

All COM orders must include the following:

- Vendor's name, pattern name and color
- Sample of the fabric attached to order
- Model numbers of items for fabric application

Description	① Model	Specifications			List Price Per Grade	
Guest Chair 	RI2571	Dimensions			COM \$1,039	
		Overall	25	22 ½	31 ½	A \$1,073
		Seat	19	20	18 ¼	B \$1,114
		Arm			25 ½	COL/C \$1,184
		Upholstery		Shipping		D \$1,273
		COM Ydg	1 ½	Ctn Wt	20	E \$1,362
		COL Sq Ft	27	Cu Ft	12	F \$1,500
						G \$1,647
						H \$1,808
						I \$2,054
				J \$2,350		
				L1 \$1,678		
				L2 \$1,835		

To Order, Specify:

- ① Model Number
- ② Wood Species - Maple (M)
- ③ Wood Finish/Color [See Wood Finish Options](#)
- ④ Fabric Selection - vendor, pattern and color
Visit www.jsifurniture.com/finishes-and-materials/textiles for our textiles program. See selection of standard and graded in manufacturers and patterns.
- ⑤ Optional Rubber Cushion Nylon Glides - no upcharge

Specifications

- Wood species - Maple.
- Solid Maple lumber exterior frame.
- Solid lumber interior frame.
- Seat has synthetic sheet webbing and 2" high density polyurethane foam.
- Back has synthetic sheet webbing and 1 ¼" polyurethane foam.
- Mortise and tenon construction with corner blocks, glue and screws.
- Wall saver feature.
- Standard with rubber cushion metal glides.

Sosa Order Check List:



SOSA

Specify:

- 1. Model Number
- 2. Wood Species - Maple (M)
- 3. Wood Finish
- 4. Fabric Selection - vendor, pattern and color
- 5. Optional Back Stitching Detail - Add \$55 list (model SA1061D only)
- 6. Optional Rubber Cushion Nylon Glides - no upcharge

Example:

SA1061D | M | HRV | MOMENTUM | VOX | MYSTIC
 (model #) | (wood species) | (finish) | (fabric vendor) | (pattern name) | (pattern color)

1. Model Number

- Special application instructions (e.g., all stripes will be applied front to back unless specified otherwise)
- Customer and purchase order number

2. Wood Species - Maple (M)

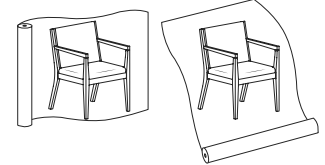
3. Wood Finish Options:

ALM Ale Medium	HRV Harvest
CAL Ale Light Coordinate	CKC Khaki Coordinate
BBM Bourbon Medium	MINC Mineral Coordinate
CBZ Brazilwood Coordinate	MCH Mocha
BARC Barrel Coordinate	CPI Pinnacle Walnut Coordinate
CBO Bourbon Light Coordinate	PRL Praline
CBG Brighton Light Coordinate	RAVC Raven Coordinate
BRM Brighton Medium	SABC Sable Coordinate
BUT Butterscotch	SIE Sienna
CNDC Cinder Coordinate	CST Studio Teak Coordinate
CLA Classic	TRF Truffle
CLL Collectors	UMB Umber
EGRC Egret Coordinate	VALC Valley Coordinate
ESP Espresso	VEN Venetian
FAWC Fawn Coordinate	CWE Weathered Ash Coordinate
FLX Flax	
CGR Graphite Coordinate	

Ship prepaid COM material to:

Application of fabric:
 Railroaded Up the Roll

JSI
 Attn: COM Dept
 201 East Martin Street
 Receiving B, Dock 71
 Orleans, IN 47452



All COM orders will ship at standard lead time from receipt of COM except for orders requiring special custom matched finishes.

4. Fabric Selection - Please supply the following:
 Fabric vendor/Pattern name/Pattern color

For a complete list of JSI Standard and Graded-In Textiles click here

When specifying contrasting upholstery, indicate clearly which upholstery is to be applied to the seat and back. Use higher grade pricing.

- Indicate direction of fabric - Railroaded or Up the Roll
- Please provide illustration, if available

All COM orders must include the following:

- Vendor's name, pattern name and color
- Sample of the fabric attached to order
- Model numbers of items for fabric application

5. Optional Back Stitching Detail - add \$55 list (available on model SA1061D only). Specify SBS001 for Cross Stitch Detail or SBS002 for Dual Horizontal Stitch Detail.






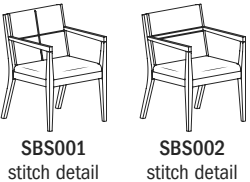
SBS001-
Cross Stitch Detail




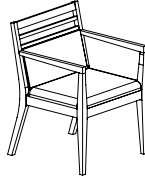
SBS002
Dual Horizontal Stitch Detail

6. Optional Rubber Cushion Nylon Glides - no upcharge

Description	① Model	Specifications				List Price Per Grade	
Guest Chair 	SA1061C · upholstered seat · wood back	Dimensions		D	W	H	COM \$976
		Overall	23 ½	23	33 ¼		
		Seat	19 ½	22 ¾	18		B \$1,000
		Arm			26 ⅞		COL/C \$1,027
		Upholstery		Shipping			D \$1,062
		COM Ydg	¾	Ctn Wt	25		E \$1,098
		COL Sq Ft	14	Cu Ft	12		F \$1,152
							G \$1,210
							H \$1,273
							I \$1,369
							J \$1,486
							L1 \$1,221
							L2 \$1,291
Guest Chair 	SA1061E · upholstered seat · partial upholstered back	Dimensions		D	W	H	COM \$1,115
		Overall	23 ½	23	33 ¼		
		Seat	18 ⅞	22 ¾	18		B \$1,154
		Arm			26 ⅞		COL/C \$1,200
		Upholstery		Shipping			D \$1,258
		COM Ydg	1 ¼	Ctn Wt	28		E \$1,318
		COL Sq Ft	23	Cu Ft	12		F \$1,407
							G \$1,505
							H \$1,607
							I \$1,769
							J \$1,963
							L1 \$1,524
							L2 \$1,640
Guest Chair 	SA1061D · upholstered seat · fully upholstered back · optional back stitching detail available; specify SBS001 or SBS002 - add \$55 list	Dimensions		D	W	H	COM \$1,125
		Overall	23 ½	23	33 ¼		
		Seat	18 ⅞	22 ¾	18		B \$1,172
		Arm			26 ⅞		COL/C \$1,226
		Upholstery		Shipping			D \$1,296
		COM Ydg	1 ½	Ctn Wt	28		E \$1,366
		COL Sq Ft	27	Cu Ft	12		F \$1,474
							G \$1,591
							H \$1,715
							I \$1,908
							J \$2,142
							L1 \$1,614
							L2 \$1,754



Description	① Model	Specifications				List Price Per Grade	
		Dimensions	D	W	H	COM	
Guest Chair 	SA1061F · upholstered seat · wood back slats	Overall	23 1/2	23	33 1/4	COM	\$1,005
		Seat	19 1/2	22 3/8	18	A	\$1,014
		Arm			26 7/8	B	\$1,029
		Upholstery		Shipping		COL/C	\$1,057
		COM Ydg	3/4	Ctn Wt	25	D	\$1,091
		COL Sq Ft	14	Cu Ft	12	E	\$1,127
						F	\$1,182
						G	\$1,239
						H	\$1,301
						I	\$1,399
						J	\$1,514
						L1	\$1,251
						L2	\$1,321


Description	① Model	Specifications				List Price Per Grade	
		Dimensions	D	W	H	COM	
Guest Chair 	SA1061G · upholstered seat · 1/2 upholstered lower back with wood slats	Overall	23 1/2	23	33 1/4	COM	\$1,135
		Seat	18 1/8	22 3/8	18	A	\$1,150
		Arm			26 7/8	B	\$1,174
		Upholstery		Shipping		COL/C	\$1,220
		COM Ydg	1 1/4	Ctn Wt	28	D	\$1,278
		COL Sq Ft	23	Cu Ft	12	E	\$1,337
						F	\$1,426
						G	\$1,525
						H	\$1,626
						I	\$1,788
						J	\$1,983
						L1	\$1,543
						L2	\$1,660


To Order, Specify:

- ① Model Number
- ② Wood Species - Maple (M)
- ③ Wood Finish [See Wood Finish Options](#)
- ④ Fabric Selection - vendor, pattern and color
Visit www.jsifurniture.com/finishes-and-materials/textiles for our textiles program. See selection of standard and graded in manufacturers and patterns.
- ⑤ Optional Back Stitching Detail - add \$55 list (model SA1061D only)
- ⑥ Optional Rubber Cushion Nylon Glides - no upcharge

Specifications

- Wood species - Maple.
- Seat has 1/2" plywood with synthetic sheet webbing and 2" high density polyurethane foam.
- Solid hardwood back frame with synthetic sheet webbing and 1" polyurethane foam.
- Mortise and tenon construction with corner blocks, glue and screws.
- Wall saver feature.
- Standard with rubber cushion metal glides.

Description	① Model	Specifications			List Price Per Grade	
Guest Chair 	SA1061H · upholstered seat · ½ upholstered upper back with wood slats	Dimensions			COM \$1,121	
			D	W	H	A \$1,134
		Overall	23 ½	23	33 ¼	B \$1,160
		Seat	19 ½	22 ¾	18	COL/C \$1,206
		Arm			26 ⅞	D \$1,262
		Upholstery		Shipping		E \$1,322
		COM Ydg	1 ¼	Ctn Wt	25	F \$1,411
COL Sq Ft	23	Cu Ft	12	G \$1,509		
				H \$1,612		
				I \$1,773		
				J \$1,967		
				L1 \$1,529		
				L2 \$1,645		

Guest Chair 	SA1061I · upholstered seat · ¾ upholstered back	Dimensions			COM \$1,128	
			D	W	H	A \$1,142
		Overall	23 ½	23	33 ¼	B \$1,167
		Seat	19 ½	22 ¾	18	COL/C \$1,213
		Arm			26 ⅞	D \$1,271
		Upholstery		Shipping		E \$1,330
		COM Ydg	1 ¼	Ctn Wt	25	F \$1,420
COL Sq Ft	23	Cu Ft	12	G \$1,517		
				H \$1,620		
				I \$1,782		
				J \$1,977		
				L1 \$1,536		
				L2 \$1,654		

To Order, Specify:

- ① Model Number
- ② Wood Species - Maple (M)
- ③ Wood Finish [See Wood Finish Options](#)
- ④ Fabric Selection - vendor, pattern and color
 Visit www.jsifurniture.com/finishes-and-materials/textiles for our textiles program. See selection of standard and graded in manufacturers and patterns.
- ⑤ Optional Rubber Cushion Nylon Glides - no upcharge

Specifications

- Wood species - Maple.
- Seat has ½" plywood with synthetic sheet webbing and 2" high density polyurethane foam.
- Solid hardwood back frame with synthetic sheet webbing and 1" polyurethane foam.
- Mortise and tenon construction with corner blocks, glue and screws.
- Wall saver feature.
- Standard with rubber cushion metal glides.

Tara Order Check List:



Specify:

- 1. Model Number
- 2. Wood Species - Maple (M)
- 3. Wood Base Finish
- 4. Fabric Selection - vendor, pattern and color
- 5. Base Selection - wood base standard; specify wood finish
 - A. Black Polyurethane Base - no upcharge
 - B. Black Pneumatic Jury Base - add \$203 list
- 6. Optional Plastic Bumper Guard - add \$25 list

Example:

TA6095P (model #)	M (wood species)	HRV (finish) wood base	MOMENTUM (fabric vendor)	VOX (pattern name)	MYSTIC (pattern color)
-----------------------------	----------------------------	-------------------------------------	------------------------------------	------------------------------	----------------------------------

1. Model Number

- Special application instructions (e.g., all stripes will be applied front to back unless specified otherwise)
- Customer and purchase order number

2. Wood Species - Maple (M)

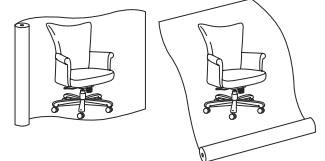
3. Wood Base Finish Options:

ALM Ale Medium	HRV Harvest
CAL Ale Light Coordinate	CKC Khaki Coordinate
BBM Bourbon Medium	MINC Mineral Coordinate
CBZ Brazilwood Coordinate	MCH Mocha
BARC Barrel Coordinate	CPI Pinnacle Walnut Coordinate
CBO Bourbon Light Coordinate	PRL Praline
CBG Brighton Light Coordinate	RAVC Raven Coordinate
BRM Brighton Medium	SABC Sable Coordinate
BUT Butterscotch	SIE Sienna
CNDC Cinder Coordinate	CST Studio Teak Coordinate
CLA Classic	TRF Truffle
CLL Collectors	UMB Umber
EGRC Egret Coordinate	VALC Valley Coordinate
ESPL Espresso	VEN Venetian
FAWC Fawn Coordinate	CWE Weathered Ash Coordinate
FLX Flax	
CGR Graphite Coordinate	

Ship prepaid COM material to:
JSI

Attn: COM Dept
201 East Martin Street
Receiving B, Dock 71
Orleans, IN 47452

Application of fabric:
Railroaded Up the Roll



All COM orders will ship at standard lead time from receipt of COM except for orders requiring special custom matched finishes.

4. Fabric Selection - Please supply the following:
Fabric vendor/Pattern name/Pattern color

For a complete list of JSI Standard and Graded-In Textiles click here

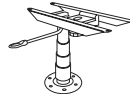
When specifying contrasting upholstery, indicate clearly which upholstery is to be applied to the seat, back and arms. Use higher grade pricing.

- Indicate direction of fabric - Railroaded or Up the Roll
- Please provide illustration, if available

All COM orders must include the following:

- Vendor's name, pattern name and color
- Sample of the fabric attached to order
- Model numbers of items for fabric application


5. Base Selection - wood base standard; specify wood finish
A. Black Polyurethane Base - no upcharge
B. Black Pneumatic Jury Base - add \$203 list





Pneumatic lift - NOT self-centering - Standard


6. Optional Plastic Bumper Guard - add \$25 list


TARA


Description	① Model	Specifications				List Price Per Grade		
Executive Posture 	TA6095P · plain back · standard size · synchro control · adjustable back height · overall height range is 43 ½ - 47 · seat height range is 19 ½ - 23 · arm height range is 26 ½ - 30	Dimensions		D	W	H	COM \$2,890	
		Overall		27 ½	30	47	A \$2,946	
		Seat		19 ½	20 ½	23	B \$3,055	
		Arm					30	COL/C \$3,245
		Upholstery		Shipping				D \$3,491
		COM Ydg		4	Ctn Wt	55	E \$3,738	
		COL Sq Ft		72	Cu Ft	19	F \$3,996	
								G \$4,366
								H \$4,757
								I \$5,369


Executive Posture 	TA6095S · single stitch · standard size · synchro control · adjustable back height · overall height range is 43 ½ - 47 · seat height range is 19 ½ - 23 · arm height range is 26 ½ - 30	Dimensions		D	W	H	COM \$2,963	
		Overall		27 ½	30	47	A \$3,019	
		Seat		19 ½	20 ½	23	B \$3,127	
		Arm					30	COL/C \$3,321
		Upholstery		Shipping				D \$3,565
		COM Ydg		4	Ctn Wt	55	E \$3,809	
		COL Sq Ft		72	Cu Ft	19	F \$4,070	
								G \$4,436
								H \$4,829
								I \$5,442

Executive Posture 	TA6095B · button stitch · standard size · synchro control · adjustable back height · overall height range is 43 ½ - 47 · seat height range is 19 ½ - 23 · arm height range is 26 ½ - 30	Dimensions		D	W	H	COM \$2,967	
		Overall		27 ½	30	47	A \$3,023	
		Seat		19 ½	20 ½	23	B \$3,129	
		Arm					30	COL/C \$3,323
		Upholstery		Shipping				D \$3,568
		COM Ydg		4	Ctn Wt	55	E \$3,814	
		COL Sq Ft		72	Cu Ft	19	F \$4,072	
								G \$4,439
								H \$4,832
								I \$5,449

Executive Swivel 	TA6085P · plain back · standard size · mid-pivot · overall height range is 43 ½ - 47 · seat height range is 19 ½ - 23 · arm height range is 26 ½ - 30	Dimensions		D	W	H	COM \$2,629	
		Overall		26 ½	30	47	A \$2,685	
		Seat		19 ½	20 ½	23	B \$2,795	
		Arm					30	COL/C \$2,984
		Upholstery		Shipping				D \$3,232
		COM Ydg		4	Ctn Wt	55	E \$3,476	
		COL Sq Ft		72	Cu Ft	19	F \$3,735	
								G \$4,104
								H \$4,494
								I \$5,109

Description	① Model	Specifications			List Price Per Grade	
Executive Swivel 	TA6085S • single stitch • standard size • mid-pivot • overall height range is 43 ½ - 47 • seat height range is 19 ½ - 23 • arm height range is 26 ½ - 30	Dimensions	D	W	H	COM \$2,700 A \$2,758 B \$2,865 COL/C \$3,057 D \$3,306 E \$3,548 F \$3,807 G \$4,175 H \$4,567 I \$5,180 J \$5,920 L1 \$4,251 L2 \$4,641
		Overall	26 ½	30	47	
		Seat	19 ½	20 ½	23	
		Arm			30	
		Upholstery	Shipping			
		COM Ydg	4	Ctn Wt	55	
		COL Sq Ft	72	Cu Ft	19	

Executive Swivel 	TA6085B • button stitch • standard size • mid-pivot • overall height range is 43 ½ - 47 • seat height range is 19 ½ - 23 • arm height range is 26 ½ - 30	Dimensions	D	W	H	COM \$2,703 A \$2,761 B \$2,867 COL/C \$3,060 D \$3,308 E \$3,552 F \$3,809 G \$4,177 H \$4,570 I \$5,189 J \$5,922 L1 \$4,253 L2 \$4,645
		Overall	26 ½	30	47	
		Seat	19 ½	20 ½	23	
		Arm			30	
		Upholstery	Shipping			
		COM Ydg	4	Ctn Wt	55	
		COL Sq Ft	72	Cu Ft	19	


Executive Swivel 	TA6075P • plain back • smaller scale • mid-pivot • overall height range is 43 ½ - 47 • seat height range is 19 ½ - 23 • arm height range is 26 ½ - 30	Dimensions	D	W	H	COM \$2,520 A \$2,577 B \$2,685 COL/C \$2,875 D \$3,121 E \$3,367 F \$3,626 G \$3,994 H \$4,385 I \$5,001 J \$5,737 L1 \$4,068 L2 \$4,462
		Overall	26	28	47	
		Seat	18 ½	18 ½	23	
		Arm			30	
		Upholstery	Shipping			
		COM Ydg	4	Ctn Wt	55	
		COL Sq Ft	72	Cu Ft	19	


To Order, Specify:


- ① Model Number
- ② Wood Species - Maple (M)
- ③ Wood Base Finish [See Wood Base Finish Options](#)
- ④ Fabric Selection - vendor, pattern and color
 Visit www.jsifurniture.com/finishes-and-materials/textiles for our textiles program. See selection of standard and graded in manufacturers and patterns.
- ⑤ Base Selection - wood base standard; specify wood finish
 A. Black Polyurethane Base - no upcharge
 B. Black Pneumatic Jury Base - add \$203 list
- ⑥ Optional Plastic Bumper Guard - add \$25 list


Specifications




- Wood species - Maple.
- Seat has synthetic sheet webbing and 4" polyurethane foam.
- Back has synthetic sheet webbing and 1 ¼" polyurethane foam with Dacron® wrap.
- Arms have 1" polyurethane padding with Dacron® wrap.
- Swivel models revolve, have tension control, pneumatic lift, mid-pivot-tilt with a non-locking mechanism and wood cap base with black dual wheel casters.
- Posture models revolve, have back height adjustment, tension control, pneumatic lift, 22° range of travel and multiple position tilt lock.
- Spiral grooved hardwood dowels with corner blocks, glue and screws.

Description	① Model	Specifications				List Price Per Grade		
Executive Swivel 	TA6075S · single stitch · smaller scale · mid-pivot · overall height range is 43 ½ - 47 · seat height range is 19 ½ - 23 · arm height range is 26 ½ - 30	Dimensions		D	W	H	COM \$2,592	
		Overall		26	28	47	A \$2,650	
		Seat		18 ½	18 ½	23	B \$2,758	
		Arm					30	COL/C \$2,951
		Upholstery		Shipping				D \$3,194
		COM Ydg		4	Ctn Wt	55		E \$3,439
		COL Sq Ft		72	Cu Ft	19		F \$3,699
								G \$4,067
								H \$4,461
								I \$5,073

Executive Swivel 	TA6075B · button stitch · smaller scale · mid-pivot · overall height range is 43 ½ - 47 · seat height range is 19 ½ - 23 · arm height range is 26 ½ - 30	Dimensions		D	W	H	COM \$2,597	
		Overall		26	28	47	A \$2,652	
		Seat		18 ½	18 ½	23	B \$2,761	
		Arm					30	COL/C \$2,953
		Upholstery		Shipping				D \$3,198
		COM Ydg		4	Ctn Wt	55		E \$3,443
		COL Sq Ft		72	Cu Ft	19		F \$3,703
								G \$4,070
								H \$4,463
								I \$5,076

Management Posture 	TA6090P · plain back · standard size · synchro control · adjustable back height · overall height range is 40 - 44 · seat height range is 19 ½ - 23 · arm height range is 26 ½ - 30	Dimensions		D	W	H	COM \$2,771	
		Overall		27 ½	30	44	A \$2,826	
		Seat		19 ½	20 ½	23	B \$2,937	
		Arm					30	COL/C \$3,127
		Upholstery		Shipping				D \$3,374
		COM Ydg		4	Ctn Wt	50		E \$3,621
		COL Sq Ft		72	Cu Ft	14		F \$3,879
								G \$4,248
								H \$4,638
								I \$5,253

Management Posture 	TA6090S · single stitch · standard size · synchro control · adjustable back height · overall height range is 40 - 44 · seat height range is 19 ½ - 23 · arm height range is 26 ½ - 30	Dimensions		D	W	H	COM \$2,847	
		Overall		27 ½	30	44	A \$2,903	
		Seat		19 ½	20 ½	23	B \$3,012	
		Arm					30	COL/C \$3,203
		Upholstery		Shipping				D \$3,449
		COM Ydg		4	Ctn Wt	50		E \$3,691
		COL Sq Ft		72	Cu Ft	14		F \$3,952
								G \$4,319
								H \$4,711
								I \$5,326


Description	① Model	Specifications				List Price Per Grade	
Management Posture 	TA6090B • button stitch • standard size • synchro control • adjustable back height • overall height range is 40 - 44 • seat height range is 19 1/2 - 23 • arm height range is 26 1/2 - 30	Dimensions		D	W	H	COM
		Overall	27 1/2	30	44	A	\$2,905
		Seat	19 1/2	20 1/2	23	B	\$3,015
		Arm	30			COL/C	\$3,207
		Upholstery		Shipping		D	\$3,451
		COM Ydg	4	Ctn Wt	50	E	\$3,696
		COL Sq Ft	72	Cu Ft	14	F	\$3,955
						G	\$4,324
						H	\$4,717
						I	\$5,330
						J	\$6,066
						L1	\$4,397
						L2	\$4,790
Management Swivel 	TA6080P • plain back • standard size • mid-pivot • overall height range is 39 1/2 - 43 • seat height range is 19 1/2 - 23 • arm height range is 26 1/2 - 30	Dimensions		D	W	H	COM
		Overall	25 1/2	30	43	A	\$2,511
		Seat	19 1/2	20 1/2	23	B	\$2,679
		Arm	30			COL/C	\$2,866
		Upholstery		Shipping		D	\$3,115
		COM Ydg	4	Ctn Wt	50	E	\$3,359
		COL Sq Ft	72	Cu Ft	14	F	\$3,620
						G	\$3,986
						H	\$4,377
						I	\$4,993
						J	\$5,729
						L1	\$4,060
						L2	\$4,450
Management Swivel 	TA6080S • single stitch • standard size • mid-pivot • overall height range is 39 1/2 - 43 • seat height range is 19 1/2 - 23 • arm height range is 26 1/2 - 30	Dimensions		D	W	H	COM
		Overall	25 1/2	30	43	A	\$2,585
		Seat	19 1/2	20 1/2	23	B	\$2,749
		Arm	30			COL/C	\$2,940
		Upholstery		Shipping		D	\$3,187
		COM Ydg	4	Ctn Wt	50	E	\$3,431
		COL Sq Ft	72	Cu Ft	14	F	\$3,689
						G	\$4,059
						H	\$4,449
						I	\$5,064
						J	\$5,802
						L1	\$4,132
						L2	\$4,524


To Order, Specify:


- ① Model Number
- ② Wood Species - Maple (M)
- ③ Wood Base Finish [See Wood Base Finish Options](#)
- ④ Fabric Selection - vendor, pattern and color
 Visit www.jsifurniture.com/finishes-and-materials/textiles for our textiles program. See selection of standard and graded in manufacturers and patterns.
- ⑤ Base Selection - wood base standard; specify wood finish
 A. Black Polyurethane Base - no upcharge
 B. Black Pneumatic Jury Base - add \$203 list
- ⑥ Optional Plastic Bumper Guard - add \$25 list

Specifications


- Wood species - Maple.
- Seat has synthetic sheet webbing and 4" polyurethane foam.
- Back has synthetic sheet webbing and 1 1/4" polyurethane foam with Dacron® wrap.
- Arms have 1" polyurethane padding with Dacron® wrap.
- Swivel models revolve, have tension control, pneumatic lift, mid-pivot-tilt with a non-locking mechanism and wood cap base with black dual wheel casters.
- Posture models revolve, have back height adjustment, tension control, pneumatic lift, 22° range of travel and multiple position tilt lock.
- Spiral grooved hardwood dowels with corner blocks, glue and screws.

Description	① Model	Specifications				List Price Per Grade		
Management Swivel 	TA6080B · button stitch · standard size · mid-pivot · overall height range is 39 ½ - 43 · seat height range is 19 ½ - 23 · arm height range is 26 ½ - 30	Dimensions		D	W	H	COM \$2,589	
		Overall	25 ½	30	43	A \$2,644		
		Seat	19 ½	20 ½	23	B \$2,754		
		Arm			30	COL/C \$2,944		
		Upholstery		Shipping		D \$3,190		
		COM Ydg	4	Ctn Wt	50	E \$3,435		
		COL Sq Ft	72	Cu Ft	14	F \$3,691		
								G \$4,063
								H \$4,455
								I \$5,068
						J \$5,805		
						L1 \$4,135		
						L2 \$4,528		

Description	① Model	Specifications				List Price Per Grade		
Management Swivel 	TA6070P · plain back · smaller scale · mid-pivot · overall height range is 39 ½ - 43 · seat height range is 19 ½ - 23 · arm height range is 26 ½ - 30	Dimensions		D	W	H	COM \$2,401	
		Overall	25	28	43	A \$2,456		
		Seat	18 ½	18 ½	23	B \$2,564		
		Arm			30	COL/C \$2,757		
		Upholstery		Shipping		D \$3,001		
		COM Ydg	4	Ctn Wt	50	E \$3,247		
		COL Sq Ft	72	Cu Ft	14	F \$3,506		
								G \$3,873
								H \$4,266
								I \$4,881
						J \$5,617		
						L1 \$3,948		
						L2 \$4,340		

Description	① Model	Specifications				List Price Per Grade		
Management Swivel 	TA6070S · single stitch · smaller scale · mid-pivot · overall height range is 39 ½ - 43 · seat height range is 19 ½ - 23 · arm height range is 26 ½ - 30	Dimensions		D	W	H	COM \$2,471	
		Overall	25	28	43	A \$2,529		
		Seat	18 ½	18 ½	23	B \$2,637		
		Arm			30	COL/C \$2,826		
		Upholstery		Shipping		D \$3,075		
		COM Ydg	4	Ctn Wt	50	E \$3,321		
		COL Sq Ft	72	Cu Ft	14	F \$3,580		
								G \$3,947
								H \$4,339
								I \$4,954
						J \$5,689		
						L1 \$4,020		
						L2 \$4,414		

TARA

Description	① Model	Specifications				List Price Per Grade	
Management Swivel 	TA6070B • button stitch • smaller scale • mid-pivot • overall height range is 39 ½ - 43 • seat height range is 19 ½ - 23 • arm height range is 26 ½ - 30	Dimensions		D	W	H	COM \$2,474
		Overall	25	28	43		
		Seat	18 ½	18 ½	23		B \$2,640
		Arm			30		COL/C \$2,832
		Upholstery		Shipping			D \$3,077
		COM Ydg	4	Ctn Wt	50		E \$3,323
		COL Sq Ft	72	Cu Ft	14		F \$3,582
							G \$3,950
							H \$4,341
							I \$4,956
							J \$5,691
							L1 \$4,023
							L2 \$4,416

TARA

To Order, Specify:

- ① Model Number
- ② Wood Species - Maple (M)
- ③ Wood Base Finish [See Wood Base Finish Options](#)
- ④ Fabric Selection - vendor, pattern and color
Visit www.jsifurniture.com/finishes-and-materials/textiles for our textiles program. See selection of standard and graded in manufacturers and patterns.
- ⑤ Base Selection - wood base standard; specify wood finish
 - A. Black Polyurethane Base - no upcharge
 - B. Black Pneumatic Jury Base - add \$203 list
- ⑥ Optional Plastic Bumper Guard - add \$25 list

Specifications

- Wood species - Maple.
- Seat has synthetic sheet webbing and 4" polyurethane foam.
- Back has synthetic sheet webbing and 1 ¼" polyurethane foam with Dacron® wrap.
- Arms have 1" polyurethane padding with Dacron® wrap.
- Swivel models revolve, have tension control, pneumatic lift, mid-pivot-tilt with a non-locking mechanism and wood cap base with black dual wheel casters.
- Posture models revolve, have back height adjustment, tension control, pneumatic lift, 22° range of travel and multiple position tilt lock.
- Spiral grooved hardwood dowels with corner blocks, glue and screws.

Tara Order Check List:



Specify:

- 1. Model Number
- 2. Wood Species - Maple (M)
- 3. Wood Finish
- 4. Fabric Selection - vendor, pattern and color
- 5. Optional Rubber Cushion Nylon Glides - no upcharge

Example:

TA6081P (model #)	M (wood species)	HRV (finish) wood legs	MOMENTUM (fabric vendor)	VOX (pattern name)	MYSTIC (pattern color)
-----------------------------	----------------------------	-------------------------------------	------------------------------------	------------------------------	----------------------------------

1. Model Number

2. Wood Species - Maple (M)

3. Wood Leg Finish Options:

ALM Ale Medium	HRV Harvest
CAL Ale Light Coordinate	CKC Khaki Coordinate
BBM Bourbon Medium	MINC Mineral Coordinate
CBZ Brazilwood Coordinate	MCH Mocha
BARC Barrel Coordinate	CPI Pinnacle Walnut Coordinate
CBO Bourbon Light Coordinate	PRL Praline
CBG Brighton Light Coordinate	RAVC Raven Coordinate
BRM Brighton Medium	SABC Sable Coordinate
BUT Butterscotch	SIE Sienna
CNDC Cinder Coordinate	CST Studio Teak Coordinate
CLA Classic	TRF Truffle
CLL Collectors	UMB Umber
EGRC Egret Coordinate	VALC Valley Coordinate
ESP Espresso	VEN Venetian
FAWC Fawn Coordinate	CWE Weathered Ash Coordinate
FLX Flax	
CGR Graphite Coordinate	

4. Fabric Selection - Please supply the following:

Fabric vendor/Pattern name/Pattern color

For a complete list of JSI Standard and Graded-In Textiles click here

When specifying contrasting upholstery, indicate clearly which upholstery is to be applied to the seat, back and arms. Use higher grade pricing.

- Indicate direction of fabric - Railroaded or Up the Roll
- Please provide illustration, if available

All COM orders must include the following:

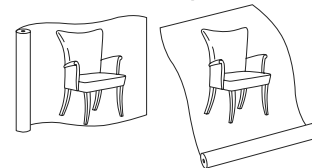
- Vendor's name, pattern name and color
- Sample of the fabric attached to order
- Model numbers of items for fabric application
- Special application instructions (e.g., all stripes will be applied front to back unless specified otherwise)
- Customer and purchase order number

Ship prepaid COM material to:

JSI
Attn: COM Dept
201 East Martin Street
Receiving B, Dock 71
Orleans, IN 47452


Application of fabric:


Railroaded Up the Roll




All COM orders will ship at standard lead time from receipt of COM except for orders requiring special custom matched finishes.

5. Optional Rubber Cushion Nylon Glides - no upcharge

Description	Model	Specifications			List Price Per Grade	
Guest Chair 	TA6081P · plain back	Dimensions	D	W	H	COM \$2,108
		Overall	28	29½	39	A \$2,165
		Seat	20	19½	19	B \$2,273
		Arm			26½	COL/C \$2,464
		Upholstery	Shipping			D \$2,709
		COM Ydg	4	Ctn Wt	28	E \$2,955
		COL Sq Ft	72	Cu Ft	12	F \$3,213
						G \$3,582
						H \$3,974
						I \$4,589
				J \$5,325		
				L1 \$3,653		
				L2 \$4,047		

Guest Chair 	TA6081S · single stitch	Dimensions	D	W	H	COM \$2,179
		Overall	28	29½	39	A \$2,236
		Seat	20	19½	19	B \$2,344
		Arm			26½	COL/C \$2,536
		Upholstery	Shipping			D \$2,784
		COM Ydg	4	Ctn Wt	28	E \$3,028
		COL Sq Ft	72	Cu Ft	12	F \$3,286
						G \$3,652
						H \$4,045
						I \$4,660
				J \$5,399		
				L1 \$3,728		
				L2 \$4,119		

Guest Chair 	TA6081B · button stitch	Dimensions	D	W	H	COM \$2,186
		Overall	28	29½	39	A \$2,238
		Seat	20	19½	19	B \$2,348
		Arm			26½	COL/C \$2,539
		Upholstery	Shipping			D \$2,786
		COM Ydg	4	Ctn Wt	28	E \$3,031
		COL Sq Ft	72	Cu Ft	12	F \$3,290
						G \$3,657
						H \$4,049
						I \$4,666
				J \$5,402		
				L1 \$3,732		
				L2 \$4,122		

To Order, Specify:

- 1 Model Number
- 2 Wood Species - Maple (M)
- 3 Wood Base Finish [See Wood Base Finish Options](#)
- 4 Fabric Selection - vendor, pattern and color
Visit www.jsifurniture.com/finishes-and-materials/textiles for our textiles program. See selection of standard and graded in manufacturers and patterns.
- 5 Optional Rubber Cushion Nylon Glides - no upcharge

Specifications

- Wood species - Maple.
- Seat has synthetic sheet webbing and 4" polyurethane foam.
- Back has polypropylene webbing, 1 ¼" polyurethane foam with Dacron® wrap.
- Arms have 1" polyurethane foam with Dacron wrap.
- Spiral grooved hardwood dowels with corner blocks, glue and screws.
- Standard with rubber cushion metal glides.

TARA

Teekan Lounge Order Check List:



Specify:

- 1. Model Number
- 2. Fabric Selection
 - A. Single Upholstery Models : Vendor, Pattern and Color
 - B. Multiple Upholstery Models (_M): Vendor, Pattern and Color each per zone
- 3. Back Cushion - Plain (PBC) or Quilted (QBC), specify and upcharge applies
- 4. Seat Cushion - Plain (PSC) or Quilted (QSC), specify and upcharge applies
- 5. Foot Option
 - A. Metal Finish (MF) upcharge applies for Chrome \$30
 - B. Wood (WF) add \$324
 - C. Sled Foot (SF) add \$296
- 6. Arm Caps - Wood (WAC) add \$195, Solid Surface (SAC) add \$314 or 3D Black Laminate (B3LAC), add \$195 list per set

Example:

TK1613 (model #)	Momentum (fabric vendor)	Boom (pattern name)	Pewter (pattern color)	PBC (back cushion)	PBC (seat cushion)	MF (foot option)	ASL (foot finish)
----------------------------	------------------------------------	-------------------------------	----------------------------------	------------------------------	------------------------------	----------------------------	-----------------------------

1. Model Number

Fabric Application

2. Fabric Selection - Please supply the following:
Fabric vendor/ Pattern name/ Pattern color

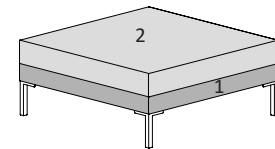
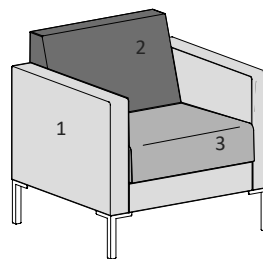
Teekan affords the ability to be specified with multiple upholsteries to create a unique look. Upholstery zones are defined by the style of the unit.

[For a complete list of JSI Standard and Graded-In Textiles click here](#)

- Indicate direction of fabric - Railroaded or Up the Roll
- Please provide illustration, if available

All COM orders must include the following:

- Vendor's name, pattern name and color
- Sample of the fabric attached to the order
- Model numbers of items for fabric application
- Special application instructions
- Customer and purchase order number



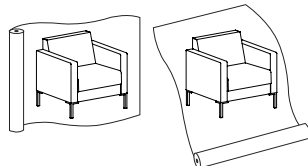
Seating:
Zone 1 = Frame
Zone 2 = Back Cushion
Zone 3 = Seat Cushion

Ottoman:
Zone 1 = Apron
Zone 2 = Seat Cushion

Ship prepaid COM material to:

Application of fabric:
Railroaded Up the Roll

JSI
Attn: COM Department
201 East Martin Street
Receiving B, Dock 71
Orleans, IN 47452



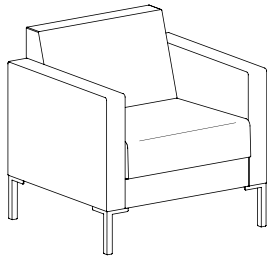
Models ending with _M designate multiple upholstery zones are available (ex: TK1611_M). To calculate pricing, add base price + zone 1 + zone 2 upcharge + zone 3 upcharge

All COM orders will ship at standard lead time from receipt of COM except for orders requiring special custom matched finishes.

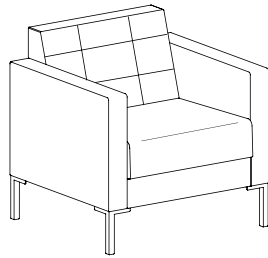
Models are presented as both single upholstery and multiple upholstery in both the price list and in eTools.

3 & 4. Back & Seat Cushion:

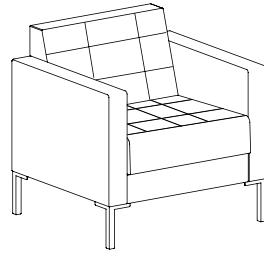
Back & Seat cushions are offered in two back styles for aesthetic appeal; Plain or Quilted. All cushions are fixed.



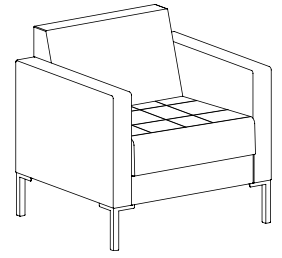
**Plain Back (PBC)
Plain Seat (PSC)**



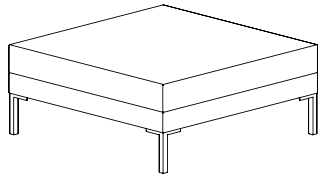
**Quilted Back (QBC)
Plain Seat (PSC)**



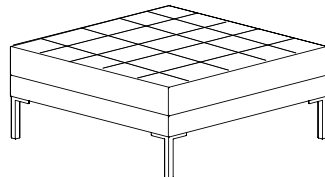
**Quilted Back (QBC)
Quilted Seat (QSC)**



**Plain Back (PBC)
Quilted Seat (QSC)**



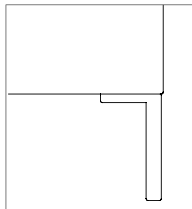
**Plain Seat
(PSC)**



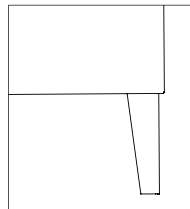
**Quilted Seat
(QSC)**

5. Foot Options for Lounge Seating and Ottomans:

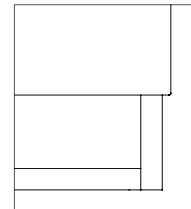
Sled base foot available on lounge seating units only.



Metal Foot (MF)



**Wood Foot (WF)
+ \$324 list**



**Sled Foot (SF)
+ \$296 list**

Maple Finishes available on both Wood and Sled Foot Styles:

ABZ Aged Bronze
ASL Arctic Silver
GLD Gold
MBK Matte Black
PEW Pewter
SBZ Soft Bronze
SNK Soft Nickel
CHR Chrome + \$30 list

ALM Ale Medium
CAL Ale Light Coordinate
BBM Bourbon Medium
CBZ Brazilwood Coordinate
BARC Barrel Coordinate
CBO Bourbon Light Coordinate
CBG Brighton Light Coordinate
BRM Brighton Medium
BUT Butterscotch
CNDC Cinder Coordinate
CLA Classic

CLL Collectors
EGRC Egret Coordinate
ESP Espresso
FAWC Fawn Coordinate
FLX Flax
CGR Graphitae Coordinate
HRV Harvest
CKC Khaki Coordinate
MINC Mineral Coordinate
MCH Mocha
CPI Pinnacle Walnut Coordinate

PRL Praline
RAVC Raven Coordinate
SABC Sable Coordinate
SIE Sienna
CST Studio Teak Coordinate
TRF Truffle
UMB Umber
VALC Valley Coordinate
VEN Venetian
CWE Weathered Ash Coordinate

6. Arm Cap

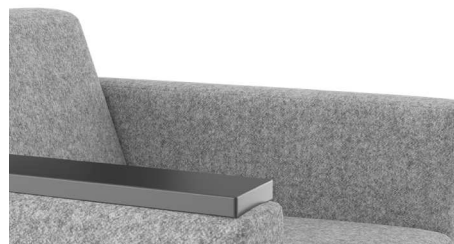
Available in wood, solid surface and 3D Black Laminate. 3D Black laminate is fully sealed to prevent water, bacteria and dirt from penetrating through surface.

A. Wood (WAC) - add \$195 per set
In same wood seating finishes listed above for foot options.

B. Solid Surface (SAC) - add \$314 per set

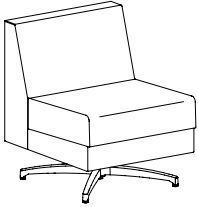
ARM Armadillo
BLP Black Pearl
PEB Pebble Pearl
PUR Pure White

C. Black 3D Laminate (B3LAC) - add \$195 per set



Description + General Information

Swivel Club Chair with 4 Star Base - Armless



- four star 30" diameter polished aluminum base with glide
- discreet cleanout feature allows for easier cleaning between the back and the seat
- under mount power center available - order EC30 separately

Dimensions	D	W	H	Shipping	
				Ctn Wt	Cu Ft
Overall	27 ½	24 ½	31	48	
Seat	20	24 ½	18	13	

	Single Upholstery	Frame Zone 1	Back Zone 2	Seat Zone 3
COM Ydg	2 ¾	½	1 ½	1 ¼
COL Sq Ft	50	9	27	22

Single Upholstery Specify: Model | Upholstery | Back Style | Seat Style

TK1603														
	COM	COL	A	B	C	D	E	F	G	H	I	J	L1	L2
Single Uph	\$1,384	\$1,531	\$1,408	\$1,452	\$1,531	\$1,632	\$1,734	\$1,891	\$2,060	\$2,239	\$2,520	\$2,857	\$2,093	\$2,295

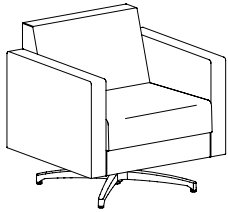
Multiple Upholstery Specify: Model | Frame Upholstery | Back Uph | Seat Uph | Back Style | Seat Style

TK1603_M														
Base Price: \$1,384	To the Base Price, add the appropriate upcharges by grade, per zone													
	COM	COL	A	B	C	D	E	F	G	H	I	J	L1	L2
Frame - Zone 1	+\$0	+\$36	+\$7	+\$17	+\$36	+\$61	+\$85	+\$122	+\$163	+\$207	+\$273	+\$354	+\$171	+\$220
Back - Zone 2	+\$0	+\$92	+\$16	+\$43	+\$92	+\$155	+\$218	+\$315	+\$420	+\$531	+\$705	+\$914	+\$440	+\$566
Seat - Zone 3	+\$0	+\$71	+\$13	+\$33	+\$71	+\$120	+\$169	+\$244	+\$325	+\$412	+\$546	+\$708	+\$341	+\$438

Model	Upholstery	Back Style	Seat Style
	Grade Vendor Pattern Colorway	PBC Plain Back Cushion QBC Quilted Back Cushion, add \$117	PSC Plain Seat Cushion QSC Quilted Seat Cushion, add \$117

Description + General Information

Swivel Club Chair with 4 Star Base



- four star 30" diameter polished aluminum base with glide
- discreet cleanout feature allows for easier cleaning between the back and the seat
- under mount power center available - order EC30 separately

Dimensions	D	W	H	Shipping	
Overall	27 ½	30 ½	31	Ctn Wt	70
Seat	20	23 ½	18	Cu Ft	15
Arm			25 ½		

	Single Upholstery	Frame Zone 1	Back Zone 2	Seat Zone 3
COM Ydg	4 ½	3	1 ½	1 ¼
COL Sq Ft	81	51	27	22

Single Upholstery Specify: Specify: Model | Upholstery | Back Style | Seat Style | Arm Cap

TK1601														
	COM	COL	A	B	C	D	E	F	G	H	I	J	L1	L2
Single Uph	\$2,043	\$2,292	\$2,082	\$2,158	\$2,292	\$2,465	\$2,636	\$2,903	\$3,190	\$3,496	\$3,972	\$4,547	\$3,248	\$3,592

Multiple Upholstery Specify: Model | Frame Upholstery | Back Uph | Seat Uph | Back Style | Seat Style | Arm Cap

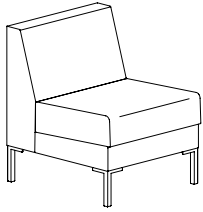
TK1601_M														
Base Price: \$2,043		To the Base Price, add the appropriate upcharges by grade, per zone												
	COM	COL	A	B	C	D	E	F	G	H	I	J	L1	L2
Frame - Zone 1	+\$0	+\$171	+\$27	+\$79	+\$171	+\$289	+\$405	+\$588	+\$784	+\$992	+\$1,318	+\$1,709	+\$823	+\$1,058
Back - Zone 2	+\$0	+\$92	+\$15	+\$43	+\$92	+\$154	+\$217	+\$314	+\$420	+\$530	+\$705	+\$914	+\$440	+\$566
Seat - Zone 3	+\$0	+\$71	+\$12	+\$33	+\$71	+\$120	+\$169	+\$243	+\$324	+\$412	+\$546	+\$708	+\$341	+\$438

- arm considered part of frame

Model	Upholstery	Back Style	Seat Style	Arm Cap
	Grade Vendor Pattern Colorway	PBC Plain Back Cushion QBC Quilted Back Cushion, add \$117	PSC Plain Seat Cushion QSC Quilted Seat Cushion, add \$117	NAC No Arm Cap B3LAC Black 3D Laminate, add \$195 per set WAC Wood, add \$195 per set See JSI Standard Seating Finishes SAC Solid Surface, add \$314 per set See JSI Standard Solid Surfaces

Description + General Information

Single Seat Lounge - Armless



- discreet cleanout feature allows for easier cleaning between the back and the seat
- under mount power center available - order EC30 separately

Dimensions	D	W	H	Shipping	
				Ctn Wt	Cu Ft
Overall	27 ½	24 ½	31	43	
Seat	20	24 ½	18	13	

	Single Upholstery	Frame Zone 1	Back Zone 2	Seat Zone 3
COM Ydg	2 ¾	½	1 ½	1 ¼
COL Sq Ft	50	9	27	22

Single Upholstery Specify: Model | Upholstery | Back Style | Seat Style | Foot Style

TK1613														
	COM	COL	A	B	C	D	E	F	G	H	I	J	L1	L2
Single Uph	\$1,191	\$1,337	\$1,213	\$1,258	\$1,337	\$1,439	\$1,539	\$1,697	\$1,865	\$2,045	\$2,326	\$2,663	\$1,899	\$2,102

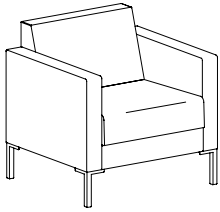
Multiple Upholstery Specify: Model | Frame Upholstery | Back Uph | Seat Uph | Back Style | Seat Style | Foot Style

TK1613_M														
Base Price: \$1,191	To the Base Price, add the appropriate upcharges by grade, per zone													
	COM	COL	A	B	C	D	E	F	G	H	I	J	L1	L2
Frame - Zone 1	+\$0	+\$36	+\$7	+\$17	+\$36	+\$61	+\$85	+\$122	+\$162	+\$207	+\$273	+\$354	+\$171	+\$220
Back - Zone 2	+\$0	+\$92	+\$15	+\$43	+\$92	+\$155	+\$217	+\$315	+\$419	+\$531	+\$705	+\$914	+\$440	+\$566
Seat - Zone 3	+\$0	+\$71	+\$12	+\$33	+\$71	+\$120	+\$169	+\$244	+\$324	+\$412	+\$546	+\$708	+\$341	+\$438

Model	Upholstery	Back Style	Seat Style	Foot Style
	Grade Vendor Pattern Colorway	PBC Plain Back Cushion QBC Quilted Back Cushion, add \$117	PSC Plain Seat Cushion QSC Quilted Seat Cushion, add \$117	MF Metal Foot See Teekan Metal Finishes WF Wood Foot, add \$324 See JSI Standard Seating Finishes SF Sled Foot, add \$296 See JSI Standard Seating Finishes

Description + General Information

Single Seat Lounge



- discreet cleanout feature allows for easier cleaning between the back and the seat
- under mount power center available - order EC30 separately

Dimensions	D	W	H	Shipping	
Overall	27 ½	30 ½	31	Ctn Wt	65
Seat	20	23 ½	18	Cu Ft	15
Arm			25 ½		

	Single Upholstery	Frame Zone 1	Back Zone 2	Seat Zone 3
COM Ydg	4 ½	3	1 ½	1 ¼
COL Sq Ft	81	51	27	22

Single Upholstery Specify: Model | Upholstery | Back Style | Seat Style | Foot Style | Arm Cap

TK1611														
	COM	COL	A	B	C	D	E	F	G	H	I	J	L1	L2
Single Uph	\$1,753	\$2,001	\$1,791	\$1,868	\$2,001	\$2,172	\$2,346	\$2,613	\$2,900	\$3,206	\$3,683	\$4,256	\$2,958	\$3,301

Multiple Upholstery Specify: Model | Frame Upholstery | Back Uph | Seat Uph | Back Style | Seat Style | Foot Style | Arm Cap

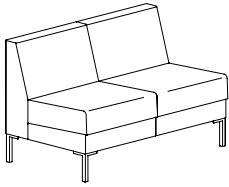
TK1611_M														
Base Price: \$1,753	To the Base Price, add the appropriate upcharges by grade, per zone													
	COM	COL	A	B	C	D	E	F	G	H	I	J	L1	L2
Frame - Zone 1	+\$0	+\$171	+\$27	+\$79	+\$171	+\$287	+\$405	+\$588	+\$784	+\$992	+\$1,318	+\$1,709	+\$823	+\$1,057
Back - Zone 2	+\$0	+\$92	+\$15	+\$43	+\$92	+\$154	+\$217	+\$314	+\$420	+\$530	+\$705	+\$914	+\$440	+\$565
Seat - Zone 3	+\$0	+\$71	+\$12	+\$33	+\$71	+\$119	+\$169	+\$243	+\$324	+\$412	+\$546	+\$708	+\$341	+\$438

- arm considered part of frame

Model	Upholstery	Back Style	Seat Style	Foot Style	Arm Cap
	Grade Vendor Pattern Colorway	PBC Plain Back Cushion QBC Quilted Back Cushion, add \$117	PSC Plain Seat Cushion QSC Quilted Seat Cushion, add \$117	MF Metal Foot See Teekan Metal Finishes WF Wood Foot, add \$324 See JSI Standard Seating Finishes SF Sled Foot, add \$296 See JSI Standard Seating Finishes	NAC No Arm Cap B3LAC Black 3D Laminated, add \$195 per set WAC Wood, add \$195 per set See JSI Standard Seating Finishes SAC Solid Surface, add \$314 per set See JSI Standard Solid Surfaces

Description + General Information

Two Seat Lounge - Armless



- discreet cleanout feature allows for easier cleaning between the back and the seat
- under mount power center available - order EC30 separately

Dimensions	D	W	H	Shipping	
Overall	27 ½	48 ½	31	Ctn Wt	86
Seat	20	48 ½	18	Cu Ft	24

	Single Upholstery	Frame Zone 1	Back Zone 2	Seat Zone 3
COM Ydg	4	½	2 ½	1 ½
COL Sq Ft	72	15	45	26

Single Upholstery Specify: Model | Upholstery | Back Style | Seat Style | Foot Style

TK1623														
	COM	COL	A	B	C	D	E	F	G	H	I	J	L1	L2
Single Uph	\$1,775	\$2,038	\$1,816	\$1,897	\$2,038	\$2,220	\$2,402	\$2,685	\$2,989	\$3,312	\$3,819	\$4,425	\$3,050	\$3,414

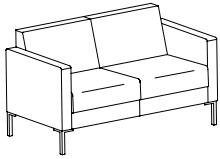
Multiple Upholstery Specify: Model | Frame Upholstery | Back Uph | Seat Uph | Back Style | Seat Style | Foot Style

TK1623_M														
Base Price: \$1,775	To the Base Price, add the appropriate upcharges by grade, per zone													
	COM	COL	A	B	C	D	E	F	G	H	I	J	L1	L2
Frame - Zone 1	+\$0	+\$41	+\$8	+\$20	+\$41	+\$70	+\$99	+\$143	+\$190	+\$240	+\$319	+\$414	+\$199	+\$256
Back - Zone 2	+\$0	+\$142	+\$23	+\$66	+\$142	+\$238	+\$336	+\$486	+\$648	+\$820	+\$1,091	+\$1,415	+\$681	+\$875
Seat - Zone 3	+\$0	+\$101	+\$17	+\$47	+\$101	+\$169	+\$238	+\$345	+\$460	+\$582	+\$773	+\$1,002	+\$482	+\$621

Model	Upholstery	Back Style	Seat Style	Foot Style
	Grade Vendor Pattern Colorway	PBC Plain Back Cushion QBC Quilted Back Cushion, add \$176	PSC Plain Seat Cushion QSC Quilted Seat Cushion, add \$176	MF Metal Foot See Teekan Metal Finishes WF Wood Foot, add \$324 See JSI Standard Seating Finishes SF Sled Foot, add \$296 See JSI Standard Seating Finishes

Description + General Information

Two Seat Lounge



- discreet cleanout feature allows for easier cleaning between the back and the seat
- under mount power center available - order EC30 separately

Dimensions	D	W	H	Shipping	
Overall	27 ½	55	31	Ctn Wt	65
Seat	20	47 ½	18	Cu Ft	15
Arm			25 ½		

	Single Upholstery	Frame Zone 1	Back Zone 2	Seat Zone 3
COM Ydg	5 ¼	3	2 ½	1 ½
COL Sq Ft	95	51	45	26

Single Upholstery Specify: Model | Upholstery | Back Style | Seat Style | Foot Style | Arm Cap

TK1621														
	COM	COL	A	B	C	D	E	F	G	H	I	J	L1	L2
Single Uph	\$2,361	\$2,697	\$2,413	\$2,516	\$2,697	\$2,930	\$3,163	\$3,524	\$3,911	\$4,326	\$4,973	\$5,748	\$3,990	\$4,455

Multiple Upholstery Specify: Model | Frame Upholstery | Back Uph | Seat Uph | Back Style | Seat Style | Foot Style | Arm Cap

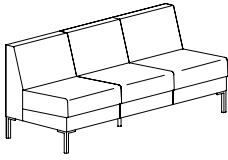
TK1621_M														
Base Price: \$2,361		To the Base Price, add the appropriate upcharges by grade, per zone												
	COM	COL	A	B	C	D	E	F	G	H	I	J	L1	L2
Frame - Zone 1	+\$0	+\$185	+\$29	+\$86	+\$185	+\$313	+\$440	+\$638	+\$850	+\$1,078	+\$1,431	+\$1,857	+\$893	+\$1,148
Back - Zone 2	+\$0	+\$141	+\$23	+\$66	+\$141	+\$238	+\$336	+\$486	+\$648	+\$822	+\$1,091	+\$1,415	+\$681	+\$875
Seat - Zone 3	+\$0	+\$100	+\$17	+\$47	+\$100	+\$170	+\$238	+\$345	+\$460	+\$582	+\$773	+\$1,002	+\$482	+\$621

- arm considered part of frame

Model	Upholstery	Back Style	Seat Style	Foot Style	Arm Cap
	Grade Vendor Pattern Colorway	PBC Plain Back Cushion QBC Quilted Back Cushion, add \$176	PSC Plain Seat Cushion QSC Quilted Seat Cushion, add \$176	MF Metal Foot See Teekan Metal Finishes WF Wood Foot, add \$324 See JSI Standard Seating Finishes SF Sled Foot, add \$296 See JSI Standard Seating Finishes	NAC No Arm Cap B3LAC Black 3D Laminate, add \$195 per set WAC Wood, add \$195 per set See JSI Standard Seating Finishes SAC Solid Surface, add \$314 per set See JSI Standard Solid Surfaces

Description + General Information

Three Seat Lounge - Armless



- discreet cleanout feature allows for easier cleaning between the back and the seat
- under mount power center available - order EC30 separately

Dimensions	D	W	H	Shipping	
				Ctn Wt	103
Overall	27 ½	71 ½	31	Cu Ft	36
Seat	20	71 ½	18		

	Single Upholstery	Frame Zone 1	Back Zone 2	Seat Zone 3
COM Ydg	5 ½	1	3 ¼	1 ¼
COL Sq Ft	99	15	56	57

Single Upholstery Specify: Model | Upholstery | Back Style | Seat Style | Foot Style

TK1633														
	COM	COL	A	B	C	D	E	F	G	H	I	J	L1	L2
Single Uph	\$2,544	\$2,894	\$2,598	\$2,705	\$2,894	\$3,137	\$3,380	\$3,757	\$4,162	\$4,594	\$5,268	\$6,078	\$4,243	\$4,729

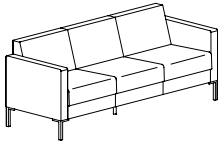
Multiple Upholstery Specify: Model | Frame Upholstery | Back Uph | Seat Uph | Back Style | Seat Style | Foot Style

TK1633_M														
Base Price: \$2,544	To the Base Price, add the appropriate upcharges by grade, per zone													
	COM	COL	A	B	C	D	E	F	G	H	I	J	L1	L2
Frame - Zone 1	+\$0	+\$48	+\$9	+\$23	+\$48	+\$80	+\$112	+\$162	+\$217	+\$274	+\$364	+\$472	+\$228	+\$293
Back - Zone 2	+\$0	+\$185	+\$29	+\$86	+\$185	+\$312	+\$440	+\$638	+\$850	+\$1,077	+\$1,431	+\$1,857	+\$893	+\$1,148
Seat - Zone 3	+\$0	+\$144	+\$23	+\$67	+\$144	+\$243	+\$343	+\$497	+\$662	+\$838	+\$1,114	+\$1,444	+\$695	+\$893

Model	Upholstery	Back Style	Seat Style	Foot Style
	Grade Vendor Pattern Colorway	PBC Plain Back Cushion QBC Quilted Back Cushion, add \$234	PSC Plain Seat Cushion QSC Quilted Seat Cushion, add \$234	MF Metal Foot See Teekan Metal Finishes WF Wood Foot, add \$324 See JSI Standard Seating Finishes SF Sled Foot, add \$296 See JSI Standard Seating Finishes

Description + General Information

Three Seat Lounge



- discreet cleanout feature allows for easier cleaning between the back and the seat
- under mount power center available - order EC30 separately

Dimensions	D	W	H	Shipping	
Overall	27 ½	78	31	Ctn Wt	130
Seat	20	70 ½	18	Cu Ft	39
Arm			25 ½		

	Single Upholstery	Frame Zone 1	Back Zone 2	Seat Zone 3
COM Ydg	7	3	2 ½	1 ½
COL Sq Ft	126	56	56	47

Single Upholstery Specify: Model | Upholstery | Back Style | Seat Style | Foot Style | Arm Cap

TK1631														
	COM	COL	A	B	C	D	E	F	G	H	I	J	L1	L2
Single Uph	\$3,045	\$3,498	\$3,114	\$3,253	\$3,498	\$3,811	\$4,125	\$4,613	\$5,136	\$5,693	\$6,565	\$7,610	\$5,240	\$5,868

Multiple Upholstery Specify: Model | Frame Upholstery | Back Uph | Seat Uph | Back Style | Seat Style | Foot Style | Arm Cap

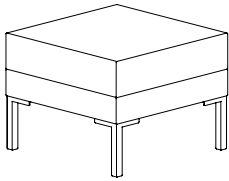
TK1631_M														
Base Price: \$3,045		To the Base Price, add the appropriate upcharges by grade, per zone												
	COM	COL	A	B	C	D	E	F	G	H	I	J	L1	L2
Frame - Zone 1	+\$0	+\$185	+\$29	+\$86	+\$185	+\$313	+\$440	+\$638	+\$851	+\$1,078	+\$1,431	+\$1,857	+\$893	+\$1,148
Back - Zone 2	+\$0	+\$185	+\$29	+\$86	+\$185	+\$313	+\$440	+\$638	+\$851	+\$1,078	+\$1,431	+\$1,857	+\$893	+\$1,148
Seat - Zone 3	+\$0	+\$144	+\$23	+\$67	+\$144	+\$243	+\$343	+\$497	+\$662	+\$838	+\$1,114	+\$1,445	+\$695	+\$893

- arm considered part of frame

Model	Upholstery	Back Style	Seat Style	Foot Style	Arm Cap
	Grade Vendor Pattern Colorway	PBC Plain Back Cushion QBC Quilted Back Cushion, add \$234	PSC Plain Seat Cushion QSC Quilted Seat Cushion, add \$234	MF Metal Foot See Teekan Metal Finishes WF Wood Foot, add \$324 See JSI Standard Seating Finishes SF Sled Foot, add \$296 See JSI Standard Seating Finishes	NAC No Arm Cap B3LAC Black 3D Laminate, add \$195 per set WAC Wood, add \$195 per set See JSI Standard Seating Finishes SAC Solid Surface, add \$314 per set See JSI Standard Solid Surfaces

Description + General Information

20" Square Ottoman



Dimensions	D	W	H	Shipping	
Overall	20	20	15 ¼	Ctn Wt	35
Seat	20	20	15 ¼	Cu Ft	4

	Single Upholstery	Seat Zone 1	Apron Zone 2
COM Ydg	1 ¼	¾	¾
COL Sq Ft	23	13	13

Single Upholstery Specify: Model | Upholstery | Seat Style | Foot Style

TK2020														
	COM	COL	A	B	C	D	E	F	G	H	I	J	L1	L2
Single Uph	\$827	\$899	\$838	\$860	\$899	\$950	\$1,001	\$1,079	\$1,164	\$1,253	\$1,393	\$1,563	\$1,179	\$1,282

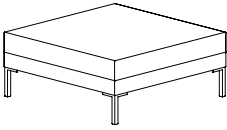
Multiple Upholstery Specify: Model | Apron Upholstery | Seat Upholstery | Seat Style | Foot Style

TK2020_M														
Base Price: \$827	To the Base Price, add the appropriate upcharges by grade, per zone													
	COM	COL	A	B	C	D	E	F	G	H	I	J	L1	L2
Apron - Zone 1	+\$0	+\$41	+\$8	+\$20	+\$41	+\$70	+\$99	+\$142	+\$190	+\$239	+\$318	+\$414	+\$199	+\$256
Seat - Zone 2	+\$0	+\$48	+\$9	+\$23	+\$48	+\$79	+\$112	+\$162	+\$217	+\$274	+\$363	+\$472	+\$227	+\$293

Model	Upholstery	Seat Style	Foot Style
	Grade Vendor Pattern Colorway	PSC Plain Seat Cushion QSC Quilted Seat Cushion, add \$117	MF Metal Foot See Teekan Metal Finishes WF Wood Foot, add \$324 See JSI Standard Seating Finishes

Description + General Information

36" Square Ottoman



Dimensions	D	W	H	Shipping	
Overall	36	36	15 ¼	Ctn Wt	48
Seat	36	36	15 ¼	Cu Ft	12

	Single Upholstery	Seat Zone 1	Apron Zone 2
COM Ydg	2 ¼	2	¾
COL Sq Ft	41	35	13

Single Upholstery Specify: Model | Upholstery | Seat Style | Foot Style

TK3636														
	COM	COL	A	B	C	D	E	F	G	H	I	J	L1	L2
Single Uph	\$1,348	\$1,509	\$1,373	\$1,422	\$1,509	\$1,620	\$1,732	\$1,905	\$2,090	\$2,288	\$2,597	\$2,967	\$2,127	\$2,350

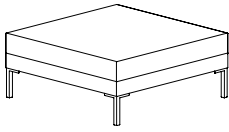
Multiple Upholstery Specify: Model | Apron Upholstery | Seat Upholstery | Seat Style | Foot Style

TK3636_M														
Base Price: \$1,348		To the Base Price, add the appropriate upcharges by grade, per zone												
	COM	COL	A	B	C	D	E	F	G	H	I	J	L1	L2
Apron - Zone 1	+\$0	+\$60	+\$10	+\$28	+\$60	+\$100	+\$140	+\$203	+\$271	+\$343	+\$455	+\$590	+\$284	+\$365
Seat - Zone 2	+\$0	+\$118	+\$19	+\$55	+\$118	+\$198	+\$279	+\$405	+\$541	+\$684	+\$909	+\$1,179	+\$567	+\$729

Model	Upholstery	Seat Style	Foot Style
	Grade Vendor Pattern Colorway	PSC Plain Seat Cushion QSC Quilted Seat Cushion, add \$176	MF Metal Foot See Teekan Metal Finishes WF Wood Foot, add \$324 See JSI Standard Seating Finishes

Description + General Information

48" Square Ottoman



Dimensions	D	W	H	Shipping	
Overall	48	48	15 ¼	Ctn Wt	68
Seat	48	48	15 ¼	Cu Ft	21

	Single Upholstery	Seat Zone 1	Apron Zone 2
COM Ydg	3	2 ¼	¾
COL Sq Ft	54	40	13

Single Upholstery Specify: Model | Upholstery | Seat Style | Foot Style

TK4848														
	COM	COL	A	B	C	D	E	F	G	H	I	J	L1	L2
Single Uph	\$1,493	\$1,668	\$1,520	\$1,574	\$1,668	\$1,788	\$1,911	\$2,100	\$2,302	\$2,518	\$2,855	\$3,260	\$2,343	\$2,586

Multiple Upholstery Specify: Model | Apron Upholstery | Seat Upholstery | Seat Style | Foot Style

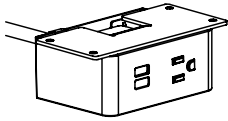
TK4848_M														
Base Price: \$1,493	To the Base Price, add the appropriate upcharges by grade, per zone													
	COM	COL	A	B	C	D	E	F	G	H	I	J	L1	L2
Apron - Zone 1	+\$0	+\$59	+\$10	+\$28	+\$59	+\$100	+\$140	+\$203	+\$270	+\$343	+\$455	+\$590	+\$284	+\$365
Seat - Zone 2	+\$0	+\$136	+\$21	+\$63	+\$136	+\$228	+\$321	+\$466	+\$621	+\$787	+\$1,045	+\$1,356	+\$652	+\$839

Model	Upholstery	Seat Style	Foot Style
	Grade Vendor Pattern Colorway	PSC Plain Seat Cushion QSC Quilted Seat Cushion, add \$205	MF Metal Foot See Teekan Metal Finishes WF Wood Foot, add \$324 See JSI Standard Seating Finishes

Description + General Information

Power Center - Under Mount

EC30	List Price
	\$363



- front frame mount - field installed
- simplex receptacle and two USB/10' - three prong plug power cord
- 10' cord
- overall mounting bracket tabs: 5" w
- specify black or white - cord color will match unit; optional graphite fabric cord available; specify and add \$187 list

Dimensions	D	W	H	Shipping	
Overall	2 ¾	4	2 ⅞	Ctn Wt	48
				Cu Ft	12

Electical Specify: Color Cord

Totem Order Check List:



Specify:

- 1. Model Number
- 2. Fabric Selection - vendor, pattern and color

Example:

TM24C | **MOMENTUM** | **VOX** | **MYSTIC**
 (model #) | (fabric vendor) | (pattern name) | (pattern color)

1. Model Number

2. Fabric Selection - Please supply the following:
 Fabric vendor/Pattern name/Pattern color

For a complete list of JSI Standard and Graded-In Textiles click here

When specifying contrasting upholstery, indicate clearly which upholstery is to be applied to the top and to the side. Use higher grade pricing.

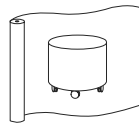
- Indicate direction of fabric - Railroaded or Up the Roll
- Please provide illustration, if available

All COM orders must include the following:

- Vendor's name, pattern name and color
- Sample of the fabric attached to order
- Model numbers of items for fabric application
- Special application instructions (e.g., all stripes will be applied front to back unless specified otherwise)
- Customer and purchase order number

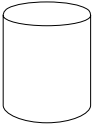
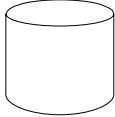
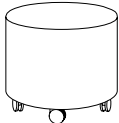
Ship prepaid COM material to:
 JSI
 Attn: COM Dept
 201 East Martin Street
 Receiving B, Dock 71
 Orleans, IN 47452

Application of fabric:
 Railroaded



All COM orders will ship at standard lead time from receipt of COM.

TOTEM

Description	① Model	Specifications				List Price Per Grade	
Round Pod 	TM17 · upholstered base · five 1" diameter black nylon glides	Dimensions		D	W	H	COM \$707
		Overall		17		18	A \$745
		Seat				18	B \$802
		Upholstery		Shipping			COL/C \$899
		COM Ydg	2	Ctn Wt	20		D \$1,025
		COL Sq Ft	36	Cu Ft	5		E \$1,152
							F \$1,343
					G \$1,553		
					H \$1,775		
					I \$2,122		
					J \$2,541		
					L1 \$1,595		
					L2 \$1,816		
Round Pod 	TM24 · upholstered base · five 1" diameter black nylon glides	Dimensions		D	W	H	COM \$893
		Overall		24		18	A \$942
		Seat				18	B \$1,013
		Upholstery		Shipping			COL/C \$1,134
		COM Ydg	2 ½	Ctn Wt	32		D \$1,294
		COL Sq Ft	45	Cu Ft	8		E \$1,450
							F \$1,692
					G \$1,953		
					H \$2,229		
					I \$2,664		
					J \$3,186		
					L1 \$2,003		
					L2 \$2,283		
Mobile Round Pod 	TM24C · upholstered base · six 65 mm casters	Dimensions		D	W	H	COM \$1,047
		Overall		24		18	A \$1,097
		Seat				18	B \$1,167
		Upholstery		Shipping			COL/C \$1,289
		COM Ydg	2 ½	Ctn Wt	49		D \$1,446
		COL Sq Ft	45	Cu Ft	8		E \$1,602
							F \$1,844
					G \$2,108		
					H \$2,384		
					I \$2,819		
					J \$3,339		
					L1 \$2,159		
					L2 \$2,436		

TOTEM

To Order, Specify:

- ① Model Number
- ② Fabric Selection - vendor, pattern and color
 Visit www.jsifurniture.com/finishes-and-materials/textiles for our textiles program. See selection of standard and graded in manufacturers and patterns.

Specifications

- Wood frame.
- Pod is upholstered with 2" high density polyurethane foam.

Trinity Order Check List:



Specify:

- 1. Model Number
- 2. Wood Species - Beech (B)
- 3. Wood Finish/Paint Color
- 4. Metal Frame Tier/Color:
 - A. Tier 1 - no upcharge
 - B. Tier 2 - add \$150 list
 - C. Tier 3 - add \$170 list
- 5. Fabric Selection - vendor, pattern and color
- 6. Wood Back Style - R, S, T, U, V or W
- 7. Optional Linking Brackets - add \$41 list per chair
- 8. Optional Laser Engraved Back - specify location and size

Example:

TR503A (model #)	B (wood species)	HRV (finish)	MBK (frame color)	MOMENTUM (fabric vendor)	VOX (pattern name)	MYSTIC (pattern color)
----------------------------	----------------------------	------------------------	-----------------------------	------------------------------------	------------------------------	----------------------------------

1. Model Number

2. Wood Species - Beech (B)

3. Wood Finish/Color Options:

ALM Ale Medium	HRV Harvest
CAL Ale Light Coordinate	CKC Khaki Coordinate
BBM Bourbon Medium	MINC Mineral Coordinate
CBZ Brazilwood Coordinate	MCH Mocha
BARC Barrel Coordinate	CPI Pinnacle Walnut Coordinate
CBO Bourbon Light Coordinate	PRL Praline
CBG Brighton Light Coordinate	RAVC Raven Coordinate
BRM Brighton Medium	SABC Sable Coordinate
BUT Butterscotch	SIE Sienna
CNDC Cinder Coordinate	CST Studio Teak Coordinate
CLA Classic	TRF Truffle
CLL Collectors	UMB Umber
EGRC Egret Coordinate	VALC Valley Coordinate
ESP Espresso	VEN Venetian
FAWC Fawn Coordinate	CWE Weathered Ash Coordinate
FLX Flax	
CGR Graphite Coordinate	

Paint Color - Add \$45 list per item

BKD Backdrop	GRV Greek Villa
BFX Black Fox	GLF Gulf Stream
BWH Bright White	HTB Heartthrob
CGP Cargo Pants	NET Network Gray
CHT Chatroom	NWH Nonchalant White
DSY Daisy	PAR Paradise
DRG Daring	QXP Quixotic Plum
DYN Dynamo	RBZ Relic Bronze
ENG Enigma	SND Sandbank
FRR French Roast	STM Storm
GBY Georgian Bay	TRC Tricorn Black

4. Metal Frame Tier/Color:

Tier 1:

MBK Matte Black	CHR Chrome
-----------------	------------

Tier 2: add \$150 list

ABZ Aged Bronze	PEW Pewter
ASL Arctic Silver	SBZ Soft Bronze
BWH Bright White	SNK Soft Nickel
GLD Gold	

Tier 3: add \$170 list

BRD Beige Red (RAL3012)	SGR Signal Green (RAL6032)
CAR Carmine Red (RAL3002)	SIG Signal Orange (RAL2010)
COP Copper Brown (RAL8004)	SGY Silk Grey (RAL7044)
HYL Honey Yellow (RAL1005)	SKY Sky Blue (RAL5015)
LGR Leaf Green (RAL6002)	TBL Traffic Blue (RAL5017)
MHB Mahogany Brown (RAL8016)	TRD Traffic Red (RAL3020)
MTQ Mint Turquoise (RAL6033)	TQP Turquoise Pastel (RAL6034)
OGR Olive Green (RAL6003)	ZYL Zinc Yellow (RAL1018)
PPV Purple Violet (RAL4007)	
QZG Quartz Grey (RAL7039)	
SAL Salmon Orange (RAL2012)	
SPB Sapphire Blue (RAL4007)	

5. Fabric Selection - Please supply the following:

Fabric vendor/Pattern name/Pattern color

For a complete list of JSI Standard and Graded-In Textiles click here

When specifying contrasting upholstery, indicate clearly which upholstery is to be applied to the seat and back. Use higher grade pricing.

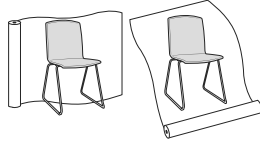
- Indicate direction of fabric - Railroaded or Up the Roll
- Please provide illustration, if available

All COM orders must include the following:

- Vendor's name, pattern name and color
- Sample of the fabric attached to order
- Model numbers of items for fabric application
- Special application instructions (e.g., all stripes will be applied front to back unless specified otherwise)
- Customer and purchase order number

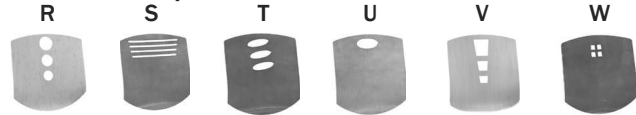
Ship prepaid COM material to:
 JSI
 Attn: COM Dept
 201 East Martin Street
 Receiving B, Dock 71
 Orleans, IN 47452

Application of fabric:
 Railroaded Up the Roll



All COM orders will ship at standard lead time from receipt of COM except for orders requiring special custom matched finishes.

6. Wood Back Options:




7. Optional Linking Brackets - add \$41 list per chair

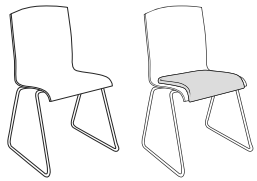


8. Optional Laser Engraved Back - available on models TR503A/C. See page VIII for details.



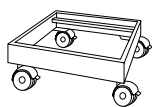
- Specify:
- location - inside/outside of back.
 - size of design

Description	① Model	Specifications				List Price Per Grade	
Side Chair 	TR503D Fully Upholstered · protective stack bumpers · not recommended for stacking	Dimensions		D	W	H	COM \$786
		Overall	22	18 ½	33 ¾	A \$814	
		Seat	16	17	19	B \$846	
		Upholstery		Shipping		COL/C \$904	
		COM Ydg	1 ¼	Ctn Wt	16	D \$977	
		COL Sq Ft	25	Cu Ft	9	E \$1,050	
						F \$1,126	
						G \$1,236	
						H \$1,353	
						I \$1,532	
						J \$1,753	
						L1 \$1,258	
						L2 \$1,375	

Description	① Model	Specifications				List Price Per Grade	
Stack/Side Chair 	TR503A All Wood TR503C Upholstered Seat · protective stack bumpers · stacks ten high · upholstered models not recommended for stacking · optional laser engraved back, specify location and size -see page VIII for details.	Dimensions		D	W	H	All Wood \$564
		Overall	22	18 ½	33 ¾	COM \$667	
		Seat	16	17	19	A \$685	
		Upholstery		Shipping		B \$705	
		COM Ydg	¾	Ctn Wt	16	COL/C \$738	
		COL Sq Ft	9	Cu Ft	9	D \$784	
						E \$825	
						F \$871	
						G \$937	
						H \$1,009	
						I \$1,118	
						J \$1,249	
						L1 \$953	
						L2 \$1,021	

TRINITY

Description	D	W	H	CTN WT	CU FT	① Model	List Price
Dolly	21	20	8	15	4	TR500	\$415



· stacks up to ten high

To Order, Specify:

- ① Model Number
- ② Wood Species - Beech (B)
- ③ Wood Finish/Paint Color [See Wood Finish/Paint Color Options](#)
- ④ Metal Frame Tier/Color [See Metal Frame Tier/Color Options](#)
- ⑤ Fabric Selection - vendor, pattern and color
Visit www.jsifurniture.com/finishes-and-materials/textiles for our textiles program. See selection of standard and graded in manufacturers and patterns.
- ⑥ Wood Back Style - R, S, T, U, V or W
- ⑦ Optional Linking Brackets - add \$41 list per chair
- ⑧ Optional Laser Engraved Back - specify location and size; see page VIII for details

Shell Specifications

- Wood species - Beech.
- Stacks ten high.
- Consists of seven-ply hardwood construction.
- Contoured molded seat panel.
- Upholstered shell or seat ½" polyurethane foam.

Frame Specifications

- Manufactured with 7/16" solid steel rod.
- Four clear plastic glides - chrome frame.
- Four black plastic glides - black frame.
- Four protective stack bumpers.

Tyler Order Check List:



Specify:

- 1. Model Number
- 2. Fabric Selection - vendor, pattern and color
- 3. Base Selection - black polyurethane base standard
 - A. Aluminum Base - add \$116 list
 - B. Black Pneumatic Jury Base - add \$203 list
- 4. Optional Mid-Pivot Swivel-Tilt Mechanism - add \$148 list
- 5. Optional Base Glides - add \$17 list

Example:

TY8600 | **MOMENTUM** | **VOX** | **MYSTIC**
 (model #) | (fabric vendor) | (pattern name) | (pattern color)

1. Model Number

2. Fabric Selection - Please supply the following:
 Fabric vendor/Pattern name/Pattern color

For a complete list of JSI Standard and Graded-In Textiles click here

When specifying contrasting upholstery, indicate clearly which upholstery is to be applied to the seat, back and arms. Use higher grade pricing.

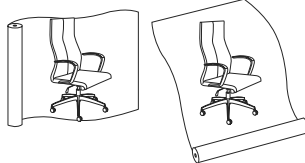
- Indicate direction of fabric - Railroaded or Up the Roll
- Please provide illustration, if available

All COM orders must include the following:

- Vendor's name, pattern name and color
- Sample of the fabric attached to order
- Model numbers of items for fabric application
- Special application instructions (e.g., all stripes will be applied front to back unless specified otherwise)
- Customer and purchase order number

Ship prepaid COM material to:
 JSI
 Attn: COM Dept
 201 East Martin Street
 Receiving B, Dock 71
 Orleans, IN 47452

Application of fabric:
 Railroaded Up the Roll



All COM orders will ship at standard lead time from receipt of COM except for orders requiring special custom matched finishes.

3. Base Selections - black polyurethane base standard

- A. Aluminum base - add \$116 list
- B. Black pneumatic jury base - add \$203 list



Pneumatic lift - NOT self-centering - Standard

4. Pneumatic Swivel Tilt Control (Standard) -





Optional mid-pivot swivel-tilt mechanism - add \$148 list


5. Optional Base Glides - add \$17 list




TYLER


Description	① Model	Specifications				List Price Per Grade	
Management Mid Back 	TY8600 · armless · overall height range is 37 - 42 · seat height range is 17 - 22	Dimensions		D	W	H	COM \$1,124
		Overall	26	26	42	A \$1,143	
		Seat	18	19 ½	22	B \$1,182	
		Arm				COL/C \$1,247	
		Upholstery		Shipping		D \$1,331	
		COM Ydg	1 ¾	Ctn Wt	28	E \$1,417	
		COL Sq Ft	32	Cu Ft	14	F \$1,507	
						G \$1,633	
						H \$1,769	
						I \$1,982	
				J \$2,235			
				L1 \$1,658			
				L2 \$1,794			


Description	① Model	Specifications				List Price Per Grade	
Management Mid Back 	TY8610T · adjustable T arm · overall height range is 37 - 42 · seat height range is 17 - 22 · arm height range is 24 ¼ - 32 ¾	Dimensions		D	W	H	COM \$1,228
		Overall	26	26	42	A \$1,248	
		Seat	18	19 ½	22	B \$1,287	
		Arm			32 ¾	COL/C \$1,351	
		Upholstery		Shipping		D \$1,436	
		COM Ydg	1 ¾	Ctn Wt	35	E \$1,520	
		COL Sq Ft	32	Cu Ft	14	F \$1,611	
						G \$1,740	
						H \$1,872	
						I \$2,085	
				J \$2,338			
				L1 \$1,760			
				L2 \$1,900			

Description	① Model	Specifications				List Price Per Grade	
Management Mid Back 	TY8610L · fixed height loop arm · overall height range is 37 - 42 · seat height range is 17 - 22 · arm height range is 25 - 30	Dimensions		D	W	H	COM \$1,228
		Overall	26	26	42	A \$1,248	
		Seat	18	19 ½	22	B \$1,287	
		Arm			30	COL/C \$1,351	
		Upholstery		Shipping		D \$1,436	
		COM Ydg	1 ¾	Ctn Wt	35	E \$1,520	
		COL Sq Ft	32	Cu Ft	14	F \$1,611	
						G \$1,740	
						H \$1,872	
						I \$2,085	
				J \$2,338			
				L1 \$1,760			
				L2 \$1,900			

TYLER

Description	① Model	Specifications				List Price Per Grade	
Executive High Back 	TY8620 · armless · overall height range is 44 - 49 · seat height range is 17 - 22	Dimensions	D	W	H	COM	\$1,165
		Overall	26	26	49	A	\$1,185
		Seat	18	19½	22	B	\$1,229
		Upholstery	Shipping			COL/C	\$1,307
		COM Ydg	2	Ctn Wt	36	D	\$1,407
		COL Sq Ft	36	Cu Ft	14	E	\$1,505
						F	\$1,610
						G	\$1,756
						H	\$1,914
						I	\$2,162
				J	\$2,456		
				L1	\$1,787		
				L2	\$1,944		

Description	① Model	Specifications				List Price Per Grade	
Executive High Back 	TY8630T · adjustable T-arm · overall height range is 44 - 49 · seat height range is 17 - 22 · arm height range is 24¼ - 32¾	Dimensions	D	W	H	COM	\$1,264
		Overall	26	26	49	A	\$1,289
		Seat	18	19½	22	B	\$1,331
		Arm			32¾	COL/C	\$1,410
		Upholstery	Shipping			D	\$1,508
		COM Ydg	2	Ctn Wt	43	E	\$1,606
		COL Sq Ft	36	Cu Ft	14	F	\$1,712
						G	\$1,859
						H	\$2,016
						I	\$2,263
				J	\$2,560		
				L1	\$1,892		
				L2	\$2,047		

Description	① Model	Specifications				List Price Per Grade	
Executive High Back 	TY8630L · fixed height loop arm · overall height range is 44 - 49 · seat height range is 17 - 22 · arm height range is 25 - 30	Dimensions	D	W	H	COM	\$1,264
		Overall	26	26	49	A	\$1,289
		Seat	18	19½	22	B	\$1,331
		Arm			30	COL/C	\$1,410
		Upholstery	Shipping			D	\$1,508
		COM Ydg	2	Ctn Wt	43	E	\$1,606
		COL Sq Ft	36	Cu Ft	14	F	\$1,712
						G	\$1,859
						H	\$2,016
						I	\$2,263
				J	\$2,560		
				L1	\$1,892		
				L2	\$2,047		

To Order, Specify:

- ① Model Number
- ② Fabric Selection - vendor, pattern and color
Visit www.jsifurniture.com/finishes-and-materials/textiles for our textiles program.
See selection of standard and graded in manufacturers and patterns.
- ③ Base Selection - black polyurethane base standard
 - A. Aluminum Base - add \$116 list
 - B. Black Pneumatic Jury Base - add \$203 list
- ④ Optional Mid-Pivot Swivel-Tilt Mechanism (MP) - add \$148 list
- ④ Optional Base Glides (G) - add \$17 list

Specifications

- One piece solid plywood construction.
- Seat has 2½" polyurethane foam.
- Back has 1½" polyurethane foam and vertical stitch detail.
- All models standard with swivel tilt, lock, pneumatic lift, tension adjustment and a black polyurethane base with dual wheel casters.

Wink Order Check List:



Specify:

- 1. Model Number
- 2. Plastic Color or Wood Finish
- 3. Fabric Selection - vendor, pattern and color
- 4. Frame Selection - tier and finish
- 5. Optional Felt Glides - no upcharge (available on metal 4-leg chairs and stools only, not available on sled base)

Example:

WK821CP | **SMK** | **MOMENTUM** | **VOX** | **MYSTIC**
 (model #) | (plastic color) | (fabric vendor) | (pattern name) | (pattern color)

1. Model Number

2. Seat and Back Plastic Color or Wood Finish Options:
 see individual model for shell availability.

Gloss Plastic Color:

CTG Cherry Tomato Gloss TBG Tricorn Black Gloss ♦
 NOG Navel Orange Gloss ♦

Matte Plastic Color:

EWM Extra White SRM Stop Red
 KGR Kiwi Green* TBM Tricorn Black
 Nvy Navy Blue THG Thunderous Green
 RFB Refuge Blue TRD Toile Red

Translucent Plastic Color:

CLR Clear ♦

Wood Finish:

SSY Sapeli Sycamore
 WAL Walnut

- ♦ Navel Orange Gloss, Tricorn Black Gloss, Clear Translucent not available on Armless Shells
- * Kiwi Green not available on Wrap Shells

3. Fabric Selection - Please supply the following:
 Fabric vendor/Pattern name/Pattern color

For a complete list of JSI Standard and Graded-In Textiles click here

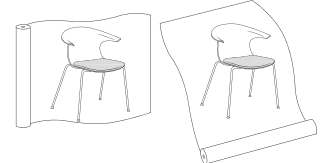
All COM orders must include the following:

- Vendor's name, pattern name and color
- Sample of the fabric attached to order
- Model numbers of items for fabric application
- Special application instructions (e.g., all stripes will be applied front to back unless specified otherwise)
- Customer and purchase order number

Ship prepaid COM material to:

JSI
 Attn: COM Dept
 201 East Martin Street
 Receiving B, Dock 71
 Orleans, IN 47452

Application of fabric:
 Railroaded Up the Roll



All COM orders will ship at standard lead time from receipt of COM except for orders requiring special custom matched finishes.

4. Frame Finish

For Wood Leg Models:

White Oak:

ACR Acorn	MIN Mineral
BAR Barrel	POR Porter
BUF Buff	RAV Raven
BUR Burlap	RYE Rye
CHE Chestnut	SAB Sable
CND Cinder	SAD Saddle
EGR Egret	WVO Whitewash

4-Leg and Sled Base Models Metal Finishes cont. on next page
Metal Finish:

Tier 1:

MBK Matte Black
 CHR Chrome

Tier 2: add \$150 list

ABZ Aged Bronze	PEW Pewter
ASL Arctic Silver	SBZ Soft Bronze
BWH Bright White	SNK Soft Nickel
GLD Gold	

Wink Order Check List:

Metal Frame continued from previous page.

4-Leg and Sled Base Models

Tier 1:

MBK	Matte Black
CHR	Chrome

Tier 2: add \$150 list

ABZ	Aged Bronze	PEW	Pewter
ASL	Arctic Silver	SBZ	Soft Bronze
BWH	Bright White	SNK	Soft Nickel
GLD	Gold		

Tier 3: add \$170 list

BRD	Beige Red (RAL3012)	SAL	Salmon Orange (RAL2012)
CAR	Carmine Red (RAL3002)	SPB	Sapphire Blue (RAL4007)
COP	Copper Brown (RAL8004)	SGR	Signal Green (RAL6032)
HYL	Honey Yellow (RAL1005)	SIG	Signal Orange (RAL2010)
LGR	Leaf Green (RAL6002)	SGY	Silk Grey (RAL7044)
MHB	Mahogany Brown (RAL8016)	SKY	Sky Blue (RAL5015)
MTQ	Mint Turquoise (RAL6033)	TBL	Traffic Blue (RAL5017)
OGR	Olive Green (RAL6003)	TRD	Traffic Red (RAL3020)
PPV	Purple Violet (RAL4007)	TQP	Turquoise Pastel (RAL6034)
QZG	Quartz Grey (RAL7039)	ZYL	Zinc Yellow (RAL1018)

Chrome Frame dictate chrome glides/back support bracketry.


Matte Black Frame dictate black glides/back support bracketry.


Pewter Frame dictate black glides/back support bracketry

All other Frame color dictates chrome glides/back support bracketry.

Care and Maintenance Information:

- do not use a dry cloth or paper towel
- do not use any cleaner, liquid or soap containing ammonia, acetone, trichloroethylene or alcohol.
- use a soft cloth with warm water and buff dry with lint free soft cloth
- if heavier soiled cleaning is required, use small amount of liquid soap free of above listed chemicals diluted in warm water, rinse and buff dry with a soft lint free cloth
- spray cleaners can be used if they are designed for cleaning acrylic, plexiglas, polycarbonate or mylar window films and do not contain ammonia or alcohol. However, some cleaners could leave residue and might cause finger printing or smearing

Description	Model	Specifications				List Price Per Grade	
Armless Stack Chair  <p>WK823AP plastic seat</p> <p>WK823CP uph. seat</p> <p>translucent seat</p>	WK823AP Plastic Seat WK823CP Uph. Seat <ul style="list-style-type: none"> low density stacker stacks 5 high available in Matte plastic shell colors available in Cherry Tomato Gloss plastic shell for limited time only - contact CS for qty 4-leg base available in 26 metal finishes, see below for options and pricing rubber nylon glides standard, optional felt glides, no upcharge 	Dimensions		D	W	H	Plastic Seat \$639 COM \$824 A \$847 B \$868 COL/C \$905 D \$952 E \$995 F \$1,066 G \$1,142 H \$1,226 I \$1,350 J \$1,507 L1 \$1,160 L2 \$1,240
		Overall		21	23	32	
		Seat		16	18 1/2	17 3/4	
		Upholstery		Shipping			
		COM Ydg	3/4	Ctn Wt	18		
		COL Sq Ft	9	Cu Ft	12		

Description	Model	Specifications				List Price Per Grade	
Wrap Stack Chair  <p>WK821AP plastic seat</p> <p>WK821CP uph. seat</p> <p>translucent seat</p>	WK821AP Plastic Seat WK821CP Uph. Seat <ul style="list-style-type: none"> low density stacker stacks 5 high available in Matte plastic shell colors available in Gloss and Translucent plastic shell for limited time only - contact CS for qty 4-leg base available in 26 metal finishes, see below for options and pricing rubber nylon glides standard, optional felt glides, no upcharge 	Dimensions		D	W	H	Plastic Seat \$686 COM \$881 A \$906 B \$925 COL/C \$961 D \$1,008 E \$1,054 F \$1,128 G \$1,201 H \$1,284 I \$1,411 J \$1,565 L1 \$1,216 L2 \$1,299
		Overall		22 1/4	24 3/4	31 3/4	
		Seat		14 1/2	18 1/2	17 1/2	
		Upholstery		Shipping			
		COM Ydg	3/4	Ctn Wt	20		
		COL Sq Ft	9	Cu Ft	12		

To Order, Specify:

- 1 Model Number
- 2 Shell Plastic Color [See Shell Plastic Color Options](#)
- 3 Fabric Selection - vendor, pattern and color
Visit www.jsifurniture.com/finishes-and-materials/textiles for our textiles program.
See selection of standard and graded in manufacturers and patterns.
- 4 Metal Leg Finish [See Metal Leg Finish Options](#)
- 5 Optional Felt Glides - no upcharge

Specifications

- Plastic/Translucent - 1/4" thick plastic seat and back.
- Wood - 5/16" thick, 5 ply wood seat and back.
- Seat is upholstered with 3/4" polyurethane foam.
- Chromium plated metal legs.
- 4-leg chairs standard with nylon glides.
- Sled base standard with snap-on clear glides.

Description

Stack Chair with Metal Loop Arms



WK851AP
plastic seat



WK851CP
uph. seat

Model

WK851AP Plastic Seat

WK851CP Uph. Seat

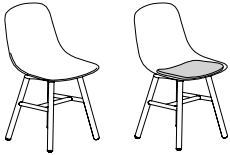

- low density stacker
- stacks 5 high
- available with Matte Plastic shell colors
- 4-leg base available in 26 metal finishes, see below for options and pricing
- rubber nylon glides standard, optional felt glides, no upcharge

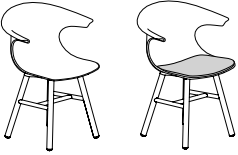

Specifications

Dimensions	D	W	H
Overall	21	18½	32
Seat	16	18½	17¾
Arm			26
Upholstery		Shipping	
COM Ydg	¾	Ctn Wt	20
COL Sq Ft	9	Cu Ft	12

List Price Per Grade

Plastic Seat	\$720
COM	\$995
A	\$1,002
B	\$1,021
COL/C	\$1,052
D	\$1,090
E	\$1,129
F	\$1,191
G	\$1,256
H	\$1,325
I	\$1,434
J	\$1,565
L1	\$1,303
L2	\$1,390

Description	Model	Specifications	List Price Per Grade																								
Armless Wood Leg Guest Chair  WK813AP plastic seat WK813CP uph. seat  translucent seat	WK813AP Plastic Seat WK813CP Uph. Seat <ul style="list-style-type: none"> · does not stack · available in Matte plastic shell colors · available in Cherry Tomato Gloss plastic shell for limited time only - contact CS for qty · oak frame available in select finishes · matte black metal seat frame standard, optional polished aluminum, no upcharge 	<table border="1"> <thead> <tr> <th>Dimensions</th> <th>D</th> <th>W</th> <th>H</th> </tr> </thead> <tbody> <tr> <td>Overall</td> <td>17</td> <td>18½</td> <td>32</td> </tr> <tr> <td>Seat</td> <td>16</td> <td>18½</td> <td>17¾</td> </tr> <tr> <th colspan="2">Upholstery</th> <th colspan="2">Shipping</th> </tr> <tr> <td>COM Ydg</td> <td>¾</td> <td>Ctn Wt</td> <td></td> </tr> <tr> <td>COL Sq Ft</td> <td>9</td> <td>Cu Ft</td> <td></td> </tr> </tbody> </table>	Dimensions	D	W	H	Overall	17	18½	32	Seat	16	18½	17¾	Upholstery		Shipping		COM Ydg	¾	Ctn Wt		COL Sq Ft	9	Cu Ft		Plastic Seat \$1,011 COM \$1,285 A \$1,296 B \$1,314 COL/C \$1,344 D \$1,384 E \$1,423 F \$1,487 G \$1,553 H \$1,625 I \$1,735 J \$1,870 L1 \$1,602 L2 \$1,692
		Dimensions	D	W	H																						
		Overall	17	18½	32																						
Seat	16	18½	17¾																								
Upholstery		Shipping																									
COM Ydg	¾	Ctn Wt																									
COL Sq Ft	9	Cu Ft																									

Description	Model	Specifications	List Price Per Grade																												
Wrap Wood Leg Guest Chair  WK811AP plastic seat WK811CP uph. seat  translucent seat	WK811AP Plastic Seat WK811CP Uph. Seat <ul style="list-style-type: none"> · does not stack · available in Matte plastic shell colors · available in Gloss and Translucent plastic shell for limited time only - contact CS for qty · oak frame available in select finishes · matte black metal seat frame standard, optional Polished Aluminum, no upcharge 	<table border="1"> <thead> <tr> <th>Dimensions</th> <th>D</th> <th>W</th> <th>H</th> </tr> </thead> <tbody> <tr> <td>Overall</td> <td>15½</td> <td>18½</td> <td>32</td> </tr> <tr> <td>Seat</td> <td>14½</td> <td>18½</td> <td>17¾</td> </tr> <tr> <td>Arm</td> <td></td> <td></td> <td>25¼</td> </tr> <tr> <th colspan="2">Upholstery</th> <th colspan="2">Shipping</th> </tr> <tr> <td>COM Ydg</td> <td>¾</td> <td>Ctn Wt</td> <td>20</td> </tr> <tr> <td>COL Sq Ft</td> <td>9</td> <td>Cu Ft</td> <td>12</td> </tr> </tbody> </table>	Dimensions	D	W	H	Overall	15½	18½	32	Seat	14½	18½	17¾	Arm			25¼	Upholstery		Shipping		COM Ydg	¾	Ctn Wt	20	COL Sq Ft	9	Cu Ft	12	Plastic Seat \$1,199 COM \$1,476 A \$1,486 B \$1,505 COL/C \$1,535 D \$1,575 E \$1,614 F \$1,676 G \$1,745 H \$1,816 I \$1,926 J \$2,061 L1 \$1,792 L2 \$1,882
		Dimensions	D	W	H																										
		Overall	15½	18½	32																										
Seat	14½	18½	17¾																												
Arm			25¼																												
Upholstery		Shipping																													
COM Ydg	¾	Ctn Wt	20																												
COL Sq Ft	9	Cu Ft	12																												

To Order, Specify:

- 1 Model Number
- 2 Shell Plastic Color [See Shell Plastic Color Options](#)
- 3 Fabric Selection - vendor, pattern and color
 Visit www.jsifurniture.com/finishes-and-materials/textiles for our textiles program.
 See selection of standard and graded in manufacturers and patterns.
- 4 Metal Leg Finish [See Metal Leg Finish Options](#)
- 5 Optional Felt Glides - no upcharge

Specifications

- Plastic/Translucent - ¼" thick plastic seat and back.
- Wood - ¾" thick, 5 ply wood seat and back.
- Seat is upholstered with ¾" polyurethane foam.
- Chromium plated metal legs.
- 4-leg chairs standard with nylon glides.
- Sled base standard with snap-on clear glides.

Description

Wrap Stack Chair



WK821AW
all wood



WK821CW
uph. seat

Model

WK821AW All Wood

WK821CW Uph. Seat

- 4-leg base available in 26 metal finishes, see below for options and pricing
- available in Sapeli Sycamore or Walnut wood finish
- rubber nylon glides standard, optional felt glides, no upcharge
- limited quantity - contact customer service

Specifications

Dimensions	D	W	H
Overall	22 ¼	24 ¾	31 ¾
Seat	14 ½	18 ¼	17 ½
Arm			28 ¼
Upholstery		Shipping	
COM Ydg	¾	Ctn Wt	20
COL Sq Ft	9	Cu Ft	12

List Price Per Grade

All Wood	\$2,945
COM	\$3,105
A	\$3,145
B	\$3,168
COL/C	\$3,205
D	\$3,250
E	\$3,295
F	\$3,365
G	\$3,442
H	\$3,528
I	\$3,653
J	\$3,807
L1	\$3,459
L2	\$3,540

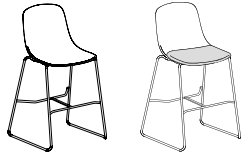
Description

1 Model

Specifications

List Price Per Grade

40" h Armless Counter Stool



WK824AP
plastic seat

WK824CP
uph. seat



translucent
seat

WK824AP Plastic Seat
WK824CP Uph. Seat

- counter height stool
- available in Matte plastic shell colors
- available in Cherry Tomato Gloss plastic shell for limited time only - contact CS for qty
- sled base available in 26 metal finishes, see below for options and pricing

Dimensions	D	W	H
Overall	19 ½	21 ½	40
Seat	16	18 ½	26
Upholstery		Shipping	
COM Ydg	¾	Ctn Wt	24
COL Sq Ft	13	Cu Ft	13

Plastic Seat	\$897
COM	\$1,082
A	\$1,106
B	\$1,129
COL/C	\$1,163
D	\$1,210
E	\$1,256
F	\$1,330
G	\$1,406
H	\$1,486
I	\$1,612
J	\$1,768
L1	\$1,419
L2	\$1,502

40" h Wrap Counter Stool



WK825AP
plastic seat

WK825CP
uph. seat



translucent
seat

WK825AP Plastic Seat
WK825CP Uph. Seat

- counter height stool
- available in Matte plastic shell colors
- available in Gloss and Translucent plastic shell for limited time only - contact CS for qty
- sled base available in 26 metal finishes, see below for options and pricing

Dimensions	D	W	H
Overall	19 ½	24 ¾	40
Seat	16	18 ½	26
Arm			36 ½
Upholstery		Shipping	
COM Ydg	¾	Ctn Wt	26
COL Sq Ft	13	Cu Ft	13



Plastic Seat	\$956
COM	\$1,133
A	\$1,160
B	\$1,179
COL/C	\$1,215
D	\$1,262
E	\$1,307
F	\$1,380
G	\$1,456
H	\$1,536
I	\$1,665
J	\$1,817
L1	\$1,472
L2	\$1,554




To Order, Specify:

- 1 Model Number
- 2 Shell Color [See Shell Color Options](#)
- 3 Fabric Selection - vendor, pattern and color
Visit www.jsifurniture.com/finishes-and-materials/textiles for our textiles program.
See selection of standard and graded in manufacturers and patterns.
- 4 Metal Leg Finish [See Metal Leg Finish Options](#)
- 5 Optional Felt Glides - no upcharge


Specifications


- Plastic/Translucent - ¼" thick plastic seat and back.
- Wood - ¾" thick, 5 ply wood seat and back.
- Seat is upholstered with ¾" polyurethane foam.
- Chromium plated metal legs.
- 4-leg chairs standard with nylon glides.
- Sled base standard with snap-on clear glides.

Description	Model	Specifications	List Price Per Grade												
43½" Armless Barstool  WK828AP plastic seat	WK828AP Plastic Seat WK828CP Uph. Seat <ul style="list-style-type: none"> · bar height stool · available in Matte plastic shell colors · available in Cherry Tomato Gloss plastic shell for limited time only - contact CS for qty · sled base available in 26 metal finishes, see below for options and pricing 	<table border="1"> <thead> <tr> <th>Dimensions</th> <th>D</th> <th>W</th> <th>H</th> </tr> </thead> <tbody> <tr> <td>Overall</td> <td>19 ½</td> <td>21 ½</td> <td>43 ½</td> </tr> <tr> <td>Seat</td> <td>16</td> <td>18 ½</td> <td>29 ½</td> </tr> </tbody> </table>	Dimensions	D	W	H	Overall	19 ½	21 ½	43 ½	Seat	16	18 ½	29 ½	Plastic Seat \$907 COM \$1,083 A \$1,107 B \$1,130 COL/C \$1,164 D \$1,211 E \$1,258 F \$1,332 G \$1,407 H \$1,487 I \$1,613 J \$1,769 L1 \$1,420 L2 \$1,504
		Dimensions	D	W	H										
Overall	19 ½	21 ½	43 ½												
Seat	16	18 ½	29 ½												
<table border="1"> <thead> <tr> <th>Upholstery</th> <th colspan="3">Shipping</th> </tr> </thead> <tbody> <tr> <td>COM Ydg</td> <td>¾</td> <td>Ctn Wt</td> <td>26</td> </tr> <tr> <td>COL Sq Ft</td> <td>15</td> <td>Cu Ft</td> <td>14</td> </tr> </tbody> </table>	Upholstery	Shipping			COM Ydg	¾	Ctn Wt	26	COL Sq Ft	15	Cu Ft	14			
Upholstery	Shipping														
COM Ydg	¾	Ctn Wt	26												
COL Sq Ft	15	Cu Ft	14												
 WK828CP uph. seat															

43½" Wrap Barstool  WK827AP plastic seat	WK827AP Plastic Seat WK827CP Uph. Seat <ul style="list-style-type: none"> · bar height stool · available in Matte plastic shell colors · available in Gloss and Translucent plastic shell for limited time only - contact CS for qty · sled base available in 26 metal finishes, see below for options and pricing 	<table border="1"> <thead> <tr> <th>Dimensions</th> <th>D</th> <th>W</th> <th>H</th> </tr> </thead> <tbody> <tr> <td>Overall</td> <td>19 ½</td> <td>24 ¾</td> <td>43 ½</td> </tr> <tr> <td>Seat</td> <td>16</td> <td>18 ½</td> <td>29 ½</td> </tr> <tr> <td>Arm</td> <td></td> <td></td> <td>39 ½</td> </tr> </tbody> </table>	Dimensions	D	W	H	Overall	19 ½	24 ¾	43 ½	Seat	16	18 ½	29 ½	Arm			39 ½	Plastic Seat \$958 COM \$1,134 A \$1,161 B \$1,182 COL/C \$1,216 D \$1,263 E \$1,310 F \$1,381 G \$1,457 H \$1,537 I \$1,666 J \$1,820 L1 \$1,473 L2 \$1,555
		Dimensions	D	W	H														
Overall	19 ½	24 ¾	43 ½																
Seat	16	18 ½	29 ½																
Arm			39 ½																
<table border="1"> <thead> <tr> <th>Upholstery</th> <th colspan="3">Shipping</th> </tr> </thead> <tbody> <tr> <td>COM Ydg</td> <td>¾</td> <td>Ctn Wt</td> <td>28</td> </tr> <tr> <td>COL Sq Ft</td> <td>15</td> <td>Cu Ft</td> <td>15</td> </tr> </tbody> </table>	Upholstery	Shipping			COM Ydg	¾	Ctn Wt	28	COL Sq Ft	15	Cu Ft	15							
Upholstery	Shipping																		
COM Ydg	¾	Ctn Wt	28																
COL Sq Ft	15	Cu Ft	15																
 WK827CP uph. seat																			
 translucent seat																			

WINK

Description	① Model	Specifications			List Price	
32½" h Armless Mini Counter Stool 	WK826AP Plastic Seat <ul style="list-style-type: none"> · counter height stool · available with Matte Plastic shell colors · NOT available in Gloss or Translucent shell colors · sled base available in 26 metal finishes, see below for options and pricing 	Dimensions	D	W	H	\$691
		Overall	19	21½	32½	
		Seat	14½	17¼	25½	
		Shipping				
			Ctn Wt		23	
			Cu Ft		10	

32½" h Armless Mini Counter Stool 	WK836AP Plastic Seat <ul style="list-style-type: none"> · counter height stool · available with Matte Plastic shell colors · NOT available in Gloss or Translucent shell colors · 4-leg base available in 26 metal finishes, see below for options and pricing · rubber nylon glides standard, optional felt glides, no upcharge 	Dimensions	D	W	H	\$691
		Overall	19	18	32½	
		Seat	14½	17¼	25½	
		Shipping				
			Ctn Wt		15	
			Cu Ft		9	


To Order, Specify:


- ① Model Number
- ② Shell Color [See Shell Color Options](#)
- ③ Fabric Selection - vendor, pattern and color
Visit www.jsifurniture.com/finishes-and-materials/textiles for our textiles program.
See selection of standard and *graded* in manufacturers and patterns.
- ④ Metal Leg Finish [See Metal Leg Finish Options](#)
- ⑤ Optional Felt Glides - no upcharge

Specifications

- Plastic/Translucent - ¼" thick plastic seat and back.
- Wood - ¾" thick, 5 ply wood seat and back.
- Seat is upholstered with ¾" polyurethane foam.
- Chromium plated metal legs.
- 4-leg chairs standard with nylon glides.
- Sled base standard with snap-on clear glides.

WINK

Description	① Model	Specifications			List Price	
 <p>38 1/4" h Armless Mini Barstool</p>	<p>WK829AP Plastic Seat</p> <ul style="list-style-type: none"> · bar height stool · available with Matte Plastic shell colors · NOT available in Gloss or Translucent shell colors · sled base available in 26 metal finishes, see below for options and pricing 	Dimensions	D	W	H	\$697
		Overall	19	21 1/2	38 1/4	
		Seat	14 1/2	17 1/4	30 1/4	
		Shipping		Ctn Wt	24	
		Cu Ft	12			

 <p>38 1/4" h Armless Mini Barstool</p>	<p>WK839AP Plastic Seat</p> <ul style="list-style-type: none"> · bar height stool · available with Matte Plastic shell colors · NOT available in Gloss or Translucent shell colors · 4-leg base available in 26 metal finishes, see below for options and pricing · rubber nylon glides standard, optional felt glides, no upcharge 	Dimensions	D	W	H	\$697
		Overall	19	18	38 1/4	
		Seat	14 1/2	17 1/4	30 1/4	
		Shipping		Ctn Wt	16	
		Cu Ft	10			

To Order, Specify:

- ① Model Number
- ② Shell Color [See Shell Color Options](#)
- ③ Fabric Selection - vendor, pattern and color
Visit www.jsifurniture.com/finishes-and-materials/textiles for our textiles program.
See selection of standard and graded in manufacturers and patterns.
- ④ Metal Leg Finish [See Metal Leg Finish Options](#)
- ⑤ Optional Felt Glides - no upcharge

Specifications

- Plastic/Translucent - 1/4" thick plastic seat and back.
- Wood - 5/16" thick, 5 ply wood seat and back.
- Seat is upholstered with 3/4" polyurethane foam.
- Chromium plated metal legs.
- 4-leg chairs standard with nylon glides.
- Sled base standard with snap-on clear glides.

Ziva Lounge Order Check List:



Specify:

- 1. Model Number
- 2. Fabric Selection - vendor, pattern and color (select models offer contrasting upholstery, see page ZV7 for details)
- 3. Front Casters and Back Handle (single seat); add \$148 list
- 4. Optional Tablet Arm - Indicate left (TBL) or right (TBR); laminate or veneer add \$547 list, solid surface add \$648 list
- 5. Optional Side Power - Black (B) or White; add \$462 list each and indicate left or right
- 6. Optional Back Power - Select USB Dual Charging (USB) or Single Simplex Plug (SSP); Black (B) or White; upcharge applies
- 7. Optional Stand Up Surface with Privacy Screen - stand up surface specify JSI standard laminate and privacy screen; upcharge applies

Example:

ZV6665 | MOMENTUM | VOX | MYSTIC
 (model #) | (fabric vendor) | (pattern name) | (pattern color)

1. Model number

3. Fabric Selection - Please supply the following:
 Fabric vendor/ Pattern name/ Pattern color

For a complete list of JSI Standard and Graded-In Textiles click here

When specifying contrasting upholstery complete the form on page 329. Use higher grade pricing.

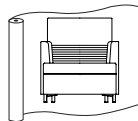
- Fabric for Ziva is always railroaded
- Please provide illustration, if available

All COM orders must include the following:

- Vendor's name, pattern name and color
- Sample of the fabric attached to the order
- Model numbers of items for fabric application
- Special application instructions (e.g., all stripes will be applied front to back unless specified otherwise)
- Customer and purchase order number

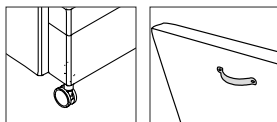
Ship prepaid COM material to:
 JSI
 Attn: COM Dept
 201 East Martin Street
 Receiving B, Dock 71
 Orleans, IN 47452

Application of fabric:
 Railroaded

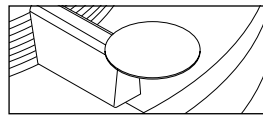


All COM orders will ship at standard lead time from receipt of COM except for orders requiring special custom matched finishes.

3. Front Casters and Back Handle - (single seat) - add \$148 list



4. Tablet Arm:



- 14" dia
- Specify Tablet Arm option (TBL) or right (TBR); laminate or veneer add \$547 list, solid surface add \$648 list for each tablet arm specified. For material offering see Ziva table top selection on page ZV4

5. Side Power:



Power Outlet - add \$462 list
 2- 120 volt
 2- USB Power
 1- Open Port

6. Back Power:



2- USB Power 1- 120 Volt

upcharges vary, see specific model numbers

7. Standup Surface Laminate Color Selection:

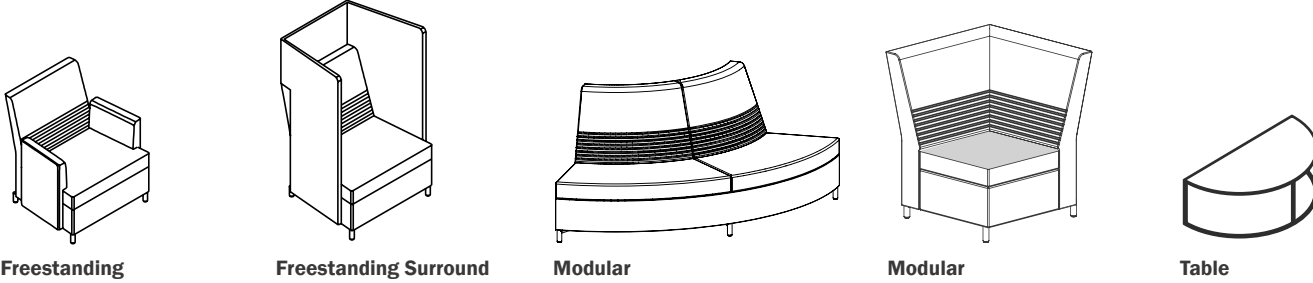
ALB	Alabaster	GRH	Graphite
ALL	Ale Light	MIN	Mineral
BLK	Black	OAT	Oatmeal Cookie
BOL	Bourbon Light	PIN	Pinnacle Walnut
BZW	Brazilwood	SHD	Shadow
BBL	Bridal Blanco	SLG	Slate Grey
BGL	Brighton Light	STU	Studio Teak
CLL	Collectors	VAL	Valley
DWH	Designer White	VIN	Vintage
FAW	Fawn	WEA	Weathered Ash
FLO	Florence Walnut		

Privacy Screen Colors:

ASH	Ash Grey	MLK	Milky
CRE	Cream	SIL	Silver Grey
GRY	Grey	WHT	White

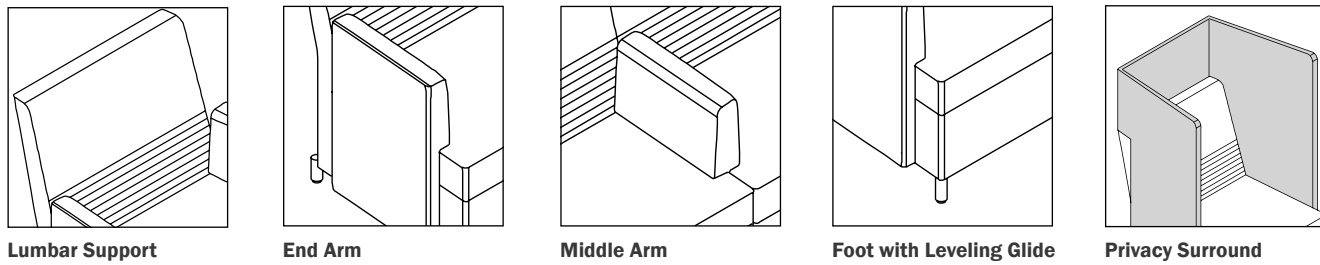
Overview

Ziva is a comprehensive collection of freestanding and configurable seating with an offering of occasional and work tables.



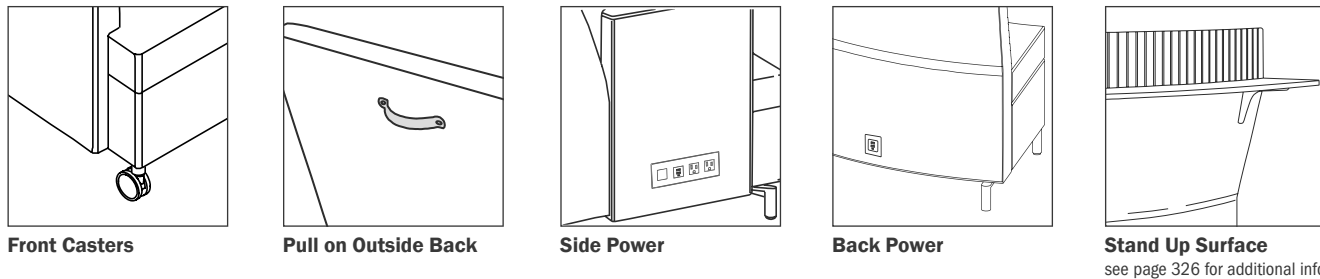
Features

Functional details are integrated into the high design of Ziva. The linear stitch pattern in the lumbar area creates interest, while adding comfort. End and middle arms allow for optional tablet. The custom foot allows for leveling and supports the caster option, if mobility is needed. An upper privacy surround on the single or two seater has acoustical capabilities, creating visual and audible privacy for the seated user.



Product Options

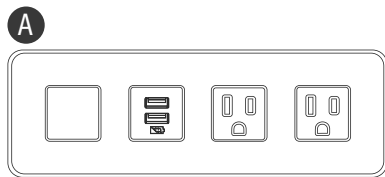
The models come with a variety of options. The front casters and back handle on the single seat provides for mobility. Several options in power and charging along with a stand up surface providing solutions for versatile environment.



Product Options

Selected Ziva lounge models may be specified with power in two different locations. Power outlets on the side of units (including the end arm or the privacy surround) will have **A** configuration. Power outlets on the lower center back have the option of **B** or **C** configuration per model. All units are available in black or white and have a 10' cord.

Side Power Option



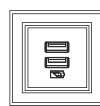
A Power Outlet

- 2- 120 volt
- 2- USB Power
- 1- Open Port

open port allow unit to be customized, adapter kit is included

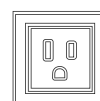
Back Power Option

- B Power Outlet**
- 2- USB Power /per device



C Power Outlet

- 1- 120 volt /per device



Back Option Devices Per Model

Model Type	# of Devices	USB	Simplex
single seat	1	\$243	\$169
two seat	2	\$486	\$338
three seat	3	\$729	\$507
wedge with full back	1	\$243	\$169
quarter round full back	2	\$486	\$338
quarter round w/partial back	1	\$243	\$169

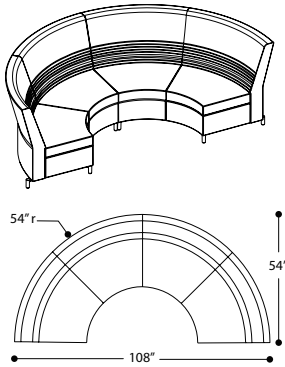
all devices must be the same per model

Configurable

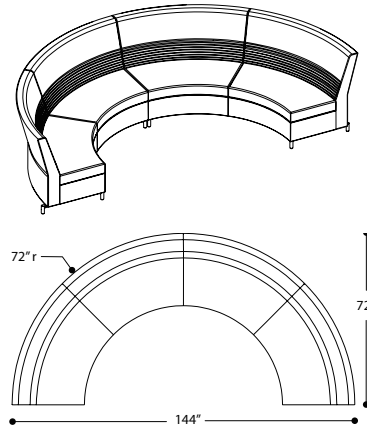
Quarter Round

Ziva's modular lounge with 54" and 72" outside radius or 14" and 32" inside radius can provide for solutions for small or large spaces. All radius will work together to create unique solutions.

2 - 54" Quarter Round

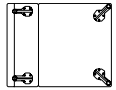


2 - 72" Quarter Round

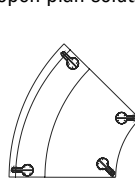


Modular Units

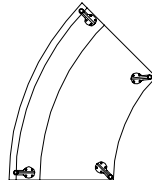
Maximum configurability is achieved with wedge, quarter round and in-line units. Modular benches available in round or in-line enhance the layout possibilities while creating an open plan solution.



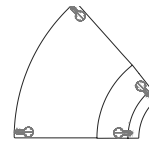
In-Line



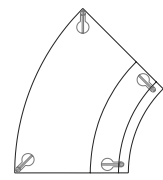
54" Outside Wedge



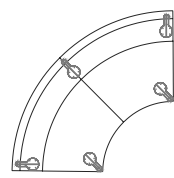
72" Outside Wedge



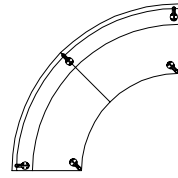
14" Inside Wedge



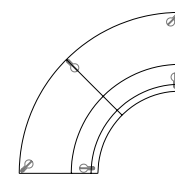
32" Inside Wedge



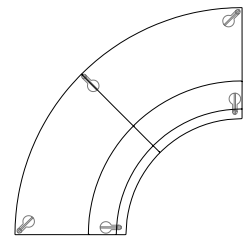
54" Outside Qtr Round



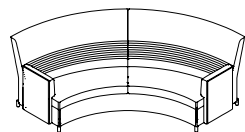
72" Outside Qtr. Round



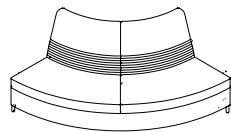
14" Inside Qtr. Round



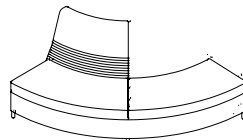
32" Inside Qtr. Round



Outside Back with Arms



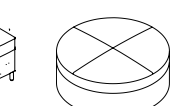
Inside Back



Partial Back



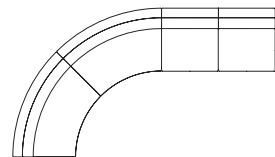
Bench



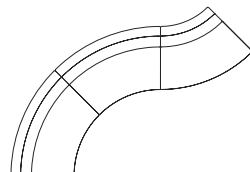
Ottoman

Recommended Combinations

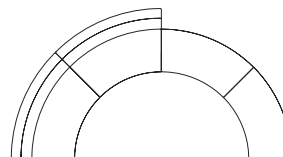
Ziva is designed to fit the user's preference. To uphold the design statement of Ziva, it is recommended that adjacent layouts have backs on the same side (example 1 & 2) or attached to a bench (example 3). Opposite facing configurations may be achieved by placing a bench or benches in between the two directions (example 4).



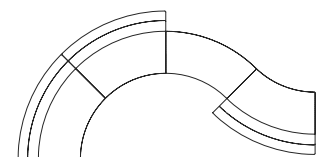
(example 1)



(example 2)



(example 3)

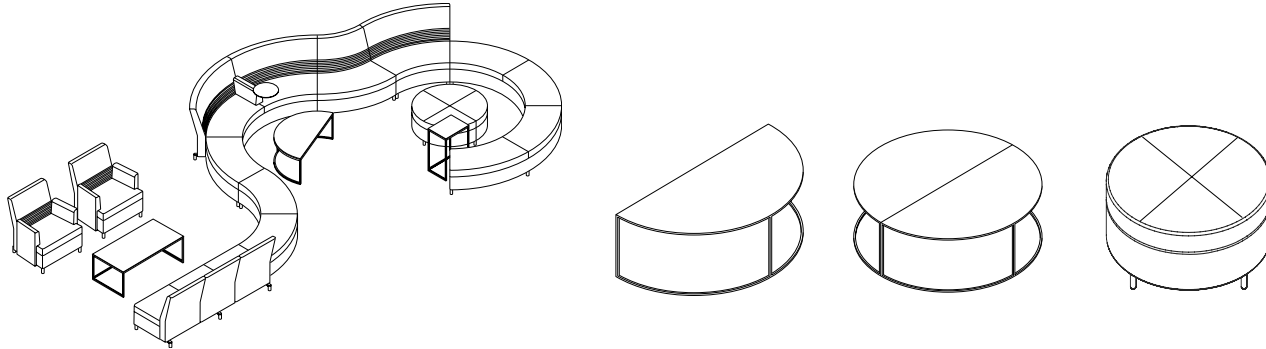


(example 4)

Ottomans and Tables

Ottomans and tables can complete a layout and provide functionality. The ottomans are available in four diameters. Both the ottoman or the half round coffee table fit perfectly inside round configurations.

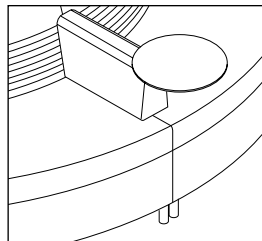
The light scale tables have an Arctic Silver powder coat frame with wood, laminate or solid surface top. The versatile work height tables serve as an end table and arm rest. They can be positioned over benches or the seated user to be used as a work surface. Tables are available in square, rectangle, or half round. They are designed to be used individually or paired up with a matching table.



Tablet Table Option

All arms on freestanding and modular units are available with an optional 14" diameter tablet. It is offered in 3/4" thick wood, 3/4" thick laminate or 1/2" thick solid surface. The wood tablet is available in Cherry, Maple and Walnut.

The tablet is on a swivel mechanism allowing it to be placed closer to the user. The recommended weight limit for the tablet is 75lbs. JSI does not warrant any damage as a result of excessive weight.



Tablet
(shown on a middle arm)
Veneer - add \$547
Laminate - add \$547
Solid Surface - add \$648

CH1 Cherry *Flat Cut Veneer*

BBM Bourbon Medium	CLL Collectors
BRM Brighton Medium	HRV Harvest
CLA Classic	PRL Praline

MA1 Maple *Flat Cut Veneer*

ALM Ale Medium	FLX Flax
BUT Butterscotch	VEN Venetian

B01 Black Oak *Flat Cut Veneer*

RAV Raven

HPL Wood Grain Pattern Laminates

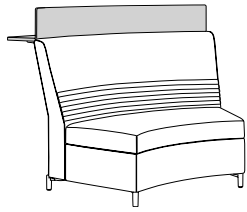
ALL Ale Light	MIN Mineral
BOL Bourbon Light	OAT Oatmeal Cookie
BZW Brazilwood	PIN Pinnacle Walnut
BGL Brighton Light	STU Studio Teak
CLL Collectors	UMB Umber
FAW Fawn	VAL Valley
FLO Florence Walnut	VIN Vintage
GRH Graphite	WEA Weathered Ash

HPL Solid Laminates

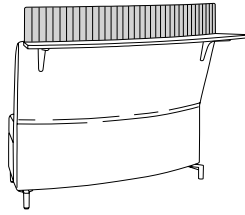
ALB Alabaster	DWH Designer White
BLK Black	SHD Shadow
BBL Bridal Blanco	SLG Slate Grey

Stand Up Surface with Privacy Screen

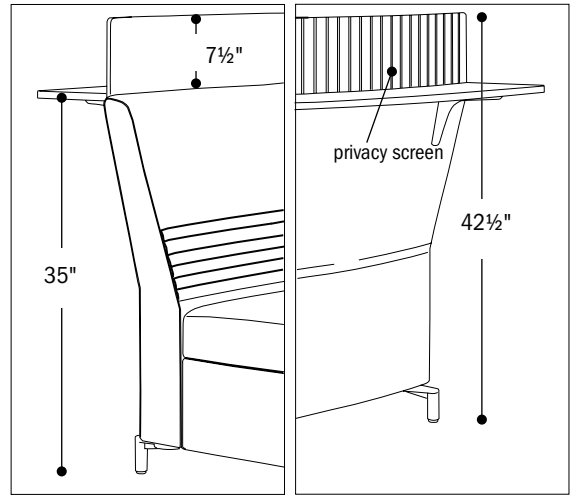
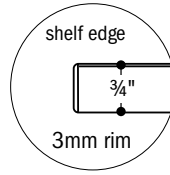
Stand Up Surface is 3/4" thick provides 9 1/4" deep surface, mounted at 35"h. This option is available on many of the units, and come with acoustical texture privacy panels. The privacy screen is available in six colors.



Stand Up Surface
All JSI standard laminates



Privacy Screen
Ash Grey Grey Silver Grey
Cream Milk White



Use JSI Counter Height Stools for proper seating height.

54"r modular units

ZV6550-OB	\$550
ZV6588-ROB	\$550
ZV6588-LOB	\$550
ZV6588-FOB	\$1,179
ZV6588-FOB-RA	\$1,179
ZV6588-FOB-LA	\$1,179

72"r modular units

ZV6650-OB	\$723
ZV6688-ROB	\$723
ZV6688-LOB	\$723
ZV6688-FOB	\$1,356
ZV6688-FOB-RA	\$1,356
ZV6688-FOB-LA	\$1,356

freestanding models

ZV6660	\$550
ZV6670	\$755
ZV6680	\$996
ZV6665	\$550
ZV6675	\$755
ZV6685	\$996
ZV6628-FB	\$550
ZV6655-FB	\$755
ZV6683-FB	\$996
ZV6688-FOB-2A	\$1,356

Lounge

Rights and Lefts

The handedness of the chair is determined by seated position.

Frame Construction

Frame interior is upholstery grade plywood with glued solid hardwood cross members reinforced with wood screws.

Seat Construction

Seat has synthetic sheet webbing with cross strap and 3 5/8" thick high resiliency polyurethane multi-density foam.

Back Construction

Back has 1 3/4" thick polyurethane foam, back lumbar has 10 channel stitch detail thru 3/8" thick polyurethane foam.

Arm Construction

3/4" of high grade polyurethane foam covers a plywood constructed arm frame.

Upholstery Detail

Contrasting fabric available on the back or the arms and seat.

Patterned fabric is not recommended as the fabric may not align at the same location.

Screen & Shelf - Outside BackTables

Frame Construction

Arctic Silver powder-coat finish over a fabricated and welded tubular frame.

Top Construction - Veneer

1.5 mm rimmed core with veneer surface.

Legs

Die cast zinc with matte chrome finish.

1" of height adjustability on the glide.

Tablet Arm

3/4" thick with Veneer or 1/2" thick Solid surface. Mechanism allows for a full 360 degree of swivel and writing surface of 14" diameter.

Important Upholstery Information

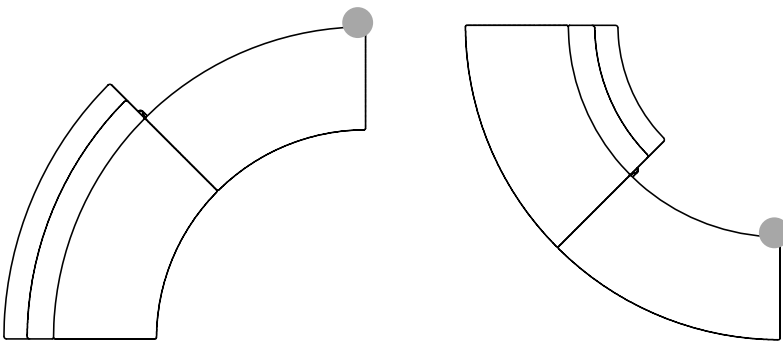
To reduce the number of seams and to achieve a clean look, **Railroaded** off the roll application is standard for Ziva. Line art and pricing for Ziva reflects railroaded fabric. **Due to the size of Ziva and minimal seams, patterned fabrics with the nap (side to side), and leather are not recommended.**

JSI strives to achieve customer satisfaction, therefore requests for patterned fabrics, with a nap application, and leather will be reviewed on a case by case basis. Fill out the sample form on the next page and contact Customer Service. Additional fabric yardage may be required and will be the customer's responsibility. The customer may also be asked to approve additional seaming. Other additional charges may apply. If a patterned fabric is specified, JSI does not guarantee matching at seams.

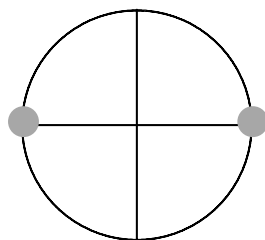
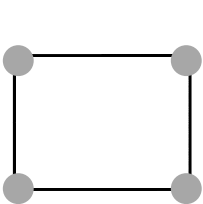
Standard Seaming

The back and seat are upholstered separately and therefore will have no joining seams, only tailoring seams as per the product design. Shown below are examples of seams required to join the fabric on the seat and surround. (marked with a ●)

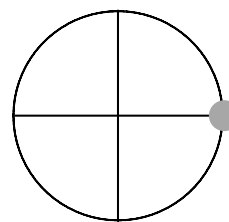
The seat seam is hidden on freestanding and modular units with full backs. Partial back modular units have seaming on the bench section on the same side as the back.



Benches (freestanding and modular) and ottomans have tailoring seams to align with the feet on the seat platform.

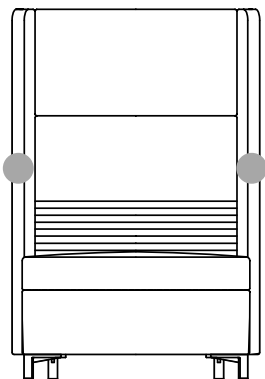


48" and 42"



36"

Privacy Surround will have a fabric joining seam on the front band of surround.

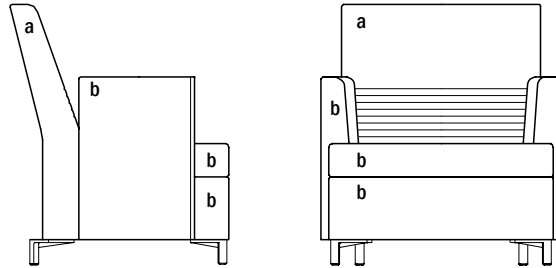


Seating Material Options

This form must accompany order when specifying contrasting or complementary upholstery.

Call for yardage and pricing.

Area (a), (b) and (c) are upholstery and can be specified in contrasting fabric. Legs and handle are a die-cast zinc with a matte chrome finish.



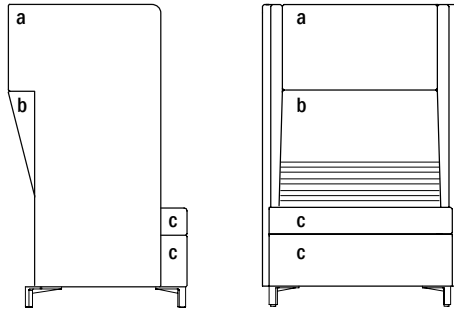
Freestanding & Modular

Model Number: _____

Back (a): _____

Arms, Seat & Base (b): _____

photo copy or scan



Freestanding with Surround

Model Number: _____

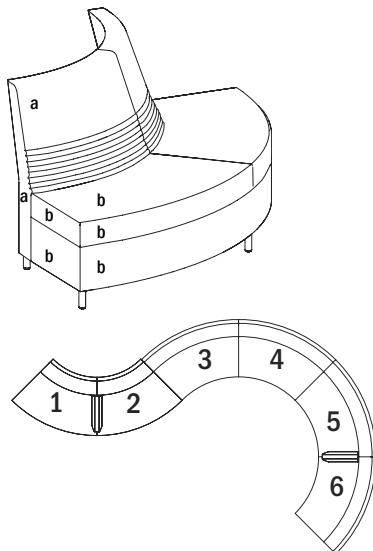
Surround (a): _____

Back (b): _____

Seat & Base (c): _____

Large Configurations

When using three or more modular units that will be connected as a single configuration, it is very helpful if the models and upholstery fabric are listed in sequence. This will assist in the order entry process and assure a better match of the configuration. Refer to the diagrams below.



Sequence	Model #	Fabric a	Fabric b
1 of _____	_____	_____	_____
2 of _____	_____	_____	_____
3 of _____	_____	_____	_____
4 of _____	_____	_____	_____
5 of _____	_____	_____	_____
6 of _____	_____	_____	_____
7 of _____	_____	_____	_____
8 of _____	_____	_____	_____
9 of _____	_____	_____	_____

Ziva

FREESTANDING



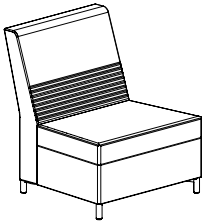
Description

① Model

Specifications

List Price Per Grade

Single Seat



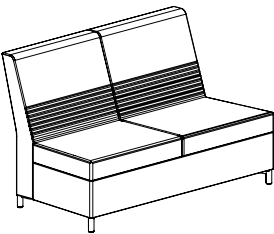
ZV6660

- upholstered seat and back
- armless
- fabric application is railroad
- front casters and pull available, specify and add \$148 list
- seat side power available, specify and add \$462 list; indicate right or left as seated and color Black (B) or White (W)
- power available in the center of the lower extreme back, dual charging USB add \$243 list or single simplex add \$169 list; specify USB or Simplex and color Black (B) or White (W)

Dimensions	D	W	H
Overall	30 3/8	31	36
Seat	20 1/2	29 3/8	17 1/2
Upholstery		Shipping	
COM Ydg	3 1/2	Ctn Wt	82
		Cu Ft	23

COM	\$2,258
A	\$2,309
B	\$2,403
C	\$2,569
D	\$2,779
E	\$2,992
F	\$3,220
G	\$3,537
H	\$3,880
I	\$4,410
J	\$5,049

Two Seat



ZV6670

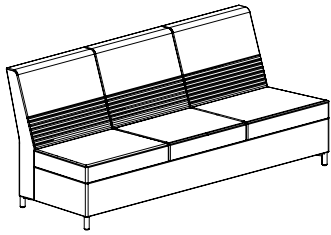
- upholstered seat and back
- armless
- fabric application is railroad
- seat side power available, specify and add \$462 list; indicate right or left as seated and color Black (B) or White (W)
- power available in the left and right of the lower extreme back, dual charging USB add \$486 list or single simplex add \$338 list; specify USB or Simplex and color Black (B) or White (W)

Dimensions	D	W	H
Overall	30 3/8	58 1/2	36
Seat	20 1/2	56 3/4	17 1/2
Upholstery		Shipping	
COM Ydg	7	Ctn Wt	154
		Cu Ft	42

COM	\$3,783
A	\$3,881
B	\$4,071
C	\$4,400
D	\$4,826
E	\$5,252
F	\$5,702
G	\$6,338
H	\$7,021
I	\$8,086
J	\$9,365

Description

Three Seat



Model

ZV6680

- upholstered seat and back
- armless
- fabric application is railroad
- seat side power available, specify and add \$462 list; indicate right or left as seated and color Black (B) or White (W)
- power available in the left, right and center of the lower extreme back, dual charging USB add \$729 list or single simplex add \$507 list; specify USB or Simplex and color Black (B) or White (W)

Specifications

Dimensions	D	W	H
Overall	30 3/8	86	36
Seat	20 1/2	84 3/8	17 1/2
Upholstery		Shipping	
COM Ydg	10 1/2	Ctn Wt	224
		Cu Ft	62

List Price Per Grade

COM	\$5,680
A	\$5,827
B	\$6,109
C	\$6,609
D	\$7,247
E	\$7,885
F	\$8,557
G	\$9,519
H	\$10,537
I	\$12,134
J	\$14,052

To Order, Specify:

- 1 Model Number
- 2 Fabric Selection - vendor, pattern and color
Visit www.jsifurniture.com/finishes-and-materials/textiles for our textiles program. See selection of standard and graded in manufacturers and patterns.

Specifications

- Fabric is railroaded.
- Non-patterned textile is recommended.
- Frame interior is upholstery grade plywood with glued solid hardwood cross members reinforced with wood screws.
- Seat has synthetic sheet webbing with cross strap and 3 3/8" thick high resiliency seat polyurethane multi-density foam.
- Back has 1 3/4" thick polyurethane foam, back lumbar has 10 channel stitch detail thru 3/8" thick polyurethane foam.
- 3/4" of high grade polyurethane foam covers a plywood constructed arm frame.

Ziva

FREESTANDING



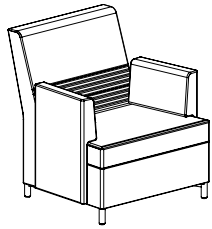
Description

1 Model

Specifications

List Price Per Grade

Single Seat



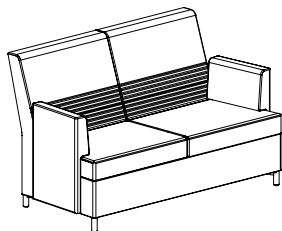
ZV6665

- upholstered seat, back and arms
- fabric application is railroad
- front casters and pull available, specify and add \$148 list
- tablet available, specify and add \$648 list for standard solid surface or \$547 list for laminate or veneer; indicate right or left as seated and finish
- seat side power available, specify and add \$462 list; indicate right or left as seated and color Black (B) or White (W)
- power available in the center of the lower extreme back, dual charging USB add \$243 list or single simplex add \$169 list; specify USB or Simplex and color Black (B) or White (W)
- stand up surface with privacy screen available, add \$550; specify standard JSI laminate for top and the color of felt board for the privacy screen

Dimensions	D	W	H
Overall	30 3/8	33 1/8	36
Seat	20 1/2	24 1/4	17 1/2 \$169
Arm			26
Upholstery		Shipping	
COM Ydg	5	Ctn Wt	97
		Cu Ft	24

COM	\$2,885
A	\$2,952
B	\$3,088
C	\$3,325
D	\$3,628
E	\$3,932
F	\$4,253
G	\$4,709
H	\$5,195
I	\$5,958
J	\$6,868

Two Seat



ZV6675

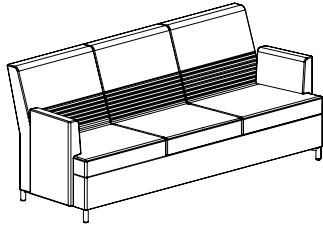
- upholstered seat, back and arms
- fabric application is railroad
- tablet available, specify and add \$648 list for standard solid surface or \$547 list for laminate or veneer; indicate right or left as seated and finish
- seat side power available, specify and add \$462 list; indicate right or left as seated and color Black (B) or White (W)
- power available in the left and right of the lower extreme back, dual charging USB add \$486 list or single simplex add \$338 list; specify USB or Simplex and color Black (B) or White (W)
- stand up surface with privacy screen available, add \$755; specify standard JSI laminate for top and the color of felt board for the privacy screen

Dimensions	D	W	H
Overall	30 3/8	60 3/4	36
Seat	20 1/2	51 3/4	17 1/2
Arm			26
Upholstery		Shipping	
COM Ydg	8 1/2	Ctn Wt	198
		Cu Ft	44

COM	\$4,493
A	\$4,609
B	\$4,840
C	\$5,243
D	\$5,757
E	\$6,273
F	\$6,821
G	\$7,598
H	\$8,423
I	\$9,716
J	\$11,269

Description

Three Seat



1 Model

ZV6685

- upholstered seat, back and arms
- fabric application is railroad
- tablet available, specify and add \$648 list for standard solid surface or \$547 list for laminate or veneer; indicate right or left as seated and finish
- seat side power available, specify and add \$462 list; indicate right or left as seated and color Black (B) or White (W)
- power available in the left, right and center of the lower extreme back, dual charging USB add \$729 list or single simplex add \$507 list; specify USB or Simplex and color Black (B) or White (W)
- stand up surface with privacy screen available, add \$971; specify standard JSI laminate for top and the color of felt board for the privacy screen

Specifications

Dimensions	D	W	H
Overall	30 3/8	88 1/4	36
Seat	20 1/2	79 1/4	17 1/2
Arm			26
Upholstery	Shipping		
COM Ydg	12	Ctn Wt	258
		Cu Ft	63

List Price Per Grade

COM	\$6,409
A	\$6,572
B	\$6,898
C	\$7,467
D	\$8,196
E	\$8,926
F	\$9,696
G	\$10,793
H	\$11,958
I	\$13,785
J	\$15,974

To Order, Specify:

- 1 Model Number
- 2 Fabric Selection - vendor, pattern and color
Visit www.jsifurniture.com/finishes-and-materials/textiles for our textiles program. See selection of standard and graded in manufacturers and patterns.

Specifications

- Fabric is railroaded.
- Non-patterned textile is recommended.
- Frame interior is upholstery grade plywood with glued solid hardwood cross members reinforced with wood screws.
- Seat has synthetic sheet webbing with cross strap and 3 3/8" thick high resiliency seat polyurethane multi-density foam.
- Back has 1 3/4" thick polyurethane foam, back lumbar has 10 channel stitch detail thru 3/8" thick polyurethane foam.
- 3/4" of high grade polyurethane foam covers a plywood constructed arm frame.

Ziva

FREESTANDING



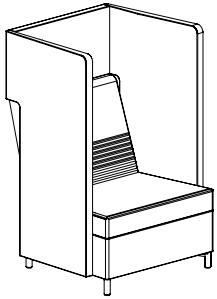
Description

① Model

Specifications

List Price Per Grade

Single Seat with Surround



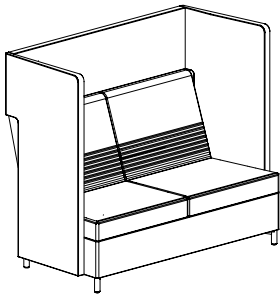
ZV6660-PS

- upholstered seat, back and surround
- fabric application is railroad
- front casters and pull available, specify and add \$148 list
- seat side power available, specify and add \$462 list; indicate right or left as seated and color Black (B) or White (W)

Dimensions	D	W	H
Overall	30 3/8	33 3/4	50 1/2
Seat	20 1/2	24 1/4	17 1/2
Upholstery		Shipping	
COM Ydg	8 1/2	Ctn Wt	119
		Cu Ft	37

COM	\$3,680
A	\$3,795
B	\$4,026
C	\$4,428
D	\$4,945
E	\$5,462
F	\$6,007
G	\$6,783
H	\$7,610
I	\$8,904
J	\$10,454

Two Seat with Surround



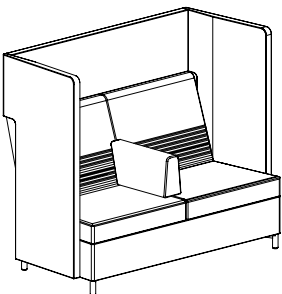
ZV6670-PS

- upholstered seat, back and surround
- fabric application is railroad
- seat side power available, specify and add \$462 list; indicate right or left as seated and color Black (B) or White (W)

Dimensions	D	W	H
Overall	30 3/8	61 1/4	50 1/2
Seat	20 1/2	51 3/4	17 1/2
Upholstery		Shipping	
COM Ydg	12 3/4	Ctn Wt	211
		Cu Ft	61

COM	\$4,919
A	\$5,095
B	\$5,439
C	\$6,043
D	\$6,817
E	\$7,594
F	\$8,413
G	\$9,573
H	\$10,816
I	\$12,755
J	\$15,084

Two Seat with Surround and Middle Arm



ZV6672-PS

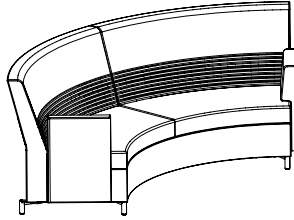
- upholstered seat, back and surround
- fabric application is railroad
- tablet available, specify and add \$648 list for standard solid surface or \$547 list for laminate or veneer
- seat side power available, specify and add \$462 list; indicate right or left as seated and color Black (B) or White (W)

Dimensions	D	W	H
Overall	30 3/8	61 1/4	50 1/2
Seat	20 1/2	51 3/4	17 1/2
Upholstery		Shipping	
COM Ydg	13 1/2	Ctn Wt	225
		Cu Ft	61

COM	\$5,187
A	\$5,373
B	\$5,737
C	\$6,375
D	\$7,196
E	\$8,017
F	\$8,885
G	\$10,116
H	\$11,430
I	\$13,483
J	\$15,946

Description

72" Radius Quarter Round with Outside Back and Arms



Model

ZV6688-FOB-2A

- upholstered seat, back and arms
- fabric application is railroad.
Non-patterned fabrics are recommended
- tablet available, specify and add \$648 list for standard solid surface or \$547 list for laminate or veneer; indicate right or left as seated and finish
- seat side power available, specify and add \$462 list; indicate right or left as seated and color Black (B) or White (W)
- power available in the left and right of the lower extreme back, dual charging USB add \$486 list or single simplex add \$338 list; specify USB or Simplex and color Black (B) or White (W)
- stand up surface with privacy screen available, add \$1,356; specify standard JSI laminate for top and the color of felt board for the privacy screen

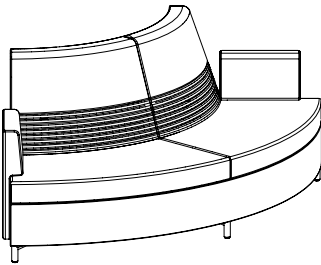
Specifications

Dimensions	D	W	H
Overall	42 1/2	101 1/2	36
Seat	20 1/2	59 1/4	17 1/2
Arm			26
Upholstery		Shipping	
COM Ydg	12 1/2	Ctn Wt	269
		Cu Ft	97

List Price Per Grade

COM	\$6,049
A	\$6,221
B	\$6,558
C	\$7,150
D	\$7,912
E	\$8,671
F	\$9,475
G	\$10,612
H	\$11,830
I	\$13,730
J	\$16,013

32" Radius Quarter Round with Inside Back and Arms



ZV6688-FIB-2A

- upholstered seat, back and arms
- fabric application is railroad.
Non-patterned fabrics are recommended
- tablet available, specify and add \$648 list for standard solid surface or \$547 list for laminate or veneer; indicate right or left as seated and finish
- seat side power available, specify and add \$462 list; indicate right or left as seated and color Black (B) or White (W)

Dimensions	D	W	H
Overall	39 1/2	87 5/8	36
Seat	20 1/2	45 5/8	17 1/2
Arm			26
Upholstery		Shipping	
COM Ydg	9 1/2	Ctn Wt	254
		Cu Ft	81

COM	\$5,959
A	\$6,087
B	\$6,346
C	\$6,794
D	\$7,371
E	\$7,951
F	\$8,558
G	\$9,426
H	\$10,351
I	\$11,795
J	\$13,529

To Order, Specify:

- 1 Model Number
- 2 Fabric Selection - vendor, pattern and color
Visit www.jsifurniture.com/finishes-and-materials/textiles for our textiles program. See selection of standard and graded in manufacturers and patterns.

Specifications

- Fabric is railroaded.
- Non-patterned textile is recommended.
- Frame interior is upholstery grade plywood with glued solid hardwood cross members reinforced with wood screws.
- Seat has synthetic sheet webbing with cross strap and 3 3/8" thick high resiliency seat polyurethane multi-density foam.
- Back has 1 3/4" thick polyurethane foam, back lumbar has 10 channel stitch detail thru 3/8" thick polyurethane foam.
- 3/4" of high grade polyurethane foam covers a plywood constructed arm frame.

Ziva MODULAR



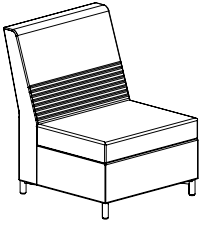
Description

① Model

Specifications

List Price Per Grade

In-Line Single Seat



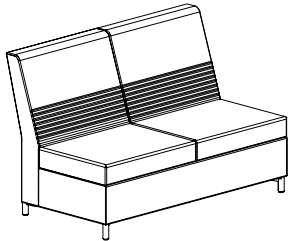
ZV6628-FB

- upholstered seat and back
- armless
- fabric application is railroad. Non-patterned fabrics are recommended
- seat side power available, specify and add \$462 list; indicate right or left as seated and color Black (B) or White (W)
- power available in the center of the lower extreme back, dual charging USB add \$243 list or single simplex add \$169 list; specify USB or Simplex and color Black (B) or White (W)
- stand up surface with privacy screen available, add \$550; specify standard JSI laminate for top and the color of felt board for the privacy screen

Dimensions	D	W	H
Overall	30 3/8	27 1/2	36
Seat	20 1/2	27 1/2	17 1/2
Upholstery		Shipping	
COM Ydg	3 1/2	Ctn Wt	82
		Cu Ft	20

COM	\$2,189
A	\$2,238
B	\$2,333
C	\$2,499
D	\$2,710
E	\$2,924
F	\$3,148
G	\$3,466
H	\$3,809
I	\$4,339
J	\$4,981

In-Line Two Seat



ZV6655-FB

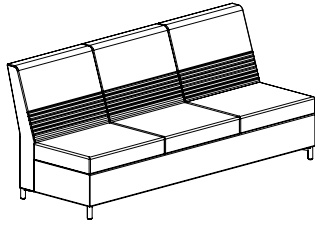
- upholstered seat and back
- armless
- fabric application is railroad. Non-patterned fabrics are recommended
- seat side power available, specify and add \$462 list; indicate right or left as seated and color Black (B) or White (W)
- power available in the left and right of the lower extreme back, dual charging USB add \$486 list or single simplex add \$338 list; specify USB or Simplex and color Black (B) or White (W)
- stand up surface with privacy screen available, add \$755; specify standard JSI laminate for top and the color of felt board for the privacy screen

Dimensions	D	W	H
Overall	30 3/8	55	36
Seat	20 1/2	55 1/8	17 1/2
Upholstery		Shipping	
COM Ydg	7	Ctn Wt	154
		Cu Ft	40

COM	\$3,828
A	\$3,924
B	\$4,114
C	\$4,444
D	\$4,871
E	\$5,295
F	\$5,747
G	\$6,382
H	\$7,067
I	\$8,129
J	\$9,408

Description

In-Line Three Seat



1 Model

ZV6683-FB

- upholstered seat and back
- armless
- fabric application is railroad. Non-patterned fabrics are recommended
- seat side power available, specify and add \$462 list; indicate right or left as seated and color Black (B) or White (W)
- power available in the left, right and center of the lower extreme back, dual charging USB add \$729 list or single simplex add \$507 list; specify USB or Simplex and color Black (B) or White (W)
- stand up surface with privacy screen available, add \$971; specify standard JSI laminate for top and the color of felt board for the privacy screen

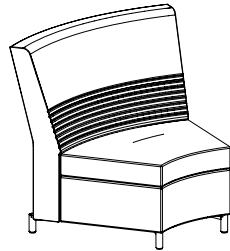
Specifications

Dimensions	D	W	H
Overall	30 3/8	82 1/2	36
Seat	20 1/2	82 5/8	17 1/2
Upholstery		Shipping	
COM Ydg	10 1/2	Ctn Wt	224
		Cu Ft	59

List Price Per Grade

COM	\$5,835
A	\$5,978
B	\$6,263
C	\$6,761
D	\$7,399
E	\$8,035
F	\$8,711
G	\$9,666
H	\$10,688
I	\$12,286
J	\$14,201

72" Radius Wedge with Outside Back



ZV6650-OB

- upholstered seat and back
- armless
- fabric application is railroad. Non-patterned fabrics are recommended
- seat side power available, specify and add \$462 list; indicate right or left as seated and color Black (B) or White (W)
- power available in the center of the lower extreme back, dual charging USB add \$243 list or single simplex add \$169 list; specify USB or Simplex and color Black (B) or White (W)
- stand up surface with privacy screen available, add \$723; specify standard JSI laminate for top and the color of felt board for the privacy screen

Dimensions	D	W	H
Overall	33 1/2	54 7/8	36
Seat	20 1/2	31 1/8	17 1/2
Upholstery		Shipping	
COM Ydg	5 1/2	Ctn Wt	129
		Cu Ft	44

COM	\$2,932
A	\$3,006
B	\$3,153
C	\$3,416
D	\$3,748
E	\$4,084
F	\$4,437
G	\$4,938
H	\$5,474
I	\$6,310
J	\$7,313

To Order, Specify:

- 1 Model Number
- 2 Fabric Selection - vendor, pattern and color
Visit www.jsifurniture.com/finishes-and-materials/textiles for our textiles program. See selection of standard and graded in manufacturers and patterns.

Specifications

- Fabric is railroaded.
- Non-patterned textile is recommended.
- Frame interior is upholstery grade plywood with glued solid hardwood cross members reinforced with wood screws.
- Seat has synthetic sheet webbing with cross strap and 3 3/8" thick high resiliency seat polyurethane multi-density foam.
- Back has 1 3/4" thick polyurethane foam, back lumbar has 10 channel stitch detail thru 3/8" thick polyurethane foam.
- 3/4" of high grade polyurethane foam covers a plywood constructed arm frame.

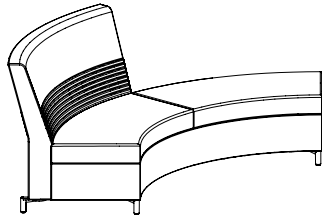
Ziva

MODULAR



Description

72" Radius Quarter Round with Partial Outside Back



right shown

Model

ZV6688-ROB

ZV6688-LOB

- upholstered seat and back
- armless
- fabric application is railroad. Non-patterned fabrics are recommended
- seat side power available, specify and add \$462 list; indicate right or left as seated and color Black (B) or White (W)
- power available in the center of the lower extreme back, dual charging USB add \$243 list or single simplex add \$169 list; specify USB or Simplex and color Black (B) or White (W)
- stand up surface with privacy screen available, add \$723; specify standard JSI laminate for top and the color of felt board for the privacy screen

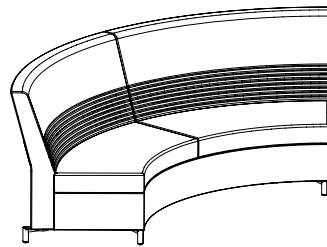
Specifications

Dimensions	D	W	H
Overall	42 ½	94 7/8	36
Seat	20 ½	59 ¼	17 ½
Upholstery		Shipping	
COM Ydg	7	Ctn Wt	231
		Cu Ft	92

List Price Per Grade

COM	\$4,185
A	\$4,281
B	\$4,472
C	\$4,802
D	\$5,227
E	\$5,654
F	\$6,104
G	\$6,741
H	\$7,423
I	\$8,490
J	\$9,765

72" Radius Quarter Round with Outside Back



ZV6688-FOB

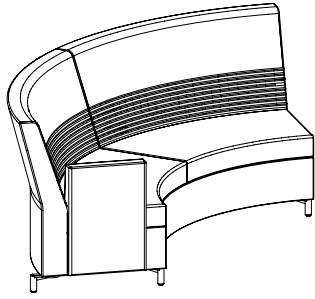
- upholstered seat and back
- armless
- fabric application is railroad. Non-patterned fabrics are recommended
- seat side power available, specify and add \$462 list; indicate right or left as seated and color Black (B) or White (W)
- power available in the left and right of the lower extreme back, dual charging USB add \$486 list or single simplex add \$338 list; specify USB or Simplex and color Black (B) or White (W)
- stand up surface with privacy screen available, add \$1,356; specify standard JSI laminate for top and the color of felt board for the privacy screen

Dimensions	D	W	H
Overall	42 ½	101 ½	36
Seat	20 ½	59 ¼	17 ½
Upholstery		Shipping	
COM Ydg	11	Ctn Wt	190
		Cu Ft	100

COM	\$5,317
A	\$5,466
B	\$5,763
C	\$6,285
D	\$6,953
E	\$7,624
F	\$8,327
G	\$9,332
H	\$10,402
I	\$12,075
J	\$14,081

Description

72" Radius Quarter Round with Outside Back and Arm



right shown

1 Model

ZV6688-FOB-RA
ZV6688-FOB-LA

- upholstered seat, back and arms
- fabric application is railroad.
- Non-patterned fabrics are recommended
- tablet available, specify and add \$648 list for standard solid surface or \$547 list for laminate or veneer
- seat side power available, specify and add \$462 list; indicate right or left as seated and color Black (B) or White (W)
- power available in the left and right of the lower extreme back, dual charging USB add \$486 list or single simplex add \$338 list; specify USB or Simplex and color Black (B) or White (W)
- stand up surface with privacy screen available, add \$1,356; specify standard JSI laminate for top and the color of felt board for the privacy screen

Specifications

Dimensions	D	W	H
Overall	42 ½	101 ½	36
Seat	20 ½	59 ¼	17 ½
Arm			26
Upholstery	Shipping		
COM Ydg	11 ¾	Ctn Wt	275
		Cu Ft	100

List Price Per Grade

COM	\$5,720
A	\$5,882
B	\$6,200
C	\$6,757
D	\$7,471
E	\$8,185
F	\$8,941
G	\$10,013
H	\$11,156
I	\$12,942
J	\$15,088

To Order, Specify:

- 1** Model Number
- 2** Fabric Selection - vendor, pattern and color
Visit www.jsifurniture.com/finishes-and-materials/textiles for our textiles program. See selection of standard and graded in manufacturers and patterns.

Specifications

- Fabric is railroaded.
- Non-patterned textile is recommended.
- Frame interior is upholstery grade plywood with glued solid hardwood cross members reinforced with wood screws.
- Seat has synthetic sheet webbing with cross strap and 3 ¾" thick high resiliency seat polyurethane multi-density foam.
- Back has 1 ¾" thick polyurethane foam, back lumbar has 10 channel stitch detail thru ¾" thick polyurethane foam.
- ¾" of high grade polyurethane foam covers a plywood constructed arm frame.

Ziva MODULAR



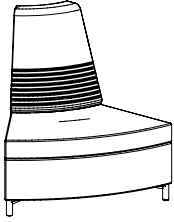
Description

① Model

Specifications

List Price Per Grade

32" Radius Wedge with Inside Back



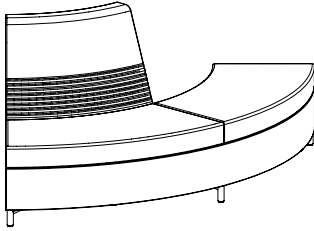
ZV6651-IB

- upholstered seat and back
- armless
- fabric application is railroad. Non-patterned fabrics are recommended
- seat side power available, specify and add \$462 list; indicate right or left as seated and color Black (B) or White (W)

Dimensions	D	W	H
Overall	32 ¾	47 ¾	36
Seat	20 ½	25 ⅞	17 ½
Upholstery		Shipping	
COM Ydg	4	Ctn Wt	114
		Cu Ft	37

COM	\$2,889
A	\$2,943
B	\$3,053
C	\$3,241
D	\$3,483
E	\$3,726
F	\$3,983
G	\$4,349
H	\$4,735
I	\$5,345
J	\$6,076

32" Radius Quarter Round with Partial Inside Back



right shown

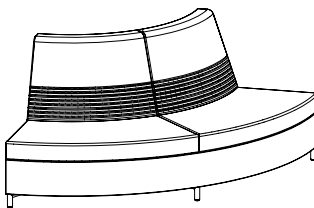
ZV6688-RIB ZV6688-LIB

- upholstered seat and back
- armless
- fabric application is railroad. Non-patterned fabrics are recommended
- seat side power available, specify and add \$462 list; indicate right or left as seated and color Black (B) or White (W)

Dimensions	D	W	H
Overall	39 ½	87 ⅞	36
Seat	20 ½	52 ⅞	17 ½
Upholstery		Shipping	
COM Ydg	5 ½	Ctn Wt	189
		Cu Ft	81

COM	\$4,138
A	\$4,213
B	\$4,363
C	\$4,624
D	\$4,957
E	\$5,293
F	\$5,644
G	\$6,146
H	\$6,683
I	\$7,519
J	\$8,521

32" Radius Quarter Round with Inside Back



ZV6688-FIB

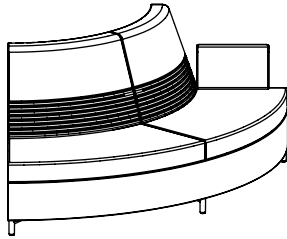
- upholstered seat and back
- armless
- fabric application is railroad. Non-patterned fabrics are recommended
- seat side power available, specify and add \$462 list; indicate right or left as seated and color Black (B) or White (W)

Dimensions	D	W	H
Overall	39 ½	87 ⅞	36
Seat	20 ½	45 ⅞	17 ½
Upholstery		Shipping	
COM Ydg	8	Ctn Wt	231
		Cu Ft	81

COM	\$5,222
A	\$5,330
B	\$5,547
C	\$5,927
D	\$6,413
E	\$6,899
F	\$7,411
G	\$8,145
H	\$8,921
I	\$10,140
J	\$11,598

Description

32" Radius Quarter Round with Inside Back



right shown

Model

ZV6688-FIB-RA
ZV6688-FIB-LA

- upholstered seat, back and arms
- fabric application is railroad.
- Non-patterned fabrics are recommended
- tablet available, specify and add \$648 list for standard solid surface or \$547 list for laminate or veneer
- seat side power available, specify and add \$462 list; indicate right or left as seated and color Black (B) or White (W)

Specifications

Dimensions	D	W	H
Overall	39 1/2	87 5/8	36
Seat	20 1/2	45 5/8	17 1/2
Arm			26
Upholstery	Shipping		
COM Ydg	8 3/4	Ctn Wt	242
		Cu Ft	81

List Price Per Grade

COM	\$5,630
A	\$5,748
B	\$5,984
C	\$6,400
D	\$6,931
E	\$7,465
F	\$8,026
G	\$8,823
H	\$9,676
I	\$11,006
J	\$12,604

To Order, Specify:

- 1 Model Number
- 2 Fabric Selection - vendor, pattern and color
Visit www.jsifurniture.com/finishes-and-materials/textiles for our textiles program. See selection of standard and graded in manufacturers and patterns.

Specifications

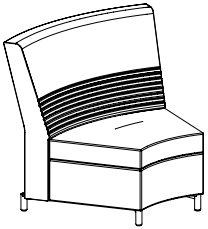
- Fabric is railroaded.
- Non-patterned textile is recommended.
- Frame interior is upholstery grade plywood with glued solid hardwood cross members reinforced with wood screws.
- Seat has synthetic sheet webbing with cross strap and 3 3/8" thick high resiliency seat polyurethane multi-density foam.
- Back has 1 3/4" thick polyurethane foam, back lumbar has 10 channel stitch detail thru 3/8" thick polyurethane foam.
- 3/4" of high grade polyurethane foam covers a plywood constructed arm frame.

Ziva MODULAR



Description

54" Radius Wedge with Outside Back



1 Model

ZV6550-OB

- upholstered seat and back
- armless
- fabric application is railroad. Non-patterned fabrics are recommended
- seat side power available, specify and add \$462 list; indicate right or left as seated and color Black (B) or White (W)
- power available in the center of the lower extreme back, dual charging USB add \$243 list or single simplex add \$169 list; specify USB or Simplex and color Black (B) or White (W)
- stand up surface with privacy screen available, add \$550; specify standard JSI laminate for top and the color of felt board for the privacy screen

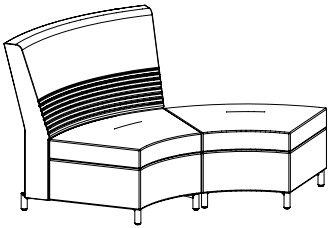
Specifications

Dimensions	D	W	H
Overall	33 ½	41 ⅛	36
Seat	20 ½	18 ¼	17 ½
Upholstery		Shipping	
COM Ydg	3 ¾	Ctn Wt	78
		Cu Ft	34

List Price Per Grade

COM	\$2,430
A	\$2,481
B	\$2,581
COL/C	\$2,756
D	\$2,982
E	\$3,208
F	\$3,557
G	\$3,932
H	\$4,333
I	\$4,960
J	\$5,710

54" Radius Quarter Round with Partial Outside Back



right shown

ZV6588-ROB

ZV6588-LOB

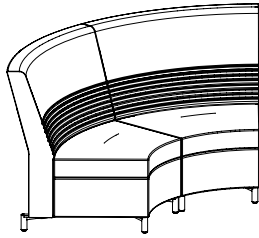
- upholstered seat and back
- armless
- fabric application is railroad. Non-patterned fabrics are recommended
- seat side power available, specify and add \$462 list; indicate right or left as seated and color Black (B) or White (W)
- power available in the center of the lower extreme back, dual charging USB add \$243 list or single simplex add \$169 list; specify USB or Simplex and color Black (B) or white (W)
- stand up surface with privacy screen available, add \$550; specify standard JSI laminate for top and the color of felt board for the privacy screen

Dimensions	D	W	H
Overall	42 ½	95 ⅛	36
Seat	20 ½	33 ½	17 ½
Upholstery		Shipping	
COM Ydg	4 ¾	Ctn Wt	139
		Cu Ft	95

COM	\$3,426
A	\$3,490
B	\$3,619
COL/C	\$3,842
D	\$4,131
E	\$4,418
F	\$4,868
G	\$5,345
H	\$5,858
I	\$6,659
J	\$7,617

Description

54" Radius Quarter Round with Outside Back



1 Model

ZV6588-FOB

- upholstered seat and back
- armless
- fabric application is railroad. Non-patterned fabrics are recommended
- seat side power available, specify and add \$462 list; indicate right or left as seated and color Black (B) or White (W)
- power available in the left and right of the lower extreme back, dual charging USB add \$486 list or single simplex add \$338 list; specify USB or Simplex and color Black (B) or white (W)
- stand up surface with privacy screen available, add \$1,179; specify standard JSI laminate for top and the color of felt board for the privacy screen

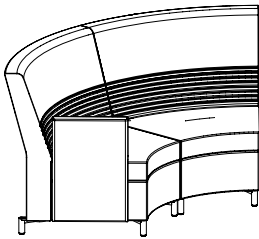
Specifications

Dimensions	D	W	H
Overall	44 ½	75 ¾	36
Seat	20 ½	33 ½	17 ½
Upholstery		Shipping	
COM Ydg	6 ½	Ctn Wt	132
		Cu Ft	81

List Price Per Grade

COM	\$4,170
A	\$4,256
B	\$4,431
COL/C	\$4,732
D	\$5,119
E	\$5,509
F	\$6,111
G	\$6,758
H	\$7,448
I	\$8,527
J	\$9,820

54" Radius Quarter Round with Outside Back and Arm



ZV6588-FOB-RA

ZV6588-FOB-LA

- upholstered seat, back and arms
- fabric application is railroad. Non-patterned fabrics are recommended
- tablet available, specify and add \$648 list for standard solid surface or \$547 list for laminate or veneer
- seat side power available, specify and add \$462 list; indicate right or left as seated and color Black (B) or White (W)
- power available in the left and right of the lower extreme back, dual charging USB add \$486 list or single simplex add \$338 list; specify USB or Simplex and color Black (B) or white (W)
- stand up surface with privacy screen available, add \$1,179; specify standard JSI laminate for top and the color of felt board for the privacy screen

Dimensions	D	W	H
Overall	45 ½	75 ¾	36
Seat	20 ½	33 ½	17 ½
Arm			26
Upholstery		Shipping	
COM Ydg	6 ¾	Ctn Wt	142
		Cu Ft	81

COM	\$4,370
A	\$4,465
B	\$4,650
COL/C	\$4,976
D	\$5,396
E	\$5,815
F	\$6,468
G	\$7,165
H	\$7,913
I	\$9,076
J	\$10,476

To Order, Specify:

- 1 Model Number
- 2 Fabric Selection - vendor, pattern and color
Visit www.jsifurniture.com/finishes-and-materials/textiles for our textiles program. See selection of standard and graded in manufacturers and patterns.

Specifications

- Fabric is railroaded.
- Non-patterned textile is recommended.
- Frame interior is upholstery grade plywood with glued solid hardwood cross members reinforced with wood screws.
- Seat has synthetic sheet webbing with cross strap and 3 ¾" thick high resiliency seat polyurethane multi-density foam.
- Back has 1 ¾" thick polyurethane foam, back lumbar has 10 channel stitch detail thru ¾" thick polyurethane foam.
- ¾" of high grade polyurethane foam covers a plywood constructed arm frame.

Ziva MODULAR



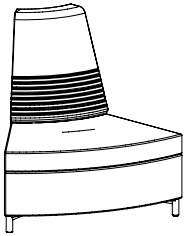
Description

① Model

Specifications

List Price Per Grade

14" Radius Wedge with Inside Back



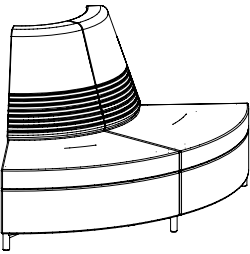
ZV6551-IB

- upholstered seat and back
- armless
- fabric application is railroad. Non-patterned fabrics are recommended
- seat side power available, specify and add \$462 list; indicate right or left as seated and color Black (B) or White (W)

Dimensions	D	W	H
Overall	32 ¾	36 ¾	36
Seat	20 ½	19 ½	17 ½
Upholstery		Shipping	
COM Ydg	3	Ctn Wt	115
		Cu Ft	29

COM	\$2,184
A	\$2,225
B	\$2,306
COL/C	\$2,445
D	\$2,627
E	\$2,810
F	\$3,093
G	\$3,393
H	\$3,718
I	\$4,219
J	\$4,826

14" Radius Quarter Round with Inside Back



ZV6588-FIB

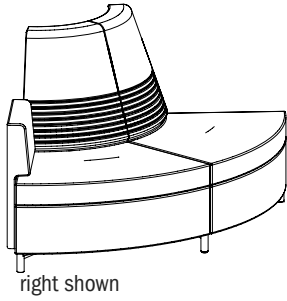
- upholstered seat and back
- armless
- fabric application is railroad. Non-patterned fabrics are recommended
- seat side power available, specify and add \$462 list; indicate right or left as seated and color Black (B) or White (W)

Dimensions	D	W	H
Overall	39 ½	66 ½	36
Seat	20 ½	35 ½	17 ½
Upholstery		Shipping	
COM Ydg	5	Ctn Wt	102
		Cu Ft	63

COM	\$3,690
A	\$3,761
B	\$3,899
COL/C	\$4,143
D	\$4,455
E	\$4,770
F	\$5,256
G	\$5,777
H	\$6,334
I	\$7,202
J	\$8,247

Description

14" Radius Quarter Round with Inside Back and Arm



① Model

ZV6588-FIB-RA
ZV6588-FIB-LA

- upholstered seat, back and arms
- fabric application is railroad.
- Non-patterned fabrics are recommended
- tablet available, specify and add \$648 list for standard solid surface or \$547 list for laminate or veneer
- seat side power available, specify and add \$462 list; indicate right or left as seated and color Black (B) or White (W)

Specifications

Dimensions	D	W	H
Overall	39 ½	66 ½	36
Seat	20 ½	35 ½	17 ½
Arm			26
Upholstery		Shipping	
COM Ydg	5 ¾	Ctn Wt	112
		Cu Ft	63

List Price Per Grade

COM	\$3,860
A	\$3,939
B	\$4,094
COL/C	\$4,367
D	\$4,718
E	\$5,068
F	\$5,613
G	\$6,197
H	\$6,821
I	\$7,795
J	\$8,964

To Order, Specify:

- ① Model Number
- ② Fabric Selection - vendor, pattern and color
Visit www.jsifurniture.com/finishes-and-materials/textiles for our textiles program. See selection of standard and graded in manufacturers and patterns.

Specifications

- Fabric is railroaded.
- Non-patterned textile is recommended.
- Frame interior is upholstery grade plywood with glued solid hardwood cross members reinforced with wood screws.
- Seat has synthetic sheet webbing with cross strap and 3 ¾" thick high resiliency seat polyurethane multi-density foam.
- Back has 1 ¾" thick polyurethane foam, back lumbar has 10 channel stitch detail thru ¾" thick polyurethane foam.
- ¾" of high grade polyurethane foam covers a plywood constructed arm frame.

Ziva MODULAR



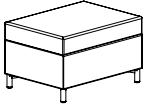
Description

① Model

Specifications

List Price Per Grade

Singe Seat Bench



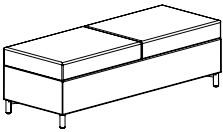
ZV6628

- upholstered seat
- fabric application is railroad. Non-patterned fabrics are recommended
- seat side power available, specify and add \$462 list; indicate right or left as seated and color Black (B) or White (W)

Dimensions	D	W	H
Overall	20 ½	27 ½	17 ½
Upholstery		Shipping	
COM Ydg	2	Ctn Wt	50
		Cu Ft	7

COM	\$1,793
A	\$1,824
B	\$1,876
C	\$1,972
D	\$2,091
E	\$2,213
F	\$2,344
G	\$2,524
H	\$2,719
I	\$3,025
J	\$3,388

Two Seat Bench



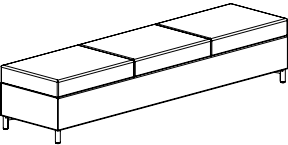
ZV6655

- upholstered seat
- fabric application is railroad. Non-patterned fabrics are recommended
- seat side power available, specify and add \$462 list; indicate right or left as seated and color Black (B) or White (W)

Dimensions	D	W	H
Overall	20 ½	55	17 ½
Upholstery		Shipping	
COM Ydg	4	Ctn Wt	73
		Cu Ft	14

COM	\$3,043
A	\$3,100
B	\$3,207
C	\$3,397
D	\$3,640
E	\$3,884
F	\$4,139
G	\$4,505
H	\$4,893
I	\$5,504
J	\$6,234

Three Seat Bench



ZV6683

- upholstered seat
- fabric application is railroad. Non-patterned fabrics are recommended
- seat side power available, specify and add \$462 list; indicate right or left as seated and color Black (B) or White (W)

Dimensions	D	W	H
Overall	20 ½	82 ½	17 ½
Upholstery		Shipping	
COM Ydg	6	Ctn Wt	146
		Cu Ft	21

COM	\$4,346
A	\$4,428
B	\$4,591
C	\$4,874
D	\$5,242
E	\$5,603
F	\$5,990
G	\$6,535
H	\$7,119
I	\$8,034
J	\$9,129

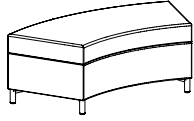
Description

Model

Specifications

List Price Per Grade

72" Radius Wedge Bench



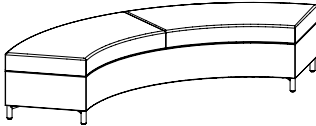
ZV6647

- upholstered seat
- fabric application is railroad. Non-patterned fabrics are recommended
- seat side power available, specify and add \$462 list; indicate right or left as seated and color Black (B) or White (W)

Dimensions	D	W	H
Overall	23 5/8	47 3/8	17 1/2
Upholstery		Shipping	
COM Ydg	2 3/4	Ctn Wt	57
		Cu Ft	14

COM	\$1,885
A	\$1,923
B	\$1,999
C	\$2,131
D	\$2,298
E	\$2,465
F	\$2,641
G	\$2,893
H	\$3,161
I	\$3,578
J	\$4,080

72" Radius Quarter Round Bench



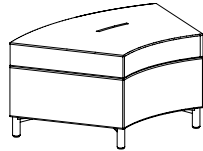
ZV6688

- upholstered seat
- fabric application is railroad. Non-patterned fabrics are recommended
- seat side power available, specify and add \$462 list; indicate right or left as seated and color Black (B) or White (W)

Dimensions	D	W	H
Overall	32 5/8	87 5/8	17 1/2
Upholstery		Shipping	
COM Ydg	5 1/2	Ctn Wt	105
		Cu Ft	34

COM	\$3,325
A	\$3,400
B	\$3,549
C	\$3,810
D	\$4,143
E	\$4,477
F	\$4,832
G	\$5,333
H	\$5,870
I	\$6,706
J	\$7,710

54" Radius Wedge Bench



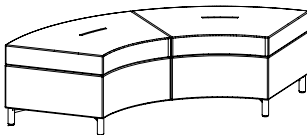
ZV6547

- upholstered seat
- armless
- fabric application is railroad. Non-patterned fabrics are recommended

Dimensions	D	W	H
Overall	29 5/8	34 3/8	17 1/2
Upholstery		Shipping	
COM Ydg	2	Ctn Wt	34
		Cu Ft	13

COM	\$1,670
A	\$1,697
B	\$1,755
COL/C	\$1,851
D	\$1,978
E	\$2,103
F	\$2,298
G	\$2,507
H	\$2,729
I	\$3,075
J	\$3,494

54" Radius Quarter Round Bench



ZV6588

- upholstered seat
- armless
- fabric application is railroad. Non-patterned fabrics are recommended

Dimensions	D	W	H
Overall	32 5/8	63 5/8	17 1/2
Upholstery		Shipping	
COM Ydg	3	Ctn Wt	63
		Cu Ft	26

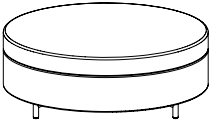
COM	\$2,657
A	\$2,699
B	\$2,782
COL/C	\$2,930
D	\$3,115
E	\$3,303
F	\$3,597
G	\$3,911
H	\$4,243
I	\$4,765
J	\$5,392

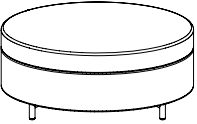
To Order, Specify:

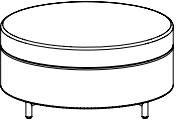
- 1 Model Number
- 2 Fabric Selection - vendor, pattern and color
Visit www.jsifurniture.com/finishes-and-materials/textiles for our textiles program. See selection of standard and graded in manufacturers and patterns.

Specifications

- Fabric is railroaded.
- Non-patterned textile is recommended.
- Frame interior is upholstery grade plywood with glued solid hardwood cross members reinforced with wood screws.
- Seat has synthetic sheet webbing with cross strap and 3 5/8" thick high resiliency seat polyurethane multi-density foam.
- Back has 1 3/4" thick polyurethane foam, back lumbar has 10 channel stitch detail thru 3/8" thick polyurethane foam.
- 3/4" of high grade polyurethane foam covers a plywood constructed arm frame.
- Linking bracket included.

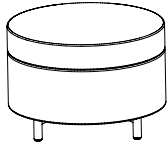
Description	① Model	Specifications	List Price Per Grade																																			
48" dia. Ottoman 	ZV6648 · upholstered seat · fabric application is railroad. Non-patterned fabrics are recommended	<table border="1"> <thead> <tr> <th>Dimensions</th> <th>D</th> <th>W</th> <th>H</th> </tr> </thead> <tbody> <tr> <td>Overall</td> <td>48</td> <td>48</td> <td>17½</td> </tr> </tbody> </table>	Dimensions	D	W	H	Overall	48	48	17½	<table border="1"> <thead> <tr> <th>Upholstery</th> <th>Shipping</th> </tr> </thead> <tbody> <tr> <td>COM Ydg</td> <td>Ctn Wt</td> </tr> <tr> <td></td> <td>Cu Ft</td> </tr> </tbody> </table>	Upholstery	Shipping	COM Ydg	Ctn Wt		Cu Ft																					
		Dimensions	D	W	H																																	
Overall	48	48	17½																																			
Upholstery	Shipping																																					
COM Ydg	Ctn Wt																																					
	Cu Ft																																					
<table border="1"> <thead> <tr> <th>COM</th> <th>Grade</th> <th>Price</th> </tr> </thead> <tbody> <tr><td>COM</td><td></td><td>\$2,553</td></tr> <tr><td>A</td><td></td><td>\$2,610</td></tr> <tr><td>B</td><td></td><td>\$2,717</td></tr> <tr><td>C</td><td></td><td>\$2,907</td></tr> <tr><td>D</td><td></td><td>\$3,149</td></tr> <tr><td>E</td><td></td><td>\$3,393</td></tr> <tr><td>F</td><td></td><td>\$3,651</td></tr> <tr><td>G</td><td></td><td>\$4,015</td></tr> <tr><td>H</td><td></td><td>\$4,403</td></tr> <tr><td>I</td><td></td><td>\$5,012</td></tr> <tr><td>J</td><td></td><td>\$5,744</td></tr> </tbody> </table>			COM	Grade	Price	COM		\$2,553	A		\$2,610	B		\$2,717	C		\$2,907	D		\$3,149	E		\$3,393	F		\$3,651	G		\$4,015	H		\$4,403	I		\$5,012	J		\$5,744
COM	Grade	Price																																				
COM		\$2,553																																				
A		\$2,610																																				
B		\$2,717																																				
C		\$2,907																																				
D		\$3,149																																				
E		\$3,393																																				
F		\$3,651																																				
G		\$4,015																																				
H		\$4,403																																				
I		\$5,012																																				
J		\$5,744																																				

42" dia. Ottoman 	ZV6642 · upholstered seat · fabric application is railroad. Non-patterned fabrics are recommended	<table border="1"> <thead> <tr> <th>Dimensions</th> <th>D</th> <th>W</th> <th>H</th> </tr> </thead> <tbody> <tr> <td>Overall</td> <td>42</td> <td>42</td> <td>17½</td> </tr> </tbody> </table>	Dimensions	D	W	H	Overall	42	42	17½	<table border="1"> <thead> <tr> <th>Upholstery</th> <th>Shipping</th> </tr> </thead> <tbody> <tr> <td>COM Ydg</td> <td>Ctn Wt</td> </tr> <tr> <td></td> <td>Cu Ft</td> </tr> </tbody> </table>	Upholstery	Shipping	COM Ydg	Ctn Wt		Cu Ft																					
		Dimensions	D	W	H																																	
Overall	42	42	17½																																			
Upholstery	Shipping																																					
COM Ydg	Ctn Wt																																					
	Cu Ft																																					
<table border="1"> <thead> <tr> <th>COM</th> <th>Grade</th> <th>Price</th> </tr> </thead> <tbody> <tr><td>COM</td><td></td><td>\$2,152</td></tr> <tr><td>A</td><td></td><td>\$2,207</td></tr> <tr><td>B</td><td></td><td>\$2,316</td></tr> <tr><td>C</td><td></td><td>\$2,506</td></tr> <tr><td>D</td><td></td><td>\$2,747</td></tr> <tr><td>E</td><td></td><td>\$2,991</td></tr> <tr><td>F</td><td></td><td>\$3,248</td></tr> <tr><td>G</td><td></td><td>\$3,614</td></tr> <tr><td>H</td><td></td><td>\$4,002</td></tr> <tr><td>I</td><td></td><td>\$4,610</td></tr> <tr><td>J</td><td></td><td>\$5,342</td></tr> </tbody> </table>			COM	Grade	Price	COM		\$2,152	A		\$2,207	B		\$2,316	C		\$2,506	D		\$2,747	E		\$2,991	F		\$3,248	G		\$3,614	H		\$4,002	I		\$4,610	J		\$5,342
COM	Grade	Price																																				
COM		\$2,152																																				
A		\$2,207																																				
B		\$2,316																																				
C		\$2,506																																				
D		\$2,747																																				
E		\$2,991																																				
F		\$3,248																																				
G		\$3,614																																				
H		\$4,002																																				
I		\$4,610																																				
J		\$5,342																																				

36" dia. Ottoman 	ZV6636 · upholstered seat · fabric application is railroad. Non-patterned fabrics are recommended	<table border="1"> <thead> <tr> <th>Dimensions</th> <th>D</th> <th>W</th> <th>H</th> </tr> </thead> <tbody> <tr> <td>Overall</td> <td>36</td> <td>36</td> <td>17½</td> </tr> </tbody> </table>	Dimensions	D	W	H	Overall	36	36	17½	<table border="1"> <thead> <tr> <th>Upholstery</th> <th>Shipping</th> </tr> </thead> <tbody> <tr> <td>COM Ydg</td> <td>Ctn Wt</td> </tr> <tr> <td></td> <td>Cu Ft</td> </tr> </tbody> </table>	Upholstery	Shipping	COM Ydg	Ctn Wt		Cu Ft																					
		Dimensions	D	W	H																																	
Overall	36	36	17½																																			
Upholstery	Shipping																																					
COM Ydg	Ctn Wt																																					
	Cu Ft																																					
<table border="1"> <thead> <tr> <th>COM</th> <th>Grade</th> <th>Price</th> </tr> </thead> <tbody> <tr><td>COM</td><td></td><td>\$1,734</td></tr> <tr><td>A</td><td></td><td>\$1,784</td></tr> <tr><td>B</td><td></td><td>\$1,879</td></tr> <tr><td>C</td><td></td><td>\$2,042</td></tr> <tr><td>D</td><td></td><td>\$2,255</td></tr> <tr><td>E</td><td></td><td>\$2,469</td></tr> <tr><td>F</td><td></td><td>\$2,696</td></tr> <tr><td>G</td><td></td><td>\$3,014</td></tr> <tr><td>H</td><td></td><td>\$3,355</td></tr> <tr><td>I</td><td></td><td>\$3,886</td></tr> <tr><td>J</td><td></td><td>\$4,525</td></tr> </tbody> </table>			COM	Grade	Price	COM		\$1,734	A		\$1,784	B		\$1,879	C		\$2,042	D		\$2,255	E		\$2,469	F		\$2,696	G		\$3,014	H		\$3,355	I		\$3,886	J		\$4,525
COM	Grade	Price																																				
COM		\$1,734																																				
A		\$1,784																																				
B		\$1,879																																				
C		\$2,042																																				
D		\$2,255																																				
E		\$2,469																																				
F		\$2,696																																				
G		\$3,014																																				
H		\$3,355																																				
I		\$3,886																																				
J		\$4,525																																				

Description

24" dia. Ottoman



Model

ZV6624

- upholstered seat
 - fabric application is railroad.
- Non-patterned fabrics are recommended

Specifications

Dimensions		D	W	H
Overall		24	24	17½
Upholstery		Shipping		
COM Ydg	1½	Ctn Wt	48	
		Cu Ft	8	

List Price Per Grade

COM	\$1,343
A	\$1,364
B	\$1,406
COL/C	\$1,479
D	\$1,573
E	\$1,666
F	\$1,812
G	\$1,968
H	\$2,138
I	\$2,397
J	\$2,710

To Order, Specify:

- 1 Model Number
 - 2 Fabric Selection - vendor, pattern and color
- Visit www.jsifurniture.com/finishes-and-materials/textiles for our textiles program. See selection of standard and graded in manufacturers and patterns.

Specifications

- Fabric is railroaded.
- Non-patterned textile is recommended.
- Frame interior is upholstery grade plywood with glued solid hardwood cross members reinforced with wood screws.
- Seat has synthetic sheet webbing with cross strap and 3 5/8" thick high resiliency seat polyurethane multi-density foam.
- Back has 1 3/4" thick polyurethane foam, back lumbar has 10 channel stitch detail thru 3/8" thick polyurethane foam.
- 3/4" of high grade polyurethane foam covers a plywood constructed arm frame.
- Linking bracket included.

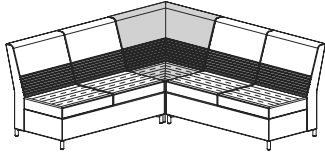
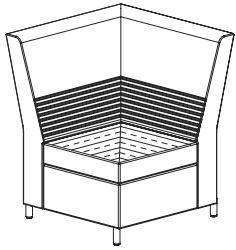
Ziva

MODULAR



Description

Square Corner Unit
Center - Fabric Diagonal



*CUD - in application

Model

ZV6600-CUD

- upholstered seat and back
- fabric runs diagonal
- power available in the left and right of the lower extreme back, dual charging USB add \$486 list or single simplex add \$338 list; specify USB or Simplex and color Black (B) or White (W)
- stand up surface with privacy screen available, add \$676; specify standard JSI laminate for top and the color of felt board for the privacy screen

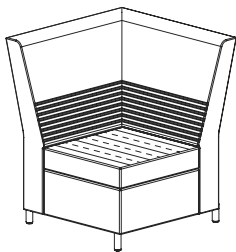
Specifications

Dimensions	D	W	H
Overall	30 3/8	30 3/8	36
Seat	20 1/2	20 1/2	17 1/2
Upholstery		Shipping	
COM Ydg	4	Ctn Wt	79
		Cu Ft	30

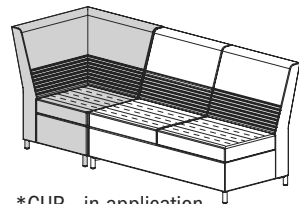
List Price Per Grade

COM	\$2,699
A	\$2,752
B	\$2,856
COL/C	\$3,039
D	\$3,274
E	\$3,509
F	\$3,877
G	\$4,269
H	\$4,686
I	\$5,341
J	\$6,125

Square Corner Unit
Right - Fabric Runs Right



right shown



*CUR - in application

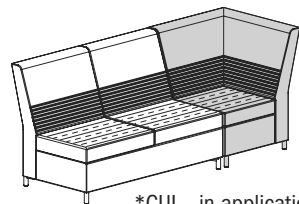
ZV6600-CUR

ZV6600-CUL

- upholstered seat and back
- fabric runs to the right
- seat side power available, specify and add \$462 list; indicate color Black (B) or White (W)
- power available in the left and right of the lower extreme back, dual charging USB add \$486 list or single simplex add \$338 list; specify USB or Simplex and color Black (B) or White (W)
- stand up surface with privacy screen available, add \$676; specify standard JSI laminate for top and the color of felt board for the privacy screen

Dimensions	D	W	H
Overall	30 3/8	30 3/8	36
Seat	20 1/2	20 1/2	17 1/2
Upholstery		Shipping	
COM Ydg	4	Ctn Wt	79
		Cu Ft	30

COM	\$2,699
A	\$2,752
B	\$2,856
COL/C	\$3,039
D	\$3,274
E	\$3,509
F	\$3,877
G	\$4,269
H	\$4,686
I	\$5,341
J	\$6,125

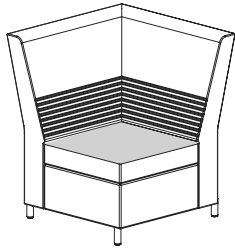


*CUL - in application

ZIVA

Description

Corner Table Unit with Upholstery
- Laminate Diagonal



Model

ZV6600-CTF

- upholstered back and worksurface
- fabric runs to the left
- surface is laminate
- power available in the left and right of the lower extreme back, dual charging USB add \$486 list or single simplex add \$338 list; specify USB or Simplex and color Black (B) or White (W)
- stand up surface with privacy screen available, add \$676; specify standard JSI laminate for top and the color of felt board for the privacy screen

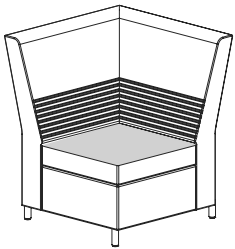
Specifications

Dimensions	D	W	H
Overall	30 3/8	30 3/8	36
Seat	20 1/2	20 1/2	17 1/2
Upholstery		Shipping	
COM Ydg	4	Ctn Wt	82
		Cu Ft	30

List Price Per Grade

COM	\$2,813
A	\$2,863
B	\$2,964
COL/C	\$3,139
D	\$3,367
E	\$3,591
F	\$3,945
G	\$4,322
H	\$4,723
I	\$5,351
J	\$6,105

Corner Table Unit with Upholstery -
Veneer Diagonal



ZV6600-CVV

- upholstered back and worksurface
- fabric runs diagonal
- surface is veneer - grain runs diagonal
- power available in the left and right of the lower extreme back, dual charging USB add \$486 list or single simplex add \$338 list; specify USB or Simplex and color Black (B) or White (W)
- stand up surface with privacy screen available, add \$676; specify standard JSI laminate for top and the color of felt board for the privacy screen

Dimensions	D	W	H
Overall	30 3/8	30 3/8	36
Seat	20 1/2	20 1/2	17 1/2
Upholstery		Shipping	
COM Ydg	4	Ctn Wt	82
		Cu Ft	30

COM	\$3,049
A	\$3,098
B	\$3,197
COL/C	\$3,375
D	\$3,601
E	\$3,828
F	\$4,179
G	\$4,557
H	\$4,959
I	\$5,588
J	\$6,344

To Order, Specify:

- Model Number
- Fabric Selection - vendor, pattern and color
Visit www.jsifurniture.com/finishes-and-materials/textiles for our textiles program. See selection of standard and graded in manufacturers and patterns.

Specifications

- Fabric is railroaded.
- Non-patterned textile is recommended.
- Frame interior is upholstery grade plywood with glued solid hardwood cross members reinforced with wood screws.
- Seat has synthetic sheet webbing with cross strap and 3 3/8" thick high resiliency seat polyurethane multi-density foam.
- Back has 1 3/4" thick polyurethane foam, back lumbar has 10 channel stitch detail thru 3/8" thick polyurethane foam.
- 3/4" of high grade polyurethane foam covers a plywood constructed arm frame.

Ziva

MODULAR



Description

① Model

Specifications

List Price Per Grade

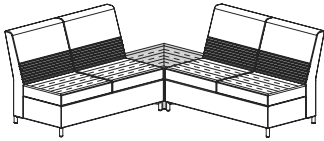
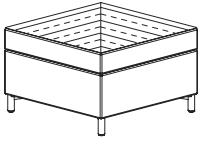
Square Corner Ottoman -
Fabric Diagonal

ZV6610-BD

- fabric runs to the left
- fabric runs diagonal
- seat side power available, specify and add \$462 list; indicate right or left as seated and color Black (B) or White (W)

Dimensions	D	W	H
Overall	26	26	17½
Seat	26	26	17½
Upholstery		Shipping	
COM Ydg	2½	Ctn Wt	43
		Cu Ft	10

- COM \$1,700
- A \$1,731
- B \$1,793
- COL/C \$1,905
- D \$2,045
- E \$2,188
- F \$2,407
- G \$2,643
- H \$2,896
- I \$3,291
- J \$3,763



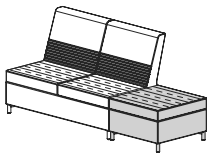
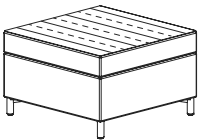
Square Corner Ottoman -
Fabric Railroad

ZV6610-BR

- fabric runs railroad
- seat side power available, specify and add \$462 list; indicate right or left as seated and color Black (B) or White (W)

Dimensions	D	W	H
Overall	26	26	17½
Seat	26	26	17½
Upholstery		Shipping	
COM Ydg	2½	Ctn Wt	43
		Cu Ft	10

- COM \$1,700
- A \$1,731
- B \$1,793
- COL/C \$1,905
- D \$2,045
- E \$2,188
- F \$2,407
- G \$2,643
- H \$2,896
- I \$3,291
- J \$3,763



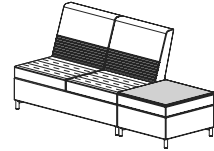
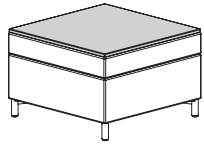
Description

1 Model

Specifications

List Price Per Grade

Table Ottoman with Upholstery - Veneer Surface



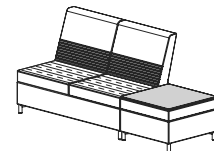
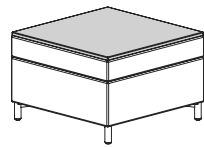
ZV6610-TVV

- veneer top
- fabric chassis
- surface is veneer
- seat side power available, specify and add \$462 list; indicate right or left as seated and color Black (B) or White (W)

Dimensions	D	W	H
Overall	26	26	17½
Seat	26	26	17½
Upholstery		Shipping	
COM Ydg	2½	Ctn Wt	46
		Cu Ft	10

COM	\$2,101
A	\$2,132
B	\$2,196
COL/C	\$2,306
D	\$2,447
E	\$2,589
F	\$2,811
G	\$3,048
H	\$3,299
I	\$3,693
J	\$4,164

Table Ottoman with Upholstery - Laminate Surface



ZV6610-TTF

- laminate top
- fabric chassis
- surface is laminate
- seat side power available, specify and add \$462 list; indicate right or left as seated and color Black (B) or White (W)

Dimensions	D	W	H
Overall	26	26	17½
Seat	26	26	17½
Upholstery		Shipping	
COM Ydg	2½	Ctn Wt	46
		Cu Ft	10

COM	\$1,863
A	\$1,895
B	\$1,958
COL/C	\$2,069
D	\$2,210
E	\$2,352
F	\$2,574
G	\$2,810
H	\$3,061
I	\$3,455
J	\$3,927

To Order, Specify:

- 1 Model Number
- 2 Fabric Selection - vendor, pattern and color
Visit www.jsifurniture.com/finishes-and-materials/textiles for our textiles program. See selection of standard and graded in manufacturers and patterns.

Specifications

- Fabric is railroaded.
- Non-patterned textile is recommended.
- Frame interior is upholstery grade plywood with glued solid hardwood cross members reinforced with wood screws.
- Seat has synthetic sheet webbing with cross strap and 3¾" thick high resiliency seat polyurethane multi-density foam.
- Back has 1¾" thick polyurethane foam, back lumbar has 10 channel stitch detail thru ¾" thick polyurethane foam.
- ¾" of high grade polyurethane foam covers a plywood constructed arm frame.

Ziva MODULAR



Description

① Model

Specifications

List Price Per Grade

Table Ottoman with Upholstery -
Veneer Surface Diagonal Grain

ZV6610-DVW

- veneer top - grain runs diagonal
- fabric chassis
- surface is veneer - grain runs diagonal
- seat side power available, specify and add \$462 list; indicate right or left as seated and color Black (B) or White (W)

Dimensions	D	W	H
Overall	26	26	17½
Seat	26	26	17½
Upholstery		Shipping	
COM Ydg	2½	Ctn Wt	46
		Cu Ft	10

COM	\$2,101
A	\$2,132
B	\$2,196
COL/C	\$2,306
D	\$2,447
E	\$2,589
F	\$2,811
G	\$3,048
H	\$3,299
I	\$3,693
J	\$4,164

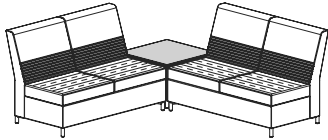
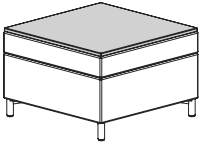


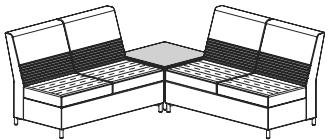
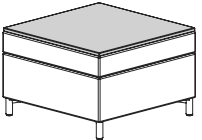
Table Ottoman with Upholstery -
Laminate Surface Diagonal Grain

ZV6610-DTF

- laminate top- grain runs diagonal
- fabric chassis
- surface is laminate - grain runs diagonal
- seat side power available, specify and add \$462 list; indicate right or left as seated and color Black (B) or White (W)

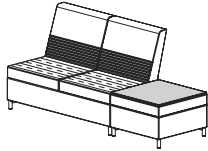
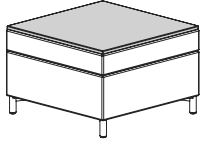
Dimensions	D	W	H
Overall	26	26	17½
Seat	26	26	17½
Upholstery		Shipping	
COM Ydg	2½	Ctn Wt	46
		Cu Ft	10

COM	\$1,863
A	\$1,895
B	\$1,958
COL/C	\$2,069
D	\$2,210
E	\$2,352
F	\$2,574
G	\$2,810
H	\$3,061
I	\$3,455
J	\$3,927



Description

Table Ottoman with Upholstery -
Solid Surface



① Model

ZV6610-TSS

- solid surface top
- fabric chassis
- surface is solid surface
- seat side power available, specify and add \$462 list; indicate right or left as seated and color Black (B) or White (W)

Specifications

Dimensions	D	W	H
Overall	26	26	17½
Seat	26	26	17½
Upholstery		Shipping	
COM Ydg	2½	Ctn Wt	46
		Cu Ft	10

List Price Per Grade

COM	\$2,497
A	\$2,531
B	\$2,593
COL/C	\$2,703
D	\$2,845
E	\$2,986
F	\$3,207
G	\$3,443
H	\$3,454
I	\$4,089
J	\$4,562

To Order, Specify:

- ① Model Number
- ② Fabric Selection - vendor, pattern and color
Visit www.jsifurniture.com/finishes-and-materials/textiles for our textiles program. See selection of standard and graded in manufacturers and patterns.

Specifications

- Fabric is railroaded.
- Non-patterned textile is recommended.
- Frame interior is upholstery grade plywood with glued solid hardwood cross members reinforced with wood screws.
- Seat has synthetic sheet webbing with cross strap and 3¾" thick high resiliency seat polyurethane multi-density foam.
- Back has 1¾" thick polyurethane foam, back lumbar has 10 channel stitch detail thru ¾" thick polyurethane foam.
- ¾" of high grade polyurethane foam covers a plywood constructed arm frame.

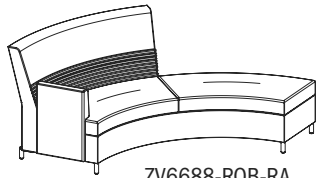
Ziva

MODULAR

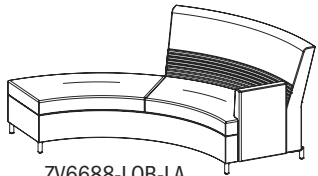


Description

72" Radius Quarter Round with Partial Outside Back and Right Arm



ZV6688-ROB-RA



ZV6688-LOB-LA

1 Model

ZV6688-ROB-RA

ZV6688-LOB-LA

- upholstered seat and back
- fabric application is railroad. Non-patterned fabrics are recommended
- seat side power available, specify and add \$462 list; indicate right or left as seated and color Black (B) or White (W)
- power available in the center of the lower extreme back, dual charging USB add \$243 list or single simplex add \$169 list; specify USB or Simplex and color Black (B) or White (W)
- stand up surface with privacy screen available, add \$723; specify standard JSI laminate for top and the color of felt board for the privacy screen
- tablet available, specify and add \$648 list for standard solid surface or \$547 list for laminate or veneer

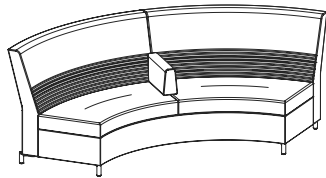
Specifications

Dimensions	D	W	H
Overall	42 ½	95 ⅞	36
Seat	20 ½	26	17 ½
Arm			
Upholstery		Shipping	
COM Ydg	7 ¾	Ctn Wt	231
		Cu Ft	92

List Price Per Grade

COM	\$4,592
A	\$4,703
B	\$4,914
COL/C	\$5,285
D	\$5,762
E	\$6,242
F	\$6,772
G	\$7,494
H	\$8,266
I	\$9,476
J	\$10,923

72" Radius Quarter Round with Outside Back and Center Arm



ZV6688-FOB-CA

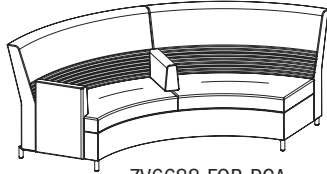
- upholstered seat and back
- fabric application is railroad. Non-patterned fabrics are recommended
- seat side power available, specify and add \$462 list; indicate right or left as seated and color Black (B) or White (W)
- power available in the left and right of the lower extreme back, dual charging USB add \$486 list or single simplex add \$338 list; specify USB or Simplex and color Black (B) or White (W)
- stand up surface with privacy screen available, add \$1,356; specify standard JSI laminate for top and the color of felt board for the privacy screen

Dimensions	D	W	H
Overall	42 ½	101 ½	36
Seat	20 ½	26	17 ½
Upholstery		Shipping	
COM Ydg	11 ¾	Ctn Wt	190
		Cu Ft	100

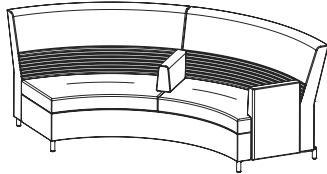
COM	\$5,725
A	\$5,888
B	\$6,208
COL/C	\$6,769
D	\$7,488
E	\$8,211
F	\$8,996
G	\$10,084
H	\$11,246
I	\$13,061
J	\$15,240

Description

72" Radius Quarter Round with Outside Back and Right and Center Arm



ZV6688-FOB-RCA



ZV6688-FOB-LCA

1 Model

ZV6688-FOB-RCA
ZV6688-FOB-LCA

- upholstered seat and back
- fabric application is railroad. Non-patterned fabrics are recommended
- seat side power available, specify and add \$462 list; indicate right or left as seated and color Black (B) or White (W)
- power available in the left and right of the lower extreme back, dual charging USB add \$486 list or single simplex add \$338 list; specify USB or Simplex and color Black (B) or White (W)
- stand up surface with privacy screen available, add \$1,356; specify standard JSI laminate for top and the color of felt board for the privacy screen

Specifications

Dimensions	D	W	H
Overall	42 ½	101 ½	36
Seat	20 ½	26	17 ½
Arm			
Upholstery	Shipping		
COM Ydg	12 ½	Ctn Wt	200
		Cu Ft	100

List Price Per Grade

COM	\$6,129
A	\$6,303
B	\$6,642
COL/C	\$7,241
D	\$8,006
E	\$8,773
F	\$9,610
G	\$10,766
H	\$12,001
I	\$13,928
J	\$16,247

To Order, Specify:

- 1 Model Number
- 2 Fabric Selection - vendor, pattern and color
Visit www.jsifurniture.com/finishes-and-materials/textiles for our textiles program. See selection of standard and graded in manufacturers and patterns.

Specifications

- Fabric is railroaded.
- Non-patterned textile is recommended.
- Frame interior is upholstery grade plywood with glued solid hardwood cross members reinforced with wood screws.
- Seat has synthetic sheet webbing with cross strap and 3 ¾" thick high resiliency seat polyurethane multi-density foam.
- Back has 1 ¾" thick polyurethane foam, back lumbar has 10 channel stitch detail thru ¾" thick polyurethane foam.
- ¾" of high grade polyurethane foam covers a plywood constructed arm frame.

Ziva

MODULAR



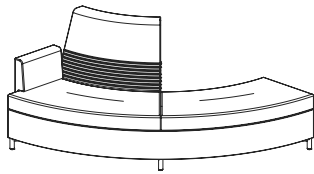
Description

① Model

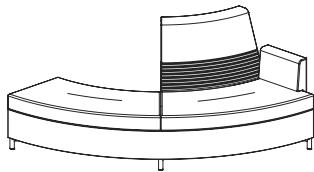
Specifications

List Price Per Grade

32" Radius Quarter Round with Partial Inside Back and Right Arm



ZV6688-RIB-RA



ZV6688-LIB-LA

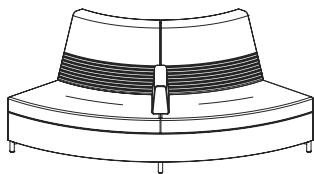
ZV6688-RIB-RA
ZV6688-LIB-LA

- upholstered seat and back
- fabric application is railroad. Non-patterned fabrics are recommended
- seat side power available, specify and add \$462 list; indicate right or left as seated and color Black (B) or White (W)
- tablet available, specify and add \$648 list for standard solid surface or \$547 list for laminate or veneer

Dimensions	D	W	H
Overall	39 ½	88 ¾	36
Seat	20 ½	26	17 ½
Arm			
Upholstery		Shipping	
COM Ydg	6 ¼	Ctn Wt	189
		Cu Ft	81

COM	\$4,547
A	\$4,636
B	\$4,806
COL/C	\$5,109
D	\$5,492
E	\$5,879
F	\$6,312
G	\$6,899
H	\$7,526
I	\$8,505
J	\$9,681

32" Radius Quarter Round with Inside Back and Center Arm



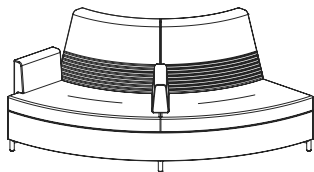
ZV6688-FIB-CA

- upholstered seat and back
- fabric application is railroad. Non-patterned fabrics are recommended
- seat side power available, specify and add \$462 list; indicate right or left as seated and color Black (B) or White (W)

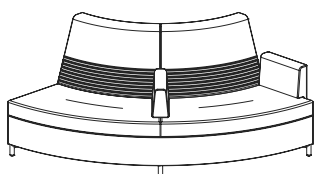
Dimensions	D	W	H
Overall	39 ½	87 ¾	36
Seat	20 ½	26	17 ½
Arm			
Upholstery		Shipping	
COM Ydg	8 ¾	Ctn Wt	231
		Cu Ft	81

COM	\$5,630
A	\$5,751
B	\$5,989
COL/C	\$6,411
D	\$6,949
E	\$7,487
F	\$8,080
G	\$8,897
H	\$9,765
I	\$11,126
J	\$12,759

32" Radius Quarter Round with Inside Back and Right and Center Arm



ZV6688-FIB-RCA



ZV6688-FIB-LCA

ZV6688-FIB-RCA
ZV6688-FIB-LCA

- upholstered seat and back
- fabric application is railroad. Non-patterned fabrics are recommended
- seat side power available, specify and add \$462 list; indicate right or left as seated and color Black (B) or White (W)
- tablet available, specify and add \$648 list for standard solid surface or \$547 list for laminate or veneer

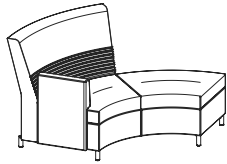
Dimensions	D	W	H
Overall	39 ½	87 ¾	36
Seat	20 ½	26	17 ½
Arm			
Upholstery		Shipping	
COM Ydg	9 ½	Ctn Wt	242
		Cu Ft	81

COM	\$6,037
A	\$6,169
B	\$6,427
COL/C	\$6,882
D	\$7,467
E	\$8,051
F	\$8,695
G	\$9,575
H	\$10,519
I	\$11,992
J	\$13,762

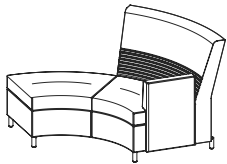
ZIVA

Description

54" Radius Quarter Round with Partial Outside Back and Right Arm



ZV6588-ROB-RA



ZV6588-LOB-LA

Model

ZV6588-ROB-RA
ZV6588-LOB-LA

- upholstered seat and back
- fabric application is railroad. Non-patterned fabrics are recommended
- seat side power available, specify and add \$462 list; indicate right or left as seated and color Black (B) or White (W)
- power available in the center of the lower extreme back, dual charging USB add \$243 list or single simplex add \$169 list; specify USB or Simplex and color Black (B) or White (W)
- tablet available, specify and add \$648 list for standard solid surface or \$547 list for laminate or veneer
- stand up surface with privacy screen available, add \$550; specify standard JSI laminate for top and the color of felt board for the privacy screen

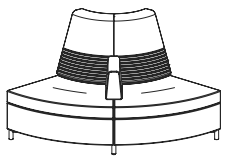
Specifications

Dimensions	D	W	H
Overall	42 ½	96 ⅞	36
Seat	20 ½	33 ½	17 ½
Arm			
Upholstery	Shipping		
COM Ydg	5 ½	Ctn Wt	139
		Cu Ft	95

List Price Per Grade

COM	\$3,835
A	\$3,911
B	\$4,062
COL/C	\$4,327
D	\$4,666
E	\$5,006
F	\$5,535
G	\$6,098
H	\$6,701
I	\$7,644
J	\$8,777

14" Radius Quarter Round with Inside Back and Center Arm



ZV6588-FIB-CA

- upholstered seat and back
- fabric application is railroad. Non-patterned fabrics are recommended
- seat side power available, specify and add \$462 list; indicate right or left as seated and color Black (B) or White (W)
- tablet available, specify and add \$648 list for standard solid surface or \$547 list for laminate or veneer

Dimensions	D	W	H
Overall	39 ½	66 ½	36
Seat	20 ½	35 ½	17 ½
Upholstery	Shipping		
COM Ydg	5 ¾	Ctn Wt	102
		Cu Ft	63

COM	\$4,098
A	\$4,181
B	\$4,340
COL/C	\$4,628
D	\$4,991
E	\$5,356
F	\$5,925
G	\$6,530
H	\$7,178
I	\$8,188
J	\$9,407

To Order, Specify:

- 1 Model Number
- 2 Fabric Selection - vendor, pattern and color
Visit www.jsifurniture.com/finishes-and-materials/textiles for our textiles program. See selection of standard and graded in manufacturers and patterns.

Specifications

- Fabric is railroaded.
- Non-patterned textile is recommended.
- Frame interior is upholstery grade plywood with glued solid hardwood cross members reinforced with wood screws.
- Seat has synthetic sheet webbing with cross strap and 3 ⅜" thick high resiliency seat polyurethane multi-density foam.
- Back has 1 ¾" thick polyurethane foam, back lumbar has 10 channel stitch detail thru ⅜" thick polyurethane foam.
- ¾" of high grade polyurethane foam covers a plywood constructed arm frame.

Ziva Tables Order Check List:



Specify:

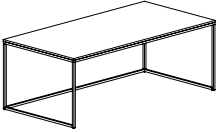
- 1. Model Number
- 2. Top Material
 - a.) Veneer
 - 1.) Wood Species - Cherry (CH1), Maple (MA1), Walnut (WA1), Black Oak (B01) or Double Cut (DC1)
 - 2.) Wood Finish
 - b.) Laminate
 - 1.) Laminate Color
 - c.) Solid Surface
 - 1.) Solid Surface Color

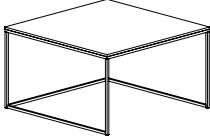
Example:

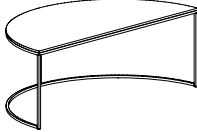
ZVV2448-18MT (model #)	VENEER (top material)	CH1 (wood species)	CLL (finish)
----------------------------------	---------------------------------	------------------------------	------------------------

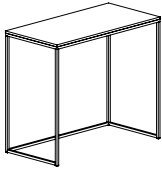
1. Model Number	2b.) Laminate
2. Top Material Selection:	HPL Wood Grain Pattern Laminates
a.) Veneer	ALL Ale Light MIN Mineral
CH1 Cherry <i>Flat Cut Veneer</i>	BOL Bourbon Light OAT Oatmeal Cookie
BBM Bourbon Medium CLL Collectors	BZW Brazilwood PIN Pinnacle Walnut
BRM Brighton Medium HRV Harvest	BGL Brighton Light STU Studio Teak
CLA Classic PRL Praline	CLL Collectors UMB Umber
	FAW Fawn VAL Valley
MA1 Maple <i>Flat Cut Veneer</i>	FLO Florence Walnut VIN Vintage
ALM Ale Medium FLX Flax	GRH Graphite WEA Weathered Ash
BUT Butterscotch VEN Venetian	
WA1 Walnut <i>Flat Cut Veneer</i>	HPL Solid Laminates
ESP Espresso TRF Truffle	ALB Alabaster DWH Designer White
MCH Mocha UMB Umber	BLK Black SHD Shadow
SIE Sienna	BBL Bridal Blanco SLG Slate Grey
B01 Black Oak <i>Flat Cut Veneer</i>	
RAV Raven	3c.) Solid Surface
DC1 Double Cut Veneer	Solid Surfaces
BAR Barrel - Oak Pattern KHK Khaki	ARM Armadillo PEB Pebble Pearl
BUF Buff - Oak Pattern MIN Mineral - Oak Pattern	BLP Black Pearl PUR Pure White
CND Cinder - Oak Pattern RYE Rye - Oak Pattern	
COF Coffee SAB Sable - Oak Pattern	
EGR Egret - Oak Pattern SAD Saddle - Oak Pattern	
FAW Fawn STU Studio Teak	
GRH Graphite VAL Valley	

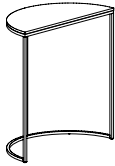
ZIVA

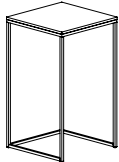
Description	D	W	H	CTN WT	CU FT	① Model	Laminate	Flat Cut Veneer	Double Cut Veneer	Solid Surface
Coffee Table 	24	48	18	51	15	ZVT2448-18MT	\$2,348			
	24	48	18	51	15	ZVW2448-18MT		\$2,348	\$2,463	
	24	48	18	51	15	ZVS2448-18MT				\$2,537
· Arctic Silver powder-coated frame										

Square Coffee Table 	30	30	18	42	12	ZVT3030-18MT	\$2,210			
	30	30	18	42	12	ZVW3030-18MT		\$2,210	\$2,317	
	30	30	18	42	12	ZVS3030-18MT				\$2,391
· Arctic Silver powder-coated frame										

Half Round Coffee Table 	24	48	18	45	15	ZVT2448-18HRT	\$2,187			
	24	48	18	45	15	ZVW2448-18HRT		\$2,187	\$2,292	
	24	48	18	45	15	ZVS2448-18HRT				\$2,365
· Arctic Silver powder-coated frame										

Work Height Table 	15	30	26	21	8	ZVT1530-26WT	\$1,913			
	15	30	26	21	8	ZVW1530-26WT		\$1,913	\$2,006	
	15	30	26	21	8	ZVS1530-26WT				\$2,066
· Arctic Silver powder-coated frame										

Half Round Work Height Table 	12	24	26	17	6	ZVT2448-26HRT	\$1,357			
	12	24	26	17	6	ZVW2448-26HRT		\$1,357	\$1,423	
	12	24	26	17	6	ZVS2448-26HRT				\$1,468
· Arctic Silver powder-coated frame										

Square Work Height Table 	15	15	26	14	5	ZVT1515-26PT	\$1,448			
	15	15	26	14	5	ZVW1515-26PT		\$1,448	\$1,518	
	15	15	26	14	5	ZVS1515-26PT				\$1,566
· Arctic Silver powder-coated frame										

To Order, Specify:

- ① Model Number
- ② Top Material:
 - a.) Veneer
 - 1.) Wood Species - Cherry (CH1), Maple (MA1), Walnut (WA1), Black Oak (BO1) or Double Cut (DC1)
 - a.) Finish Color [See Finish Color Options](#)
 - b.) Laminate
 - 1.) Laminate Color [See Laminate Color Options](#)
 - c.) Solid Surface [See Solid Surface Color Options](#)

ZIVA

pricelist

effective April 3, 2023

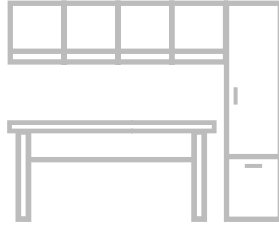
VISION



JSI Price Lists

Tables + Casegoods

[Apogee](#)
[Bourne Tables](#)
[Brogan](#)
[Collective Conference](#)
[Finale](#)
[Lincoln](#)
[Native](#)
[Nosh](#)
[Privacy Program](#)
[Prost](#)
[Reef](#)
[Romy](#)
[Strata](#)
[Traditional](#)
[Trail](#)
[Walden](#)
[Wellington](#)
[Accessories](#)



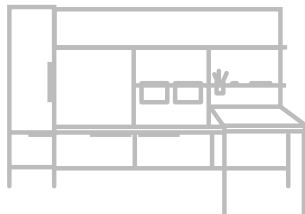
Lok

[Training Tables](#)
[Teamwork Tables](#)
[Conference Tables](#)
[Occasional Tables](#)



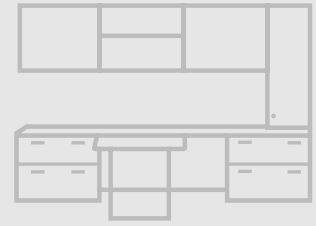
Flux

[Private Office](#)



Vision

[Casegoods](#)
[Tables](#)



Seating

Addison	Madison
Americana	Melrose
Ansen	Millie
Arwyn	Moto
Avalon	Murphy
Avini	Newton
BeSpace	Oxley
Boston	Pillow
Bourne Seating	Poet
Bryn	Protocol
Caav	Proxy
Cabaret	Ramona
Class Act	Ria
Collective Motion	Sosa
Connect	Tara
Encore	Teekan
Esque	Totem
Finn	Trinity
Finn Nu	Tyler
Garvey R5	Wink
Gatsby	Ziva
Harbor	
Hoopz	
Indie	
Jude	
Knox	
Kyla	
Laurel	
Mackey	



Environmental Mission

Our vision and goal is a sustaining supplier, manufacturer and customer for the long term protection and preservation of our environment for future generations.

MISSION

To achieve this vision, we are dedicated to ensuring the health and wellbeing of all of our partners, reducing negative impact on the environment, and maintaining price structure by increasing efficiencies and reducing consumption.

JSI, and it's parent company, is an internal manufacturer and has been an environmentally conscious organization for more than 80 years.

We are proud to use wood as our primary sustainable material resource and all corporate policies and procedures support the efforts to "recover, recycle, reuse, repurpose, reduce, refuse, and re-engineer". In doing this, we are committed to the conservation of the environment and its natural resources as well as encouraging our suppliers and customers to do the same. A goal of a "Sustainable Partnership", supplier, manufacturer and customer, is essential for the long term protection preservation and sustainability of our environment for future generations.

LOCATION

Our manufacturing facilities are located in the center of Southern Indiana. With our diverse product offering and manufacturing capabilities, we provide a single source for all of your project needs allowing you to conserve our fossil fuels and reduce greenhouse gases.

PACKAGING

We place emphasis on the minimal use of disposable packaging while still providing adequate protection to the finished product. Our corrugated packaging is recyclable, reusable, and up to 100% recycled content. We reuse or recycle more than 175 tons of corrugated material annually.

REGULATORY

All of our manufacturing facilities are in compliance with applicable OSHA regulations and meet or exceed all applicable DEM and EPA regulations for air emissions, storm water and hazardous waste disposal.

MANUFACTURING FACILITIES

Our manufacturing facilities are geared toward eco-efficiency and are encouraged to continually improve and conserve. Solid wood not used in the direct manufacturing process is recovered for the operation of our dry kilns, thus reducing greenhouse gases, the use of fossil fuels, and the burden of waste placed on landfills. Composite panels not used in the direct manufacturing process are ground and sold for use as animal bedding and boiler fuel. In addition to other energy savings techniques, our manufacturing facilities use high efficient lighting, make use of power factor capacitors, and encourage all to conserve and reduce energy consumption and water usage. Condensation pumps are used to aid in water conservation as well as extending boiler life.

MANUFACTURING PROCESSES

Our finish processes utilize efficient spray guns and proper spray techniques to reduce wasted material. Excess finish material, solvents, and waste are recycled. Many of the assembly processes use water based glues that contain no hazardous ingredients.

TEXTILES

Many of our fabric options utilize up to 100% recycled content. Our leather alternative program includes selections that contain no toxic materials, plasticizers, heavy metals, or formaldehyde and have a 100% biodegradable back cloth. Some of the available panel fabric used, if discarded is a biological nutrient for the soil. Most of the components (foam, batting, and polycord) used in upholstered products are recyclable. Excess fabrics and leathers not utilized in the upholstery process go to recyclers and local charities for additional use.

WOOD

Wood is the most diverse, most process friendly, and most widely utilized natural resource in mankind's history. No other natural resource can match the environmental advantages of wood, including being renewable, recyclable, natural, carbon negative, and biodegradable. Utilizing the sun's energy, trees grow and remove carbon dioxide from the air while giving off oxygen to benefit the entire planet. Approximately 49% of wood's dry weight is carbon and harvesting mature trees in a sustainable forest, which has slowed in the absorption of carbon dioxide, allows the photosynthetic cycle to continue at full optimization and allow for the carbon to remain sequestered. We are proud to use wood as our primary "sustainable" renewable resource.

WOOD OPTIONS

Many environmentally friendly solid wood and engineered wood options are available for quote, including: Lyptus®, Plyboo®, reclaimed woods, agricultural and post-consumer waste fiber products, etc.

INDOOR AIR QUALITY

Our goal is to reduce the impact our products will have on the indoor air quality. We practice the latest technologies and utilize a third party to assure we meet this goal. GreenGuard, one of the leaders in IAQ certification, continues to certify our product offering with UL2818 - GreenGuard Indoor Air Quality certification.

PARTNERSHIPS

BIFMA
Business and Institutional Furniture Manufacturer Association

USGBC

United States Green Building Council

IIDA

International Interior Design Association

FSC

Forest Stewardship Council - Forestland

UL GreenGuard

*Indiana Department of Natural/Resources - Division of Forestry -
Classified Forest, Wildlands Program*

Lifetime Warranty

JSI warrants to the original purchaser that each piece of furniture will be free from defects in workmanship, given normal use and care for as long as the original customer owns and uses the product. Normal use is defined as the equivalent of a single shift, 40-hour work week.

JSI will, at its option, repair or replace with comparable product within the terms of the warranty.

Exceptions to Warranty:

12 Years (from date of purchase)

- Wood Seating
- Seating Controls
- Veneer Surfaces
- Laminate Surfaces
- Pneumatic Cylinders

5 Years (from date of purchase)

- Glides · Casters · Task Lights
- Mesh/Knit Material · Foam
- Florette Plastic Frame Chairs
- Electrical Components
- Electric Height Adjustable Bases

This Warranty Does Not Cover:

- Natural variations in color, grain or texture of wood and other covering materials over which JSI has no control.
- Normal wear, color fastness, shrinkage, puddling, wrinkling and stretching of upholsteries including fabric, vinyl, leather and other textiles. This warranty does not cover any defects that may arise in the use of COM or COL upholstery materials. Textile manufacturer's warranty will apply.
- Damages resulting from transportation, improper assembly, installation, handling, accident, user modification attachments, misuse, or neglect of product care.
- Damage resulting from extreme climate conditions.
- Finish damages resulting from normal wear and tear, improper maintenance, water damage, exposure to sunlight, extreme high or low humidity or temperature, or other acts of nature.
- Damage created by loading file drawers with anything other than hanging folders.

JSI makes no expressed or implied warranties to any product and, in particular, makes no warranty of merchantability or fitness for any particular purpose. JSI will not be liable for any consequential or incidental damages under this warranty.

Unique Characteristic of Natural Woods and Veneers

JSI uses high quality wood and veneer harvested from sustainably managed forests. Every tree has unique and defining characteristics, like fingerprints. These characteristics can be defined by differences in color, grain configuration, and textures. These characteristics will be more noticeable if the product has a clear or lighter finish.

Maple and Cherry species have a higher degree of uneven distribution of grain, small color streaks, and pin knots.

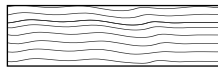
At JSI, we take care of selecting woods and veneers that are used in our products. With this in mind, we hope you appreciate the beauty of each tree's fingerprints. Products will not be replaced due to these natural characteristics.

Veneers can be sliced in a variety of ways to create unique patterns. JSI uses several different patterns, as shown below.

Flat (Plain) Cut as shown in diagram



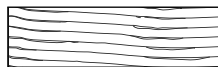
Quarter Sliced as shown in diagram



Double Cut as shown in diagram



Rift Cut as shown in diagram



Double Cut

The Double Cut veneer is a processed product that has at least two cuttings to create the final veneers. These cuts of veneer strands are dyed and layered into a block to create variation of patterns from a very tight grain pattern to an exotic figure grain pattern.

JSI uses select beech, cherry, maple, oak and walnut cut wood products to produce the desired look of our furniture products.

Laminates (Veneer Series)

An alternative HPL (Higher Pressure Laminate) laminate work surface can be specified on most of our casegood product lines. The specification pages will also list the available coordinating finishes.

Laminate Series

JSI laminate series offer a full laminated product with imprinted grain to hide finger prints and provide durability. The worksurface tops are HPL (High Pressure Laminate) or TFL (Thermal Fused Laminate). TFL is used on the product's chassis.

Please reference the featured highlights of each product line to identify the species, grain patterns, finishes for that product series

Finish - Top Coat

To reduce hazardous formaldehyde emissions, we use our proprietary specially designed top coat, DuraTex™. It significantly reduces hazardous formaldehyde emissions and helps improve indoor air quality.

Finish - Color/Stains

A wide range of stains are available to bring out the beautiful characteristics of each wood species. We coordinate finish color between our veneer stains and solid lumber stains; however, not all may be a perfect match. The stains are continually reviewed for accuracy of color, as well as a constant monitoring of the latest color trends in the furniture market.

Finish - Matching

Due to the natural characteristics of wood, environmental effects, and material upgrades, JSI cannot guarantee exact finish matches on existing furniture previously ordered.

If an exact match is required to accompany existing furniture, it must be specified at the time of order placement, so specific internal procedures can be followed to ensure a proper and acceptable finish match. We reserve the right to change our finish formula at any time to improve safety, quality, and appearance. Unless a finish match for existing furniture is requested at the time of ordering, we accept no liability for finish that may not match the existing furniture from prior orders.

Solid lumber may inherently have mineral streaks, pits, and various other natural occurrences. Care is taken in selecting the solid lumber to coordinate with the requested finish on our veneer products. This internal selection process is subject to availability of solid lumber parts.

Finish Sheen

All casegood veneer finishes are standard in 35-sheen, with the exception of Raven, which is only offered in 15 sheen. All other finishes are available in 15 sheen, with a 5% upcharge, per model

Custom/Special Finishes

JSI, upon request, will accommodate special finishes. A written request is required to proceed with custom finish orders. A sample reference is required for first time matches and must be included with the written request.

There is a one time charge of **\$372 list per order** for any non-standard wood finish.

Orders will be entered noting the special finish. A sample match will be provided to the customer. Written approval is needed before the finish process can be started. Delays in approval may have an impact on lead times.

Every effort will be made to create the requested match; however, an acceptable match may not be possible because of natural variations of wood. These natural variations can also cause minor differences in the final finish product.

Samples

Samples of standard wood finishes, paints colors, metal colors, and standard laminate are available upon request. The fastest way for requests to be filled is by using our website. See below for options to request samples.

Website – jsifurniture.com (click the resource tab)
JSI Sales representatives
Phone – 800.457.4511 – Customer Service
Email – customerservice@jaspergroup.us.com

Pricing

Prices found in this document or on our website are list prices in U.S. dollars for standard product delivery to one destination. Prices do not include storage, installation, or taxes. Possession of this price list does not constitute an offer to sell. Orders can only be received from approved authorized JSI dealers.

Prices and product information in this document, as well as our website, are subject to change without notice. Reference website for most up to date product offering and pricing.

Orders

Detailed specification pages are available in the price list at the beginning of each series.

Additional information may be obtained by consulting the Customer Service Department or our website.

Indicate shipping address if different from billing address.

Send Orders To:

US Mail – JSI
225 Clay Street
Jasper, IN 47546
Fax – 812-482-1548
Email – orders@jaspergroup.us.com

JSI reserves the right to make changes in dimensions, styles, or specifications if we believe these changes will improve the safety, quality, or appearance of the product.

Acceptance of orders will be subject to credit approval, barring any acts of governments, or any other causes beyond our control (e.g. strikes, fire, embargo of materials, etc).

Product Modifications

While we offer a wide range of products to accommodate many possible solutions, we also recognize the needs for our products to be modified from our standard offering.

In the series introduction section of each product, we address modification options for that series.

To see if the desired modification is possible, please contact our Customer Service Department for a quote. Note that order quantities and material availability can affect the quote. Additional information may be requested to fully quote modifications.

Order Acknowledgments

All orders will be acknowledged promptly upon entry of a clean order. The acknowledgment will show how the order was entered, ship date and any other information pertinent to the order. It is the purchaser's responsibility to verify all the information on the acknowledgment carefully and notify us immediately, in writing, of any discrepancies.

Every reasonable effort is made to ship as acknowledged; however, the acknowledged ship date is approximate. Company will generally ship within five (5) working days of the acknowledged ship date. If a firm ship date is necessary, customer must inform company at time of order and company will make all reasonable efforts to meet each customer's request. Acknowledged shipping dates are contingent upon the force majeure conditions contained in these terms and conditions.

Quickship

JSI offers select Vision models, with select options, in our Quickship program. These items ship within 10 business days after receipt of a clean, credit approved purchase order. Items should be placed on order separate from standard lead time models.

Product for up to 10 offices or 10 tables can be included on a single Quickship order. Available capacity is filled by orders as they are received. If normal 10 day Quickship is not available because capacity has been filled, you will be immediately notified by JSI customer service. Changes and cancellations to Quickship orders are not allowed under any circumstances, nor are modifications to the predetermined Quickship offering. Limit one order per project.

Delivery

Our freight policy consists of prepaid freight to the 48 contiguous states; all other shipments are prepaid to port of exit ONLY. JSI reserves the right to select the appropriate carrier and shipment routes, most shipments are on freight carriers that are dedicated furniture specialists. Standard deliveries require a DOCK that can accommodate **75 foot trucks**. Ownership and inspection of product is the responsibility of the buyer upon pickup by the freight carrier. Pricing in this book is for standard delivery only. Standard delivery does **not** include non-dock delivery, inside delivery, residential delivery or installation of product. Fees and changes for non-standard deliveries are listed below.

Standard Delivery Time

Between 8AM and 3PM Monday through Friday. Special delivery requests can be subject to additional fees to accommodate requests.

Cancellations and Changes

All orders are considered firm and are not subject to cancellation or change without approval from JSI. All approved changes are subject to additional charges and revised lead times

No Touch Freight

Our freight is considered "no touch". Therefore, customers are to be prepared to unload freight from inside the truck prior to arrival. In the instance that a driver must unload the shipment, driver assists fees will apply (see fees below).

On-Site Deliveries

Shipments to the installation site, and time deliveries are available on full truckloads or slightly less, at no additional charge. Shipments or timed deliveries for smaller shipments may not be available, or if available may require an additional charge.



Detention Fees

- Carriers are given two-hour maximum time allotment to unload for one-stop truckloads.
- Carriers are given one hour maximum time allotment to unload for multi-stop truckloads
- *Detention fees apply after allotted unloading time and will be at buyer's expense.

Fees

Orders of less than \$1,000 net \$90 net per order
 (If order is UPS shippable, the handling fee is waived and customer is invoiced for exact shipping charges.)
 Weekday deliveries outside of standard delivery times \$300
 Weekend deliveries (Saturday or Sunday) \$600
 Liftgate Deliveries. \$500 minimum 7% of net price
 Driver Assist \$90
 Jobsite Non-Dock Delivery \$150 per truck
 Inside Delivery (first floor inside only) - no installation or carton removal. \$250 minimum 7% of net price
 NO RESIDENTIAL DELIVERIES

Warehouse/Storage Fees

Additional storage time with a provided two-week approved notice is calculated at 3% per month of the product amount or per day.

Please be Advised

- Reconsignment fees are the responsibility of the buyer.
- Any charges arising from failure to meet shipment, re-routing while in transit or carrier storage charges are the responsibility of the buyer.
- Contact Customer Service to inquire about skidding of products, special crating of products and product installation. These requests must be approved by JSI and made at the time of order.
- Carriers have the right to refuse delivery to a specified location if it conflicts with their liability policy.

Freight Damage

JSI products are packed in cartons and meet or exceed existing codes for furniture and seating products. All shipments are delivered to the carrier in good condition and our liability ceases thereafter. If delivery arrives short or damaged, contact the carrier immediately to file a claim. In the event of concealed damage, notify the carrier and request immediate inspection. Failure to file a claim within 15 days after receipt of merchandise constitutes acceptance and a waiver of any such claims. Please inspect merchandise immediately upon receipt, otherwise there is no recourse. Keep all cartons and packing material, discarding these materials may negate your claim.

Storage of product in areas of uncontrolled humidity and temperature may cause damage to the product and void the JSI warranty.

Repairs

JSI will not issue credit allowance for any type of repairs without prior written consent.

Sales order, product model numbers, and reason for repair will be expected in order to process the repair request. A digital photo will help to expedite the request. JSI reserves the right to recommend solutions for repair.

Replacement Parts

Obtain information and pricing on replacement parts by contacting Customer Service. Please have the model number available when requesting replacement parts. Additional information may be required to ensure proper replacement parts.

Returns

JSI products are made to order and may not be returned for credit. No merchandise may be returned to JSI without a signed Return Good Authorization (RGA) form issued by our Customer Service Department. RGA's will be considered for the following reasons:

1. Manufacturing defect (validated by JSI representative).
2. JSI order processing error.
3. Shipping error.
4. Mis-marked cartons.
5. Duplicate shipments.

Liability for defective merchandise shall be limited to replacement or repair.

If you have questions as to whether your reason for return qualifies for consideration, please contact Customer Service. At the discretion of JSI, returns on stocked items may be considered with the following stipulations:

1. 60% restocking fee.
2. All return freight charges must be prepaid by dealer.
3. Product was never removed from the original carton.
4. Product must be returned within 30 days of RGA issue date.
5. Credit will not be issued if product returned is damaged.
6. Under no circumstances can we accept COD (Cash on Delivery) returns. Any such shipment will be refused.

Please note most models on Quickship are produced on demand and cannot be returned. Modified, special or custom-built product is not eligible for return.

Fire Retardancy

All JSI upholstered components comply with California Bureau of Home Furnishings and Thermal Insulation-Technical Bulletin 117-2013 issued by State of California Department of Consumer Affairs. This standard requires upholstered furniture to be safer from the hazards associated with smolder ignition in all four (4) categories of materials, as applicable.

Compliance with more stringent codes may require special manufacturing considerations and upcharges.

California Technical Bulletin 133 (CAL 133)

JSI uses a barrier material between the foam cushioning and the upholstery cover in order to comply with CAL 133. The standard upcharge on products specified to comply with CAL 133 is **\$78 list per yard** of textile.

JSI has performed a series of full scale fire tests on samples - representing worst case scenarios of upholstered units - to comply with the requirements of the state of California Technical Bulletin 133 (CAL 133). Products in compliance are labeled in accordance of the standards.

Some product designs and fabric cannot be combined to comply with CAL 133. Because of this, we reserve the right to reject any request for an upholstery cover, including COM, textile may not contain olefin or product style that we feel may compromise the integrity or safety of a product specified to comply with CAL 133.

Contact Customer Service for a quote if you require laboratory certification that a specific product and upholstery combination WILL PASS CAL 133. The quotation will include testing, video, and transportation charges plus the list cost of the sample.

Our standard lead time will apply to products that do not require certification. Allow an additional six weeks over the standard lead time for products that need actual laboratory certification.

The end user, specifier and/or dealer have the responsibility to make sure all products specified will meet the flammability and safety codes of the jurisdiction where the products will be located and used.

Flame Spread

All JSI may be required to comply with the requirements of Flame Spread based on ASTM standards/NFPA Life Safety Codes and general public knowledge are as follows:

Solid Wood - Class C
 Topcoats - Class A
 Carded Fabric - Class A
 Composite Panels - Class C
 Laminate - Class B

Plastics - According to the NFPA, the lack of stability of plastics under high temperature conditions and inherit combustibility have eliminated the use of plastics for applications requiring a flame spread rating.

Also be advised that improvements may be attained in certain instances with the addition of chemicals which may add additional costs, chemical exposure and/or compromise the integrity of the product.

Textile Carded Programs

JSI is proud to partner with Maharam, Momentum, Spradling, Stinson, Ultrafabrics, Camira and Cortina Leather. Please refer to our website for our standard patterns, along with the current grade.

<https://www.jsifurniture.com/finishes-and-materials/textiles>

Textile Grade-In Programs

For the convenience of our specifiers, we offer an extensive graded in program. Please reference our website for the most up to date information on our graded in program.

<https://www.jsifurniture.com/resources/textile-partner-info/overview/>

For additional specifications on the pattern or to order memo samples, please contact the textile suppliers directly:

Arc Com www.arc-com.com
 Camira www.camirafabrics.com
 Designtex www.designtex.com
 Maharam www.maharam.com
 Mayer www.mayerfabrics.com
 Momentum www.themomgroup.com
 Spradling www.spradlingvinyl.com
 Stinson www.cfstinson.com
 Ultrafabrics www.ultrafabricsllc.com
 Cortina Leather www.cortinaleathers.com

Any textile not graded in or pre-approved for COM/COL will require application test approval prior to order entry and shipment of fabric or leather to JSI. For current JSI grades and application status by series visit jsifurniture.com Resources > Graded-In + COM; jsifurniture.com Resources > Graded-In + COM.

Indicate on purchase order if JSI is to order the fabric.

Grades and availability of fabric are subject to change without notice. Changes could include but are not limited to price increase, discontinued patterns, discontinued colors, etc. See jsifurniture.com for up to date information.

Many textiles have repeats and the additional yardage required has been factored in for textiles ordered through the JSI Carded and Grade-In Programs. We reserve the right not to match textiles with a horizontal or vertical repeat greater than 17". Additional charges may apply for textile being applied with special instructions.

Some fabric thickness or stiffness may cause issue with proper upholstering of tackable wall panels or upholstery privacy screens. Please contact customer service with concerns on the fabric thickness for these items.

COM/COL Address

JSI
 Attn: COM/COL Department
 Receiving B
 Dock 71
 201 East Martin St.
 Orleans, IN 47452

Tag: Dealer Name / Purchase Order #

General COM Fabric/COL Hide Policy

Refer to the COM/COL Price Columns for list prices.

All yardage requirements listed in the price list are based upon 54" plain non-directional material. Additional yardage may be required based on fabric repeat and matching.

All square footage requirements for COL are based on an average hide size of 50 square feet.

Contact Customer Service for any of the following conditions:

- + approval of COM/COL to be used (see policy on the next page)
- + fabric repeats greater than 3"
- + fabric less than 54" wide
- + leather hides smaller than 50 square feet
- + special application requirements request

When requesting information from Customer Service on COM/COL please supply the following information:

- + model number and quantity of the product the COM/COL will be applied
- + COM/COL textile supplier's name
- + name of pattern and color of the textile
- + any special application request

Visit jsifurniture.com Resources > Graded-In + COM to see if the textile has already been approved. If there is no record for this particular textile then a Memo Sample will be required.

JSI takes no responsibility when additional materials must be ordered.

COM Fabric Repeat Guide

Roll Width	Plain Fabric	1" - 5" Repeat	6" - 10" Repeat	11" - 15" Repeat	16" - 20" Repeat	21" - 30" Repeat	31" - 40" Repeat	41" - 50" Repeat
54"	0%	10%	15%	20%	25%	30%	40%	50%
53" to 51"	15%	20%	25%	30%	35%	40%	50%	60%
50" to 48"	30%	35%	40%	45%	50%	55%	70%	90%
47" to 36"	60%	65%	70%	75%	80%	85%	100%	120%

The percentage represents the additional fabric yardage that needs to be added to the COM yardage. Contact Customer Service for repeats greater than 50".

All COM/COL must meet applicable codes and regulations, including TB117-2013. By selecting COM/COL, customer certifies that the material meets such codes. JSI assumes no responsibility for the applicable codes and regulation regarding flammability rating and safety rating of any COM/COL.

JSI cannot be held responsible for receipt of defective fabrics, as we apply all COM as first quality goods.

We can take no responsibility for tailoring, wear-ability or application of COM/COL textiles. Any warranty claims for the COM/COL Textile materials will fall to the original vendor of the textile, not JSI.



COM Fabric/COL Hide Process for JSI Seating

General COM Fabric and COL Hide Policy also apply.

JSI will approve or disapprove COM/COL on all products. An approval of a textile from JSI makes no claim that performance, durability or tailoring of COM/COL will result in satisfactory upholstery. Every effort will be made to meet customer's expectation, but fabrics/leathers have unforeseen inherent characteristics that may limit JSI's ability to deliver a well tailored product.

Approval COM Textile/COL Hide Process for Seating

Follow the Steps Below:

1. Send a Memo Sample of the COM/COL (recommended memo be at least 4" x 4")

JSI

Attn: COM/COL Approval Department

201 East Martin Street

Receiving B, Dock 71

Orleans, IN 47452

2. Call our Customer Service Department at 812-482-3204 to request an electronic version of approval form.

Guide Order Form for COM and COL

Please send sample to:

JSI

Attn: COM/COL Approval Depart.

201 East Martin St.

Receiving B, Dock 71

Orleans, IN 47452

① Order Information:

Quote #: _____ Purchase Order #: _____

Customer Service: _____

Dealer Name/Project Name: _____

Contact: _____

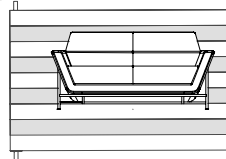
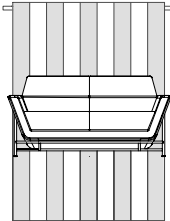
Address: _____

Phone: _____ Email: _____

Model Number(s) Receiving COM / COL: _____

② Select off the bolt application: (Check one of the boxes)

Up the roll (standard on most seating) Railroaded



③ Additional information:

④

Attach sample here.

JSI will review and test as needed all requests. You will be notified as soon as results are documented by our review personnel. JSI reserves the right to reject any COM/COL on our products. We will provide COM/COL explanation of any unapproved textile whenever possible.

Custom Options

Wood Laser Engraved Back

Many of our seating models are available with a custom wood laser engraved back. University seals, logos, unique designs, or any type of graphic can be designed into the seating back for a custom creation. Copyright approval may be required. Consult JSI Customer Service for pricing and artwork specifications. Artwork must be submitted as a JPG or PDF file.



Wood Laser Engraved Back General Pricing

* must order plain back when choosing these options

For Artwork 4" x 4" or Less	\$56 list per chair
For Artwork Less than 6" x 6"	\$99 list per chair
For Artwork Larger than 6" x 6"	Call For Pricing

For orders fewer than 50 pieces, add \$153 list per design, per order. This pricing reflects etching (leaving the wood dark). If additional painted colors are added to artwork please call customer service for pricing.

A \$134 list set-up fee applies.

Care and Maintenance

Care and Maintenance

Care of Upholstery Surfaces

Cleanability will vary based on the fabric type. For best results, a professional service is recommended. Dirt and crumbs may be gently brushed or vacuumed off. Spills should be wiped up immediately with a cloth. Vinyl textiles can be cleaned with warm soapy water and then wiped down with a warm damp cloth. For more details on any JSI carded fabric and vinyl, please visit our website at jsifurniture.com or consult the back of the appropriate swatch card for cleaning codes and any specific instructions. For COM materials, consult with the individual textile manufacturer for cleaning codes and any specific instructions pertaining to your particular fabric.

Maintenance of Mechanical Parts

Clean any lint or debris from the moving parts of the base mechanisms. Mechanisms have been designed and tested to not require lubrication under normal conditions; however, lubricant can be used if needed.

Care of Wood Edges and Veneer Surfaces

Clean all surfaces frequently with water dampened soft cloth, moving the cloth with the grain direction. Immediately remove any liquids that come in contact with wood surfaces with a blotting action to absorb liquid. Buff dry. Lift objects to move them, never pull them across the finished surface. For an additional safeguard, use a protective surface pad. This will ensure a lasting finish by protecting your furniture from possible damage caused by pens, cups and sharp objects. Avoid exposure of furniture to extremes of heat and cold, or to wide humidity variances. Avoid exposure of furniture to strong sunlight. Avoid exposure of furniture to harsh solvents such as nail polish remover, acetates, etc., as it will cause finish deterioration. If using a protective glass top, place spacer pads under the glass top to allow the wood to breath.

Care of Metal Finishes

Wash you powder-coated item at least one every six months. Use soft rags only - No abrasives. For stubborn stains and grease marks, use soap and water mixture. Combine 1 gallon of water and 1 cup of the neutral detergent in the bucket. Mix it up by swirling one of the rags around in it. Wipe down the powder coat with a rag that has been dampened with the cleaning solution. Do not scrub, but use gentle, repetitive pressure to remove any built-up grime. Rinse the powder coat off with a rag dampened with clear, clean water. Do not spray it down, but rather wipe it off with the rag. You may need to do this several times to get all the soap off. Wipe the powder coat down with a clean dry rag. This will prevent streaking and spotting.

Care of Frosted Glass

Use a clean, dry lint free cloth to wipe the surface. Follow with warm water and a clean rag; no soap or chemicals. Wipe dry with a clean, dry lint free cloth. Cleaning the frosted side is not recommended, if desired to clean use the above method but do not spray the water on the frosted side, use a clean rag. Please allow 48 hours for the frosted side to dry and not to show cloudiness.

Tempered Glass Information

JSI is aware of occasional occurrences of spontaneous glass breakage in various furniture products. Tempered glass makes it stronger and if it breaks, will cause it to break into many small pieces of "cubes" rather than sharp and potentially dangerous shards.

Glass breakage in furniture may occur for a variety of reasons. Tempered glass is particularly prone to breakage from damage (scratches, nicks, etc.) that may occur during shipping, handling, installation, use or maintenance. Exposure to rapid changes in temperature or concentrated temperature zones may also cause breakage.

Tempered glass may also break due to a specific type of imperfection or "inclusion" that occurs within the glass when manufactured. When this condition exists glass breakage may occur without any obvious cause. This is often referred to as "spontaneous" breakage but is a very isolated occurrence in the glass industry.

Care of Dry Erase Boards

Erase after every use to eliminate ghosting. Clean weekly with a Dry Erase Cleaner. Avoid the use of orange and red Dry Erase Markers. Follow manufacturers cleaning instructions for the eraser. If ghosting or staining remains use a small amount of rubbing alcohol on a clean, soft towel to remove.

Care of Solid Surface

Although liquids cannot penetrate Solid Surface, it is best to wipe up spills as they occur. Generally, a damp microfiber cloth used with a standard household kitchen spray should remove most stains.

For most residues, all you need to clean your Solid Surface countertops is a warm soapy water, ammonia-based household cleaner or a dedicated countertop cleaner. Do avoid window cleaners; however, as they can leave a waxy build-up that dulls the surface. Always clean using a circular motion.

Film will build up on countertops if water is left to dry on the surface. This film will dull the countertop surface, making the finish appear blotchy and uneven. To prevent film build-up, it is very important to wipe the countertop completely dry immediately after spills and cleaning.

Some color of Solid Surface may require more frequent cleaning to maintain a uniform finish. Darker colors tend to require more attention than lighter colors. Over time, even with proper care, your countertop will acquire a sheen. Dark colors may show light scratches more readily.

Specification Tools

JSI products are manufactured to order and provide a multitude of options to address your individual customer needs. As you process your order do not forget to include all the necessary information to allow the order entry process to be completed. Please see the order checklist at the beginning of every series.

JSI Customer Service edits every order for complete information. If details are not included with the purchase order, Customer Service will contact you to answer these questions. If information is not completed in a timely manner it will delay the entry process and could affect your product delivery date. To avoid delay in order entry and potential delay in delivery of your order, please double check the line items to ensure all selections have been completed.

To ensure completion of details on your purchase order, electronic catalogs and specification tools have been developed to aid in the process. These electronic tools include:

20-20 GIZA Studio and 20-20 CAP Studio software offers state-of-the-art design, specification, photo-realistic rendering and three-dimensional visualization capabilities for configurable products in the commercial interior design markets. 20-20 GIZA Studio and 20-20 CAP Studio are available for all JSI Casegood and Seating products, in 2D and 3D graphics and the Specifier Catalog. Updates are made monthly reflecting any changes that occurred. To be sure the most up to date information is provided on orders, users of this software program are responsible to update their catalogs.

CET Designer, by Configura is an all-in-one software solution for space planning and configuration of products. The intuitive workflow guides you through entire process from idea to reality - supporting every step of the sales process

ProjectMatrix, Inc. offers a full software solution for the contract furniture industry. Their software can help you create space plans to specifications for ease of specifying our JSI Casegood and Seating product lines. Updates are made monthly reflecting any changes that occurred. To be sure the most up to date information is provided on orders, users of this software program are responsible to update their catalogs.

GSAdvantage is a Federal Government electronic catalog site offered to assist GSA customers in specifying and pricing JSI product. Listed at this site are all contract items and prices under GSA Contract # GS-28F-0030U.

Our JSI website jsifurniture.com provides many tools to assist in the design and order selection. Included in the site are downloadable images, typicals, product symbols, brochures, contact information, price lists, sales representative locations, warranty and environmental information.

GSA Terms and Conditions



Contract Holder
Contract # GS-28F-0030U

In addition to the standard terms and conditions, the following terms and conditions apply to GSA contract.

Contract Number
GS-28F-0030U

Contract Period
June 24, 2013 - June 24, 2028

Statement of Intended Use
The furniture covered by special item number 33721 Office Furniture shall comply with the requirements defined in purchase description 3QSAB 09-608. All furniture offered under this SIN shall be GSA Chassis Grade 1, 2, 3 or NA, GSA Drawer Grade 1, 2, 3, 4 or NA, Design A B or C, as defined in 3QSAB 09-608.

Description of Special Item Number SIN #33721

Cooperative Purchasing
No

Set Aside
No

FSC/PSC Code
7125

NAICS 337211 Wood Office Furniture Manufacturing 1000 employees

Includes all furniture placed in an office, such as chairs, desks, etc. In addition, ancillary services are included, however services performed shall not be the primary purpose of the work ordered.

Lowest Price Model

SIN #	Model Number	Net Price
33721	VS-LBRKT-20	\$28.03

Maximum Order
\$250,000 net

Geographic Coverage
48 contiguous states and Washington D.C.

Point of Production
Jasper, Dubois County, Indiana
Orleans, Orange County, Indiana

Discount
Discount 61.6%* off list.

*Discount for Walden and Wellington is 61.71% off list.

Discount Quantity
Walden and Wellington only
\$300,000 to \$350,000 Net = 0.5%
\$350,001 to \$400,000 Net = 1%
\$400,001 to \$450,000 Net = 1.5%

Prompt Payment Terms
1% 15 - net 30 days from date of invoice.

Government purchase cards are accepted at or below the micro-purchase threshold

Government purchase cards are accepted above the micro-purchase threshold

Foreign Terms
Not applicable.

Time of Delivery
30-75 days after receipt of order, 90 days maximum.

Expedited Delivery
Contact Customer Service 800-457-4511

Overnight and 2-day Delivery
Not applicable.

Urgent Requirements
Contact Customer Service 800-457-4511

F.O.B. Points
F.O.B. destination, freight prepaid and allowed to 48 contiguous states and Washington D.C. excludes special delivery requirements.

GSA Terms and Conditions

Ordering Address

Jasper Seating Company, Inc. d/b/a JSI
Attn: Participating Dealer
225 Clay Street
Jasper, IN 47546
Fax: 812-482-1548
Phone: 800-457-4511
Email: orders@jaspergroup.us.com

Order Procedures:

Per contract

Payment Address

JSI
225 Clay Street
Jasper, IN 47546

Warranty Provision

Limited Lifetime

Export Package Charges

Quoted on project-by-project basis.

Terms of Government Commercial Credit Card Acceptance

Accepted.

Rental, Maintenance, and Repair

Not applicable.

Terms and Conditions of installation

12% of net purchase order for installation services up to \$250,000.00 of net purchase price.

Terms and conditions of repair parts, etc.

See warranty.

List of service and distribution points

Contact Customer Service 800-457-4511.

List of participating dealers

Contact Customer Service 800-457-4511.

Preventive Maintenance

N/A

Environmental Attributes

GreenGuard Certified and recycled wood waste and fabric remnants

Section 508 Compliance.

N/A

DUNS

00-636-7767

CCR and SAMS Registration

Jasper Seating Company, Inc. is registered
Cage Code #31881
Federal ID #35-0420370
UEI #DDJ2GKQM7M84

Product Modifications

We willingly accept customers' modifications to standard products. See product modification information by series at the start of each series under the "Product Modification" sections. If there is a modification you desire that is not listed in this section, please call Customer Service for a modification quote/price

Acceptance, Modification, Assignment

By placing this order for furniture, material or other products (sometimes collectively referred to as "goods"), customer agrees to these terms and conditions which shall prevail over inconsistent provisions in any other form or document of customer. No change or modification shall be applicable unless set forth in writing and signed by company. Neither this order nor any interest therein shall be assigned by customer except with the prior written consent of company.

Payment

Customer agrees to pay to company the amount indicated on the invoice, 1% 15 days, net 30 days from date of invoice (U.S. funds only), for goods ordered. Interest will be charged after 30 days from the date of invoice at the rate of one and a half percent (1.5%) per month. International sales will require additional payment arrangements. No goods shall be sold on consignment or conditional sales basis. Payment for the goods delivered hereunder shall constitute acceptance thereof.

Attorneys' Fees

Customer shall be responsible for all expenses and cost in connection with the enforcement by company of these terms and conditions and the cost of collection (including the fees of any collection agencies to whom the customer's account may be referred), plus reasonable attorneys' fees (which attorneys' fees shall not be less than 25% of the amount due, unless a lower amount is specified by applicable law).

Remedies

The remedies herein reserved shall be cumulative, and additional to any other or further remedies provided in law or equity. No waiver of a breach of any provision of these terms and conditions shall constitute waiver of any other breach or of such provision.

Insolvency

Company may forthwith cancel this order in the event of the happening of any of the following or any other comparable event: insolvency of the customer, the filing of a voluntary petition in bankruptcy, the filing of any involuntary petition to have customer declared bankrupt provided it is not vacated within thirty (30) days from the date of filing, the appointment of a receiver or trustee for customer provided such appointment is not vacated within thirty (30) days from the date of such appointment, or the execution by customer of an assignment for the benefit of creditors.

GSA Terms and Conditions

Limitation of Liability

The Company shall not under any circumstances be liable to the customer, owner of the goods or any third party for special, indirect, incidental, or consequential damages, including, without limitation, loss of profits or revenues, loss or damage to other property or equipment, cost of capital or of purchased or replacement goods, or expense, delay, or inconvenience cause by or arising from the purchase, sale, use, repair or inability to use the goods or by any performance or non-performance under, or breach of, these terms and conditions. The Company's sole liability for any defective goods shall be its repair or its replacement pursuant to the express warranties set forth above, or if amended, as applicable at the time of manufacture or repair of the goods. Some states do not allow the exclusion or limitation of incidental or consequential damages, so the above limitations or exclusion may not apply to all customers. Any action resulting from any breach on the part of company as to the goods or services delivered here under must be commenced within one year after the cause of action has occurred.

Returns and Allowances

Reasonable touch-up and deluxing is the dealer's responsibility. The Company will not make allowances for trip or delivery charges, but will only make allowance for actual work performed to correct manufacturing defects. Allowances maybe authorized only by a company officer. It is the responsibility of the field sales representative to inspect any defective merchandise and make suggestions and recommendations as to the proper disposition. Field personnel cannot obligate or bind the company by definite agreement, without final authorization by a company officer. Company will not accept automatic charge backs which do not have prior authorization. All defects must be called to the company's attention upon arrival at the customer's "ship to" destination. To initiate any type of claim or request for parts, it is imperative to have the model number or fabric number, which may be located on the tag attached to the frame of the unit. Authorization for return to the company via a return goods authorization. Company will not issue credit allowances for any repairs without company's prior consent. Under no circumstances shall the company accept COD (cash on delivery) returns, and any such shipment will be refused.

Security Agreement

The Company may require and customer shall grant a security interest in goods sold pursuant to any credit the company may extend to the customer.

Governing Law

All disputes between the parties, whether or not arising out of these terms and conditions, will be governed by the laws of the state of Indiana. Customer agrees to submit to the jurisdiction of and agrees all lawsuits relating to any disputes between the customer and the company will be brought only in a state court located in Dubois County, Indiana or the United States District Court for the Southern District of Indiana. The customer hereby waives the right to a trial by jury in any action, proceeding, claim, or counterclaim whether in contract or tort, at law or in equity, arising out of or relating in any way to these terms and conditions and all other disputes between the parties.

Mitigation

If the company repossesses the goods prior to payment by the customer of all amounts due hereunder, the company may sell the goods, as is, where is, free and clear of all rights of the customer at either public or private sales, and apply the net proceeds (after deducting expenses of repossession and sale) to the obligation of customer hereunder. The customer may dispose of the goods in any commercially reasonable place and manner and the customer waives any notice of time, place and manner of sale.

Integration

This order for goods, including these terms and conditions, along with any credit application, invoice, statement, dealer contract, acknowledgment, bill of lading (and any exhibits, addenda or amendments thereto) of which this order may be a part, constitutes the sole and complete agreement between the company and the customer with respect to the purchase of the goods.

Dimensions/Specifications/Finishes

All dimensions are approximate and may vary due to the upholstery technique of each craftsman. If exact dimensions are required, it is necessary for the customer to state such specifications with the order. Detailed specifications sheets are available for each series of goods, and customer should consult the company's customer service department for these specification sheets. Company reserves the right to make changes in dimensions, style, or specifications if company believes these changes will improve the goods' quality or appearance. Company reserves the right to substitute hardwoods due to availability at production. Due to the natural characteristics of wood, environmental effects, and material upgrades, the company cannot guarantee exact finish matches on existing goods previously ordered from company. If an exact match to customer's existing goods is required, it must be specified so that the proper procedures can be followed to ensure an acceptable finish. Company will accept no liability for the finish if this procedure isn't followed. Company reserves the right to make changes in a finish formula if company believes the change will improve the quality or appearance of company's goods.

Company's Performance of Its Obligation

The production and delivery of the goods to the extent delayed or hindered or prevented from the performance by reason of natural disasters, acts of god, strikes, lockouts, labor troubles, inability to procure materials, casualties, failure of power, restrictive governmental laws or regulations, riots, insurrections, acts of terrorism, war or other reason of a like nature not the fault of the company shall excuse for the period of the delay the company's performance and the period for the performance shall be extended for a period equivalent to the period of such delay.

Casegoods Price List | Vision Series

General Information

Environmental Mission	II	Custom Options	VIII
Warranty	III	Care and Maintenance	IX
Laminate and Veneer Characteristics	III	Specification Tools	X
Samples	IV	GSA Terms and Conditions	XI
Order Procedures	IV		
Quickship Program	IV		
Delivery	IV		
Freight Damage	V		
Repairs and Returns	V		
Fire Retardancy / CAL 133	V		
Textile Information / COM and COL Policy	VI		

Vision - Casegoods

Vision

Height Adjustable Table Desk/Bridges	VS2
Height Adjustable Corner Tables	VS10
Height Adjustable Modular Components	VS24
Desks	VS59
Bridges	VS83
Returns	VS84
Corner Units	VS93
Credenzas	VS101
Modular Tops	VS111
Modular Pedestals & Supports	VS126
Modular Modesty/Back Panel	VS142
Metal Bases & Supports	VS161
Overhead Cabinets	VS164
Tackboards	VS172
Accessory Rail	VS180
Accessory Rail Accessories	VS181
Wall Mount Storage	VS204
Wall Mount Tackboards	VS220
Wall Mount Cubbies	VS232
Floating Shelf	VS234
Overhead Bookcases	VS235
Storage Tower	VS237
Back Panel for Storage Tower	VS238
Markerboards/Tackboards	VS241
Wall Panels	VS258
Bookcases	VS294
Lateral Files	VS296
Mobile Pedestals	VS297
Wardrobes	VS299
Storage Cabinets	VS301

Accessories

Casegoods Tasklights	VS318
Casegoods Keyboard Accessories	VS320
Casegoods Wire Management	VS322
Casegoods Power and Data	VS324

Vision - Conference



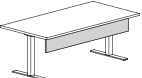
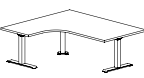
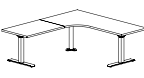


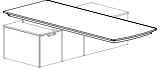
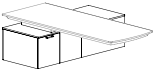
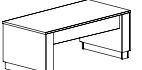
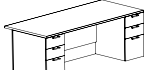
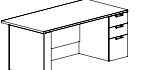
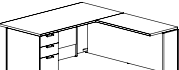


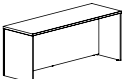
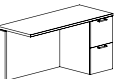
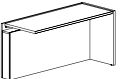
Veneer Veneer	VS331
Conference Tables	VS338
Conference Tops	VS339
Conference Table Bases	VS342
Credenzas	VS344
Vertical Storage Units	VS345
Lectern	VS349
Visual Board	VS349

Vision Laminate	VS330
Conference Tops	VS346
Conference Table Bases	VS348
Lectern	VS349
Visual Board	VS349
Credenzas	VS350
Vertical Storage Units	VS351






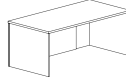
Accessories	VS353
Power and Data	VS355

Vision - Overview

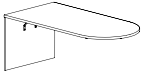
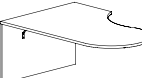
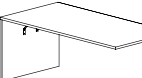
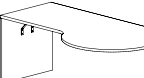
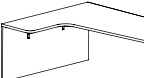
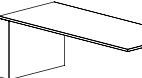
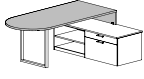
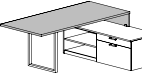
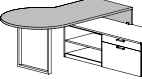
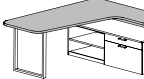
Height Adjustable Desk/Bridges/Returns/Credenzas

						
Adjustable Height Table Desk Page VS2	Adjustable Height Bridge Page VS2	Adjustable Table Modesty Panel Page VS6	Adjustable Corner Table One Piece Top Page VS10	Adjustable Corner Table Two Piece Top Page VS14	Adjustable Height Base for Table Desk Page VS32	Adjustable Height Base for Corner and L-Unit Page VS32
						
Cantilever Table Top Page VS34	Credenza Support for Cantilever Table Page VS34	Adjustable Height Table Desk Page VS35	Adjustable Height Double Pedestal Desk Page VS36	Adjustable Height Single Pedestal Desk Page VS37	Adjustable Height L-Shaped Desk Page VS41	Adjustable Height Bridge Page VS49
						
Adjustable Height Pen. Desk - Credenza Page VS51	Adjustable Height Shell Credenza Page VS53	Return for Adjustable Height Desk Page VS54	Adjustable Height Workwall Return Page VS57			


Desks

					
Table Desk Page VS59	Double Pedestal Page VS60	Single Pedestal Desk Page VS63	Single Pedestal Desk Page VS63	Shell Desk Page VS78	Shell Desk Page VS78

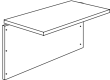


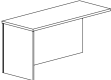
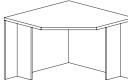
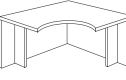
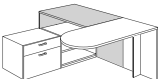
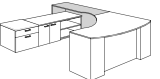
Peninsula Desks

					
Multiple Shaped Peninsula Desks Page VS69					
					
Multiple Bench Height Supported Peninsula Desks Page VS79					

Peninsula Desk Bases and Bullet Return Bases

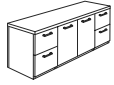
						
Executive Base Page VS161	Taper Base Page VS162	Truss Base Page VS162	Dowel Base Page VS162	Rectangular Base Page VS162	Perimeter Base Page VS162	Column Base Page VS162

Bridge/Returns/Corner Units

					
Bridge with Modesty Panel Page VS83	Returns Page VS84	Shell Return Page VS89	Shell Return Page VS89	Corner Unit Page VS93	Cockpit Corner Unit Page VS93
					
Bench Height Supported Shell Return Page VS92					

Vision - Overview

Credenzas



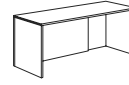
Storage Credenza
Page VS101



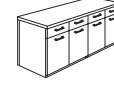
Kneespace Credenza
Page VS103



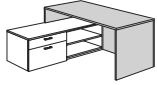
Single Pedestal Credenza
Page VS104



Shell Credenza
Page VS108



Buffet Credenza
Page VS109



Bench Height Supported
Shell Credenza
Page VS101

Modular Tops



Bow Front Desk Top
Page VS111



Rectangular/Soft Rectangular Desk Top
Page VS112-VS113



Bullet Desk Top
Page VS114



Sweeping L Desk Top
Page VS115



Extended Corner Desk Top
Page VS116



Extended Corner Bullet Desk Top
Page VS117



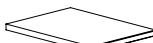
Return/Bridge Top
Page VS118



Credenza Top
Page VS120



Extended Corner Credenza Top
Page VS122



Pedestal Top
Page VS123

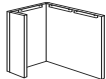


Bench Height Tops
Page VS124

Modular Pedestals & Supports



Pedestals
Page VS126



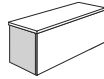
Wing End Support
Page VS138



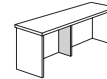
T-Support
Page VS140



T-Support with Metal Braces
Page VS140



Modular End Panel Support
Page VS142



Modular Center Support Panel
Page VS143

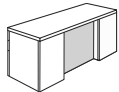


Modular Back Panel
Page VS160

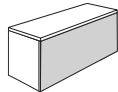


Modular Back Filler Panel
Page VS160

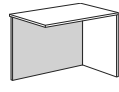
Modular Modesty / Back Panel



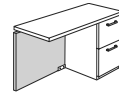
Modular Break Front Desk and Credenza Modesty Panel
Page VS146



Modular Desk and Credenza Shell Modesty Panel
Page VS147



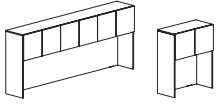
Modular Shell Return Modesty Panel
Page VS150



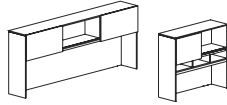
Modular Return Modesty Panel
Page VS153

Vision - Overview

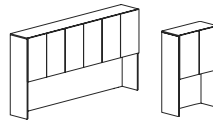
Overhead Cabinets



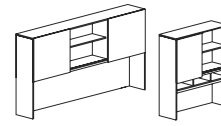
Storage Overhead Cabinet
Page VS164



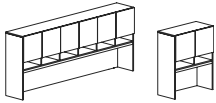
Storage Overhead Cabinet
w/ Sliding Doors
Page VS166



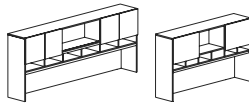
Double Height Storage Overhead
Cabinet
Page VS168



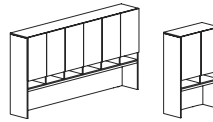
Double Height Storage
Overhead Cabinet
w/ Sliding Doors
Page VS170



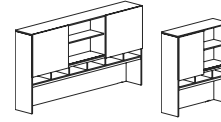
Storage Overhead Cabinet
and Cubbies
Page VS186



Storage Overhead Cabinet
w/ Doors, Open Center Shelf
and Cubbies
Page VS188

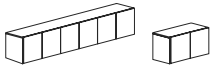


Double Height Storage Overhead
Cabinet Cubbies
Page VS192

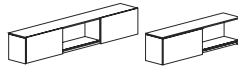


Double Height Storage Overhead
Cabinet w/ Sliding Doors and
Cubbies
Page VS194

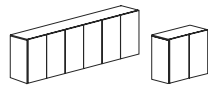
Stack On Storage



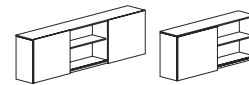
Wall Mount Overhead Cabinet
Page VS204



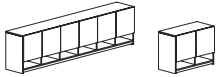
Wall Mount Overhead Cabinet
w/ Sliding Doors
Page VS206



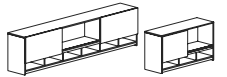
Double Height Wall Mount
Overhead Cabinet
Page VS208



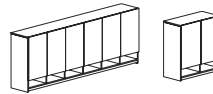
Double Height Wall Mount
Overhead Cabinet
w/ Sliding Doors
Page VS210



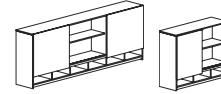
Wall Mount Overhead Cabinet
and Cubbies
Page VS212



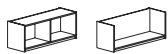
Wall Mount Overhead Cabinet
w/ Sliding Doors and Cubbies
Page VS214



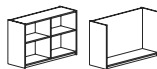
Double Height Wall Mount
Overhead Cabinet and Cubbies
Page VS216



Double Height Wall Mount
Overhead Cabinet w/ Sliding
Doors and Cubbies
Page VS218



Wall Mount Overhead
Shelf
Page VS207 & VS228



Double Height Wall Mount
Overhead Shelf/ Overhead
Page VS211 & VS228



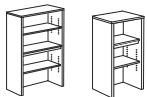
Wall Mount Cubby
Compartments
Page VS232



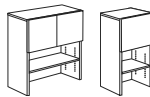
Wall Mount Shelves
Page VS230



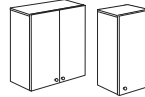
Floating Shelf
Page VS234



Bookcase Overhead
Page VS235



Storage Tower
w/ Doors
Page VS236



Storage Tower
w/ Doors
Page VS237

Accessories



Accessory Rail
Page VS180



Upright Tray
Page VS181



Small Tray
Page VS181



Pencil Tray
Page VS181



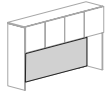
Paper Tray
Page VS181



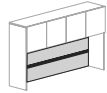
File Hanger
Page VS181

Vision - Overview

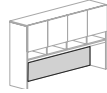
Tackboards/Markerboards



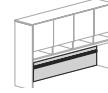
Tackboard for Front of Storage Overhead Cabinet
Pages VS172



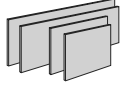
Accessory Rail Tackboard for Storage Overhead Cabinet
Pages VS176



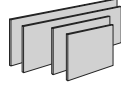
Tackboard for Front of Storage Overhead Cabinet with Cubbies
Pages VS196



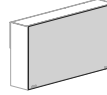
Accessory Rail Tackboard for Storage Overhead Cabinet with Cubbies
Pages VS200



Wall Mount Tackboards for Overhead Cabinets
Pages VS220



Wall Mount Tackboards for Overhead Cabinets with Cubbies
Pages VS223



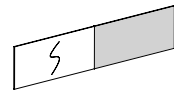
Tackboard for Back of Storage Overhead Cabinet
Pages VS182



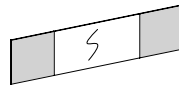
Fabric Back Panel for Storage Tower
Pages VS238



Markerboard for Front of Storage Cabinet or Cubbies
Pages VS241 & VS249

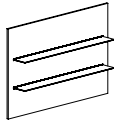


Half Markerboard/Half Tackboard for Front of Storage Cabinet or Cubbies
Pages VS242 & VS250

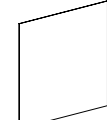


Center Markerboard/Left & Right Tackboard for Front of Storage Cabinet or Cubbies
Pages VS242 & VS254

Wall Panels



Wall Panel with Shelves
Pages VS258



Magnetic Glass Wall Panel
Pages VS274

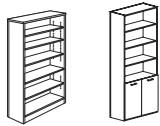


Laminate Markerboard Wall Panel
Pages VS277

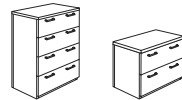


Tackable Wall Panel
Pages VS280

Freestanding Storage & Vertical Storage



Bookcases
Page VS294



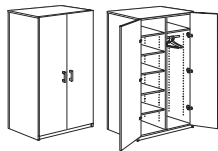
Lateral Files
Page VS296



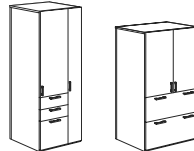
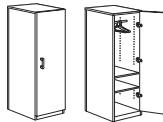
Box/Box/File Mobile Pedestal
Page VS297



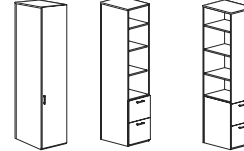
Mobile Lateral File w/Cushion Top
Page VS298



Wardrobes
Page VS299

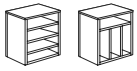


Storage Cabinets
Page VS301



Vision - Overview

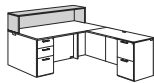
Reception



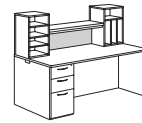
Storage Tower Insert
Page VS312



Transaction Surface
Page VS312

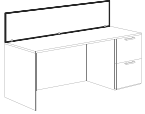


Transaction Counter
Page VS312



Transaction Trim Panel
Page VS313

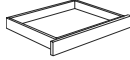
Accessories



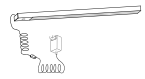
Rectangular Privacy Screen
Page VS314



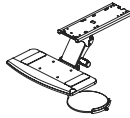
Bench Height Seat Cushions
Page VS315



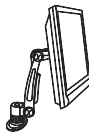
Center Drawer
Page VS108



Tasklight
Page VS318



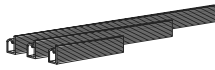
Articulating
Keyboard Tray
Page VS320



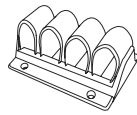
Monitor Support Arm
Page VS321



Vertical Wire Manager
Page VS322



Wire Management Channel
Page VS322

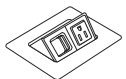


Cable Management Clip
Page VS323



Velcro Straps
Page VS323

Power and Data



Mini Power and
Data Tilt Up
Page VS324



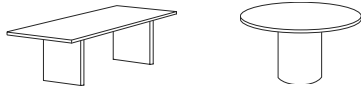
Mini Power Tilt Up
Page VS324



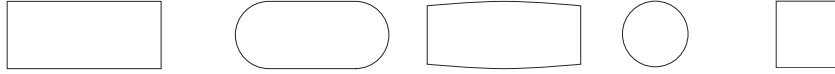
Mini Power and
USB Tilt Up
Page VS324

Vision - Overview

Veneer Conferencing



Conference Tables
Page VS338



Conference Tops
Page VS339



Panel Base
Page VS342

Rectangular Base
Page VS342

Cylinder Base
Page VS342

Half Round Base
Page VS343

Square Base
Page VS343

Cross Base
Page VS343



Buffet Credenza
Page VS344

Wardrobe
Page VS345

Lectern
Page VS349

Visual Board
Page VS349

Laminate Conferencing



Conference Tops
Page VS346



Cylinder Base
Page VS348

Rectangular Base
Page VS348

Ellipse Base
Page VS348



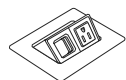
Buffet Credenza
Page VS350

Wardrobe
Page VS351

Lectern
Page VS349

Visual Board
Page VS349

Conference Electrical



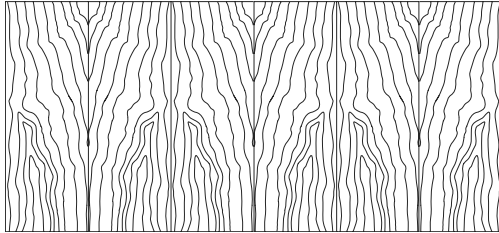
Electrical
Page VS355

Vision Product Information

Veneer

Exterior Wood Materials

Exterior surfaces are made from the finest selected veneers to achieve clarity and consistency in the Vision product line. To attain a pleasing, symmetrical pattern, all cherry, maple, walnut and black oak veneers in Vision are book-matched. All exterior solid lumber is matched to coordinate with the veneer.

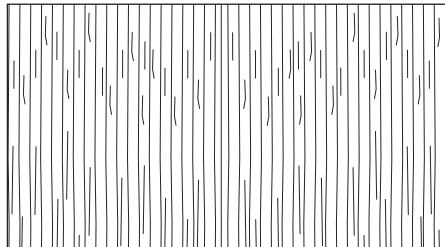


Book-Matched Example

Alternating pieces of veneer are flipped over so they face each other like the pages within a book

Vision is available in flat cut cherry, maple, walnut and black oak veneer. A wide range of wood stains have been formulated to enhance the beauty of the veneer.

Double Cut veneer is another choice on Vision product. This veneer is a processed product that has at least two cuttings to create the final veneers. These cuts of veneer strands are dyed and layered into a block to create variation of patterns from a very tight grain pattern to an exotic figure grain pattern. The diagram below show the tight pattern used on Vision.



WorkSurface Construction

Flat Cut veneer worksurfaces have a 5-ply balanced construction, Double Cut veneer and Coordinating HPL are 3-ply. The tops are 1 3/16" thick with solid matching hardwood edges. Surfaces are available in wood veneer or high pressure laminate. No additional charge for using our coordinating high pressure laminate with a veneer grain pattern with finish wood edges, see page VI3 for available laminate options.

Case Construction

Outside panels are 3/4" and joined together with dowels reinforced with screws, and metal fasteners for increased stability. Tops are secured to the chassis screws through pre-bored stretcher rails and pocket holes.

Cabinet doors have 110° swing hinges to allow adequate access into the interior of the cabinet.

Overhead Construction

Veneer models are unfinished on the back side and fasteners are visible on the back of unit.

Laminate models have visible fasteners on the back of unit.

Finish - Stain/Colors

We offer a variety of wood stains on Vision. Please see the chart below. Samples are available upon request.

CH1 Cherry		<i>Flat Cut Veneer</i>	
BBM	Bourbon Medium	CLL	Collectors
BRM	Brighton Medium	HRV	Harvest
CLA	Classic	PRL	Praline

MA1 Maple		<i>Flat Cut Veneer</i>	
ALM	Ale Medium	FLX	Flax
BUT	Butterscotch	VEN	Venetian

WA1 Walnut		<i>Flat Cut Veneer</i>	
ESP	Espresso	TRF	Truffle
MCH	Mocha	UMB	Umber
SIE	Sienna		

B01 Black Oak		<i>Flat Cut Veneer</i>	
RAV	Raven		

DC1 Double Cut Veneer		<i>Eased Edge Only</i>	
BAR	Barrel - Oak Pattern	KHK	Khaki
BUF	Buff - Oak Pattern	MIN	Mineral - Oak Pattern
CND	Cinder - Oak Pattern	RYE	Rye - Oak Pattern
COF	Coffee	SAB	Sable - Oak Pattern
EGR	Egret - Oak Pattern	SAD	Saddle - Oak Pattern
FAW	Fawn	STU	Studio Teak
GRH	Graphite	VAL	Valley

Protective Top Coat

DuraTex™ offers exceptional hardness along with abrasion and impact resistance, it has been formulated to eliminate hazardous and harmful gases that are normally associated with wood finish.

DuraTex™ Features

Safety - Significantly reduces hazardous formaldehyde emissions which help improve the quality of the of the indoor air we breathe.

Quality - Developed to be tough and durable with special attention to appearance. The DuraTex™ finish preserves the natural beauty of wood.

Durability - Designed to meet a wide range of demanding performance and environmental standards to withstand even the highest wear and tear.

Finish Sheen

All veneer finishes are standard in 35-sheen, with the exception of Raven. Raven is only offered in 15 sheen. All other finishes are available in 15 sheen, see standard modifications page VI40.

Special Finishes

Special finishes can be requested by following the instruction in the general introduction section. There is a one time charge of \$372 list per order.

Wood Species Change

For species changes contact customer service for a quote.

Vision Product Information

Laminates

Vision Laminate features TFL (thermally fused laminate) chassis and components. *Main Worksurfaces** are available in a HPL (high pressure laminate) or in the TFL surface.

Edges of the worksurface are impact resistant (PVC) on TFL and HPL tops. The laminate is offered in 16 wood grain patterns and 5 solid colors. The wood grain laminate features an embossed grain to hide finger prints and light scratches. The solid laminate is smooth to the touch with a semi-matte finish. All Vision Laminate products are indoor-air certified by GreenGuard.

The chart below lists the laminates available on the Vision product.

TFL - HPL Wood Grain Pattern Laminates

ALL Ale Light	MIN Mineral
BOL Bourbon Light	OAT Oatmeal Cookie
BZW Brazilwood	PIN Pinnacle Walnut
BGL Brighton Light	STU Studio Teak
CLL Collectors	UMB Umber
FAW Fawn	VAL Valley
FLO Florence Walnut	VIN Vintage
GRH Graphite	WEA Weathered Ash

TFL - HPL Solid Laminates

ALB Alabaster	DWH Designer White
BLK Black	SHD Shadow
BBL Bridal Blanco	SLG Slate Grey

WorkSurfaces

Laminate worksurfaces have a 3-ply balanced construction. Tops are 1 3/16" thick with coordinating PVC edges. Primary worksurfaces feature 3mm PVC edges on the approach and user sides. Some laminates have a choice of 3 edge profiles, see page VI4. *Main Worksurfaces** are offered in TFL or HPL.

Bridge, return, credenza worksurfaces are profiled with a 3mm PVC edge on the user side only. Remaining edges are banded with 1mm PVC which creates a seamless appearance when units are mated end-to-end or back-to-back.

TFL features on *Main Worksurfaces**

- fused to the 45 pound density substrate of the top for a durable wear resistant surface
- tops are laminated on both sides
- available in all the wood grain and solid patterns

HPL features on *Main Worksurfaces**

- bonded layers create a durable wear resistant surface
- tops are 3-ply balanced construction
- matched to the TFL wood grain and solid patterns

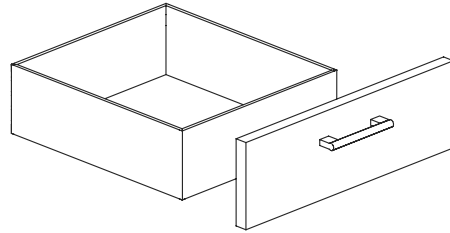
**Main Worksurfaces include tops on desks, standard height credenzas, returns, bridges and transaction tops. Refer to pricing pages to confirm availability.*

Case Construction

Panels for chassis consist of a 3/4" thick substrate with TFL surfaces and PVC bands on exposed edges. Pedestals and cabinets are constructed with dowels reinforced with screws, and metal fasteners for increased stability. Tops are secured to the chassis with screws through pre-bored stretcher rails and pocket holes.

Drawers

The unidirectional V- Fold drawer box is a durable miter-fold drawer structure which is glued and doweled. The 1/2" thick drawer sides are wrapped in a high grade maple vinyl, with an attached front. The drawer front is attached to the four sided box. Optional four corner dovetailed wood drawers are available on veneer units. Specify and add 10% per unit.



Drawer Suspension

High quality black drawer suspension carries a lifetime warranty. File and box drawers have 100% full extension with over travel. Slides feature steel ball bearings for longer wear and positive, cushioned in/out stops.

Filing Hardware

All file drawers are constructed with a custom designed filing system for hanging folders. Filing diagrams on pages VI28-VI34.

Locking

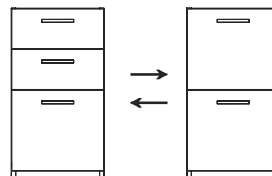
All desks, returns, credenzas, lateral files and storage towers offer optional pedestal front locking to provide maximum security and flexibility in configuration. Up-charge applies.

When locks are ordered, units are shipped randomly keyed. Key alike units are available upon request for no additional charges. Removable cores for in-field re-keying are standard.

Lock Colors: Matte Black (MBK) or Arctic Silver (ASL)

Pedestal Configuration Change

Single pedestal desks have one box/box/file pedestal. Double pedestal desks have a box/box/file pedestal on the left side and file/file pedestal on the right side. Returns are configured with either file/file or box/box/file pedestals. Credenzas are configured with file/file pedestals.



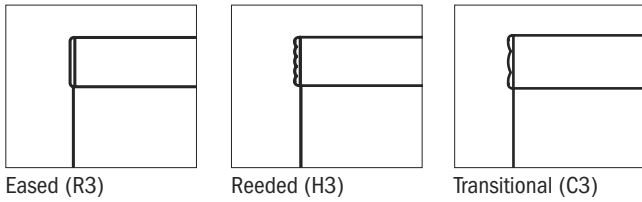
Drawer configurations on fixed height units can be changed from either a box/box/file or a file/file configuration, on units 30" h, but must be specified at the time of order. An additional \$192 upcharge per pedestal needs to be added to the list price of the unit. (*Must keep the same pedestal depth.*)

Special Construction

Vision offers large offering to create many types of configuration. Contact Customer Service if you are having trouble with finding the right units to complete the desired configuration. Requests need to be approved by JSI engineering.

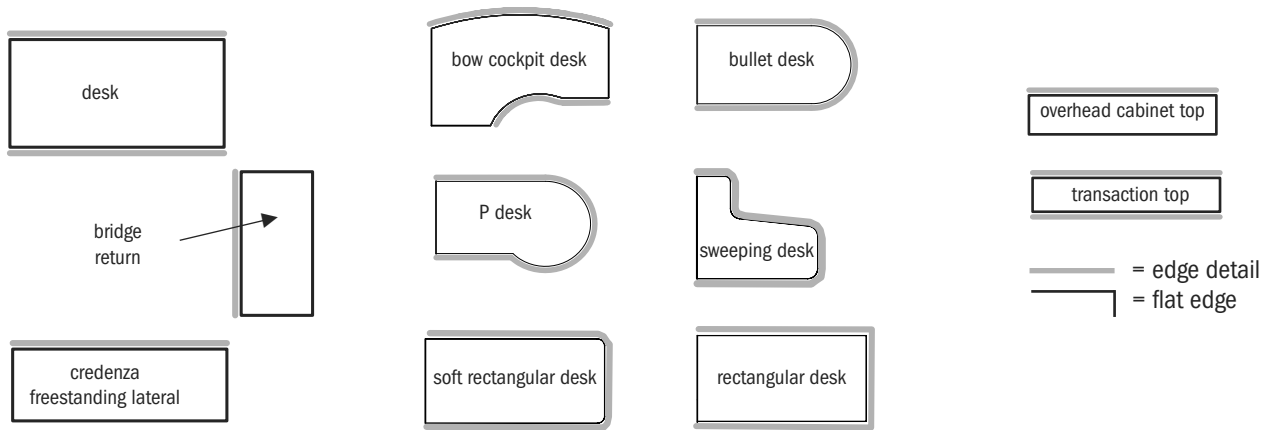
Vision Product Information

Top Edge Profile



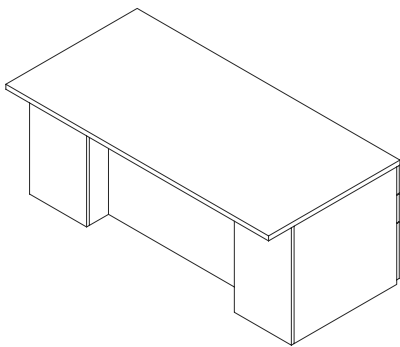
Flat Cut Veneer units are available in all three edges. Double Cut or Laminate units are available only with Eased edge.

Top Edge Detail Location

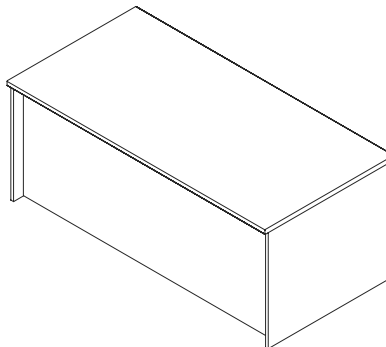


Approach View of Pedestal Desk

Vision offers two distinct approach views for desks. Specify a model with either a break front modesty or a recessed modesty. Desk model numbers ending in "F" have the full recessed modesty panel.



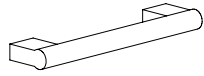
Break Front (model # **VST3672DD**)



Recessed Front Modesty (model # **VST3672DDF**)

Vision Product Information

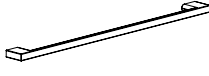
Pull Style and Color Options



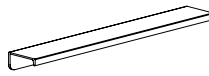
Bar
Matte Black (MBK)
Polished Nickel (PNK)



Sweep
Matte Black (MBK)
Matte Nickel (MNK)



Delve
Matte Black (MBK)
Arctic Silver (ASL)
Pewter (PEW)
Soft Nickel (SNK)
Soft Bronze (SBZ)
Aged Bronze (ABZ)
Gold (GLD)
Chrome (CHR)



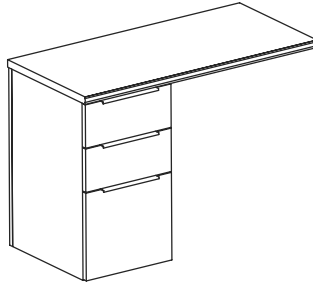
Prospect
Matte Black (MBK)
Arctic Silver (ASL)
Pewter (PEW)
Soft Nickel (SNK)
Soft Bronze (SBZ)
Aged Bronze (ABZ)
Gold (GLD)

Pull Placement

Bar, Sweep and Delve pulls are mounted on the front of drawer/door. Prospect pull overlays the top of the drawer and door front.



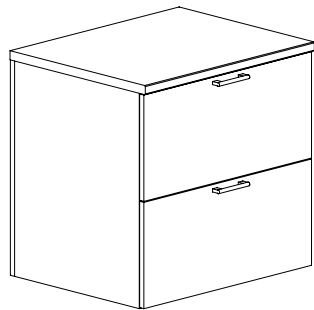
Standard Pull Placement
Bar



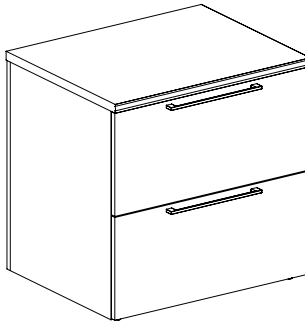
Prospect

Pull Alignment

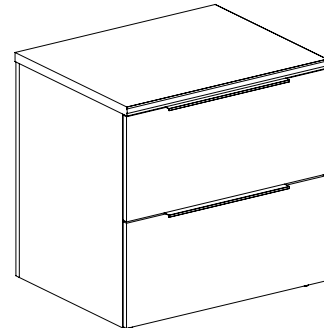
Bar and Sweep pulls are standard in one length for every application. Delve and Prospect pulls offer an enhanced aesthetic on lateral files and vertical storage, replacing one or two standard pulls with an elongated version. In these cases, the longer pull is used in appropriate application - user need not specify.



Bar and Sweep Pull
(Bar shown)



Delve

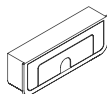


Prospect

Vision Product Information

Chassis End/Back Panel Grommet

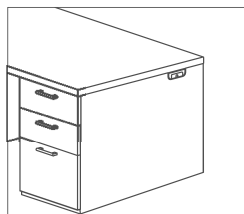
Chassis grommets, consisting of back and end panels, are available in Matte Black (MBK) or Arctic Silver (ASL). Due to the nature of wire management, grommets are selected for the complete chassis. Upcharge varies per model and is indicated on pricing pages.



Matte Black (MBK)
Arctic Silver (ASL)

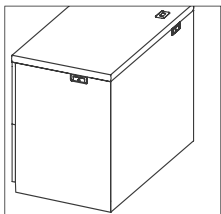
Chassis Grommet Locations

Vision offers optional grommets for wiring to pass thru the unit.



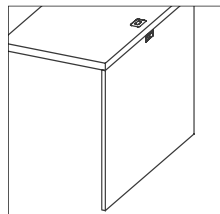
Desks - Credenza

End Panel Grommet



Returns

Work Surface Grommet
End Panel Grommet
Back Panel Grommet

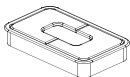


Bridge

Work Surface Grommet
Back Panel Grommet

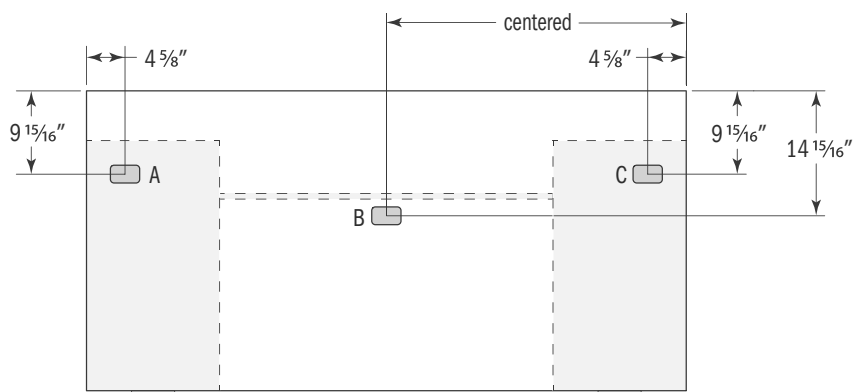
Worksurface Grommet

Standard worksurface grommet are indicated on specific model add \$51 list per location. For custom locations, contact customer service for approval of location and add \$114 list per location.



Matte Black (MBK)
Arctic Silver (ASL)

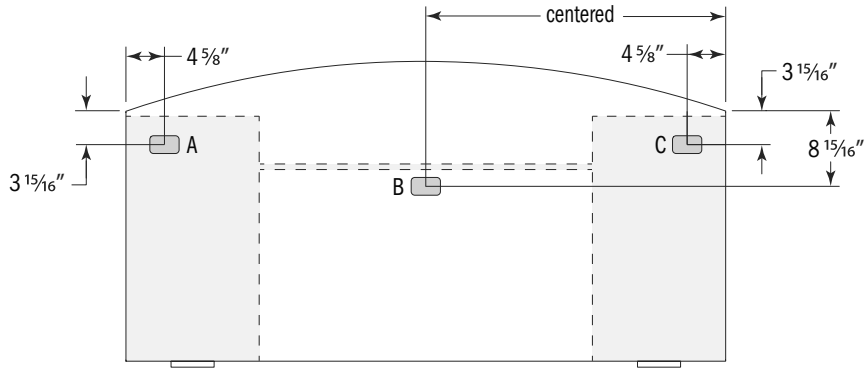
Standard Worksurface Grommet Locations



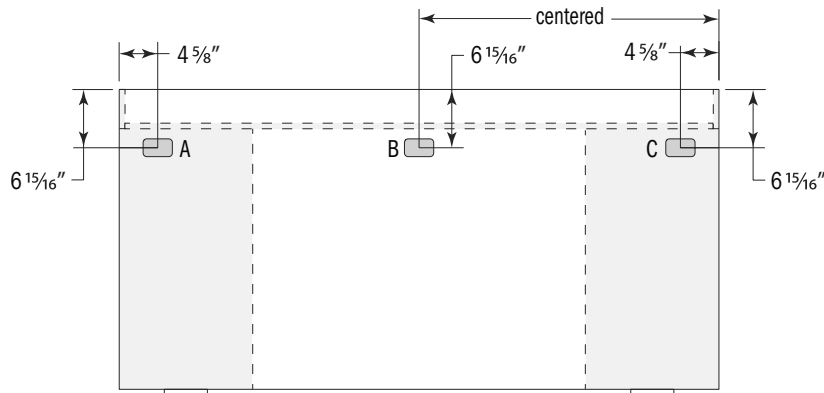
Desks with Overhangs

Vision Product Information

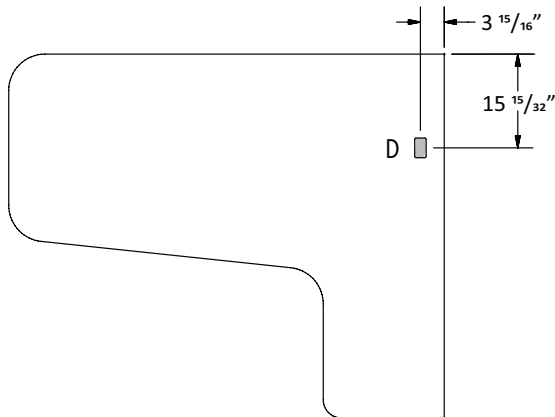
Worksurface Grommet Locations (continued)



Desks without Overhangs (Bow Front Shown)



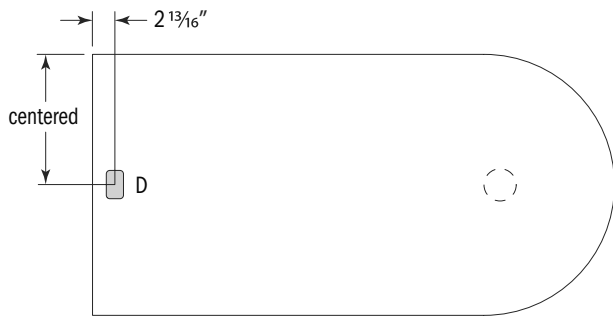
Desks with Recessed Modesty



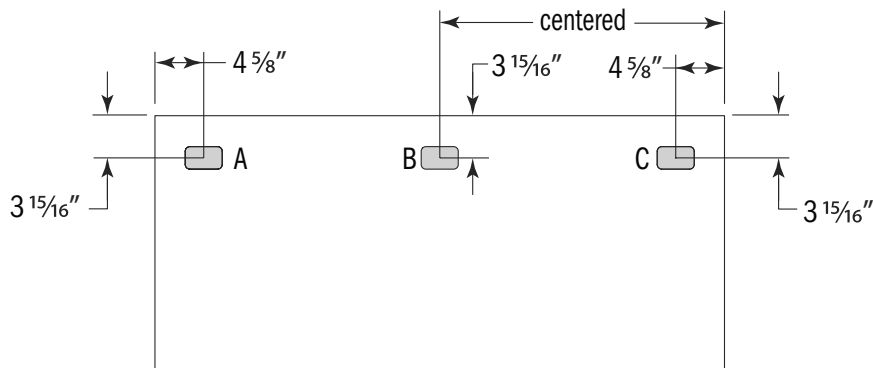
Sweeping L Desk
left shown

Vision Product Information

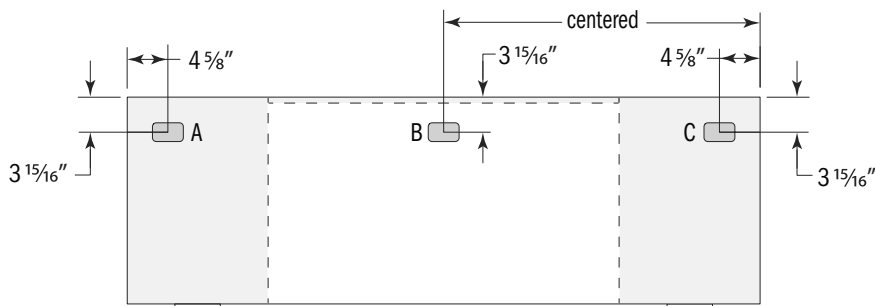
Worksurface Grommet Locations (continued)



Support End and Run-Off Desks



Bridges and Returns



Credenzas

Vision Product Information

Wire Management

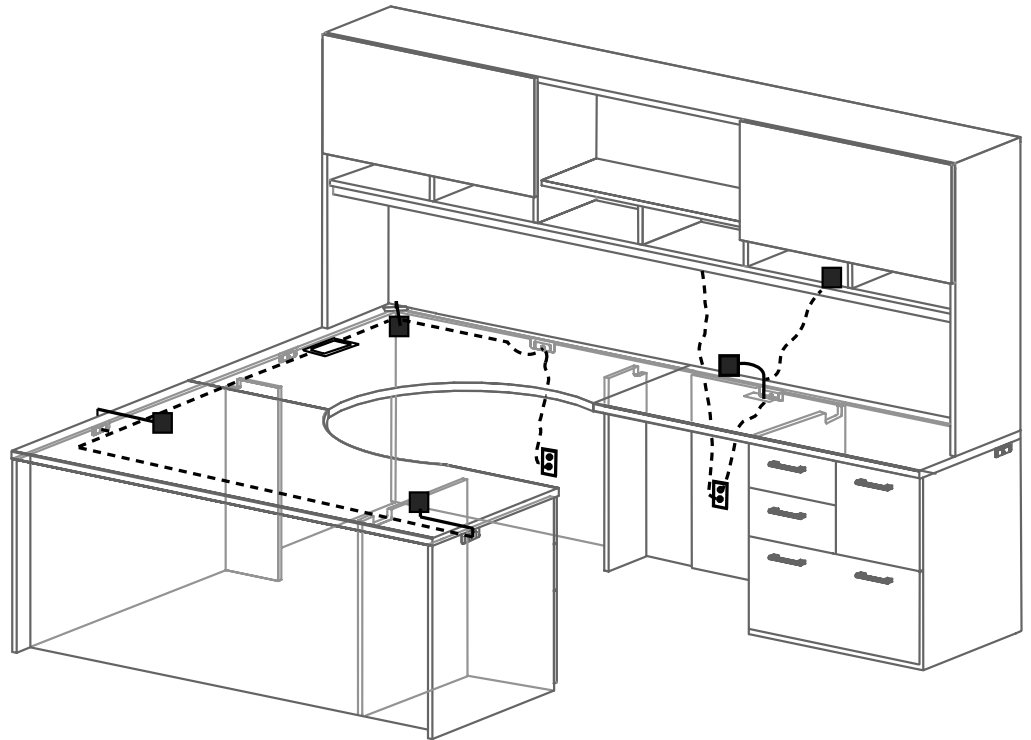
Wiring can move freely from unit to unit and out to the building power/data through numerous grommet options.

Optional top grommets are offered in key locations on desks, bridges, returns, credenzas and corner units.

Pedestal desks, credenzas, corners units, bridge panels, return modesty panels and end panels offer optional chassis grommets.

The end panel grommet opening is 4" wide by 1 7/16" high with a bezel trim secured to the panel with a friction side cap.

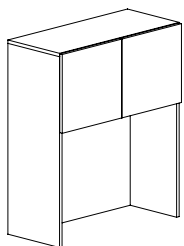
Refer to the accessory section for additional technology and accessory items. (see page [VS322](#))



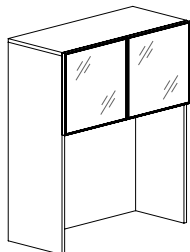
Vision Product Information

Overhead Cabinets, Storage Towers and Wall Mounted Cabinet Door Style

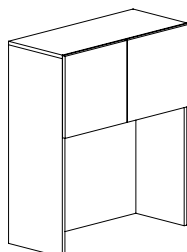
Vision overhead cabinets, storage towers and wall mounted cabinet doors can be specified in laminate door, laminate with aluminum frame glass door, veneer door, veneer aluminum frame glass door, and veneer wood frame glass door.



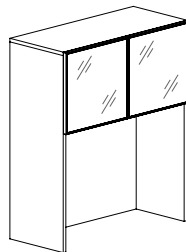
Laminate Cabinet with Laminate Door



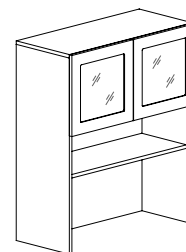
Laminate Cabinet with Aluminum Frame Glass Door



Flat Cut or Double Cut Cabinet with Flat Cut or Double Cut Veneer Door

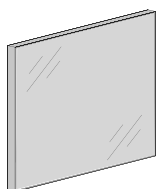


Flat Cut or Double Cut Cabinet with Aluminum Frame Glass Door



Flat Cut or Double Cut Cabinet with Wood Frame Glass Door

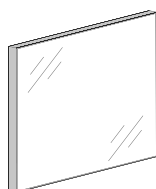
Door Options for Overhead Cabinets, Storage Towers and Wall Mounted Cabinets



Frosted

Aluminum Frame
(Frosted glass with acid etched back)

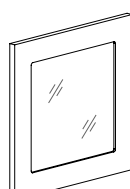
locking not available



White Back Painted

Aluminum Frame
(Glossy low iron white back painted glass)

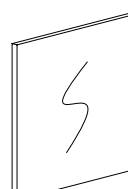
locking not available



Wood Frame

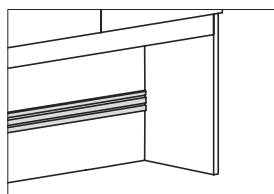
Clear Glass

locking not available



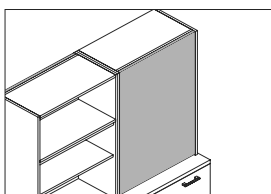
Markerboard

Product Features and Options



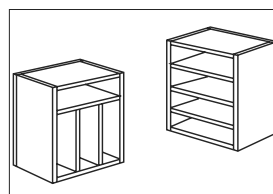
Aluminum Accessory Rail

- Anodized Aluminum finish
- Accessory Tools
 - Upright Tray
 - Small Tray
 - Pencil Tray
 - Paper Tray
 - File Hanger



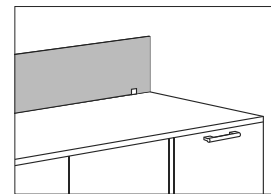
Fabric Back Panel

- excellent solution for open plan or room dividers
- tackable surface
- COM or JSI fabric program available



Paper Sorters

- Can provide support for transaction workspaces
- Use under overhead cabinet storage overhead cabinets without cubbies
- Field configured - horizontal shelf and vertical shelves or all horizontal shelves



Privacy Screens

- Mounts to the top of the worksurface
- Acrylic Panel - Frosted
- Attachment hardware is included
- Field installed

Vision Product Information

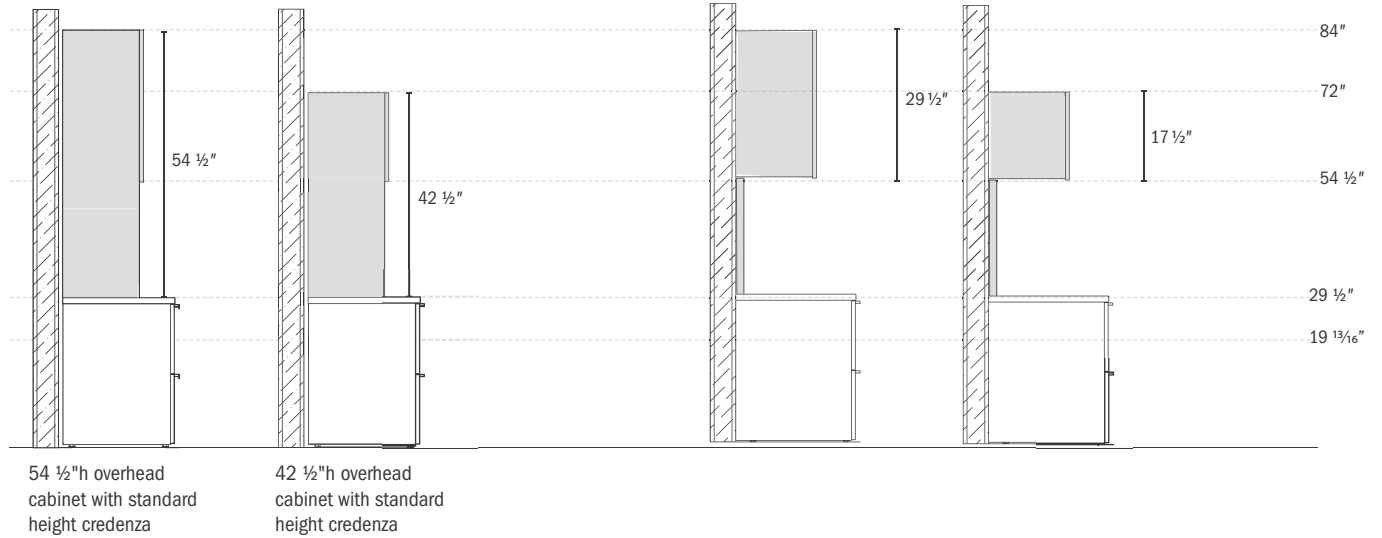
Overhead Cabinets + Wall Mount Overheads

Product Overview

Vision overhead cabinets, wall mount overheads and wall panels, when combined with lower storage, create an overall height of 72" or 84". Overhead cabinets are available in two heights: 42 1/2" or 54 1/2". Wall mount overheads are available in two heights: 17 1/2" or 29 1/2".

Overhead Cabinets (side view)

Wall Mount Overheads (side view)



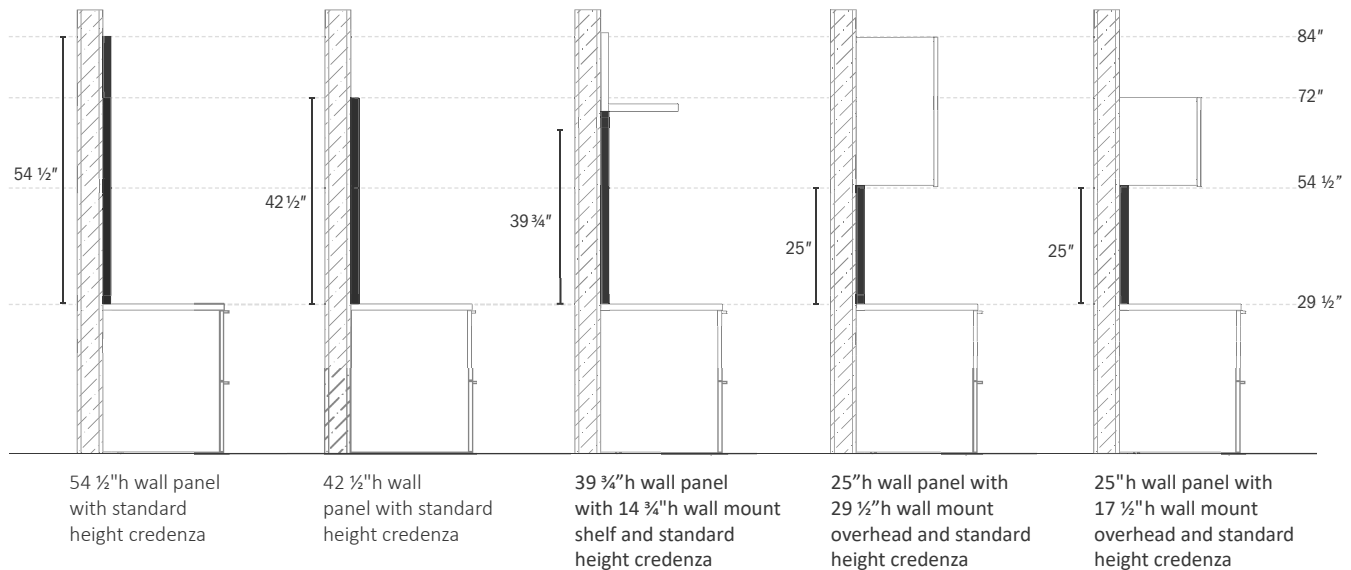
Vision Product Information

Wall Panel Stack-ups

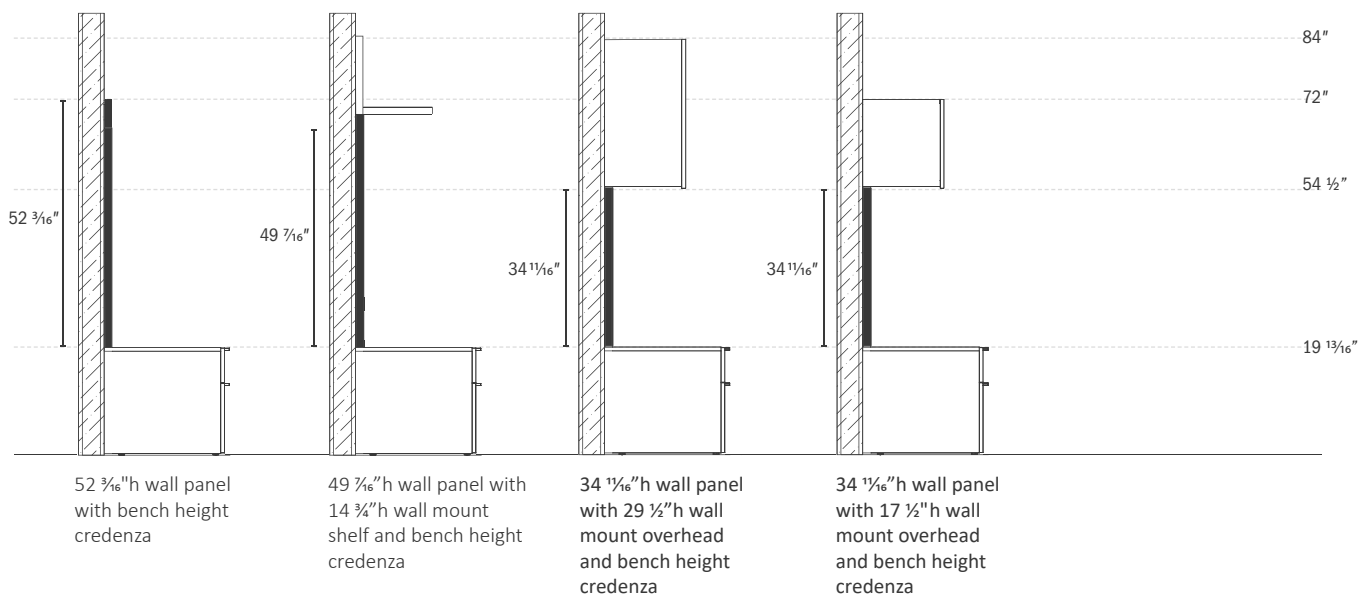
Product Overview

Vision overhead cabinets, wall mount overheads and wall panels, when combined with lower storage, create an overall height of 72" or 84". Wall panels are available in seven heights to accommodate various combinations of use to create the overall height of 72" or 84". Wall panels are offered in laminate, veneer, tackboard, markerboard, and magnetic glass materials.

Wall Panels with Standard Height Credenza (side view)



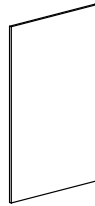
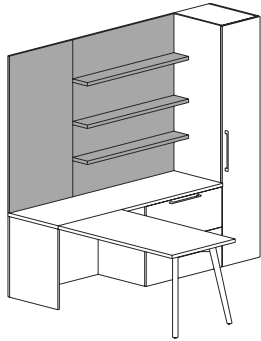
Wall Panels with Bench Height Credenza (side view)



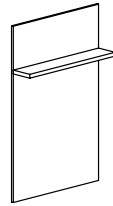
Vision Product Information

Wall Panel Shelf Options - Veneer, Laminate or Glass

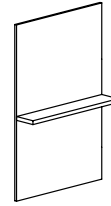
54 1/2" h



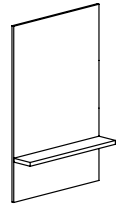
A
No Shelf



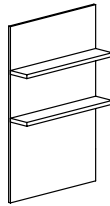
B
Shelf at 69 1/4"



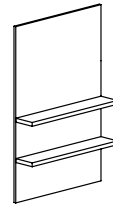
F
Shelf at 54 1/2"



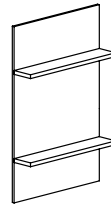
C
Shelf at 42"



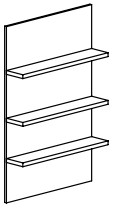
G
Shelf at 69 1/4"
Shelf at 54 1/2"



H
Shelf at 54 1/2"
Shelf at 42"



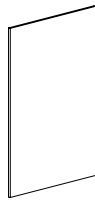
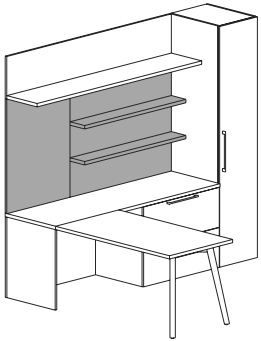
D
Shelf at 69 1/4"
Shelf at 42"



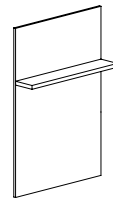
E
Shelf at 69 1/4"
Shelf at 54 1/2"
Shelf at 42"

shelf dimensions are from the floor

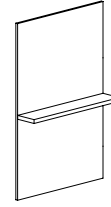
52 3/8" h, 49 1/8" h, 42 1/2" h and 39 3/4" h



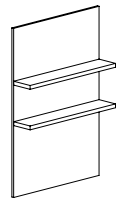
A
No Shelf



B
Shelf at 54 1/2"



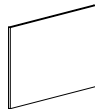
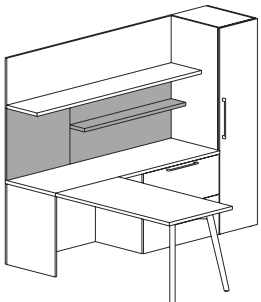
C
Shelf at 42"



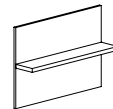
D
Shelf at 54 1/2"
Shelf at 42"

shelf dimensions are from the floor

34 1/8" h and 25" h



A
No Shelf



B
Shelf at 42"

Vision Product Information

Wall Panel Ship Weights

Ship weight listed on product pages VS264- VS279 calls out the maximum weight for the most that could be used per model. Listed below are the exact weight per shelf configuration.

Ship Weights for Wall Panels				
Model	No Shelves	1 Shelf	2 Shelves	3 Shelves
54" h Wall Panels with Veneer/Laminate Shelves				
VSV1854WP / VST1854WP	25	29	33	37
VSV2454WP / VST2454WP	32	38	44	50
VSV3054WP / VST3054WP	39	46	53	60
VSV3354WP / VST3354WP	42	50	58	66
VSV3654WP / VST3654WP	45	54	63	72
VSV3954WP / VST3954WP	48	58	68	78
VSV4254WP / VST4254WP	51	62	73	84
VSV4854WP / VST4854WP	58	70	82	94
VSV5454WP / VST5454WP	65	79	93	107
VSV6054WP / VST6054WP	72	87	102	117
53" h Wall Panels with Veneer/Laminate Shelves				
VSV1853WP / VST1853WP	23	27	31	
VSV2453WP / VST2453WP	30	36	42	
VSV3053WP / VST3053WP	37	44	51	
VSV3353WP / VST3353WP	40	48	56	
VSV3653WP / VST3653WP	43	52	61	
VSV3953WP / VST3953WP	46	56	66	
VSV4253WP / VST4253WP	49	60	71	
VSV4853WP / VST4853WP	56	68	80	
VSV5453WP / VST5453WP	63	77	91	
VSV6053WP / VST6053WP	70	85	100	
50" h Wall Panels with Veneer/Laminate Shelves				
VSV1850WP / VST1850WP	21	25	29	
VSV2450WP / VST2450WP	28	34	40	
VSV3050WP / VST3050WP	35	42	49	
VSV3350WP / VST3350WP	38	46	54	
VSV3650WP / VST3650WP	41	50	59	
VSV3950WP / VST3950WP	44	54	64	
VSV4250WP / VST4250WP	47	58	69	
VSV4850WP / VST4850WP	54	66	78	
VSV5450WP / VST5450WP	61	75	89	
VSV6050WP / VST6050WP	68	83	98	
42" h Wall Panels with Veneer/Laminate Shelves				
VSV1842WP / VST1842WP	19	24	29	
VSV2442WP / VST2442WP	25	31	37	
VSV3042WP / VST3042WP	30	38	46	
VSV3342WP / VST3342WP	33	41	49	
VSV3642WP / VST3642WP	36	45	54	
VSV3942WP / VST3942WP	39	48	56	
VSV4242WP / VST4242WP	42	51	60	
VSV4842WP / VST4842WP	47	59	70	
VSV5442WP / VST5442WP	53	64	78	
VSV6042WP / VST6042WP	59	73	87	

Ship Weights for Wall Panels			
Model	No Shelves	1 Shelf	2 Shelves
40" h Wall Panels with Veneer/Laminate Shelves			
VSV1840WP / VST1840WP	18	23	28
VSV2440WP / VST2440WP	23	29	35
VSV3040WP / VST3040WP	29	36	43
VSV3340WP / VST3340WP	31	39	47
VSV3640WP / VST3640WP	34	43	52
VSV3940WP / VST3940WP	37	46	55
VSV4240WP / VST4240WP	39	49	59
VSV4840WP / VST4840WP	44	56	68
VSV5440WP / VST5440WP	50	62	74
VSV6040WP / VST6040WP	55	67	79
35" h Wall Panels with Veneer/Laminate Shelves			
VSV1835WP / VST1835WP	16	21	
VSV2435WP / VST2435WP	21	27	
VSV3035WP / VST3035WP	25	33	
VSV3335WP / VST3335WP	28	36	
VSV3635WP / VST3635WP	30	38	
VSV3935WP / VST3935WP	32	42	
VSV4235WP / VST4235WP	35	45	
VSV4835WP / VST4835WP	40	50	
VSV5435WP / VST5435WP	44	56	
VSV6035WP / VST6035WP	48	62	
25" h Wall Panels with Veneer/Laminate Shelves			
VSV1825WP / VST1825WP	13	17	
VSV2425WP / VST2425WP	16	22	
VSV3025WP / VST3025WP	19	27	
VSV3325WP / VST3325WP	21	29	
VSV3625WP / VST3625WP	23	31	
VSV3925WP / VST3925WP	25	33	
VSV4225WP / VST4225WP	27	35	
VSV4825WP / VST4825WP	29	40	
VSV5425WP / VST5425WP	33	45	
VSV6025WP / VST6025WP	37	50	

Vision Product Information

Wall Panel Ship Weights

Ship weight listed on product pages VS264- VS279 calls out the maximum weight for the most that could be used per model. Listed below are the exact weight per shelf configuration.

Model	Ship Weights for Wall Panels		
	1 Shelf	2 Shelves	3 Shelves
54" h Wall Panels with Glass Shelves			
VSV1854WPGS / VST1854WPGS	28	31	34
VSV2454WPGS / VST2454WPGS	36	40	44
VSV3054WPGS / VST3054WPGS	44	49	54
VSV3354WPGS / VST3354WPGS	47	52	57
VSV3654WPGS / VST3654WPGS	51	57	63
VSV3954WPGS / VST3954WPGS	54	60	66
VSV4254WPGS / VST4254WPGS	58	65	72
VSV4854WPGS / VST4854WPGS	66	74	82
VSV5454WPGS / VST5454WPGS	74	83	92
VSV6054WPGS / VST6054WPGS	82	92	102
53" h Wall Panels with Glass Shelves			
VSV1853WPGS / VST1853WPGS	26	29	
VSV2453WPGS / VST2453WPGS	34	38	
VSV3053WPGS / VST3053WPGS	42	47	
VSV3353WPGS / VST3353WPGS	45	50	
VSV3653WPGS / VST3653WPGS	49	55	
VSV3953WPGS / VST3953WPGS	52	58	
VSV4253WPGS / VST4253WPGS	56	63	
VSV4853WPGS / VST4853WPGS	64	72	
VSV5453WPGS / VST5453WPGS	72	81	
VSV6053WPGS / VST6053WPGS	80	90	
50" h Wall Panels with Glass Shelves			
VSV1850WPGS / VST1850WPGS	24	27	
VSV2450WPGS / VST2450WPGS	32	36	
VSV3050WPGS / VST3050WPGS	40	45	
VSV3350WPGS / VST3350WPGS	43	48	
VSV3650WPGS / VST3650WPGS	47	53	
VSV3950WPGS / VST3950WPGS	50	56	
VSV4250WPGS / VST4250WPGS	54	61	
VSV4850WPGS / VST4850WPGS	62	70	
VSV5450WPGS / VST5450WPGS	70	79	
VSV6050WPGS / VST6050WPGS	78	88	
42" h Wall Panels with Glass Shelves			
VSV1842WPGS / VST1842WPGS	22	25	
VSV2442WPGS / VST2442WPGS	29	33	
VSV3042WPGS / VST3042WPGS	35	40	
VSV3342WPGS / VST3342WPGS	38	43	
VSV3642WPGS / VST3642WPGS	42	48	
VSV3942WPGS / VST3942WPGS	45	51	
VSV4242WPGS / VST4242WPGS	49	56	
VSV4842WPGS / VST4842WPGS	55	63	
VSV5442WPGS / VST5442WPGS	62	71	
VSV6042WPGS / VST6042WPGS	69	79	

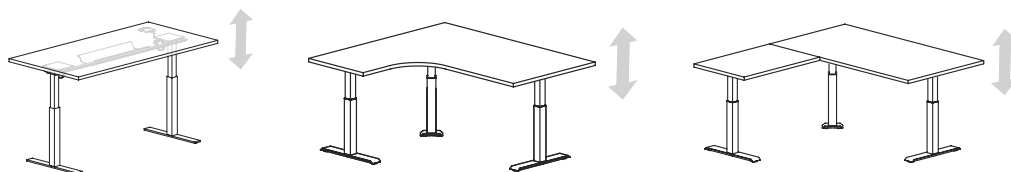
Model	Ship Weights for Wall Panels	
	1 Shelf	2 Shelves
40" h Wall Panels with Glass Shelves		
VSV1840WPGS / VST1840WPGS	21	24
VSV2440WPGS / VST2440WPGS	27	31
VSV3040WPGS / VST3040WPGS	34	39
VSV3340WPGS / VST3340WPGS	36	41
VSV3640WPGS / VST3640WPGS	40	46
VSV3940WPGS / VST3940WPGS	43	49
VSV4240WPGS / VST4240WPGS	46	53
VSV4840WPGS / VST4840WPGS	52	60
VSV5440WPGS / VST5440WPGS	59	68
VSV6040WPGS / VST6040WPGS	65	75
35" h Wall Panels with Glass Shelf		
VSV1835WPGS / VST1835WPGS	19	
VSV2435WPGS / VST2435WPGS	25	
VSV3035WPGS / VST3035WPGS	30	
VSV3335WPGS / VST3335WPGS	33	
VSV3635WPGS / VST3635WPGS	36	
VSV3935WPGS / VST3935WPGS	38	
VSV4235WPGS / VST4235WPGS	42	
VSV4835WPGS / VST4835WPGS	48	
VSV5435WPGS / VST5435WPGS	53	
VSV6035WPGS / VST6035WPGS	58	
25" h Wall Panels with Glass Shelf		
VSV1825WPGS / VST1825WPGS	16	
VSV2425WPGS / VST2425WPGS	20	
VSV3025WPGS / VST3025WPGS	24	
VSV3325WPGS / VST3325WPGS	26	
VSV3625WPGS / VST3625WPGS	29	
VSV3925WPGS / VST3925WPGS	31	
VSV4225WPGS / VST4225WPGS	34	
VSV4825WPGS / VST4825WPGS	37	
VSV5425WPGS / VST5425WPGS	42	
VSV6025WPGS / VST6025WPGS	47	

Vision Product Information

Vision integrates height adjustability into the workplace environment in multiple ways to meet the unique needs of the customer. Here is an overview of the most popular ways.

Adjustable Height T-Base Table Desks

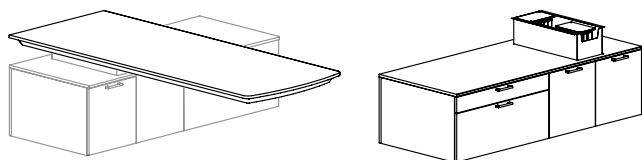
Tables with exposed telescoping legs is offered in Standard and Extended Range with electrical units. Select units also offer Pneumatic.



See Page [VS2-VS32](#)

Adjustable Height Cantilever

Creates a statement piece when using the Cantilevered Table and Support Credenza together.

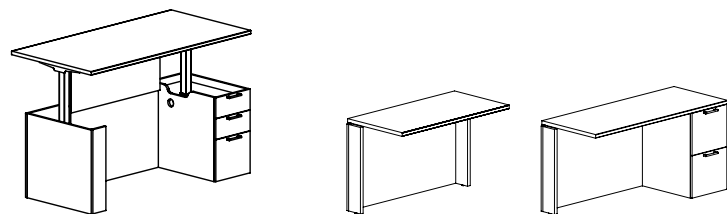


See Page [VS34](#)

Use with Cantilever Support Credenza
See Page [VS34](#)

Adjustable Height Single Pedestal Desk

Single pedestal adjustable desks can be used with companion fixed bridge or return to eliminate pinch points.

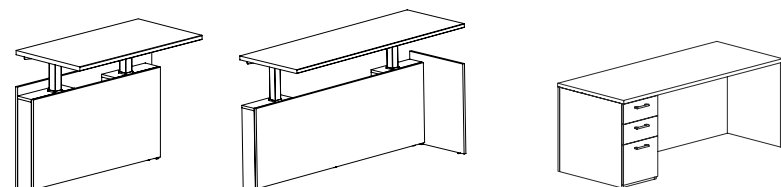


See Page [VS37-VS39](#)

Use with Fixed Bridge or Return
See Page [VS54-VS56](#)

Adjustable Height Bridge and Return

For applications when desk is stationary and height adjustability is needed on the bridge or return. Units created to eliminate pinch points.



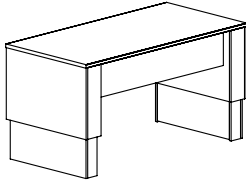
See Page [VS49-VS50](#)

Use with Fixed Height Desk
See Page [VS63-VS68](#)

Vision Product Information

Adjustable Height Desk

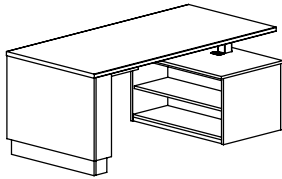
Stand alone height adjustable table encapsulates mechanism within end panels.



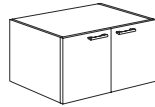
With Telescoping End Panels
See Page [VS35](#)

Adjustable Height Peninsula Desk

Use with bench height configurations for smaller footprints when adjustability needed at desk.



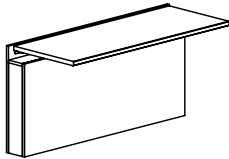
With Telescoping End Panel and Credenza
See Page [VS51](#)



Use with Bench Height Configurations
See Page [VS133](#)

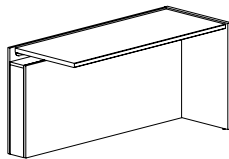
Use with workwall peninsula desk for height adjustability on bridge or return.

Adjustable Height Workwall Bridge



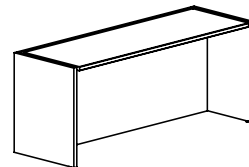
See Page [VS56](#)

Adjustable Height Workwall Return



See Page [VS57](#)

Adjustable Height Workwall Credenza

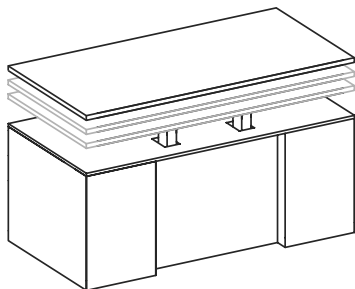


See Page [VS53](#)

Vision Product Information

ERGO Adjustable Work Height Mechanism

Our proprietary adjustable work height mechanism can be specified on many of the models in Vision. ERGO can only be specified in a HPL (high pressured laminate) or Veneer.



ERGO mechanism allows height adjustability to be added to the worksurface. Our solution uses a standardized design that minimizes the modifications required to standard desk, bridge, or credenza models. The mechanism and control box are neatly concealed to maintain the appearance of the original elegance of the product. A push button activates the electric powered lifting columns for adjustability from sitting height to a standing height. A ¾" thick finished sub top is added to the top of the desk chassis for a clean appearance when the surface is in the raised position. In the lowered position, please note that ERGO adds ¾" to the standard height of the desk and the installation will decrease knee space depth by 8".

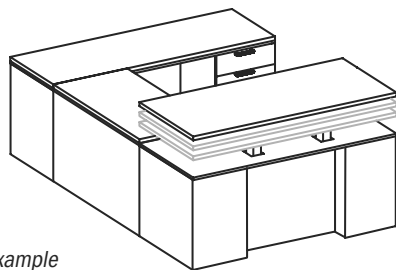
Automatic Collision Control is built in to each mechanism as a standard feature. When the system senses an obstacle obstructing the movement, the mechanism will reverse direction and retreat by 1".

When ERGO is added to a worksurface in an "L" or "U" group, all units in the configuration need to have a sub top added. These units are considered to be ERGO ADJACENT units. ERGO ADJACENT units must have a fixed height worksurface that matches the lowest position of the ERGO mechanism and the top. This is accomplished by adding a ¾" sub top between the chassis and the worksurface. This feature can also be specified for cabinets which may sit next to a unit with the ERGO mechanism.

Height adjustment starts at 30 ¾", to a standing height of 49 ¾", a range of 19 ½".

NOTE: The kneespace depth is decreased when the ERGO mechanism is specified. Contact Customer Service for dimension information.

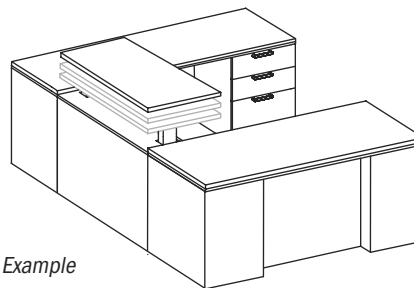
The Ergo mechanism and controls are warranted for a period of (1) year. The rest of the casegood unit(s) are warranted under the Lifetime Warranty.



Example

VST3672LD (with ERGO option) add \$4,328 to list
 VST2448EB (with ERGO ADJACENT option) add \$465 to list
 VST2472RC (with ERGO ADJACENT option) add \$569 to list

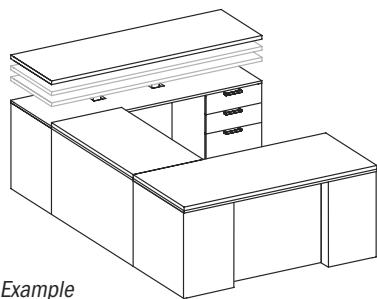
VSV3672LD (with ERGO option) add \$4,835 to list
 VSV2448EB (with ERGO ADJACENT option) add \$606 to list
 VSV2472RC (with ERGO ADJACENT option) add \$711 to list



Example

VST3672LD (with ERGO ADJACENT option) add \$569 to list
 VST2448EB (with ERGO option) add \$4,328 to list
 VST2472RC (with ERGO ADJACENT option) add \$569 to list

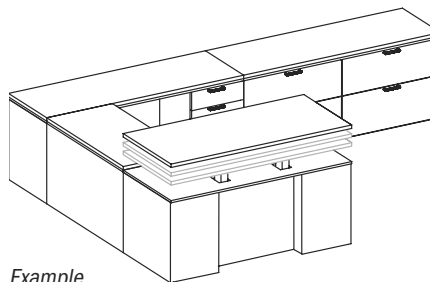
VSV3672LD (with ERGO ADJACENT option) add \$711 to list
 VSV2448E (with ERGO option) add \$4,835 to list
 VSV2472RC (with ERGO ADJACENT option) add \$711 to list



Example

VST3672LD (with ERGO ADJACENT option) add \$569 to list
 VST2448EB (with ERGO ADJACENT option) add \$465 to list
 VST2472RC (with ERGO option) add \$4,328 to list

VSV3672LD (with ERGO ADJACENT option) add \$711 to list
 VSV2448EB (with ERGO ADJACENT option) add \$606 to list
 VSV2472RC (with ERGO option) add \$4,835 to list



Example

VST3672LD (with ERGO option) add \$4,328 to list
 VST2448EB (with ERGO ADJACENT option) add \$465 to list
 VST2472RC (with ERGO ADJACENT option) add \$569 to list
 VST2472LFC (with ERGO ADJACENT option) add \$569 to list

VSV3672LD (with ERGO option) add \$4,835 to list
 VSV2448EB (with ERGO ADJACENT option) add \$606 to list
 VSV2472RC (with ERGO ADJACENT option) add \$711 to list
 VSV2472LFC (with ERGO ADJACENT option) add \$711 to list

Vision Product Information

Availability of Vision HPL Laminate or Veneer Units with the ERGO Mechanism

The following models are available, in HPL or Veneer, with the ERGO Adjustable Work Height Mechanism.

Freestanding Units - Units below do not require adjacent products; select ERGO option for HPL Laminate add \$4,328 or Veneer add \$4,835 to the list price.

Double Pedestal Desks		Credenzas		Shell Desks
VST3060DD	VST3672DDF	VST2060KC	VST2460KC	VST3060SHDF
VSV3060DD	VSV3672DDF	VSV2060KC	VSV2460KC	VSV3060SHDF
VST3060DDF	VST3678DD	VST2066KC	VST2466KC	VST3066SHDF
VSV3060DDF	VSV3678DD	VSV2066KC	VSV2466KC	VSV3066SHDF
VST3066DD	VST3678DDF	VST2072KC	VST2472KC	VST3072SHDF
VSV3066DD	VSV3678DDF	VSV2072KC	VSV2472KC	VSV3072SHDF
VST3066DDF	VST3684BD	VST2078KC	VST2478KC	VST3672SHDF
VSV3066DDF	VSV3684BD	VSV2078KC	VSV2478KC	VSV3672SHDF
VST3072DD	VST3684BDF	VST2084KC	VST2484KC	
VSV3072DD	VSV3684BDF	VSV2084KC	VSV2484KC	
VST3072DDF	VST3684DD			
VSV3072DDF	VSV3684DD			
VST3672BD	VST3684DDF			
VSV3672BD	VSV3684DDF			
VST3672BDF	VST4272BD			
VSV3672BDF	VSV4272BD			
VST3672DD	VST4272BDF			
VSV3672DD	VSV4272BDF			

ERGO Adjacent Connecting Units - Select ERGO option for the model you wish to have height adjustment for HPL Laminate add \$4,328 or Veneer add \$4,835 to the list price. For units, from this list, that are connecting to the ERGO model, you must select ERGO ADJACENT on each of these connecting laminate models add \$569 and veneer add \$711 list price. *If the connecting model is 24" x 48" or less for laminate add \$465 list or veneer add \$606.

Single Pedestal Desks		Returns			Credenzas		Bridges	Corner Units
VST3066LD	VST3684LD	VST2042ELR*	VST2442ERCR*	VST2460LRR	VST2060LC*	VST2460LC	VST2036EB*	VST4242-20ECU
VSV3066LD	VSV3684LD	VSV2042ELR*	VSV2442ERCR*	VSV2460LRR	VSV2060LC*	VSV2460LC	VSV2036EB*	VSV4242-20ECU
VST3066LDF	VST3684LDF	VST2042ELY*	VST2442ERCY*	VST2460LLR	VST2060RC*	VST2460RC	VST2042EB*	VST4242-24ECU
VSV3066LDF	VSV3684LDF	VSV2042ELY*	VSV2442ERCY*	VSV2460LLR	VSV2060RC*	VSV2460RC	VSV2042EB*	VSV4242-24ECU
VST3066RD	VST3684RBD	VST2042ELR*	VST2442ERR*	VST2454LRR	VST2066LC*	VST2466LC	VST2048EB*	VST4852ERC*
VSV3066RD	VSV3684RBD	VSV2042ELR*	VSV2442ERR*	VSV2454LRR	VSV2066LC*	VSV2466LC	VSV2048EB*	VSV4852ERC*
VST3066RDF	VST3684RDF	VST2042ERY*	VST2442ERY*	VST2454LLR	VST2066RC*	VST2466RC	VST2436EB*	VST4852ELCU
VSV3066RDF	VSV3684RDF	VSV2042ERY*	VSV2442ERY*	VSV2454LLR	VSV2066RC*	VSV2466RC	VSV2436EB*	VSV4852ELCU
VST3072LD	VST3684RD	VST2048ELR*	VST2448ELCR*	VST2448LRR	VST2072LC*	VST2472LC	VST2442EB*	
VSV3072LD	VSV3684RD	VSV2048ELR*	VSV2448ELCR*	VSV2448LRR	VSV2072LC*	VSV2472LC	VSV2442EB*	
VST3072LDF	VST3684RDF	VST2048ELY*	VST2448ELCY*	VST2448LLR	VST2072RC*	VST2472RC	VST2448EB*	
VSV3072LDF	VSV3684RDF	VSV2048ELY*	VSV2448ELCY*	VSV2448LLR	VST2072RC*	VSV2472RC	VSV2448EB*	
VST3072RD	VST4272CLD	VST2048ERR*	VST2448ELR*	VST2060LRR*	VST2078LC*	VST2478LC		
VSV3072RD	VSV4272CLD	VSV2048ERR*	VSV2448ELR*	VSV2060LRR*	VSV2078LC*	VSV2478LC		
VST3072RDF	VST4272CLDF	VST2048ERY*	VST2448ELY*	VST2060LLR*	VST2078RC*	VST2478RC		
VSV3072RDF	VSV4272CLDF	VSV2048ERY*	VSV2448ELY*	VSV2060LLR*	VSV2078RC*	VSV2478RC		
VST3672LBD	VST4272CRD	VST2054ELR*	VST2448ERCR*	VST2054LRR*	VST2084LC*	VST2484LC		
VSV3672LBD	VSV4272CRD	VSV2054ELR*	VSV2448ERCR*	VSV2054LRR*	VSV2084LC*	VSV2484LC		
VST3672LDF	VST4272CRDF	VST2054ELY*	VST2448ERCY*	VST2054LLR*	VST2084RC*	VST2484RC		
VSV3672LDF	VSV4272CRDF	VSV2054ELY*	VSV2448ERCY*	VSV2054LLR*	VSV2084RC*	VSV2484RC		
VST3672LD	VST4272LBD	VST2054ERR*	VST2448ERR*	VST2048LRR*	VST2084LRC	VST2484LRC		
VSV3672LD	VSV4272LBD	VSV2054ERR*	VSV2448ERR*	VSV2048LRR*	VSV2084LRC	VSV2484LRC		
VST3672LDF	VST4272LBDF	VST2054ERY*	VST2448ERY*	VST2048LLR*	VST2084LLC	VST2484LLC		
VSV3672LDF	VSV4272LBDF	VSV2054ERY*	VSV2448ERY*	VSV2048LLR*	VSV2084LLC	VSV2484LLC		
VST3672RBD	VST4272RBD	VST2060ELY*	VST2454ELR		VST2078LRC	VST2478LRC		
VSV3672RBD	VSV4272RBD	VSV2060ELY*	VSV2454ELR		VSV2078LRC	VSV2478LRC		
VST3672RDF	VST4272RDF	VST2060ERR*	VST2454ELY		VST2078LLC	VST2478LLC		
VSV3672RDF	VSV4272RDF	VSV2060ERR*	VSV2454ELY		VSV2078LLC	VSV2478LLC		
VST3672RD	VST4872CBDL	VST2060ELR*	VST2454ERR		VST2072LRC	VST2472LRC		
VSV3672RD	VSV4872CBDL	VSV2060ELR*	VSV2454ERR		VSV2072LRC	VSV2472LRC		
VST3672RDF	VST4872CBDF	VST2060ERY*	VST2454ERY		VST2072LLC	VST2472LLC		
VSV3672RDF	VSV4872CBDF	VSV2060ERY*	VSV2454ERY		VSV2072LLC	VSV2472LLC		
VST3684LBD	VST4872CBDR	VST2442ELCR*	VST2460ELR					
VSV3684LBD	VSV4872CBDR	VSV2442ELCR*	VSV2460ELR					
VST3684LDF	VST4872CBDRF	VST2442ELCY*	VST2460ELY					
VSV3684LDF	VSV4872CBDRF	VSV2442ELCY*	VSV2460ELY					
		VST2442ELR*	VST2460ERR					
		VSV2442ELR*	VSV2460ERR					
		VST2442ELY*	VST2460ERY					
		VSV2442ELY*	VSV2460ERY					

Vision Product Information

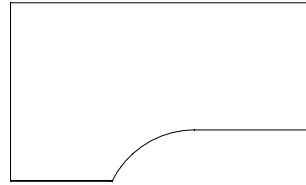
Peninsula and Modular Top Shapes



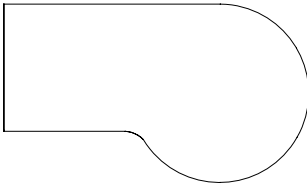
Rectangular/Soft Rectangular
peninsula/modular



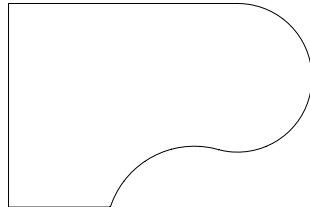
Bullet
peninsula/modular



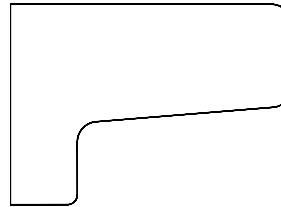
Extended Corner
modular



"P" Top
peninsula



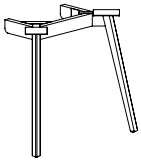
Extended Corner Bullet
peninsula/modular



Sweeping L
peninsula/modular

Base for Worksurface Tops and Finish/Metal Colors Options

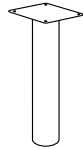
These base styles can be used with Peninsula Desks and Modular Desk Tops.



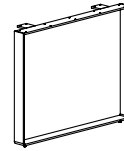
Taper Base
JSI standard seating finishes
paint - add \$45



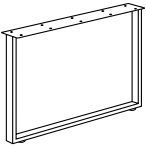
Truss Base
JSI standard seating finishes



Column Base
Matte Black (MBK)
Arctic Silver (ASL)



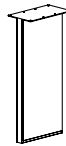
Perimeter Base
Chrome (CHR)



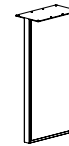
Rectangular Base
Matte Black (MBK)
Arctic Silver (ASL)
Pewter (PEW)
Soft Nickel (SNK)
Soft Bronze (SBZ)
Aged Bronze (ABZ)
Gold (GLD)



Dowel Base
Metal (upper section)
Matte Black (MBK)
Arctic Silver (ASL)
Pewter (PEW)
Soft Nickel (SNK)
Soft Bronze (SBZ)
Aged Bronze (ABZ)
Gold (GLD)
JSI standard seating finishes
paint - add \$45 (lower section)

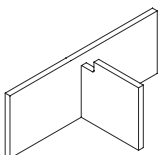


Executive Base
Vision laminate finishes
Metal
Matte Black (MBK)
Arctic Silver (ASL)
Pewter (PEW)
Soft Nickel (SNK)

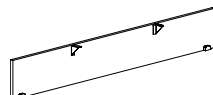


Executive Base
Vision wood finishes
Metal
Matte Black (MBK)
Arctic Silver (ASL)
Pewter (PEW)
Soft Nickel (SNK)
Soft Bronze (SBZ)
Aged Bronze (ABZ)
Gold (GLD)

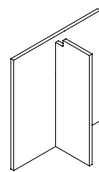
Modular Top End Supports for Peninsula and Modular Tops



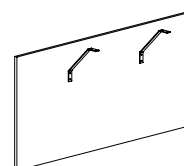
Bench Height "T" Support
use with bench height configurations



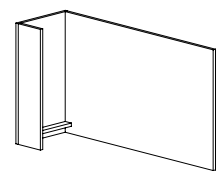
Bench Height Support with Metal Braces
use with modular tops or bench height configurations



Full Height "T" Support
use with peninsula or modular tops



Full Height End Support with Metal Braces
use with peninsula or modular tops

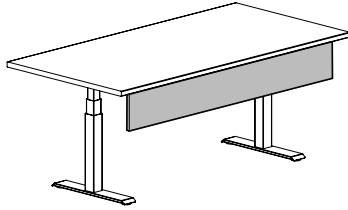


Wing End Support
use to create a modular open corner credenza or desk

Vision Product Information

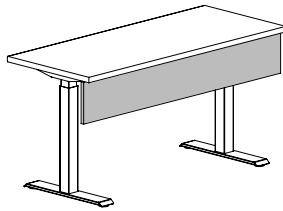
Electric Adjustable Height Table Desk - Standard/Extended/Pneumatic

Height Adjustable Modesty Panel Recommendations



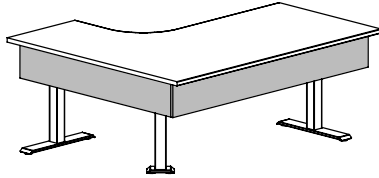
Top Depth	Top Width	Model Number
36/30/24	72	VST0964TDM / VSV0964TDM
30/24	84	VST0976TDM / VSV0976TDM
30/24	78	VST0970TDM / VSV0970TDM
30/24	66	VST0958TDM / VSV0958TDM
30/24	60	VST0952TDM / VSV0952TDM
30/24	54	VST0946TDM / VSV0946TDM
30/24	48	VST0940TDM / VSV0940TDM

Electric Adjustable Height Bridge - Standard/Extended/Pneumatic



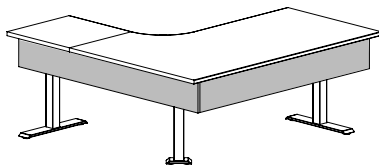
Top Depth	Top Width	Model Number
24	58	VST0958TDM / VSV0958TDM
24	52	VST0952TDM / VSV0952TDM
24	46	VST0940TDM / VSV0940TDM
24	40	VST0940TDM / VSV0940TDM

Adjustable Height Corner Table - One Piece Top - Standard/Extended



Top Depth	Top Width	Model Number
36/30	72	VST7203TDM / VSV7203TDM
36/30	66	VST6603TDM / VSV6603TDM
36/30	60	VST6003TDM / VSV6003TDM
24	72	VST7204TDM / VSV7204TDM
24	66	VST6604TDM / VSV6604TDM
24	60	VST6004TDM / VSV6004TDM

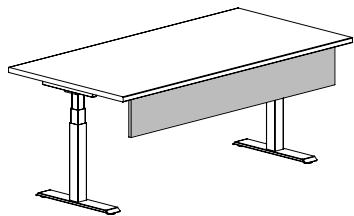
Adjustable Height Corner Table - Two Piece Top - Standard/Extended Adjustable Height Table & Return - Two Piece Top - Standard/Extended



Top Depth	Top Width	Model Number
36/30	72	VST7201TDM / VSV7201TDM
36/30	66	VST6601TDM / VSV6601TDM
36/30	60	VST6001TDM / VSV6001TDM
24	72	VST7202TDM / VSV7202TDM
24	66	VST6602TDM / VSV6602TDM
24	60	VST6002TDM / VSV6002TDM

Vision Product Information

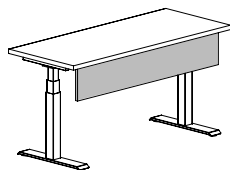
Rectangular Table & Run-Off Top (for use with Adj. Height T-Base)



Height Adjustable Modesty Panel Recommendations

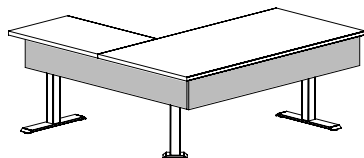
Top Depth	Top Width	Model Number
36	72	VST0964TDM / VSV0964TDM
30	84	VST0976TDM / VSV0976TDM
30	78	VST0970TDM / VSV0970TDM
30	72	VST0964TDM / VSV0964TDM
30	66	VST0958TDM / VSV0958TDM
30	60	VST0952TDM / VSV0952TDM
30	54	VST0946TDM / VSV0946TDM
30	48	VST0940TDM / VSV0940TDM
24	84	VST0976TDM / VSV0976TDM
24	78	VST0970TDM / VSV0970TDM
24	72	VST0964TDM / VSV0964TDM
24	66	VST0958TDM / VSV0958TDM
24	60	VST0952TDM / VSV0952TDM
24	54	VST0946TDM / VSV0946TDM
24	48	VST0940TDM / VSV0940TDM

Bridge Top (for use with Adj. Height T-Base)



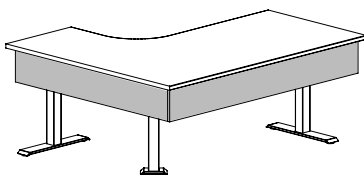
Top Depth	Top Width	Model Number
24	58	VST0952TDM / VSV0952TDM
24	52	VST0946TDM / VSV0946TDM
24	46	VST0940TDM / VSV0940TDM

Corner Desk Top (for use with Adj. Height T-Base)



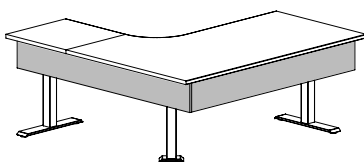
Top Depth	Top Width	Model Number
36/30	72	VST7201TDM / VSV7201TDM
36/30	66	VST6601TDM / VSV6601TDM
36/30	60	VST6001TDM / VSV6001TDM
24	72	VST7202TDM / VSV7202TDM
24	66	VST6602TDM / VSV6602TDM
24	60	VST6002TDM / VSV6002TDM

Cockpit Corner Desk Top (for use with Adj. Height T-Base)



Top Depth	Top Width	Model Number
36/30	72	VST7203TDM / VSV7203TDM
36/30	66	VST6603TDM / VSV6603TDM
36/30	60	VST6003TDM / VSV6003TDM
24	72	VST7204TDM / VSV7204TDM
24	66	VST6604TDM / VSV6604TDM
24	60	VST6004TDM / VSV6004TDM

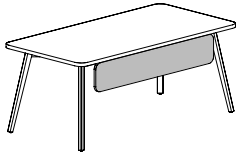
Cockpit Corner Desk Top - Two Piece (for use with Adj. Height T-Base)



Top Depth	Top Width	Model Number
36/30	72	VST7201TDM / VSV7201TDM
36/30	66	VST6601TDM / VSV6601TDM
36/30	60	VST6001TDM / VSV6001TDM
24	72	VST7202TDM / VSV7202TDM
24	66	VST6602TDM / VSV6602TDM
24	60	VST6002TDM / VSV60042TDM

Vision Product Information

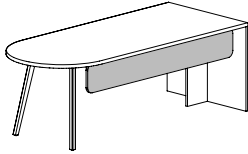
Table Desk



Modesty Panel Recommendations

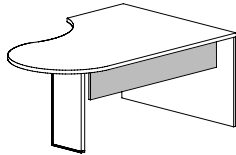
Top Depth	Top Width	Model Number
36/30	72	VST5410HMPR / VSV5410HMPR
36/30	66	VST4810HMPR / VST4810HMPR

Bullet Peninsula Desk



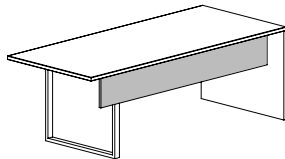
Top Depth	Top Width	Model Number
36/30	84	VST6610HMPS / VST6610HMPR VSV6610HMPS / VSV6610HMPR
36/30	78	VST6010HMPS / VST6010HMPR VSV6010HMPS / VSV6010HMPR
36/30	72	VST5410HMPS / VST5410HMPR VSV5410HMPS / VSV5410HMPR
30	66	VST4810HMPS / VST4810HMPR VSV4810HMPS / VSV4810HMPR

Cockpit Bullet Peninsula Desk



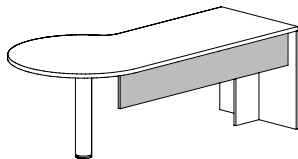
Top Depth	Top Width	Model Number
48	72	VST5410HMPS / VST5410HMPR VSV5410HMPS / VSV5410HMPR

Rectangular Peninsula Desk/ Soft Rectangular Desk



Top Depth	Top Width	Model Number
36/30	84	VST7210HMPS / VST7210HMPR VSV7210HMPS / VSV7210HMPR
36/30	78	VST6610HMPS / VST6610HMPR VSV6610HMPS / VSV6610HMPR
36/30	72	VST6010HMPS / VST6010HMPR VSV6010HMPS / VSV6010HMPR
36/30	66	VST5410HMPS / VST5410HMPR VSV5410HMPS / VSV5410HMPR
36/30	60	VST4810HMPS / VST4810HMPR VSV4810HMPS / VSV4810HMPR

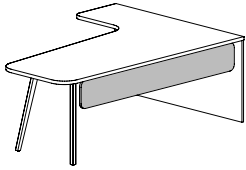
P-Top Peninsula Desk



Top Depth	Top Width	Model Number
42	84	VST6610HMPS / VST6610HMPR VSV6610HMPS / VSV6610HMPR
42	78	VST6010HMPS / VST6010HMPR VSV6010HMPS / VSV6010HMPR
42	72	VST5410HMPS / VST5410HMPR VSV5410HMPS / VSV5410HMPR

Vision Product Information

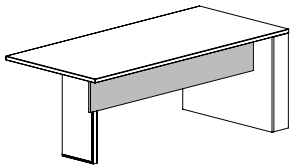
Sweeping L Peninsula Desk



Modesty Panel Recommendations

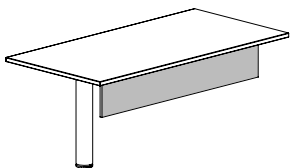
Top Depth	Top Width	Model Number
60	84	VST7210HMPS / VST7210HMPR VSV7210HMPS / VSV7210HMPR
60	78	VST6610HMPS / VST6610HMPR VSV6610HMPS / VSV6610HMPR
60	72	VST6010HMPS / VST6010HMPR VSV6010HMPS / VSV6010HMPR
60	66	VST5410HMPS / VST5410HMPR VSV5410HMPS / VSV5410HMPR
60	66	VST4810HMPS / VST4810HMPR VSV4810HMPS / VSV4810HMPR

Rectangular Workwall Peninsula Desk / Soft Rectangular Workwall Peninsula Desk



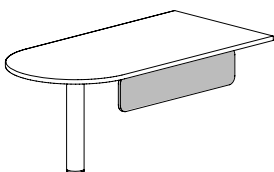
Top Depth	Top Width	Model Number
36/30	84	VST6610HMPS / VST6610HMPR VSV6610HMPS / VSV6610HMPR
36/30	78	VST6010HMPS / VST6010HMPR VSV6010HMPS / VSV6010HMPR
36/30	72	VST5410HMPS / VST5410HMPR VSV5410HMPS / VSV5410HMPR
36/30	66	VST4810HMPS / VST4810HMPR VSV4810HMPS / VSV4810HMPR
36/30	60	VST4210HMPS / VST4210HMPR VSV4210HMPS / VSV4210HMPR

Rectangular Run-Off Desk Top / Soft Rectangular Run-Off Desk Top



Top Depth	Top Width	Model Number
36/30	72	VST6010HMPS / VST6010HMPR VSV6010HMPS / VSV6010HMPR
36/30	66	VST5410HMPS / VST5410HMPR VSV5410HMPS / VSV5410HMPR
36/30	60	VST4810HMPS / VST4810HMPR VSV4810HMPS / VSV4810HMPR
36/30	54	VST4210HMPS / VST4210HMPR VSV4210HMPS / VSV4210HMPR
36/30	48	VST3610HMPS / VST3610HMPR VSV3610HMPS / VSV3610HMPR

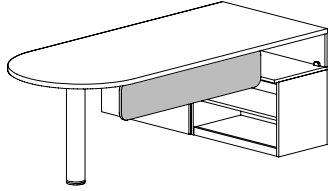
Bullet Run-Off Desk



Top Depth	Top Width	Model Number
36	72	VST4210HMPS / VST4210HMPR VSV4210HMPS / VSV4210HMPR
36	66	VST3610HMPS / VST3610HMPR VSV3610HMPS / VSV3610HMPR
36	60	VST3010HMPS / VST3010HMPR VSV3010HMPS / VSV3010HMPR

Vision Product Information

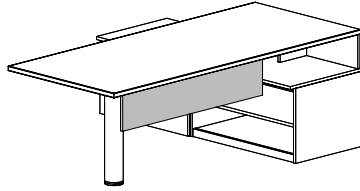
Bench Height Supported Bullet Peninsula Desk



Modesty Panel Recommendations

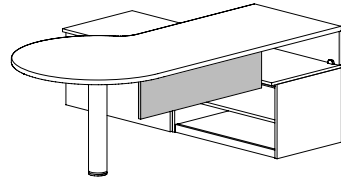
Top Depth	Top Width	Model Number
36/30	84	VST4210HMPS / VST4210HMPR VSV4210HMPS / VSV4210HMPR
36/30	78	VST3610HMPS / VST3610HMPR VSV3610HMPS / VSV3610HMPR
36/30	72	VST3010HMPS / VST3010HMPR VSV3010HMPS / VSV3010HMPR

Bench Height Supported Rectangular Peninsula Desk / Bench Height Supported Soft Rectangular



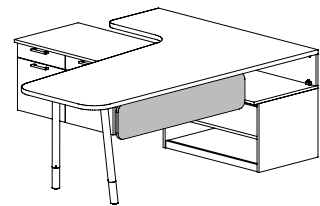
Top Depth	Top Width	Model Number
36/30	84	VST4810HMPS / VST4810HMPR VSV4810HMPS / VSV4810HMPR
36/30	78	VST4210HMPS / VST4210HMPR VSV4210HMPS / VSV4210HMPR
36/30	72	VST3610HMPS / VST3610HMPR VSV3610HMPS / VSV3610HMPR
36/30	66	VST3010HMPS / VST3010HMPR VSV3010HMPS / VSV3010HMPR
36/30	60	VST2410HMPS / VST2410HMPR VSV2410HMPS / VSV2410HMPR

Bench Height Supported P Top Peninsula Desk



Top Depth	Top Width	Model Number
42	84	VST4210HMPS / VST4210HMPR VSV4210HMPS / VSV4210HMPR
42	78	VST3610HMPS / VST3610HMPR VSV3610HMPS / VSV3610HMPR
42	72	VST3010HMPS / VST3010HMPR VSV3010HMPS / VSV3010HMPR

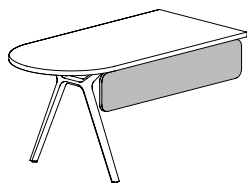
Bench Height Sweeping L Desk



Top Depth	Top Width	Model Number
60	84	VST4810HMPS / VST4810HMPR VSV4810HMPS / VSV4810HMPR
60	78	VST4210HMPS / VST4210HMPR VSV4210HMPS / VSV4210HMPR
60	72	VST3610HMPS / VST3610HMPR VSV3610HMPS / VSV3610HMPR
60	66	VST3010HMPS / VST3010HMPR VSV3010HMPS / VSV3010HMPR

Vision Product Information

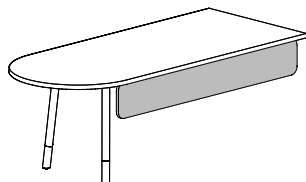
Bullet Return Top



Modesty Panel Recommendations

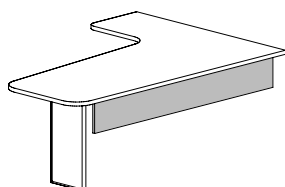
Top Depth	Top Width	Model Number
30/24	60	VST4810HMPS / VST4810HMPR VSV4810HMPS / VSV4810HMPR
30/24	48	VST3610HMPS / VST3610HMPR VSV3610HMPS / VSV3610HMPR

Modular Bullet Desk Top



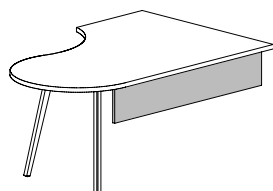
Top Depth	Top Width	Model Number
36	84	VST6610HMPS / VST6610HMPR VSV6610HMPS / VSV6610HMPR
36	78	VST6010HMPS / VST6010HMPR VSV6010HMPS / VSV6010HMPR
36/30	72	VST5410HMPS / VST5410HMPR VSV5410HMPS / VSV5410HMPR
36/30	66	VST4810HMPS / VST4810HMPR VSV4810HMPS / VSV4810HMPR
24	60	VST4210HMPS / VST4210HMPR VSV4210HMPS / VSV4210HMPR
24	48	VST3010HMPS / VST3010HMPR VSV3010HMPS / VSV3010HMPR

Modular Sweeping L Desk Top



Top Depth	Top Width	Model Number
60	84	VST7210HMPS / VST7210HMPR VSV7210HMPS / VSV7210HMPR
60	78	VST6610HMPS / VST6610HMPR VSV6610HMPS / VSV6610HMPR
60	72	VST6010HMPS / VST6010HMPR VSV6010HMPS / VSV6010HMPR
60	66	VST5410HMPS / VST5410HMPR VSV5410HMPS / VSV5410HMPR
60	60	VST4810HMPS / VST4810HMPR VSV4810HMPS / VSV4810HMPR

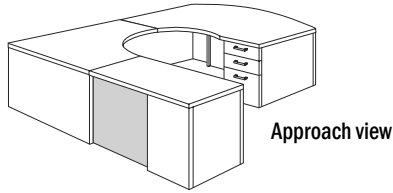
Modular Extended Corner Bullet Desk Top



Top Depth	Top Width	Model Number
48/42	72	VST5410HMPS / VST5410HMPR VSV5410HMPS / VSV5410HMPR
42	66	VST4810HMPS / VST4810HMPR VSV4810HMPS / VSV4810HMPR

Vision Product Information

Returns with Breakfront

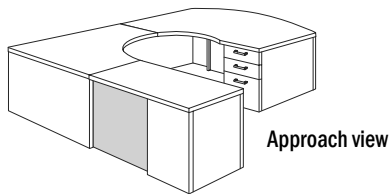


Consists of:
 VST2442MCT - top
 VST1624MFF - pedestal
 VST2728MDRA - breakfront modesty panel

Modesty Panel Sizes for Returns with Pedestal

Top Width	Pedestal Width	Modesty Width	Modesty Height	Model Number
36	15 ^{5/8}	21 ^{3/16}	28	VST2128MDRA
42	15 ^{5/8}	27 ^{3/16}	28	VST2728MDRA
48	15 ^{5/8}	33 ^{3/16}	28	VST3328MDRA
54	15 ^{5/8}	39 ^{3/16}	28	VST3928MDRA
60	15 ^{5/8}	45 ^{3/16}	28	VST4528MDRA

Returns with Breakfront



Consists of:
 VST2448MCT - top
 VST3624MLF - pedestal
 VST1328MDRB - modesty panel

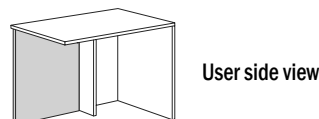
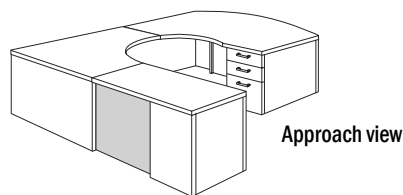
Modesty Panel Sizes for Returns with Lateral File Pedestal

Top Width	Pedestal 36" Wide	Modesty Width	Modesty Height	Model Number
42	35 ^{7/8}	6 ^{15/16}	28	VST0728MDRB
48	35 ^{7/8}	12 ^{15/16}	28	VST1328MDRB
54	35 ^{7/8}	18 ^{15/16}	28	VST1828MDRB
60	35 ^{7/8}	24 ^{15/16}	28	VST2528MDRB

Top Width	Pedestal 30" Wide	Modesty Width	Modesty Height	Model Number
36	29 ^{7/8}	6 ^{15/16}	28	VST0728MDRB
42	29 ^{7/8}	12 ^{15/16}	28	VST1328MDRB
48	29 ^{7/8}	18 ^{15/16}	28	VST1828MDRB
54	29 ^{7/8}	24 ^{15/16}	28	VST2528MDRB
60	29 ^{7/8}	30 ^{15/16}	28	VST3128MDRB

Vision Product Information

Return Shells with Breakfront

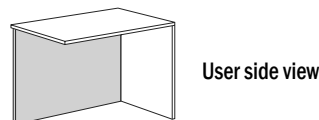
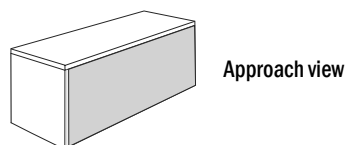


Consists of:
 VST2442MCT - top
 VST1624WEAR - wing end panel
 VST2728MDRA - breakfront modesty panel

Modesty Panel Sizes for Return Shells using VST1624WEAL or VST1624WEAR wing end panel

Top Width	Wing Assembly Width	Modesty Width	Modesty Height	Model Number
36	15 ⁵ / ₈	21 ³ / ₁₆	28	VST2128MDRA
42	15 ⁵ / ₈	27 ³ / ₁₆	28	VST2728MDRA
48	15 ⁵ / ₈	33 ³ / ₁₆	28	VST3328MDRA
54	15 ⁵ / ₈	39 ³ / ₁₆	28	VST3928MDRA
60	15 ⁵ / ₈	45 ³ / ₁₆	28	VST4528MDRA

Return Shells

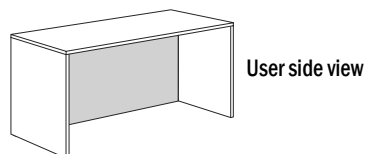
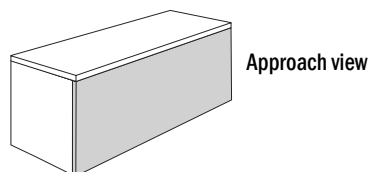


Consists of:
 VST2442MCT - top
 VST24EP - end panel
 VST4328MDRS - modesty panel

Modesty Panel Sizes for Return Shells using VST24EP end panel

Top Width	End Panel Thickness VST24EP	Modesty Width	Modesty Height	Model Number
36	³ / ₄	36 ¹ / ₁₆	28	VST3728MDRS
42	³ / ₄	42 ¹ / ₁₆	28	VST4328MDRS
48	³ / ₄	48 ¹ / ₁₆	28	VST4928MDRS
54	³ / ₄	54 ¹ / ₁₆	28	VST5528MDRS

Desk Shells



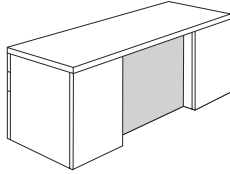
Consists of:
 VST2442MCT - top
 VST23EP - (2) end panels
 VST4228MBK - modesty panel

Modesty Panel Sizes for Desk Shells with both left and right ends using VST23EP end panel

Top Width	End Panel Thickness VST23EP	Modesty Width	Modesty Height	Model Number
30	³ / ₄	29 ⁷ / ₈	28	VST3028MBK
36	³ / ₄	35 ⁷ / ₈	28	VST3628MBK
42	³ / ₄	41 ⁷ / ₈	28	VST4228MBK
48	³ / ₄	47 ⁷ / ₈	28	VST4828MBK
54	³ / ₄	53 ⁷ / ₈	28	VST5428MBK
60	³ / ₄	59 ⁷ / ₈	28	VST6028MBK

Vision Product Information

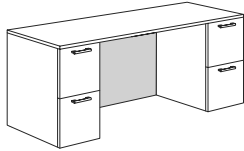
Desk Shells with Breakfront



Approach view
of unit using
wing end panels

Consists of:

- VST1630WEAL - left wing end panel
- VST1630WEAR - right wing end panel
- VST4128MDDE - breakfront modesty panel
- VST3072MCT - top



User side view of
double ped desk

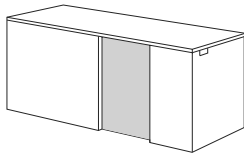
Consists of:

- VST1630MFF - (2) 30" deep modular pedestals
- VST4128MDDE - breakfront modesty panel
- VST3072MCT - top

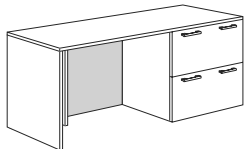
Modular Breakfront Modesty Panel Sizes for double pedestal desks and credenzas
-OR- Single pedestal desks and credenzas with the VST1630WEAL or VST1630WEAR
wing end assembly or with the VST1624WEAL or VST1624WEAR wing end assembly

Top Width	Right or Left Pedestal or Wing End Assembly Width	Modesty Width	Modesty Height	Model Number
60	15 ⁵ / ₈	28 ⁵ / ₈	28	VST2928MDDE
66	15 ⁵ / ₈	34 ⁵ / ₈	28	VST3528MDDE
72	15 ⁵ / ₈	40 ⁵ / ₈	28	VST4128MDDE
78	15 ⁵ / ₈	46 ⁵ / ₈	28	VST4728MDDE
84	15 ⁵ / ₈	52 ⁵ / ₈	28	VST5328MDDE
90	15 ⁵ / ₈	58 ⁵ / ₈	28	VST5928MDDE

Credenza Shells with Breakfront



Approach view



User side view

Consists of:

- VST3624MLF - pedestal
- VST1624WEAL - wing end support
- VST2128MDCG - breakfront modesty panel
- VST2472MCT - top

Modular Breakfront Modesty Panel Sizes for Single Pedestal Credenzas with 30" or 36" wide pedestal -OR- using the VST1624WEAL OR VST1624WEAR wing end assembly.

Top Width	36" Pedestal Width	Wing End Assembly Width	Modesty Width	Modesty Height	Model Number
66	35 ⁷ / ₈	15 ⁵ / ₈	14 ³ / ₈	28	VST1528MDCG
72	35 ⁷ / ₈	15 ⁵ / ₈	20 ³ / ₈	28	VST2128MDCG
78	35 ⁷ / ₈	15 ⁵ / ₈	26 ³ / ₈	28	VST2628MDCG
84	35 ⁷ / ₈	15 ⁵ / ₈	32 ³ / ₈	28	VST3328MDCG
90	35 ⁷ / ₈	15 ⁵ / ₈	38 ³ / ₈	28	VST3928MDCG
96	35 ⁷ / ₈	15 ⁵ / ₈	44 ³ / ₈	28	VST4528MDCG

Top Width	30" Pedestal Width	Wing End Assembly Width	Modesty Width	Modesty Height	Model Number
60	29 ⁷ / ₈	15 ⁵ / ₈	14 ³ / ₈	28	VST1528MDCG
66	29 ⁷ / ₈	15 ⁵ / ₈	20 ³ / ₈	28	VST2128MDCG
72	29 ⁷ / ₈	15 ⁵ / ₈	26 ³ / ₈	28	VST2728MDCG
78	29 ⁷ / ₈	15 ⁵ / ₈	32 ³ / ₈	28	VST3328MDCG
84	29 ⁷ / ₈	15 ⁵ / ₈	38 ³ / ₈	28	VST3928MDCG
90	29 ⁷ / ₈	15 ⁵ / ₈	44 ³ / ₈	28	VST4528MDCG
96	29 ⁷ / ₈	15 ⁵ / ₈	50 ³ / ₈	28	VST5128MDCG

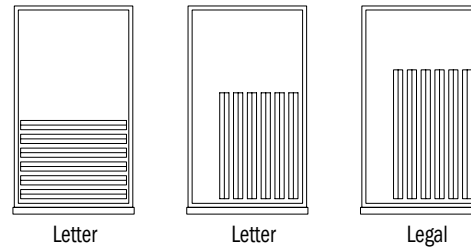
Vision Product Information

Desks	Model	Description	Drawer Configuration (User Side)	
			Left Pedestal	Right Pedestal
VST4272BD	Double Pedestal Bow Desk		Box/Box/File	File/File
VST4272BDF	Double Pedestal Bow Desk		Box/Box/File	File/File
VST3684BD	Double Pedestal Bow Desk		Box/Box/File	File/File
VST3684BDF	Double Pedestal Bow Desk		Box/Box/File	File/File
VST3672BD	Double Pedestal Bow Desk		Box/Box/File	File/File
VST3672BDF	Double Pedestal Bow Desk		Box/Box/File	File/File
VST3684DD	Double Pedestal Desk		Box/Box/File	File/File
VST3684DDF	Double Pedestal Desk		Box/Box/File	File/File
VST3678DD	Double Pedestal Desk		Box/Box/File	File/File
VST3678DDF	Double Pedestal Desk		Box/Box/File	File/File
VST3672DD	Double Pedestal Desk		Box/Box/File	File/File
VST3672DDF	Double Pedestal Desk		Box/Box/File	File/File
VST3072DD	Double Pedestal Desk		Box/Box/File	File/File
VST3072DDF	Double Pedestal Desk		Box/Box/File	File/File
VST3066DD	Double Pedestal Desk		Box/Box/File	File/File
VST3066DDF	Double Pedestal Desk		Box/Box/File	File/File
VST3060DD	Double Pedestal Desk		Box/Box/File	File/File
VST3060DDF	Double Pedestal Desk		Box/Box/File	File/File
VST4872CBDR	Right Ped. Bow Cockpit Desk			Box/Box/File
VST4872CBDRF	Right Ped. Bow Cockpit Desk			Box/Box/File
VST4872CBDL	Left Ped. Bow Cockpit Desk		Box/Box/File	
VST4872CBDLF	Left Ped. Bow Cockpit Desk		Box/Box/File	
VST4272CRD	Right Ped. Cockpit Desk			Box/Box/File
VST4272CRDF	Right Ped. Cockpit Desk			Box/Box/File
VST4272CLD	Left Pedestal Cockpit Desk		Box/Box/File	
VST4272CLDF	Left Pedestal Cockpit Desk		Box/Box/File	
VST4272RBD	Right Pedestal Bow Desk			Box/Box/File
VST4272RBDF	Right Pedestal Bow Desk			Box/Box/File
VST4272LBD	Left Pedestal Bow Desk		Box/Box/File	
VST4272LBDF	Left Pedestal Bow Desk		Box/Box/File	
VST3684RBD	Right Pedestal Bow Desk			Box/Box/File
VST3684RBDF	Right Pedestal Bow Desk			Box/Box/File
VST3684LBD	Left Pedestal Bow Desk		Box/Box/File	
VST3684LBDF	Left Pedestal Bow Desk		Box/Box/File	
VST3672RBD	Right Pedestal Bow Desk			Box/Box/File
VST3672RBDF	Right Pedestal Bow Desk			Box/Box/File
VST3672LBD	Left Pedestal Bow Desk		Box/Box/File	
VST3672LBDF	Left Pedestal Bow Desk		Box/Box/File	
VST3684RD	Right Pedestal Desk			Box/Box/File
VST3684RDF	Right Pedestal Desk			Box/Box/File
VST3684LD	Left Pedestal Desk		Box/Box/File	
VST3684LDF	Left Pedestal Desk		Box/Box/File	
VST3672RD	Right Pedestal Desk			Box/Box/File
VST3672RDF	Right Pedestal Desk			Box/Box/File
VST3672LD	Left Pedestal Desk		Box/Box/File	
VST3672LDF	Left Pedestal Desk		Box/Box/File	

Desks (continued)	Model	Description	Drawer Configuration (User Side)	
			Left Pedestal	Right Pedestal
VST3072RD	Right Pedestal Desk			Box/Box/File
VST3072RDF	Right Pedestal Desk			Box/Box/File
VST3072LD	Left Pedestal Desk		Box/Box/File	
VST3072LDF	Left Pedestal Desk		Box/Box/File	
VST3066RD	Right Pedestal Desk			Box/Box/File
VST3066RDF	Right Pedestal Desk			Box/Box/File
VST3066LD	Left Pedestal Desk		Box/Box/File	
VST3066LDF	Left Pedestal Desk		Box/Box/File	

Interior Drawer Dimensions	Depth	Width	Height
Box	21"	12"	3 1/4"
File	21"	12"	9 1/8"

Filing Options (Diagram 1)



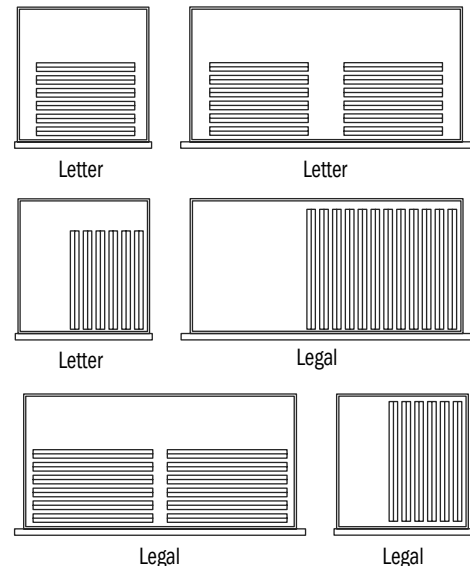
Vision Product Information

Executive Returns		Drawer Configuration (User Side)	
Model	Description	Left Pedestal	Right Pedestal
VST2460ERR	Right Executive Return		File/File
VST2460ELR	Left Executive Return	File/File	
VST2454ERR	Right Executive Return		File/File
VST2454ELR	Left Executive Return	File/File	
VST2448ERR	Right Executive Return		File/File
VST2448ELR	Left Executive Return	File/File	
VST2442ERR	Right Executive Return		File/File
VST2442ELR	Left Executive Return	File/File	
VST2060ERR	Right Executive Return		File/File
VST2060ELR	Left Executive Return	File/File	
VST2054ERR	Right Executive Return		File/File
VST2054ELR	Left Executive Return	File/File	
VST2048ERR	Right Executive Return		File/File
VST2048ELR	Left Executive Return	File/File	
VST2042ERR	Right Executive Return		File/File
VST2042ELR	Left Executive Return	File/File	
VST2460ERY	Right Executive Return		Box/Box/File
VST2460ELY	Left Executive Return	Box/Box/File	
VST2454ERY	Right Executive Return		Box/Box/File
VST2454ELY	Left Executive Return	Box/Box/File	
VST2448ERY	Right Executive Return		Box/Box/File
VST2448ELY	Left Executive Return	Box/Box/File	
VST2442ERY	Right Executive Return		Box/Box/File
VST2442ELY	Left Executive Return	Box/Box/File	
VST2060ERY	Right Executive Return		Box/Box/File
VST2060ELY	Left Executive Return	Box/Box/File	
VST2054ERY	Right Executive Return		Box/Box/File
VST2054ELY	Left Executive Return	Box/Box/File	
VST2048ERY	Right Executive Return		Box/Box/File
VST2048ELY	Left Executive Return	Box/Box/File	
VST2042ERY	Right Executive Return		Box/Box/File
VST2042ELY	Left Executive Return	Box/Box/File	
VST2460ERCR	Right Corner Return		File/File
VST2460ELCR	Left Corner Return	File/File	
VST2454ERCR	Right Corner Return		File/File
VST2454ELCR	Left Corner Return	File/File	
VST2448ERCR	Right Corner Return		File/File
VST2448ELCR	Left Corner Return	File/File	
VST2442ERCR	Right Corner Return		File/File
VST2442ELCR	Left Corner Return	File/File	
VST2460ERCY	Right Corner Return		Box/Box/File
VST2460ELCY	Left Corner Return	Box/Box/File	
VST2454ERCY	Right Corner Return		Box/Box/File
VST2454ELCY	Left Corner Return	Box/Box/File	
VST2448ERCY	Right Corner Return		Box/Box/File
VST2448ELCY	Left Corner Return	Box/Box/File	
VST2442ERCY	Right Corner Return		Box/Box/File
VST2442ELCY	Left Corner Return	Box/Box/File	
VST2060ERCR	Right Corner Return		File/File
VST2060ELCR	Left Corner Return	File/File	
VST2054ERCR	Right Corner Return		File/File
VST2054ELCR	Left Corner Return	File/File	
VST2048ERCR	Right Corner Return		File/File
VST2048ELCR	Left Corner Return	File/File	
VST2042ERCR	Right Corner Return		File/File
VST2042ELCR	Left Corner Return	File/File	
VST2060ERCY	Right Corner Return		Box/Box/File
VST2060ELCY	Left Corner Return	Box/Box/File	

Executive Returns (continued)		Drawer Configuration (User Side)	
Model	Description	Left Pedestal	Right Pedestal
VST2054ERCY	Right Corner Return		Box/Box/File
VST2054ELCY	Left Corner Return	Box/Box/File	
VST2048ERCY	Right Corner Return		Box/Box/File
VST2048ELCY	Left Corner Return	Box/Box/File	
VST2042ERCY	Right Corner Return		Box/Box/File
VST2042ELCY	Left Corner Return	Box/Box/File	
VST2460LRR	Right Lateral Return		Lat. File/Lat. File
VST2460LLR	Left Lateral Return	Lat. File/Lat. File	
VST2454LRR	Right Lateral Return		Lat. File/Lat. File
VST2454LLR	Left Lateral Return	Lat. File/Lat. File	
VST2448LRR	Right Lateral Return		Lat. File/Lat. File
VST2448LLR	Left Lateral Return	Lat. File/Lat. File	
VST2060LRR	Right Lateral Return		Lat. File/Lat. File
VST2060LLR	Left Lateral Return	Lat. File/Lat. File	
VST2054LRR	Right Lateral Return		Lat. File/Lat. File
VST2054LLR	Left Lateral Return	Lat. File/Lat. File	
VST2048LRR	Right Lateral Return		Lat. File/Lat. File
VST2048LLR	Left Lateral Return	Lat. File/Lat. File	
VST2460LRCR	Right Lateral Corner Return		Lat. File/Lat. File
VST2460LLCR	Left Lateral Corner Return	Lat. File/Lat. File	
VST2454LRCR	Right Lateral Corner Return		Lat. File/Lat. File
VST2454LLCR	Left Lateral Corner Return	Lat. File/Lat. File	
VST2448LRCR	Right Lateral Corner Return		Lat. File/Lat. File
VST2448LLCR	Left Lateral Corner Return	Lat. File/Lat. File	
VST2060LRCR	Right Lateral Corner Return		Lat. File/Lat. File
VST2060LLCR	Left Lateral Corner Return	Lat. File/Lat. File	
VST2054LRCR	Right Lateral Corner Return		Lat. File/Lat. File
VST2054LLCR	Left Lateral Corner Return	Lat. File/Lat. File	
VST2048LRCR	Right Lateral Corner Return		Lat. File/Lat. File
VST2048LLCR	Left Lateral Corner Return	Lat. File/Lat. File	

Interior Drawer Dimensions	Depth	Width	Height
Box	15"	12"	3 ¼"
File	15"	12"	9 ⅛"
Lateral File	15"	32 ⅝"	9 ⅛"

Filing Options (Diagram 4)

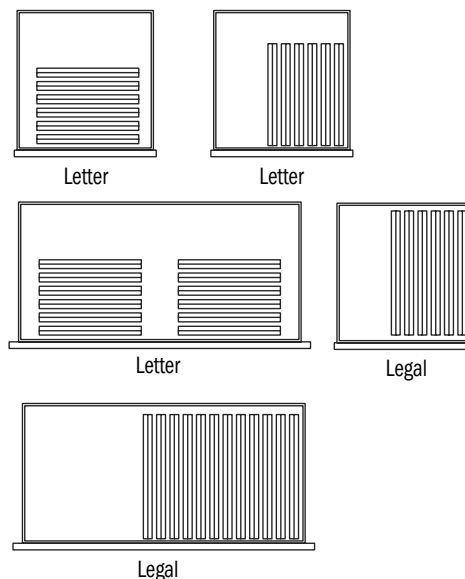


Vision Product Information

Executive Returns		Drawer Configuration (User Side)	
Model	Description	Left Pedestal	Right Pedestal
VST2460MLR	Right Multi-File Return		2 Box/File/Lateral File
VST2460MLL	Left Multi-File Return	2 Box/File/Lateral File	
VST2454MLR	Right Multi-File Return		2 Box/File/Lateral File
VST2454MLL	Left Multi-File Return	2 Box/File/Lateral File	
VST2448MLR	Right Multi-File Return		2 Box/File/Lateral File
VST2448MLL	Left Multi-File Return	2 Box/File/Lateral File	
VST2060MLR	Right Multi-File Return		2 Box/File/Lateral File
VST2060MLL	Left Multi-File Return	2 Box/File/Lateral File	
VST2054MLR	Right Multi-File Return		2 Box/File/Lateral File
VST2054MLL	Left Multi-File Return	2 Box/File/Lateral File	
VST2048MLR	Right Multi-File Return		2 Box/File/Lateral File
VST2048MLL	Left Multi-File Return	2 Box/File/Lateral File	
VST2460MRCR	Rt. Multi-File Corner Return		2 Box/File/Lateral File
VST2460MLCR	Lt. Multi-File Corner Return	2 Box/File/Lateral File	
VST2454MRCR	Rt. Multi-File Corner Return		2 Box/File/Lateral File
VST2454MLCR	Lt. Multi-File Corner Return	2 Box/File/Lateral File	
VST2448MRCR	Rt. Multi-File Corner Return		2 Box/File/Lateral File
VST2448MLCR	Lt. Multi-File Corner Return	2 Box/File/Lateral File	
VST2060MRCR	Rt. Multi-File Corner Return		2 Box/File/Lateral File
VST2060MLCR	Lt. Multi-File Corner Return	2 Box/File/Lateral File	
VST2054MRCR	Rt. Multi-File Corner Return		2 Box/File/Lateral File
VST2054MLCR	Lt. Multi-File Corner Return	2 Box/File/Lateral File	
VST2048MRCR	Rt. Multi-File Corner Return		2 Box/File/Lateral File
VST2048MLCR	Lt. Multi-File Corner Return	2 Box/File/Lateral File	

Interior Drawer Dimensions	Depth	Width	Height
Box	15"	12"	3 1/4"
File	15"	12"	9 1/8"
Lateral File	15"	26 5/16"	9 1/8"

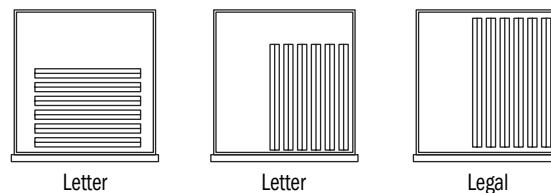
Filing Options (Diagram 3)



Mobile Pedestal		Drawer Configuration
Model	Description	Single Pedestal Width
VST1620MP	Mobile Pedestal	Box/Box/File

Interior Drawer Dimensions	Depth	Width	Height
Box	15"	12"	3 1/4"
File	15"	12"	9 1/8"

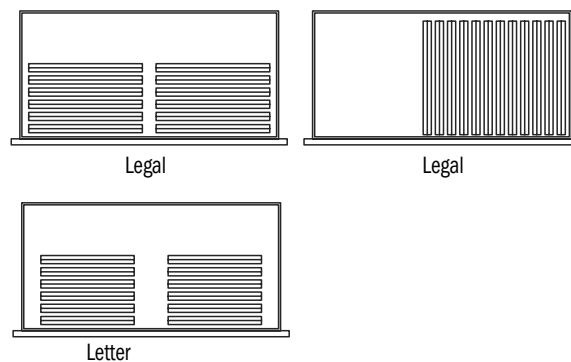
Filing Options (Diagram 2)



Credenzas		Drawer Configuration (User Side)	
Model	Description	Left Pedestal	Right Pedestal
VST2460LFC	Lateral File Credenza	Lat. File/Lat. File	Lat. File/Lat. File
VST2060LFC	Lateral File Credenza	Lat. File/Lat. File	Lat. File/Lat. File

Interior Drawer Dimensions	Depth	Width	Height
Lateral File	15"	26 5/16"	9 1/8"

Filing Options (Diagram 6)

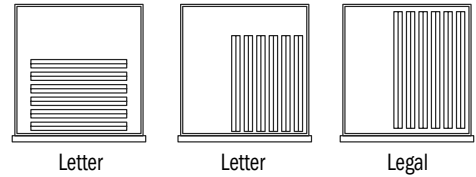


Vision Product Information

Credenzas		Drawer Configuration (User Side)	
Model	Description	Left Pedestal	Right Pedestal
VST2472SC	Storage Credenza ¹	File/File	File/File
VST2466SC	Storage Credenza ¹	File/File	File/File
VST2072SC	Storage Credenza ¹	File/File	File/File
VST2066SC	Storage Credenza ¹	File/File	File/File
VST2484KC	Kneespace Credenza	File/File	File/File
VST2478KC	Kneespace Credenza	File/File	File/File
VST2472KC	Kneespace Credenza	File/File	File/File
VST2466KC	Kneespace Credenza	File/File	File/File
VST2460KC	Kneespace Credenza	File/File	File/File
VST2084KC	Kneespace Credenza	File/File	File/File
VST2078KC	Kneespace Credenza	File/File	File/File
VST2072KC	Kneespace Credenza	File/File	File/File
VST2066KC	Kneespace Credenza	File/File	File/File
VST2060KC	Kneespace Credenza	File/File	File/File

Interior Drawer Dimensions	Depth	Width	Height
File	15"	12"	9 1/8"

Filing Options (Diagram 2)



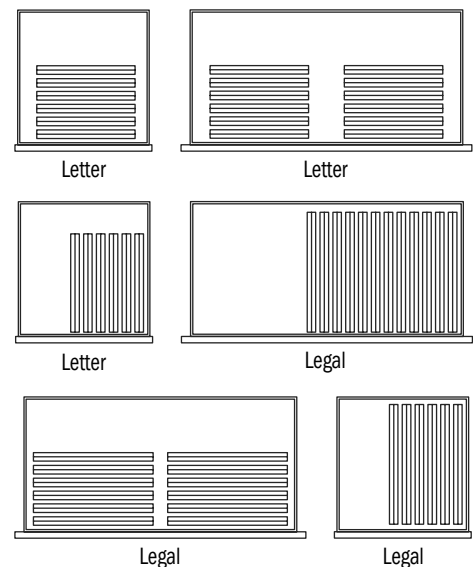
¹Center Section - Hinge Door Storage

Credenzas		Drawer Configuration (User Side)	
Model	Description	Left Pedestal	Right Pedestal
VST2484RC	Right Pedestal Credenza		File/File
VST2484LC	Left Pedestal Credenza	File/File	
VST2478RC	Right Pedestal Credenza		File/File
VST2478LC	Left Pedestal Credenza	File/File	
VST2472RC	Right Pedestal Credenza		File/File
VST2472LC	Left Pedestal Credenza	File/File	
VST2466RC	Right Pedestal Credenza		File/File
VST2466LC	Left Pedestal Credenza	File/File	
VST2460RC	Right Pedestal Credenza		File/File
VST2460LC	Left Pedestal Credenza	File/File	
VST2084RC	Right Pedestal Credenza		File/File
VST2084LC	Left Pedestal Credenza	File/File	
VST2078RC	Right Pedestal Credenza		File/File
VST2078LC	Left Pedestal Credenza	File/File	
VST2072RC	Right Pedestal Credenza		File/File
VST2072LC	Left Pedestal Credenza	File/File	
VST2066RC	Right Pedestal Credenza		File/File
VST2066LC	Left Pedestal Credenza	File/File	
VST2060RC	Right Pedestal Credenza		File/File
VST2060LC	Left Pedestal Credenza	File/File	
VST2484LRC	Right Lateral File Credenza		Lat. File/Lat. File
VST2484LLC	Left Lateral File Credenza	Lat. File/Lat. File	
VST2478LRC	Right Lateral File Credenza		Lat. File/Lat. File
VST2478LLC	Left Lateral File Credenza	Lat. File/Lat. File	
VST2472LRC	Right Lateral File Credenza		Lat. File/Lat. File
VST2472LLC	Left Lateral File Credenza	Lat. File/Lat. File	
VST2472LFC	Lateral File Credenza	Lat. File/Lat. File	Lat. File/Lat. File

Credenzas (continued)		Drawer Configuration (User Side)	
Model	Description	Left Pedestal	Right Pedestal
VST2084LRC	Right Lateral File Credenza		Lat. File/Lat. File
VST2084LLC	Left Lateral File Credenza	Lat. File/Lat. File	
VST2078LRC	Right Lateral File Credenza		Lat. File/Lat. File
VST2078LLC	Left Lateral File Credenza	Lat. File/Lat. File	
VST2072LRC	Right Lateral File Credenza		Lat. File/Lat. File
VST2072LLC	Left Lateral File Credenza	Lat. File/Lat. File	
VST2072LFC	Lateral File Credenza	Lat. File/Lat. File	Lat. File/Lat. File

Interior Drawer Dimensions	Depth	Width	Height
File	15"	12"	9 1/8"
Lateral File	15"	32 3/16"	9 1/8"

Filing Options (Diagram 4)



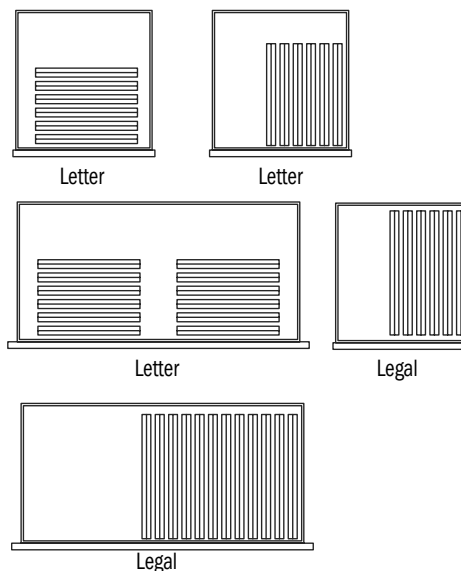
Vision Product Information

Credenzas

Model	Description	Drawer Configuration (User Side)	
		Left Pedestal	Right Pedestal
VST2484MRC	Right Multi-File Credenza		2 Box/File/Lateral File
VST2484MLC	Left Multi-File Return	2 Box/File/Lateral File	
VST2478MRC	Right Multi-File Credenza		2 Box/File/Lateral File
VST2478MLC	Left Multi-File Return	2 Box/File/Lateral File	
VST2472MRC	Right Multi-File Credenza		2 Box/File/Lateral File
VST2472MLC	Left Multi-File Return	2 Box/File/Lateral File	
VST2084MRC	Right Multi-File Credenza		2 Box/File/Lateral File
VST2084MLC	Left Multi-File Return	2 Box/File/Lateral File	
VST2078MRC	Right Multi-File Credenza		2 Box/File/Lateral File
VST2078MLC	Left Multi-File Return	2 Box/File/Lateral File	
VST2072MRC	Right Multi-File Credenza		2 Box/File/Lateral File
VST2072MLC	Left Multi-File Return	2 Box/File/Lateral File	

Interior Drawer Dimensions	Depth	Width	Height
Box	15"	12"	3 1/4"
File	15"	12"	9 1/8"
Lateral File	15"	26 5/16"	9 1/8"

Filing Options (Diagram 3)



Buffet Credenzas

Model	Description	Drawer Configuration
		Along the Top ²
VST2472BSC	Buffet Credenza ²	4 Box Drawers
VST2436BSC	Buffet Credenza ²	2 Box Drawers

Interior Drawer Dimensions	Depth	Width	Height
Box	15"	14 3/4"	3 1/4"

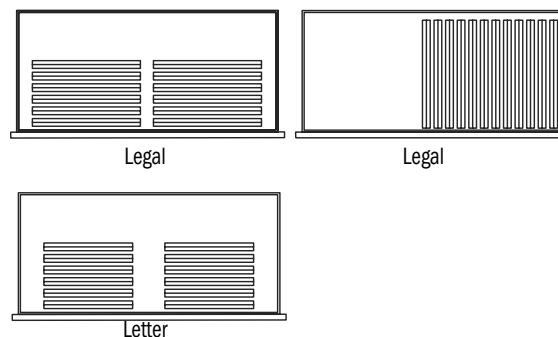
²Bottom Section - Hinge Door Storage

Lateral File Cabinets

Model	Description	Drawer Configuration
		Single Lateral Pedestal Width
VST2036-57LF	4 Drawer Lateral File Cabinet	4 Lateral Drawers
VST2036-42LF	3 Drawer Lateral File Cabinet	3 Lateral Drawers
VST2036-30LF	2 Drawer Lateral File Cabinet	2 Lateral Drawers
VST2436-57LF	4 Drawer Lateral File Cabinet	4 Lateral Drawers
VST2436-42LF	3 Drawer Lateral File Cabinet	3 Lateral Drawers
VST2436-30LF	2 Drawer Lateral File Cabinet	2 Lateral Drawers

Interior Drawer Dimensions	Depth	Width	Height
Lateral File	15"	32 5/16"	9 1/8"

Filing Options (Diagram 5)

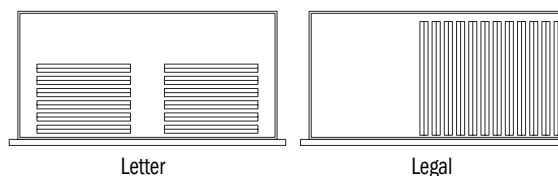


Lateral File Cabinets

Model	Description	Drawer Configuration
		Single Lateral Pedestal Width
VST2030-57LF	4 Drawer Lateral File Cabinet	4 Lateral Drawers
VST2030-42LF	3 Drawer Lateral File Cabinet	3 Lateral Drawers
VST2030-30LF	2 Drawer Lateral File Cabinet	2 Lateral Drawers
VST2430-57LF	4 Drawer Lateral File Cabinet	4 Lateral Drawers
VST2430-42LF	3 Drawer Lateral File Cabinet	3 Lateral Drawers
VST2430-30LF	2 Drawer Lateral File Cabinet	2 Lateral Drawers

Interior Drawer Dimensions	Depth	Width	Height
Lateral File	15"	26 5/16"	9 1/8"

Filing Options (Diagram 6)



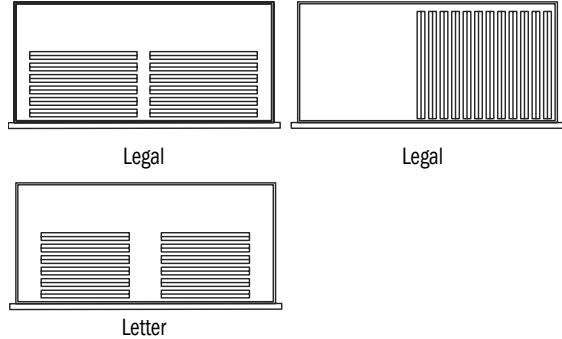
Vision Product Information

Tall Storage Cabinets

Model	Description	Drawer Configuration Single Lateral Pedestal Width
VST2436-84BBFT	Storage Cabinet	Box/Box/Lateral File
VST2436-72BBFT	Storage Cabinet	Box/Box/Lateral File
VST2436-57BBFT	Storage Cabinet	Box/Box/Lateral File
VST2436-84FFT	Storage Cabinet	Lateral File/Lateral File
VST2436-72FFT	Storage Cabinet	Lateral File/Lateral File
VST2436-57FFT	Storage Cabinet	Lateral File/Lateral File
VST2036-84BBFT	Storage Cabinet	Box/Box/Lateral File
VST2036-72BBFT	Storage Cabinet	Box/Box/Lateral File
VST2036-57BBFT	Storage Cabinet	Box/Box/Lateral File
VST2036-84FFT	Storage Cabinet	Lateral File/Lateral File
VST2036-72FFT	Storage Cabinet	Lateral File/Lateral File
VST2036-57FFT	Storage Cabinet	Lateral File/Lateral File

Interior Drawer Dimensions	Depth	Width	Height
Box	15"	32 5/16"	3 1/4"
Lateral File	15"	32 5/16"	9 1/8"

Filing Options (Diagram 5)

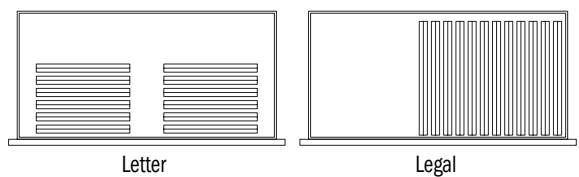


Tall Storage Cabinets

Model	Description	Drawer Configuration Single Lateral Pedestal Width
VST2430-84BBFT	Storage Cabinet	Box/Box/Lateral File
VST2430-72BBFT	Storage Cabinet	Box/Box/Lateral File
VST2430-57BBFT	Storage Cabinet	Box/Box/Lateral File
VST2430-84FFT	Storage Cabinet	Lateral File/Lateral File
VST2430-72FFT	Storage Cabinet	Lateral File/Lateral File
VST2430-57FFT	Storage Cabinet	Lateral File/Lateral File
VST2030-84BBFT	Storage Cabinet	Box/Box/Lateral File
VST2030-72BBFT	Storage Cabinet	Box/Box/Lateral File
VST2030-57BBFT	Storage Cabinet	Box/Box/Lateral File
VST2030-84FFT	Storage Cabinet	Lateral File/Lateral File
VST2030-72FFT	Storage Cabinet	Lateral File/Lateral File
VST2030-57FFT	Storage Cabinet	Lateral File/Lateral File

Interior Drawer Dimensions	Depth	Width	Height
Box	15"	26 5/16"	3 1/4"
Lateral File	15"	26 5/16"	9 1/8"

Filing Options (Diagram 6)

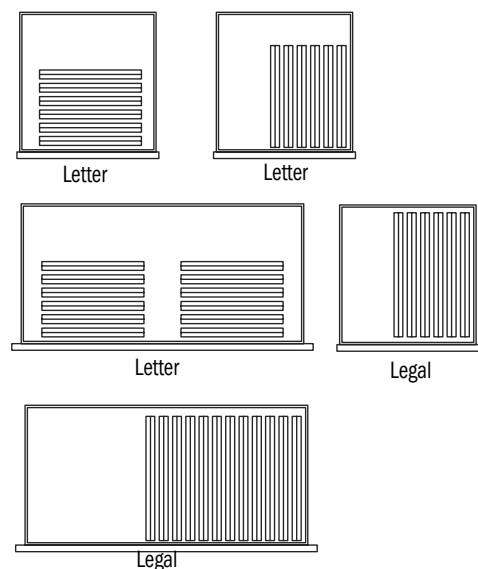


Tall Storage Cabinets

Model	Description	Drawer Configuration Single Pedestal Width
VST2430-84MFR	Storage Cabinet	(Right) Box/Box-File/Lat. File
VST2430-84MFL	Storage Cabinet	(Left) Box/Box-File/Lat. File
VST2430-72MFR	Storage Cabinet	(Right) Box/Box-File/Lat. File
VST2430-72MFL	Storage Cabinet	(Left) Box/Box-File/Lat. File
VST2430-57MFR	Storage Cabinet	(Right) Box/Box-File/Lat. File
VST2430-57MFL	Storage Cabinet	(Left) Box/Box-File/Lat. File
VST2030-84MFR	Storage Cabinet	(Right) Box/Box-File/Lat. File
VST2030-84MFL	Storage Cabinet	(Left) Box/Box-File/Lat. File
VST2030-72MFR	Storage Cabinet	(Right) Box/Box-File/Lat. File
VST2030-72MFL	Storage Cabinet	(Left) Box/Box-File/Lat. File
VST2030-57MFR	Storage Cabinet	(Right) Box/Box-File/Lat. File
VST2030-57MFL	Storage Cabinet	(Left) Box/Box-File/Lat. File

Interior Drawer Dimensions	Depth	Width	Height
Box	15"	12"	3 1/4"
File	15"	12"	9 1/8"
Lateral File	15"	26 5/16"	9 1/8"

Filing Options (Diagram 3)



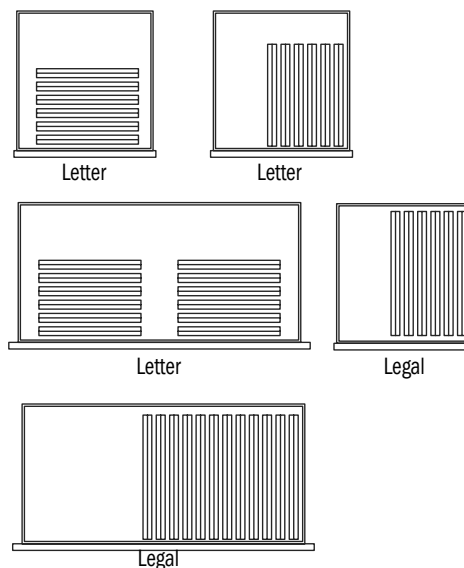
Vision Product Information

Tall Storage Cabinets		Drawer Configuration
Model	Description	Single Pedestal Width
VST2418-84BBFSSTR	Storage Cabinet	Box/Box/File
VST2418-84BBFSSTL	Storage Cabinet	Box/Box/File
VST2418-72BBFSSTR	Storage Cabinet	Box/Box/File
VST2418-72BBFSSTL	Storage Cabinet	Box/Box/File
VST2418-57BBFSSTR	Storage Cabinet	Box/Box/File
VST2418-57BBFSSTL	Storage Cabinet	Box/Box/File
VST2418-84FFSSTR	Storage Cabinet	File/File
VST2418-84FFSSTL	Storage Cabinet	File/File
VST2418-72FFSSTR	Storage Cabinet	File/File
VST2418-72FFSSTL	Storage Cabinet	File/File
VST2418-57FFSSTR	Storage Cabinet	File/File
VST2418-57FFSSTL	Storage Cabinet	File/File
VST2418-84BBFO	Storage Cabinet	Box/Box/File
VST2418-84FFO	Storage Cabinet	File/File
VST2418-84BBFTR	Storage Cabinet	Box/Box/File
VST2418-84BBFTL	Storage Cabinet	Box/Box/File
VST2418-72BBFO	Storage Cabinet	Box/Box/File
VST2418-72FFO	Storage Cabinet	File/File
VST2418-72BBFTR	Storage Cabinet	Box/Box/File
VST2418-72BBFTL	Storage Cabinet	Box/Box/File
VST2418-57BBFO	Storage Cabinet	Box/Box/File
VST2418-57FFO	Storage Cabinet	File/File
VST2418-57BBFTR	Storage Cabinet	Box/Box/File
VST2418-57BBFTL	Storage Cabinet	Box/Box/File
VST2418-84FFTR	Storage Cabinet	File/File
VST2418-84FFTL	Storage Cabinet	File/File
VST2418-72FFTR	Storage Cabinet	File/File
VST2418-72FFTL	Storage Cabinet	File/File
VST2418-57FFTR	Storage Cabinet	File/File
VST2418-57FFTL	Storage Cabinet	File/File
VST2430-84WR	Wardrobe	(Right) Box/Box/File
VST2430-84WL	Wardrobe	(Left) Box/Box/File
VST2430-72WR	Wardrobe	(Right) Box/Box/File
VST2430-72WL	Wardrobe	(Left) Box/Box/File
VST2430-57WR	Wardrobe	(Right) Box/Box/File
VST2430-57WL	Wardrobe	(Left) Box/Box/File
VST2018-84BBFSSTR	Storage Cabinet	Box/Box/File
VST2018-84BBFSSTL	Storage Cabinet	Box/Box/File
VST2018-72BBFSSTR	Storage Cabinet	Box/Box/File
VST2018-72BBFSSTL	Storage Cabinet	Box/Box/File
VST2018-57BBFSSTR	Storage Cabinet	Box/Box/File
VST2018-57BBFSSTL	Storage Cabinet	Box/Box/File
VST2018-84FFSSTR	Storage Cabinet	File/File
VST2018-84FFSSTL	Storage Cabinet	File/File
VST2018-72FFSSTR	Storage Cabinet	File/File
VST2018-72FFSSTL	Storage Cabinet	File/File
VST2018-57FFSSTR	Storage Cabinet	File/File
VST2018-57FFSSTL	Storage Cabinet	File/File

Tall Storage Cabinets (continued):		Drawer Configuration
Model	Description	Single Pedestal Width
VST2018-84BBFO	Storage Cabinet	Box/Box/File
VST2018-84FFO	Storage Cabinet	File/File
VST2018-84BBFTR	Storage Cabinet	Box/Box/File
VST2018-84BBFTL	Storage Cabinet	Box/Box/File
VST2018-72BBFO	Storage Cabinet	Box/Box/File
VST2018-72FFO	Storage Cabinet	File/File
VST2018-72BBFTR	Storage Cabinet	Box/Box/File
VST2018-72BBFTL	Storage Cabinet	Box/Box/File
VST2018-57BBFO	Storage Cabinet	Box/Box/File
VST2018-57FFO	Storage Cabinet	File/File
VST2018-57BBFTR	Storage Cabinet	Box/Box/File
VST2018-57BBFTL	Storage Cabinet	Box/Box/File
VST2018-84FFTR	Storage Cabinet	File/File
VST2018-84FFTL	Storage Cabinet	File/File
VST2018-72FFTR	Storage Cabinet	File/File
VST2018-72FFTL	Storage Cabinet	File/File
VST2018-57FFTR	Storage Cabinet	File/File
VST20418-57FFTL	Storage Cabinet	File/File
VST2030-84WR	Wardrobe	(Right) Box/Box/File
VST2030-84WL	Wardrobe	(Left) Box/Box/File
VST2030-72WR	Wardrobe	(Right) Box/Box/File
VST2030-72WL	Wardrobe	(Left) Box/Box/File
VST2030-57WR	Wardrobe	(Right) Box/Box/File
VST2030-57WL	Wardrobe	(Left) Box/Box/File

Interior Drawer Dimensions	Depth	Width	Height
Box	15"	14 5/16"	3 1/4"
File	15"	14 3/16"	9 1/8"
Lateral File	15"	26 3/16"	9 1/8"

Filing Options (Diagram 3)



Vision Product Information

Modular Pedestals

Model	Description	Drawer Configuration	Interior Drawer Dimensions									File Option Diagram Reference #
			Box			File			Lateral File			
			d	w	h	d	w	h	d	w	h	
VST1630MBBF	Desk Pedestal	Box/Box/File	21"	12"	3 1/4"	21"	12"	9 1/8"	n/a			1
VST1630MFF	Desk Pedestal	File/File	n/a			21"	12"	9 1/8"	n/a			1
VST1624MBBF	Credenza Pedestal	Box/Box/File	15"	12"	3 1/4"	15"	12"	9 1/8"	n/a			2
VST1624MFF	Credenza Pedestal	File/File	n/a			15"	12"	9 1/8"	n/a			2
VST3624MLF	Lateral File - 36" Wide	Lat. File/Lat. File	n/a			n/a			15"	32 5/16"	9 1/8"	5
VST3024MLF	Lateral File - 30" Wide	Lat. File/Lat. File	n/a			n/a			15"	26 5/16"	9 1/8"	6
VST3624MBSC	Buffet Credenza	2 Top Box Drawers	15"	14 3/4"	3 1/4"	n/a			n/a			n/a
VST1636MBBF	Desk Pedestal	Box/Box/File	21"	12"	3 1/4"	21"	12"	9 1/8"	n/a			1
VST1636MFF	Desk Pedestal	File/File	n/a			21"	12"	9 1/8"	n/a			1
VST1620MBBF	Credenza Pedestal	Box/Box/File	15"	12"	3 1/4"	15"	12"	9 1/8"	n/a			2
VST1620MFF	Credenza Pedestal	File/File	n/a			15"	12"	9 1/8"	n/a			2
VST3620MBSC	Buffet Credenza	2 Top Box Drawers	15"	14 3/4"	3 1/4"	n/a			n/a			n/a
VST3620MLF	Lateral File - 36" Wide	Lat. File/Lat. File	n/a			n/a			15"	32 5/16"	9 1/8"	5
VST3020MLF	Lateral File - 30" Wide	Lat. File/Lat. File	n/a			n/a			15"	26 5/16"	9 1/8"	6
VST3020MRM	Multi-File Pedestal	(right) Box/Box/File/Lat. File	15"	12"	3 1/4"	15"	12"	9 1/8"	15"	26 5/16"	9 1/8"	3
VST3020MLM	Multi-File Pedestal	(left) Box/Box/File/Lat. File	15"	12"	3 1/4"	15"	12"	9 1/8"	15"	26 5/16"	9 1/8"	3

Vision Product Information

Finish and Reference Codes - Summary

Select	Code	Select	Code	Select	Code
Veneer/Substrate		Double Cut Finishes		Solid Laminates	
Cherry	CH1	Barrel - Oak Pattern	BAR	Alabaster	ALB
Maple	MA1	Buff - Oak Pattern	BUF	Bridal Blanco	BBL
Walnut	WA1	Cinder - Oak Pattern	CND	Black	BLK
Black Oak	BO1	Coffee	COF	Designer White	DWH
Double Cut	DC1	Egret - Oak Pattern	EGR	Shadow	SHD
		Fawn	FAW	Slate Grey	SLG
		Graphite	GRH		
Finish		Khaki	KHK	Top Edge Details	
Cherry Finishes		Mineral - Oak Pattern	MIN	Eased	R3
Bourbon Medium	BBM	Rye - Oak Pattern	RYE		
Brighton Medium	BRM	Sable - Oak Pattern	SAB	Pull & Finish Codes	
Classic	CLA	Saddle - Oak Pattern	SAD	Bar - Matte Nickel	MBK
Harvest	HRV	Studio Teak	STU	Bar - Polished Nickel	PNK
Praline	PRL	Valley	VAL	Sweep - Matte Black	MBK
				Sweep - Matte Nickel	MNK
Maples Finishes		Veneer Wood Grain Laminates		Delve - Matte Black	MBK
Ale Medium	ALM	Ale Light	ALL	Delve - Arctic Silver	ASL
Butterscotch	BUT	Bourbon Light	BOL	Delve - Pewter	PEW
Flax	FLX	Brazilwood	BZW	Delve - Soft Nickel	SNK
Venetian	VEN	Brighton Light	BGL	Delve - Soft Bronze	SBZ
		Collectors	CLL	Delve - Aged Bronze	ABZ
Walnut Finishes		Fawn	FAW	Delve - Gold	GLD
Espresso	ESP	Florence Walnut	FLO	Prospect - Matte Black	MBK
Mocha	MCH	Graphite	GRH	Prospect - Arctic Silver	ASL
Sienna	SIE	Mineral	MIN	Prospect - Pewter	PEW
Truffle	TRF	Oatmeal Cookie	OAT	Prospect - Matte Nickel	MNL
Umber	UMB	Pinnacle Walnut	PIN	Prospect - Soft Nickel	SNK
		Studio Teak	STU	Prospect - Soft Bronze	SBZ
Black Oak Finishes		Umber	UMB	Prospect - Aged Bronze	ABZ
Raven	RAV	Valley	VAL	Prospect - Gold	GLD
		Vintage	VIN		
		Weathered Ash	WEA	Grommet Finish	
				Matte Black	MBK
				Arctic Silver	ASL
				Drawer Box	
				Wood Drawers	DRM001
				Vinyl Wrapped Drawers	DRM002

Vision Product Information

Finish and Reference Codes - Summary

Select	Code
--------	------

Overhead Cabinet Doors - Glass Options

Frosted - Aluminum Frame
 White Back Painted - Aluminum Frm
 Clear - Wood Frame

Metal Colors

Matte Black	MBK
Arctic Silver	ASL

Select	Code
--------	------

Peninsula Supports

Column Base - Matte Black	MBK
Column Base - Arctic Silver	ASL
Dowel Base - Matte Black	MBK
Dowel Base - Arctic Silver	ASL
Dowel Base - Pewter	PEW
Dowel Base - Soft Nickel	SNK
Dowel Base - Soft Bronze	SBZ
Dowel Base - Aged Bronze	ABZ
Dowel Base - Gold	GLD
Executive Base - Matte Black	MBK
Executive Base - Arctic Silver	ASL
Executive Base - Pewter	PEW
Executive Base - Soft Nickel	SNK
Executive Base - Soft Bronze	SBZ
Executive Base - Aged Bronze	ABZ
Executive Base - Gold	GLD
Perimeter Base - Chrome	CHR
Rectangular Base - Matte Black	MBK
Rectangular Base - Arctic Silver	ASL
Rectangular Base - Pewter	PEW
Rectangular Base - Soft Nickel	SNK
Rectangular Base - Soft Bronze	SBZ
Rectangular Base - Aged Bronze	ABZ
Rectangular Base - Gold	GLD

Adjustable Height Table Base Finish

Electric	
Matte Black	MBK
Arctic Silver	ASL
White	WH
Pneumatic	
Alloy	ALY
Matte Black	MBK

Vision Product Information

Commonly Requested Modifications:

Price

Material/Finish

Low sheen finish on veneer models	5% Upcharge
Upgrade HPL worksurface to Black Matte HPL (traceless)	Add \$25/SQ FT Top width (inches) x top length (inches)/144 = sq ft per top
JSI solid color powdercoat	
Fixed height metal leg (per model #)	Add \$60 list for any of the JSI extended powdercoat bright colors
Drawer pull (per pull)	Add \$60 list for any of the JSI extended powdercoat bright colors
Top grommet cap (per grommet)	Add \$60 list for any of the JSI extended powdercoat bright colors

Size or Configuration

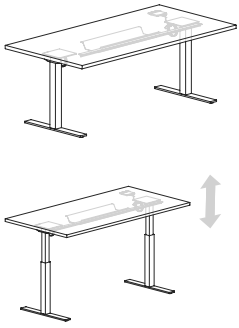
Size change - increase or decrease width 6" or less	Add 20% list
Units not to exceed 96" wide	
TFL, HPL, veneer width only; must not affect drawer size, Glass or metal components	
Change modular lateral file pedestal to BBF drawer config	Add \$192 list
Soft close hinges	Add \$40 list per door
Soft close drawers (not available for lateral file)	Add \$90 list per Drawer

Additional Access Cut Outs

Worksurface grommet in non-standard location (contact customer service for approval of location)	Add \$114 list per location
10" x 10" wall access cut out in modesty panel	Add \$202 list
Door cabinet back panel ventilation slots	
For 1 or 2 door cabinet (single cavity cabinet)	Add \$344 list
For 3 or 4 door cabinet (two cavity cabinet)	Add \$462 list

Description	D	W	H	CTN WT	CU FT	① Model	TFL Laminate	HPL Laminate	Flat Cut Veneer	Double Cut Veneer
Electric Adjustable Height Table Desk - Standard Range 	36	72	Adj	196	12	VST3672AHTD-S	\$1,601	\$1,770		
	36	72	Adj	196	12	VSV3672AHTD-S			\$2,049	\$2,160
	30	84	Adj	196	12	VST3084AHTD-S	\$1,465	\$1,622		
	30	84	Adj	196	12	VSV3084AHTD-S			\$2,086	\$2,203
	30	78	Adj	196	12	VST3078AHTD-S	\$1,455	\$1,588		
	30	78	Adj	196	12	VSV3078AHTD-S			\$1,994	\$2,103
	30	72	Adj	187	12	VST3072AHTD-S	\$1,443	\$1,554		
	30	72	Adj	187	12	VSV3072AHTD-S			\$1,907	\$2,006
	30	66	Adj	177	11	VST3066AHTD-S	\$1,395	\$1,518		
	30	66	Adj	177	11	VSV3066AHTD-S			\$1,829	\$1,919
	30	60	Adj	177	10	VST3060AHTD-S	\$1,346	\$1,479		
	30	60	Adj	177	10	VSV3060AHTD-S			\$1,747	\$1,829
	30	54	Adj	177	10	VST3054AHTD-S	\$1,326	\$1,445		
	30	54	Adj	177	10	VSV3054AHTD-S			\$1,664	\$1,738
	30	48	Adj	177	10	VST3048AHTD-S	\$1,304	\$1,412		
	30	48	Adj	177	10	VSV3048AHTD-S			\$1,582	\$1,647

- 27 3/4" to 47 7/16" height adjustment
- top edge profile on user and approach sides
- top grommet available, specify location; and add \$51 list each
- maximum weight rating 140 lbs. (evenly distributed load)
- push button control pad mounted right or left
- 120" power cord
- specify Matte Black (MBK) or Arctic Silver (ASL) or White (WH) base finish
- ships KD
- casters available, order AHCAST separately
- preset control available, order AH-3PDC separately

Description	D	W	H	CTN WT	CU FT	① Model	TFL Laminate	HPL Laminate	Flat Cut Veneer	Double Cut Veneer
Electric Adjustable Height Table Desk - Standard Range 	24	84	Adj	175	13	VST2484AHTD-S	\$1,443	\$1,535		
	24	84	Adj	175	13	VSV2484AHTD-S			\$1,876	\$1,970
	24	78	Adj	166	12	VST2478AHTD-S	\$1,433	\$1,505		
	24	78	Adj	166	12	VSV2478AHTD-S			\$1,822	\$1,913
	24	72	Adj	157	10	VST2472AHTD-S	\$1,419	\$1,474		
	24	72	Adj	157	10	VSV2472AHTD-S			\$1,729	\$1,811
	24	66	Adj	151	10	VST2466AHTD-S	\$1,389	\$1,443		
	24	66	Adj	151	10	VSV2466AHTD-S			\$1,695	\$1,772
	24	60	Adj	144	9	VST2460AHTD-S	\$1,350	\$1,414		
	24	60	Adj	144	9	VSV2460AHTD-S			\$1,625	\$1,696
	24	54	Adj	144	9	VST2454AHTD-S	\$1,312	\$1,386		
	24	54	Adj	144	9	VSV2454AHTD-S			\$1,614	\$1,684
	24	48	Adj	144	9	VST2448AHTD-S	\$1,288	\$1,358		
	24	48	Adj	144	9	VSV2448AHTD-S			\$1,546	\$1,608

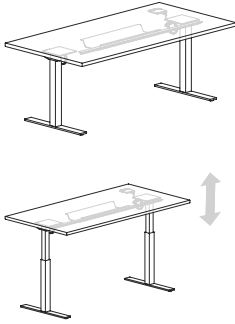
- 27 3/4" to 47 7/16" height adjustment
- top edge profile on user and approach sides
- top grommet available, specify location; and add \$51 list each
- maximum weight rating 140 lbs. (evenly distributed load)
- push button control pad mounted right or left
- 120" power cord
- specify Matte Black (MBK) or Arctic Silver (ASL) or White (WH) base finish
- ships KD
- casters available, order AHCAST separately
- preset control available, order AH-3PDC separately

To Order, Specify:

① Model Number	Laminate - VST	Veneer - VSV	
	② Worksurface Material (see page VI3) a.) TFL b.) HPL	② Wood Species - Cherry (CH1), Maple (MA1) Walnut (WA1), Black Oak (BO1) or Double Cut (DC1) (see page VI1)	④ Edge Profile (see page VI4)
	③ Laminate Color (see page VI3) a.) Worksurface Color b.) Chassis Color c.) Drawer Color	③ Finish Color (see page VI1)	⑤ Pull Style and Color (see page VI5)
			⑥ Optional Grommet Location & Color - Matte Black (MBK) or Arctic Silver (ASL) (see page VI6)
			⑦ Other Product Options (see page VI10)
			⑧ Accessories (see page VS314)
			⑨ Power and Data Options (see page VS324)

Description	D	W	H	CTN WT	CU FT	① Model	TFL Laminate	HPL Laminate	Flat Cut Veneer	Double Cut Veneer
Electric Adjustable Height Table Desk - Extended Range 	36	72	Adj	196	12	VST3672AHTD-E	\$1,755	\$2,004		
	36	72	Adj	196	12	VSV3672AHTD-E			\$2,203	\$2,315
	30	84	Adj	196	12	VST3084AHTD-E	\$1,620	\$1,776		
	30	84	Adj	196	12	VSV3084AHTD-E			\$2,242	\$2,358
	30	78	Adj	196	12	VST3078AHTD-E	\$1,609	\$1,742		
	30	78	Adj	196	12	VSV3078AHTD-E			\$2,149	\$2,257
	30	72	Adj	187	12	VST3072AHTD-E	\$1,598	\$1,709		
	30	72	Adj	187	12	VSV3072AHTD-E			\$2,063	\$2,160
	30	66	Adj	177	11	VST3066AHTD-E	\$1,549	\$1,672		
	30	66	Adj	177	11	VSV3066AHTD-E			\$1,983	\$2,073
	30	60	Adj	177	10	VST3060AHTD-E	\$1,500	\$1,633		
	30	60	Adj	177	10	VSV3060AHTD-E			\$1,901	\$1,983
	30	54	Adj	177	10	VST3054AHTD-E	\$1,480	\$1,600		
	30	54	Adj	177	10	VSV3054AHTD-E			\$1,818	\$1,893
	30	48	Adj	177	10	VST3048AHTD-E	\$1,458	\$1,567		
	30	48	Adj	177	10	VSV3048AHTD-E			\$1,737	\$1,802

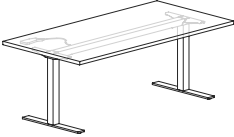
- 22 7/8" to 48 7/8" height adjustment
- top edge profile on user and approach sides
- top grommet available, specify location; and add \$51 list each
- maximum weight rating 140 lbs. (evenly distributed load)
- push button control pad mounted right or left
- key pad features height display with three memory settings
- display will reference position to the nearest 1/2"
- 120" power cord
- specify Matte Black (MBK) or Arctic Silver (ASL) or White (WH) base finish
- ships KD
- casters available, order AHCAST separately

Description	D	W	H	CTN WT	CU FT	① Model	TFL Laminate	HPL Laminate	Flat Cut Veneer	Double Cut Veneer
Electric Adjustable Height Table Desk - Extended Range 	24	84	Adj	151	12	VST2484AHTD-E	\$1,598	\$1,689		
	24	84	Adj	151	12	VSV2484AHTD-E			\$2,030	\$2,126
	24	78	Adj	151	12	VST2478AHTD-E	\$1,587	\$1,659		
	24	78	Adj	151	12	VSV2478AHTD-E			\$1,977	\$2,067
	24	72	Adj	157	10	VST2472AHTD-E	\$1,573	\$1,628		
	24	72	Adj	157	10	VSV2472AHTD-E			\$1,884	\$1,965
	24	66	Adj	151	10	VST2466AHTD-E	\$1,543	\$1,598		
	24	66	Adj	151	10	VSV2466AHTD-E			\$1,850	\$1,926
	24	60	Adj	144	9	VST2460AHTD-E	\$1,504	\$1,568		
	24	60	Adj	144	9	VSV2460AHTD-E			\$1,780	\$1,851
	24	54	Adj	144	9	VST2454AHTD-E	\$1,466	\$1,542		
	24	54	Adj	144	9	VSV2454AHTD-E			\$1,770	\$1,838
	24	48	Adj	144	9	VST2448AHTD-E	\$1,431	\$1,512		
	24	48	Adj	144	9	VSV2448AHTD-E			\$1,700	\$1,762

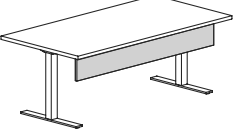
- 22 7/8" to 48 7/8" height adjustment
- top edge profile on user and approach sides
- top grommet available, specify location; and add \$51 list each
- maximum weight rating 140 lbs. (evenly distributed load)
- push button control pad mounted right or left
- key pad features height display with three memory settings
- display will reference position to the nearest 1/2"
- 120" power cord
- specify Matte Black (MBK) or Arctic Silver (ASL) or White (WH) base finish
- ships KD
- casters available, order AHCAST separately

To Order, Specify:

① Model Number	Laminate - VST	Veneer - VSV	
	② Worksurface Material (see page VI3) a.) TFL b.) HPL	② Wood Species - Cherry (CH1), Maple (MA1) Walnut (WA1), Black Oak (BO1) or Double Cut (DC1) (see page VI1)	④ Edge Profile (see page VI4)
	③ Laminate Color (see page VI3) a.) Worksurface Color b.) Chassis Color c.) Drawer Color	③ Finish Color (see page VI1)	⑤ Pull Style and Color (see page VI5)
			⑥ Optional Grommet Location & Color - Matte Black (MBK) or Arctic Silver (ASL) (see page VI6)
			⑦ Other Product Options (see page VI10)
			⑧ Accessories (see page VS314)
			⑨ Power and Data Options (see page VS324)

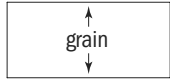
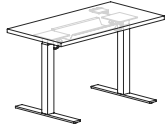
Description	D	W	H	CTN WT	CU FT	① Model	TFL Laminate	HPL Laminate	Flat Cut Veneer	Double Cut Veneer
Pneumatic Adjustable Height Table Desk 	36	72	Adj	194	18	VST3672AHTD-PN	\$4,098	\$4,410		
	36	72	Adj	194	18	VSV3672AHTD-PN			\$5,218	\$5,740
	30	72	Adj	175	16	VST3072AHTD-PN	\$4,059	\$4,318		
	30	72	Adj	175	16	VSV3072AHTD-PN			\$4,992	\$5,492
	30	66	Adj	168	15	VST3066AHTD-PN	\$3,989	\$4,229		
	30	66	Adj	168	15	VSV3066AHTD-PN			\$4,845	\$5,331
	30	60	Adj	160	14	VST3060AHTD-PN	\$3,914	\$4,131		
	30	60	Adj	160	14	VSV3060AHTD-PN			\$4,691	\$5,162
	24	72	Adj	151	12	VST2472AHTD-PN	\$3,929	\$4,136		
	24	72	Adj	151	12	VSV2472AHTD-PN			\$4,675	\$5,144
	24	66	Adj	146	11	VST2466AHTD-PN	\$3,909	\$4,099		
	24	66	Adj	146	11	VSV2466AHTD-PN			\$4,594	\$5,054
	24	60	Adj	140	10	VST2460AHTD-PN	\$3,874	\$4,044		
	24	60	Adj	140	10	VSV2460AHTD-PN			\$4,494	\$4,944

- 27 1/2" to 44 1/2" height adjustment
- top edge profile on user and approach sides
- top grommet available, specify location; and add \$51 list each
- release lever mounts under edge of top
- 20 lb. lift force/max weight rating 140 lbs. (evenly distributed load)
- specify Matte Black or Alloy base finish
- ships KD

Description	D	W	H	CTN WT	CU FT	① Model	Laminate	Flat Cut Veneer	Double Cut Veneer
Modesty Panel for Adjustable Height Tables 	3/4	76	9	20	3	VST0976TDM	\$233		
	3/4	76	9	20	3	VSV0976TDM		\$406	\$447
	3/4	70	9	20	3	VST0970TDM	\$226		
	3/4	70	9	20	3	VSV0970TDM		\$396	\$437
	3/4	64	9	18	2	VST0964TDM	\$221		
	3/4	64	9	18	2	VSV0964TDM		\$383	\$422
	3/4	58	9	16	3	VST0958TDM	\$217		
	3/4	58	9	16	3	VSV0958TDM		\$373	\$412
	3/4	52	9	14	2	VST0952TDM	\$204		
	3/4	52	9	14	2	VSV0952TDM		\$360	\$397
	3/4	46	9	12	2	VST0946TDM	\$191		
	3/4	46	9	12	2	VSV0946TDM		\$348	\$383
	3/4	40	9	10	2	VST0940TDM	\$189		
3/4	40	9	10	2	VSV0940TDM		\$340	\$375	

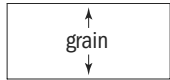
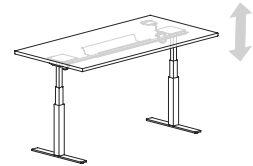
- VST0976TDM or VSV0976TDM use with 84" w adjustable height desk
- VST0970TDM or VSV0970TDM use with 78" w adjustable height desk
- VST0964TDM or VSV0964TDM use with 72" w adjustable height desk
- VST0958TDM or VSV0958TDM use with 66" w adjustable height desk
- VST0952TDM or VSV0952TDM use with 60" w adjustable height desk
- VST0946TDM or VSV0946TDM use with 54" w adjustable height desk
- VST0940TDM or VSV0940TDM use with 48" w adjustable height desk
- flat edge detail
- modesty panel bracket is always Black

Description	D	W	H	CTN WT	CU FT	① Model	TFL Laminate	HPL Laminate	Flat Cut Veneer	Double Cut Veneer
Electric Adjustable Height Bridge - Standard Range	24	58	Adj	90	9	VST2458AHB-S	\$1,350	\$1,414		
	24	58	Adj	90	9	VSV2458AHB-S			\$1,625	\$1,696
	24	52	Adj	85	8	VST2452AHB-S	\$1,312	\$1,386		
	24	52	Adj	85	8	VSV2452AHB-S			\$1,614	\$1,684
	24	46	Adj	85	8	VST2446AHB-S	\$1,288	\$1,358		
	24	46	Adj	85	8	VSV2446AHB-S			\$1,546	\$1,608



- 27 3/4" to 47 7/16" height adjustment
- top edge profile on user and approach sides
- top grommet available, specify location; and add \$51 list each
- maximum weight rating 140 lbs. (evenly distributed load)
- push button control pad mounted right or left
- 120" power cord
- specify Matte Black (MBK), Arctic Silver (ASL) or White (WH) base finish
- ships KD
- 1" gap between credenza or desk top avoids pinch point
- casters available, order AHCAST separately
- preset control available, order AH-3PDC separately

Electric Adjustable Height Bridge - Extended Range	24	58	Adj	144	9	VST2458AHB-E	\$1,504	\$1,568		
	24	58	Adj	144	9	VSV2458AHB-E			\$1,780	\$1,851
	24	52	Adj	138	9	VST2452AHB-E	\$1,466	\$1,542		
	24	52	Adj	138	9	VSV2452AHB-E			\$1,770	\$1,838
	24	46	Adj	90	9	VST2446AHB-E	\$1,431	\$1,512		
	24	46	Adj	90	9	VSV2446AHB-E			\$1,700	\$1,762



- 22 7/8" to 48 7/8" height adjustment
- top edge profile on user and approach sides
- top grommet available, specify location, and add \$51 list each
- maximum weight rating 140 lbs. (evenly distributed load)
- push button control pad mounted right or left
- key pad features height display with three memory settings
- display will reference position to the nearest 1/2"
- 1" gap between credenza or desk top avoids pinch point
- 120" power cord
- specify Matte Black (MBK), Arctic Silver (ASL) or White (WH) base finish
- ships KD
- casters available, order AHCAST separately

To Order, Specify:

① Model Number

Laminate - VST

Veneer - VSV

② Worksurface Material (see page VI3)

a.) TFL

b.) HPL

③ Laminate Color (see page VI3)

a.) Worksurface Color

b.) Chassis Color

c.) Drawer Color

② Wood Species - Cherry (CH1), Maple (MA1)

Walnut (WA1), Black Oak (BO1) or

Double Cut (DC1) (see page VI1)

③ Finish Color (see page VI1)

④ Edge Profile (see page VI4)

⑤ Pull Style and Color (see page VI5)

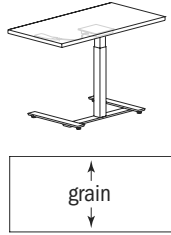
⑥ Optional Grommet Location & Color - Matte Black (MBK) or Arctic Silver (ASL) (see page VI6)

⑦ Other Product Options (see page VI10)

⑧ Accessories (see page VS314)

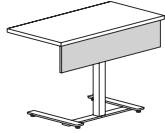
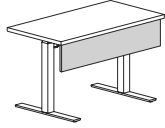
⑨ Power and Data Options (see page VS324)

Description	D	W	H	CTN WT	CU FT	① Model	TFL Laminate	HPL Laminate	Flat Cut Veneer	Double Cut Veneer
Pneumatic Adjustable Height Bridge	24	46	Adj	90	9	VST2446AHB-PN	\$2,994	\$3,128		
	24	46	Adj	90	9	VSV2446AHB-PN			\$4,103	\$4,513
	24	40	Adj	85	8	VST2440AHB-PN	\$2,927	\$3,027		
	24	40	Adj	85	8	VSV2440AHB-PN			\$4,002	\$4,404



- 27 1/2" to 44 1/2" height adjustment
- top grommet available, specify location, and add \$51 list each
- top edge profile on user and approach sides
- release lever mounts under edge of top
- may be used in place of standard bridge
- 1" gap between credenza or desk top avoids pinch point
- can be used as freestanding table
- 20 lb. lift force/max weight rating 140 lbs. (evenly distributed load)
- specify Matte Black (MBK) or Alloy base finish (ALY)
- ships KD

Description	D	W	H	CTN WT	CU FT	① Model	Laminate	Flat Cut Veneer	Double Cut Veneer
Modesty Panel for Adjustable Height Bridge	¾	46	9	12	2	VST0946TDM	\$191		
	¾	46	9	12	2	VSV0946TDM		\$348	\$383
	¾	40	9	10	2	VST0940TDM	\$189		
	¾	40	9	10	2	VSV0940TDM		\$340	\$375



- VST0946TDM use with 46" w adjustable height bridge
- VST0940TDM use with 40" w adjustable height bridge
- modesty panel bracket is always Black

To Order, Specify:

① Model Number

Laminate - VST

Veneer - VSV

② Worksurface Material (see page VI3)

- a.) TFL
- b.) HPL

② Wood Species - Cherry (CH1), Maple (MA1)

- Walnut (WA1), Black Oak (BO1) or
- Double Cut (DC1) (see page VI1)

④ Edge Profile (see page VI4)

⑤ Pull Style and Color (see page VI5)

③ Laminate Color (see page VI3)

- a.) Worksurface Color
- b.) Chassis Color
- c.) Drawer Color

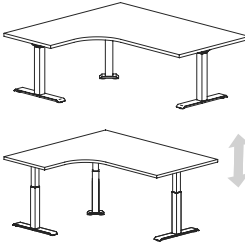
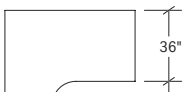
③ Finish Color (see page VI1)

⑥ Optional Grommet Location & Color -
Matte Black (MBK) or Arctic Silver (ASL)
(see page VI6)

⑦ Other Product Options (see page VI10)

⑧ Accessories (see page VS314)

⑨ Power and Data Options (see page VS324)

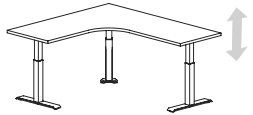
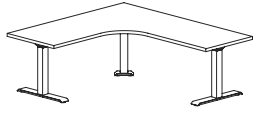
Description	D	W	H	CTN WT	CU FT	① Model	TFL Laminate	HPL Laminate	Flat Cut Veneer	Double Cut Veneer
Adjustable Height Corner Table - 90° One Piece Top - Standard Range - 36"d Desk  left shown 	60	72	Adj	240	12	VST3672CT24AHR-S	\$2,675	\$2,887		
	60	72	Adj	240	12	VSV3672CT24AHR-S			\$3,270	\$3,442
	60	72	Adj	240	12	VST3672CT24AHL-S	\$2,675	\$2,887		
	60	72	Adj	240	12	VSV3672CT24AHL-S			\$3,270	\$3,442
	60	66	Adj	227	12	VST3666CT24AHR-S	\$2,644	\$2,841		
	60	66	Adj	227	12	VSV3666CT24AHR-S			\$3,199	\$3,365
	60	66	Adj	227	12	VST3666CT24AHL-S	\$2,644	\$2,841		
	60	66	Adj	227	12	VSV3666CT24AHL-S			\$3,199	\$3,365
	60	60	Adj	213	12	VST3660CT24AHR-S	\$2,615	\$2,795		
	60	60	Adj	213	12	VSV3660CT24AHR-S			\$3,160	\$3,323
	60	60	Adj	213	12	VST3660CT24AHL-S	\$2,615	\$2,795		
	60	60	Adj	213	12	VSV3660CT24AHL-S			\$3,160	\$3,323

- 27 3/4" to 47 7/16" height adjustment
- top edge profile on user and approach sides
- top grommet available, specify location; and add \$51 list each
- maximum weight rating 140 lbs. (evenly distributed load)
- push botton control pad mounted right or left
- 120" power cord
- specify Matte Black (MBK), Arctic Silver (ASL) or White (WH) base finish
- ships KD
- preset control available, order AH-3PDC separately

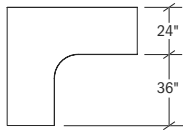
Adjustable Height Corner Table - 90° One Piece Top - Standard Range - 30"d Desk  left shown 	60	72	Adj	240	12	VST3072CT30AHR-S	\$2,675	\$2,887		
	60	72	Adj	240	12	VSV3072CT30AHR-S			\$3,270	\$3,442
	60	72	Adj	240	12	VST3072CT30AHL-S	\$2,675	\$2,887		
	60	72	Adj	240	12	VSV3072CT30AHL-S			\$3,270	\$3,442
	60	66	Adj	227	12	VST3066CT30AHR-S	\$2,644	\$2,841		
	60	66	Adj	227	12	VSV3066CT30AHR-S			\$3,199	\$3,365
	60	66	Adj	227	12	VST3066CT30AHL-S	\$2,644	\$2,841		
	60	66	Adj	227	12	VSV3066CT30AHL-S			\$3,199	\$3,365
	60	60	Adj	213	12	VST3060CT30AHR-S	\$2,615	\$2,795		
	60	60	Adj	213	12	VSV3060CT30AHR-S			\$3,160	\$3,323
	60	60	Adj	213	12	VST3060CT30AHL-S	\$2,615	\$2,795		
	60	60	Adj	213	12	VSV3060CT30AHL-S			\$3,160	\$3,323

- 27 3/4" to 47 7/16" height adjustment
- top edge profile on user and approach sides
- top grommet available, specify location; and add \$51 list each
- maximum weight rating 140 lbs. (evenly distributed load)
- push botton control pad mounted right or left
- 120" power cord
- specify Matte Black (MBK), Arctic Silver (ASL) or White (WH) base finish
- ships KD
- preset control available, order AH-3PDC separately

Description	D	W	H	CTN WT	CU FT	① Model	TFL Laminate	HPL Laminate	Flat Cut Veneer	Double Cut Veneer
Adjustable Height Corner Table - 90° One Piece Top - Standard Range - 24" d Desk	60	72	Adj	232	12	VST2472CT36AHR-S	\$2,675	\$2,887		
	60	72	Adj	232	12	VSV2472CT36AHR-S			\$3,270	\$3,442
	60	72	Adj	232	12	VST2472CT36AHL-S	\$2,675	\$2,887		
	60	72	Adj	232	12	VSV2472CT36AHL-S			\$3,270	\$3,442
	60	66	Adj	222	12	VST2466CT36AHR-S	\$2,644	\$2,841		
	60	66	Adj	222	12	VSV2466CT36AHR-S			\$3,199	\$3,365
	60	66	Adj	222	12	VST2466CT36AHL-S	\$2,644	\$2,841		
	60	66	Adj	222	12	VSV2466CT36AHL-S			\$3,199	\$3,365
	60	60	Adj	207	12	VST2460CT36AHR-S	\$2,615	\$2,795		
	60	60	Adj	207	12	VSV2460CT36AHR-S			\$3,160	\$3,323
	60	60	Adj	207	12	VST2460CT36AHL-S	\$2,615	\$2,795		
	60	60	Adj	207	12	VSV2460CT36AHL-S			\$3,160	\$3,323



left shown



- 27 3/4" to 47 7/16" height adjustment
- top edge profile on user and approach sides
- top grommet available, specify location; and add \$51 list each
- maximum weight rating 140 lbs. (evenly distributed load)
- push button control pad mounted right or left
- 120" power cord
- specify Matte Black (MBK), Arctic Silver (ASL) or White (WH) base finish
- ships KD
- preset control available, order AH-3PDC separately

To Order, Specify:

① Model Number

Laminate - VST

Veneer - VSV

② Worksurface Material (see page VI3)

- a.) TFL
- b.) HPL

② Wood Species - Cherry (CH1), Maple (MA1)

- Walnut (WA1), Black Oak (BO1) or
- Double Cut (DC1) (see page VI1)

④ Edge Profile (see page VI4)

⑤ Pull Style and Color (see page VI5)

⑥ Optional Grommet Location & Color -
Matte Black (MBK) or Arctic Silver (ASL)
(see page VI6)

③ Laminate Color (see page VI3)

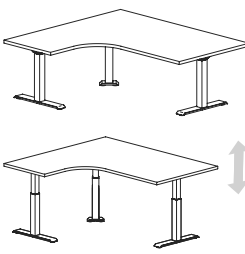
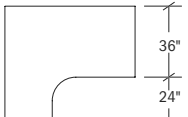
- a.) Worksurface Color
- b.) Chassis Color
- c.) Drawer Color

③ Finish Color (see page VI1)

⑦ Other Product Options (see page VI10)

⑧ Accessories (see page VS314)

⑨ Power and Data Options (see page VS324)

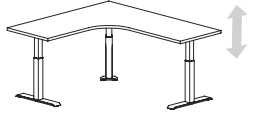
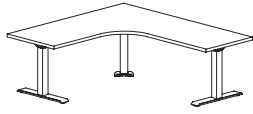
Description	D	W	H	CTN WT	CU FT	① Model	TFL Laminate	HPL Laminate	Flat Cut Veneer	Double Cut Veneer
Adjustable Height Corner Table - 90° One Piece Top - Extended Range - 36" d Desk  left shown 	60	72	Adj	259	33	VST3672CT24AHR-E	\$2,891	\$3,103		
	60	72	Adj	259	33	VSV3672CT24AHR-E			\$3,486	\$3,659
	60	72	Adj	259	33	VST3672CT24AHL-E	\$2,891	\$3,103		
	60	72	Adj	259	33	VSV3672CT24AHL-E			\$3,486	\$3,659
	60	66	Adj	240	31	VST3666CT24AHR-E	\$2,861	\$3,057		
	60	66	Adj	240	31	VSV3666CT24AHR-E			\$3,415	\$3,581
	60	66	Adj	240	31	VST3666CT24AHL-E	\$2,861	\$3,057		
	60	66	Adj	240	31	VSV3666CT24AHL-E			\$3,415	\$3,581
	60	60	Adj	231	28	VST3660CT24AHR-E	\$2,830	\$3,011		
	60	60	Adj	231	28	VSV3660CT24AHR-E			\$3,376	\$3,539
	60	60	Adj	231	28	VST3660CT24AHL-E	\$2,830	\$3,011		
	60	60	Adj	231	28	VSV3660CT24AHL-E			\$3,376	\$3,539

- 22 7/8" to 48 7/8" height adjustment
- top edge profile on user and approach sides
- top grommet available, specify location; and add \$51 list each
- maximum weight rating 140 lbs. (evenly distributed load)
- push button control pad mounted right or left
- key pad features height display with three memory settings
- display will reference position to the nearest 1/2"
- 120" power cord
- specify Matte Black (MBK) or Arctic Silver (ASL) or White (WH) base finish
- ships KD

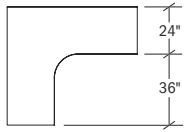
Adjustable Height Corner Table - 90° One Piece Top - Extended Range - 30" d Desk  left shown 	60	72	Adj	234	33	VST3072CT30AHR-E	\$2,891	\$3,103		
	60	72	Adj	234	33	VSV3072CT30AHR-E			\$3,486	\$3,659
	60	72	Adj	234	33	VST3072CT30AHL-E	\$2,891	\$3,103		
	60	72	Adj	234	33	VSV3072CT30AHL-E			\$3,486	\$3,659
	60	66	Adj	230	31	VST3066CT30AHR-E	\$2,861	\$3,057		
	60	66	Adj	230	31	VSV3066CT30AHR-E			\$3,415	\$3,581
	60	66	Adj	230	31	VST3066CT30AHL-E	\$2,861	\$3,057		
	60	66	Adj	230	31	VSV3066CT30AHL-E			\$3,415	\$3,581
	60	60	Adj	222	28	VST3060CT30AHR-E	\$2,830	\$3,011		
	60	60	Adj	222	28	VSV3060CT30AHR-E			\$3,376	\$3,539
	60	60	Adj	222	28	VST3060CT30AHL-E	\$2,830	\$3,011		
	60	60	Adj	222	28	VSV3060CT30AHL-E			\$3,376	\$3,539

- 22 7/8" to 48 7/8" height adjustment
- top edge profile on user and approach sides
- top grommet available, specify location; and add \$51 list each
- maximum weight rating 140 lbs. (evenly distributed load)
- push button control pad mounted right or left
- key pad features height display with three memory settings
- display will reference position to the nearest 1/2"
- 120" power cord
- specify Matte Black (MBK), Arctic Silver (ASL) or White (WH) base finish
- ships KD

Description	D	W	H	CTN WT	CU FT	① Model	TFL Laminate	HPL Laminate	Flat Cut Veneer	Double Cut Veneer
Adjustable Height Corner Table - 90° One Piece Top - Extended Range - 24" d Desk	60	72	Adj	225	33	VST2472CT36AHR-E	\$2,891	\$3,103		
	60	72	Adj	225	33	VSV2472CT36AHR-E			\$3,486	\$3,659
	60	72	Adj	225	33	VST2472CT36AHL-E	\$2,891	\$3,103		
	60	72	Adj	225	33	VSV2472CT36AHL-E			\$3,486	\$3,659
	60	66	Adj	220	31	VST2466CT36AHR-E	\$2,861	\$3,057		
	60	66	Adj	220	31	VSV2466CT36AHR-E			\$3,415	\$3,581
	60	66	Adj	220	31	VST2466CT36AHL-E	\$2,861	\$3,057		
	60	66	Adj	220	31	VSV2466CT36AHL-E			\$3,415	\$3,581
	60	60	Adj	214	28	VST2460CT36AHR-E	\$2,830	\$3,011		
	60	60	Adj	214	28	VSV2460CT36AHR-E			\$3,376	\$3,539
	60	60	Adj	214	28	VST2460CT36AHL-E	\$2,830	\$3,011		
	60	60	Adj	214	28	VSV2460CT36AHL-E			\$3,376	\$3,539



left shown



- 22 7/8" to 48 7/8" height adjustment
- top edge profile on user and approach sides
- top grommet available, specify location; and add \$51 list each
- maximum weight rating 140 lbs. (evenly distributed load)
- push button control pad mounted right or left
- key pad features height display with three memory settings
- display will reference position to the nearest 1/2"
- 120" power cord
- specify Matte Black (MBK), Arctic Silver (ASL) or White (WH) base finish
- ships KD

To Order, Specify:

① Model Number

Laminate - VST

Veneer - VSV

② Worksurface Material (see page VI3)

a.) TFL

b.) HPL

③ Laminate Color (see page VI3)

a.) Worksurface Color

b.) Chassis Color

c.) Drawer Color

② Wood Species - Cherry (CH1), Maple (MA1)

Walnut (WA1), Black Oak (BO1) or

Double Cut (DC1) (see page VI1)

③ Finish Color (see page VI1)

④ Edge Profile (see page VI4)

⑤ Pull Style and Color (see page VI5)

⑥ Optional Grommet Location & Color -
Matte Black (MBK) or Arctic Silver (ASL)
(see page VI6)

⑦ Other Product Options (see page VI10)

⑧ Accessories (see page VS314)

⑨ Power and Data Options (see page VS324)

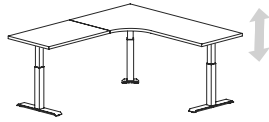
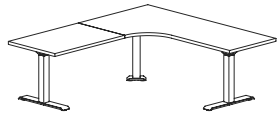
Description	D	W	H	CTN WT	CU FT	① Model	TFL Laminate	HPL Laminate	Flat Cut Veneer	Double Cut Veneer
Adjustable Height Corner Table - 90° Two Piece Top - Standard Range - 36"d Desk left shown 	72	60	Adj	209	16	VST3672CT36AHR-S	\$2,832	\$3,052		
	72	72	Adj	288	19	VSV3672CT36AHR-S			\$3,729	\$3,947
	72	72	Adj	288	19	VST3672CT36AHL-S	\$2,832	\$3,052		
	72	72	Adj	288	19	VSV3672CT36AHL-S			\$3,729	\$3,947
	72	66	Adj	219	18	VST3666CT36AHR-S	\$2,807	\$3,016		
	72	66	Adj	219	18	VSV3666CT36AHR-S			\$3,668	\$3,881
	72	66	Adj	219	18	VST3666CT36AHL-S	\$2,807	\$3,016		
	72	66	Adj	219	18	VSV3666CT36AHL-S			\$3,668	\$3,881
	72	60	Adj	209	16	VST3660CT36AHR-S	\$2,783	\$2,979		
	72	60	Adj	209	16	VSV3660CT36AHR-S			\$3,635	\$3,845
	72	60	Adj	209	16	VST3660CT36AHL-S	\$2,783	\$2,979		
	72	60	Adj	209	16	VSV3660CT36AHL-S			\$3,635	\$3,845

- 27 3/4" to 47 7/16" height adjustment
- top edge profile on user and approach sides
- top grommet available, specify location; and add \$51 list each
- maximum weight rating 140 lbs. (evenly distributed load)
- push botton control pad mounted right or left
- 120" power cord
- specify Matte Black (MBK), Arctic Silver (ASL) or White (WH) base finish
- ships KD
- preset control available, order AH-3PDC separately

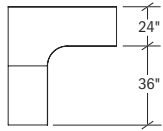
Adjustable Height Corner Table - 90° Two Piece Top - Standard Range - 30"d Desk left shown 	72	72	Adj	209	19	VST3072CT42AHR-S	\$2,795	\$3,008		
	72	72	Adj	209	19	VSV3072CT42AHR-S			\$3,663	\$3,876
	72	72	Adj	209	19	VST3072CT42AHL-S	\$2,795	\$3,008		
	72	72	Adj	209	19	VSV3072CT42AHL-S			\$3,663	\$3,876
	72	66	Adj	201	18	VST3066CT42AHR-S	\$2,770	\$2,972		
	72	66	Adj	201	18	VSV3066CT42AHR-S			\$3,605	\$3,811
	72	66	Adj	201	18	VST3066CT42AHL-S	\$2,770	\$2,972		
	72	66	Adj	201	18	VSV3066CT42AHL-S			\$3,605	\$3,811
	72	60	Adj	193	16	VST3060CT42AHR-S	\$2,746	\$2,934		
	72	60	Adj	193	16	VSV3060CT42AHR-S			\$3,573	\$3,775
	72	60	Adj	193	16	VST3060CT42AHL-S	\$2,746	\$2,934		
	72	60	Adj	193	16	VSV3060CT42AHL-S			\$3,573	\$3,775

- 27 3/4" to 47 7/16" height adjustment
- top edge profile on user and approach sides
- top grommet available, specify location; and add \$51 list each
- maximum weight rating 140 lbs. (evenly distributed load)
- push botton control pad mounted right or left
- 120" power cord
- specify Matte Black (MBK), Arctic Silver (ASL) or White (WH) base finish
- ships KD
- preset control available, order AH-3PDC separately

Description	D	W	H	CTN WT	CU FT	① Model	TFL Laminate	HPL Laminate	Flat Cut Veneer	Double Cut Veneer
Adjustable Height Corner Table - 90° Two Piece Top - Standard Range - 24" d Desk	72	72	Adj	186	17	VST2472CT48AHR-S	\$2,757	\$2,965		
	72	72	Adj	186	17	VSV2472CT48AHR-S			\$3,601	\$3,807
	72	72	Adj	186	17	VST2472CT48AHL-S	\$2,757	\$2,965		
	72	72	Adj	186	17	VSV2472CT48AHL-S			\$3,601	\$3,807
	72	66	Adj	183	16	VST2466CT48AHR-S	\$2,734	\$2,930		
	72	66	Adj	183	16	VSV2466CT48AHR-S			\$3,544	\$3,745
	72	66	Adj	183	16	VST2466CT48AHL-S	\$2,734	\$2,930		
	72	66	Adj	183	16	VSV2466CT48AHL-S			\$3,544	\$3,745
	72	60	Adj	176	16	VST2460CT48AHR-S	\$2,712	\$2,893		
	72	60	Adj	176	16	VSV2460CT48AHR-S			\$3,513	\$3,709
	72	60	Adj	176	16	VST2460CT48AHL-S	\$2,712	\$2,893		
	72	60	Adj	176	16	VSV2460CT48AHL-S			\$3,513	\$3,709



left shown



- 27 3/4" to 47 7/16" height adjustment
- top edge profile on user and approach sides
- top grommet available, specify location; and add \$51 list each
- maximum weight rating 140 lbs. (evenly distributed load)
- push button control pad mounted right or left
- 120" power cord
- specify Matte Black (MBK), Arctic Silver (ASL) or White (WH) base finish
- ships KD
- preset control available, order AH-3PDC separately

To Order, Specify:

① Model Number

Laminate - VST

Veneer - VSV

② Worksurface Material (see page VI3)

- a.) TFL
- b.) HPL

② Wood Species - Cherry (CH1), Maple (MA1)

- Walnut (WA1), Black Oak (BO1) or
- Double Cut (DC1) (see page VI1)

④ Edge Profile (see page VI4)

⑤ Pull Style and Color (see page VI5)

③ Laminate Color (see page VI3)

- a.) Worksurface Color
- b.) Chassis Color
- c.) Drawer Color

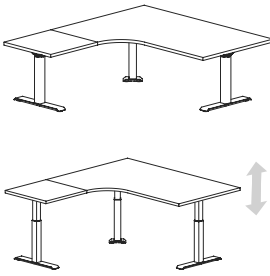
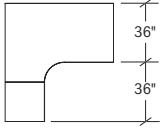
③ Finish Color (see page VI1)

⑥ Optional Grommet Location & Color - Matte Black (MBK) or Arctic Silver (ASL) (see page VI6)

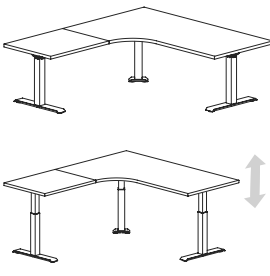
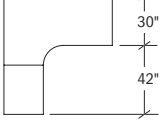
⑦ Other Product Options (see page VI10)

⑧ Accessories (see page VS314)

⑨ Power and Data Options (see page VS324)

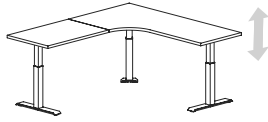
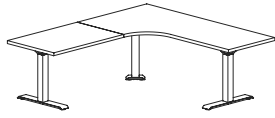
Description	D	W	H	CTN WT	CU FT	① Model	TFL Laminate	HPL Laminate	Flat Cut Veneer	Double Cut Veneer
Adjustable Height Corner Table - 90° Two Piece Top - Extended Range - 36"d Desk  left shown 	72	72	Adj	255	27	VST3672CT36AHR-E	\$3,049	\$3,268		
	72	72	Adj	255	27	VSV3672CT36AHR-E			\$3,945	\$4,164
	72	72	Adj	255	27	VST3672CT36AHL-E	\$3,049	\$3,268		
	72	72	Adj	255	27	VSV3672CT36AHL-E			\$3,945	\$4,164
	72	66	Adj	247	25	VST3666CT36AHR-E	\$3,023	\$3,232		
	72	66	Adj	247	25	VSV3666CT36AHR-E			\$3,884	\$4,098
	72	66	Adj	247	25	VST3666CT36AHL-E	\$3,023	\$3,232		
	72	66	Adj	247	25	VSV3666CT36AHL-E			\$3,884	\$4,098
	72	60	Adj	237	23	VST3660CT36AHR-E	\$2,999	\$3,196		
	72	60	Adj	237	23	VSV3660CT36AHR-E			\$3,851	\$4,060
	72	60	Adj	237	23	VST3660CT36AHL-E	\$2,999	\$3,196		
	72	60	Adj	237	23	VSV3660CT36AHL-E			\$3,851	\$4,060

- 22⁷/₈" to 48⁷/₈" height adjustment
- top edge profile on user and approach sides
- top grommet available, specify location; and add \$51 list each
- maximum weight rating 140 lbs. (evenly distributed load)
- push button control pad mounted right or left
- key pad features height display with three memory settings
- display will reference position to the nearest 1/2"
- 120" power cord
- specify Matte Black (MBK), Arctic Silver (ASL) or White (WH) base finish
- ships KD

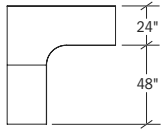
Adjustable Height Corner Table - 90° Two Piece Top - Extended Range - 30"d Desk  left shown 	72	72	Adj	223	24	VST3072CT42AHR-E	\$3,011	\$3,224		
	72	72	Adj	223	24	VSV3072CT42AHR-E			\$3,880	\$4,092
	72	72	Adj	223	24	VST3072CT42AHL-E	\$3,011	\$3,224		
	72	72	Adj	223	24	VSV3072CT42AHL-E			\$3,880	\$4,092
	72	66	Adj	213	22	VST3066CT42AHR-E	\$2,986	\$3,188		
	72	66	Adj	213	22	VSV3066CT42AHR-E			\$3,821	\$4,027
	72	66	Adj	213	22	VST3066CT42AHL-E	\$2,986	\$3,188		
	72	66	Adj	213	22	VSV3066CT42AHL-E			\$3,821	\$4,027
	72	60	Adj	203	21	VST3060CT42AHR-E	\$2,961	\$3,150		
	72	60	Adj	203	21	VSV3060CT42AHR-E			\$3,789	\$3,992
	72	60	Adj	203	21	VST3060CT42AHL-E	\$2,961	\$3,150		
	72	60	Adj	203	21	VSV3060CT42AHL-E			\$3,789	\$3,992

- 22⁷/₈" to 48⁷/₈" height adjustment
- top edge profile on user and approach sides
- top grommet available, specify location; and add \$51 list each
- maximum weight rating 140 lbs. (evenly distributed load)
- push button control pad mounted right or left
- key pad features height display with three memory settings
- display will reference position to the nearest 1/2"
- 120" power cord
- specify Matte Black (MBK), Arctic Silver (ASL) or White (WH) base finish
- ships KD

Description	D	W	H	CTN WT	CU FT	① Model	TFL Laminate	HPL Laminate	Flat Cut Veneer	Double Cut Veneer
Adjustable Height Corner Table - 90° Two Piece Top- Extended Range - 24" d Desk	72	72	Adj	232	21	VST2472CT48AHR-E	\$2,973	\$3,181		
	72	72	Adj	232	21	VSV2472CT48AHR-E			\$3,817	\$4,023
	72	72	Adj	232	21	VST2472CT48AHL-E	\$2,973	\$3,181		
	72	72	Adj	232	21	VSV2472CT48AHL-E			\$3,817	\$4,023
	72	66	Adj	225	20	VST2466CT48AHR-E	\$2,950	\$3,146		
	72	66	Adj	225	20	VSV2466CT48AHR-E			\$3,761	\$3,961
	72	66	Adj	225	20	VST2466CT48AHL-E	\$2,950	\$3,146		
	72	66	Adj	225	20	VSV2466CT48AHL-E			\$3,761	\$3,961
	72	60	Adj	219		VST2460CT48AHR-E	\$2,928	\$3,110		
	72	60	Adj	219		VSV2460CT48AHR-E			\$3,728	\$3,925
	72	60	Adj	219		VST2460CT48AHL-E	\$2,928	\$3,110		
	72	60	Adj	219		VSV2460CT48AHL-E			\$3,728	\$3,925



left shown



- 22 7/8" to 48 7/8" height adjustment
- top edge profile on user and approach sides
- top grommet available, specify location; and add \$51 list each
- maximum weight rating 140 lbs. (evenly distributed load)
- push button control pad mounted right or left
- key pad features height display with three memory settings
- display will reference position to the nearest 1/2"
- 120" power cord
- specify Matte Black (MBK), Arctic Silver (ASL) or White (WH) base finish
- ships KD

To Order, Specify:

① Model Number

Laminate - VST

Veneer - VSV

② Worksurface Material (see page VI3)

a.) TFL

b.) HPL

③ Laminate Color (see page VI3)

a.) Worksurface Color

b.) Chassis Color

c.) Drawer Color

② Wood Species - Cherry (CH1), Maple (MA1)

Walnut (WA1), Black Oak (BO1) or

Double Cut (DC1) (see page VI1)

③ Finish Color (see page VI1)

④ Edge Profile (see page VI4)

⑤ Pull Style and Color (see page VI5)

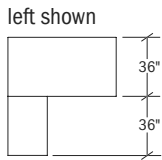
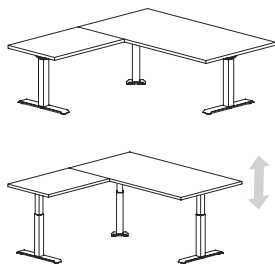
⑥ Optional Grommet Location & Color -
Matte Black (MBK) or Arctic Silver (ASL)
(see page VI6)

⑦ Other Product Options (see page VI10)

⑧ Accessories (see page VS314)

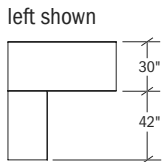
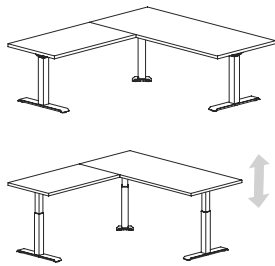
⑨ Power and Data Options (see page VS324)

Description	D	W	H	CTN WT	CU FT	① Model	TFL Laminate	HPL Laminate	Flat Cut Veneer	Double Cut Veneer
Adjustable Height Table & Return - 90° Two Piece Top - Standard Range - 36"d Desk	72	72	Adj	288	16	VST3672RTAH36R-S	\$2,559	\$2,876		
	72	72	Adj	288	16	VSV3672RTAH36R-S			\$3,366	\$3,547
	72	72	Adj	288	16	VST3672RTAH36L-S	\$2,559	\$2,876		
	72	72	Adj	288	16	VSV3672RTAH36L-S			\$3,366	\$3,547
	72	66	Adj	219	16	VST3666RTAH36R-S	\$2,502	\$2,832		
	72	66	Adj	219	16	VSV3666RTAH36R-S			\$3,275	\$3,450
	72	66	Adj	219	16	VST3666RTAH36L-S	\$2,502	\$2,832		
	72	66	Adj	219	16	VSV3666RTAH36L-S			\$3,275	\$3,450
	72	60	Adj	209	15	VST3660RTAH36R-S	\$2,446	\$2,789		
	72	60	Adj	209	15	VSV3660RTAH36R-S			\$3,184	\$3,349
	72	60	Adj	209	15	VST3660RTAH36L-S	\$2,446	\$2,789		
	72	60	Adj	209	15	VSV3660RTAH36L-S			\$3,184	\$3,349



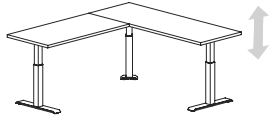
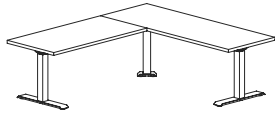
- 27 3/4" to 47 7/16" height adjustment
- top edge profile on user and approach sides
- top grommet available, specify location; and add \$51 list each
- maximum weight rating 140 lbs. (evenly distributed load)
- push botton control pad mounted right or left
- 120" power cord
- specify Matte Black (MBK), Arctic Silver (ASL) or White (WH) base finish
- ships KD
- preset control available, order AH-3PDC separately

Adjustable Height Table & Return - 90° Two Piece Top - Standard Range - 30"d Desk	72	72	Adj	209	15	VST3072RTAH42R-S	\$2,433	\$2,704		
	72	72	Adj	209	15	VSV3072RTAH42R-S			\$3,299	\$3,475
	72	72	Adj	209	15	VST3072RTAH42L-S	\$2,433	\$2,704		
	72	72	Adj	209	15	VSV3072RTAH42L-S			\$3,299	\$3,475
	72	66	Adj	201	14	VST3066RTAH42R-S	\$2,381	\$2,663		
	72	66	Adj	201	14	VSV3066RTAH42R-S			\$3,211	\$3,377
	72	66	Adj	201	14	VST3066RTAH42L-S	\$2,381	\$2,663		
	72	66	Adj	201	14	VSV3066RTAH42L-S			\$3,211	\$3,377
	72	60	Adj	193	14	VST3060RTAH42R-S	\$2,325	\$2,619		
	72	60	Adj	193	14	VSV3060RTAH42R-S			\$3,121	\$3,279
	72	60	Adj	193	14	VST3060RTAH42L-S	\$2,325	\$2,619		
	72	60	Adj	193	14	VSV3060RTAH42L-S			\$3,121	\$3,279

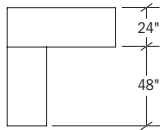


- 27 3/4" to 47 7/16" height adjustment
- top edge profile on user and approach sides
- top grommet available, specify location; and add \$51 list each
- maximum weight rating 140 lbs. (evenly distributed load)
- push botton control pad mounted right or left
- 120" power cord
- specify Matte Black (MBK), Arctic Silver (ASL) or White (WH) base finish
- ships KD
- preset control available, order AH-3PDC separately

Description	D	W	H	CTN WT	CU FT	① Model	TFL Laminate	HPL Laminate	Flat Cut Veneer	Double Cut Veneer
Adjustable Height Table & Return - 90° Two Piece Top - Standard Range - 24" d Desk	72	72	Adj	186	14	VST2472RTAH48R-S	\$2,407	\$2,615		
	72	72	Adj	186	14	VSV2472RTAH48R-S			\$3,102	\$3,259
	72	72	Adj	186	14	VST2472RTAH48L-S	\$2,407	\$2,615		
	72	72	Adj	186	14	VSV2472RTAH48L-S			\$3,102	\$3,259
	72	66	Adj	183	14	VST2466RTAH48R-S	\$2,373	\$2,580		
	72	66	Adj	183	14	VSV2466RTAH48R-S			\$3,063	\$3,216
	72	66	Adj	183	14	VST2466RTAH48L-S	\$2,373	\$2,580		
	72	66	Adj	183	14	VSV2466RTAH48L-S			\$3,063	\$3,216
	72	60	Adj	176	13	VST2460RTAH48R-S	\$2,331	\$2,548		
	72	60	Adj	176	13	VSV2460RTAH48R-S			\$2,988	\$3,133
	72	60	Adj	176	13	VST2460RTAH48L-S	\$2,331	\$2,548		
	72	60	Adj	176	13	VSV2460RTAH48L-S			\$2,988	\$3,133



left shown



- 27 3/4" to 47 7/16" height adjustment
- top edge profile on user and approach sides
- top grommet available, specify location; and add \$51 list each
- maximum weight rating 140 lbs. (evenly distributed load)
- push button control pad mounted right or left
- 120" power cord
- specify Matte Black (MBK), Arctic Silver (ASL) or White (WH) base finish
- ships KD
- preset control available, order AH-3PDC separately

To Order, Specify:

① Model Number

Laminate - VST

Veneer - VSV

② Worksurface Material (see page VI3)

- a.) TFL
- b.) HPL

② Wood Species - Cherry (CH1), Maple (MA1)

- Walnut (WA1), Black Oak (BO1) or Double Cut (DC1) (see page VI1)

④ Edge Profile (see page VI4)

⑤ Pull Style and Color (see page VI5)

③ Laminate Color (see page VI3)

- a.) Worksurface Color
- b.) Chassis Color
- c.) Drawer Color

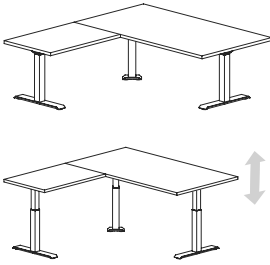
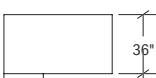
③ Finish Color (see page VI1)

⑥ Optional Grommet Location & Color - Matte Black (MBK) or Arctic Silver (ASL) (see page VI6)

⑦ Other Product Options (see page VI10)

⑧ Accessories (see page VS314)

⑨ Power and Data Options (see page VS324)

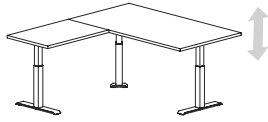
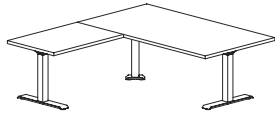
Description	D	W	H	CTN WT	CU FT	① Model	TFL Laminate	HPL Laminate	Flat Cut Veneer	Double Cut Veneer
Adjustable Height Table & Return - 90° Two Piece Top - Extended Range - 36"d Desk  left shown 	72	72	Adj	298	16	VST3672RTAH36R-E	\$2,776	\$3,093		
	72	72	Adj	298	16	VSV3672RTAH36R-E			\$3,582	\$3,764
	72	72	Adj	298	16	VST3672RTAH36L-E	\$2,776	\$3,093		
	72	72	Adj	298	16	VSV3672RTAH36L-E			\$3,582	\$3,764
	72	66	Adj	229	16	VST3666RTAH36R-E	\$2,718	\$3,049		
	72	66	Adj	229	16	VSV3666RTAH36R-E			\$3,491	\$3,665
	72	66	Adj	229	16	VST3666RTAH36L-E	\$2,718	\$3,049		
	72	66	Adj	229	16	VSV3666RTAH36L-E			\$3,491	\$3,665
	72	60	Adj	219	15	VST3660RTAH36R-E	\$2,662	\$3,006		
	72	60	Adj	219	15	VSV3660RTAH36R-E			\$3,400	\$3,565
	72	60	Adj	219	15	VST3660RTAH36L-E	\$2,662	\$3,006		
	72	60	Adj	219	15	VSV3660RTAH36L-E			\$3,400	\$3,565

- 22 7/8" to 48 7/8" height adjustment
- top edge profile on user and approach sides
- top grommet available, specify location; and add \$51 list each
- maximum weight rating 140 lbs. (evenly distributed load)
- push button control pad mounted right or left
- key pad features height display with three memory settings
- display will reference position to the nearest 1/2"
- 120" power cord
- specify Matte Black (MBK), Arctic Silver (ASL) or White (WH) base finish
- ships KD

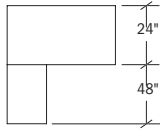
Adjustable Height Table & Return - 90° Two Piece Top - Extended Range - 30"d Desk  left shown 	72	72	Adj	242	18	VST3072RTAH42R-E	\$2,650	\$2,919		
	72	72	Adj	242	18	VSV3072RTAH42R-E			\$3,514	\$3,691
	72	72	Adj	242	18	VST3072RTAH42L-E	\$2,650	\$2,919		
	72	72	Adj	242	18	VSV3072RTAH42L-E			\$3,514	\$3,691
	72	66	Adj	233	17	VST3066RTAH42R-E	\$2,597	\$2,880		
	72	66	Adj	233	17	VSV3066RTAH42R-E			\$3,428	\$3,594
	72	66	Adj	233	17	VST3066RTAH42L-E	\$2,597	\$2,880		
	72	66	Adj	233	17	VSV3066RTAH42L-E			\$3,428	\$3,594
	72	60	Adj	224	16	VST3060RTAH42R-E	\$2,541	\$2,835		
	72	60	Adj	224	16	VSV3060RTAH42R-E			\$3,336	\$3,495
	72	60	Adj	224	16	VST3060RTAH42L-E	\$2,541	\$2,835		
	72	60	Adj	224	16	VSV3060RTAH42L-E			\$3,336	\$3,495

- 22 7/8" to 48 7/8" height adjustment
- top edge profile on user and approach sides
- top grommet available, specify location; and add \$51 list each
- maximum weight rating 140 lbs. (evenly distributed load)
- push button control pad mounted right or left
- key pad features height display with three memory settings
- display will reference position to the nearest 1/2"
- 120" power cord
- specify Matte Black (MBK), Arctic Silver (ASL) or White (WH) base finish
- ships KD

Description	D	W	H	CTN WT	CU FT	① Model	TFL Laminate	HPL Laminate	Flat Cut Veneer	Double Cut Veneer
Adjustable Height Table & Return - 90° Two Piece Top - Extended Range - 24" d Desk	72	72	Adj	231	15	VST2472RTAH48R-E	\$2,623	\$2,830		
	72	72	Adj	231	15	VSV2472RTAH48R-E			\$3,318	\$3,475
	72	72	Adj	231	15	VST2472RTAH48L-E	\$2,623	\$2,830		
	72	72	Adj	231	15	VSV2472RTAH48L-E			\$3,318	\$3,475
	72	66	Adj	225	14	VST2466RTAH48R-E	\$2,589	\$2,797		
	72	66	Adj	225	14	VSV2466RTAH48R-E			\$3,280	\$3,432
	72	66	Adj	225	14	VST2466RTAH48L-E	\$2,589	\$2,797		
	72	66	Adj	225	14	VSV2466RTAH48L-E			\$3,280	\$3,432
	72	60	Adj	219	13	VST2460RTAH48R-E	\$2,547	\$2,764		
	72	60	Adj	219	13	VSV2460RTAH48R-E			\$3,203	\$3,349
	72	60	Adj	219	13	VST2460RTAH48L-E	\$2,547	\$2,764		
	72	60	Adj	219	13	VSV2460RTAH48L-E			\$3,203	\$3,349



left shown



- 22 7/8" to 48 7/8" height adjustment
- top edge profile on user and approach sides
- top grommet available, specify location; and add \$51 list each
- maximum weight rating 140 lbs. (evenly distributed load)
- push button control pad mounted right or left
- key pad features height display with three memory settings
- display will reference position to the nearest 1/2"
- 120" power cord
- specify Matte Black (MBK), Arctic Silver (ASL) or White (WH) base finish
- ships KD

To Order, Specify:

① Model Number

Laminate - VST

Veneer - VSV

② Worksurface Material (see page VI3)

a.) TFL

b.) HPL

③ Laminate Color (see page VI3)

a.) Worksurface Color

b.) Chassis Color

c.) Drawer Color

② Wood Species - Cherry (CH1), Maple (MA1)

Walnut (WA1), Black Oak (BO1) or

Double Cut (DC1) (see page VI1)

③ Finish Color (see page VI1)

④ Edge Profile (see page VI4)

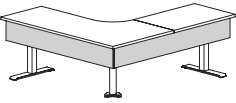
⑤ Pull Style and Color (see page VI5)

⑥ Optional Grommet Location & Color -
Matte Black (MBK) or Arctic Silver (ASL)
(see page VI6)

⑦ Other Product Options (see page VI10)

⑧ Accessories (see page VS314)

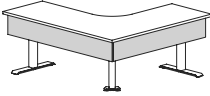
⑨ Power and Data Options (see page VS324)

Description	D	W	H	CTN WT	CU FT	① Model	Laminate	Flat Cut Veneer	Double Cut Veneer
Modesty Panel for 2-Piece Adjustable Height Corner Table Desk 	65 ¼	69	9	34	3	VST7201TDM	\$454		
	65 ¼	69	9	38	3	VSV7201TDM		\$661	\$726
	65 ¼	63	9	36	3	VST6601TDM	\$447		
	65 ¼	63	9	36	3	VSV6601TDM		\$649	\$714
	65 ¼	57	9	34	2	VST6001TDM	\$441		
	65 ¼	57	9	34	2	VSV6001TDM		\$637	\$701

- use with 30" & 36"d two piece adjustable corner table desk
- modesty panel bracket is always Black

Modesty Panel for 2-Piece Adjustable Height Corner Table Desk 	68 ¼	69	9	40	3	VST7202TDM	\$457		
	68 ¼	69	9	40	3	VSV7202TDM		\$667	\$734
	68 ¼	63	9	38	3	VST6602TDM	\$450		
	68 ¼	63	9	38	3	VSV6602TDM		\$654	\$720
	68 ¼	57	9	36	2	VST6002TDM	\$444		
	68 ¼	57	9	36	2	VSV6002TDM		\$642	\$707

- use with 24"d two piece adjustable corner table desk
- modesty panel bracket is always Black

Description	D	W	H	CTN WT	CU FT	① Model	Laminate	Flat Cut Veneer	Double Cut Veneer
Modesty Panel for 1-Piece Adjustable Height Corner Table Desk 	53 1/4	69	9	34	3	VST7203TDM	\$442		
	53 1/4	69	9	34	3	VSV7203TDM		\$637	\$701
	53 1/4	63	9	32	3	VST6603TDM	\$437		
	53 1/4	63	9	32	3	VSV6603TDM		\$627	\$689
	53 1/4	57	9	30	2	VST6003TDM	\$429		
	53 1/4	57	9	30	2	VSV6003TDM		\$614	\$676

· use with 30" & 36"d one piece adjustable corner table desk

Modesty Panel for 1-Piece Adjustable Height Corner Table Desk 	55 1/4	69	9	34	3	VST7204TDM	\$444		
	55 1/4	69	9	34	3	VSV7204TDM		\$642	\$873
	55 1/4	63	9	32	3	VST6604TDM	\$439		
	55 1/4	63	9	32	3	VSV6604TDM		\$631	\$855
	55 1/4	57	9	30	2	VST6004TDM	\$433		
	55 1/4	57	9	30	2	VSV6004TDM		\$620	\$841

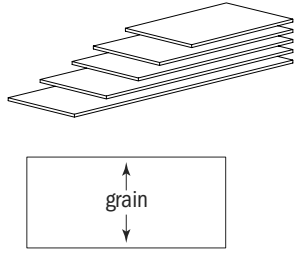
· use with 24"d one piece adjustable corner table desk

To Order, Specify:

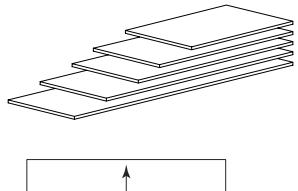
① Model Number	Laminate - VST	Veneer - VSV	
	② Worksurface Material (see page VI3) a.) TFL b.) HPL	② Wood Species - Cherry (CH1), Maple (MA1) Walnut (WA1), Black Oak (BO1) or Double Cut (DC1) (see page VI1)	④ Edge Profile (see page VI4) ⑤ Pull Style and Color (see page VI5) ⑥ Optional Grommet Location & Color - Matte Black (MBK) or Arctic Silver (ASL) (see page VI6)
	③ Laminate Color (see page VI3) a.) Worksurface Color b.) Chassis Color c.) Drawer Color	③ Finish Color (see page VI1)	⑦ Other Product Options (see page VI10) ⑧ Accessories (see page VS314) ⑨ Power and Data Options (see page VS324)

Description	D	W	H	CTN WT	CU FT	① Model	TFL Laminate	HPL Laminate	Flat Cut Veneer	Double Cut Veneer
	36	72	1 3/16	117	9	VST3672AHTT	\$627	\$822		
	36	72	1 3/16	117	9	VSV3672AHTT			\$1,092	\$1,203
	30	84	1 3/16	117	9	VST3084AHTT	\$492	\$676		
	30	84	1 3/16	117	9	VSV3084AHTT			\$1,130	\$1,244
	30	78	1 3/16	108	9	VST3078AHTT	\$482	\$643		
	30	78	1 3/16	108	9	VSV3078AHTT			\$1,041	\$1,146
	30	72	1 3/16	98	8	VST3072AHTT	\$471	\$611		
	30	72	1 3/16	98	8	VSV3072AHTT			\$956	\$1,052
	30	66	1 3/16	90	7	VST3066AHTT	\$425	\$574		
	30	66	1 3/16	90	7	VSV3066AHTT			\$878	\$967
	30	60	1 3/16	82	7	VST3060AHTT	\$377	\$537		
	30	60	1 3/16	82	7	VSV3060AHTT			\$799	\$878
	30	54	1 3/16	74	6	VST3054AHTT	\$356	\$505		
	30	54	1 3/16	74	6	VSV3054AHTT			\$718	\$790
	30	48	1 3/16	57	5	VST3048AHTT	\$335	\$471		
	30	48	1 3/16	57	5	VSV3048AHTT			\$638	\$702
	24	84	1 3/16	91	8	VST2484AHTT	\$471	\$592		
	24	84	1 3/16	91	8	VSV2484AHTT			\$925	\$1,017
	24	78	1 3/16	85	8	VST2478AHTT	\$462	\$563		
	24	78	1 3/16	85	8	VSV2478AHTT			\$873	\$960
	24	72	1 3/16	78	7	VST2472AHTT	\$447	\$531		
	24	72	1 3/16	78	7	VSV2472AHTT			\$782	\$861
	24	66	1 3/16	72	7	VST2466AHTT	\$418	\$503		
	24	66	1 3/16	72	7	VSV2466AHTT			\$748	\$824
	24	60	1 3/16	65	6	VST2460AHTT	\$380	\$472		
	24	60	1 3/16	65	6	VSV2460AHTT			\$680	\$749
	24	54	1 3/16	59	6	VST2454AHTT	\$343	\$446		
	24	54	1 3/16	59	6	VSV2454AHTT			\$670	\$737
	24	48	1 3/16	52	5	VST2448AHTT	\$319	\$420		
	24	48	1 3/16	52	5	VSV2448AHTT			\$603	\$663

- use with adjustable height T-Base
- top edge profile on user and approach sides
- top grommet available, specify location; and add \$51 list each

Description	D	W	H	CTN WT	CU FT	① Model	TFL Laminate	HPL Laminate	Flat Cut Veneer	Double Cut Veneer
	30	60	1 3/16	82	7	VST6030AHTT	\$377	\$537		
	30	60	1 3/16	82	7	VSV6030AHTT			\$799	\$878
	30	54	1 3/16	74	6	VST5430AHTT	\$356	\$505		
	30	54	1 3/16	74	6	VSV5430AHTT			\$718	\$790
	30	48	1 3/16	57	5	VST4830AHTT	\$335	\$471		
	30	48	1 3/16	57	5	VSV4830AHTT			\$638	\$702
	24	60	1 3/16	65	6	VST6024AHTT	\$380	\$472		
	24	60	1 3/16	65	6	VSV6024AHTT			\$680	\$749
	24	54	1 3/16	59	6	VST5424AHTT	\$343	\$446		
	24	54	1 3/16	59	6	VSV5424AHTT			\$670	\$737
	24	48	1 3/16	52	5	VST4824AHTT	\$319	\$420		
	24	48	1 3/16	52	5	VSV4824AHTT			\$603	\$663

- use with adjustable height T-Base
- top edge profile on user and approach sides
- top grommet available, specify location; and add \$51 list each

	24	58	1 3/16	65	6	VST5824AHTT	\$380	\$472		
	24	58	1 3/16	65	6	VSV5824AHTT			\$680	\$749
	24	52	1 3/16	59	6	VST5224AHTT	\$343	\$446		
	24	52	1 3/16	59	6	VSV5224AHTT			\$670	\$737
	24	46	1 3/16	52	5	VST4624AHTT	\$319	\$420		
	24	46	1 3/16	52	5	VSV4624AHTT			\$603	\$663

- use with adjustable height T-Base
- top edge profile on user and approach sides
- top grommet available, specify location; and add \$51 list each

To Order, Specify:

① Model Number

Laminate - VST

Veneer - VSV

② Worksurface Material (see page VI3)

a.) TFL

b.) HPL

③ Laminate Color (see page VI3)

a.) Worksurface Color

b.) Chassis Color

c.) Drawer Color

② Wood Species - Cherry (CH1), Maple (MA1)

Walnut (WA1), Black Oak (BO1) or

Double Cut (DC1) (see page VI1)

③ Finish Color (see page VI1)

④ Edge Profile (see page VI4)


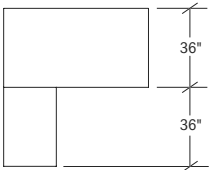
⑤ Pull Style and Color (see page VI5)

⑥ Optional Grommet Location & Color - Matte Black (MBK) or Arctic Silver (ASL) (see page VI6)

⑦ Other Product Options (see page VI10)

⑧ Accessories (see page VS314)

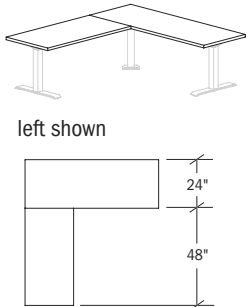
⑨ Power and Data Options (see page VS324)

Description	D	W	H	CTN WT	CU FT	① Model	TFL Laminate	HPL Laminate	Flat Cut Veneer	Double Cut Veneer
36"d Corner Top with Return - Two Piece Top  left shown 	72	72	1 3/16	156	9	VST3672AHLT36R	\$992	\$1,301		
	72	72	1 3/16	156	9	VSV3672AHLT36R			\$1,779	\$1,957
	72	72	1 3/16	156	9	VST3672AHLT36L	\$992	\$1,301		
	72	72	1 3/16	156	9	VSV3672AHLT36L			\$1,779	\$1,957
	72	66	1 3/16	147	9	VST3666AHLT36R	\$936	\$1,259		
	72	66	1 3/16	147	9	VSV3666AHLT36R			\$1,691	\$1,860
	72	66	1 3/16	147	9	VST3666AHLT36L	\$936	\$1,259		
	72	66	1 3/16	147	9	VSV3666AHLT36L			\$1,691	\$1,860
	72	60	1 3/16	137	8	VST3660AHLT36R	\$881	\$1,216		
	72	60	1 3/16	137	8	VSV3660AHLT36R			\$1,602	\$1,762
	72	60	1 3/16	137	8	VST3660AHLT36L	\$881	\$1,216		
	72	60	1 3/16	137	8	VSV3660AHLT36L			\$1,602	\$1,762

- use with adjustable height T-Base
- top edge profile on user and approach sides
- top grommet available, specify location; and add \$51 list each

30"d Corner Top with Return - Two Piece Top  left shown 	72	72	1 3/16	137	8	VST3072AHLT42R	\$869	\$1,133		
	72	72	1 3/16	137	8	VSV3072AHLT42R			\$1,712	\$1,884
	72	72	1 3/16	137	8	VST3072AHLT42L	\$869	\$1,133		
	72	72	1 3/16	137	8	VSV3072AHLT42L			\$1,712	\$1,884
	72	66	1 3/16	129	7	VST3066AHLT42R	\$817	\$1,092		
	72	66	1 3/16	129	7	VSV3066AHLT42R			\$1,628	\$1,791
	72	66	1 3/16	129	7	VST3066AHLT42L	\$817	\$1,092		
	72	66	1 3/16	129	7	VSV3066AHLT42L			\$1,628	\$1,791
	72	60	1 3/16	121	7	VST3060AHLT42R	\$764	\$1,050		
	72	60	1 3/16	121	7	VSV3060AHLT42R			\$1,539	\$1,694
	72	60	1 3/16	121	7	VST3060AHLT42L	\$764	\$1,050		
	72	60	1 3/16	121	7	VSV3060AHLT42L			\$1,539	\$1,694

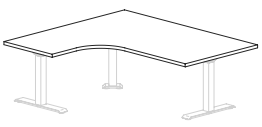
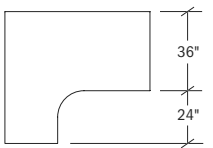
- use with adjustable height T-Base
- top edge profile on user and approach sides
- top grommet available, specify location; and add \$51 list each

Description	D	W	H	CTN WT	CU FT	① Model	TFL Laminate	HPL Laminate	Flat Cut Veneer	Double Cut Veneer
24" d Corner Top with Return - Two Piece Top 	72	72	1 3/16	117	7	VST2472AHLT48R	\$843	\$1,046		
	72	72	1 3/16	117	7	VSV2472AHLT48R			\$1,522	\$1,674
	72	72	1 3/16	117	7	VST2472AHLT48L	\$843	\$1,046		
	72	72	1 3/16	117	7	VSV2472AHLT48L			\$1,522	\$1,674
	72	66	1 3/16	111	7	VST2466AHLT48R	\$810	\$1,013		
	72	66	1 3/16	111	7	VSV2466AHLT48R			\$1,485	\$1,633
	72	66	1 3/16	111	7	VST2466AHLT48L	\$810	\$1,013		
	72	66	1 3/16	111	7	VSV2466AHLT48L			\$1,485	\$1,633
	72	60	1 3/16	104	6	VST2460AHLT48R	\$768	\$980		
	72	60	1 3/16	104	6	VSV2460AHLT48R			\$1,410	\$1,551
	72	60	1 3/16	104	6	VST2460AHLT48L	\$768	\$980		
	72	60	1 3/16	104	6	VSV2460AHLT48L			\$1,410	\$1,551

- use with adjustable height T-Base
- top edge profile on user and approach sides
- top grommet available, specify location; and add \$51 list each

To Order, Specify:

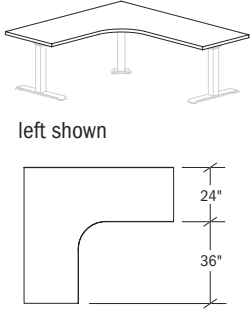
① Model Number	Laminate - VST	Veneer - VSV	
	② Worksurface Material (see page VI3) a.) TFL b.) HPL	② Wood Species - Cherry (CH1), Maple (MA1) Walnut (WA1), Black Oak (BO1) or Double Cut (DC1) (see page VI1)	④ Edge Profile (see page VI4) ⑤ Pull Style and Color (see page VI5) ⑥ Optional Grommet Location & Color - Matte Black (MBK) or Arctic Silver (ASL) (see page VI6)
	③ Laminate Color (see page VI3) a.) Worksurface Color b.) Chassis Color c.) Drawer Color	③ Finish Color (see page VI1)	⑦ Other Product Options (see page VI10) ⑧ Accessories (see page VS314) ⑨ Power and Data Options (see page VS324)

Description	D	W	H	CTN WT	CU FT	① Model	TFL Laminate	HPL Laminate	Flat Cut Veneer	Double Cut Veneer
36" d Cockpit Corner Desk Top  left shown 	60	72	1 3/16	168	5	VST3672AHCT24R	\$1,104	\$1,312		
	60	72	1 3/16	168	5	VSV3672AHCT24R			\$1,686	\$1,855
	60	72	1 3/16	168	5	VST3672AHCT24L	\$1,104	\$1,312		
	60	72	1 3/16	168	5	VSV3672AHCT24L			\$1,686	\$1,855
	60	66	1 3/16	141	5	VST3666AHCT24R	\$1,076	\$1,266		
	60	66	1 3/16	155	5	VSV3666AHCT24R			\$1,617	\$1,778
	60	66	1 3/16	141	5	VST3666AHCT24L	\$1,076	\$1,266		
	60	66	1 3/16	155	5	VSV3666AHCT24L			\$1,617	\$1,778
	60	60	1 3/16	141	5	VST3660AHCT24R	\$1,046	\$1,221		
	60	60	1 3/16	141	5	VSV3660AHCT24R			\$1,579	\$1,736
	60	60	1 3/16	141	5	VST3660AHCT24L	\$1,046	\$1,221		
	60	60	1 3/16	141	5	VSV3660AHCT24L			\$1,579	\$1,736

- use with adjustable height T-Base
- top edge profile on user and approach sides
- top grommet available, specify location; and add \$51 list each

30" d Cockpit Corner Desk Top  left shown 	60	72	1 3/16	168	5	VST3072AHCT30R	\$1,104	\$1,312		
	60	72	1 3/16	168	5	VSV3072AHCT30R			\$1,686	\$1,855
	60	72	1 3/16	168	5	VST3072AHCT30L	\$1,104	\$1,312		
	60	72	1 3/16	168	5	VSV3072AHCT30L			\$1,686	\$1,855
	60	66	1 3/16	155	5	VST3066AHCT30R	\$1,076	\$1,266		
	60	66	1 3/16	155	5	VSV3066AHCT30R			\$1,617	\$1,778
	60	66	1 3/16	155	5	VST3066AHCT30L	\$1,076	\$1,266		
	60	66	1 3/16	155	5	VSV3066AHCT30L			\$1,617	\$1,778
	60	60	1 3/16	141	5	VST3060AHCT30R	\$1,046	\$1,221		
	60	60	1 3/16	141	5	VSV3060AHCT30R			\$1,579	\$1,736
	60	60	1 3/16	141	5	VST3060AHCT30L	\$1,046	\$1,221		
	60	60	1 3/16	141	5	VSV3060AHCT30L			\$1,579	\$1,736

- use with adjustable height T-Base
- top edge profile on user and approach sides
- top grommet available, specify location; and add \$51 list each

Description	D	W	H	CTN WT	CU FT	① Model	TFL Laminate	HPL Laminate	Flat Cut Veneer	Double Cut Veneer
 <p>left shown</p>	60	72	1 3/16	160	5	VST2472AHCT36R	\$1,104	\$1,312		
	60	72	1 3/16	160	5	VSV2472AHCT36R			\$1,686	\$1,855
	60	72	1 3/16	160	5	VST2472AHCT36L	\$1,104	\$1,312		
	60	72	1 3/16	160	5	VSV2472AHCT36L			\$1,686	\$1,855
	60	66	1 3/16	150	5	VST2466AHCT36R	\$1,076	\$1,266		
	60	66	1 3/16	150	5	VSV2466AHCT36R			\$1,617	\$1,778
	60	66	1 3/16	150	5	VST2466AHCT36L	\$1,076	\$1,266		
	60	66	1 3/16	150	5	VSV2466AHCT36L			\$1,617	\$1,778
	60	60	1 3/16	135	5	VST2460AHCT36R	\$1,046	\$1,221		
	60	60	1 3/16	135	5	VSV2460AHCT36R			\$1,579	\$1,736
	60	60	1 3/16	135	5	VST2460AHCT36L	\$1,046	\$1,221		
	60	60	1 3/16	135	5	VSV2460AHCT36L			\$1,579	\$1,736

- use with adjustable height T-Base
- top edge profile on user and approach sides
- top grommet available, specify location; and add \$51 list each

To Order, Specify:

① Model Number

Laminate - VST

Veneer - VSV

② Worksurface Material (see page VI3)

a.) TFL

b.) HPL

③ Laminate Color (see page VI3)

a.) Worksurface Color

b.) Chassis Color

c.) Drawer Color

② Wood Species - Cherry (CH1), Maple (MA1)

Walnut (WA1), Black Oak (BO1) or

Double Cut (DC1) (see page VI1)

③ Finish Color (see page VI1)

④ Edge Profile (see page VI4)

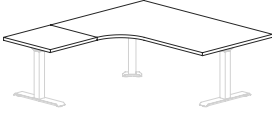
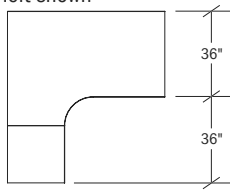
⑤ Pull Style and Color (see page VI5)

⑥ Optional Grommet Location & Color -
Matte Black (MBK) or Arctic Silver (ASL)
(see page VI6)

⑦ Other Product Options (see page VI10)

⑧ Accessories (see page VS314)

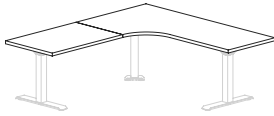
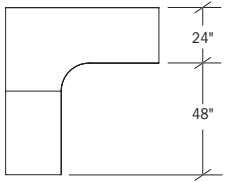
⑨ Power and Data Options (see page VS324)

Description	D	W	H	CTN WT	CU FT	① Model	TFL Laminate	HPL Laminate	Flat Cut Veneer	Double Cut Veneer
36" d Cockpit Corner Desk Top - Two Piece Top  left shown 	72	72	1 3/16	13	0	VST3672AHCT36R	\$1,259	\$1,473		
	72	72	1 3/16	163	13	VSV3672AHCT36R			\$2,134	\$2,347
	72	72	1 3/16	13	0	VST3672AHCT36L	\$1,259	\$1,473		
	72	72	1 3/16	163	13	VSV3672AHCT36L			\$2,134	\$2,347
	72	66	1 3/16	153	12	VST3666AHCT36R	\$1,235	\$1,437		
	72	66	1 3/16	153	12	VSV3666AHCT36R			\$2,075	\$2,282
	72	66	1 3/16	153	12	VST3666AHCT36L	\$1,235	\$1,437		
	72	66	1 3/16	153	12	VSV3666AHCT36L			\$2,075	\$2,282
	72	60	1 3/16	143	11	VST3660AHCT36R	\$1,210	\$1,400		
	72	60	1 3/16	143	11	VSV3660AHCT36R			\$2,042	\$2,245
	72	60	1 3/16	143	11	VST3660AHCT36L	\$1,210	\$1,400		
	72	60	1 3/16	143	11	VSV3660AHCT36L			\$2,042	\$2,245

- use with adjustable height T-Base
- top edge profile on user and approach sides
- top grommet available, specify location; and add \$51 list each

30" d Cockpit Corner Desk Top - Two Piece Top  left shown 	72	72	1 3/16	144	12	VST3072AHCT42R	\$1,221	\$1,430		
	72	72	1 3/16	144	12	VSV3072AHCT42R			\$2,070	\$2,278
	72	72	1 3/16	144	12	VST3072AHCT42L	\$1,221	\$1,430		
	72	72	1 3/16	144	12	VSV3072AHCT42L			\$2,070	\$2,278
	72	66	1 3/16	136	11	VST3066AHCT42R	\$1,198	\$1,396		
	72	66	1 3/16	136	11	VSV3066AHCT42R			\$2,014	\$2,214
	72	66	1 3/16	136	11	VST3066AHCT42L	\$1,198	\$1,396		
	72	66	1 3/16	136	11	VSV3066AHCT42L			\$2,014	\$2,214
	72	60	1 3/16	128	10	VST3060AHCT42R	\$1,174	\$1,359		
	72	60	1 3/16	128	10	VSV3060AHCT42R			\$1,981	\$2,180
	72	60	1 3/16	128	10	VST3060AHCT42L	\$1,174	\$1,359		
	72	60	1 3/16	128	10	VSV3060AHCT42L			\$1,981	\$2,180

- use with adjustable height T-Base
- top edge profile on user and approach sides
- top grommet available, specify location; and add \$51 list each

Description	D	W	H	CTN WT	CU FT	① Model	TFL Laminate	HPL Laminate	Flat Cut Veneer	Double Cut Veneer
24" d Cockpit Corner Desk Top - Two Piece Top  left shown 	72	72	1 3/16	91	10	VST2472AHCT48R	\$1,185	\$1,387		
	72	72	1 3/16	91	10	VSV2472AHCT48R			\$2,008	\$2,209
	72	72	1 3/16	91	10	VST2472AHCT48L	\$1,185	\$1,387		
	72	72	1 3/16	91	10	VSV2472AHCT48L			\$2,008	\$2,209
	72	66	1 3/16	85	9	VST2466AHCT48R	\$1,163	\$1,353		
	72	66	1 3/16	85	9	VSV2466AHCT48R			\$1,953	\$2,150
	72	66	1 3/16	85	9	VST2466AHCT48L	\$1,163	\$1,353		
	72	66	1 3/16	85	9	VSV2466AHCT48L			\$1,953	\$2,150
	72	60	1 3/16	78	9	VST2460AHCT48R	\$1,140	\$1,319		
	72	60	1 3/16	78	9	VSV2460AHCT48R			\$1,921	\$2,115
	72	60	1 3/16	78	9	VST2460AHCT48L	\$1,140	\$1,319		
	72	60	1 3/16	78	9	VSV2460AHCT48L			\$1,921	\$2,115

- use with adjustable height T-Base
- top edge profile on user and approach sides
- top grommet available, specify location; and add \$51 list each

To Order, Specify:

① Model Number	Laminate - VST	Veneer - VSV	
	② Worksurface Material (see page VI3) a.) TFL b.) HPL	② Wood Species - Cherry (CH1), Maple (MA1) Walnut (WA1), Black Oak (BO1) or Double Cut (DC1) (see page VI1)	④ Edge Profile (see page VI4)
	③ Laminate Color (see page VI3) a.) Worksurface Color b.) Chassis Color c.) Drawer Color	③ Finish Color (see page VI1)	⑤ Pull Style and Color (see page VI5)
			⑥ Optional Grommet Location & Color - Matte Black (MBK) or Arctic Silver (ASL) (see page VI6)
			⑦ Other Product Options (see page VI10)
			⑧ Accessories (see page VS314)
			⑨ Power and Data Options (see page VS324)

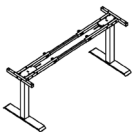
Description	D	W	H	CTN WT	CU FT	① Model	List Price
-------------	---	---	---	-----------	----------	---------	------------

Adjustable Height Base for Table Desk - Standard Range



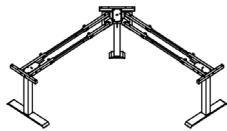
- 26 5/8" to 46 5/16" height adjustment
- maximum weight rating 140 lbs. (evenly distributed load)
- push button control pad mounted right or left
- 120" power cord
- specify Matte Black (MBK), Arctic Silver (ASL) or White (WH) base finish
- ships KD
- casters available, order AHCAST separately, see page VS33
- preset control available, order AH-3PDC separately

Adjustable Height Base for Table Desk - Extended Range	24	41-68	Adj	78	3	AH24-4168-2TE	\$1,085
---	----	-------	-----	----	---	----------------------	----------------



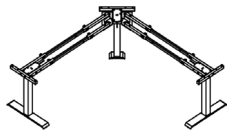
- 21 1/16" to 47 13/16" height adjustment
- maximum weight rating 140 lbs. (evenly distributed load)
- push button control pad mounted right or left
- key pad features height display with three memory settings
- display will reference position to the nearest 1/2"
- 120" power cord
- specify Matte Black (MBK), Arctic Silver (ASL) or White (WH) base finish
- ships KD
- casters available, order AHCAST separately

Adjustable Height Base for Corner and L-Unit - Standard Range	24	54-72	Adj	72	7	AH24-5472-3TS	\$1,545
--	----	-------	-----	----	---	----------------------	----------------



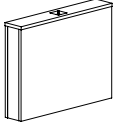
- 26 5/8" to 46 5/16" height adjustment
- maximum weight rating 140 lbs. (evenly distributed load)
- push button control pad mounted right or left
- 120" power cord
- specify Matte Black (MBK), Arctic Silver (ASL) or White (WH) base finish
- ships KD
- preset control available, order AH-3PDC separately

Adjustable Height Base for Corner and L-Unit - Extended Range	24	54-72	Adj	79	7	AH24-5472-3TE	\$1,761
--	----	-------	-----	----	---	----------------------	----------------



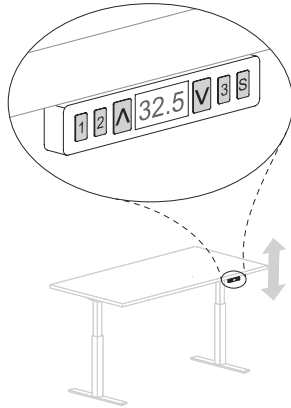
- 21 1/16" to 47 13/16" height adjustment
- maximum weight rating 140 lbs. (evenly distributed load)
- push button control pad mounted right or left
- key pad features height display with three memory settings
- display will reference position to the nearest 1/2"
- 120" power cord
- specify Matte Black (MBK), Arctic Silver (ASL) or White (WH) base finish
- ships KD

Description	D	W	H	CTN WT	CU FT	① Model	Laminate	Flat Cut Veneer	Double Cut Veneer
Shroud for Standard Range T-Base Tables	5 5/16	29 13/16	22 3/4	41	4	VST0630AHTP	\$579		
	5 5/16	29 13/16	22 3/4	41	4	VSV0630AHTP		\$1,043	\$1,148

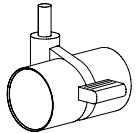


- use with 36" or 30" d standard range T base legs
- encapsulates legs to give a more finished look
- sold separately

Description	D	W	H	CTN WT	CU FT	① Model	List Price
3 Preset Digital Control Upgrade for Standard Range Bases				1	1	AH-3PDC	\$59

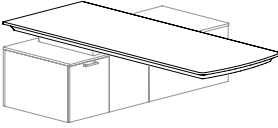


Caster Kit				1	1	AHCAST	\$71
------------	--	--	--	---	---	--------	------

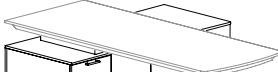


To Order, Specify:

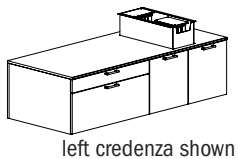
① Model Number	Laminate - VST	Veneer - VSV
	<p>② Worksurface Material (see page VI3)</p> <p>a.) TFL</p> <p>b.) HPL</p> <p>③ Laminate Color (see page VI3)</p> <p>a.) Worksurface Color</p> <p>b.) Chassis Color</p> <p>c.) Drawer Color</p>	<p>② Wood Species - Cherry (CH1), Maple (MA1) Walnut (WA1), Black Oak (BO1) or Double Cut (DC1) (see page VI1)</p> <p>③ Finish Color (see page VI1)</p>
		<p>④ Edge Profile (see page VI4)</p> <p>⑤ Pull Style and Color (see page VI5)</p> <p>⑥ Optional Grommet Location & Color - Matte Black (MBK) or Arctic Silver (ASL) (see page VI6)</p> <p>⑦ Other Product Options (see page VI10)</p> <p>⑧ Accessories (see page VS314)</p> <p>⑨ Power and Data Options (see page VS324)</p>

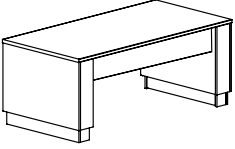
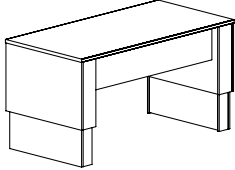
Description	D	W	H	CTN WT	CU FT	① Model	TFL Laminate	HPL Laminate	Flat Cut Veneer	Double Cut Veneer
 left top shown	36	92	29 1/2	139	12	VST3692AHCVR	\$4,268	\$4,571		
	36	92	29 1/2	139	12	VSV3692AHCVR			\$5,077	\$5,331
	36	92	29 1/2	139	12	VST3692AHCVL	\$4,268	\$4,571		
	36	92	29 1/2	139	12	VSV3692AHCVL			\$5,077	\$5,331
	36	80	29 1/2	126	11	VST3680AHCVR	\$4,085	\$4,351		
	36	80	29 1/2	126	11	VSV3680AHCVR			\$4,918	\$5,163
	36	80	29 1/2	126	11	VST3680AHCVL	\$4,085	\$4,351		
	36	80	29 1/2	126	11	VSV3680AHCVL			\$4,918	\$5,163

- use with credenza support for cantilever table top
- 28 3/4" to 42" height adjustment
- top grommet available, specify location; and add \$51 list each
- maximum weight rating 150 lbs. (evenly distributed load)
- push button control pad mounted right or left
- key pad features height display with three memory settings
- display will reference position to the nearest 1/2"
- 120" power cord
- electrical cut out to fit an EC10, EC11 and EC12 available, specify location and order separately
- specify finish from top separately from apron

Description	D	W	H	CTN WT	CU FT	① Model	Laminate	Flat Cut Veneer	Double Cut Veneer
 right credenza shown	30	72	20	1095	43	VSTB3072CMR	\$22,123		
	30	72	20	1095	43	VSVB3072CMR		\$23,081	\$24,236
	30	72	20	1095	43	VSTB3072CML	\$22,123		
	30	72	20	1095	43	VSVB3072CML		\$23,081	\$24,236

- use with cantilever table top
- box/file drawer configuration determines hand of unit
- locking available, specify and add \$112 list
- height adjustable mechanism ships with credenza
- wall access cut out available, specify and add \$170 list
- specify Matte Black (MBK), Arctic Silver (ASL), Pewter (PEW), Soft Nickel (SNK), Aged Bronze (ABZ), Soft Bronze (SBZ) or Gold (GLD) metal finish



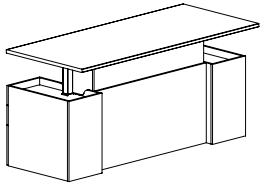
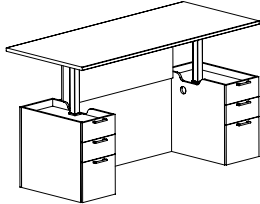
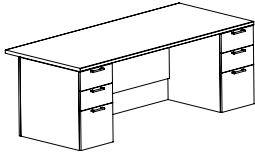
Description	D	W	H	CTN WT	CU FT	① Model	TFL Laminate	HPL Laminate	Flat Cut Veneer	Double Cut Veneer
Adjustable Height Table Desk  	36	72	Adj.	327	52	VST3672AHD	\$4,204	\$4,421		
	36	72	Adj.	327	52	VSV3672AHD			\$6,165	\$6,597
	36	66	Adj.	318	48	VST3666AHD	\$4,185	\$4,389		
	36	66	Adj.	318	48	VSV3666AHD			\$6,122	\$6,550
	36	60	Adj.	308	43	VST3660AHD	\$4,165	\$4,365		
	36	60	Adj.	308	43	VSV3660AHD			\$6,078	\$6,505
	30	72	Adj.	285	44	VST3072AHD	\$4,109	\$4,310		
	30	72	Adj.	285	44	VSV3072AHD			\$5,987	\$6,407
	30	66	Adj.	276	40	VST3066AHD	\$4,094	\$4,286		
	30	66	Adj.	276	40	VSV3066AHD			\$5,949	\$6,366
	30	60	Adj.	267	37	VST3060AHD	\$4,082	\$4,259		
	30	60	Adj.	267	37	VSV3060AHD			\$5,912	\$6,327

- 29 1/2" to 49 1/8" height adjustment
- top edge profile on user side and approach sides
- top grommet available, specify location; and add \$51 list each
- maximum weight rating 140 lbs. (evenly distributed load)
- telescoping end panels
- 12" hanging modesty panel included, travels with top
- push button control pad mounted right or left
- 120" power cord
- electrical cut out to fit an EC10, EC11 and EC12 available, specify location and order separately
- wire access cut out in modesty panel, specify and add \$47 list

To Order, Specify:

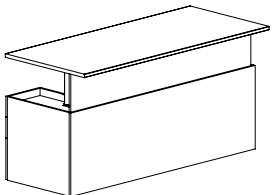
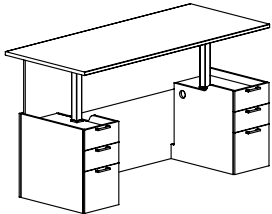
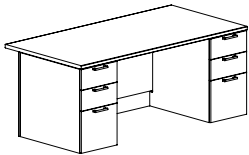
① Model Number	Laminate - VST	Veneer - VSV	
	<p>② Worksurface Material (see page VI3)</p> <p>a.) TFL</p> <p>b.) HPL</p> <p>③ Laminate Color (see page VI3)</p> <p>a.) Worksurface Color</p> <p>b.) Chassis Color</p> <p>c.) Drawer Color</p>	<p>② Wood Species - Cherry (CH1), Maple (MA1) Walnut (WA1), Black Oak (BO1) or Double Cut (DC1) (see page VI1)</p> <p>③ Finish Color (see page VI1)</p>	<p>④ Edge Profile (see page VI4)</p> <p>⑤ Pull Style and Color (see page VI5)</p> <p>⑥ Optional Grommet Location & Color - Matte Black (MBK) or Arctic Silver (ASL) (see page VI6)</p> <p>⑦ Other Product Options (see page VI10)</p> <p>⑧ Accessories (see page VS314)</p> <p>⑨ Power and Data Options (see page VS324)</p>

Description	D	W	H	CTN WT	CU FT	① Model	TFL Laminate	HPL Laminate	Flat Cut Veneer	Double Cut Veneer
Adjustable Height Double Pedestal Desk with Break Front Modesty Panel	36	84	Adj	394	60	VST3684AHDD	\$5,326	\$5,547		
	36	84	Adj	394	60	VSV3684AHDD			\$7,375	\$7,873
	36	72	Adj	373	52	VST3672AHDD	\$5,247	\$5,464		
	36	72	Adj	373	52	VSV3672AHDD			\$7,265	\$7,757
	36	66	Adj	357	48	VST3666AHDD	\$5,212	\$5,418		
	36	66	Adj	357	48	VSV3666AHDD			\$7,201	\$7,690
Adjustable Height Double Pedestal Desk with Flush Modesty Panel	30	84	Adj	381	51	VST3084AHDD	\$5,301	\$5,505		
	30	84	Adj	381	51	VSV3084AHDD			\$7,306	\$7,801
	30	72	Adj	356	44	VST3072AHDD	\$5,222	\$5,423		
	30	72	Adj	356	44	VSV3072AHDD			\$7,198	\$7,685
	30	66	Adj	344	40	VST3066AHDD	\$5,183	\$5,373		
	30	66	Adj	344	40	VSV3066AHDD			\$7,138	\$7,620

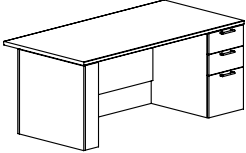
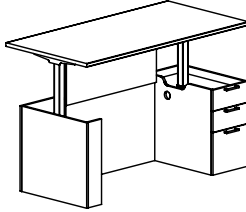


- 29 1/2" to 49 1/8" height adjustment
- top edge profile on user side and approach sides
- top grommet available, specify location; and add \$51 list each
- maximum weight rating 140 lbs. (evenly distributed load)
- hanging modesty panel included, travels with top
- push button control pad mounted right or left
- 120" power cord
- specify Matte Black (MBK), Arctic Silver (ASL) or White (WH) metal finish
- locking available, specify and add \$82 list
- electrical cut out to fit an EC10, EC11 and EC12 available, specify location and order separately

Adjustable Height Double Pedestal Desk with Flush Modesty Panel	36	84	Adj	417	60	VST3684AHDDF	\$5,069	\$5,289		
	36	84	Adj	417	60	VSV3684AHDDF			\$7,454	\$7,957
	36	72	Adj	398	52	VST3672AHDDF	\$4,993	\$5,211		
	36	72	Adj	398	52	VSV3672AHDDF			\$7,344	\$7,840
	36	66	Adj	379	48	VST3666AHDDF	\$4,956	\$5,163		
	36	66	Adj	379	48	VSV3666AHDDF			\$7,276	\$7,768



- 29 1/2" to 49 1/8" height adjustment
- top edge profile on user side and approach sides
- top grommet available, specify location; and add \$51 list each
- maximum weight rating 140 lbs. (evenly distributed load)
- hanging modesty panel included, travels with top
- push button control pad mounted right or left
- 120" power cord
- specify Matte Black (MBK), Arctic Silver (ASL) or White (WH) metal finish
- locking available, specify and add \$82 list
- electrical cut out to fit an EC10, EC11 and EC12 available, specify location and order separately

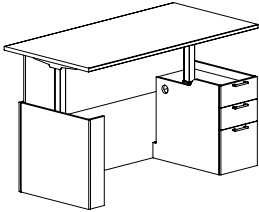
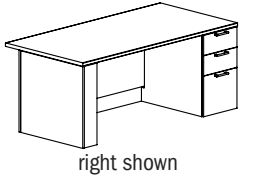
Description	D	W	H	CTN WT	CU FT	① Model	TFL Laminate	HPL Laminate	Flat Cut Veneer	Double Cut Veneer
Adjustable Height Single Pedestal Desk with Break Front Modesty Panel	36	72	Adj	357	52	VST3672AHRD	\$4,990	\$5,206		
	36	72	Adj	357	52	VSV3672AHRD			\$7,008	\$7,500
 right shown 	36	72	Adj	357	52	VST3672AHL D	\$4,990	\$5,206		
	36	72	Adj	357	52	VSV3672AHL D			\$7,008	\$7,500
	36	66	Adj	345	48	VST3666AHRD	\$4,954	\$5,161		
	36	66	Adj	345	48	VSV3666AHRD			\$6,944	\$7,432
	36	66	Adj	345	48	VST3666AHL D	\$4,954	\$5,161		
	36	66	Adj	345	48	VSV3666AHL D			\$6,944	\$7,432
	36	60	Adj	333	43	VST3660AHRD	\$4,922	\$5,122		
	36	60	Adj	333	43	VSV3660AHRD			\$6,880	\$7,362
	36	60	Adj	333	43	VST3660AHL D	\$4,922	\$5,122		
	36	60	Adj	333	43	VSV3660AHL D			\$6,880	\$7,362
	30	72	Adj	362	44	VST3072AHRD	\$4,965	\$5,165		
	30	72	Adj	362	44	VSV3072AHRD			\$6,941	\$7,428
	30	72	Adj	362	44	VST3072AHL D	\$4,965	\$5,165		
	30	72	Adj	362	44	VSV3072AHL D			\$6,941	\$7,428
	30	66	Adj	350	40	VST3066AHRD	\$4,926	\$5,116		
	30	66	Adj	350	40	VSV3066AHRD			\$6,881	\$7,363
	30	66	Adj	350	40	VST3066AHL D	\$4,926	\$5,116		
	30	66	Adj	350	40	VSV3066AHL D			\$6,881	\$7,363
30	60	Adj	338	37	VST3060AHRD	\$4,886	\$5,065			
30	60	Adj	338	37	VSV3060AHRD			\$6,821	\$7,299	
30	60	Adj	338	37	VST3060AHL D	\$4,886	\$5,065			
30	60	Adj	338	37	VSV3060AHL D			\$6,821	\$7,299	

- 29 1/2" to 49 1/8" height adjustment
- top edge profile on user side and approach sides
- top grommet available, specify location; and add \$51 list each
- maximum weight rating 140 lbs. (evenly distributed load)
- hanging modesty panel included, travels with top
- push button control pad mounted right or left
- 120" power cord
- specify Matte Black (MBK), Arctic Silver (ASL) or White (WH) metal finish
- locking available, specify and add \$82 list
- electrical cut out to fit an EC10, EC11 and EC12 available, specify location and order separately

To Order, Specify:

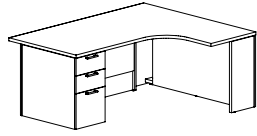
① Model Number	Laminate - VST	Veneer - VSV	
	② Worksurface Material (see page VI3) a.) TFL b.) HPL	② Wood Species - Cherry (CH1), Maple (MA1) Walnut (WA1), Black Oak (BO1) or Double Cut (DC1) (see page VI1)	④ Edge Profile (see page VI4)
	③ Laminate Color (see page VI3) a.) Worksurface Color b.) Chassis Color c.) Drawer Color	③ Finish Color (see page VI1)	⑤ Pull Style and Color (see page VI5)
			⑥ Optional Grommet Location & Color - Matte Black (MBK) or Arctic Silver (ASL) (see page VI6)
			⑦ Other Product Options (see page VI10)
			⑧ Accessories (see page VS314)
			⑨ Power and Data Options (see page VS324)

Description	D	W	H	CTN WT	CU FT	① Model	TFL Laminate	HPL Laminate	Flat Cut Veneer	Double Cut Veneer
Adjustable Height Single Pedestal Desk with Flush Modesty Panel	36	72	Adj	352	52	VST3672AHRDF	\$4,736	\$4,953		
	36	72	Adj	352	52	VSV3672AHRDF			\$7,087	\$7,583
	36	72	Adj	352	52	VST3672AHLDF	\$4,736	\$4,953		
	36	72	Adj	352	52	VSV3672AHLDF			\$7,087	\$7,583
	36	66	Adj	340	48	VST3666AHRDF	\$4,699	\$4,906		
	36	66	Adj	340	48	VSV3666AHRDF			\$7,019	\$7,511
	36	66	Adj	340	48	VST3666AHLDF	\$4,699	\$4,906		
	36	66	Adj	340	48	VSV3666AHLDF			\$7,019	\$7,511
	36	60	Adj	328	43	VST3660AHRDF	\$4,662	\$4,863		
	36	60	Adj	328	43	VSV3660AHRDF			\$6,951	\$7,438
	36	60	Adj	328	43	VST3660AHLDF	\$4,662	\$4,863		
	36	60	Adj	328	43	VSV3660AHLDF			\$6,951	\$7,438

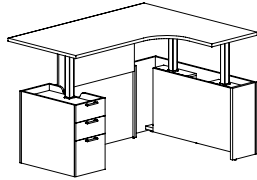


- 6" front overhang
- 29 1/2" to 49 1/8" height adjustment
- top edge profile on user side and approach sides
- top grommet available, specify location; and add \$51 list each
- maximum weight rating 140 lbs. (evenly distributed load)
- hanging modesty panel included, travels with top
- push button control pad mounted right or left
- 120" power cord
- specify Matte Black (MBK), Arctic Silver (ASL) or White (WH) metal finish
- locking available, specify and add \$82 list
- electrical cut out to fit an EC10, EC11 and EC12 available, specify location and order separately

Description	D	W	H	CTN WT	CU FT	① Model	TFL Laminate	HPL Laminate	Flat Cut Veneer	Double Cut Veneer
36" d Adjustable Height Corner Desk - Break Front Modesty Panel	60	72	Adj	446	40	VST3672-C24AHBR	\$6,157	\$6,477		
	60	72	Adj	446	41	VSV3672-C24AHBR			\$8,486	\$9,080
	60	72	Adj	446	41	VST3672-C24AHBL	\$6,157	\$6,477		
	60	72	Adj	446	41	VSV3672-C24AHBL			\$8,486	\$9,080
	60	66	Adj	432	40	VST3666-C24AHBR	\$6,104	\$6,421		
	60	66	Adj	432	39	VSV3666-C24AHBR			\$8,455	\$9,046
	60	66	Adj	432	39	VST3666-C24AHBL	\$6,104	\$6,421		
	60	66	Adj	432	39	VSV3666-C24AHBL			\$8,455	\$9,046

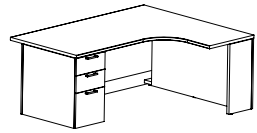


left shown

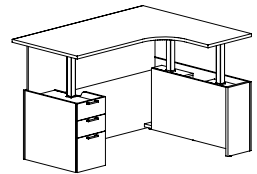


- 29 1/2" to 49 1/8" height adjustment
- top edge profile on user side and approach sides
- top grommet available, specify location; and add \$51 list each
- maximum weight rating 140 lbs. (evenly distributed load)
- hanging modesty panel included, travels with top
- push button control pad mounted right or left
- 120" power cord
- specify Matte Black (MBK), Arctic Silver (ASL) or White (WH) metal finish
- locking available, specify and add \$82 list
- electrical cut out to fit an EC10, EC11 and EC12 available, specify location and order separately
- wall access cut out in back panel, specify and add \$170 list

36" d Adjustable Height Corner Desk - Flush Modesty Panel	60	72	Adj	464	42	VST3672-C24AHFR	\$5,972	\$6,289		
	60	72	Adj	464	42	VSV3672-C24AHFR			\$8,293	\$8,874
	60	72	Adj	464	42	VST3672-C24AHFL	\$5,972	\$6,289		
	60	72	Adj	464	42	VSV3672-C24AHFL			\$8,293	\$8,874
	60	66	Adj	450	41	VST3666-C24AHFR	\$5,915	\$6,232		
	60	66	Adj	450	41	VSV3666-C24AHFR			\$8,182	\$8,755
	60	66	Adj	450	41	VST3666-C24AHFL	\$5,915	\$6,232		
	60	66	Adj	450	41	VSV3666-C24AHFL			\$8,182	\$8,755



left shown



- 29 1/2" to 49 1/8" height adjustment
- top edge profile on user side and approach sides
- top grommet available, specify location; and add \$51 list each
- maximum weight rating 140 lbs. (evenly distributed load)
- hanging modesty panel included, travels with top
- push button control pad mounted right or left
- 120" power cord
- specify Matte Black (MBK), Arctic Silver (ASL) or White (WH) metal finish
- locking available, specify and add \$82 list
- electrical cut out to fit an EC10, EC11 and EC12 available, specify location and order separately
- wall access cut out in back panel, specify and add \$170 list

To Order, Specify:

① Model Number

Laminate - VST

Veneer - VSV

② Worksurface Material (see page V13)

a.) TFL

b.) HPL

③ Laminate Color (see page V13)

a.) Worksurface Color

b.) Chassis Color

c.) Drawer Color

② Wood Species - Cherry (CH1), Maple (MA1)

Walnut (WA1), Black Oak (BO1) or

Double Cut (DC1) (see page V11)

③ Finish Color (see page V11)

④ Edge Profile (see page V14)

⑤ Pull Style and Color (see page V15)

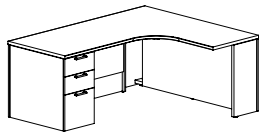
⑥ Optional Grommet Location & Color - Matte Black (MBK) or Arctic Silver (ASL) (see page V16)

⑦ Other Product Options (see page V110)

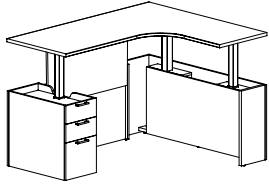
⑧ Accessories (see page VS314)

⑨ Power and Data Options (see page VS324)

Description	D	W	H	CTN WT	CU FT	① Model	TFL Laminate	HPL Laminate	Flat Cut Veneer	Double Cut Veneer
30" d Adjustable Height Corner Desk - Break Front Modesty Panel	60	72	Adj	446	41	VST3072-C30AHBR	\$6,157	\$6,477		
	60	72	Adj	446	41	VSV3072-C30AHBR			\$8,486	\$9,080
	60	72	Adj	446	41	VST3072-C30AHBL	\$6,157	\$6,477		
	60	72	Adj	446	41	VSV3072-C30AHBL			\$8,486	\$9,080
	60	66	Adj	434	39	VST3066-C30AHBR	\$6,104	\$6,421		
	60	66	Adj	434	39	VSV3066-C30AHBR			\$8,455	\$9,046
	60	66	Adj	434	39	VST3066-C30AHBL	\$6,104	\$6,421		
	60	66	Adj	434	39	VSV3066-C30AHBL			\$8,455	\$9,046

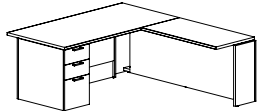


left shown

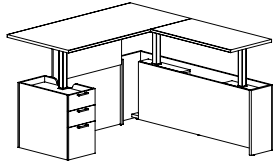


- 29 1/2" to 49 1/8" height adjustment
- top edge profile on user side and approach sides
- top grommet available, specify location; and add \$51 list each
- maximum weight rating 140 lbs. (evenly distributed load)
- hanging modesty panel included, travels with top
- push button control pad mounted right or left
- 120" power cord
- specify Matte Black (MBK), Arctic Silver (ASL) or White (WH) metal finish
- locking available, specify and add \$82 list
- electrical cut out to fit an EC10, EC11 and EC12 available, specify location and order separately
- wall access cut out in back panel, specify and add \$170 list

Description	D	W	H	CTN WT	CU FT	① Model	TFL Laminate	HPL Laminate	Flat Cut Veneer	Double Cut Veneer
36" d Adjustable Height L-Shaped Desk with 48" d Bridge - Break Front Modesty Panel	84	72	Adj	516	47	VST3672-U48AHBR	\$6,163	\$6,438		
	84	72	Adj	516	47	VSV3672-U48AHBR			\$8,610	\$9,213
	84	72	Adj	516	47	VST3672-U48AHBL	\$6,163	\$6,438		
	84	72	Adj	516	47	VSV3672-U48AHBL			\$8,610	\$9,213
	84	66	Adj	502	46	VST3666-U48AHBR	\$6,127	\$6,388		
	84	66	Adj	502	46	VSV3666-U48AHBR			\$8,544	\$9,142
	84	66	Adj	502	46	VST3666-U48AHBL	\$6,127	\$6,388		
	84	66	Adj	502	46	VSV3666-U48AHBL			\$8,544	\$9,142

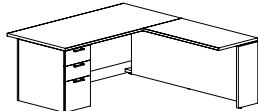


left shown

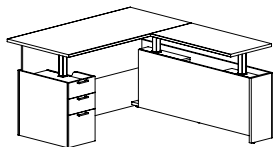


- 29 1/2" to 49 1/8" height adjustment
- top edge profile on user side and approach sides
- top grommet available, specify location; and add \$51 list each
- 1" gap at the end of bridge worksurface
- maximum weight rating 140 lbs. (evenly distributed load)
- hanging modesty panel included, travels with top
- push button control pad mounted right or left
- 120" power cord
- specify Matte Black (MBK), Arctic Silver (ASL) or White (WH) metal finish
- locking available, specify and add \$82 list
- electrical cut out to fit an EC10, EC11 and EC12 available, specify location and order separately
- wall access cut out in back panel, specify and add \$170 list

36" d Adjustable Height L-Shaped Desk with 48" d Bridge - Flush Modesty Panel	84	72	Adj	534	45	VST3672-U48AHFR	\$5,993	\$6,268		
	84	72	Adj	534	45	VSV3672-U48AHFR			\$8,407	\$8,996
	84	72	Adj	534	45	VST3672-U48AHFL	\$5,993	\$6,268		
	84	72	Adj	534	45	VSV3672-U48AHFL			\$8,407	\$8,996
	84	66	Adj	520	44	VST3666-U48AHFR	\$5,954	\$6,213		
	84	66	Adj	520	44	VSV3666-U48AHFR			\$8,337	\$8,921
	84	66	Adj	520	44	VST3666-U48AHFL	\$5,954	\$6,213		
	84	66	Adj	520	44	VSV3666-U48AHFL			\$8,337	\$8,921



left shown



- 29 1/2" to 49 1/8" height adjustment
- top edge profile on user side and approach sides
- top grommet available, specify location; and add \$51 list each
- 1" gap at the end of bridge worksurface
- maximum weight rating 140 lbs. (evenly distributed load)
- hanging modesty panel included, travels with top
- push button control pad mounted right or left
- 120" power cord
- specify Matte Black (MBK), Arctic Silver (ASL) or White (WH) metal finish
- locking available, specify and add \$82 list
- electrical cut out to fit an EC10, EC11 and EC12 available, specify location and order separately
- wall access cut out in back panel, specify and add \$170 list

To Order, Specify:

① Model Number

Laminate - VST

Veneer - VSV

② Worksurface Material (see page V13)

a.) TFL

b.) HPL

③ Laminate Color (see page V13)

a.) Worksurface Color

b.) Chassis Color

c.) Drawer Color

② Wood Species - Cherry (CH1), Maple (MA1)

Walnut (WA1), Black Oak (BO1) or

Double Cut (DC1) (see page V11)

③ Finish Color (see page V11)

④ Edge Profile (see page V14)

⑤ Pull Style and Color (see page V15)

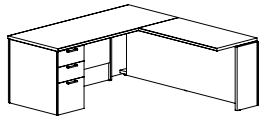
⑥ Optional Grommet Location & Color - Matte Black (MBK) or Arctic Silver (ASL) (see page V16)

⑦ Other Product Options (see page V110)

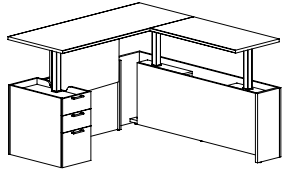
⑧ Accessories (see page VS314)

⑨ Power and Data Options (see page VS324)

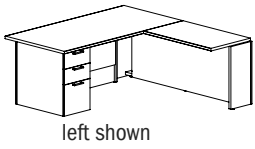
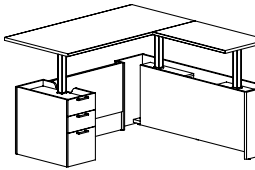
Description	D	W	H	CTN WT	CU FT	① Model	TFL Laminate	HPL Laminate	Flat Cut Veneer	Double Cut Veneer
30" d Adjustable Height L-Shaped Desk with 48" d Bridge - Break Front Modesty Panel	78	72	Adj	471	46	VST3072-U48AHBR	\$6,138	\$6,401		
	78	72	Adj	471	46	VSV3072-U48AHBR			\$8,540	\$9,140
	78	72	Adj	471	46	VST3072-U48AHBL	\$6,138	\$6,401		
	78	72	Adj	471	46	VSV3072-U48AHBL			\$8,540	\$9,140
	78	66	Adj	501	45	VST3066-U48AHBR	\$6,098	\$6,351		
	78	66	Adj	501	45	VSV3066-U48AHBR			\$8,480	\$9,075
	78	66	Adj	501	45	VST3066-U48AHBL	\$6,098	\$6,351		
	78	66	Adj	501	45	VSV3066-U48AHBL			\$8,480	\$9,075



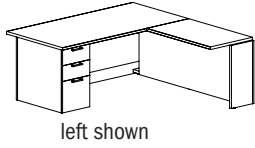
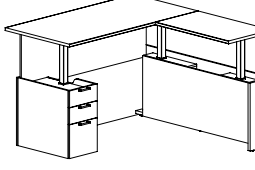
left shown



- 29 1/2" to 49 1/8" height adjustment
- top edge profile on user side and approach sides
- top grommet available, specify location; and add \$51 list each
- 1" gap at the end of bridge worksurface
- maximum weight rating 140 lbs. (evenly distributed load)
- hanging modesty panel included, travels with top
- push button control pad mounted right or left
- 120" power cord
- specify Matte Black (MBK), Arctic Silver (ASL) or White (WH) metal finish
- locking available, specify and add \$82 list
- electrical cut out to fit an EC10, EC11 and EC12 available, specify location and order separately
- wall access cut out in back panel, specify and add \$170 list

Description	D	W	H	CTN WT	CU FT	① Model	TFL Laminate	HPL Laminate	Flat Cut Veneer	Double Cut Veneer
36" d Adjustable Height L-Shaped Desk with 42" d Bridge - Break Front Modesty Panel  left shown 	78	72	Adj	499	45	VST3672-U42AHBR	\$6,130	\$6,407		
	78	72	Adj	499	45	VSV3672-U42AHBR			\$8,567	\$9,168
	78	72	Adj	499	45	VST3672-U42AHBL	\$6,130	\$6,407		
	78	72	Adj	499	45	VSV3672-U42AHBL			\$8,567	\$9,168
	78	66	Adj	485	44	VST3666-U42AHBR	\$6,096	\$6,359		
	78	66	Adj	485	44	VSV3666-U42AHBR			\$8,502	\$9,100
	78	66	Adj	485	44	VST3666-U42AHBL	\$6,096	\$6,359		
	78	66	Adj	485	44	VSV3666-U42AHBL			\$8,502	\$9,100

- 29 1/2" to 49 1/8" height adjustment
- top edge profile on user side
- top grommet available, specify location; and add \$51 list each
- 1" gap at the end of bridge worksurface
- maximum weight rating 140 lbs. (evenly distributed load)
- hanging modesty panel included, travels with top
- push button control pad mounted right or left
- 120" power cord
- specify Matte Black (MBK), Arctic Silver (ASL) or White (WH) metal finish
- locking available, specify and add \$82 list
- electrical cut out to fit an EC10, EC11 and EC12 available, specify location and order separately
- wall access cut out in back panel, specify and add \$170 list

36" d Adjustable Height L-Shaped Desk with 42" d Bridge - Flush Modesty Panel  left shown 	78	72	Adj	518	43	VST3672-U42AHFR	\$5,958	\$6,225		
	78	72	Adj	518	43	VSV3672-U42AHFR			\$8,358	\$8,945
	78	72	Adj	518	43	VST3672-U42AHFL	\$5,958	\$6,225		
	78	72	Adj	518	43	VSV3672-U42AHFL			\$8,358	\$8,945
	78	66	Adj	504	42	VST3666-U42AHFR	\$5,921	\$6,185		
	78	66	Adj	504	42	VSV3666-U42AHFR			\$8,289	\$8,871
	78	66	Adj	504	42	VST3666-U42AHFL	\$5,921	\$6,185		
	78	66	Adj	504	42	VSV3666-U42AHFL			\$8,289	\$8,871

- 29 1/2" to 49 1/8" height adjustment
- top edge profile on user side and approach sides
- top grommet available, specify location; and add \$51 list each
- 1" gap at the end of bridge worksurface
- maximum weight rating 140 lbs. (evenly distributed load)
- hanging modesty panel included, travels with top
- push button control pad mounted right or left
- 120" power cord
- specify Matte Black (MBK), Arctic Silver (ASL) or White (WH) metal finish
- locking available, specify and add \$82 list
- electrical cut out to fit an EC10, EC11 and EC12 available, specify location and order separately
- wall access cut out in back panel, specify and add \$170 list

To Order, Specify:

① Model Number

Laminate - VST

Veneer - VSV

② Worksurface Material (see page V13)

- a.) TFL
- b.) HPL

③ Laminate Color (see page V13)

- a.) Worksurface Color
- b.) Chassis Color
- c.) Drawer Color

② Wood Species - Cherry (CH1), Maple (MA1)

- Walnut (WA1), Black Oak (BO1) or Double Cut (DC1) (see page V11)

③ Finish Color (see page V11)

④ Edge Profile (see page V14)

⑤ Pull Style and Color (see page V15)

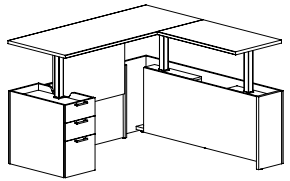
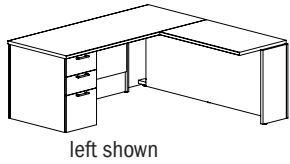
⑥ Optional Grommet Location & Color - Matte Black (MBK) or Arctic Silver (ASL) (see page V16)

⑦ Other Product Options (see page V110)

⑧ Accessories (see page VS314)

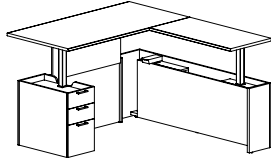
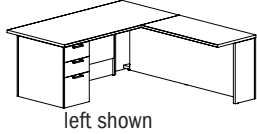
⑨ Power and Data Options (see page VS324)

Description	D	W	H	CTN WT	CU FT	① Model	TFL Laminate	HPL Laminate	Flat Cut Veneer	Double Cut Veneer
30" d Adjustable Height L-Shaped Desk with 42" d Bridge - Break Front Modesty Panel	72	72	Adj	485	44	VST3072-U42AHBR	\$6,104	\$6,359		
	72	72	Adj	485	44	VSV3072-U42AHBR			\$8,500	\$9,097
	72	72	Adj	485	44	VST3072-U42AHBL	\$6,104	\$6,359		
	72	72	Adj	485	44	VSV3072-U42AHBL			\$8,500	\$9,097
	72	66	Adj	472	43	VST3066-U42AHBR	\$6,065	\$6,309		
	72	66	Adj	472	43	VSV3066-U42AHBR			\$8,439	\$9,030
	72	66	Adj	472	43	VST3066-U42AHBL	\$6,065	\$6,309		
	72	66	Adj	472	43	VSV3066-U42AHBL			\$8,439	\$9,030



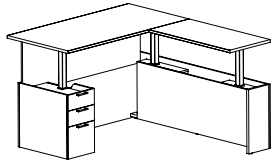
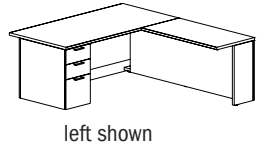
- 29 1/2" to 49 1/8" height adjustment
- top edge profile on user side and approach sides
- top grommet available, specify location; and add \$51 list each
- 1" gap at the end of bridge worksurface
- maximum weight rating 140 lbs. (evenly distributed load)
- hanging modesty panel included, travels with top
- push button control pad mounted right or left
- 120" power cord
- specify Matte Black (MBK), Arctic Silver (ASL) or White (WH) metal finish
- locking available, specify and add \$82 list
- electrical cut out to fit an EC10, EC11 and EC12 available, specify location and order separately
- wall access cut out in back panel, specify and add \$170 list

Description	D	W	H	CTN WT	CU FT	① Model	TFL Laminate	HPL Laminate	Flat Cut Veneer	Double Cut Veneer
36" d Adjustable Height L-Shaped Desk with 48" d Return - Break Front Modesty Panel	84	72	Adj	516	47	VST3672-L48AHBR	\$6,163	\$6,438		
	84	72	Adj	516	47	VSV3672-L48AHBR			\$8,610	\$9,213
	84	72	Adj	516	47	VST3672-L48AHBL	\$6,163	\$6,438		
	84	72	Adj	516	47	VSV3672-L48AHBL			\$8,610	\$9,213
	84	66	Adj	502	46	VST3666-L48AHBR	\$6,127	\$6,388		
	84	66	Adj	502	46	VSV3666-L48AHBR			\$8,544	\$9,142
	84	66	Adj	502	46	VST3666-L48AHBL	\$6,127	\$6,388		
	84	66	Adj	502	46	VSV3666-L48AHBL			\$8,544	\$9,142



- 29 1/2" to 49 1/8" height adjustment
- top edge profile on user side and approach sides
- top grommet available, specify location; and add \$51 list each
- maximum weight rating 140 lbs. (evenly distributed load)
- hanging modesty panel included, travels with top
- push button control pad mounted right or left
- 120" power cord
- specify Matte Black (MBK), Arctic Silver (ASL) or White (WH) metal finish
- locking available, specify and add \$82 list
- electrical cut out to fit an EC10, EC11 and EC12 available, specify location and order separately
- wall access cut out in back panel, specify and add \$170 list

36" d Adjustable Height L-Shaped Desk with 48" d Return - Flush Modesty Panel	84	72	Adj	534	45	VST3672-L48AHFR	\$5,993	\$6,268		
	84	72	Adj	534	45	VSV3672-L48AHFR			\$8,407	\$8,996
	84	72	Adj	534	45	VST3672-L48AHFL	\$5,993	\$6,268		
	84	72	Adj	534	45	VSV3672-L48AHFL			\$8,407	\$8,996
	84	66	Adj	520	44	VST3666-L48AHFR	\$5,954	\$6,213		
	84	66	Adj	520	44	VSV3666-L48AHFR			\$8,337	\$8,921
	84	66	Adj	520	44	VST3666-L48AHFL	\$5,954	\$6,213		
	84	66	Adj	520	44	VSV3666-L48AHFL			\$8,337	\$8,921



- 29 1/2" to 49 1/8" height adjustment
- top edge profile on user side and approach sides
- top grommet available, specify location; and add \$51 list each
- maximum weight rating 140 lbs. (evenly distributed load)
- hanging modesty panel included, travels with top
- push button control pad mounted right or left
- 120" power cord
- specify Matte Black (MBK), Arctic Silver (ASL) or White (WH) metal finish
- locking available, specify and add \$82 list
- electrical cut out to fit an EC10, EC11 and EC12 available, specify location and order separately
- wall access cut out in back panel, specify and add \$170 list

To Order, Specify:

① Model Number

Laminate - VST

Veneer - VSV

② Worksurface Material (see page VI3)

a.) TFL

b.) HPL

③ Laminate Color (see page VI3)

a.) Worksurface Color

b.) Chassis Color

c.) Drawer Color

② Wood Species - Cherry (CH1), Maple (MA1)

Walnut (WA1), Black Oak (BO1) or

Double Cut (DC1) (see page VI1)

③ Finish Color (see page VI1)

④ Edge Profile (see page VI4)

⑤ Pull Style and Color (see page VI5)

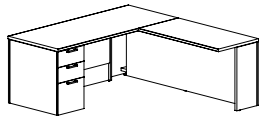
⑥ Optional Grommet Location & Color - Matte Black (MBK) or Arctic Silver (ASL) (see page VI6)

⑦ Other Product Options (see page VI10)

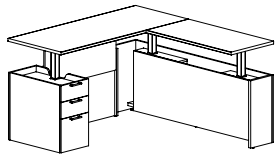
⑧ Accessories (see page VS314)

⑨ Power and Data Options (see page VS324)

Description	D	W	H	CTN WT	CU FT	① Model	TFL Laminate	HPL Laminate	Flat Cut Veneer	Double Cut Veneer
30" d Adjustable Height L-Shaped Desk with 48" d Return - Break Front Modesty Panel	78	72	Adj	471	46	VST3072-L48AHBR	\$6,138	\$6,401		
	78	72	Adj	471	46	VSV3072-L48AHBR			\$8,540	\$9,140
	78	72	Adj	471	46	VST3072-L48AHBL	\$6,138	\$6,401		
	78	72	Adj	471	46	VSV3072-L48AHBL			\$8,540	\$9,140
	78	66	Adj	501	45	VST3066-L48AHBR	\$6,098	\$6,351		
	78	66	Adj	501	45	VSV3066-L48AHBR			\$8,480	\$9,075
	78	66	Adj	501	45	VST3066-L48AHBL	\$6,098	\$6,351		
	78	66	Adj	501	45	VSV3066-L48AHBL			\$8,480	\$9,075

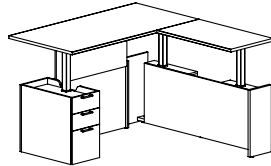
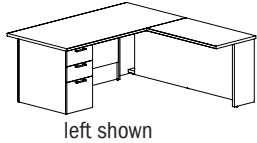


left shown



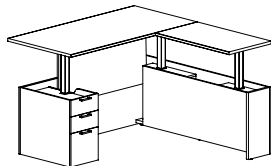
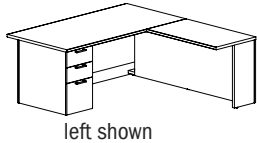
- 29 1/2" to 49 1/8" height adjustment
- top edge profile on user side and approach sides
- top grommet available, specify location; and add \$51 list each
- maximum weight rating 140 lbs. (evenly distributed load)
- hanging modesty panel included, travels with top
- push button control pad mounted right or left
- 120" power cord
- specify Matte Black (MBK), Arctic Silver (ASL) or White (WH) metal finish
- locking available, specify and add \$82 list
- electrical cut out to fit an EC10, EC11 and EC12 available, specify location and order separately
- wall access cut out in back panel, specify and add \$170 list

Description	D	W	H	CTN WT	CU FT	① Model	TFL Laminate	HPL Laminate	Flat Cut Veneer	Double Cut Veneer
36" d Adjustable Height L-Shaped Desk with 42" d Return - Break Front Modesty Panel	78	72	Adj	499	45	VST3672-L42AHBR	\$6,130	\$6,407		
	78	72	Adj	499	45	VSV3672-L42AHBR			\$8,567	\$9,168
	78	72	Adj	499	45	VST3672-L42AHBL	\$6,130	\$6,407		
	78	72	Adj	499	45	VSV3672-L42AHBL			\$8,567	\$9,168
	78	66	Adj	485	44	VST3666-L42AHBR	\$6,096	\$6,359		
	78	66	Adj	485	44	VSV3666-L42AHBR			\$8,502	\$9,100
	78	66	Adj	485	44	VST3666-L42AHBL	\$6,096	\$6,359		
	78	66	Adj	485	44	VSV3666-L42AHBL			\$8,502	\$9,100



- 29 1/2" to 49 1/8" height adjustment
- top edge profile on user side and approach sides
- top grommet available, specify location; and add \$51 list each
- maximum weight rating 140 lbs. (evenly distributed load)
- hanging modesty panel included, travels with top
- push button control pad mounted right or left
- 120" power cord
- specify Matte Black (MBK), Arctic Silver (ASL) or White (WH) metal finish
- locking available, specify and add \$82 list
- electrical cut out to fit an EC10, EC11 and EC12 available, specify location and order separately
- wall access cut out in back panel, specify and add \$170 list

36" d Adjustable Height L-Shaped Desk with 42" d Return - Flush Modesty Panel	78	72	Adj	518	43	VST3672-L42AHFR	\$5,958	\$6,225		
	78	72	Adj	518	43	VSV3672-L42AHFR			\$8,358	\$8,945
	78	72	Adj	518	43	VST3672-L42AHFL	\$5,958	\$6,225		
	78	72	Adj	518	43	VSV3672-L42AHFL			\$8,358	\$8,945
	78	66	Adj	504	42	VST3666-L42AHFR	\$5,921	\$6,185		
	78	66	Adj	504	42	VSV3666-L42AHFR			\$8,289	\$8,871
	78	66	Adj	504	42	VST3666-L42AHFL	\$5,921	\$6,185		
	78	66	Adj	504	42	VSV3666-L42AHFL			\$8,289	\$8,871



- 29 1/2" to 49 1/8" height adjustment
- top edge profile on user side and approach sides
- top grommet available, specify location; and add \$51 list each
- maximum weight rating 140 lbs. (evenly distributed load)
- hanging modesty panel included, travels with top
- push button control pad mounted right or left
- 120" power cord
- specify Matte Black (MBK), Arctic Silver (ASL) or White (WH) metal finish
- locking available, specify and add \$82 list
- electrical cut out to fit an EC10, EC11 and EC12 available, specify location and order separately
- wall access cut out in back panel, specify and add \$170 list

To Order, Specify:

① Model Number

Laminate - VST

Veneer - VSV

② Worksurface Material (see page V13)

a.) TFL

b.) HPL

③ Laminate Color (see page V13)

a.) Worksurface Color

b.) Chassis Color

c.) Drawer Color

② Wood Species - Cherry (CH1), Maple (MA1)

Walnut (WA1), Black Oak (BO1) or

Double Cut (DC1) (see page V11)

③ Finish Color (see page V11)

④ Edge Profile (see page V14)

⑤ Pull Style and Color (see page V15)

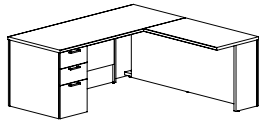
⑥ Optional Grommet Location & Color - Matte Black (MBK) or Arctic Silver (ASL) (see page V16)

⑦ Other Product Options (see page V110)

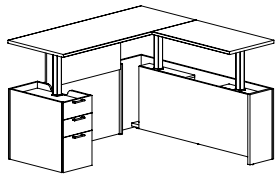
⑧ Accessories (see page VS314)

⑨ Power and Data Options (see page VS324)

Description	D	W	H	CTN WT	CU FT	① Model	TFL Laminate	HPL Laminate	Flat Cut Veneer	Double Cut Veneer
30" d Adjustable Height L-Shaped Desk with 42" d Return - Break Front Modesty Panel	72	72	Adj	485	44	VST3072-L42AHBR	\$6,104	\$6,359		
	72	72	Adj	485	44	VSV3072-L42AHBR			\$8,500	\$9,097
	72	72	Adj	485	44	VST3072-L42AHBL	\$6,104	\$6,359		
	72	72	Adj	485	44	VSV3072-L42AHBL			\$8,500	\$9,097
	72	66	Adj	472	43	VST3066-L42AHBR	\$6,065	\$6,309		
	72	66	Adj	472	43	VSV3066-L42AHBR			\$8,439	\$9,030
	72	66	Adj	472	43	VST3066-L42AHBL	\$6,065	\$6,309		
	72	66	Adj	472	43	VSV3066-L42AHBL			\$8,439	\$9,030

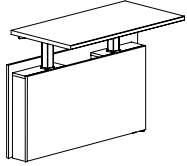
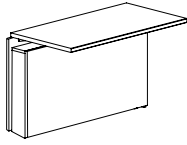


left shown



- 29 1/2" to 49 1/8" height adjustment
- top edge profile on user side and approach sides
- top grommet available, specify location; and add \$51 list each
- maximum weight rating 140 lbs. (evenly distributed load)
- hanging modesty panel included, travels with top
- push button control pad mounted right or left
- 120" power cord
- specify Matte Black (MBK), Arctic Silver (ASL) or White (WH) metal finish
- locking available, specify and add \$82 list
- electrical cut out to fit an EC10, EC11 and EC12 available, specify location and order separately
- wall access cut out in back panel, specify and add \$170 list

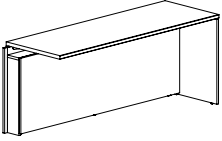
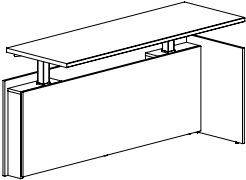
Description	D	W	H	CTN WT	CU FT	① Model	TFL Laminate	HPL Laminate	Flat Cut Veneer	Double Cut Veneer
Adjustable Height Bridge	24	48	Adj.	175	24	VST2448AHB	\$3,167	\$3,315		
	24	48	Adj.	175	24	VSV2448AHB			\$4,371	\$4,677
	24	42	Adj.	166	21	VST2442AHB	\$3,128	\$3,263		
	24	42	Adj.	166	21	VSV2442AHB			\$4,310	\$4,612



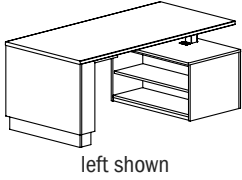
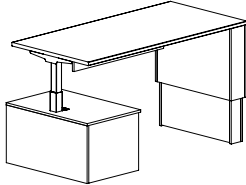
- attaches to fixed height desk & credenza
- 29 1/2" to 49 1/8" height adjustment
- top edge profile on user side
- top grommet available, specify location; and add \$51 list each
- 1" gap on ends
- maximum weight rating 140 lbs. (evenly distributed load)
- push button control pad mounted right or left
- 120" power cord
- specify Matte Black (MBK), Arctic Silver (ASL) or White (WH) metal finish
- electrical cut out to fit an EC10, EC11 and EC12 available, specify location and order separately
- wall access cut out in back panel, specify and add \$170 list

To Order, Specify:

① Model Number	Laminate - VST	Veneer - VSV	
	<p>② Worksurface Material (see page VI3)</p> <p>a.) TFL</p> <p>b.) HPL</p>	<p>② Wood Species - Cherry (CH1), Maple (MA1)</p> <p>Walnut (WA1), Black Oak (BO1) or</p> <p>Double Cut (DC1) (see page VI1)</p>	<p>④ Edge Profile (see page VI4)</p> <p>⑤ Pull Style and Color (see page VI5)</p>
	<p>③ Laminate Color (see page VI3)</p> <p>a.) Worksurface Color</p> <p>b.) Chassis Color</p> <p>c.) Drawer Color</p>	<p>③ Finish Color (see page VI1)</p>	<p>⑥ Optional Grommet Location & Color - Matte Black (MBK) or Arctic Silver (ASL) (see page VI6)</p> <p>⑦ Other Product Options (see page VI10)</p> <p>⑧ Accessories (see page VS314)</p> <p>⑨ Power and Data Options (see page VS324)</p>

Description	D	W	H	CTN WT	CU FT	① Model	TFL Laminate	HPL Laminate	Flat Cut Veneer	Double Cut Veneer
Adjustable Height Kneespace Return	24	72	Adj.	269	36	VST2472AHRR	\$3,485	\$3,654		
	24	72	Adj.	269	36	VSV2472AHRR			\$5,082	\$5,492
 right shown	24	72	Adj.	269	36	VST2472AHRL	\$3,485	\$3,654		
	24	72	Adj.	269	36	VSV2472AHRL			\$5,082	\$5,492
	24	66	Adj.	254	33	VST2466AHRR	\$3,440	\$3,603		
	24	66	Adj.	254	33	VSV2466AHRR			\$5,017	\$5,422
	24	66	Adj.	254	33	VST2466AHRL	\$3,440	\$3,603		
	24	66	Adj.	254	33	VSV2466AHRL			\$5,017	\$5,422
	24	60	Adj.	237	30	VST2460AHRR	\$3,395	\$3,553		
	24	60	Adj.	237	30	VSV2460AHRR			\$5,000	\$5,351
	24	60	Adj.	237	30	VST2460AHRL	\$3,395	\$3,553		
	24	60	Adj.	237	30	VSV2460AHRL			\$5,000	\$5,351
	24	54	Adj.	221	27	VST2454AHRR	\$3,350	\$3,499		
	24	54	Adj.	221	27	VSV2454AHRR			\$4,934	\$5,281
	24	54	Adj.	221	27	VST2454AHRL	\$3,350	\$3,499		
	24	54	Adj.	221	27	VSV2454AHRL			\$4,934	\$5,281
	24	48	Adj.	205	24	VST2448AHRR	\$3,306	\$3,447		
	24	48	Adj.	205	24	VSV2448AHRR			\$4,869	\$5,210
	24	48	Adj.	205	24	VST2448AHRL	\$3,306	\$3,447		
	24	48	Adj.	205	24	VSV2448AHRL			\$4,869	\$5,210

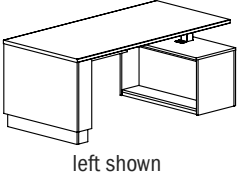
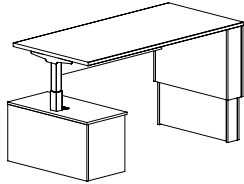
- attaches to fixed height desk
- 29 1/2" to 49 1/8" height adjustment
- top edge profile on user side
- top grommet available, specify location; and add \$51 list each
- 1" gap on attaching end
- maximum weight rating 140 lbs. (evenly distributed load)
- push button control pad mounted right or left
- 120" power cord
- specify Matte Black (MBK), Arctic Silver (ASL) or White (WH) metal finish
- electrical cut out to fit an EC10, EC11 and EC12 available, specify location and order separately
- wall access cut out in back panel, specify and add \$170 list

Description	D	W	H	CTN WT	CU FT	① Model	TFL Laminate	HPL Laminate	Flat Cut Veneer	Double Cut Veneer
Adjustable Height Peninsula Desk -24" d Credenza	36	72	Adj	340	35	VSTB3672-AH24PDR	\$4,168	\$4,386		
	36	72	Adj	340	35	VSVB3672-AH24PDR			\$6,147	\$6,579
	36	72	Adj	340	35	VSTB3672-AH24PDL	\$4,168	\$4,386		
	36	72	Adj	340	35	VSVB3672-AH24PDL			\$6,147	\$6,579
	36	66	Adj	332	35	VSTB3666-AH24PDR	\$4,150	\$4,357		
	36	66	Adj	332	35	VSVB3666-AH24PDR			\$6,103	\$6,533
	36	66	Adj	332	35	VSTB3666-AH24PDL	\$4,150	\$4,357		
	36	66	Adj	332	35	VSVB3666-AH24PDL			\$6,103	\$6,533
	36	60	Adj	323	34	VSTB3660-AH24PDR	\$4,131	\$4,332		
	36	60	Adj	323	34	VSVB3660-AH24PDR			\$6,060	\$6,485
	36	60	Adj	323	34	VSTB3660-AH24PDL	\$4,131	\$4,332		
	36	60	Adj	323	34	VSVB3660-AH24PDL			\$6,060	\$6,485
	30	72	Adj	297	30	VSTB3072-AH24PDR	\$4,042	\$4,242		
	30	72	Adj	297	30	VSVB3072-AH24PDR			\$5,765	\$6,168
	30	72	Adj	297	30	VSTB3072-AH24PDL	\$4,042	\$4,242		
	30	72	Adj	297	30	VSVB3072-AH24PDL			\$5,765	\$6,168
	30	66	Adj	289	29	VSTB3066-AH24PDR	\$4,019	\$4,208		
	30	66	Adj	289	29	VSVB3066-AH24PDR			\$5,726	\$6,127
	30	66	Adj	289	29	VSTB3066-AH24PDL	\$4,019	\$4,208		
	30	66	Adj	289	29	VSVB3066-AH24PDL			\$5,726	\$6,127
	30	60	Adj	281	28	VSTB3060-AH24PDR	\$3,995	\$4,174		
	30	60	Adj	281	28	VSVB3060-AH24PDR			\$5,688	\$6,086
	30	60	Adj	281	28	VSTB3060-AH24PDL	\$3,995	\$4,174		
	30	60	Adj	281	28	VSVB3060-AH24PDL			\$5,688	\$6,086

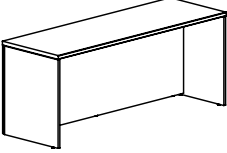
- use with bench height - 24" d credenza
- 29 1/2" to 49 1/8" height adjustment
- top edge profile on user side
- top grommet available, specify location; and add \$51 list each
- 12" hanging modesty panel included, travels with top
- maximum weight rating 140 lbs. (evenly distributed load)
- push button control pad mounted right or left
- 120" power cord
- specify Matte Black (MBK), Arctic Silver (ASL) or White (WH) metal finish
- electrical cut out to fit an EC10, EC11 and EC12 available, specify location and order separately
- wall access cut out in back panel, specify and add \$170 list

To Order, Specify:

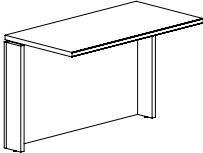
① Model Number	Laminate - VST	Veneer - VSV	
	② Worksurface Material (see page VI3) a.) TFL b.) HPL	② Wood Species - Cherry (CH1), Maple (MA1) Walnut (WA1), Black Oak (BO1) or Double Cut (DC1) (see page VI1)	④ Edge Profile (see page VI4)
	③ Laminate Color (see page VI3) a.) Worksurface Color b.) Chassis Color c.) Drawer Color	③ Finish Color (see page VI1)	⑤ Pull Style and Color (see page VI5)
			⑥ Optional Grommet Location & Color - Matte Black (MBK) or Arctic Silver (ASL) (see page VI6)
			⑦ Other Product Options (see page VI10)
			⑧ Accessories (see page VS314)
			⑨ Power and Data Options (see page VS324)

Description	D	W	H	CTN WT	CU FT	① Model	TFL Laminate	HPL Laminate	Flat Cut Veneer	Double Cut Veneer
Adjustable Height Peninsula Desk - 18" d Credenza	36	72	Adj	314	31	VSTB3672-AH18PDR	\$4,122	\$4,338		
	36	72	Adj	314	31	VSVB3672-AH18PDR			\$5,998	\$6,430
	36	72	Adj	314	31	VSTB3672-AH18PDL	\$4,122	\$4,338		
	36	72	Adj	314	31	VSVB3672-AH18PDL			\$5,998	\$6,430
	36	66	Adj	306	31	VSTB3666-AH18PDR	\$4,103	\$4,308		
	36	66	Adj	306	31	VSVB3666-AH18PDR			\$5,954	\$6,383
	36	66	Adj	306	31	VSTB3666-AH18PDL	\$4,103	\$4,308		
	36	66	Adj	306	31	VSVB3666-AH18PDL			\$5,954	\$6,383
	36	60	Adj	297	30	VSTB3660-AH18PDR	\$4,084	\$4,283		
	36	60	Adj	297	30	VSVB3660-AH18PDR			\$5,911	\$6,334
	36	60	Adj	297	30	VSTB3660-AH18PDL	\$4,084	\$4,283		
	36	60	Adj	297	30	VSVB3660-AH18PDL			\$5,911	\$6,334
	30	72	Adj	274	26	VSTB3072-AH18PDR	\$3,994	\$4,195		
	30	72	Adj	274	26	VSVB3072-AH18PDR			\$5,615	\$6,018
	30	72	Adj	274	26	VSTB3072-AH18PDL	\$3,994	\$4,195		
	30	72	Adj	274	26	VSVB3072-AH18PDL			\$5,615	\$6,018
	30	66	Adj	266	26	VSTB3066-AH18PDR	\$3,971	\$4,161		
	30	66	Adj	266	26	VSVB3066-AH18PDR			\$5,575	\$5,976
	30	66	Adj	266	26	VSTB3066-AH18PDL	\$3,971	\$4,161		
	30	66	Adj	266	26	VSVB3066-AH18PDL			\$5,575	\$5,976
	30	60	Adj	258	25	VSTB3060-AH18PDR	\$3,948	\$4,127		
	30	60	Adj	258	25	VSVB3060-AH18PDR			\$5,538	\$5,937
	30	60	Adj	258	25	VSTB3060-AH18PDL	\$3,948	\$4,127		
	30	60	Adj	258	25	VSVB3060-AH18PDL			\$5,538	\$5,937

- use with bench height - 18" d credenza
- 29 1/2" to 49 1/8" height adjustment
- top edge profile on user side
- top grommet available, specify location; and add \$51 list each
- maximum weight rating 140 lbs. (evenly distributed load)
- push button control pad mounted right or left
- 120" power cord
- specify Matte Black (MBK), Arctic Silver (ASL) or White (WH) metal finish
- electrical cut out to fit an EC10, EC11 and EC12 available, specify location and order separately
- wall access cut out in back panel, specify and add \$170 list

Description	D	W	H	CTN WT	CU FT	① Model	TFL Laminate	HPL Laminate	Flat Cut Veneer	Double Cut Veneer
Adjustable Height Shell Credenza 	24	72	Adj	273	36	VST2472AHC	\$3,585	\$3,761		
	24	72	Adj	273	36	VSV2472AHC			\$5,044	\$5,397
	24	66	Adj	264	33	VST2466AHC	\$3,539	\$3,710		
	24	66	Adj	264	33	VSV2466AHC			\$4,982	\$5,330
	24	60	Adj	255	30	VST2460AHC	\$3,493	\$3,659		
	24	60	Adj	255	30	VSV2460AHC			\$4,920	\$5,265
	24	54	Adj	246	27	VST2454AHC	\$3,448	\$3,605		
	24	54	Adj	246	27	VSV2454AHC			\$4,860	\$5,200
	24	48	Adj	237	24	VST2448AHC	\$3,405	\$3,554		
	24	48	Adj	237	24	VSV2448AHC			\$4,798	\$5,135

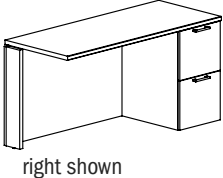
- 29 1/2" to 49 1/8" height adjustment
- top edge profile on user side
- top grommet available, specify location; and add \$51 list each
- maximum weight rating 140 lbs. (evenly distributed load)
- push button control pad mounted right or left
- 120" power cord
- specify Matte Black (MBK), Arctic Silver (ASL) or White (WH) metal finish
- electrical cut out to fit an EC10, EC11 and EC12 available, specify location and order separately
- wall access cut out in back panel, specify and add \$170 list

Bridge with Modesty Panel for Adjustable Height 	24	48	29 1/2	117	4	VST2448AAEB	\$614	\$645		
	24	78	29 1/2	117	4	VSV2448AAEB			\$763	\$840
	24	42	29 1/2	114	3	VST2442AAEB	\$590	\$619		
	24	42	29 1/2	114	3	VSV2442AAEB			\$729	\$803
	24	36	29 1/2	106	3	VST2436AAEB	\$565	\$593		
	24	36	29 1/2	106	3	VSV2436AAEB			\$708	\$782
	20	48	29 1/2	109	4	VST2048AAEB	\$591	\$620		
	20	48	29 1/2	109	4	VSV2048AAEB			\$734	\$806
	20	42	29 1/2	107	3	VST2042AAEB	\$565	\$593		
	20	42	29 1/2	107	3	VSV2042AAEB			\$702	\$774
	20	36	29 1/2	101	3	VST2036AAEB	\$542	\$569		
	20	36	29 1/2	101	3	VSV2036AAEB			\$683	\$750

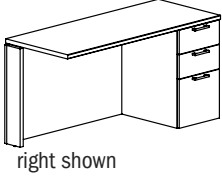
- attaches to adjustable height single pedestal desk on one end and fixed height credenza on other end
- top edge profile on user side
- top grommet available, specify location; and add \$51 list each
- 1" gap between bridge and desk surface
- chassis grommet available, specify and add \$49 list
- ships KD

To Order, Specify:

① Model Number	Laminate - VST	Veneer - VSV	
② Worksurface Material (see page V13)	② Wood Species - Cherry (CH1), Maple (MA1)	④ Edge Profile (see page V14)	
a.) TFL	Walnut (WA1), Black Oak (BO1) or	⑤ Pull Style and Color (see page V15)	
b.) HPL	Double Cut (DC1) (see page V11)	⑥ Optional Grommet Location & Color -	
③ Laminate Color (see page V13)	③ Finish Color (see page V11)	Matte Black (MBK) or Arctic Silver (ASL)	
a.) Worksurface Color		(see page V16)	
b.) Chassis Color		⑦ Other Product Options (see page V110)	
c.) Drawer Color		⑧ Accessories (see page VS314)	
		⑨ Power and Data Options (see page VS324)	

Description	D	W	H	CTN WT	CU FT	① Model	TFL Laminate	HPL Laminate	Flat Cut Veneer	Double Cut Veneer
File/File Return for Adjustable Height Desk	24	60	29 ½	190	30	VST2460AAERR	\$1,670	\$1,761		
	24	60	29 ½	190	30	VSV2460AAERR			\$2,436	\$2,687
 right shown	24	60	29 ½	190	30	VST2460AAELR	\$1,670	\$1,761		
	24	60	29 ½	190	30	VSV2460AAELR			\$2,436	\$2,687
	24	54	29 ½	179	27	VST2454AAERR	\$1,532	\$1,614		
	24	54	29 ½	179	27	VSV2454AAERR			\$2,369	\$2,611
	24	54	29 ½	179	27	VST2454AAELR	\$1,532	\$1,614		
	24	54	29 ½	179	27	VSV2454AAELR			\$2,369	\$2,611
	24	48	29 ½	168	25	VST2448AAERR	\$1,266	\$1,337		
	24	48	29 ½	168	25	VSV2448AAERR			\$2,262	\$2,493
	24	48	29 ½	168	25	VST2448AAELR	\$1,266	\$1,337		
	24	48	29 ½	168	25	VSV2448AAELR			\$2,262	\$2,493
	24	42	29 ½	155	22	VST2442AAERR	\$1,184	\$1,249		
	24	42	29 ½	155	22	VSV2442AAERR			\$2,195	\$2,419
	24	42	29 ½	155	22	VST2442AAELR	\$1,184	\$1,249		
	24	42	29 ½	155	22	VSV2442AAELR			\$2,195	\$2,419
	20	60	29 ½	173	26	VST2060AAERR	\$1,602	\$1,686		
	20	60	29 ½	173	26	VSV2060AAERR			\$2,339	\$2,577
	20	60	29 ½	173	26	VST2060AAELR	\$1,602	\$1,686		
	20	60	29 ½	173	26	VSV2060AAELR			\$2,339	\$2,577
	20	54	29 ½	163	23	VST2054AAERR	\$1,470	\$1,549		
	20	54	29 ½	163	23	VSV2054AAERR			\$2,271	\$2,505
	20	54	29 ½	163	23	VST2054AAELR	\$1,470	\$1,549		
	20	54	29 ½	163	23	VSV2054AAELR			\$2,271	\$2,505
	20	48	29 ½	154	21	VST2048AAERR	\$1,214	\$1,279		
	20	48	29 ½	154	21	VSV2048AAERR			\$2,168	\$2,391
	20	48	29 ½	154	21	VST2048AAELR	\$1,214	\$1,279		
	20	48	29 ½	154	21	VSV2048AAELR			\$2,168	\$2,391
	20	42	29 ½	142	18	VST2042AAERR	\$1,134	\$1,197		
	20	42	29 ½	142	18	VSV2042AAERR			\$2,106	\$2,323
	20	42	29 ½	142	18	VST2042AAELR	\$1,134	\$1,197		
	20	42	29 ½	142	18	VSV2042AAELR			\$2,106	\$2,323

- attaches to adjustable height case single pedestal desk
- 1" gap between return and desk surface
- top edge profile on user side
- top grommet available, specify location; and add \$51 list each
- chassis grommet available, specify and add \$97 list
- locking available, specify and add \$80 list
- specify Matte Black (MBK) or Arctic Silver (ASL) or White (WH) metal finish

Description	D	W	H	CTN WT	CU FT	① Model	TFL Laminate	HPL Laminate	Flat Cut Veneer	Double Cut Veneer
24" d Box/Box/File Return for Adjustable Height Desk 	24	60	29½	190	30	VST2460AAERY	\$1,670	\$1,761		
	24	60	29½	190	30	VSV2460AAERY			\$2,436	\$2,687
	24	60	29½	190	30	VST2460AAELY	\$1,670	\$1,761		
	24	60	29½	190	30	VSV2460AAELY			\$2,436	\$2,687
	24	54	29½	179	27	VST2454AAERY	\$1,532	\$1,614		
	24	54	29½	179	27	VSV2454AAERY			\$2,369	\$2,611
	24	54	29½	179	27	VST2454AAELY	\$1,532	\$1,614		
	24	54	29½	179	27	VSV2454AAELY			\$2,369	\$2,611
	24	48	29½	168	25	VST2448AAERY	\$1,266	\$1,337		
	24	48	29½	168	25	VSV2448AAERY			\$2,262	\$2,493
	24	48	29½	168	25	VST2448AAELY	\$1,266	\$1,337		
	24	48	29½	168	25	VSV2448AAELY			\$2,262	\$2,493
	24	42	29½	155	22	VST2442AAERY	\$1,184	\$1,249		
	24	42	29½	155	22	VSV2442AAERY			\$2,195	\$2,419
	24	42	29½	155	22	VST2442AAELY	\$1,184	\$1,249		
	24	42	29½	155	22	VSV2442AAELY			\$2,195	\$2,419

- attaches to adjustable height single pedestal desk
- 1" gap between return and desk surface
- top edge profile on user side
- top grommet available, specify location; and add \$51 list each
- chassis grommet available, specify and add \$97 list
- locking available, specify and add \$80 list

To Order, Specify:

① Model Number

Laminate - VST

Veneer - VSV

② Worksurface Material (see page VI3)

a.) TFL

b.) HPL

③ Laminate Color (see page VI3)

a.) Worksurface Color

b.) Chassis Color

c.) Drawer Color

② Wood Species - Cherry (CH1), Maple (MA1)

Walnut (WA1), Black Oak (BO1) or

Double Cut (DC1) (see page VI1)

③ Finish Color (see page VI1)

④ Edge Profile (see page VI4)

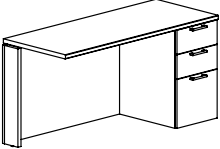
⑤ Pull Style and Color (see page VI5)

⑥ Optional Grommet Location & Color -
Matte Black (MBK) or Arctic Silver (ASL)
(see page VI6)

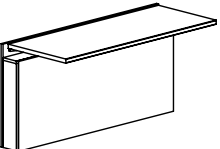
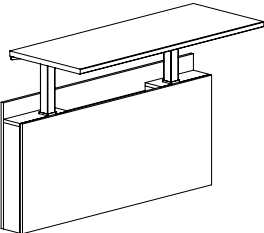
⑦ Other Product Options (see page VI10)

⑧ Accessories (see page VS314)

⑨ Power and Data Options (see page VS324)

Description	D	W	H	CTN WT	CU FT	① Model	TFL Laminate	HPL Laminate	Flat Cut Veneer	Double Cut Veneer
20" d Box/Box/File Return for Adjustable Height Desk  right shown	20	60	29 1/2	173	26	VST2060AAERY	\$1,602	\$1,686		
	20	60	29 1/2	173	26	VSV2060AAERY			\$2,339	\$2,577
	20	60	29 1/2	173	26	VST2060AAELY	\$1,602	\$1,686		
	20	60	29 1/2	173	26	VSV2060AAELY			\$2,339	\$2,577
	20	54	29 1/2	163	23	VST2054AAERY	\$1,470	\$1,549		
	20	54	29 1/2	163	23	VSV2054AAERY			\$2,271	\$2,505
	20	54	29 1/2	163	23	VST2054AAELY	\$1,470	\$1,549		
	20	54	29 1/2	163	23	VSV2054AAELY			\$2,271	\$2,505
	20	48	29 1/2	154	21	VST2048AAERY	\$1,214	\$1,279		
	20	48	29 1/2	154	21	VSV2048AAERY			\$2,168	\$2,391
	20	48	29 1/2	154	21	VST2048AAELY	\$1,214	\$1,279		
	20	48	29 1/2	154	21	VSV2048AAELY			\$2,168	\$2,391
	20	42	29 1/2	142	18	VST2042AAERY	\$1,134	\$1,197		
	20	42	29 1/2	142	18	VSV2042AAERY			\$2,106	\$2,323
	20	42	29 1/2	142	18	VST2042AAELY	\$1,134	\$1,197		
20	42	29 1/2	142	18	VSV2042AAELY			\$2,106	\$2,323	

- attaches to adjustable height single pedestal desk
- 1" gap between return and desk surface
- top edge profile on user side
- top grommet available, specify location; and add \$51 list each
- chassis grommet available, specify and add \$97 list
- locking available, specify and add \$80 list

Adjustable Height Workwall Bridge	D	W	H	CTN WT	CU FT	① Model	TFL Laminate	HPL Laminate	Flat Cut Veneer	Double Cut Veneer
 	24	60	Adj	168	30	VST2460WAHB	\$3,262	\$3,428		
	24	60	Adj	168	30	VSV2460WAHB			\$4,890	\$5,232
	24	54	Adj	159	27	VST2454WAHB	\$3,217	\$3,373		
	24	54	Adj	159	27	VSV2454WAHB			\$4,824	\$5,163
	24	48	Adj	150	24	VST2448WAHB	\$3,171	\$3,318		
	24	48	Adj	150	24	VSV2448WAHB			\$4,759	\$5,093
	24	42	Adj	141	21	VST2442WAHB	\$3,128	\$3,263		
	24	42	Adj	141	21	VSV2442WAHB			\$4,694	\$5,023

- attaches to workwall peninsula desk
- attaches to side of vertical storage or standard credenza
- 29 1/2" to 49 1/8" height adjustment
- 1" gap between bridge and adjacent surfaces
- top edge profile on user side
- top grommet available, specify location; and add \$51 list each
- push button control pad mounted right or left
- 120" power cord
- maximum weight rating 140 lbs. (evenly distributed load)
- ships KD
- specify Matte Black (MBK), Arctic Silver (ASL) or White (WH) metal finish
- electrical cut out to fit an EC10, EC11 and EC12 available, specify location and order separately

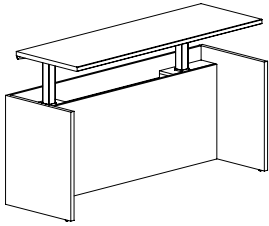
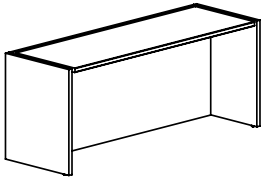
Description	D	W	H	CTN WT	CU FT	① Model	TFL Laminate	HPL Laminate	Flat Cut Veneer	Double Cut Veneer
Adjustable Height Workwall Return  right shown 	24	60	Adj	192	30	VST2460WAHRR	\$3,395	\$3,553		
	24	60	Adj	192	30	VSV2460WAHRR			\$5,000	\$5,351
	24	60	Adj	192	30	VST2460WAHRL	\$3,395	\$3,553		
	24	60	Adj	192	30	VSV2460WAHRL			\$5,000	\$5,351
	24	54	Adj	183	27	VST2454WAHRR	\$3,350	\$3,499		
	24	54	Adj	183	27	VSV2454WAHRR			\$4,934	\$5,281
	24	54	Adj	183	27	VST2454WAHRL	\$3,350	\$3,499		
	24	54	Adj	183	27	VSV2454WAHRL			\$4,934	\$5,281
	24	48	Adj	174	24	VST2448WAHRR	\$3,306	\$3,447		
	24	48	Adj	174	24	VSV2448WAHRR			\$4,869	\$5,210
	24	48	Adj	174	24	VST2448WAHRL	\$3,306	\$3,447		
	24	48	Adj	174	24	VSV2448WAHRL			\$4,869	\$5,210
	24	42	Adj	165	21	VST2442WAHRR	\$3,262	\$3,395		
	24	42	Adj	165	21	VSV2442WAHRR			\$4,804	\$5,210
	24	42	Adj	165	21	VST2442WAHRL	\$3,262	\$3,395		
	24	42	Adj	165	21	VSV2442WAHRL			\$4,804	\$5,210

- attaches to workwall peninsula desk or side of vertical storage or standard credenza
- 29 1/2" to 49 1/8" height adjustment
- 1" gap between return and desk surface
- top edge profile on user side
- top grommet available, specify location; and add \$51 list each
- push button control pad mounted right or left
- 120" power cord
- maximum weight rating 140 lbs. (evenly distributed load)
- ships KD
- specify Matte Black (MBK), Arctic Silver (ASL) or White (WH) metal finish
- electrical cut out to fit an EC10, EC11 and EC12 available, specify location and order separately

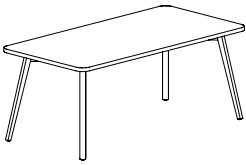
To Order, Specify:

① Model Number	Laminate - VST	Veneer - VSV	
	② Worksurface Material (see page VI3) a.) TFL b.) HPL	② Wood Species - Cherry (CH1), Maple (MA1) Walnut (WA1), Black Oak (BO1) or Double Cut (DC1) (see page VI1)	④ Edge Profile (see page VI4) ⑤ Pull Style and Color (see page VI5)
	③ Laminate Color (see page VI3) a.) Worksurface Color b.) Chassis Color c.) Drawer Color	③ Finish Color (see page VI1)	⑥ Optional Grommet Location & Color - Matte Black (MBK) or Arctic Silver (ASL) (see page VI6) ⑦ Other Product Options (see page VI10) ⑧ Accessories (see page VS314) ⑨ Power and Data Options (see page VS324)

Description	D	W	H	CTN WT	CU FT	① Model	TFL Laminate	HPL Laminate	Flat Cut Veneer	Double Cut Veneer
Adjustable Height Workwall Credenza	24	72	Adj	234	36	VST2472WAHC	\$3,639	\$3,803		
	24	72	Adj	234	36	VSV2472WAHC			\$5,424	\$5,803
	24	66	Adj	225	33	VST2466WAHC	\$3,591	\$3,749		
	24	66	Adj	225	33	VSV2466WAHC			\$5,355	\$5,730
	24	60	Adj	216	30	VST2460WAHC	\$3,545	\$3,695		
	24	60	Adj	216	30	VSV2460WAHC			\$5,290	\$5,661
	24	54	Adj	207	27	VST2454WAHC	\$3,501	\$3,644		
	24	54	Adj	207	27	VSV2454WAHC			\$5,224	\$5,590
	24	48	Adj	198	24	VST2448WAHC	\$3,456	\$3,591		
	24	48	Adj	198	24	VSV2448WAHC			\$5,157	\$5,520




- 29 1/2" to 49 1/8" height adjustment
- top edge profile on user side
- top grommet available, specify location; and add \$51 list each
- push button control pad mounted right or left
- 120" power cord
- maximum weight rating 140 lbs. (evenly distributed load)
- specify Matte Black (MBK), Arctic Silver (ASL) or White (WH) metal finish
- electrical cut out to fit an EC10, EC11 and EC12 available, specify location and order separately

Description	D	W	H	CTN WT	CU FT	① Model	TFL Laminate	HPL Laminate	Flat Cut Veneer	Double Cut Veneer
Table Desk 	36	72	29½	176	20	VST3672TAB	\$2,553	\$2,680		
	36	72	29½	176	20	VSV3672TAB			\$2,754	\$3,029
	36	66	29½	167	18	VST3666TAB	\$2,514	\$2,640		
	36	66	29½	167	18	VSV3666TAB			\$2,699	\$2,969
	30	72	29½	161	17	VST3072TAB	\$2,504	\$2,630		
	30	72	29½	161	17	VSV3072TAB			\$2,675	\$2,943
	30	66	29½	152	16	VST3066TAB	\$2,468	\$2,592		
	30	66	29½	152	16	VSV3066TAB			\$2,626	\$2,889

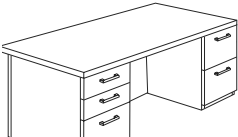
- top edge profile on use and approach sides
- top grommet available, specify location and add \$51 list each
- modesty panel available, see page VS144

To Order, Specify:

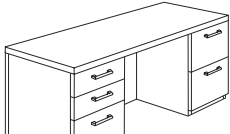
① Model Number	Laminate - VST	Veneer - VSV	
	② Worksurface Material (see page VI3) a.) TFL b.) HPL	② Wood Species - Cherry (CH1), Maple (MA1) Walnut (WA1), Black Oak (BO1) or Double Cut (DC1) (see page VI1)	④ Edge Profile (see page VI4) ⑤ Pull Style and Color (see page VI5) ⑥ Optional Grommet Location & Color - Matte Black (MBK) or Arctic Silver (ASL) (see page VI6)
	③ Laminate Color (see page VI3) a.) Worksurface Color b.) Chassis Color c.) Drawer Color	③ Finish Color (see page VI1)	⑦ Other Product Options (see page VI10) ⑧ Accessories (see page VS314) ⑨ Power and Data Options (see page VS324)

Description	D	W	H	CTN WT	CU FT	① Model	TFL Laminate	HPL Laminate	Flat Cut Veneer	Double Cut Veneer
Double Pedestal Desk with Break Front Modesty 	36	84	29 1/2	420	61	VST3684DD	\$3,129	\$3,300		
	36	84	29 1/2	420	61	VSV3684DD			\$4,079	\$4,501
	36	78	29 1/2	400	57	VST3678DD	\$3,110	\$3,279		
	36	78	29 1/2	400	57	VSV3678DD			\$4,050	\$4,469
	36	72	29 1/2	392	53	VST3672DD	\$2,220	\$2,345		
	36	72	29 1/2	392	53	VSV3672DD			\$3,769	\$4,162

- top edge profile on user and approach sides
- top grommet available, specify location; and add \$51 list each
- chassis grommets available, specify and add \$97 list
- letter width pedestals
- locking available, specify and add \$160 list
- 6" overhang on approach side
- VST3684DD or VSV3684DD chassis - 30" x 84"
- VST3678DD or VSV3678DD chassis - 30" x 78"
- VST3672DD or VSV3672DD chassis - 30" x 72"
- VST3684DD or VSV3684DD kneespace - 52 5/8"
- VST3678DD or VSV3678DD kneespace - 46 5/8"
- VST3672DD or VSV3672DD kneespace - 40 5/8"
- optional 14" half modesty panel available in place of full modesty, specify half modesty and indicate color on order

Double Pedestal Desk with Recessed Modesty 	36	84	29 1/2	420	61	VST3684DDF	\$3,024	\$3,196		
	36	84	29 1/2	420	61	VSV3684DDF			\$3,856	\$4,255
	36	78	29 1/2	400	57	VST3678DDF	\$3,001	\$3,174		
	36	78	29 1/2	400	57	VSV3678DDF			\$3,827	\$4,222
	36	72	29 1/2	392	53	VST3672DDF	\$2,115	\$2,238		
	36	72	29 1/2	392	53	VSV3672DDF			\$3,546	\$3,916

- top edge profile on user and approach sides
- top grommet available, specify location; and add \$51 list each
- chassis grommets available, specify and add \$97 list
- letter width pedestals
- locking available, specify and add \$160 list
- full width modesty panel
- 3 3/4" overhang on approach side
- VST3684DDF or VSV3684DDF chassis - 32 1/4" x 84"
- VST3678DDF or VSV3678DDF chassis - 32 1/4" x 78"
- VST3672DDF or VSV3672DDF chassis - 32 1/4" x 72"
- VST3684DDF or VSV3684DDF kneespace - 52 5/8"
- VST3678DDF or VSV3678DDF kneespace - 46 5/8"
- VST3672DDF or VSV3672DDF kneespace - 40 5/8"

Description	D	W	H	CTN WT	CU FT	① Model	TFL Laminate	HPL Laminate	Flat Cut Veneer	Double Cut Veneer
Double Pedestal with Break Front Modesty 	30	72	29 1/2	368	37	VST3072DD	\$2,193	\$2,314		
	30	72	29 1/2	368	44	VSV3072DD			\$3,741	\$4,128
	30	66	29 1/2	289	41	VST3066DD	\$2,158	\$2,280		
	30	66	29 1/2	289	41	VSV3066DD			\$3,679	\$4,064
	30	60	29 1/2	289	37	VST3060DD	\$2,050	\$2,165		
	30	60	29 1/2	289	37	VSV3060DD			\$3,554	\$3,922

- top edge profile on user and approach sides
- top grommet available, specify location; and add \$51 list each
- chassis grommets available, specify and add \$97 list
- letter width pedestals
- locking available, specify and add \$160 list
- VST3072DD or VSV3072DD kneespace - 40 5/8"
- VST3066DD or VSV3066DD kneespace - 34 5/8"
- VST3060DD or VSV3060DD kneespace - 28 5/8"
- optional 14" half modesty panel available in place of full modesty, specify half modesty and indicate color on order

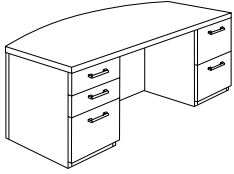
Double Pedestal Desk with Recessed Modesty 	30	72	29 1/2	368	44	VST3072DDF	\$2,087	\$2,207		
	30	72	29 1/2	368	44	VSV3072DDF			\$3,518	\$3,883
	30	66	29 1/2	289	41	VST3066DDF	\$2,054	\$2,175		
	30	66	29 1/2	289	41	VSV3066DDF			\$3,456	\$3,816
	30	60	29 1/2	289	37	VST3060DDF	\$1,944	\$2,057		
	30	60	29 1/2	289	37	VSV3060DDF			\$3,330	\$3,674

- top edge profile on user and approach sides
- top grommet available, specify location, and add \$51 list each
- chassis grommets available, specify and add \$97 list
- letter width pedestals
- locking available, specify and add \$160 list
- full width modesty panel
- 3 3/4" overhang on approach side
- VST3072DDF or VSV3072DDF chassis - 26 1/4" x 72"
- VST3066DDF or VSV3066DDF chassis - 26 1/4" x 66"
- VST3060DDF or VSV3060DDF chassis - 26 1/4" x 60"
- VST3072DDF or VSV3072DDF kneespace - 40 5/8"
- VST3066DDF or VSV3066DDF kneespace - 34 5/8"
- VST3060DDF or VSV3060DDF kneespace - 28 5/8"

To Order, Specify:

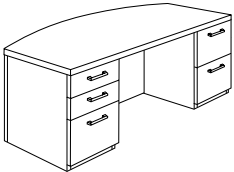
① Model Number	Laminate - VST	Veneer - VSV	
	② Worksurface Material (see page VI3) a.) TFL b.) HPL	② Wood Species - Cherry (CH1), Maple (MA1) Walnut (WA1), Black Oak (BO1) or Double Cut (DC1) (see page VI1)	④ Edge Profile (see page VI4) ⑤ Pull Style and Color (see page VI5) ⑥ Optional Grommet Location & Color - Matte Black (MBK) or Arctic Silver (ASL) (see page VI6)
	③ Laminate Color (see page VI3) a.) Worksurface Color b.) Chassis Color c.) Drawer Color	③ Finish Color (see page VI1)	⑦ Other Product Options (see page VI10) ⑧ Accessories (see page VS314) ⑨ Power and Data Options (see page VS324)

Description	D	W	H	CTN WT	CU FT	① Model	TFL Laminate	HPL Laminate	Flat Cut Veneer	Double Cut Veneer
Bow Front Double Pedestal Desk with Break Front Modesty	42	72	29 1/2	435	61	VST4272BD	\$3,350	\$3,533		
	42	72	29 1/2	435	61	VSV4272BD			\$4,964	\$5,472
	36	84	29 1/2	435	61	VST3684BD	\$3,338	\$3,522		
	36	84	29 1/2	435	61	VSV3684BD			\$4,950	\$5,460
	36	72	29 1/2	392	53	VST3672BD	\$2,705	\$2,853		
	36	72	29 1/2	392	53	VSV3672BD			\$4,340	\$4,787



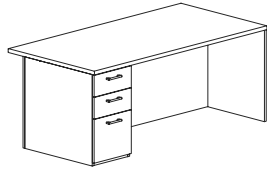
- top edge profile on user and approach sides
- top grommet available, specify location; and add \$51 list each
- chassis grommets available, specify and add \$97 list
- locking available, specify and add \$160 list
- letter width pedestals
- 6" overhang on approach side
- VST4272BD or VSV4272B chassis - 36" x 72"
- VST3684BD or VSV3684BD chassis - 30" x 84"
- VST3672BD or VSV3672BD chassis - 30" x 72"
- VST4272BD & VST3672BD or VSV4272BD & VSV3672BD kneespace - 40 5/8"
- VST3684BD or VSV3684BD kneespace - 52 5/8"
- optional 14" half modesty panel available in place of full modesty, specify half modesty and indicate color on order

Bow Front Double Pedestal Desk with Recessed Modesty	42	72	29 1/2	435	61	VST4272BDF	\$3,246	\$3,426		
	42	72	29 1/2	435	61	VSV4272BDF			\$4,741	\$5,229
	36	84	29 1/2	435	61	VST3684BDF	\$3,231	\$3,416		
	36	84	29 1/2	435	61	VSV3684BDF			\$4,727	\$5,213
	36	72	29 1/2	392	53	VST3672BDF	\$2,600	\$2,749		
	36	72	29 1/2	392	53	VSV3672BDF			\$4,118	\$4,543

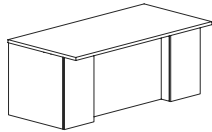


- top edge profile on user and approach sides
- top grommet available, specify location; and add \$51 list each
- chassis grommets available, specify and add \$97 list
- letter width pedestals
- locking available, specify and add \$160 list
- 6" overhang on approach side
- VST4272BDF or VSV4272BDF chassis - 36" x 72"
- VST3684BDF or VSV3684BDF chassis - 30" x 84"
- VST3672BDF or VSV3672BDF chassis - 30" x 72"
- VST4272BDF & VST3672BDF or VSV4272BDF & VSV3672BDF kneespace - 40 5/8"
- VST3684BDF or VSV3684BDF kneespace - 52 5/8"

Description	D	W	H	CTN WT	CU FT	① Model	TFL Laminate	HPL Laminate	Flat Cut Veneer	Double Cut Veneer
36" d Single Pedestal Desk with Break Front Modesty	36	84	29½	325	61	VST3684RD	\$2,675	\$2,818		
	36	84	29½	325	61	VSV3684RD			\$3,634	\$4,004
	36	84	29½	325	61	VST3684LD	\$2,675	\$2,818		
	36	84	29½	325	61	VSV3684LD			\$3,634	\$4,004
	36	72	29½	302	53	VST3672RD	\$1,922	\$2,024		
	36	72	29½	302	53	VSV3672RD			\$3,289	\$3,627
	36	72	29½	302	53	VST3672LD	\$1,922	\$2,024		
	36	72	29½	302	53	VSV3672LD			\$3,289	\$3,627

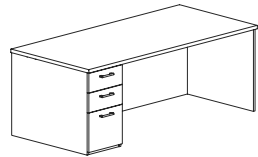


left shown

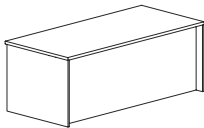


- top edge profile on user and approach sides
- top grommet available, specify location; and add \$51 list each
- chassis grommets available, specify and add \$97 list
- letter width pedestal
- locking available, specify and add \$80 list
- 6" overhang on approach side
- VST3684RD or VST3684LD or VSV3684RD or VSV3684LD chassis - 30" x 84"
- VST3672RD or VST3672LD or VSV3672RD or VSV3672LD chassis - 30" x 72"
- optional 14" half modesty panel available in place of full modesty, specify half modesty and indicate color on order

36" d Single Pedestal Desk with Recessed Modesty	36	84	29½	325	61	VST3684RDF	\$2,568	\$2,713		
	36	84	29½	325	61	VSV3684RDF			\$3,412	\$3,760
	36	84	29½	325	61	VST3684LDF	\$2,568	\$2,713		
	36	84	29½	325	61	VSV3684LDF			\$3,412	\$3,760
	36	72	29½	302	53	VST3672RDF	\$1,816	\$1,920		
	36	72	29½	302	53	VSV3672RDF			\$3,064	\$3,381
	36	72	29½	302	53	VST3672LDF	\$1,816	\$1,920		
	36	72	29½	302	53	VSV3672LDF			\$3,064	\$3,381



left shown



- top edge profile on user and approach sides
- top grommet available, specify location; and add \$51 list each
- chassis grommets available, specify and add \$97 list
- letter width pedestal
- locking available, specify and add \$80 list
- full width modesty panel

To Order, Specify:

① Model Number

Laminate - VST

Veneer - VSV

② Worksurface Material (see page VI3)

a.) TFL

b.) HPL

③ Laminate Color (see page VI3)

a.) Worksurface Color

b.) Chassis Color

c.) Drawer Color

② Wood Species - Cherry (CH1), Maple (MA1)

Walnut (WA1), Black Oak (BO1) or

Double Cut (DC1) (see page VI1)

③ Finish Color (see page VI1)

④ Edge Profile (see page VI4)

⑤ Pull Style and Color (see page VI5)

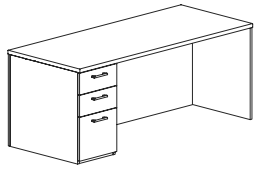
⑥ Optional Grommet Location & Color - Matte Black (MBK) or Arctic Silver (ASL) (see page VI6)

⑦ Other Product Options (see page VI10)

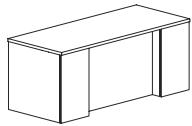
⑧ Accessories (see page VS314)

⑨ Power and Data Options (see page VS324)

Description	D	W	H	CTN WT	CU FT	① Model	TFL Laminate	HPL Laminate	Flat Cut Veneer	Double Cut Veneer
30" d Single Pedestal Desk with Break Front Modesty	30	72	29 1/2	290	44	VST3072RD	\$1,895	\$1,996		
	30	72	29 1/2	290	44	VSV3072RD			\$3,226	\$3,555
	30	72	29 1/2	290	44	VST3072LD	\$1,895	\$1,996		
	30	72	29 1/2	290	44	VSV3072LD			\$3,226	\$3,555
	30	66	29 1/2	262	41	VST3066RD	\$1,815	\$1,911		
	30	66	29 1/2	262	41	VSV3066RD			\$3,044	\$3,355
	30	66	29 1/2	262	41	VST3066LD	\$1,815	\$1,911		
	30	66	29 1/2	262	41	VSV3066LD			\$3,044	\$3,355



left shown

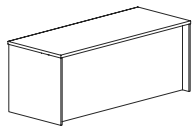


- top edge profile on user and approach sides
- top grommet available, specify location; and add \$51 list each
- chassis grommets available, specify and add \$97 list
- letter width pedestal
- locking available, specify and add \$80 list
- optional 14" half modesty panel available in place of full modesty, specify half modesty and indicate color on order

30" d Single Pedestal Desk with Recessed Modesty	30	72	29 1/2	290	44	VST3072RDF	\$1,787	\$1,890		
	30	72	29 1/2	290	44	VSV3072RDF			\$3,004	\$3,311
	30	72	29 1/2	290	44	VST3072LDF	\$1,787	\$1,890		
	30	72	29 1/2	290	44	VSV3072LDF			\$3,004	\$3,311
	30	66	29 1/2	262	41	VST3066RDF	\$1,708	\$1,808		
	30	66	29 1/2	262	41	VSV3066RDF			\$2,820	\$3,108
	30	66	29 1/2	262	41	VST3066LDF	\$1,708	\$1,808		
	30	66	29 1/2	262	41	VSV3066LDF			\$2,820	\$3,108

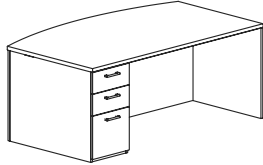


left shown

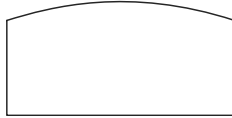


- top edge profile on user and approach sides
- top grommet available, specify location; and add \$51 list each
- chassis grommets available, specify and add \$97 list
- letter width pedestal
- locking available, specify and add \$80 list
- full width modesty panel

Description	D	W	H	CTN WT	CU FT	① Model	TFL Laminate	HPL Laminate	Flat Cut Veneer	Double Cut Veneer
Bow Front Single Pedestal Desk with Break Front Modesty	42	72	29½	365	61	VST4272RBD	\$2,984	\$3,144		
	42	72	29½	365	61	VSV4272RBD			\$4,363	\$4,805
	42	72	29½	365	61	VST4272LBD	\$2,984	\$3,144		
	42	72	29½	365	61	VSV4272LBD			\$4,363	\$4,805
	36	84	29½	365	61	VST3684RBD	\$2,829	\$2,983		
	36	84	29½	365	61	VSV3684RBD			\$4,343	\$4,785
	36	84	29½	365	61	VST3684LBD	\$2,829	\$2,983		
	36	84	29½	365	61	VSV3684LBD			\$4,343	\$4,785
	36	72	29½	351	53	VST3672RBD	\$2,421	\$2,553		
	36	72	29½	351	53	VSV3672RBD			\$3,778	\$4,165
	36	72	29½	351	53	VST3672LBD	\$2,421	\$2,553		
	36	72	29½	351	53	VSV3672LBD			\$3,778	\$4,165



left shown



- top edge profile on user and approach sides
- top grommet available, specify location; and add \$51 list each
- chassis grommets available, specify and add \$97 list
- letter width pedestals
- locking available, specify and add \$80 list
- 6" overhang on approach side
- VST4272RBD & VST4272LBD or VSV4272RBD & VSV4272LBD chassis - 36" x 72"
- VST3684RBD & VST3684LBD or VSV3684RBD & VSV3684LBD chassis - 30" x 84"
- VST3672RBD & VST3672LBD or VSV3672RBD & VSV3672LBD chassis - 30" x 72"
- optional 14" half modesty panel available in place of full modesty, specify half modesty and indicate color on order

To Order, Specify:

① Model Number	Laminate - VST	Veneer - VSV	
	<p>② Worksurface Material (see page VI3)</p> <p>a.) TFL</p> <p>b.) HPL</p>	<p>② Wood Species - Cherry (CH1), Maple (MA1)</p> <p>Walnut (WA1), Black Oak (BO1) or</p> <p>Double Cut (DC1) (see page VI1)</p>	<p>④ Edge Profile (see page VI4)</p> <p>⑤ Pull Style and Color (see page VI5)</p> <p>⑥ Optional Grommet Location & Color -</p> <p>Matte Black (MBK) or Arctic Silver (ASL)</p> <p>(see page VI6)</p> <p>⑦ Other Product Options (see page VI10)</p> <p>⑧ Accessories (see page VS314)</p> <p>⑨ Power and Data Options (see page VS324)</p>
	<p>③ Laminate Color (see page VI3)</p> <p>a.) Worksurface Color</p> <p>b.) Chassis Color</p> <p>c.) Drawer Color</p>	<p>③ Finish Color (see page VI1)</p>	

Description	D	W	H	CTN WT	CU FT	① Model	TFL Laminate	HPL Laminate	Flat Cut Veneer	Double Cut Veneer
Bow Front Single Pedestal Desk with Recessed Modesty	42	72	29 ½	365	61	VST4272RBDF	\$2,878	\$3,038		
	42	72	29 ½	365	61	VSV4272RBDF			\$4,139	\$4,560
	42	72	29 ½	365	61	VST4272LBDF	\$2,878	\$3,038		
	42	72	29 ½	365	61	VSV4272LBDF			\$4,139	\$4,560
	36	84	29 ½	365	61	VST3684RBDF	\$2,725	\$2,877		
	36	84	29 ½	365	61	VSV3684RBDF			\$4,120	\$4,539
	36	84	29 ½	365	61	VST3684LBDF	\$2,725	\$2,877		
	36	84	29 ½	365	61	VSV3684LBDF			\$4,120	\$4,539
	36	72	29 ½	351	53	VST3672RBDF	\$2,315	\$2,447		
	36	72	29 ½	351	53	VSV3672RBDF			\$3,554	\$3,917
	36	72	29 ½	351	53	VST3672LBDF	\$2,315	\$2,447		
	36	72	29 ½	351	53	VSV3672LBDF			\$3,554	\$3,917

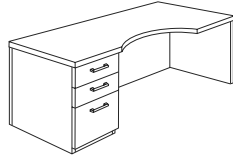


left shown



- top edge profile on user and approach sides
- top grommet available, specify location; and add \$51 list each
- chassis grommets available, specify and add \$97 list
- letter width pedestals
- locking available, specify and add \$80 list
- full width modesty panel
- 6" overhang on approach side
- VST4272RBDF & VST4272LBDF or VSV4272RBDF & VSV4272LBDF chassis - 36" x 72"
- VST3684RBDF & VST3684LBDF or VSV3684RBDF & VSV3684LBDF chassis - 30" x 84"
- VST3672RBDF & VST3672LBDF or VSV3672RBDF & VSV3672LBDF chassis - 30" x 72"

Description	D	W	H	CTN WT	CU FT	① Model	TFL Laminate	HPL Laminate	Flat Cut Veneer	Double Cut Veneer
Cockpit Single Pedestal Desk with Break Front Modesty	42	72	29½	308	61	VST4272CRD	\$2,682	\$2,826		
	42	72	29½	308	61	VSV4272CRD			\$3,848	\$4,239
	42	72	29½	308	61	VST4272CLD	\$2,682	\$2,826		
	42	72	29½	308	61	VSV4272CLD			\$3,848	\$4,239



left shown

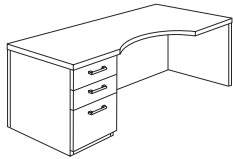


left

right

- cockpit style wrap around top
- top edge profile on user and approach sides
- top grommet available, specify location; and add \$51 list each
- chassis grommets available, specify and add \$97 list
- letter width pedestal
- locking available, specify and add \$80 list
- optional 14" half modesty panel available in place of full modesty, specify half modesty and indicate color on order

Cockpit Single Pedestal Desk with Recessed Modesty	42	72	29½	308	63	VST4272CRDF	\$2,576	\$2,719		
	42	72	29½	308	63	VSV4272CRDF			\$3,625	\$3,994
	42	72	29½	308	63	VST4272CLDF	\$2,576	\$2,719		
	42	72	29½	308	63	VSV4272CLDF			\$3,625	\$3,994



left shown



left

right

- cockpit style wrap around top
- top edge profile on user and approach sides
- top grommet available, specify location; and add \$51 list each
- chassis grommets available, specify and add \$97 list
- letter width pedestal
- locking available, specify and add \$80 list
- full width modesty panel

To Order, Specify:

① Model Number

Laminate - VST

Veneer - VSV

② Worksurface Material (see page VI3)

a.) TFL

b.) HPL

③ Laminate Color (see page VI3)

a.) Worksurface Color

b.) Chassis Color

c.) Drawer Color

② Wood Species - Cherry (CH1), Maple (MA1)

Walnut (WA1), Black Oak (BO1) or

Double Cut (DC1) (see page VI1)

③ Finish Color (see page VI1)

④ Edge Profile (see page VI4)

⑤ Pull Style and Color (see page VI5)

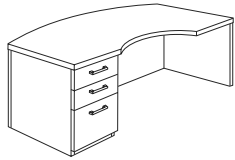
⑥ Optional Grommet Location & Color -
Matte Black (MBK) or Arctic Silver (ASL)
(see page VI6)

⑦ Other Product Options (see page VI10)

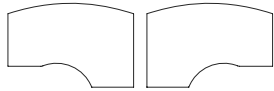
⑧ Accessories (see page VS314)

⑨ Power and Data Options (see page VS324)

Description	D	W	H	CTN WT	CU FT	① Model	TFL Laminate	HPL Laminate	Flat Cut Veneer	Double Cut Veneer
Bow Front Cockpit Single Pedestal Desk with Break Front Modesty	48	72	29 ½	312	66	VST4872CBDR	\$2,808	\$2,958		
	48	72	29 ½	312	66	VSV4872CBDR			\$3,956	\$4,360
	48	72	29 ½	312	66	VST4872CBDL	\$2,808	\$2,958		
	48	72	29 ½	312	66	VSV4872CBDL			\$3,956	\$4,360



left shown

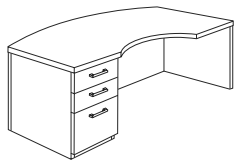


left

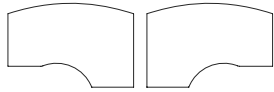
right

- cockpit style wrap around top
- top edge profile on user and approach sides
- top grommet available, specify location; and add \$51 list each
- chassis grommets available, specify and add \$97 list
- letter width pedestal
- locking available, specify and add \$80 list
- 6" overhang on approach side
- chassis - 42" x 72"
- optional 14" half modesty panel available in place of full modesty, specify half modesty and indicate color on order

Bow Front Cockpit Single Pedestal Desk with Recessed Modesty	48	72	29 ½	312	66	VST4872CBDRF	\$2,702	\$2,850		
	48	72	29 ½	312	66	VSV4872CBDRF			\$3,734	\$4,112
	48	72	29 ½	312	66	VST4872CBDLF	\$2,702	\$2,850		
	48	72	29 ½	312	66	VSV4872CBDLF			\$3,734	\$4,112



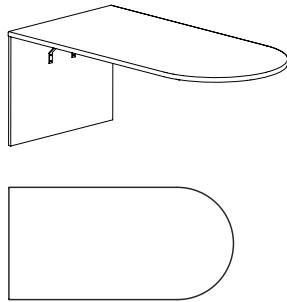
left shown



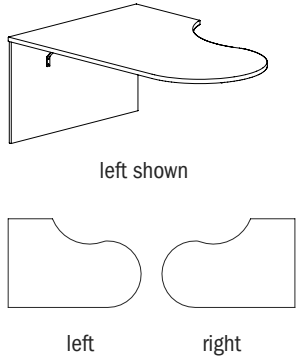
left

right

- cockpit style wrap around top
- top edge profile on user and approach sides
- top grommet available, specify location; and add \$51 list each
- chassis grommets available, specify and add \$97 list
- letter width pedestal
- locking available, specify and add \$80 list
- full width modesty panel
- 6" overhang on approach side
- chassis - 42" x 72"

Description	D	W	H	CTN WT	CU FT	① Model	TFL Laminate	HPL Laminate	Flat Cut Veneer	Double Cut Veneer
	30	84	29½	175	61	VST3684B	\$2,030	\$2,136		
	36	84	29½	175	61	VSV3684B			\$3,506	\$3,860
	36	78	29½	169	57	VST3678B	\$1,976	\$2,078		
	36	78	29½	169	57	VSV3678B			\$3,416	\$3,756
	36	72	29½	163	53	VST3672B	\$1,680	\$1,770		
	36	72	29½	163	53	VSV3672B			\$2,903	\$3,193
	30	84	29½	168	51	VST3084B	\$1,899	\$2,000		
	30	84	29½	168	51	VSV3084B			\$3,284	\$3,613
	30	78	29½	163	48	VST3078B	\$1,840	\$1,937		
	30	78	29½	163	48	VSV3078B			\$3,181	\$3,499
	30	72	29½	158	44	VST3072B	\$1,618	\$1,703		
	30	72	29½	158	44	VSV3072B			\$2,797	\$3,078
	30	66	29½	152	41	VST3066B	\$1,483	\$1,558		
	30	66	29½	152	41	VSV3066B			\$2,559	\$2,815

- top edge profile on three open sides
 - top grommet available, specify location, and add \$51 list each
 - chassis grommet available, specify and add \$49 list
 - non-handed
 - not recommended for freestanding use
 - bases must be purchased separately; see pages VS161-VS162 for options
- Note: truss base not compatible with models wider than 72"

	Cockpit Bullet Peninsula Desk	48	72	29½	175	66	VST4872CBR	\$2,002	\$2,107		
		48	72	29½	175	66	VSV4872CBR			\$3,460	\$3,806
		48	72	29½	175	66	VST4872CBL	\$2,002	\$2,107		
		48	72	29½	175	66	VSV4872CBL			\$3,460	\$3,806

- cockpit style wrap around top
- edge profile on three open sides
- top grommet available, specify location, and add \$51 list each
- chassis grommets available, specify and add \$97 list
- not recommended for freestanding use
- bases must be purchased separately; see pages VS161-VS162 for options

To Order, Specify:

① Model Number

Laminate - VST

Veneer - VSV

② Worksurface Material (see page VI3)

a.) TFL

b.) HPL

③ Laminate Color (see page VI3)

a.) Worksurface Color

b.) Chassis Color

c.) Drawer Color

② Wood Species - Cherry (CH1), Maple (MA1)

Walnut (WA1), Black Oak (BO1) or

Double Cut (DC1) (see page VI1)

③ Finish Color (see page VI1)

④ Edge Profile (see page VI4)

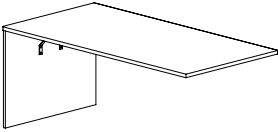
⑤ Pull Style and Color (see page VI5)

⑥ Optional Grommet Location & Color - Matte Black (MBK) or Arctic Silver (ASL) (see page VI6)

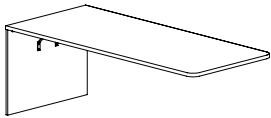
⑦ Other Product Options (see page VI10)

⑧ Accessories (see page VS314)

⑨ Power and Data Options (see page VS324)

Description	D	W	H	CTN WT	CU FT	① Model	TFL Laminate	HPL Laminate	Flat Cut Veneer	Double Cut Veneer
Rectangular Peninsula Desk 	36	84	29 ½	176	61	VST3684RCT	\$1,538	\$1,617		
	36	84	29 ½	176	61	VSV3684RCT			\$2,567	\$2,822
	36	78	29 ½	170	57	VST3678RCT	\$1,460	\$1,537		
	36	78	29 ½	170	57	VSV3678RCT			\$2,438	\$2,681
	36	72	29 ½	164	53	VST3672RCT	\$1,396	\$1,468		
	36	72	29 ½	164	53	VSV3672RCT			\$2,335	\$2,568
	30	84	29 ½	169	51	VST3084RCT	\$1,461	\$1,538		
	30	84	29 ½	169	51	VSV3084RCT			\$2,439	\$2,682
	30	78	29 ½	164	48	VST3078RCT	\$1,411	\$1,485		
	30	78	29 ½	164	48	VSV3078RCT			\$2,355	\$2,592
	30	72	29 ½	159	44	VST3072RCT	\$1,374	\$1,445		
	30	72	29 ½	159	44	VSV3072RCT			\$2,290	\$2,522

- edge profile on three open sides
 - top grommet available, specify location, and add \$51 list each
 - chassis grommets available, specify and add \$97 list
 - non-handed
 - not recommended for freestanding use
 - bases must be purchased separately; see pages VS161-VS162 for options
- Note: truss base not compatible with models wider than 72"

Description	D	W	H	CTN WT	CU FT	① Model	TFL Laminate	HPL Laminate	Flat Cut Veneer	Double Cut Veneer
Soft Rectangular Peninsula Desk 	36	84	29½	143	60	VST3684RRD	\$1,366	\$1,497		
	36	84	29½	143	60	VSV3684RRD			\$2,612	\$2,875
	36	78	29½	134	56	VST3678RRD	\$1,289	\$1,409		
	36	78	29½	134	56	VSV3678RRD			\$2,470	\$2,717
	36	72	29½	126	52	VST3672RRD	\$1,203	\$1,314		
	36	72	29½	126	52	VSV3672RRD			\$2,318	\$2,550
	36	66	29½	118	48	VST3666RRD	\$1,126	\$1,228		
	36	66	29½	118	48	VSV3666RRD			\$2,178	\$2,395
	36	60	29½	109	43	VST3660RRD	\$1,059	\$1,152		
	36	60	29½	109	43	VSV3660RRD			\$2,045	\$2,250
	30	84	29½	120	51	VST3084RRD	\$1,198	\$1,306		
	30	84	29½	120	51	VSV3084RRD			\$2,288	\$2,517
	30	78	29½	113	47	VST3078RRD	\$1,130	\$1,233		
	30	78	29½	113	47	VSV3078RRD			\$2,165	\$2,383
	30	72	29½	106	44	VST3072RRD	\$1,055	\$1,148		
	30	72	29½	106	44	VSV3072RRD			\$2,036	\$2,241
	30	66	29½	99	40	VST3066RRD	\$991	\$1,077		
	30	66	29½	99	40	VSV3066RRD			\$1,918	\$2,110
	30	60	29½	92	37	VST3060RRD	\$935	\$1,013		
	30	60	29½	92	37	VSV3060RRD			\$1,809	\$1,990

- edge profile on three open sides
 - top grommet available, specify location, and add \$51 list each
 - chassis grommets available, specify and add \$97 list
 - non-handed
 - not recommended for freestanding use
 - bases must be purchased separately; see pages VS161-VS162 for options
- Note: truss base not compatible with models wider than 72"

To Order, Specify:

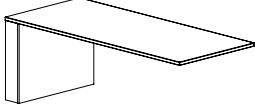
① Model Number	Laminate - VST	Veneer - VSV	
	<p>② Worksurface Material (see page VI3)</p> <p>a.) TFL</p> <p>b.) HPL</p>	<p>② Wood Species - Cherry (CH1), Maple (MA1)</p> <p>Walnut (WA1), Black Oak (BO1) or</p> <p>Double Cut (DC1) (see page VI1)</p>	<p>④ Edge Profile (see page VI4)</p> <p>⑤ Pull Style and Color (see page VI5)</p>
	<p>③ Laminate Color (see page VI3)</p> <p>a.) Worksurface Color</p> <p>b.) Chassis Color</p> <p>c.) Drawer Color</p>	<p>③ Finish Color (see page VI1)</p>	<p>⑥ Optional Grommet Location & Color - Matte Black (MBK) or Arctic Silver (ASL) (see page VI6)</p> <p>⑦ Other Product Options (see page VI10)</p> <p>⑧ Accessories (see page VS314)</p> <p>⑨ Power and Data Options (see page VS324)</p>

Description	D	W	H	CTN WT	CU FT	① Model	TFL Laminate	HPL Laminate	Flat Cut Veneer	Double Cut Veneer
<p>left shown</p> <p>left right</p>	42	84	29 ½	190	71	VST4284RP	\$2,140	\$2,251		
	42	84	29 ½	190	71	VSV4284RP			\$3,698	\$4,067
	42	84	29 ½	190	71	VST4284LP	\$2,140	\$2,251		
	42	84	29 ½	190	71	VSV4284LP			\$3,698	\$4,067
	42	78	29 ½	184	66	VST4278RP	\$2,066	\$2,175		
	42	78	29 ½	184	66	VSV4278RP			\$3,570	\$3,927
	42	78	29 ½	184	66	VST4278LP	\$2,066	\$2,175		
	42	78	29 ½	184	66	VSV4278LP			\$3,570	\$3,927
	42	72	29 ½	175	61	VST4272RP	\$1,944	\$2,046		
	42	72	29 ½	175	61	VSV4272RP			\$3,361	\$3,700
	42	72	29 ½	175	61	VST4272LP	\$1,944	\$2,046		
	42	72	29 ½	175	61	VSV4272LP			\$3,361	\$3,700

- 42" at widest point
 - 30" at end panel
 - edge profile on three open sides
 - top grommet available, specify location, and add \$51 list each
 - chassis grommets available, specify and add \$97 list
 - not recommended for freestanding use
 - bases must be purchased separately; see pages VS161-VS162 for options
- Note: truss base not compatible with P-Top Peninsula Desk

Description	D	W	H	CTN WT	CU FT	① Model	TFL Laminate	HPL Laminate	Flat Cut Veneer	Double Cut Veneer
<p>right shown</p>	60	84	29 ½	166	98	VST6084SWPR	\$2,121	\$2,340		
	60	84	29 ½	166	98	VSV6084SWPR			\$4,089	\$4,498
	60	84	29 ½	166	98	VST6084SWPL	\$2,121	\$2,340		
	60	84	29 ½	166	98	VSV6084SWPL			\$4,089	\$4,498
	60	78	29 ½	159	91	VST6078SWPR	\$2,000	\$2,201		
	60	78	29 ½	159	91	VSV6078SWPR			\$3,858	\$4,244
	60	78	29 ½	159	91	VST6078SWPL	\$2,000	\$2,201		
	60	78	29 ½	159	91	VSV6078SWPL			\$3,858	\$4,244
	60	72	29 ½	152	84	VST6072SWPR	\$1,869	\$2,055		
	60	72	29 ½	152	84	VSV6072SWPR			\$3,619	\$3,981
	60	72	29 ½	152	84	VST6072SWPL	\$1,869	\$2,055		
	60	72	29 ½	152	84	VSV6072SWPL			\$3,619	\$3,981
	60	66	29 ½	145	77	VST6066SWPR	\$1,748	\$1,919		
	60	66	29 ½	145	77	VSV6066SWPR			\$3,391	\$3,729
	60	66	29 ½	145	77	VST6066SWPL	\$1,748	\$1,919		
	60	66	29 ½	145	77	VSV6066SWPL			\$3,391	\$3,729
	60	60	29 ½	138	71	VST6060SWPR	\$1,636	\$1,792		
	60	60	29 ½	138	71	VSV6060SWPR			\$3,170	\$3,487
60	60	29 ½	138	71	VST6060SWPL	\$1,636	\$1,792			
60	60	29 ½	138	71	VSV6060SWPL			\$3,170	\$3,487	

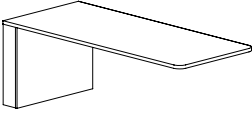
- edge profile on three open sides
 - top grommet available, specify location, and add \$51 list each
 - chassis grommets available, specify and add \$97 list
 - bases must be purchased separately; see pages VS161-VS162 for options
- Note: truss base not compatible with models wider than 72"

Description	D	W	H	CTN WT	CU FT	① Model	TFL Laminate	HPL Laminate	Flat Cut Veneer	Double Cut Veneer
Rectangular Workwall Peninsula Desk 	36	84	29½	143	19	VST3684WPRCT	\$1,283	\$1,413		
	36	84	29½	143	19	VSV3684WPRCT			\$2,576	\$2,833
	36	78	29½	134	18	VST3678WPRCT	\$1,206	\$1,325		
	36	78	29½	134	18	VSV3678WPRCT			\$2,433	\$2,676
	36	72	29½	126	17	VST3672WPRCT	\$1,120	\$1,229		
	36	72	29½	126	17	VSV3672WPRCT			\$2,281	\$2,512
	36	66	29½	118	15	VST3666WPRCT	\$1,042	\$1,145		
	36	66	29½	118	15	VSV3666WPRCT			\$2,141	\$2,357
	36	60	29½	109	14	VST3660WPRCT	\$975	\$1,068		
	36	60	29½	109	14	VSV3660WPRCT			\$2,008	\$2,212
	30	84	29½	120	16	VST3084WPRCT	\$1,114	\$1,222		
	30	84	29½	120	16	VSV3084WPRCT			\$2,251	\$2,476
	30	78	29½	113	15	VST3078WPRCT	\$1,047	\$1,148		
	30	78	29½	113	15	VSV3078WPRCT			\$2,129	\$2,343
	30	72	29½	106	14	VST3072WPRCT	\$972	\$1,064		
	30	72	29½	106	14	VSV3072WPRCT			\$2,001	\$2,202
	30	66	29½	99	13	VST3066WPRCT	\$907	\$993		
	30	66	29½	99	13	VSV3066WPRCT			\$1,881	\$2,072
	30	60	29½	92	12	VST3060WPRCT	\$851	\$929		
	30	60	29½	92	12	VSV3060WPRCT			\$1,772	\$1,953


- edge profile on three open sides
 - top grommet available, specify location, and add \$51 list each
 - not recommended for freestanding use
 - bases must be purchased separately; see pages VS161-VS162 for options
- Note: truss base not compatible with models wider than 72"

To Order, Specify:

① Model Number	Laminate - VST	Veneer - VSV	
	② Worksurface Material (see page VI3) a.) TFL b.) HPL	② Wood Species - Cherry (CH1), Maple (MA1) Walnut (WA1), Black Oak (BO1) or Double Cut (DC1) (see page VI1)	④ Edge Profile (see page VI4) ⑤ Pull Style and Color (see page VI5) ⑥ Optional Grommet Location & Color - Matte Black (MBK) or Arctic Silver (ASL) (see page VI6)
	③ Laminate Color (see page VI3) a.) Worksurface Color b.) Chassis Color c.) Drawer Color	③ Finish Color (see page VI1)	⑦ Other Product Options (see page VI10) ⑧ Accessories (see page VS314) ⑨ Power and Data Options (see page VS324)

Description	D	W	H	CTN WT	CU FT	① Model	TFL Laminate	HPL Laminate	Flat Cut Veneer	Double Cut Veneer
Soft Rectangular Workwall Peninsula Desk 	36	84	29 1/2	143	19	VST3684WPRRD	\$1,461	\$1,592		
	36	84	29 1/2	143	19	VSV3684WPRRD			\$2,754	\$3,010
	36	78	29 1/2	134	18	VST3678WPRRD	\$1,383	\$1,504		
	36	78	29 1/2	134	18	VSV3678WPRRD			\$2,611	\$2,854
	36	72	29 1/2	126	17	VST3672WPRRD	\$1,297	\$1,408		
	36	72	29 1/2	126	17	VSV3672WPRRD			\$2,458	\$2,689
	36	66	29 1/2	118	15	VST3666WPRRD	\$1,220	\$1,323		
	36	66	29 1/2	118	15	VSV3666WPRRD			\$2,319	\$2,536
	36	60	29 1/2	109	14	VST3660WPRRD	\$1,153	\$1,247		
	36	60	29 1/2	109	14	VSV3660WPRRD			\$2,187	\$2,390
	30	84	29 1/2	120	16	VST3084WPRRD	\$1,293	\$1,401		
	30	84	29 1/2	120	16	VSV3084WPRRD			\$2,430	\$2,653
	30	78	29 1/2	113	15	VST3078WPRRD	\$1,225	\$1,326		
	30	78	29 1/2	113	15	VSV3078WPRRD			\$2,307	\$2,520
	30	72	29 1/2	106	14	VST3072WPRRD	\$1,150	\$1,242		
	30	72	29 1/2	106	14	VSV3072WPRRD			\$2,179	\$2,380
	30	66	29 1/2	99	13	VST3066WPRRD	\$1,085	\$1,171		
	30	66	29 1/2	99	13	VSV3066WPRRD			\$2,060	\$2,250
	30	60	29 1/2	92	12	VST3060WPRRD	\$1,029	\$1,107		
	30	60	29 1/2	92	12	VSV3060WPRRD			\$1,949	\$2,130

- edge profile on three open sides
 - top grommet available, specify location, and add \$51 list each
 - not recommended for freestanding use
 - bases must be purchased separately; see pages VS161-VS162 for options
- Note: truss base not compatible with models wider than 72"

Description	D	W	H	CTN WT	CU FT	① Model	TFL Laminate	HPL Laminate	Flat Cut Veneer	Double Cut Veneer
Rectangular Run-Off Desk Top 	36	72	1 3/16	101	7	VST3672SR0D	\$855	\$1,142		
	36	72	1 3/16	101	7	VSV3672SR0D			\$1,780	\$1,958
	36	66	1 3/16	93	6	VST3666SR0D	\$816	\$1,028		
	36	66	1 3/16	93	6	VSV3666SR0D			\$1,649	\$1,815
	36	60	1 3/16	86	6	VST3660SR0D	\$777	\$952		
	36	60	1 3/16	86	6	VSV3660SR0D			\$1,526	\$1,679
	36	54	1 3/16	79	5	VST3654SR0D	\$731	\$894		
	36	54	1 3/16	79	5	VSV3654SR0D			\$1,409	\$1,550
	36	48	1 3/16	72	5	VST3648SR0D	\$686	\$841		
	36	48	1 3/16	72	5	VSV3648SR0D			\$1,301	\$1,432
	30	72	1 3/16	88	6	VST3072SR0D	\$786	\$1,012		
	30	72	1 3/16	88	6	VSV3072SR0D			\$1,582	\$1,742
	30	66	1 3/16	81	6	VST3066SR0D	\$735	\$910		
	30	66	1 3/16	81	6	VSV3066SR0D			\$1,468	\$1,616
	30	60	1 3/16	74	5	VST3060SR0D	\$692	\$832		
	30	60	1 3/16	74	5	VSV3060SR0D			\$1,352	\$1,488
	30	54	1 3/16	68	5	VST3054SR0D	\$647	\$776		
	30	54	1 3/16	68	5	VSV3054SR0D			\$1,250	\$1,375
	30	48	1 3/16	62	4	VST3048SR0D	\$601	\$722		
	30	48	1 3/16	62	4	VSV3048SR0D			\$1,152	\$1,268

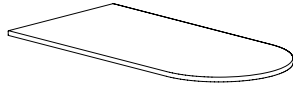
- edge profile on three open sides
- top grommet available, specify location, and add \$51 list each
- not recommended for freestanding use
- bases must be purchased separately; see pages VS161-VS162 for options

To Order, Specify:

① Model Number	Laminate - VST	Veneer - VSV	
	② Worksurface Material (see page VI3) a.) TFL b.) HPL	② Wood Species - Cherry (CH1), Maple (MA1) Walnut (WA1), Black Oak (BO1) or Double Cut (DC1) (see page VI1)	④ Edge Profile (see page VI4) ⑤ Pull Style and Color (see page VI5) ⑥ Optional Grommet Location & Color - Matte Black (MBK) or Arctic Silver (ASL) (see page VI6)
	③ Laminate Color (see page VI3) a.) Worksurface Color b.) Chassis Color c.) Drawer Color	③ Finish Color (see page VI1)	⑦ Other Product Options (see page VI10) ⑧ Accessories (see page VS314) ⑨ Power and Data Options (see page VS324)

Description	D	W	H	CTN WT	CU FT	① Model	TFL Laminate	HPL Laminate	Flat Cut Veneer	Double Cut Veneer
Soft Rectangular Run-off Desk Top 	36	72	1 3/16	101	7	VST3672RR0D	\$1,004	\$1,115		
	36	72	1 3/16	101	7	VSV3672RR0D			\$1,784	\$1,943
	36	66	1 3/16	93	6	VST3666RR0D	\$918	\$1,021		
	36	66	1 3/16	93	6	VSV3666RR0D			\$1,634	\$1,780
	36	60	1 3/16	86	6	VST3660RR0D	\$842	\$935		
	36	60	1 3/16	86	6	VSV3660RR0D			\$1,493	\$1,624
	36	54	1 3/16	79	5	VST3654RR0D	\$786	\$858		
	36	54	1 3/16	79	5	VSV3654RR0D			\$1,381	\$1,519
	36	48	1 3/16	72	5	VST3648RR0D	\$736	\$789		
	36	48	1 3/16	72	5	VSV3648RR0D			\$1,276	\$1,405
	30	72	1 3/16	88	6	VST3072RR0D	\$871	\$963		
	30	72	1 3/16	88	6	VSV3072RR0D			\$1,521	\$1,654
	30	66	1 3/16	81	6	VST3066RR0D	\$797	\$883		
	30	66	1 3/16	81	6	VSV3066RR0D			\$1,392	\$1,513
	30	60	1 3/16	74	5	VST3060RR0D	\$731	\$809		
	30	60	1 3/16	74	5	VSV3060RR0D			\$1,274	\$1,384
	30	54	1 3/16	68	5	VST3054RR0D	\$675	\$732		
	30	54	1 3/16	68	5	VSV3054RR0D			\$1,166	\$1,283
	30	48	1 3/16	62	4	VST3048RR0D	\$626	\$663		
	30	48	1 3/16	62	4	VSV3048RR0D			\$1,070	\$1,176

- edge profile on three open sides
- top grommet available, specify location, and add \$51 list each
- not recommended for freestanding use
- bases must be purchased separately; see pages VS161-VS162 for options

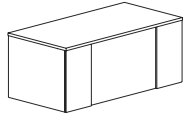
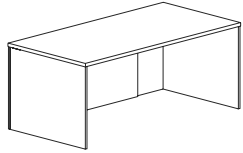
Description	D	W	H	CTN WT	CU FT	① Model	TFL Laminate	HPL Laminate	Flat Cut Veneer	Double Cut Veneer
Bullet Run-Off Desk 	36	72	1 3/16	94	7	VST3672BROD	\$1,004	\$1,115		
	36	72	1 3/16	94	7	VSV3672BROD			\$1,784	\$1,943
	36	66	1 3/16	86	6	VST3666BROD	\$918	\$1,021		
	36	66	1 3/16	86	6	VSV3666BROD			\$1,634	\$1,780
	36	60	1 3/16	79	6	VST3660BROD	\$842	\$935		
	36	60	1 3/16	79	6	VSV3660BROD			\$1,493	\$1,624
	36	54	1 3/16	72	5	VST3654BROD	\$786	\$858		
	36	54	1 3/16	72	5	VSV3654BROD			\$1,381	\$1,519
	36	48	1 3/16	65	5	VST3648BROD	\$736	\$789		
	36	48	1 3/16	65	5	VSV3648BROD			\$1,276	\$1,405
	30	72	1 3/16	82	6	VST3072BROD	\$871	\$963		
	30	72	1 3/16	82	6	VSV3072BROD			\$1,521	\$1,654
	30	66	1 3/16	75	6	VST3066BROD	\$797	\$883		
	30	66	1 3/16	75	6	VSV3066BROD			\$1,392	\$1,513
	30	60	1 3/16	68	5	VST3060BROD	\$731	\$809		
	30	60	1 3/16	68	5	VSV3060BROD			\$1,274	\$1,384
	30	54	1 3/16	62	5	VST3054BROD	\$675	\$732		
	30	54	1 3/16	62	5	VSV3054BROD			\$1,166	\$1,283
	30	48	1 3/16	56	4	VST3048BROD	\$626	\$663		
	30	48	1 3/16	56	4	VSV3048BROD			\$1,070	\$1,176

- edge profile on three open sides
 - top grommet available, specify location, and add \$51 list each
 - not recommended for freestanding use
 - bases must be purchased separately; see pages VS161-VS162 for options
- Note: truss base not compatible with models wider than 72"

To Order, Specify:

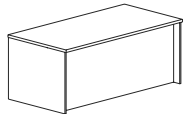
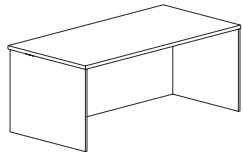
① Model Number	Laminate - VST	Veneer - VSV	
	<ul style="list-style-type: none"> ② Worksurface Material (see page VI3) <ul style="list-style-type: none"> a.) TFL b.) HPL ③ Laminate Color (see page VI3) <ul style="list-style-type: none"> a.) Worksurface Color b.) Chassis Color c.) Drawer Color 	<ul style="list-style-type: none"> ② Wood Species - Cherry (CH1), Maple (MA1) Walnut (WA1), Black Oak (BO1) or Double Cut (DC1) (see page VI1) ③ Finish Color (see page VI1) 	<ul style="list-style-type: none"> ④ Edge Profile (see page VI4) ⑤ Pull Style and Color (see page VI5) ⑥ Optional Grommet Location & Color - Matte Black (MBK) or Arctic Silver (ASL) (see page VI6) ⑦ Other Product Options (see page VI10) ⑧ Accessories (see page VS314) ⑨ Power and Data Options (see page VS324)

Description	D	W	H	CTN WT	CU FT	① Model	TFL Laminate	HPL Laminate	Flat Cut Veneer	Double Cut Veneer
Shell Desk with Break Front Modesty	36	72	29 ½	205	53	VST3672SHD	\$1,829	\$1,922		
	36	72	29 ½	205	53	VSV3672SHD			\$2,519	\$2,773
	30	72	29 ½	192	44	VST3072SHD	\$1,726	\$1,813		
	30	72	29 ½	192	44	VSV3072SHD			\$2,457	\$2,706
	30	66	29 ½	179	41	VST3066SHD	\$1,626	\$1,709		
	30	66	29 ½	179	41	VSV3066SHD			\$2,369	\$2,604
	30	60	29 ½	168	41	VST3060SHD	\$1,582	\$1,663		
	30	60	29 ½	168	41	VSV3060SHD			\$2,336	\$2,569



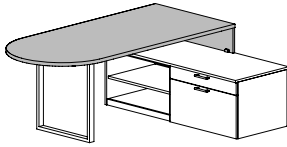
- top edge profile on user and approach sides
- top grommet available, specify location, and add \$51 list each
- chassis grommet available, specify and add \$49 list
- modular pedestals available; see page VS126
- use 30"d pedestals with 36"d shell, use 24"d pedestals with 30"d shells
- adding modular pedestals could block grommets

Shell Desk with Recessed Modesty	36	72	29 ½	205	53	VST3672SHDF	\$1,721	\$1,818		
	36	72	29 ½	205	53	VSV3672SHDF			\$2,293	\$2,526
	30	72	29 ½	192	44	VST3072SHDF	\$1,618	\$1,707		
	30	72	29 ½	192	44	VSV3072SHDF			\$2,235	\$2,457
	30	66	29 ½	179	41	VST3066SHDF	\$1,519	\$1,604		
	30	66	29 ½	179	41	VSV3066SHDF			\$2,144	\$2,361
	30	60	29 ½	168	41	VST3060SHDF	\$1,474	\$1,557		
	30	60	29 ½	168	41	VSV3060SHDF			\$2,112	\$2,323



- top edge profile on user and approach sides
- top grommet available, specify location, and add \$51 list each
- chassis grommet available, specify and add \$49 list
- full width modesty panel
- modular pedestals available; see page VS126
- use 30"d pedestals with 36"d shell, use 24"d pedestals with 30"d shells
- adding modular pedestals could block grommets

Description	D	W	H	CTN WT	CU FT	① Model	TFL Laminate	HPL Laminate	Flat Cut Veneer	Double Cut Veneer
Bench Height Supported Bullet Peninsula Desk	36	84	9 1/16	170	22	VSTB3684B	\$1,916	\$2,016		
	36	84	9 1/16	170	22	VSVB3684B			\$3,309	\$3,639
	36	78	9 1/16	164	21	VSTB3678B	\$1,861	\$1,960		
	36	78	9 1/16	164	21	VSVB3678B			\$3,218	\$3,537
	36	72	9 1/16	158	19	VSTB3672B	\$1,565	\$1,647		
	36	72	9 1/16	158	19	VSVB3672B			\$2,709	\$2,976
	30	84	9 1/16	163	19	VSTB3084B	\$1,796	\$1,890		
	30	84	9 1/16	163	19	VSVB3084B			\$3,102	\$3,416
	30	78	9 1/16	158	18	VSTB3078B	\$1,738	\$1,828		
	30	78	9 1/16	158	18	VSVB3078B			\$3,000	\$3,301
	30	72	9 1/16	153	16	VSTB3072B	\$1,516	\$1,596		
	30	72	9 1/16	153	16	VSVB3072B			\$2,618	\$2,882

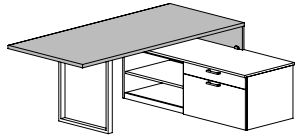


- must attach to bench height cabinet & top, see pages VS132-134
 - edge profile on three open sides
 - top grommet available, specify location, and add \$51 list each
 - chassis grommet available, specify and add \$49 list
 - non-handed
 - not recommended for freestanding use
 - bases must be purchased separately; see pages VS161-VS162 for options
- Note: truss base not compatible with models wider than 72"

To Order, Specify:

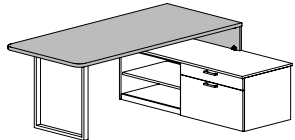
① Model Number	Laminate - VST	Veneer - VSV	
	<p>② Worksurface Material (see page VI3)</p> <p>a.) TFL</p> <p>b.) HPL</p> <p>③ Laminate Color (see page VI3)</p> <p>a.) Worksurface Color</p> <p>b.) Chassis Color</p> <p>c.) Drawer Color</p>	<p>② Wood Species - Cherry (CH1), Maple (MA1) Walnut (WA1), Black Oak (BO1) or Double Cut (DC1) (see page VI1)</p> <p>③ Finish Color (see page VI1)</p>	<p>④ Edge Profile (see page VI4)</p> <p>⑤ Pull Style and Color (see page VI5)</p> <p>⑥ Optional Grommet Location & Color - Matte Black (MBK) or Arctic Silver (ASL) (see page VI6)</p> <p>⑦ Other Product Options (see page VI10)</p> <p>⑧ Accessories (see page VS314)</p> <p>⑨ Power and Data Options (see page VS324)</p>

Description	D	W	H	CTN WT	CU FT	① Model	TFL Laminate	HPL Laminate	Flat Cut Veneer	Double Cut Veneer
Bench Height Supported Rectangular Peninsula Desk	36	84	9 1/16	171	22	VSTB3684RCT	\$1,425	\$1,497		
	36	84	9 1/16	171	22	VSVB3684RCT			\$2,376	\$2,614
	36	78	9 1/16	165	21	VSTB3678RCT	\$1,344	\$1,413		
	36	78	9 1/16	165	21	VSVB3678RCT			\$2,245	\$2,473
	36	72	9 1/16	159	19	VSTB3672RCT	\$1,285	\$1,358		
	36	72	9 1/16	159	19	VSVB3672RCT			\$2,157	\$2,374
	30	84	9 1/16	164	19	VSTB3084RCT	\$1,359	\$1,429		
	30	84	9 1/16	164	19	VSVB3084RCT			\$2,267	\$2,492
	30	78	9 1/16	159	18	VSTB3078RCT	\$1,308	\$1,376		
	30	78	9 1/16	159	18	VSVB3078RCT			\$2,182	\$2,401
	30	72	9 1/16	154	16	VSTB3072RCT	\$1,269	\$1,335		
	30	72	9 1/16	154	16	VSVB3072RCT			\$2,119	\$2,332



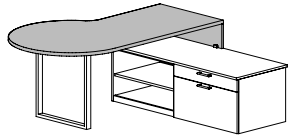
- must attach to bench height cabinet & top, see pages VS132-VS134
 - edge profile on three open sides
 - top grommet available, specify location, and add \$51 list each
 - chassis grommet available, specify and add \$49 list
 - non-handed
 - not recommended for freestanding use
 - bases must be purchased separately; see pages VS161-VS162 for options
- Note: truss base not compatible with models wider than 72"

Description	D	W	H	CTN WT	CU FT	① Model	TFL Laminate	HPL Laminate	Flat Cut Veneer	Double Cut Veneer
Soft Rectangular Desk - use with Bench Height	36	84	9 1/16	126	23	VSTB3684RRD	\$1,387	\$1,519		
	36	84	9 1/16	126	23	VSVB3684RRD			\$2,651	\$2,897
	36	78	9 1/16	117	21	VSTB3678RRD	\$1,310	\$1,430		
	36	78	9 1/16	117	21	VSVB3678RRD			\$2,508	\$2,740
	36	72	9 1/16	109	20	VSTB3672RRD	\$1,224	\$1,335		
	36	72	9 1/16	109	20	VSVB3672RRD			\$2,356	\$2,576
	36	66	9 1/16	101	18	VSTB3666RRD	\$1,147	\$1,250		
	36	66	9 1/16	101	18	VSVB3666RRD			\$2,217	\$2,423
	36	60	9 1/16	92	16	VSTB3660RRD	\$1,080	\$1,173		
	36	60	9 1/16	92	16	VSVB3660RRD			\$2,084	\$2,277
	30	84	9 1/16	106	19	VSTB3084RRD	\$1,228	\$1,337		
	30	84	9 1/16	106	19	VSVB3084RRD			\$2,339	\$2,553
30	78	9 1/16	99	18	VSTB3078RRD	\$1,162	\$1,262			
30	78	9 1/16	99	18	VSVB3078RRD			\$2,216	\$2,418	
30	72	9 1/16	92	17	VSTB3072RRD	\$1,086	\$1,178			
30	72	9 1/16	92	17	VSVB3072RRD			\$2,087	\$2,279	
30	66	9 1/16	85	15	VSTB3066RRD	\$1,021	\$1,107			
30	66	9 1/16	85	15	VSVB3066RRD			\$1,967	\$2,150	
30	60	9 1/16	78	14	VSTB3060RRD	\$965	\$1,043			
30	60	9 1/16	78	14	VSVB3060RRD			\$1,858	\$2,029	



- must attach to bench height cabinet & top, see pages VS132-VS134
 - edge profile on three open sides
 - top grommet available, specify location, and add \$51 list each
 - chassis grommet available, specify and add \$49 list
 - non-handed
 - not recommended for freestanding use
 - bases must be purchased separately; see pages VS161-VS162 for options
- Note: truss base not compatible with models wider than 72"

Description	D	W	H	CTN WT	CU FT	① Model	TFL Laminate	HPL Laminate	Flat Cut Veneer	Double Cut Veneer
Bench Height Supported P-Top Peninsula Desk	42	84	9 1/16	185	26	VSTB4284RP	\$2,035	\$2,142		
	42	84	9 1/16	185	26	VSVB4284RP			\$3,522	\$3,872
	42	84	9 1/16	185	26	VSTB4284LP	\$2,035	\$2,142		
	42	84	9 1/16	185	26	VSVB4284LP			\$3,522	\$3,872
	42	78	9 1/16	179	24	VSTB4278RP	\$1,963	\$2,065		
	42	78	9 1/16	179	24	VSVB4278RP			\$3,391	\$3,728
	42	78	9 1/16	179	24	VSTB4278LP	\$1,963	\$2,065		
	42	78	9 1/16	179	24	VSVB4278LP			\$3,391	\$3,728
	42	72	9 1/16	170	22	VSTB4272RP	\$1,841	\$1,940		
	42	72	9 1/16	170	22	VSVB4272RP			\$3,184	\$3,501
	42	72	9 1/16	170	22	VSTB4272LP	\$1,841	\$1,940		
	42	72	9 1/16	170	22	VSVB4272LP			\$3,184	\$3,501



left shown



left

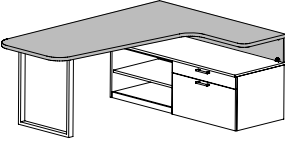
right

- 42" widest point
- 30" at end panel
- top grommet available, specify location, and add \$51 list each
- chassis grommet available, specify and add \$49 list
- must attach to bench height cabinet & top, see pages VS132-VS134
- edge profile on three open sides
- not recommended for freestanding use
- bases must be purchased separately; see pages VS161-VS162 for options

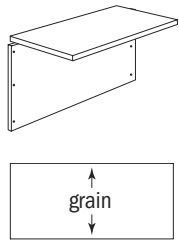
Note: truss base not compatible with P-Top Peninsula Desk

To Order, Specify:

① Model Number	Laminate - VST	Veneer - VSV	
	<p>② Worksurface Material (see page VI3)</p> <p>a.) TFL</p> <p>b.) HPL</p>	<p>② Wood Species - Cherry (CH1), Maple (MA1)</p> <p>Walnut (WA1), Black Oak (BO1) or</p> <p>Double Cut (DC1) (see page VI1)</p>	<p>④ Edge Profile (see page VI4)</p> <p>⑤ Pull Style and Color (see page VI5)</p>
	<p>③ Laminate Color (see page VI3)</p> <p>a.) Worksurface Color</p> <p>b.) Chassis Color</p> <p>c.) Drawer Color</p>	<p>③ Finish Color (see page VI1)</p>	<p>⑥ Optional Grommet Location & Color - Matte Black (MBK) or Arctic Silver (ASL) (see page VI6)</p> <p>⑦ Other Product Options (see page VI10)</p> <p>⑧ Accessories (see page VS314)</p> <p>⑨ Power and Data Options (see page VS324)</p>

Description	D	W	H	CTN WT	CU FT	① Model	TFL Laminate	HPL Laminate	Flat Cut Veneer	Double Cut Veneer
 <p>left shown</p>	60	84	9 1/16	139	37	VSTB6084SWPR	\$2,090	\$2,307		
	60	84	9 1/16	139	37	VSVB6084SWPR			\$4,018	\$4,401
	60	84	9 1/16	139	37	VSTB6084SWPL	\$2,090	\$2,307		
	60	84	9 1/16	139	37	VSVB6084SWPL			\$4,018	\$4,401
	60	78	9 1/16	132	34	VSTB6078SWPR	\$1,967	\$2,169		
	60	78	9 1/16	132	34	VSVB6078SWPR			\$3,788	\$4,149
	60	78	9 1/16	132	34	VSTB6078SWPL	\$1,967	\$2,169		
	60	78	9 1/16	132	34	VSVB6078SWPL			\$3,788	\$4,149
	60	72	9 1/16	125	32	VSTB6072SWPR	\$1,836	\$2,023		
	60	72	9 1/16	125	32	VSVB6072SWPR			\$3,548	\$3,887
	60	72	9 1/16	125	32	VSTB6072SWPL	\$1,836	\$2,023		
	60	72	9 1/16	125	32	VSVB6072SWPL			\$3,548	\$3,887
	60	66	9 1/16	118	29	VSTB6066SWPR	\$1,717	\$1,886		
	60	66	9 1/16	118	29	VSVB6066SWPR			\$3,319	\$3,636
	60	66	9 1/16	118	29	VSTB6066SWPL	\$1,717	\$1,886		
	60	66	9 1/16	118	29	VSVB6066SWPL			\$3,319	\$3,636
	60	60	9 1/16	111	26	VSTB6060SWPR	\$1,605	\$1,760		
	60	60	9 1/16	111	26	VSVB6060SWPR			\$3,099	\$3,394
	60	60	9 1/16	111	26	VSTB6060SWPL	\$1,605	\$1,760		
	60	60	9 1/16	111	26	VSVB6060SWPL			\$3,099	\$3,394

- must attach to bench height cabinet & top, see pages VS132-VS134
 - edge profile on three open sides
 - top grommet available, specify location, and add \$51 list each
 - chassis grommet available, specify and add \$97 list
 - not recommended for freestanding use
 - bases must be purchased separately; see pages VS161-VS162 for options
- Note: truss base not compatible with models wider than 72"

Description	D	W	H	CTN WT	CU FT	① Model	TFL Laminate	HPL Laminate	Flat Cut Veneer	Double Cut Veneer
Bridge with Modesty Panel 	24	48	29½	112	4	VST2448EB	\$614	\$645		
	24	48	29½	112	4	VSV2448EB			\$763	\$840
	24	42	29½	109	3	VST2442EB	\$590	\$619		
	24	42	29½	109	3	VSV2442EB			\$729	\$803
	24	36	29½	101	3	VST2436EB	\$565	\$593		
	24	36	29½	101	3	VSV2436EB			\$708	\$782
	20	48	29½	104	4	VST2048EB	\$591	\$620		
	20	48	29½	104	4	VSV2048EB			\$734	\$806
	20	42	29½	102	3	VST2042EB	\$565	\$593		
	20	42	29½	102	3	VSV2042EB			\$702	\$774
	20	36	29½	96	3	VST2036EB	\$542	\$569		
	20	36	29½	96	3	VSV2036EB			\$683	\$750

- top edge profile on user side
- short grain direction
- top grommet available, specify location, and add \$51 list each
- chassis grommet available, specify and add \$49 list

To Order, Specify:

① Model Number

Laminate - VST

Veneer - VSV

② Worksurface Material (see page VI3)

- a.) TFL
- b.) HPL

② Wood Species - Cherry (CH1), Maple (MA1)

- Walnut (WA1), Black Oak (BO1) or
- Double Cut (DC1) (see page VI1)

③ Laminate Color (see page VI3)

- a.) Worksurface Color
- b.) Chassis Color
- c.) Drawer Color

③ Finish Color (see page VI1)

④ Edge Profile (see page VI4)

⑤ Pull Style and Color (see page VI5)

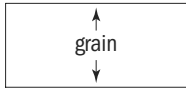
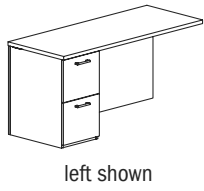
⑥ Optional Grommet Location & Color -
Matte Black (MBK) or Arctic Silver (ASL)
(see page VI6)

⑦ Other Product Options (see page VI10)

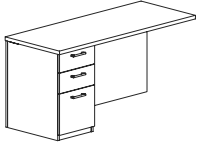
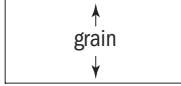
⑧ Accessories (see page VS314)

⑨ Power and Data Options (see page VS324)

Description	D	W	H	CTN WT	CU FT	① Model	TFL Laminate	HPL Laminate	Flat Cut Veneer	Double Cut Veneer
File/File Return	24	60	29 1/2	190	30	VST2460ERR	\$1,670	\$1,761		
	24	60	29 1/2	190	30	VSV2460ERR			\$2,436	\$2,687
	24	60	29 1/2	190	30	VST2460ELR	\$1,670	\$1,761		
	24	60	29 1/2	190	30	VSV2460ELR			\$2,436	\$2,687
	24	54	29 1/2	179	27	VST2454ERR	\$1,532	\$1,614		
	24	54	29 1/2	179	27	VSV2454ERR			\$2,369	\$2,611
	24	54	29 1/2	179	27	VST2454ELR	\$1,532	\$1,614		
	24	54	29 1/2	179	27	VSV2454ELR			\$2,369	\$2,611
	24	48	29 1/2	168	25	VST2448ERR	\$1,266	\$1,337		
	24	48	29 1/2	168	25	VSV2448ERR			\$2,262	\$2,493
	24	48	29 1/2	168	25	VST2448ELR	\$1,266	\$1,337		
	24	48	29 1/2	168	25	VSV2448ELR			\$2,262	\$2,493
	24	42	29 1/2	155	22	VST2442ERR	\$1,184	\$1,249		
	24	42	29 1/2	155	22	VSV2442ERR			\$2,195	\$2,419
	24	42	29 1/2	155	22	VST2442ELR	\$1,184	\$1,249		
	24	42	29 1/2	155	22	VSV2442ELR			\$2,195	\$2,419
	20	60	29 1/2	173	26	VST2060ERR	\$1,602	\$1,686		
	20	60	29 1/2	173	26	VSV2060ERR			\$2,339	\$2,577
	20	60	29 1/2	173	26	VST2060ELR	\$1,602	\$1,686		
	20	60	29 1/2	173	26	VSV2060ELR			\$2,339	\$2,577
	20	54	29 1/2	163	23	VST2054ERR	\$1,470	\$1,549		
	20	54	29 1/2	163	23	VSV2054ERR			\$2,271	\$2,505
	20	54	29 1/2	163	23	VST2054ELR	\$1,470	\$1,549		
	20	54	29 1/2	163	23	VSV2054ELR			\$2,271	\$2,505
	20	48	29 1/2	154	21	VST2048ERR	\$1,214	\$1,279		
	20	48	29 1/2	154	21	VSV2048ERR			\$2,168	\$2,391
	20	48	29 1/2	154	21	VST2048ELR	\$1,214	\$1,279		
	20	48	29 1/2	154	21	VSV2048ELR			\$2,168	\$2,391
	20	42	29 1/2	142	18	VST2042ERR	\$1,134	\$1,197		
	20	42	29 1/2	142	18	VSV2042ERR			\$2,106	\$2,323
	20	42	29 1/2	142	18	VST2042ELR	\$1,134	\$1,197		
	20	42	29 1/2	142	18	VSV2042ELR			\$2,106	\$2,323



- top edge profile on user side
- short grain direction
- top grommet available, specify location, and add \$51 list each
- chassis grommets available, specify and add \$97 list
- letter width file/file pedestal
- locking available, specify and add \$80 list
- optional 10" modesty panel available in place of full modesty, add and specify color

Description	D	W	H	CTN WT	CU FT	① Model	TFL Laminate	HPL Laminate	Flat Cut Veneer	Double Cut Veneer
 <p>left shown</p> 	24	60	29 1/2	190	30	VST2460ERY	\$1,670	\$1,761		
	24	60	29 1/2	190	30	VSV2460ERY			\$2,436	\$2,687
	24	60	29 1/2	190	30	VST2460ELY	\$1,670	\$1,761		
	24	60	29 1/2	190	30	VSV2460ELY			\$2,436	\$2,687
	24	54	29 1/2	179	27	VST2454ERY	\$1,532	\$1,614		
	24	54	29 1/2	179	27	VSV2454ERY			\$2,369	\$2,611
	24	54	29 1/2	179	27	VST2454ELY	\$1,532	\$1,614		
	24	54	29 1/2	179	27	VSV2454ELY			\$2,369	\$2,611
	24	48	29 1/2	168	25	VST2448ERY	\$1,266	\$1,337		
	24	48	29 1/2	168	25	VSV2448ERY			\$2,262	\$2,493
	24	48	29 1/2	168	25	VST2448ELY	\$1,266	\$1,337		
	24	48	29 1/2	168	25	VSV2448ELY			\$2,262	\$2,493
	24	42	29 1/2	155	22	VST2442ERY	\$1,184	\$1,249		
	24	42	29 1/2	155	22	VSV2442ERY			\$2,195	\$2,419
	24	42	29 1/2	155	22	VST2442ELY	\$1,184	\$1,249		
	24	42	29 1/2	155	22	VSV2442ELY			\$2,195	\$2,419

- top edge profile on user side
- short grain direction
- top grommet available, specify location, and add \$51 list each
- chassis grommets available, specify and add \$97 list
- letter width box/box/file pedestal
- locking available, specify and add \$80 list
- optional 10" modesty panel available in place of full modesty, add and specify color

To Order, Specify:

① Model Number

Laminate - VST

Veneer - VSV

② Worksurface Material (see page VI3)

a.) TFL

b.) HPL

③ Laminate Color (see page VI3)

a.) Worksurface Color

b.) Chassis Color

c.) Drawer Color

② Wood Species - Cherry (CH1), Maple (MA1)

Walnut (WA1), Black Oak (BO1) or

Double Cut (DC1) (see page VI1)

③ Finish Color (see page VI1)

④ Edge Profile (see page VI4)

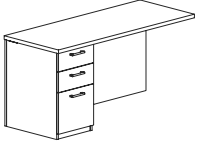
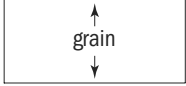
⑤ Pull Style and Color (see page VI5)

⑥ Optional Grommet Location & Color -
Matte Black (MBK) or Arctic Silver (ASL)
(see page VI6)

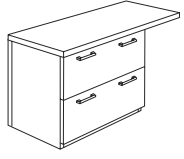
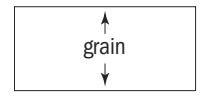
⑦ Other Product Options (see page VI10)

⑧ Accessories (see page VS314)

⑨ Power and Data Options (see page VS324)

Description	D	W	H	CTN WT	CU FT	① Model	TFL Laminate	HPL Laminate	Flat Cut Veneer	Double Cut Veneer
 <p>left shown</p> 	20	60	29 ½	173	26	VST2060ERY	\$1,602	\$1,686		
	20	60	29 ½	173	26	VSV2060ERY			\$2,339	\$2,577
	20	60	29 ½	173	26	VST2060ELY	\$1,602	\$1,686		
	20	60	29 ½	173	26	VSV2060ELY			\$2,339	\$2,577
	20	54	29 ½	163	23	VST2054ERY	\$1,470	\$1,549		
	20	54	29 ½	163	23	VSV2054ERY			\$2,271	\$2,505
	20	54	29 ½	163	23	VST2054ELY	\$1,470	\$1,549		
	20	54	29 ½	163	23	VSV2054ELY			\$2,271	\$2,505
	20	48	29 ½	154	21	VST2048ERY	\$1,214	\$1,279		
	20	48	29 ½	154	21	VSV2048ERY			\$2,168	\$2,391
	20	48	29 ½	154	21	VST2048ELY	\$1,214	\$1,279		
	20	48	29 ½	154	21	VSV2048ELY			\$2,168	\$2,391
	20	42	29 ½	142	18	VST2042ERY	\$1,134	\$1,197		
	20	42	29 ½	142	18	VSV2042ERY			\$2,106	\$2,323
	20	42	29 ½	142	18	VST2042ELY	\$1,134	\$1,197		
	20	42	29 ½	142	18	VSV2042ELY			\$2,106	\$2,323

- top edge profile on user side
- short grain direction
- top grommet available, specify location, and add \$51 list each
- chassis grommets available, specify and add \$97 list
- letter width box/box/file pedestal
- locking available, specify and add \$80 list
- optional 10" modesty panel available in place of full modesty, add and specify color

Description	D	W	H	CTN WT	CU FT	① Model	TFL Laminate	HPL Laminate	Flat Cut Veneer	Double Cut Veneer
Lateral File Return  left shown 	24	60	29½	199	30	VST2460LRR	\$2,063	\$2,177		
	24	60	29½	199	30	VSV2460LRR			\$2,742	\$3,027
	24	60	29½	199	30	VST2460LLR	\$2,063	\$2,177		
	24	60	29½	199	30	VSV2460LLR			\$2,742	\$3,027
	24	54	29½	187	27	VST2454LRR	\$1,797	\$1,897		
	24	54	29½	187	27	VSV2454LRR			\$2,635	\$2,909
	24	54	29½	187	27	VST2454LLR	\$1,797	\$1,897		
	24	54	29½	187	27	VSV2454LLR			\$2,635	\$2,909
	24	48	29½	175	25	VST2448LRR	\$1,713	\$1,810		
	24	48	29½	175	25	VSV2448LRR			\$2,567	\$2,836
	24	48	29½	175	25	VST2448LLR	\$1,713	\$1,810		
	24	48	29½	175	25	VSV2448LLR			\$2,567	\$2,836
	20	60	29½	188	26	VST2060LRR	\$1,980	\$2,085		
	20	60	29½	188	26	VSV2060LRR			\$2,629	\$2,901
	20	60	29½	188	26	VST2060LLR	\$1,980	\$2,085		
	20	60	29½	188	26	VSV2060LLR			\$2,629	\$2,901
	20	54	29½	177	23	VST2054LRR	\$1,721	\$1,817		
	20	54	29½	177	23	VSV2054LRR			\$2,527	\$2,790
	20	54	29½	177	23	VST2054LLR	\$1,721	\$1,817		
	20	54	29½	177	23	VSV2054LLR			\$2,527	\$2,790
20	48	29½	164	21	VST2048LRR	\$1,644	\$1,734			
20	48	29½	164	21	VSV2048LRR			\$2,463	\$2,719	
20	48	29½	164	21	VST2048LLR	\$1,644	\$1,734			
20	48	29½	164	21	VSV2048LLR			\$2,463	\$2,719	

- top edge profile on user side
- short grain direction
- top grommet available, specify location, and add \$51 list each
- chassis grommets available, specify and add \$97 list
- 36" w lateral file
- locking available, specify and add \$112 list
- optional 10" modesty panel available in place of full modesty, add and specify color

To Order, Specify:

① Model Number

Laminate - VST

Veneer - VSV

② Worksurface Material (see page VI3)

a.) TFL

b.) HPL

③ Laminate Color (see page VI3)

a.) Worksurface Color

b.) Chassis Color

c.) Drawer Color

② Wood Species - Cherry (CH1), Maple (MA1)

Walnut (WA1), Black Oak (BO1) or

Double Cut (DC1) (see page VI1)

③ Finish Color (see page VI1)

④ Edge Profile (see page VI4)

⑤ Pull Style and Color (see page VI5)

⑥ Optional Grommet Location & Color -
Matte Black (MBK) or Arctic Silver (ASL)
(see page VI6)

⑦ Other Product Options (see page VI10)

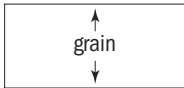
⑧ Accessories (see page VS314)

⑨ Power and Data Options (see page VS324)

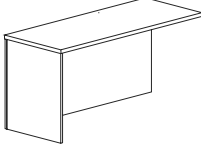
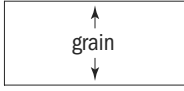
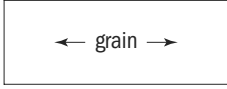
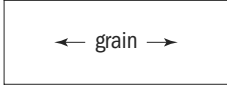
Description	D	W	H	CTN WT	CU FT	① Model	TFL Laminate	HPL Laminate	Flat Cut Veneer	Double Cut Veneer
Multi-File Return	24	60	29 1/2	202	27	VST2460MLR	\$2,220	\$2,344		
	24	60	29 1/2	202	30	VSV2460MLR			\$3,236	\$3,570
	24	60	29 1/2	202	30	VST2460MLL	\$2,220	\$2,344		
	24	60	29 1/2	202	30	VSV2460MLL			\$3,236	\$3,570
	24	54	29 1/2	190	27	VST2454MLR	\$2,084	\$2,196		
	24	54	29 1/2	190	27	VSV2454MLR			\$3,169	\$3,494
	24	54	29 1/2	190	27	VST2454MLL	\$2,084	\$2,196		
	24	54	29 1/2	190	27	VSV2454MLL			\$3,169	\$3,494
	24	48	29 1/2	179	25	VST2448MLR	\$1,818	\$1,917		
	24	48	29 1/2	179	25	VSV2448MLR			\$3,061	\$3,376
	24	48	29 1/2	179	25	VST2448MLL	\$1,818	\$1,917		
	24	48	29 1/2	179	25	VSV2448MLL			\$3,061	\$3,376
	20	60	29 1/2	191	26	VST2060MLR	\$2,130	\$2,246		
	20	60	29 1/2	191	26	VSV2060MLR			\$3,102	\$3,424
	20	60	29 1/2	191	26	VST2060MLL	\$2,130	\$2,246		
	20	60	29 1/2	191	26	VSV2060MLL			\$3,102	\$3,424
	20	54	29 1/2	180	23	VST2054MLR	\$1,998	\$2,107		
	20	54	29 1/2	180	23	VSV2054MLR			\$3,037	\$3,352
	20	54	29 1/2	180	23	VST2054MLL	\$1,998	\$2,107		
	20	54	29 1/2	180	23	VSV2054MLL			\$3,037	\$3,352
	20	48	29 1/2	167	21	VST2048MLR	\$1,742	\$1,837		
	20	48	29 1/2	167	21	VSV2048MLR			\$2,934	\$3,239
	20	48	29 1/2	167	21	VST2048MLL	\$1,742	\$1,837		
	20	48	29 1/2	167	21	VSV2048MLL			\$2,934	\$3,239



left shown



- top edge profile on user side
- short grain direction
- top grommet available, specify location, and add \$51 list each
- chassis grommets available, specify and add \$97 list
- 30" w multi-file
- locking available, specify and add \$112 list
- optional 10" modesty panel available in place of full modesty, add and specify color

Description	D	W	H	CTN WT	CU FT	① Model	TFL Laminate	HPL Laminate	Flat Cut Veneer	Double Cut Veneer
24" d Shell Return	24	72	29½	153	124	VST2472RSHR	\$1,125	\$1,184		
	24	72	29½	153	36	VSV2472RSHR			\$1,786	\$1,966
	24	72	29½	153	36	VST2472LSHR	\$1,125	\$1,184		
	24	72	29½	153	36	VSV2472LSHR			\$1,786	\$1,966
left shown	24	66	29½	147	33	VST2466RSHR	\$1,047	\$1,101		
	24	66	29½	147	33	VSV2466RSHR			\$1,665	\$1,832
	24	66	29½	147	33	VST2466LSHR	\$1,047	\$1,101		
	24	66	29½	147	33	VSV2466LSHR			\$1,665	\$1,832
36, 42, 48, 54, & 60" w	24	60	29½	141	30	VST2460RSHR	\$1,018	\$1,070		
	24	60	29½	141	30	VSV2460RSHR			\$1,614	\$1,777
	24	60	29½	141	30	VST2460LSHR	\$1,018	\$1,070		
	24	60	29½	141	30	VSV2460LSHR			\$1,614	\$1,777
66 & 72" w	24	54	29½	136	27	VST2454RSHR	\$989	\$1,039		
	24	54	29½	136	27	VSV2454RSHR			\$1,568	\$1,726
	24	54	29½	136	27	VST2454LSHR	\$989	\$1,039		
	24	54	29½	136	27	VSV2454LSHR			\$1,568	\$1,726
	24	48	29½	130	25	VST2448RSHR	\$960	\$1,010		
	24	48	29½	130	25	VSV2448RSHR			\$1,520	\$1,672
	24	48	29½	130	25	VST2448LSHR	\$960	\$1,010		
	24	48	29½	130	25	VSV2448LSHR			\$1,520	\$1,672
	24	42	29½	124	22	VST2442RSHR	\$929	\$978		
	24	42	29½	124	22	VSV2442RSHR			\$1,474	\$1,624
	24	42	29½	124	22	VST2442LSHR	\$929	\$978		
	24	42	29½	124	22	VSV2442LSHR			\$1,474	\$1,624
	24	36	29½	120	19	VST2436RSHR	\$905	\$952		
	24	36	29½	120	19	VSV2436RSHR			\$1,431	\$1,573
	24	36	29½	120	19	VST2436LSHR	\$905	\$952		
	24	36	29½	120	19	VSV2436LSHR			\$1,431	\$1,573

- top edge profile on user side
- short grain direction for 36", 42", 48", 54", and 60" w
- long grain direction for 66" and 72" w
- top grommet available, specify location, and add \$51 list each
- chassis grommet available, specify and add \$49 list
- modular pedestals available; see page VS126
- use 20" d pedestals with 24" d shell
- adding modular pedestals could block grommets

To Order, Specify:

① Model Number

Laminate - VST

Veneer - VSV

② Worksurface Material (see page V13)

a.) TFL

b.) HPL

③ Laminate Color (see page V13)

a.) Worksurface Color

b.) Chassis Color

c.) Drawer Color

② Wood Species - Cherry (CH1), Maple (MA1)

Walnut (WA1), Black Oak (BO1) or

Double Cut (DC1) (see page V11)

③ Finish Color (see page V11)

④ Edge Profile (see page V14)

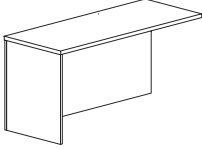
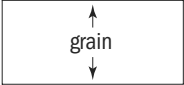
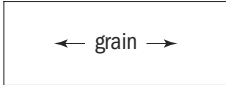
⑤ Pull Style and Color (see page V15)

⑥ Optional Grommet Location & Color -
Matte Black (MBK) or Arctic Silver (ASL)
(see page V16)

⑦ Other Product Options (see page V110)

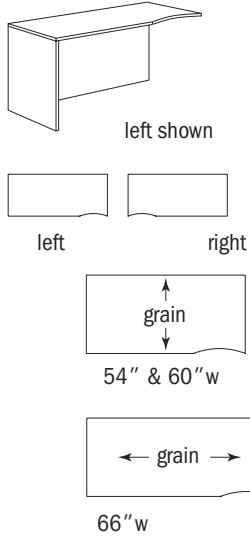
⑧ Accessories (see page VS314)

⑨ Power and Data Options (see page VS324)

Description	D	W	H	CTN WT	CU FT	① Model	TFL Laminate	HPL Laminate	Flat Cut Veneer	Double Cut Veneer
 <p>left shown</p>  <p>36, 42, 48, 54, & 60" w</p>  <p>66 & 72" w</p>	20	72	29 1/2	142	31	VST2072RSHR	\$1,082	\$1,139		
	20	72	29 1/2	142	31	VSV2072RSHR			\$1,718	\$1,891
	20	72	29 1/2	142	31	VST2072LSHR	\$1,082	\$1,139		
	20	72	29 1/2	142	31	VSV2072LSHR			\$1,718	\$1,891
	20	66	29 1/2	138	28	VST2066RSHR	\$1,006	\$1,060		
	20	66	29 1/2	138	28	VSV2066RSHR			\$1,598	\$1,757
	20	66	29 1/2	138	28	VST2066LSHR	\$1,006	\$1,060		
	20	66	29 1/2	138	28	VSV2066LSHR			\$1,598	\$1,757
	20	60	29 1/2	135	26	VST2060RSHR	\$978	\$1,029		
	20	60	29 1/2	135	26	VSV2060RSHR			\$1,550	\$1,706
	20	60	29 1/2	135	26	VST2060LSHR	\$978	\$1,029		
	20	60	29 1/2	135	26	VSV2060LSHR			\$1,550	\$1,706
	20	54	29 1/2	129	23	VST2054RSHR	\$949	\$998		
	20	54	29 1/2	129	23	VSV2054RSHR			\$1,505	\$1,657
	20	54	29 1/2	129	23	VST2054LSHR	\$949	\$998		
	20	54	29 1/2	129	23	VSV2054LSHR			\$1,505	\$1,657
	20	48	29 1/2	125	21	VST2048RSHR	\$922	\$970		
	20	48	29 1/2	125	21	VSV2048RSHR			\$1,460	\$1,605
	20	48	29 1/2	125	21	VST2048LSHR	\$922	\$970		
	20	48	29 1/2	125	21	VSV2048LSHR			\$1,460	\$1,605
	20	42	29 1/2	119	18	VST2042RSHR	\$892	\$940		
	20	42	29 1/2	119	18	VSV2042RSHR			\$1,415	\$1,558
	20	42	29 1/2	119	18	VST2042LSHR	\$892	\$940		
	20	42	29 1/2	119	18	VSV2042LSHR			\$1,415	\$1,558
	20	36	29 1/2	115	16	VST2036RSHR	\$869	\$915		
	20	36	29 1/2	115	16	VSV2036RSHR			\$1,375	\$1,512
	20	36	29 1/2	115	16	VST2036LSHR	\$869	\$915		
	20	36	29 1/2	115	16	VSV2036LSHR			\$1,375	\$1,512

- top edge profile on user side
- short grain direction for 36", 42", 48", 54", and 60" w
- long grain direction for 66" and 72" w
- top grommet available, specify location, and add \$51 list each
- chassis grommet available, specify and add \$49 list
- modular pedestals available; see page VS126
- use 18"d pedestals with 20"d shells
- adding modular pedestals could block grommets

Description	D	W	H	CTN WT	CU FT	① Model	TFL Laminate	HPL Laminate	Flat Cut Veneer	Double Cut Veneer
Cockpit Shell Return	24	66	29 1/2	153	36	VST2466RCSHR	\$1,323	\$1,389		
	24	66	29 1/2	153	36	VSV2466RCSHR			\$2,103	\$2,312
	24	66	29 1/2	153	36	VST2466LCSHR	\$1,323	\$1,389		
	24	66	29 1/2	153	36	VSV2466LCSHR			\$2,103	\$2,312
	24	60	29 1/2	147	33	VST2460RCSHR	\$1,242	\$1,308		
	24	60	29 1/2	147	33	VSV2460RCSHR			\$1,978	\$2,177
	24	60	29 1/2	147	33	VST2460LCSHR	\$1,242	\$1,308		
	24	60	29 1/2	147	33	VSV2460LCSHR			\$1,978	\$2,177
	24	54	29 1/2	147	33	VST2454RCSHR	\$1,199	\$1,261		
	24	54	29 1/2	147	33	VSV2454RCSHR			\$1,907	\$2,097
	24	54	29 1/2	147	33	VST2454LCSHR	\$1,199	\$1,261		
	24	54	29 1/2	147	33	VSV2454LCSHR			\$1,907	\$2,097



- top edge profile on user side
- long grain direction for 66" w
- short grain direction for 54" and 60" w
- top grommet available, specify location, and add \$51 list each
- chassis grommet available, specify and add \$49 list
- modular pedestals available; see page VS126
- use 20"d pedestals with 24"d shell
- adding modular pedestals could block grommets

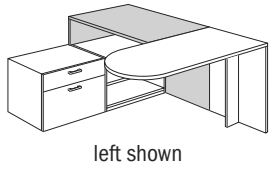
Bullet Return	60	30	1 3/16	91	4	VST3060BRET	\$635	\$667		
	60	30	1 3/16	91	4	VSV3060BRET			\$1,133	\$1,246
	48	30	1 3/16	68	4	VST3048BRET	\$586	\$615		
	48	30	1 3/16	68	4	VSV3048BRET			\$1,006	\$1,106
	60	24	1 3/16	70	3	VST2460BRET	\$559	\$588		
	60	24	1 3/16	70	3	VSV2460BRET			\$974	\$1,071
	48	24	1 3/16	55	3	VST2448BRET	\$503	\$528		
	48	24	1 3/16	55	3	VSV2448BRET			\$861	\$949

- edge profile on three open sides
- top grommet available, specify location, and add \$51 list each
- short grain direction
- includes hardware to attach flat end to desk top
- base must be purchased separately, see pages VS161-VS162 for options

To Order, Specify:

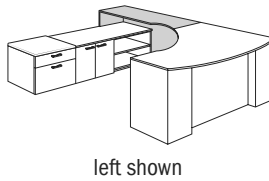
① Model Number	Laminate - VST	Veneer - VSV	④ Edge Profile (see page VI4)
	② Worksurface Material (see page VI3) a.) TFL b.) HPL	② Wood Species - Cherry (CH1), Maple (MA1) Walnut (WA1), Black Oak (BO1) or Double Cut (DC1) (see page VI1)	⑤ Pull Style and Color (see page VI5)
	③ Laminate Color (see page VI3) a.) Worksurface Color b.) Chassis Color c.) Drawer Color	③ Finish Color (see page VI1)	⑥ Optional Grommet Location & Color - Matte Black (MBK) or Arctic Silver (ASL) (see page VI6)
			⑦ Other Product Options (see page VI10)
			⑧ Accessories (see page VS314)
			⑨ Power and Data Options (see page VS324)

Description	D	W	H	CTN WT	CU FT	① Model	TFL Laminate	HPL Laminate	Flat Cut Veneer	Double Cut Veneer
Bench Height Supported Shell Return	24	72	29 ½	149	36	VSTB2472RSHR	\$1,125	\$1,184		
	24	72	29 ½	149	36	VSVB2472RSHR			\$1,786	\$1,966
	24	72	29 ½	149	36	VSTB2472LSHR	\$1,125	\$1,184		
	24	72	29 ½	149	36	VSVB2472LSHR			\$1,786	\$1,966
	24	66	29 ½	143	33	VSTB2466RSHR	\$1,047	\$1,101		
	24	66	29 ½	143	33	VSVB2466RSHR			\$1,665	\$1,832
	24	66	29 ½	143	33	VSTB2466LSHR	\$1,047	\$1,101		
	24	66	29 ½	143	33	VSVB2466LSHR			\$1,665	\$1,832

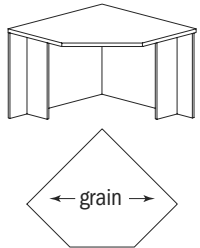


- must be attached to bench height cabinet & top, see pages VS132-VS134
- top edge profile on user side
- top grommet available, specify location, and add \$51 list each
- chassis grommet available, specify and add \$49 list
- long grain direction for 66" and 72" w laminate worksurface

Bench Height Supported Cockpit Shell Return	24	66	29 ½	153	36	VSTB2466RCSHR	\$1,323	\$1,389		
	24	66	29 ½	153	36	VSVB2466RCSHR			\$2,103	\$2,312
	24	66	29 ½	153	36	VSTB2466LCSHR	\$1,323	\$1,389		
	24	66	29 ½	153	36	VSVB2466LCSHR			\$2,103	\$2,312
	24	60	29 ½	147	33	VSTB2460RCSHR	\$1,242	\$1,308		
	24	60	29 ½	147	33	VSVB2460RCSHR			\$1,978	\$2,177
	24	60	29 ½	147	33	VSTB2460LCSHR	\$1,242	\$1,308		
	24	60	29 ½	147	33	VSVB2460LCSHR			\$1,978	\$2,177
	24	54	29 ½	147	33	VSTB2454RCSHR	\$1,199	\$1,261		
	24	54	29 ½	147	33	VSVB2454RCSHR			\$1,907	\$2,097
	24	54	29 ½	147	33	VSTB2454LCSHR	\$1,199	\$1,261		
	24	54	29 ½	147	33	VSVB2454LCSHR			\$1,907	\$2,097



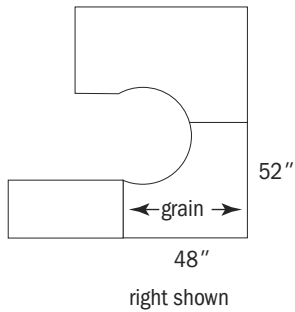
- must be attached to bench height cabinet & top, see pages VS132-VS134
- top edge profile on user side
- top grommet available, specify location, and add \$51 list each
- chassis grommet available, specify and add \$49 list
- long grain direction for 66" w laminate worksurface
- short grain direction for 54" and 60" w laminate worksurface

Description	D	W	H	CTN WT	CU FT	① Model	TFL Laminate	HPL Laminate	Flat Cut Veneer	Double Cut Veneer
	42	42	29½	162	36	VST4242-24ECU	\$1,749	\$1,841		
	42	42	29½	162	36	VSV4242-24ECU			\$2,469	\$2,716
	36	36	29½	132	27	VST3636-24ECU	\$1,596	\$1,679		
	36	36	29½	132	27	VSV3636-24ECU			\$2,399	\$2,640
	42	42	29½	162	36	VST4242-20ECU	\$1,749	\$1,841		
	42	42	29½	162	36	VSV4242-20ECU			\$2,469	\$2,716
	36	36	29½	132	27	VST3636-20ECU	\$1,596	\$1,679		
	36	36	29½	132	27	VSV3636-20ECU			\$2,399	\$2,640

- angle grain on top
- top edge profile on user side
- top grommet available, specify location, and add \$51 list each
- chassis grommet available, specify and add \$49 list

	48	52	29½	180	50	VST4852ERCU	\$2,127	\$2,238		
	48	52	29½	180	50	VSV4852ERCU			\$2,632	\$2,897
	48	52	29½	180	50	VST4852ELCU	\$2,127	\$2,238		
	48	52	29½	180	50	VSV4852ELCU			\$2,632	\$2,897

- attaches to 24" return
- parallel grain to 48" side of top
- top edge profile on user side
- top grommet available, specify location, and add \$51 list each
- chassis grommet available, specify and add \$49 list



To Order, Specify:

① Model Number

Laminate - VST

Veneer - VSV

② Worksurface Material (see page VI3)

- a.) TFL
- b.) HPL

② Wood Species - Cherry (CH1), Maple (MA1)

- Walnut (WA1), Black Oak (BO1) or Double Cut (DC1) (see page VI1)

③ Laminate Color (see page VI3)

- a.) Worksurface Color
- b.) Chassis Color
- c.) Drawer Color

③ Finish Color (see page VI1)

④ Edge Profile (see page VI4)

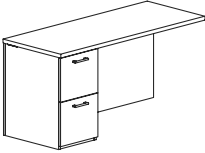
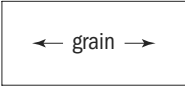
⑤ Pull Style and Color (see page VI5)

⑥ Optional Grommet Location & Color - Matte Black (MBK) or Arctic Silver (ASL) (see page VI6)

⑦ Other Product Options (see page VI10)

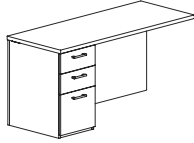
⑧ Accessories (see page VS314)

⑨ Power and Data Options (see page VS324)

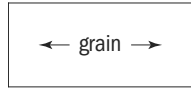
Description	D	W	H	CTN WT	CU FT	① Model	TFL Laminate	HPL Laminate	Flat Cut Veneer	Double Cut Veneer
 <p>left shown</p> 	24	60	29 ½	190	30	VST2460ERCR	\$1,670	\$1,761		
	24	60	29 ½	190	30	VSV2460ERCR			\$2,436	\$2,687
	24	60	29 ½	190	30	VST2460ELCR	\$1,670	\$1,761		
	24	60	29 ½	190	30	VSV2460ELCR			\$2,436	\$2,687
	24	54	29 ½	179	27	VST2454ERCR	\$1,532	\$1,614		
	24	54	29 ½	179	27	VSV2454ERCR			\$2,369	\$2,611
	24	54	29 ½	179	27	VST2454ELCR	\$1,532	\$1,614		
	24	54	29 ½	179	27	VSV2454ELCR			\$2,369	\$2,611
	24	48	29 ½	168	25	VST2448ERCR	\$1,266	\$1,337		
	24	48	29 ½	168	25	VSV2448ERCR			\$2,262	\$2,493
	24	48	29 ½	168	25	VST2448ELCR	\$1,266	\$1,337		
	24	48	29 ½	168	25	VSV2448ELCR			\$2,262	\$2,493
	24	42	29 ½	155	22	VST2442ERCR	\$1,184	\$1,249		
	24	42	29 ½	155	22	VSV2442ERCR			\$2,195	\$2,419
	24	42	29 ½	155	22	VST2442ELCR	\$1,184	\$1,249		
	24	42	29 ½	155	22	VSV2442ELCR			\$2,195	\$2,419
	20	60	29 ½	173	26	VST2060ERCR	\$1,602	\$1,686		
	20	60	29 ½	173	26	VSV2060ERCR			\$2,339	\$2,577
	20	60	29 ½	173	26	VST2060ELCR	\$1,602	\$1,686		
	20	60	29 ½	173	26	VSV2060ELCR			\$2,339	\$2,577
	20	54	29 ½	163	23	VST2054ERCR	\$1,470	\$1,549		
	20	54	29 ½	163	23	VSV2054ERCR			\$2,271	\$2,505
	20	54	29 ½	163	23	VST2054ELCR	\$1,470	\$1,549		
	20	54	29 ½	163	23	VSV2054ELCR			\$2,271	\$2,505
	20	48	29 ½	154	21	VST2048ERCR	\$1,214	\$1,279		
	20	48	29 ½	154	21	VSV2048ERCR			\$2,168	\$2,391
	20	48	29 ½	154	21	VST2048ELCR	\$1,214	\$1,279		
	20	48	29 ½	154	21	VSV2048ELCR			\$2,168	\$2,391
	20	42	29 ½	142	18	VST2042ERCR	\$1,134	\$1,197		
	20	42	29 ½	142	18	VSV2042ERCR			\$2,106	\$2,323
20	42	29 ½	142	18	VST2042ELCR	\$1,134	\$1,197			
20	42	29 ½	142	18	VSV2042ELCR			\$2,106	\$2,323	

- top edge profile on user side
- long grain direction
- top grommet available, specify location, and add \$51 list each
- chassis grommets available, specify and add \$97 list
- letter width file/file pedestal
- locking available, specify and add \$80 list
- optional 10" modesty panel available in place of full modesty, add and specify color

Description	D	W	H	CTN WT	CU FT	① Model	TFL Laminate	HPL Laminate	Flat Cut Veneer	Double Cut Veneer
24" d Box/Box/File Corner Return	24	60	29½	190	30	VST2460ERCY	\$1,670	\$1,761		
	24	60	29½	190	30	VSV2460ERCY			\$2,436	\$2,687
	24	60	29½	190	30	VST2460ELCY	\$1,670	\$1,761		
	24	60	29½	190	30	VSV2460ELCY			\$2,436	\$2,687
	24	54	29½	179	27	VST2454ERCY	\$1,532	\$1,614		
	24	54	29½	179	27	VSV2454ERCY			\$2,369	\$2,611
	24	54	29½	179	27	VST2454ELCY	\$1,532	\$1,614		
	24	54	29½	179	27	VSV2454ELCY			\$2,369	\$2,611
	24	48	29½	168	25	VST2448ERCY	\$1,266	\$1,337		
	24	48	29½	168	25	VSV2448ERCY			\$2,262	\$2,493
	24	48	29½	168	25	VST2448ELCY	\$1,266	\$1,337		
	24	48	29½	168	25	VSV2448ELCY			\$2,262	\$2,493
	24	42	29½	155	22	VST2442ERCY	\$1,184	\$1,249		
	24	42	29½	155	22	VSV2442ERCY			\$2,195	\$2,419
	24	42	29½	155	22	VST2442ELCY	\$1,184	\$1,249		
	24	42	29½	155	22	VSV2442ELCY			\$2,195	\$2,419



left shown



- top edge profile on user side
- long grain direction
- top grommet available, specify location, and add \$51 list each
- chassis grommets available, specify and add \$97 list
- letter width box/box/file pedestal
- locking available, specify and add \$80 list
- optional 10" modesty panel available in place of full modesty, add and specify color

To Order, Specify:

① Model Number

Laminate - VST

Veneer - VSV

② Worksurface Material (see page VI3)

- a.) TFL
- b.) HPL

② Wood Species - Cherry (CH1), Maple (MA1)

- Walnut (WA1), Black Oak (BO1) or Double Cut (DC1) (see page VI1)

④ Edge Profile (see page VI4)

⑤ Pull Style and Color (see page VI5)

③ Laminate Color (see page VI3)

- a.) Worksurface Color
- b.) Chassis Color
- c.) Drawer Color

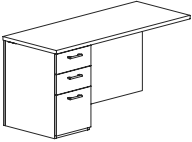
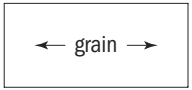
③ Finish Color (see page VI1)

⑥ Optional Grommet Location & Color - Matte Black (MBK) or Arctic Silver (ASL) (see page VI6)

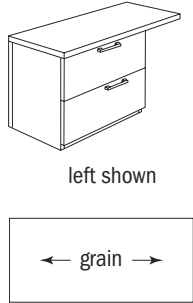
⑦ Other Product Options (see page VI10)

⑧ Accessories (see page VS314)

⑨ Power and Data Options (see page VS324)

Description	D	W	H	CTN WT	CU FT	① Model	TFL Laminate	HPL Laminate	Flat Cut Veneer	Double Cut Veneer
20" d Box/Box/File Corner Return	20	60	29 1/2	173	26	VST2060ERCY	\$1,602	\$1,686		
	20	60	29 1/2	173	26	VSV2060ERCY			\$2,339	\$2,577
 left shown	20	60	29 1/2	173	26	VST2060ELCY	\$1,602	\$1,686		
	20	60	29 1/2	173	26	VSV2060ELCY			\$2,339	\$2,577
	20	54	29 1/2	163	23	VST2054ERCY	\$1,470	\$1,549		
	20	54	29 1/2	163	23	VSV2054ERCY			\$2,271	\$2,505
	20	54	29 1/2	163	23	VST2054ELCY	\$1,470	\$1,549		
	20	54	29 1/2	163	23	VSV2054ELCY			\$2,271	\$2,505
	20	48	29 1/2	154	21	VST2048ERCY	\$1,214	\$1,279		
	20	48	29 1/2	154	21	VSV2048ERCY			\$2,168	\$2,391
	20	48	29 1/2	154	21	VST2048ELCY	\$1,214	\$1,279		
	20	48	29 1/2	154	21	VSV2048ELCY			\$2,168	\$2,391
	20	42	29 1/2	142	18	VST2042ERCY	\$1,134	\$1,197		
	20	42	29 1/2	142	18	VSV2042ERCY			\$2,106	\$2,323
	20	42	29 1/2	142	18	VST2042ELCY	\$1,134	\$1,197		
	20	42	29 1/2	142	18	VSV2042ELCY			\$2,106	\$2,323

- top edge profile on user side
- long grain direction
- top grommet available, specify location, and add \$51 list each
- chassis grommets available, specify and add \$97 list
- letter width box/box/file pedestal
- locking available, specify and add \$80 list
- optional 10" modesty panel available in place of full modesty, add and specify color

Description	D	W	H	CTN WT	CU FT	① Model	TFL Laminate	HPL Laminate	Flat Cut Veneer	Double Cut Veneer
Lateral File Corner Return 	24	60	29½	199	30	VST2460LRCR	\$2,063	\$2,177		
	24	60	29½	199	30	VSV2460LRCR			\$2,742	\$3,027
	24	60	29½	199	30	VST2460LLCR	\$2,063	\$2,177		
	24	60	29½	199	30	VSV2460LLCR			\$2,742	\$3,027
	24	54	29½	187	27	VST2454LRCR	\$1,797	\$1,897		
	24	54	29½	187	27	VSV2454LRCR			\$2,635	\$2,909
	24	54	29½	187	27	VST2454LLCR	\$1,797	\$1,897		
	24	54	29½	187	27	VSV2454LLCR			\$2,635	\$2,909
	24	48	29½	175	25	VST2448LRCR	\$1,713	\$1,810		
	24	48	29½	175	25	VSV2448LRCR			\$2,567	\$2,836
	24	48	29½	175	25	VST2448LLCR	\$1,713	\$1,810		
	24	48	29½	175	25	VSV2448LLCR			\$2,567	\$2,836
	20	60	29½	188	26	VST2060LRCR	\$1,980	\$2,085		
	20	60	29½	188	26	VSV2060LRCR			\$2,629	\$2,901
	20	60	29½	188	26	VST2060LLCR	\$1,980	\$2,085		
	20	60	29½	188	26	VSV2060LLCR			\$2,629	\$2,901
	20	54	29½	177	23	VST2054LRCR	\$1,721	\$1,817		
	20	54	29½	177	23	VSV2054LRCR			\$2,527	\$2,790
	20	54	29½	177	23	VST2054LLCR	\$1,721	\$1,817		
	20	54	29½	177	23	VSV2054LLCR			\$2,527	\$2,790
	20	48	29½	164	21	VST2048LRCR	\$1,644	\$1,734		
	20	48	29½	164	21	VSV2048LRCR			\$2,463	\$2,719
	20	48	29½	164	21	VST2048LLCR	\$1,644	\$1,734		
	20	48	29½	164	21	VSV2048LLCR			\$2,463	\$2,719

- top edge profile on user side
- long grain direction
- top grommet available, specify location, and add \$51 list each
- chassis grommets available, specify and add \$97 list
- 36" w lateral file
- locking available, specify and add \$112 list
- optional 10" modesty panel available in place of full modesty, add and specify color

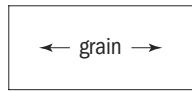
To Order, Specify:

① Model Number	Laminate - VST	Veneer - VSV	
	② Worksurface Material (see page VI3) a.) TFL b.) HPL	② Wood Species - Cherry (CH1), Maple (MA1) Walnut (WA1), Black Oak (BO1) or Double Cut (DC1) (see page VI1)	④ Edge Profile (see page VI4)
	③ Laminate Color (see page VI3) a.) Worksurface Color b.) Chassis Color c.) Drawer Color	③ Finish Color (see page VI1)	⑤ Pull Style and Color (see page VI5)
			⑥ Optional Grommet Location & Color - Matte Black (MBK) or Arctic Silver (ASL) (see page VI6)
			⑦ Other Product Options (see page VI10)
			⑧ Accessories (see page VS314)
			⑨ Power and Data Options (see page VS324)

Description	D	W	H	CTN WT	CU FT	① Model	TFL Laminate	HPL Laminate	Flat Cut Veneer	Double Cut Veneer
Multi-File Corner Return	24	60	29 ½	202	30	VST2460MRCR	\$2,220	\$2,344		
	24	60	29 ½	202	30	VSV2460MRCR			\$3,236	\$3,570
	24	60	29 ½	202	30	VST2460MLCR	\$2,220	\$2,344		
	24	60	29 ½	202	30	VSV2460MLCR			\$3,236	\$3,570
	24	54	29 ½	190	27	VST2454MRCR	\$2,084	\$2,196		
	24	54	29 ½	190	27	VSV2454MRCR			\$3,169	\$3,494
	24	54	29 ½	190	27	VST2454MLCR	\$2,084	\$2,196		
	24	54	29 ½	190	27	VSV2454MLCR			\$3,169	\$3,494
	24	48	29 ½	179	25	VST2448MRCR	\$1,818	\$1,917		
	24	48	29 ½	179	25	VSV2448MRCR			\$3,061	\$3,376
	24	48	29 ½	179	25	VST2448MLCR	\$1,818	\$1,917		
	24	48	29 ½	179	25	VSV2448MLCR			\$3,061	\$3,376
	20	60	29 ½	191	26	VST2060MRCR	\$2,130	\$2,246		
	20	60	29 ½	191	26	VSV2060MRCR			\$3,102	\$3,424
	20	60	29 ½	191	26	VST2060MLCR	\$2,130	\$2,246		
	20	60	29 ½	191	26	VSV2060MLCR			\$3,102	\$3,424
	20	54	29 ½	180	23	VST2054MRCR	\$1,998	\$2,107		
	20	54	29 ½	180	23	VSV2054MRCR			\$3,037	\$3,352
	20	54	29 ½	180	23	VST2054MLCR	\$1,998	\$2,107		
	20	54	29 ½	180	23	VSV2054MLCR			\$3,037	\$3,352
	20	48	29 ½	167	21	VST2048MRCR	\$1,742	\$1,837		
	20	48	29 ½	167	21	VSV2048MRCR			\$2,934	\$3,239
	20	48	29 ½	167	21	VST2048MLCR	\$1,742	\$1,837		
	20	48	29 ½	167	21	VSV2048MLCR			\$2,934	\$3,239

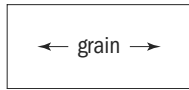
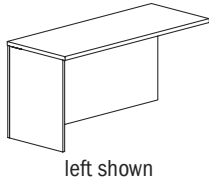


left shown



- top edge profile on user side
- long grain direction
- top grommet available, specify location, and add \$51 list each
- chassis grommets available, specify and add \$97 list
- 30" w multi-file
- locking available, specify and add \$112 list
- optional 10" modesty panel available in place of full modesty, add and specify color

Description	D	W	H	CTN WT	CU FT	① Model	TFL Laminate	HPL Laminate	Flat Cut Veneer	Double Cut Veneer
24" d Shell Corner Return	24	72	29½	153	36	VST2472RSHCR	\$1,125	\$1,184		
	24	72	29½	153	36	VSV2472RSHCR			\$1,786	\$1,966
	24	72	29½	153	36	VST2472LSHCR	\$1,125	\$1,184		
	24	72	29½	153	36	VSV2472LSHCR			\$1,786	\$1,966
	24	66	29½	147	33	VST2466RSHCR	\$1,047	\$1,101		
	24	66	29½	147	33	VSV2466RSHCR			\$1,665	\$1,832
	24	66	29½	147	33	VST2466LSHCR	\$1,047	\$1,101		
	24	66	29½	147	33	VSV2466LSHCR			\$1,665	\$1,832
	24	60	29½	141	30	VST2460RSHCR	\$1,018	\$1,070		
	24	60	29½	141	30	VSV2460RSHCR			\$1,614	\$1,777
	24	60	29½	141	30	VST2460LSHCR	\$1,018	\$1,070		
	24	60	29½	141	30	VSV2460LSHCR			\$1,614	\$1,777
	24	54	29½	136	27	VST2454RSHCR	\$989	\$1,039		
	24	54	29½	136	27	VSV2454RSHCR			\$1,568	\$1,726
	24	54	29½	136	27	VST2454LSHCR	\$989	\$1,039		
	24	54	29½	136	27	VSV2454LSHCR			\$1,568	\$1,726
	24	48	29½	130	25	VST2448RSHCR	\$960	\$1,010		
	24	48	29½	130	25	VSV2448RSHCR			\$1,520	\$1,672
	24	48	29½	130	25	VST2448LSHCR	\$960	\$1,010		
	24	48	29½	130	25	VSV2448LSHCR			\$1,520	\$1,672
	24	42	29½	124	22	VST2442RSHCR	\$929	\$978		
	24	42	29½	124	22	VSV2442RSHCR			\$1,474	\$1,624
	24	42	29½	124	22	VST2442LSHCR	\$929	\$978		
	24	42	29½	124	22	VSV2442LSHCR			\$1,474	\$1,624
	24	36	29½	120	19	VST2436RSHCR	\$905	\$952		
	24	36	29½	120	19	VSV2436RSHCR			\$1,431	\$1,573
	24	36	29½	120	19	VST2436LSHCR	\$905	\$952		
	24	36	29½	120	19	VSV2436LSHCR			\$1,431	\$1,573



- use 20" d pedestals with 24" d shells
- top edge profile on user side
- long grain direction
- top grommet available, specify location, and add \$51 list each
- chassis grommet available, specify and add \$49 list
- modular pedestals available; see pages VS126-VS131
- adding modular pedestals could block grommets

To Order, Specify:

① Model Number

Laminate - VST

Veneer - VSV

② Worksurface Material (see page VI3)

a.) TFL

b.) HPL

③ Laminate Color (see page VI3)

a.) Worksurface Color

b.) Chassis Color

c.) Drawer Color

② Wood Species - Cherry (CH1), Maple (MA1)

Walnut (WA1), Black Oak (BO1) or

Double Cut (DC1) (see page VI1)

③ Finish Color (see page VI1)

④ Edge Profile (see page VI4)

⑤ Pull Style and Color (see page VI5)

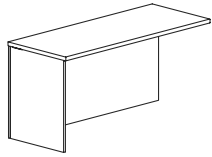
⑥ Optional Grommet Location & Color -
Matte Black (MBK) or Arctic Silver (ASL)
(see page VI6)

⑦ Other Product Options (see page VI10)

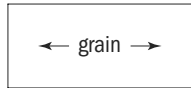
⑧ Accessories (see page VS314)

⑨ Power and Data Options (see page VS324)

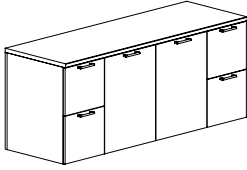
Description	D	W	H	CTN WT	CU FT	① Model	TFL Laminate	HPL Laminate	Flat Cut Veneer	Double Cut Veneer
20" d Shell Corner Return	20	72	29 ½	142	31	VST2072RSHCR	\$1,082	\$1,139		
	20	72	29 ½	142	31	VSV2072RSHCR			\$1,718	\$1,891
	20	72	29 ½	142	31	VST2072LSHCR	\$1,082	\$1,139		
	20	72	29 ½	142	31	VSV2072LSHCR			\$1,718	\$1,891
	20	66	29 ½	138	28	VST2066RSHCR	\$1,006	\$1,060		
	20	66	29 ½	138	28	VSV2066RSHCR			\$1,598	\$1,757
	20	66	29 ½	138	28	VST2066LSHCR	\$1,006	\$1,060		
	20	66	29 ½	138	28	VSV2066LSHCR			\$1,598	\$1,757
	20	60	29 ½	135	26	VST2060RSHCR	\$978	\$1,029		
	20	60	29 ½	135	26	VSV2060RSHCR			\$1,550	\$1,706
	20	60	29 ½	135	26	VST2060LSHCR	\$978	\$1,029		
	20	60	29 ½	135	26	VSV2060LSHCR			\$1,550	\$1,706
	20	54	29 ½	129	23	VST2054RSHCR	\$949	\$998		
	20	54	29 ½	129	23	VSV2054RSHCR			\$1,505	\$1,657
	20	54	29 ½	129	23	VST2054LSHCR	\$949	\$998		
	20	54	29 ½	129	23	VSV2054LSHCR			\$1,505	\$1,657
	20	48	29 ½	125	21	VST2048RSHCR	\$922	\$970		
	20	48	29 ½	125	21	VSV2048RSHCR			\$1,460	\$1,605
	20	48	29 ½	125	21	VST2048LSHCR	\$922	\$970		
	20	48	29 ½	125	21	VSV2048LSHCR			\$1,460	\$1,605
	20	42	29 ½	119	18	VST2042RSHCR	\$892	\$940		
	20	42	29 ½	119	18	VSV2042RSHCR			\$1,415	\$1,558
	20	42	29 ½	119	18	VST2042LSHCR	\$892	\$940		
	20	42	29 ½	119	18	VSV2042LSHCR			\$1,415	\$1,558
	20	36	29 ½	115	16	VST2036RSHCR	\$869	\$915		
	20	36	29 ½	115	16	VSV2036RSHCR			\$1,375	\$1,512
	20	36	29 ½	115	16	VST2036LSHCR	\$869	\$915		
	20	36	29 ½	115	16	VSV2036LSHCR			\$1,375	\$1,512



left shown



- use 18" d pedestals with 20" d shells
- top edge profile on user side
- long grain direction
- top grommet available, specify location, and add \$51 list each
- chassis grommet available, specify and add \$49 list
- modular pedestals available; see pages VS126-VS131
- adding modular pedestals could block grommets

Description	D	W	H	CTN WT	CU FT	① Model	TFL Laminate	HPL Laminate	Flat Cut Veneer	Double Cut Veneer
Storage Credenza 	24	72	29½	309	36	VST2472SC	\$2,344	\$2,471		
	24	72	29½	309	36	VSV2472SC			\$3,672	\$4,054
	24	66	29½	285	33	VST2466SC	\$2,189	\$2,312		
	24	66	29½	285	33	VSV2466SC			\$3,414	\$3,768
	20	72	29½	284	31	VST2072SC	\$2,242	\$2,367		
	20	72	29½	284	31	VSV2072SC			\$3,522	\$3,888
	20	66	29½	255	28	VST2066SC	\$2,098	\$2,214		
	20	66	29½	255	28	VSV2066SC			\$3,274	\$3,616

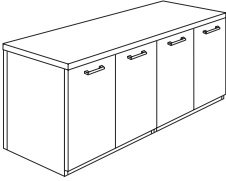
- top edge profile on user side
- top grommet available, specify location, and add \$51 list each
- chassis grommets available, specify and add \$97 list
- file/file pedestals - letter width
- adjustable shelf in storage cabinet
- locking available, specify and add \$207 list

Description	D	W	H	CTN WT	CU FT	① Model	TFL Laminate	HPL Laminate	Flat Cut Veneer	Double Cut Veneer
Lateral File Credenza 	24	72	29½	248	39	VST2472LFC	\$3,141	\$3,314		
	24	72	29½	248	39	VSV2472LFC			\$3,917	\$4,325
	24	60	29½	243	30	VST2460LFC	\$3,010	\$3,177		
	24	60	29½	243	30	VSV2460LFC			\$3,854	\$4,257
	20	72	29½	223	36	VST2072LFC	\$3,010	\$3,176		
	20	72	29½	223	36	VSV2072LFC			\$3,755	\$4,146
	20	60	29½	220	26	VST2060LFC	\$2,884	\$3,044		
	20	60	29½	220	26	VSV2060LFC			\$3,696	\$4,080

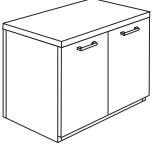
- two drawer lateral files side by side
- top edge profile on user side
- top grommet available, specify location, and add \$51 list each
- chassis grommets available, specify and add \$97 list
- locking available, specify and add \$194 list

To Order, Specify:

① Model Number	Laminate - VST	Veneer - VSV	④ Edge Profile (see page VI4)
	② Worksurface Material (see page VI3) a.) TFL b.) HPL ③ Laminate Color (see page VI3) a.) Worksurface Color b.) Chassis Color c.) Drawer Color	② Wood Species - Cherry (CH1), Maple (MA1) Walnut (WA1), Black Oak (BO1) or Double Cut (DC1) (see page VI1) ③ Finish Color (see page VI1)	⑤ Pull Style and Color (see page VI5) ⑥ Optional Grommet Location & Color - Matte Black (MBK) or Arctic Silver (ASL) (see page VI6) ⑦ Other Product Options (see page VI10) ⑧ Accessories (see page VS314) ⑨ Power and Data Options (see page VS324)

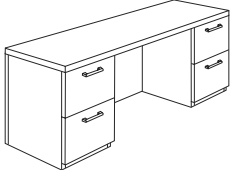
Description	D	W	H	CTN WT	CU FT	① Model	TFL Laminate	HPL Laminate	Flat Cut Veneer	Double Cut Veneer
	24	72	29 ½	293	36	VST2472DSC	\$2,411	\$2,537		
	24	72	29 ½	293	36	VSV2472DSC			\$3,690	\$4,059
	24	60	29 ½	287	30	VST2460DSC	\$2,288	\$2,408		
	24	60	29 ½	287	30	VSV2460DSC			\$3,384	\$3,721
	20	72	29 ½	268	36	VST2072DSC	\$2,315	\$2,437		
	20	72	29 ½	268	36	VSV2072DSC			\$3,541	\$3,895
	20	60	29 ½	266	26	VST2060DSC	\$2,199	\$2,313		
	20	60	29 ½	266	26	VSV2060DSC			\$3,249	\$3,574

- top edge profile on user side
- top grommet available, specify location, and add \$51 list each
- chassis grommets available, specify and add \$97 list
- adjustable shelf in storage cabinets
- locking available, specify and add \$79 list

	24	36	29 ½	133	19	VST2436SC	\$1,411	\$1,485		
	24	36	29 ½	133	19	VSV2436SC			\$1,788	\$1,968
	24	30	29 ½	129	16	VST2430SC	\$1,194	\$1,256		
	24	30	29 ½	129	16	VSV2430SC			\$1,774	\$1,951
	20	36	29 ½	121	16	VST2036SC	\$1,358	\$1,427		
	20	36	29 ½	121	16	VSV2036SC			\$1,719	\$1,894
	20	30	29 ½	119	14	VST2030SC	\$1,146	\$1,207		
	20	30	29 ½	119	14	VSV2030SC			\$1,703	\$1,872

- top edge profile on user side
- top grommet available, specify location, and add \$51 list each
- chassis grommet available, specify and add \$49 list
- one adjustable shelf
- locking available, specify and add \$47 list

VISION

Description	D	W	H	CTN WT	CU FT	① Model	TFL Laminate	HPL Laminate	Flat Cut Veneer	Double Cut Veneer
Kneespace Credenza 	24	84	29 1/2	299	42	VST2484KC	\$2,606	\$2,751		
	24	84	29 1/2	299	42	VSV2484KC			\$3,657	\$4,037
	24	78	29 1/2	280	39	VST2478KC	\$2,452	\$2,588		
	24	78	29 1/2	280	39	VSV2478KC			\$3,558	\$3,928
	24	72	29 1/2	261	36	VST2472KC	\$2,141	\$2,263		
	24	72	29 1/2	261	36	VSV2472KC			\$3,455	\$3,815
	24	66	29 1/2	243	33	VST2466KC	\$1,976	\$2,085		
	24	66	29 1/2	243	33	VSV2466KC			\$3,177	\$3,509
	24	60	29 1/2	231	30	VST2460KC	\$1,940	\$2,044		
	24	60	29 1/2	231	30	VSV2460KC			\$3,095	\$3,419
	20	84	29 1/2	270	36	VST2084KC	\$2,498	\$2,636		
	20	84	29 1/2	270	36	VSV2084KC			\$3,506	\$3,872
	20	78	29 1/2	253	33	VST2078KC	\$2,349	\$2,479		
	20	78	29 1/2	253	33	VSV2078KC			\$3,412	\$3,765
	20	72	29 1/2	236	31	VST2072KC	\$2,052	\$2,167		
	20	72	29 1/2	236	31	VSV2072KC			\$3,312	\$3,657
	20	66	29 1/2	220	28	VST2066KC	\$1,893	\$1,997		
	20	66	29 1/2	220	28	VSV2066KC			\$3,047	\$3,362
	20	60	29 1/2	210	26	VST2060KC	\$1,858	\$1,959		
	20	60	29 1/2	210	26	VSV2060KC			\$2,965	\$3,276

- top edge profile on user side
- top grommet available, specify location, and add \$51 list each
- chassis grommets available, specify and add \$97 list
- file/file pedestals - letter width
- locking available, specify and add \$160 list
- kneespace for VST2484KC and VST2084KC or VSV2484KC and VSV2084KC - 52 5/8"
- kneespace for VST2478KC and VST2078KC or VSV2478KC and VSV2078KC - 46 5/8"
- kneespace for VST2472KC and VST2072KC or VSV2472KC and VSV2072KC - 40 5/8"
- kneespace for VST2466KC and VST2066KC or VSV2466KC and VSV2066KC - 34 5/8"
- kneespace for VST2460KC and VST2060KC or VSV2460KC and VSV2060KC - 28 5/8"
- optional 10" modesty panel available in place of full modesty, add and specify color

To Order, Specify:

① Model Number

Laminate - VST

Veneer - VSV

② Worksurface Material (see page VI3)

a.) TFL

b.) HPL

③ Laminate Color (see page VI3)

a.) Worksurface Color

b.) Chassis Color

c.) Drawer Color

② Wood Species - Cherry (CH1), Maple (MA1)

Walnut (WA1), Black Oak (BO1) or

Double Cut (DC1) (see page VI1)

③ Finish Color (see page VI1)

④ Edge Profile (see page VI4)

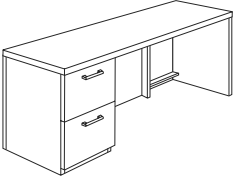
⑤ Pull Style and Color (see page VI5)

⑥ Optional Grommet Location & Color - Matte Black (MBK) or Arctic Silver (ASL) (see page VI6)

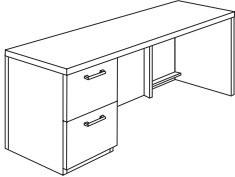
⑦ Other Product Options (see page VI10)

⑧ Accessories (see page VS314)

⑨ Power and Data Options (see page VS324)

Description	D	W	H	CTN WT	CU FT	① Model	TFL Laminate	HPL Laminate	Flat Cut Veneer	Double Cut Veneer
24" d File/File Pedestal Credenza  left shown	24	84	29 1/2	248	42	VST2484RC	\$1,710	\$1,803		
	24	84	29 1/2	248	42	VSV2484RC			\$2,793	\$3,081
	24	84	29 1/2	248	42	VST2484LC	\$1,710	\$1,803		
	24	84	29 1/2	248	42	VSV2484LC			\$2,793	\$3,081
	24	78	29 1/2	237	39	VST2478RC	\$1,642	\$1,732		
	24	78	29 1/2	237	39	VSV2478RC			\$2,685	\$2,959
	24	78	29 1/2	237	39	VST2478LC	\$1,642	\$1,732		
	24	78	29 1/2	237	39	VSV2478LC			\$2,685	\$2,959
	24	72	29 1/2	226	36	VST2472RC	\$1,575	\$1,662		
	24	72	29 1/2	226	36	VSV2472RC			\$2,577	\$2,842
	24	72	29 1/2	226	36	VST2472LC	\$1,575	\$1,662		
	24	72	29 1/2	226	36	VSV2472LC			\$2,577	\$2,842
	24	66	29 1/2	212	33	VST2466RC	\$1,558	\$1,642		
	24	66	29 1/2	212	33	VSV2466RC			\$2,505	\$2,761
	24	66	29 1/2	212	33	VST2466LC	\$1,558	\$1,642		
	24	66	29 1/2	212	33	VSV2466LC			\$2,505	\$2,761
	24	60	29 1/2	179	30	VST2460RC	\$1,539	\$1,625		
	24	60	29 1/2	179	30	VSV2460RC			\$2,470	\$2,723
	24	60	29 1/2	179	30	VST2460LC	\$1,539	\$1,625		
	24	60	29 1/2	179	30	VSV2460LC			\$2,470	\$2,723

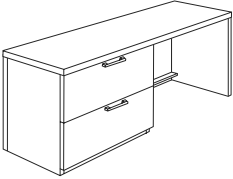
- top edge profile on user side
- top grommet available, specify location, and add \$51 list each
- chassis grommets available, specify and add \$97 list
- letter width pedestal
- locking available, specify and add \$80 list
- optional 10" modesty panel available in place of full modesty, add and specify color

Description	D	W	H	CTN WT	CU FT	① Model	TFL Laminate	HPL Laminate	Flat Cut Veneer	Double Cut Veneer
20" d File/File Pedestal Credenza  left shown	20	84	29½	238	36	VST2084RC	\$1,640	\$1,730		
	20	84	29½	238	36	VSV2084RC			\$2,681	\$2,955
	20	84	29½	238	36	VST2084LC	\$1,640	\$1,730		
	20	84	29½	238	36	VSV2084LC			\$2,681	\$2,955
	20	78	29½	227	33	VST2078RC	\$1,575	\$1,662		
	20	78	29½	227	33	VSV2078RC			\$2,575	\$2,840
	20	78	29½	227	33	VST2078LC	\$1,575	\$1,662		
	20	78	29½	227	33	VSV2078LC			\$2,575	\$2,840
	20	72	29½	216	31	VST2072RC	\$1,511	\$1,593		
	20	72	29½	216	31	VSV2072RC			\$2,473	\$2,728
	20	72	29½	216	31	VST2072LC	\$1,511	\$1,593		
	20	72	29½	216	31	VSV2072LC			\$2,473	\$2,728
	20	66	29½	203	28	VST2066RC	\$1,493	\$1,573		
	20	66	29½	203	28	VSV2066RC			\$2,405	\$2,650
	20	66	29½	203	28	VST2066LC	\$1,493	\$1,573		
	20	66	29½	203	28	VSV2066LC			\$2,405	\$2,650
	20	60	29½	171	26	VST2060RC	\$1,476	\$1,558		
	20	60	29½	171	26	VSV2060RC			\$2,370	\$2,612
	20	60	29½	171	26	VST2060LC	\$1,476	\$1,558		
	20	60	29½	171	26	VSV2060LC			\$2,370	\$2,612

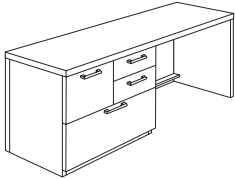
- top edge profile on user side
- top grommet available, specify location, and add \$51 list each
- chassis grommets available, specify and add \$97 list
- letter width pedestal
- locking available, specify and add \$80 list
- optional 10" modesty panel available in place of full modesty, add and specify color

To Order, Specify:

① Model Number	Laminate - VST	Veneer - VSV	
	② Worksurface Material (see page VI3) a.) TFL b.) HPL ③ Laminate Color (see page VI3) a.) Worksurface Color b.) Chassis Color c.) Drawer Color	② Wood Species - Cherry (CH1), Maple (MA1) Walnut (WA1), Black Oak (BO1) or Double Cut (DC1) (see page VI1) ③ Finish Color (see page VI1)	④ Edge Profile (see page VI4) ⑤ Pull Style and Color (see page VI5) ⑥ Optional Grommet Location & Color - Matte Black (MBK) or Arctic Silver (ASL) (see page VI6) ⑦ Other Product Options (see page VI10) ⑧ Accessories (see page VS314) ⑨ Power and Data Options (see page VS324)

Description	D	W	H	CTN WT	CU FT	① Model	TFL Laminate	HPL Laminate	Flat Cut Veneer	Double Cut Veneer
Lateral File Pedestal Credenza  left shown	24	84	29 1/2	256	42	VST2484LRC	\$2,183	\$2,305		
	24	84	29 1/2	256	42	VSV2484LRC			\$3,137	\$3,462
	24	84	29 1/2	256	42	VST2484LLC	\$2,183	\$2,305		
	24	84	29 1/2	256	42	VSV2484LLC			\$3,137	\$3,462
	24	78	29 1/2	244	39	VST2478LRC	\$2,095	\$2,211		
	24	78	29 1/2	244	39	VSV2478LRC			\$3,012	\$3,321
	24	78	29 1/2	244	39	VST2478LLC	\$2,095	\$2,211		
	24	78	29 1/2	244	39	VSV2478LLC			\$3,012	\$3,321
	24	72	29 1/2	232	36	VST2472LRC	\$2,011	\$2,121		
	24	72	29 1/2	232	36	VSV2472LRC			\$2,891	\$3,189
	24	72	29 1/2	232	36	VST2472LLC	\$2,011	\$2,121		
	24	72	29 1/2	232	36	VSV2472LLC			\$2,891	\$3,189
	20	84	29 1/2	245	36	VST2084LRC	\$2,094	\$2,209		
	20	84	29 1/2	245	36	VSV2084LRC			\$3,007	\$3,318
	20	84	29 1/2	245	36	VST2084LLC	\$2,094	\$2,209		
	20	84	29 1/2	245	36	VSV2084LLC			\$3,007	\$3,318
	20	78	29 1/2	233	33	VST2078LRC	\$2,007	\$2,119		
	20	78	29 1/2	233	33	VSV2078LRC			\$2,888	\$3,185
	20	78	29 1/2	233	33	VST2078LLC	\$2,007	\$2,119		
	20	78	29 1/2	233	33	VSV2078LLC			\$2,888	\$3,185
	20	72	29 1/2	221	31	VST2072LRC	\$1,927	\$2,034		
	20	72	29 1/2	221	31	VSV2072LRC			\$2,774	\$3,061
	20	72	29 1/2	221	31	VST2072LLC	\$1,927	\$2,034		
	20	72	29 1/2	221	31	VSV2072LLC			\$2,774	\$3,061

- top edge profile on user side
- top grommet available, specify location, and add \$51 list each
- chassis grommets available, specify and add \$97 list
- 36" w lateral file
- locking available, specify and add \$112 list
- optional 10" modesty panel available in place of full modesty, add and specify color

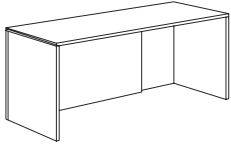
Description	D	W	H	CTN WT	CU FT	① Model	TFL Laminate	HPL Laminate	Flat Cut Veneer	Double Cut Veneer
 <p>left shown</p>	24	84	29½	260	42	VST2484MRC	\$2,299	\$2,421		
	24	84	29½	260	42	VSV2484MRC			\$3,671	\$4,047
	24	84	29½	260	42	VST2484MLC	\$2,299	\$2,421		
	24	84	29½	260	42	VSV2484MLC			\$3,671	\$4,047
	24	78	29½	248	39	VST2478MRC	\$2,205	\$2,324		
	24	78	29½	248	39	VSV2478MRC			\$3,525	\$3,889
	24	78	29½	248	39	VST2478MLC	\$2,205	\$2,324		
	24	78	29½	248	39	VSV2478MLC			\$3,525	\$3,889
	24	72	29½	235	36	VST2472MRC	\$2,115	\$2,232		
	24	72	29½	235	36	VSV2472MRC			\$3,386	\$3,736
	24	72	29½	235	36	VST2472MLC	\$2,115	\$2,232		
	24	72	29½	235	36	VSV2472MLC			\$3,386	\$3,736
	20	84	29½	249	36	VST2084MRC	\$2,204	\$2,323		
	20	84	29½	249	36	VSV2084MRC			\$3,522	\$3,884
	20	84	29½	249	36	VST2084MLC	\$2,204	\$2,323		
	20	84	29½	249	36	VSV2084MLC			\$3,522	\$3,884
	20	78	29½	237	33	VST2078MRC	\$2,114	\$2,228		
	20	78	29½	237	33	VSV2078MRC			\$3,382	\$3,731
	20	78	29½	237	33	VST2078MLC	\$2,114	\$2,228		
	20	78	29½	237	33	VSV2078MLC			\$3,382	\$3,731
	20	72	29½	225	31	VST2072MRC	\$2,028	\$2,139		
	20	72	29½	225	31	VSV2072MRC			\$3,248	\$3,580
	20	72	29½	225	31	VST2072MLC	\$2,028	\$2,139		
	20	72	29½	225	31	VSV2072MLC			\$3,248	\$3,580

- top edge profile on user side
- top grommet available, specify location, and add \$51 list each
- chassis grommets available, specify and add \$97 list
- 30" width multi-file
- locking available, specify and add \$112 list
- optional 10" modesty panel available in place of full modesty, add and specify color

To Order, Specify:

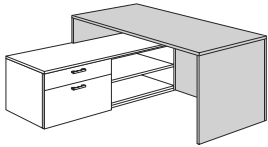
① Model Number	Laminate - VST	Veneer - VSV	
	<p>② Worksurface Material (see page VI3)</p> <p>a.) TFL</p> <p>b.) HPL</p> <p>③ Laminate Color (see page VI3)</p> <p>a.) Worksurface Color</p> <p>b.) Chassis Color</p> <p>c.) Drawer Color</p>	<p>② Wood Species - Cherry (CH1), Maple (MA1) Walnut (WA1), Black Oak (BO1) or Double Cut (DC1) (see page VI1)</p> <p>③ Finish Color (see page VI1)</p>	<p>④ Edge Profile (see page VI4)</p> <p>⑤ Pull Style and Color (see page VI5)</p> <p>⑥ Optional Grommet Location & Color - Matte Black (MBK) or Arctic Silver (ASL) (see page VI6)</p> <p>⑦ Other Product Options (see page VI10)</p> <p>⑧ Accessories (see page VS314)</p> <p>⑨ Power and Data Options (see page VS324)</p>

Description	D	W	H	CTN WT	CU FT	① Model	TFL Laminate	HPL Laminate	Flat Cut Veneer	Double Cut Veneer
Shell Credenza	24	72	29 1/2	159	36	VST2472SHD	\$1,286	\$1,352		
	24	72	29 1/2	159	36	VSV2472SHD			\$2,042	\$2,245
	24	66	29 1/2	153	33	VST2466SHD	\$1,211	\$1,274		
	24	66	29 1/2	153	33	VSV2466SHD			\$1,923	\$2,118



- top edge profile on user side
- top grommet available, specify location, and add \$51 list each
- chassis grommets available, specify and add \$97 list
- modular pedestals available; see pages VS126-VS131
- use 20"d pedestals with 24"d shell
- adding modular pedestals could block grommets

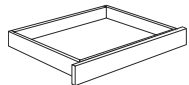
Description	D	W	H	CTN WT	CU FT	① Model	TFL Laminate	HPL Laminate	Flat Cut Veneer	Double Cut Veneer
Bench Height Supported Shell Credenza	24	72	29 1/2	157	36	VSTB2472SHBR	\$1,286	\$1,352		
	24	72	29 1/2	157	36	VSVB2472SHBR			\$2,042	\$2,245
	24	72	29 1/2	157	36	VSTB2472SHBL	\$1,286	\$1,352		
	24	72	29 1/2	157	36	VSVB2472SHBL			\$2,042	\$2,245
	24	66	29 1/2	151	33	VSTB2466SHBR	\$1,211	\$1,274		
	24	66	29 1/2	151	33	VSVB2466SHBR			\$1,923	\$2,118
	24	66	29 1/2	151	33	VSTB2466SHBL	\$1,211	\$1,274		
	24	66	29 1/2	151	33	VSVB2466SHBL			\$1,923	\$2,118



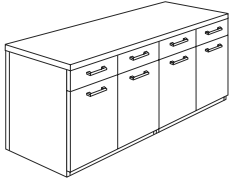
right shown

- must be attached to bench height cabinet & top, see pages VS132-VS134
- top grommet available, specify location, and add \$51 list each
- chassis grommet available specify and add \$49 list
- long grain direction for 66" and 72" w laminate worksurface
- edge profile on user side


Description	D	W	H	CTN WT	CU FT	① Model	Laminate	Flat Cut Veneer	Double Cut Veneer
Center Drawer	17 1/4	27	2 1/2	12	2	VST1825CD	\$387		
	17 1/4	27	2 1/2	12	2	VSV1825CD		\$406	\$457



- use on all 24"d returns, bridges or credenzas with the exception of a lateral file or multi-file
- use on all 20"d returns, bridges or credenzas with the exception of a lateral file or multi-file without a center grommet
- interior dimensions 22 3/4" w x 15 1/2" d x 2 1/8" h
- drawer front 27" w
- field installed
- locking not available
- mounts to bottom of worksurface
- available on any double or single pedestal desk, not available on height adjustable, cockpit or peninsula desks

Description	D	W	H	CTN WT	CU FT	① Model	TFL Laminate	HPL Laminate	Flat Cut Veneer	Double Cut Veneer
	24	72	35 1/2	316	43	VST2472BSC	\$2,918	\$3,073		
	24	72	35 1/2	316	43	VSV2472BSC			\$4,923	\$5,417
	20	72	35 1/2	291	31	VST2072BSC	\$2,803	\$2,950		
	20	72	35 1/2	291	31	VSV2072BSC			\$4,728	\$5,200

- four door credenza
- four box drawers above doors
- top edge profile on user side
- top grommet available, specify location, and add \$51 list each
- chassis grommets available, specify and add \$97 list
- adjustable shelf in storage cabinets
- locking not available

	24	36	35 1/2	167	22	VST2436BSC	\$1,935	\$2,035		
	24	36	35 1/2	167	22	VSV2436BSC			\$3,530	\$3,882
	20	36	35 1/2	155	16	VST2036BSC	\$1,858	\$1,954		
	20	36	35 1/2	155	16	VSV2036BSC			\$3,389	\$3,727

- two door credenza
- two box drawers above doors
- top edge profile on user side
- top grommet available, specify location, and add \$51 list each
- chassis grommets available, specify and add \$97 list
- adjustable shelf in storage cabinet
- locking not available

To Order, Specify:

① Model Number

Laminate - VST

Veneer - VSV

② Worksurface Material (see page VI3)

a.) TFL

b.) HPL

③ Laminate Color (see page VI3)

a.) Worksurface Color

b.) Chassis Color

c.) Drawer Color

② Wood Species - Cherry (CH1), Maple (MA1)

Walnut (WA1), Black Oak (BO1) or

Double Cut (DC1) (see page VI1)

③ Finish Color (see page VI1)

④ Edge Profile (see page VI4)

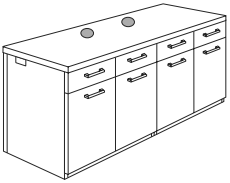
⑤ Pull Style and Color (see page VI5)

⑥ Optional Grommet Location & Color -
Matte Black (MBK) or Arctic Silver (ASL)
(see page VI6)

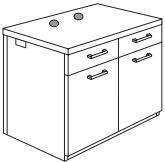
⑦ Other Product Options (see page VI10)

⑧ Accessories (see page VS314)

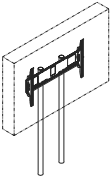
⑨ Power and Data Options (see page VS324)

Description	D	W	H	CTN WT	CU FT	① Model	TFL Laminate	HPL Laminate	Flat Cut Veneer	Double Cut Veneer
Buffet Credenza - Flat Screen Support 	24	72	35 1/2	316	43	VST2472BSCT	\$3,425	\$3,532		
	24	72	35 1/2	316	43	VSV2472BSCT			\$5,526	\$6,080
	20	72	35 1/2	291	31	VST2072BSCT	\$3,309	\$3,412		
	20	72	35 1/2	291	31	VSV2072BSCT			\$5,329	\$5,862

- four door credenza
- four box drawers above doors
- top edge profile on user side
- chassis grommet available, specify and add \$97 list
- adjustable shelf in storage cabinets
- locking doors and drawers not available
- flat screen mounting grommets in top
- back panel includes cord exit grommets
- flat screen mounting frame sold separately, see below

Buffet Credenza - Flat Screen Support 	24	36	35 1/2	167	22	VST2436BSCT	\$2,419	\$2,494		
	24	36	35 1/2	167	22	VSV2436BSCT			\$4,130	\$4,543
	20	36	35 1/2	155	16	VST2036BSCT	\$2,343	\$2,414		
	20	36	35 1/2	155	16	VSV2036BSCT			\$3,991	\$4,390

- two door credenza
- two box drawers above doors
- top edge profile on user side
- chassis grommet available, specify and add \$97 list
- adjustable shelf in storage cabinet
- locking doors and drawers not available
- flat screen mounting grommets in top
- back panel includes cord exit grommets
- flat screen mounting frame sold separately, see below

Description	D	W	H	CTN WT	CU FT	① Model	List Price
Flat Screen Mounting Frame 	2	14	55	35	4	FSTV	\$1,716

- round 2" tube frame with cable management to inside of credenza
- mounting bracket for TV provided
- available in black (B) or silver (S)
- TV not included
- TV dimension not to exceed 70"w x 38"h to allow proper mounting clearance.
- coordinates with VST2472BSCT and VST2436BSCT

Description	D	W	H	CTN WT	CU FT	① Model	TFL Laminate	HPL Laminate	Flat Cut Veneer	Double Cut Veneer
Modular Bow Front Desk Top	42	72	1 3/16	130	12	VST4272BMCT	\$841	\$968		
	42	72	1 3/16	130	12	VSV4272BMCT			\$1,747	\$1,922
	36	72	1 3/16	110	9	VST3672BMCT	\$757	\$872		
	36	72	1 3/16	110	9	VSV3672BMCT			\$1,572	\$1,730



- top edge profile on user and approach sides
- top grommet available, specify location, and add \$51 list each
- long grain direction

To Order, Specify:

① Model Number

Laminate - VST

Veneer - VSV

② Worksurface Material (see page VI3)

a.) TFL

b.) HPL

③ Laminate Color (see page VI3)

a.) Worksurface Color

b.) Chassis Color

c.) Drawer Color

② Wood Species - Cherry (CH1), Maple (MA1)

Walnut (WA1), Black Oak (BO1) or

Double Cut (DC1) (see page VI1)

③ Finish Color (see page VI1)

④ Edge Profile (see page VI4)

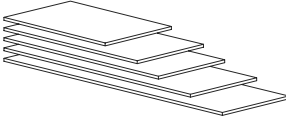
⑤ Pull Style and Color (see page VI5)

⑥ Optional Grommet Location & Color -
Matte Black (MBK) or Arctic Silver (ASL)
(see page VI6)


⑦ Other Product Options (see page VI10)

⑧ Accessories (see page VS314)

⑨ Power and Data Options (see page VS324)

Description	D	W	H	CTN WT	CU FT	① Model	TFL Laminate	HPL Laminate	Flat Cut Veneer	Double Cut Veneer
Modular Rectangular Desk Top 	36	84	1 3/16	137	11	VST3684MCT	\$841	\$968		
	36	84	1 3/16	137	11	VSV3684MCT			\$1,747	\$1,922
	36	78	1 3/16	127	10	VST3678MCT	\$757	\$872		
	36	78	1 3/16	127	10	VSV3678MCT			\$1,572	\$1,730
	36	72	1 3/16	117	9	VST3672MCT	\$627	\$898		
	36	72	1 3/16	117	9	VSV3672MCT			\$1,365	\$1,502
	36	66	1 3/16	108	9	VST3666MCT	\$589	\$790		
	36	66	1 3/16	108	9	VSV3666MCT			\$1,252	\$1,378
	30	84	1 3/16	116	10	VST3084MCT	\$652	\$889		
	30	84	1 3/16	116	10	VSV3084MCT			\$1,389	\$1,530
	30	78	1 3/16	107	9	VST3078MCT	\$606	\$837		
	30	78	1 3/16	107	9	VSV3078MCT			\$1,293	\$1,422
	30	72	1 3/16	98	8	VST3072MCT	\$559	\$774		
	30	72	1 3/16	98	8	VSV3072MCT			\$1,195	\$1,315
	30	66	1 3/16	90	7	VST3066MCT	\$512	\$677		
	30	66	1 3/16	90	7	VSV3066MCT			\$1,097	\$1,207
	30	60	1 3/16	82	7	VST3060MCT	\$471	\$604		
	30	60	1 3/16	82	7	VSV3060MCT			\$997	\$1,097
	30	54	1 3/16	74	6	VST3054MCT	\$426	\$550		
	30	54	1 3/16	74	6	VSV3054MCT			\$897	\$987
	30	48	1 3/16	65	5	VST3048MCT	\$381	\$492		
	30	48	1 3/16	65	5	VSV3048MCT			\$798	\$877
	30	42	1 3/16	57	4	VST3042MCT	\$336	\$437		
	30	42	1 3/16	57	4	VSV3042MCT			\$697	\$766

- top edge profile on user and approach sides
- top grommet available, specify location, and add \$51 list each
- long grain direction

Description	D	W	H	CTN WT	CU FT	① Model	TFL Laminate	HPL Laminate	Flat Cut Veneer	Double Cut Veneer
Modular Soft Rectangular Desk Top 	36	84	1 3/16	111	8	VST3684RRDT	\$937	\$1,068		
	36	84	1 3/16	111	8	VSV3684RRDT			\$1,848	\$2,032
	36	78	1 3/16	102	8	VST3678RRDT	\$872	\$992		
	36	78	1 3/16	102	8	VSV3678RRDT			\$1,717	\$1,890
	36	72	1 3/16	94	7	VST3672RRDT	\$804	\$915		
	36	72	1 3/16	94	7	VSV3672RRDT			\$1,583	\$1,743
	36	66	1 3/16	86	6	VST3666RRDT	\$737	\$840		
	36	66	1 3/16	86	6	VSV3666RRDT			\$1,452	\$1,598
	36	60	1 3/16	77	6	VST3660RRDT	\$670	\$763		
	36	60	1 3/16	77	6	VSV3660RRDT			\$1,321	\$1,452
	30	84	1 3/16	92	7	VST3084RRDT	\$782	\$890		
	30	84	1 3/16	92	7	VSV3084RRDT			\$1,541	\$1,696
	30	78	1 3/16	85	6	VST3078RRDT	\$726	\$828		
	30	78	1 3/16	85	6	VSV3078RRDT			\$1,430	\$1,574
	30	72	1 3/16	78	6	VST3072RRDT	\$670	\$763		
	30	72	1 3/16	78	6	VSV3072RRDT			\$1,321	\$1,452
	30	66	1 3/16	71	6	VST3066RRDT	\$614	\$701		
	30	66	1 3/16	71	6	VSV3066RRDT			\$1,211	\$1,333
	30	60	1 3/16	64	5	VST3060RRDT	\$559	\$637		
	30	60	1 3/16	64	5	VSV3060RRDT			\$1,101	\$1,212

- top edge profile on user and approach sides
- top grommet available, specify location, and add \$51 list each
- long grain direction

To Order, Specify:

① Model Number

Laminate - VST

Veneer - VSV

② Worksurface Material (see page VI3)

a.) TFL

b.) HPL

③ Laminate Color (see page VI3)

a.) Worksurface Color

b.) Chassis Color

c.) Drawer Color

② Wood Species - Cherry (CH1), Maple (MA1)

Walnut (WA1), Black Oak (BO1) or

Double Cut (DC1) (see page VI1)

③ Finish Color (see page VI1)

④ Edge Profile (see page VI4)

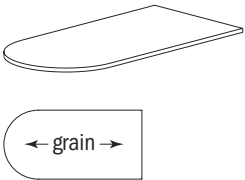
⑤ Pull Style and Color (see page VI5)

⑥ Optional Grommet Location & Color -
Matte Black (MBK) or Arctic Silver (ASL)
(see page VI6)

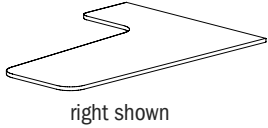
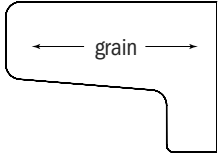
⑦ Other Product Options (see page VI10)

⑧ Accessories (see page VS314)

⑨ Power and Data Options (see page VS324)

Description	D	W	H	CTN WT	CU FT	① Model	TFL Laminate	HPL Laminate	Flat Cut Veneer	Double Cut Veneer
Modular Bullet Desk Top 	36	84	1 3/16	137	12	VST3684MBULT	\$892	\$1,016		
	36	84	1 3/16	137	12	VSV3684MBULT			\$1,759	\$1,933
	36	78	1 3/16	127	11	VST3678MBULT	\$829	\$943		
	36	78	1 3/16	127	11	VSV3678MBULT			\$1,634	\$1,794
	36	72	1 3/16	117	10	VST3672MBULT	\$765	\$872		
	36	72	1 3/16	117	10	VSV3672MBULT			\$1,508	\$1,657
	30	72	1 3/16	98	9	VST3072MBULT	\$638	\$726		
	30	72	1 3/16	98	9	VSV3072MBULT			\$1,257	\$1,381
	30	66	1 3/16	90	8	VST3066MBULT	\$586	\$667		
	30	66	1 3/16	90	8	VSV3066MBULT			\$1,153	\$1,266
	24	60	1 3/16	65	6	VST2460MBULT	\$426	\$484		
	24	60	1 3/16	65	6	VSV2460MBULT			\$839	\$921
	24	48	1 3/16	52	5	VST2448MBULT	\$341	\$389		
	24	48	1 3/16	52	5	VSV2448MBULT			\$671	\$737

- top edge profile on three open sides
 - top grommet available, specify location, and add \$51 list each
 - long grain direction
 - supports located on pages VS161-VS163
- Note: truss base not compatible with models wider than 72"

Description	D	W	H	CTN WT	CU FT	① Model	TFL Laminate	HPL Laminate	Flat Cut Veneer	Double Cut Veneer
Modular Sweeping L Desk Top	60	84	1 3/16	118	13	VST6084SWPRT	\$1,561	\$1,778		
	60	84	1 3/16	118	13	VSV6084SWPRT			\$3,078	\$3,385
	60	84	1 3/16	118	13	VST6084SWPLT	\$1,561	\$1,778		
	60	84	1 3/16	118	13	VSV6084SWPLT			\$3,078	\$3,385
	60	78	1 3/16	111	12	VST6078SWPRT	\$1,450	\$1,651		
	60	78	1 3/16	111	12	VSV6078SWPRT			\$2,859	\$3,145
	60	78	1 3/16	111	12	VST6078SWPLT	\$1,450	\$1,651		
	60	78	1 3/16	111	12	VSV6078SWPLT			\$2,859	\$3,145
	60	72	1 3/16	104	11	VST6072SWPRT	\$1,338	\$1,525		
	60	72	1 3/16	104	11	VSV6072SWPRT			\$2,639	\$2,902
	60	72	1 3/16	104	11	VST6072SWPLT	\$1,338	\$1,525		
	60	72	1 3/16	104	11	VSV6072SWPLT			\$2,639	\$2,902
	60	66	1 3/16	97	10	VST6066SWPRT	\$1,227	\$1,399		
	60	66	1 3/16	97	10	VSV6066SWPRT			\$2,418	\$2,662
	60	66	1 3/16	97	10	VST6066SWPLT	\$1,227	\$1,399		
	60	66	1 3/16	97	10	VSV6066SWPLT			\$2,418	\$2,662
	60	60	1 3/16	90	9	VST6060SWPRT	\$1,115	\$1,271		
	60	60	1 3/16	90	9	VSV6060SWPRT			\$2,199	\$2,418
	60	60	1 3/16	90	9	VST6060SWPLT	\$1,115	\$1,271		
	60	60	1 3/16	90	9	VSV6060SWPLT			\$2,199	\$2,418

- top does not attach to other tops
- top grommet available, specify location, and add \$51 list each

To Order, Specify:

① Model Number

Laminate - VST

Veneer - VSV

② Worksurface Material (see page VI3)

- a.) TFL
- b.) HPL

③ Laminate Color (see page VI3)

- a.) Worksurface Color
- b.) Chassis Color
- c.) Drawer Color

② Wood Species - Cherry (CH1), Maple (MA1)

- Walnut (WA1), Black Oak (BO1) or Double Cut (DC1) (see page VI1)

③ Finish Color (see page VI1)

④ Edge Profile (see page VI4)

⑤ Pull Style and Color (see page VI5)

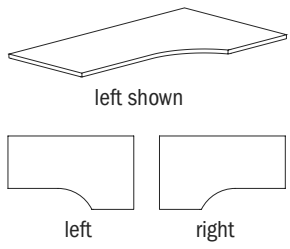
⑥ Optional Grommet Location & Color - Matte Black (MBK) or Arctic Silver (ASL) (see page VI6)

⑦ Other Product Options (see page VI10)


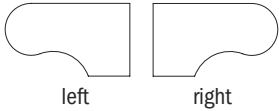
⑧ Accessories (see page VS314)

⑨ Power and Data Options (see page VS324)

Description	D	W	H	CTN WT	CU FT	① Model	TFL Laminate	HPL Laminate	Flat Cut Veneer	Double Cut Veneer
Modular Extended Corner Desk Top	48	72	1 3/16	130	13	VST4872MCDT24R	\$1,020	\$1,162		
	48	72	1 3/16	130	13	VSV4872MCDT24R			\$2,009	\$2,207
	48	72	1 3/16	130	13	VST4872MCDT24L	\$1,020	\$1,162		
	48	72	1 3/16	130	13	VSV4872MCDT24L			\$2,009	\$2,207
	42	72	1 3/16	111	12	VST4272MCDT24R	\$892	\$1,016		
	42	72	1 3/16	111	12	VSV4272MCDT24R			\$1,759	\$1,933
	42	72	1 3/16	111	12	VST4272MCDT24L	\$892	\$1,016		
	42	72	1 3/16	111	12	VSV4272MCDT24L			\$1,759	\$1,933
	48	66	1 3/16	120	12	VST4866MCDT24R	\$935	\$1,064		
	48	66	1 3/16	120	12	VSV4866MCDT24R			\$1,842	\$2,024
	48	66	1 3/16	120	12	VST4866MCDT24L	\$935	\$1,064		
	48	66	1 3/16	120	12	VSV4866MCDT24L			\$1,842	\$2,024
	42	66	1 3/16	103	11	VST4266MCDT24R	\$818	\$933		
	42	66	1 3/16	103	11	VSV4266MCDT24R			\$1,613	\$1,772
	42	66	1 3/16	103	11	VST4266MCDT24L	\$818	\$933		
	42	66	1 3/16	103	11	VSV4266MCDT24L			\$1,613	\$1,772



- top edge profile on three open sides
- top grommet available, specify location, and add \$51 list each
- long grain direction
- supports located on pages VS161-VS163

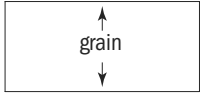
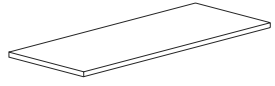
Description	D	W	H	CTN WT	CU FT	① Model	TFL Laminate	HPL Laminate	Flat Cut Veneer	Double Cut Veneer
Modular Extended Corner Bullet Desk Top  left shown  left right	48	72	1 3/16	130	13	VST4872MCBT24R	\$1,020	\$1,162		
	48	72	1 3/16	130	13	VSV4872MCBT24R			\$2,009	\$2,207
	48	72	1 3/16	130	13	VST4872MCBT24L	\$1,020	\$1,162		
	48	72	1 3/16	130	13	VSV4872MCBT24L			\$2,009	\$2,207
	42	72	1 3/16	111	12	VST4272MCBT24R	\$892	\$1,016		
	42	72	1 3/16	111	12	VSV4272MCBT24R			\$1,759	\$1,933
	42	72	1 3/16	111	12	VST4272MCBT24L	\$892	\$1,016		
	42	72	1 3/16	111	12	VSV4272MCBT24L			\$1,759	\$1,933
	42	66	1 3/16	103	11	VST4266MCBT24R	\$818	\$933		
	42	66	1 3/16	103	11	VSV4266MCBT24R			\$1,613	\$1,772
	42	66	1 3/16	103	11	VST4266MCBT24L	\$818	\$933		
	42	66	1 3/16	103	11	VSV4266MCBT24L			\$1,613	\$1,772

- top edge profile on three open sides
- top grommet available, specify location, and add \$51 list each
- long grain direction
- supports located on pages VS161-VS163

To Order, Specify:

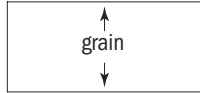
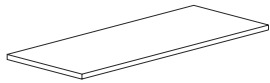
① Model Number	Laminate - VST	Veneer - VSV	
	② Worksurface Material (see page VI3) a.) TFL b.) HPL ③ Laminate Color (see page VI3) a.) Worksurface Color b.) Chassis Color c.) Drawer Color	② Wood Species - Cherry (CH1), Maple (MA1) Walnut (WA1), Black Oak (BO1) or Double Cut (DC1) (see page VI1) ③ Finish Color (see page VI1)	④ Edge Profile (see page VI4) ⑤ Pull Style and Color (see page VI5) ⑥ Optional Grommet Location & Color - Matte Black (MBK) or Arctic Silver (ASL) (see page VI6) ⑦ Other Product Options (see page VI10) ⑧ Accessories (see page VS314) ⑨ Power and Data Options (see page VS324)

Description	D	W	H	CTN WT	CU FT	① Model	TFL Laminate	HPL Laminate	Flat Cut Veneer	Double Cut Veneer
24" d Modular Return/Bridge Top	24	84	1 3/16	91	8	VST8424MCT	\$528	\$680		
	24	84	1 3/16	91	8	VSV8424MCT			\$1,025	\$1,128
	24	78	1 3/16	85	7	VST7824MCT	\$491	\$633		
	24	78	1 3/16	85	7	VSV7824MCT			\$970	\$1,066
	24	72	1 3/16	79	6	VST7224MCT	\$455	\$584		
	24	72	1 3/16	79	6	VSV7224MCT			\$868	\$955
	24	66	1 3/16	73	5	VST6624MCT	\$418	\$536		
	24	66	1 3/16	73	5	VSV6624MCT			\$830	\$914
	24	36	1 3/16	65	6	VST6024MCT	\$380	\$487		
	24	60	1 3/16	65	6	VSV6024MCT			\$756	\$831
	24	54	1 3/16	59	6	VST5424MCT	\$343	\$440		
	24	54	1 3/16	59	6	VSV5424MCT			\$743	\$817
	24	48	1 3/16	52	5	VST4824MCT	\$319	\$403		
	24	48	1 3/16	52	5	VSV4824MCT			\$603	\$663
	24	42	1 3/16	46	4	VST4224MCT	\$301	\$383		
	24	42	1 3/16	46	4	VSV4224MCT			\$548	\$603
	24	36	1 3/16	39	4	VST3624MCT	\$281	\$363		
	24	36	1 3/16	39	4	VSV3624MCT			\$491	\$542



- top edge profile on user side
- top grommet available, specify location, and add \$51 list each
- short grain direction
- laminate 66" - 84" will have grain running the width

Description	D	W	H	CTN WT	CU FT	① Model	TFL Laminate	HPL Laminate	Flat Cut Veneer	Double Cut Veneer
20" d Modular Return/Bridge Top	20	84	1 3/16	76	7	VST8420MCT	\$468	\$627		
	20	84	1 3/16	76	7	VSV8420MCT			\$934	\$1,028
	20	78	1 3/16	71	6	VST7820MCT	\$436	\$584		
	20	78	1 3/16	71	6	VSV7820MCT			\$871	\$958
	20	72	1 3/16	65	6	VST7220MCT	\$402	\$539		
	20	72	1 3/16	65	6	VSV7220MCT			\$802	\$883
	20	66	1 3/16	59	5	VST6620MCT	\$369	\$492		
	20	66	1 3/16	59	5	VSV6620MCT			\$735	\$809
	20	60	1 3/16	55	5	VST6020MCT	\$336	\$447		
	20	60	1 3/16	55	5	VSV6020MCT			\$669	\$736
	20	54	1 3/16	49	5	VST5420MCT	\$305	\$405		
	20	54	1 3/16	49	5	VSV5420MCT			\$605	\$667
	20	48	1 3/16	44	4	VST4820MCT	\$281	\$387		
	20	48	1 3/16	44	4	VSV4820MCT			\$568	\$627
	20	42	1 3/16	38	4	VST4220MCT	\$267	\$353		
	20	42	1 3/16	38	4	VSV4220MCT			\$518	\$569
	20	36	1 3/16	33	3	VST3620MCT	\$249	\$335		
	20	36	1 3/16	33	3	VSV3620MCT			\$491	\$542



- top edge profile on user side
- top grommet available, specify location, and add \$51 list each
- short grain direction
- laminate 66" - 84" will have grain running the width

To Order, Specify:

① Model Number

Laminate - VST

Veneer - VSV

② Worksurface Material (see page VI3)

- a.) TFL
- b.) HPL

③ Laminate Color (see page VI3)

- a.) Worksurface Color
- b.) Chassis Color
- c.) Drawer Color

② Wood Species - Cherry (CH1), Maple (MA1)

- Walnut (WA1), Black Oak (BO1) or Double Cut (DC1) (see page VI1)

③ Finish Color (see page VI1)

④ Edge Profile (see page VI4)

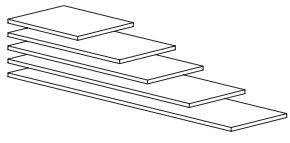
⑤ Pull Style and Color (see page VI5)

⑥ Optional Grommet Location & Color - Matte Black (MBK) or Arctic Silver (ASL) (see page VI6)

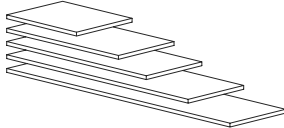
⑦ Other Product Options (see page VI10)

⑧ Accessories (see page VS314)

⑨ Power and Data Options (see page VS324)

Description	D	W	H	CTN WT	CU FT	① Model	TFL Laminate	HPL Laminate	Flat Cut Veneer	Double Cut Veneer
24" d Modular Credenza Top 	24	108	1 3/16	117	10	VST24108MCT	\$719	\$914		
	24	108	1 3/16	117	10	VSV24108MCT			\$1,384	\$1,524
	24	102	1 3/16	111	10	VST24102MCT	\$681	\$866		
	24	102	1 3/16	111	10	VSV24102MCT			\$1,310	\$1,442
	24	96	1 3/16	104	9	VST2496MCT	\$640	\$812		
	24	96	1 3/16	104	9	VSV2496MCT			\$1,232	\$1,356
	24	90	1 3/16	98	9	VST2490MCT	\$577	\$731		
	24	90	1 3/16	98	9	VSV2490MCT			\$1,109	\$1,219
	24	84	1 3/16	91	8	VST2484MCT	\$528	\$680		
	24	84	1 3/16	91	8	VSV2484MCT			\$1,025	\$1,128
	24	78	1 3/16	85	8	VST2478MCT	\$491	\$633		
	24	78	1 3/16	85	8	VSV2478MCT			\$970	\$1,066
	24	72	1 3/16	78	7	VST2472MCT	\$455	\$584		
	24	72	1 3/16	78	7	VSV2472MCT			\$868	\$955
	24	66	1 3/16	72	7	VST2466MCT	\$418	\$536		
	24	66	1 3/16	72	7	VSV2466MCT			\$830	\$914
	24	60	1 3/16	65	6	VST2460MCT	\$380	\$487		
	24	60	1 3/16	65	6	VSV2460MCT			\$756	\$831
	24	54	1 3/16	59	6	VST2454MCT	\$343	\$440		
	24	54	1 3/16	59	6	VSV2454MCT			\$743	\$817
	24	48	1 3/16	52	5	VST2448MCT	\$319	\$403		
	24	48	1 3/16	52	5	VSV2448MCT			\$603	\$663
	24	42	1 3/16	46	4	VST2442MCT	\$309	\$393		
	24	42	1 3/16	46	4	VSV2442MCT			\$576	\$633
	24	36	1 3/16	39	4	VST2436MCT	\$301	\$383		
	24	36	1 3/16	39	4	VSV2436MCT			\$548	\$603
	24	30	1 3/16	33	3	VST2430MCT	\$281	\$363		
	24	30	1 3/16	33	3	VSV2430MCT			\$491	\$542

- top edge profile on user side
- top grommet available, specify location, and add \$51 list each
- long grain direction

Description	D	W	H	CTN WT	CU FT	① Model	TFL Laminate	HPL Laminate	Flat Cut Veneer	Double Cut Veneer
	20	108	1 3/16	98	9	VST20108MCT	\$637	\$842		
	20	108	1 3/16	98	9	VSV20108MCT			\$1,256	\$1,382
	20	102	1 3/16	93	8	VST20102MCT	\$604	\$798		
	20	102	1 3/16	93	8	VSV20102MCT			\$1,188	\$1,307
	20	96	1 3/16	87	8	VST2096MCT	\$567	\$749		
	20	96	1 3/16	87	8	VSV2096MCT			\$1,117	\$1,228
	20	90	1 3/16	82	8	VST2090MCT	\$511	\$674		
	20	90	1 3/16	82	8	VSV2090MCT			\$1,004	\$1,106
	20	84	1 3/16	76	7	VST2084MCT	\$468	\$627		
	20	84	1 3/16	76	7	VSV2084MCT			\$934	\$1,028
	20	78	1 3/16	71	7	VST2078MCT	\$436	\$584		
	20	78	1 3/16	71	7	VSV2078MCT			\$871	\$958
	20	72	1 3/16	65	6	VST2072MCT	\$402	\$539		
	20	72	1 3/16	65	6	VSV2072MCT			\$802	\$883
	20	66	1 3/16	60	6	VST2066MCT	\$369	\$492		
	20	66	1 3/16	60	6	VSV2066MCT			\$735	\$809
	20	60	1 3/16	55	5	VST2060MCT	\$336	\$447		
	20	60	1 3/16	55	5	VSV2060MCT			\$669	\$736
	20	54	1 3/16	49	5	VST2054MCT	\$305	\$405		
	20	54	1 3/16	49	5	VSV2054MCT			\$605	\$667
	20	48	1 3/16	44	4	VST2048MCT	\$281	\$387		
	20	48	1 3/16	44	4	VSV2048MCT			\$568	\$627
	20	42	1 3/16	38	4	VST2042MCT	\$273	\$373		
	20	42	1 3/16	38	4	VSV2042MCT			\$544	\$598
	20	36	1 3/16	33	3	VST2036MCT	\$267	\$353		
	20	36	1 3/16	33	3	VSV2036MCT			\$518	\$569
	20	30	1 3/16	28	3	VST2030MCT	\$249	\$335		
	20	30	1 3/16	28	3	VSV2030MCT			\$491	\$542

- top edge profile on user side
- top grommet available, specify location, and add \$51 list each
- long grain direction

To Order, Specify:

① Model Number

Laminate - VST

Veneer - VSV

② Worksurface Material (see page VI3)

a.) TFL

b.) HPL

③ Laminate Color (see page VI3)

a.) Worksurface Color

b.) Chassis Color

c.) Drawer Color

② Wood Species - Cherry (CH1), Maple (MA1)

Walnut (WA1), Black Oak (BO1) or

Double Cut (DC1) (see page VI1)

③ Finish Color (see page VI1)

④ Edge Profile (see page VI4)


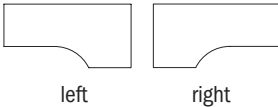
⑤ Pull Style and Color (see page VI5)

⑥ Optional Grommet Location & Color - Matte Black (MBK) or Arctic Silver (ASL) (see page VI6)

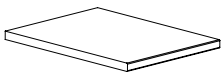

⑦ Other Product Options (see page VI10)

⑧ Accessories (see page VS314)

⑨ Power and Data Options (see page VS324)

Description	D	W	H	CTN WT	CU FT	① Model	TFL Laminate	HPL Laminate	Flat Cut Veneer	Double Cut Veneer
Modular Extended Corner Credenza Top	36	96	1 3/16	117	13	VST3696MCCT24R	\$1,020	\$1,162		
	36	96	1 3/16	117	13	VSV3696MCCT24R			\$2,009	\$2,207
 left shown	36	96	1 3/16	117	13	VST3696MCCT24L	\$1,020	\$1,162		
	36	96	1 3/16	117	13	VSV3696MCCT24L			\$2,009	\$2,207
 left right	36	90	1 3/16	111	13	VST3690MCCT24R	\$956	\$1,089		
	36	90	1 3/16	111	13	VSV3690MCCT24R			\$1,884	\$2,070
	36	90	1 3/16	111	13	VST3690MCCT24L	\$956	\$1,089		
	36	90	1 3/16	111	13	VSV3690MCCT24L			\$1,884	\$2,070
	36	84	1 3/16	104	12	VST3684MCCT24R	\$892	\$1,016		
	36	84	1 3/16	104	12	VSV3684MCCT24R			\$1,759	\$1,933
	36	84	1 3/16	104	12	VST3684MCCT24L	\$892	\$1,016		
	36	84	1 3/16	104	12	VSV3684MCCT24L			\$1,759	\$1,933
	36	72	1 3/16	91	10	VST3672MCCT24R	\$765	\$872		
	36	72	1 3/16	91	10	VSV3672MCCT24R			\$1,508	\$1,657
	36	72	1 3/16	91	10	VST3672MCCT24L	\$765	\$872		
	36	72	1 3/16	91	10	VSV3672MCCT24L			\$1,508	\$1,657
	36	66	1 3/16	85	9	VST3666MCCT24R	\$702	\$800		
	36	66	1 3/16	85	9	VSV3666MCCT24R			\$1,383	\$1,519
	36	66	1 3/16	85	9	VST3666MCCT24L	\$702	\$800		
	36	66	1 3/16	85	9	VSV3666MCCT24L			\$1,383	\$1,519
	36	60	1 3/16	78	9	VST3660MCCT24R	\$638	\$726		
	36	60	1 3/16	78	9	VSV3660MCCT24R			\$1,257	\$1,381
	36	60	1 3/16	78	9	VST3660MCCT24L	\$638	\$726		
	36	60	1 3/16	78	9	VSV3660MCCT24L			\$1,257	\$1,381
	36	54	1 3/16	71	8	VST3654MCCT24R	\$574	\$654		
	36	54	1 3/16	71	8	VSV3654MCCT24R			\$1,132	\$1,242
	36	54	1 3/16	71	8	VST3654MCCT24L	\$574	\$654		
	36	54	1 3/16	71	8	VSV3654MCCT24L			\$1,132	\$1,242

- top edge profile on user side
- top grommet available, specify location, and add \$51 list each
- long grain direction

Description	D	W	H	CTN WT	CU FT	① Model	TFL Laminate	HPL Laminate	Flat Cut Veneer	Double Cut Veneer
Modular Pedestal Top  	24	18 1/8	1 3/16	20	2	VST2418MCT	\$249	\$328		
	24	18 1/8	1 3/16	20	2	VSV2418MCT			\$427	\$470
	24	15 3/4	1 3/16	18	2	VST2416MCT	\$243	\$319		
	24	15 3/4	1 3/16	18	2	VSV2416MCT			\$420	\$463
	20	18 1/8	1 3/16	18	2	VST2018MCT	\$223	\$305		
	20	18 1/8	1 3/16	18	2	VSV2018MCT			\$420	\$463
	20	15 3/4	1 3/16	16	2	VST2016MCT	\$218	\$296		
	20	15 3/4	1 3/16	16	2	VSV2016MCT			\$414	\$455

· short grain direction

To Order, Specify:

① Model Number

Laminate - VST

Veneer - VSV

② Worksurface Material (see page VI3)

a.) TFL

b.) HPL

③ Laminate Color (see page VI3)

a.) Worksurface Color

b.) Chassis Color

c.) Drawer Color

② Wood Species - Cherry (CH1), Maple (MA1)

Walnut (WA1), Black Oak (BO1) or

Double Cut (DC1) (see page VI1)

③ Finish Color (see page VI1)

④ Edge Profile (see page VI4)

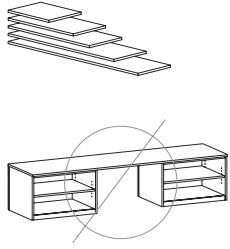
⑤ Pull Style and Color (see page VI5)

⑥ Optional Grommet Location & Color -
Matte Black (MBK) or Arctic Silver (ASL)
(see page VI6)

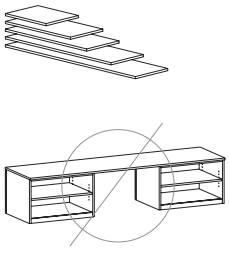
⑦ Other Product Options (see page VI10)

⑧ Accessories (see page VS314)

⑨ Power and Data Options (see page VS324)

Description	D	W	H	CTN WT	CU FT	① Model	Laminate	Flat Cut Veneer	Double Cut Veneer
23 3/4" d Bench Height Modular Tops	23 3/4	108	3/4	63	5	VSTB24108MT	\$412		
	23 3/4	108	3/4	63	5	VSVB24108MT		\$612	\$674
	23 3/4	102	3/4	58	5	VSTB24102MT	\$399		
	23 3/4	102	3/4	58	5	VSVB24102MT		\$599	\$660
	23 3/4	96	3/4	55	4	VSTB2496MT	\$383		
	23 3/4	96	3/4	55	4	VSVB2496MT		\$584	\$642
	23 3/4	90	3/4	53	4	VSTB2490MT	\$371		
	23 3/4	90	3/4	53	4	VSVB2490MT		\$570	\$629
	23 3/4	84	3/4	47	4	VSTB2484MT	\$357		
	23 3/4	84	3/4	47	4	VSVB2484MT		\$555	\$611
	23 3/4	78	3/4	44	4	VSTB2478MT	\$342		
	23 3/4	78	3/4	44	4	VSVB2478MT		\$542	\$595
	23 3/4	72	3/4	42	4	VSTB2472MT	\$330		
	23 3/4	72	3/4	42	4	VSVB2472MT		\$527	\$581
	23 3/4	66	3/4	39	3	VSTB2466MT	\$317		
	23 3/4	66	3/4	39	3	VSVB2466MT		\$513	\$565
	23 3/4	60	3/4	35	3	VSTB2460MT	\$296		
	23 3/4	60	3/4	35	3	VSVB2460MT		\$499	\$549
	23 3/4	54	3/4	31	3	VSTB2454MT	\$283		
	23 3/4	54	3/4	31	3	VSVB2454MT		\$480	\$528
	23 3/4	48	3/4	28	3	VSTB2448MT	\$269		
	23 3/4	48	3/4	28	3	VSVB2448MT		\$467	\$514
	23 3/4	36	3/4	21	2	VSTB2436MT	\$217		
	23 3/4	36	3/4	21	2	VSVB2436MT		\$438	\$481
	23 3/4	30	3/4	17	2	VSTB2430MT	\$203		
	23 3/4	30	3/4	17	2	VSVB2430MT		\$424	\$466
	23 3/4	18	3/4	10	1	VSTB2418MT	\$179		
	23 3/4	18	3/4	10	1	VSVB2418MT		\$394	\$434

- flat edge on all four sides
- long grain direction
- modular bench height tops NOT intended for unsupported space

Description	D	W	H	CTN WT	CU FT	① Model	Laminate	Flat Cut Veneer	Double Cut Veneer
18 1/8" d Bench Height Modular Tops	18 1/8	108	3/4	54	4	VSTB18108MT	\$367		
	18 1/8	108	3/4	54	4	VSVB18108MT		\$549	\$604
	18 1/8	102	3/4	50	4	VSTB18102MT	\$357		
	18 1/8	102	3/4	50	4	VSVB18102MT		\$539	\$592
	18 1/8	96	3/4	49	4	VSTB1896MT	\$347		
	18 1/8	96	3/4	49	4	VSVB1896MT		\$528	\$582
	18 1/8	90	3/4	46	3	VSTB1890MT	\$336		
	18 1/8	90	3/4	46	3	VSVB1890MT		\$519	\$570
	18 1/8	84	3/4	41	4	VSTB1884MT	\$325		
	18 1/8	84	3/4	41	4	VSVB1884MT		\$506	\$556
	18 1/8	78	3/4	39	3	VSTB1878MT	\$314		
	18 1/8	78	3/4	39	3	VSVB1878MT		\$499	\$549
	18 1/8	72	3/4	36	3	VSTB1872MT	\$301		
	18 1/8	72	3/4	36	3	VSVB1872MT		\$482	\$530
	18 1/8	66	3/4	33	3	VSTB1866MT	\$283		
	18 1/8	66	3/4	33	3	VSVB1866MT		\$471	\$519
	18 1/8	60	3/4	30	2	VSTB1860MT	\$272		
	18 1/8	60	3/4	30	2	VSVB1860MT		\$459	\$505
	18 1/8	54	3/4	27	2	VSTB1854MT	\$264		
	18 1/8	54	3/4	27	2	VSVB1854MT		\$445	\$490
	18 1/8	48	3/4	24	2	VSTB1848MT	\$252		
	18 1/8	48	3/4	24	2	VSVB1848MT		\$437	\$480
	18 1/8	36	3/4	18	2	VSTB1836MT	\$202		
	18 1/8	36	3/4	54	2	VSVB1836MT		\$413	\$454
	18 1/8	30	3/4	15	2	VSTB1830MT	\$191		
	18 1/8	30	3/4	15	2	VSVB1830MT		\$400	\$440
	18 1/8	18	3/4	9	1	VSTB1818MT	\$172		
	18 1/8	18	3/4	9	1	VSVB1818MT		\$380	\$419

- flat edge on all four sides
- long grain direction
- modular bench height tops NOT intended for unsupported space

To Order, Specify:

① Model Number

Laminate - VST

Veneer - VSV

② Worksurface Material (see page VI3)

- a.) TFL
- b.) HPL

② Wood Species - Cherry (CH1), Maple (MA1)

- Walnut (WA1), Black Oak (BO1) or Double Cut (DC1) (see page VI1)

④ Edge Profile (see page VI4)

⑤ Pull Style and Color (see page VI5)

③ Laminate Color (see page VI3)

- a.) Worksurface Color
- b.) Chassis Color
- c.) Drawer Color


③ Finish Color (see page VI1)

⑥ Optional Grommet Location & Color - Matte Black (MBK) or Arctic Silver (ASL) (see page VI6)

⑦ Other Product Options (see page VI10)

⑧ Accessories (see page VS314)

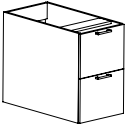
⑨ Power and Data Options (see page VS324)

Description	D	W	H	CTN WT	CU FT	① Model	Laminate	Flat Cut Veneer	Double Cut Veneer
Modular Box/Box/File Pedestal 	34 7/8	18	28 5/16	118	13	VST1836MBBF	\$917		
	34 7/8	18	28 5/16	118	13	VSV1836MBBF		\$1,485	\$1,633
	28 7/8	18	28 5/16	103	11	VST1830MBBF	\$899		
	28 7/8	18	28 5/16	103	11	VSV1830MBBF		\$1,462	\$1,608
	22 7/8	18	28 5/16	91	10	VST1824MBBF	\$847		
	22 7/8	18	28 5/16	91	10	VSV1824MBBF		\$1,405	\$1,544
	18 7/8	18	28 5/16	80	8	VST1820MBBF	\$831		
	18 7/8	18	28 5/16	80	8	VSV1820MBBF		\$1,383	\$1,522
	34 7/8	15 5/8	28 5/16	113	12	VST1636MBBF	\$814		
	34 7/8	15 5/8	28 5/16	113	12	VSV1636MBBF		\$1,320	\$1,451
	28 7/8	15 5/8	28 5/16	99	10	VST1630MBBF	\$800		
	28 7/8	15 5/8	28 5/16	99	10	VSV1630MBBF		\$1,299	\$1,430
	22 7/8	15 5/8	28 5/16	87	9	VST1624MBBF	\$753		
	22 7/8	15 5/8	28 5/16	87	9	VSV1624MBBF		\$1,248	\$1,372
	18 7/8	15 5/8	28 5/16	76	7	VST1620MBBF	\$738		
	18 7/8	15 5/8	28 5/16	76	7	VSV1620MBBF		\$1,228	\$1,352

- chassis grommet available, specify and add \$49 list
- locking available, specify and add \$80 list
- unit ships with support rails in back of unit - order modular back panel if not placed against the wall, see pages [VS158-VS161](#)

Note: Use 28 7/8" and 34 7/8"d pedestals with modular modesty panels and modular worksurfaces tops to build desks.
 Use 18 7/8"d and 22 7/8"d pedestals with modular modesty panels and modular worksurfaces tops to build credenzas and returns.

Note: Pedestals can be used in shell desk, credenzas and returns - use 18 7/8"d pedestal with 24"d shell, 22 7/8"d pedestal with 30"d shell, and 28 7/8"d pedestal with 36"d shell

Description	D	W	H	CTN WT	CU FT	① Model	Laminate	Flat Cut Veneer	Double Cut Veneer
	34 7/8	18	28 5/16	118	13	VST1836MFF	\$898		
	34 7/8	18	28 5/16	118	13	VSV1836MFF		\$1,465	\$1,613
	28 7/8	18	28 5/16	103	11	VST1830MFF	\$881		
	28 7/8	18	28 5/16	103	11	VSV1830MFF		\$1,444	\$1,588
	22 7/8	18	28 5/16	91	10	VST1824MFF	\$828		
	22 7/8	18	28 5/16	91	10	VSV1824MFF		\$1,385	\$1,525
	18 7/8	18	28 5/16	80	8	VST1820MFF	\$812		
	18 7/8	18	28 5/16	80	8	VSV1820MFF		\$1,364	\$1,500
	34 7/8	15 5/8	28 5/16	113	12	VST1636MFF	\$799		
	34 7/8	15 5/8	28 5/16	113	12	VSV1636MFF		\$1,302	\$1,433
	28 7/8	15 5/8	28 5/16	99	10	VST1630MFF	\$783		
	28 7/8	15 5/8	28 5/16	99	10	VSV1630MFF		\$1,283	\$1,411
	22 7/8	15 5/8	28 5/16	87	9	VST1624MFF	\$736		
	22 7/8	15 5/8	28 5/16	87	9	VSV1624MFF		\$1,232	\$1,356
	18 7/8	15 5/8	28 5/16	76	7	VST1620MFF	\$722		
	18 7/8	15 5/8	28 5/16	76	7	VSV1620MFF		\$1,212	\$1,334

- chassis grommet available, specify and add \$49 list
- locking available, specify and add \$80 list
- unit ships with support rails in back of unit - order modular back panel if not placed against the wall, see pages [VS158-VS161](#)

Note: Use 28 7/8" and 34 7/8"d pedestals with modular modesty panels and modular worksurfaces tops to build desks
 Use 18 7/8" and 22 7/8"d pedestals with modular modesty panels and modular worksurfaces tops to build credenzas and returns

Note: Pedestals can be used in shell desk, credenzas and returns - use 18 7/8"d pedestal with 24"d shell, 22 7/8"d pedestal with 30"d shell and 28 7/8"d pedestal with 36"d shell

To Order, Specify:

① Model Number

Laminate - VST

Veneer - VSV

② Worksurface Material (see page [VI3](#))

a.) TFL

b.) HPL

③ Laminate Color (see page [VI3](#))

a.) Worksurface Color

b.) Chassis Color

c.) Drawer Color

② Wood Species - Cherry (CH1), Maple (MA1)

Walnut (WA1), Black Oak (BO1) or

Double Cut (DC1) (see page [VI1](#))

③ Finish Color (see page [VI1](#))

④ Edge Profile (see page [VI4](#))

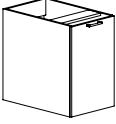
⑤ Pull Style and Color (see page [VI5](#))

⑥ Optional Grommet Location & Color - Matte Black (MBK) or Arctic Silver (ASL) (see page [VI6](#))

⑦ Other Product Options (see page [VI10](#))

⑧ Accessories (see page [VS314](#))

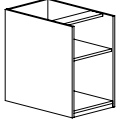
⑨ Power and Data Options (see page [VS324](#))

Description	D	W	H	CTN WT	CU FT	① Model	Laminate	Flat Cut Veneer	Double Cut Veneer
Modular Hinged Door Pedestal 	28 7/8	18	28 5/16	89	11	VST1830MHR	\$703		
	28 7/8	18	28 5/16	89	11	VSV1830MHR		\$984	\$1,084
	28 7/8	18	28 5/16	89	11	VST1830MHL	\$703		
	28 7/8	18	28 5/16	89	11	VSV1830MHL		\$984	\$1,084
	22 7/8	18	28 5/16	80	10	VST1824MHR	\$654		
	22 7/8	18	28 5/16	80	10	VSV1824MHR		\$922	\$1,015
	22 7/8	18	28 5/16	80	10	VST1824MHL	\$654		
	22 7/8	18	28 5/16	80	10	VSV1824MHL		\$922	\$1,015
	18 7/8	18	28 5/16	69	8	VST1820MHR	\$613		
	18 7/8	18	28 5/16	69	8	VSV1820MHR		\$865	\$952
	18 7/8	18	28 5/16	69	8	VST1820MHL	\$613		
	18 7/8	18	28 5/16	69	8	VSV1820MHL		\$865	\$952
	28 7/8	15 5/8	28 5/16	87	10	VST1630MHR	\$674		
	28 7/8	15 5/8	28 5/16	87	10	VSV1630MHR		\$954	\$1,049
	28 7/8	15 5/8	28 5/16	87	10	VST1630MHL	\$674		
	28 7/8	15 5/8	28 5/16	87	10	VSV1630MHL		\$954	\$1,049
	22 7/8	15 5/8	28 5/16	78	9	VST1624MHR	\$628		
	22 7/8	15 5/8	28 5/16	78	9	VSV1624MHR		\$893	\$983
	22 7/8	15 5/8	28 5/16	78	9	VST1624MHL	\$628		
	22 7/8	15 5/8	28 5/16	78	9	VSV1624MHL		\$893	\$983
18 7/8	15 5/8	28 5/16	67	7	VST1620MHR	\$587			
18 7/8	15 5/8	28 5/16	67	7	VSV1620MHR		\$837	\$921	
18 7/8	15 5/8	28 5/16	67	7	VST1620MHL	\$587			
18 7/8	15 5/8	28 5/16	67	7	VSV1620MHL		\$837	\$921	

- chassis grommet available, specify and add \$49 list
- locking available, specify and add \$40 list
- unit ships with support rails in back of unit - order modular back panel if not placed against the wall, see pages [VS158-VS161](#)

Note: Use 28 7/8"d pedestals with modular modesty panels and modular worksurfaces tops to build desks
 Use 18 7/8" and 22 7/8"d pedestals with modular modesty panels and modular worksurfaces tops to build credenzas and returns

Note: Pedestals can be used in shell desk, credenzas and returns - use 18 7/8"d pedestal with 24"d shell,
 22 7/8"d pedestal with 30"d shell and 28 7/8"d pedestal with 36"d shell

Description	D	W	H	CTN WT	CU FT	① Model	Laminate	Flat Cut Veneer	Double Cut Veneer
Modular Open Shelf Pedestal 	28 7/8	18	28 3/16	79	11	VST1830MOS	\$623		
	28 7/8	18	28 3/16	79	11	VSV1830MOS		\$877	\$965
	22 7/8	18	28 3/16	70	10	VST1824MOS	\$574		
	22 7/8	18	28 3/16	70	10	VSV1824MOS		\$814	\$896
	18 7/8	18	28 3/16	59	8	VST1820MOS	\$532		
	18 7/8	18	28 3/16	59	8	VSV1820MOS		\$757	\$834
	28 7/8	15 5/8	28 3/16	77	10	VST1630MOS	\$605		
	28 7/8	15 5/8	28 3/16	77	10	VSV1630MOS		\$851	\$937
	22 7/8	15 5/8	28 3/16	68	9	VST1624MOS	\$559		
	22 7/8	15 5/8	28 3/16	68	9	VSV1624MOS		\$791	\$871
	18 7/8	15 5/8	28 3/16	57	7	VST1620MOS	\$518		
	18 7/8	15 5/8	28 3/16	57	7	VSV1620MOS		\$735	\$809

- chassis grommet available, specify and add \$49 list
- unit ships with support rails in back of unit - order modular back panel if not placed against the wall, see pages [VS158-VS161](#)

Note: Use 28 7/8" d pedestals with modular modesty panels and modular worksurfaces tops to build desk
 Use 18 7/8" and 28 3/16" d pedestals with modular modesty panels and modular worksurfaces tops to build credenzas and returns.

Note: Pedestals can be used in shell desk, credenzas and returns - use 18 7/8" d pedestal with 24" d shell, 22 7/8" d pedestal with 30" d shell and 28 3/16" d pedestal with 36" d shell

To Order, Specify:

① Model Number

Laminate - VST

Veneer - VSV

② Worksurface Material (see page [VI3](#))

- a.) TFL
- b.) HPL

② Wood Species - Cherry (CH1), Maple (MA1)

- Walnut (WA1), Black Oak (BO1) or
- Double Cut (DC1) (see page [VI1](#))

③ Laminate Color (see page [VI3](#))

- a.) Worksurface Color
- b.) Chassis Color
- c.) Drawer Color

③ Finish Color (see page [VI1](#))

④ Edge Profile (see page [VI4](#))

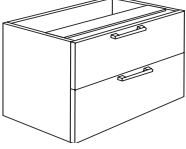
⑤ Pull Style and Color (see page [VI5](#))

⑥ Optional Grommet Location & Color - Matte Black (MBK) or Arctic Silver (ASL) (see page [VI6](#))

⑦ Other Product Options (see page [VI10](#))

⑧ Accessories (see page [VS314](#))

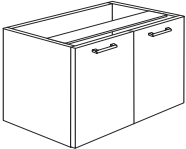
⑨ Power and Data Options (see page [VS324](#))

Description	D	W	H	CTN WT	CU FT	① Model	Laminate	Flat Cut Veneer	Double Cut Veneer
Modular Lateral File Pedestal 	22 7/8	35 7/8	28 5/16	147	18	VST3624MLF	\$1,030		
	22 7/8	35 7/8	28 5/16	147	18	VSV3624MLF		\$1,528	\$1,673
	18 7/8	35 7/8	28 5/16	154	15	VST3620MLF	\$1,024		
	18 7/8	29 7/8	28 5/16	154	15	VSV3620MLF		\$1,519	\$1,663
	22 7/8	29 7/8	28 5/16	138	15	VST3024MLF	\$1,021		
	22 7/8	29 7/8	28 5/16	138	15	VSV3024MLF		\$1,462	\$1,603
	18 7/8	29 7/8	28 5/16	146	13	VST3020MLF	\$1,017		
	18 7/8	29 7/8	28 5/16	146	13	VSV3020MLF		\$1,454	\$1,592

- chassis grommet available, specify and add \$49 list
- locking available, specify and add \$112 list
- unit ships with support rails in back of unit - order modular back panel if not placed against the wall, see pages [VS158-VS161](#)

Note: Use 18 7/8" and 22 7/8" d pedestals with modular modesty panels and modular worksurface tops to build credenzas and returns

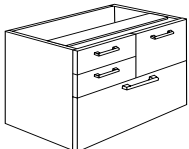
Note: Pedestals can be used in shell desk, credenzas and returns - use 18 7/8" d pedestal with 24" d shell and 22 7/8" d pedestal with 30" d shell

Modular Hinged Door Pedestal 	22 7/8	35 7/8	28 5/16	108	18	VST3624MSC	\$863		
	22 7/8	35 7/8	28 5/16	108	18	VSV3624MSC		\$1,499	\$1,650
	18 7/8	35 7/8	28 5/16	96	15	VST3620MSC	\$848		
	18 7/8	29 7/8	28 5/16	96	15	VSV3620MSC		\$1,482	\$1,629
	22 7/8	29 7/8	28 5/16	108	15	VST3024MSC	\$817		
	22 7/8	29 7/8	28 5/16	108	15	VSV3024MSC		\$1,440	\$1,583
	18 7/8	29 7/8	28 5/16	96	13	VST3020MSC	\$803		
	18 7/8	29 7/8	28 5/16	96	13	VSV3020MSC		\$1,421	\$1,563

- chassis grommet available, specify and add \$49 list
- adjustable shelf in storage cabinet
- locking available, specify and add \$47 list
- unit ships with support rails in back of unit - order modular back panel if not placed against the wall, see pages [VS158-VS161](#)

Note: Use 18 7/8" and 22 7/8" d pedestals with modular modesty panels and modular worksurfaces tops to build credenzas and returns

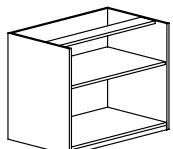
Note: Pedestals can be used in shell desk, credenzas and returns - use 18 7/8" d pedestal with 24" d shell and 22 7/8" d pedestal with 30" d shell

Description	D	W	H	CTN WT	CU FT	① Model	Laminate	Flat Cut Veneer	Double Cut Veneer
 <p>right shown</p>	22 7/8	29 7/8	28 3/16	150	15	VST3024MRM	\$1,126		
	22 7/8	29 7/8	28 3/16	150	15	VSV3024MRM		\$1,616	\$1,771
	22 7/8	29 7/8	28 3/16	150	15	VST3024MLM	\$1,126		
	22 7/8	29 7/8	28 3/16	150	15	VSV3024MLM		\$1,616	\$1,771
	18 7/8	29 7/8	28 3/16	155	13	VST3020MRM	\$1,121		
	18 7/8	29 7/8	28 3/16	155	13	VSV3020MRM		\$1,606	\$1,758
	18 7/8	29 7/8	28 3/16	155	13	VST3020MLM	\$1,121		
	18 7/8	29 7/8	28 3/16	155	13	VSV3020MLM		\$1,606	\$1,758

- chassis grommet available, specify and add \$49 list
- locking available, specify and add \$112 list
- top file drawer determines left or right
- unit ships with support rails in back of unit - order modular back panel if not placed against the wall, see pages [VS158-VS161](#)

Note: Use 18 7/8" and 22 7/8" d pedestals with modular modesty panels and modular worksurface tops to build credenzas and returns

Note: Pedestals can be used in shell desk, credenzas and returns - use 18 7/8" d pedestal with 24" d shell and 22 7/8" d pedestal with 30" d shell

Description	D	W	H	CTN WT	CU FT	① Model	Laminate	Flat Cut Veneer	Double Cut Veneer
	22 7/8	35 7/8	28 3/16	90	18	VST3624MOS	\$713		
	22 7/8	35 7/8	28 3/16	90	18	VSV3624MOS		\$1,285	\$1,413
	18 7/8	35 7/8	28 3/16	78	15	VST3620MOS	\$677		
	18 7/8	35 7/8	28 3/16	78	15	VSV3620MOS		\$1,221	\$1,344
	22 7/8	29 7/8	28 3/16	79	15	VST3024MOS	\$679		
	22 7/8	29 7/8	28 3/16	79	15	VSV3024MOS		\$1,239	\$1,363
	18 7/8	29 7/8	28 3/16	67	13	VST3020MOS	\$647		
	18 7/8	29 7/8	28 3/16	67	13	VSV3020MOS		\$1,177	\$1,296

- chassis grommet available, specify and add \$49 list
- unit ships with support rails in back of unit - order modular back panel if not placed against the wall, see pages [VS158-VS161](#)

Note: Use 18 7/8" and 22 7/8" d pedestals with modular modesty panels and modular worksurface tops to build credenzas and returns

Note: Pedestals can be used in shell desk, credenzas and returns - use 18 7/8" d pedestal with 24" d shell and 22 7/8" d pedestal with 30" d shell

To Order, Specify:

① Model Number

Laminate - VST

Veneer - VSV

② Worksurface Material (see page [VI3](#))

a.) TFL

b.) HPL

③ Laminate Color (see page [VI3](#))

a.) Worksurface Color

b.) Chassis Color

c.) Drawer Color

② Wood Species - Cherry (CH1), Maple (MA1)

Walnut (WA1), Black Oak (BO1) or

Double Cut (DC1) (see page [VI1](#))

③ Finish Color (see page [VI1](#))

④ Edge Profile (see page [VI4](#))

⑤ Pull Style and Color (see page [VI5](#))

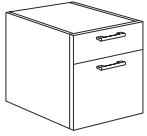
⑥ Optional Grommet Location & Color - Matte Black (MBK) or Arctic Silver (ASL) (see page [VI6](#))

⑦ Other Product Options (see page [VI10](#))

⑧ Accessories (see page [VS314](#))

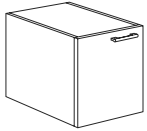
⑨ Power and Data Options (see page [VS324](#))

Description	D	W	H	CTN WT	CU FT	① Model	Laminate	Flat Cut Veneer	Double Cut Veneer
Box/File Bench Height Modular Pedestal	22 7/8	18	18 3/4	18	7	VSTB2418MBF	\$611		
	22 7/8	18	18 3/4	18	7	VSVB2418MBF		\$1,090	\$1,200
	17 1/4	18	18 3/4	64	5	VSTB1818MBF	\$563		
	17 1/4	18	18 3/4	64	5	VSVB1818MBF		\$1,004	\$1,106



- tops and backs are unfinished; specify modular tops and back panels to finish as needed
- specify chassis color
- specify top drawer color
- specify bottom drawer color
- locking available, specify and add \$80 list

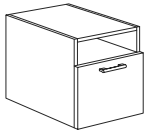
Hinged Door Bench Height Modular Pedestal	22 7/8	18	18 3/4	74	7	VSTB2418MHR	\$631		
	22 7/8	18	18 3/4	74	7	VSVB2418MHR		\$1,113	\$1,225
	22 7/8	18	18 3/4	74	7	VSTB2418MHL	\$631		
	22 7/8	18	18 3/4	74	7	VSVB2418MHL		\$1,113	\$1,225
	17 1/4	18	18 3/4	65	5	VSTB1818MHR	\$582		
	17 1/4	18	18 3/4	65	5	VSVB1818MHR		\$1,024	\$1,127
	17 1/4	18	18 3/4	65	5	VSTB1818MHL	\$582		
	17 1/4	18	18 3/4	65	5	VSVB1818MHL		\$1,024	\$1,127



left shown

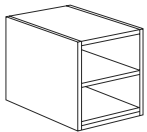
- tops and backs are unfinished; specify modular tops and back panels to finish as needed
- locking available, specify and add \$40 list
- hinge determines left or right for 18" w units

Open Shelf/File Drawer Bench Height Modular Pedestal	22 7/8	18	18 3/4	66	7	VSTB2418MOF	\$638		
	22 7/8	18	18 3/4	66	7	VSVB2418MOF		\$1,100	\$1,211
	17 1/4	18	18 3/4	57	5	VSTB1818MOF	\$588		
	17 1/4	18	18 3/4	57	5	VSVB1818MOF		\$1,013	\$1,114

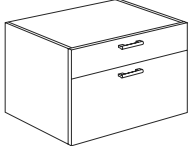


- tops and backs are unfinished; specify modular tops and back panels to finish as needed
- locking available, specify and add \$80 list

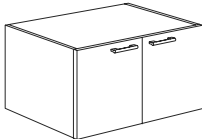
Open Shelf Bench Height Modular Pedestal	22 7/8	18	18 3/4	65	7	VSTB2418MOS	\$543		
	22 7/8	18	18 3/4	65	7	VSVB2418MOS		\$984	\$1,084
	17 1/4	18	18 3/4	56	5	VSTB1818MOS	\$501		
	17 1/4	18	18 3/4	56	5	VSVB1818MOS		\$907	\$998



- tops and backs are unfinished; specify modular tops and back panels to finish as needed
- adjustable shelf

Description	D	W	H	CTN WT	CU FT	① Model	Laminate	Flat Cut Veneer	Double Cut Veneer
Box/File Bench Height Modular Pedestal 	22 7/8	35 7/8	18 3/4	129	12	VSTB2436MBF	\$955		
	22 7/8	35 7/8	18 3/4	129	12	VSVB2436MBF		\$1,494	\$1,628
	22 7/8	29 7/8	18 3/4	128	10	VSTB2430MBF	\$916		
	22 7/8	29 7/8	18 3/4	128	10	VSVB2430MBF		\$1,446	\$1,575
	17 1/4	35 7/8	18 3/4	136	10	VSTB1836MBF	\$891		
	17 1/4	35 7/8	18 3/4	136	10	VSVB1836MBF		\$1,386	\$1,510
	17 1/4	29 7/8	18 3/4	136	8	VSTB1830MBF	\$854		
	17 1/4	29 7/8	18 3/4	136	8	VSVB1830MBF		\$1,343	\$1,463

- tops and backs are unfinished; specify modular tops and back panels to finish as needed
- specify chassis color
- specify top drawer color
- specify bottom drawer color
- locking available, specify and add \$112 list

Description	D	W	H	CTN WT	CU FT	① Model	Laminate	Flat Cut Veneer	Double Cut Veneer
Hinged Door Bench Height Modular Pedestal 	22 7/8	35 7/8	18 3/4	106	12	VSTB2436MHD	\$788		
	22 7/8	35 7/8	18 3/4	106	12	VSVB2436MHD		\$1,340	\$1,474
	22 7/8	29 7/8	18 3/4	104	10	VSTB2430MHD	\$745		
	22 7/8	29 7/8	18 3/4	104	10	VSVB2430MHD		\$1,284	\$1,412
	17 1/4	35 7/8	18 3/4	93	10	VSTB1836MHD	\$725		
	17 1/4	35 7/8	18 3/4	93	10	VSVB1836MHD		\$1,235	\$1,359
	17 1/4	29 7/8	18 3/4	92	8	VSTB1830MHD	\$686		
	17 1/4	29 7/8	18 3/4	92	8	VSVB1830MHD		\$1,182	\$1,300

- tops and backs are unfinished; specify modular tops and back panels to finish as needed
- locking available, specify and add \$47 list

To Order, Specify:

① Model Number

Laminate - VST

Veneer - VSV

② Worksurface Material (see page VI3)

a.) TFL

b.) HPL

③ Laminate Color (see page VI3)

a.) Worksurface Color

b.) Chassis Color

c.) Drawer Color

② Wood Species - Cherry (CH1), Maple (MA1)

Walnut (WA1), Black Oak (BO1) or

Double Cut (DC1) (see page VI1)

③ Finish Color (see page VI1)

④ Edge Profile (see page VI4)

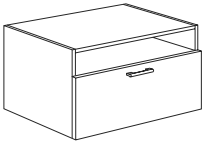
⑤ Pull Style and Color (see page VI5)

⑥ Optional Grommet Location & Color - Matte Black (MBK) or Arctic Silver (ASL) (see page VI6)

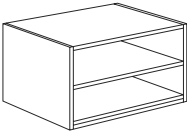
⑦ Other Product Options (see page VI10)

⑧ Accessories (see page VS314)

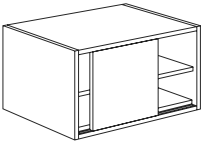
⑨ Power and Data Options (see page VS324)

Description	D	W	H	CTN WT	CU FT	① Model	Laminate	Flat Cut Veneer	Double Cut Veneer
Open Shelf/File Drawer Bench Height Modular Pedestal 	22 7/8	35 7/8	18 3/4	124	12	VSTB2436MOF	\$992		
	22 7/8	35 7/8	18 3/4	124	12	VSVB2436MOF		\$1,532	\$1,670
	22 7/8	29 7/8	18 3/4	115	10	VSTB2430MOF	\$952		
	22 7/8	29 7/8	18 3/4	115	10	VSVB2430MOF		\$1,479	\$1,612
	17 1/4	35 7/8	18 3/4	131	10	VSTB1836MOF	\$925		
	17 1/4	35 7/8	18 3/4	131	10	VSVB1836MOF		\$1,422	\$1,549
	17 1/4	29 7/8	18 3/4	125	8	VSTB1830MOF	\$888		
	17 1/4	29 7/8	18 3/4	125	8	VSVB1830MOF		\$1,373	\$1,495

- tops and backs are unfinished; specify modular tops and back panels to finish as needed
- locking available, specify and add \$112 list

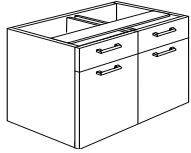
Open Shelf Bench Height Modular Pedestal 	22 7/8	35 7/8	18 3/4	86	12	VSTB2436MOS	\$654		
	22 7/8	35 7/8	18 3/4	86	12	VSVB2436MOS		\$1,161	\$1,277
	22 7/8	29 7/8	18 3/4	81	10	VSTB2430MOS	\$619		
	22 7/8	29 7/8	18 3/4	81	10	VSVB2430MOS		\$1,085	\$1,194
	17 1/4	35 7/8	18 3/4	73	10	VSTB1836MOS	\$601		
	17 1/4	35 7/8	18 3/4	73	10	VSVB1836MOS		\$1,068	\$1,175
	17 1/4	29 7/8	18 3/4	69	8	VSTB1830MOS	\$570		
17 1/4	29 7/8	18 3/4	69	8	VSVB1830MOS		\$999	\$1,099	

- tops and backs are unfinished; specify modular tops and back panels to finish as needed
- adjustable shelf

Sliding Door Bench Height Modular Pedestal 	22 7/8	35 7/8	18 3/4	107	12	VSTB2436MSD	\$836		
	22 7/8	35 7/8	18 3/4	107	12	VSVB2436MSD		\$1,425	\$1,569
	22 7/8	29 7/8	18 3/4	99	10	VSTB2430MSD	\$766		
	22 7/8	29 7/8	18 3/4	99	10	VSVB2430MSD		\$1,340	\$1,474
	17 1/4	35 7/8	18 3/4	94	10	VSTB1836MSD	\$769		
	17 1/4	35 7/8	18 3/4	94	10	VSVB1836MSD		\$1,312	\$1,445
	17 1/4	29 7/8	18 3/4	87	8	VSTB1830MSD	\$706		
17 1/4	29 7/8	18 3/4	87	8	VSVB1830MSD		\$1,235	\$1,359	

- tops and backs are unfinished; specify modular tops and back panels to finish as needed
- adjustable shelf
- locking not available

Description	D	W	H	CTN WT	CU FT	① Model	Laminate	Flat Cut Veneer	Double Cut Veneer
Modular Buffet Door Pedestal	23 5/8	35 7/8	34 3/16	119	21	VST3624MBSC	\$992		
	23 5/8	35 7/8	34 3/16	119	21	VSV3624MBSC		\$1,725	\$1,898
	19 5/8	35 7/8	34 3/16	103	18	VST3620MBSC	\$975		
	19 5/8	35 7/8	34 3/16	103	18	VSV3620MBSC		\$1,704	\$1,874



- chassis grommet available, specify and add \$49 list
- adjustable shelf in storage cabinet
- locking not available

Note: These units are NOT to be used with Shell Desks, Credenzas and Returns.

To Order, Specify:

① Model Number

Laminate - VST

Veneer - VSV

② Worksurface Material (see page VI3)

a.) TFL

b.) HPL

③ Laminate Color (see page VI3)

a.) Worksurface Color

b.) Chassis Color

c.) Drawer Color

② Wood Species - Cherry (CH1), Maple (MA1)

Walnut (WA1), Black Oak (BO1) or

Double Cut (DC1) (see page VI1)

③ Finish Color (see page VI1)

④ Edge Profile (see page VI4)

⑤ Pull Style and Color (see page VI5)

⑥ Optional Grommet Location & Color -
Matte Black (MBK) or Arctic Silver (ASL)
(see page VI6)

⑦ Other Product Options (see page VI10)

⑧ Accessories (see page VS314)

⑨ Power and Data Options (see page VS324)

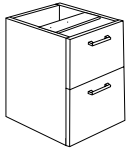
Description	D	W	H	CTN WT	CU FT	① Model	Laminate	Flat Cut Veneer	Double Cut Veneer
Modular Shell Box/Box/File Pedestal	17 3/8	15 5/8	28 3/16	84	14	VST1618SMBBF	\$791		
	17 3/8	15 5/8	28 3/16	84	14	VSV1618SMBBF		\$1,324	\$1,457



- chassis grommet available, specify and add \$49 list
- letter width pedestal
- locking available, specify and add \$80 list

Note: This unit is ONLY to be used with Shell Desks, Credenzas and Returns.

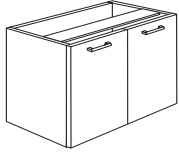
Modular Shell File/File Pedestal	17 3/8	15 5/8	28 3/16	84	12	VST1618SMFF	\$775		
	17 3/8	15 5/8	28 3/16	84	12	VSV1618SMFF		\$1,307	\$1,439



- chassis grommet available, specify and add \$49 list
- letter width pedestal
- locking available, specify and add \$80 list

Note: This unit is ONLY to be used with Shell Desks, Credenzas and Returns.

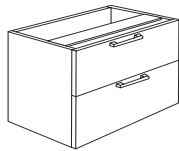
Description	D	W	H	CTN WT	CU FT	① Model	Laminate	Flat Cut Veneer	Double Cut Veneer
Modular Shell Hinged Door Pedestal	17 3/8	36	28 5/16	115	14	VST3618SMSC	\$915		
	17 3/8	36	28 5/16	115	14	VSV3618SMSC		\$1,581	\$1,740
	17 3/8	30	28 5/16	111	12	VST3018SMSC	\$861		
	17 3/8	30	28 5/16	111	12	VSV3018SMSC		\$1,510	\$1,661



- chassis grommet available, specify and add \$49 list
- adjustable shelf in storage cabinet
- locking available, specify and add \$47 list

Note: These units are ONLY to be used with Shell Desks, Credenzas and Returns.

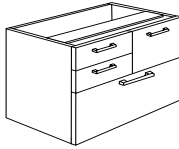
Modular Shell Lateral File Pedestal	17 3/8	36	28 5/16	128	14	VST3618SMLF	\$1,011		
	17 3/8	36	28 5/16	128	14	VSV3618SMLF		\$1,492	\$1,642
	17 3/8	30	28 5/16	123	12	VST3018SMLF	\$993		
	17 3/8	30	28 5/16	123	12	VSV3018SMLF		\$1,462	\$1,608



- one end panel grommet available, specify chassis grommet add \$49 list
- locking available, specify and add \$112 list

Note: These units are ONLY to be used with Shell Desks, Credenzas and Returns.

Modular Shell Multi-File Pedestal	17 3/8	30	28 5/16	147	12	VST3018SMRM	\$1,112		
	17 3/8	30	28 5/16	147	12	VSV3018SMRM		\$1,634	\$1,797
	17 3/8	30	28 5/16	147	12	VST3018SMLM	\$1,112		
	17 3/8	30	28 5/16	147	12	VSV3018SMLM		\$1,634	\$1,797



right shown

- one end panel grommet available, specify chassis grommet add \$49 list
- locking available, specify and add \$112 list
- top file drawer determines left or right

Note: These units are ONLY to be used with Shell Desks, Credenzas and Returns.

To Order, Specify:

① Model Number

Laminate - VST

Veneer - VSV

② Worksurface Material (see page VI3)

a.) TFL

b.) HPL

③ Laminate Color (see page VI3)

a.) Worksurface Color

b.) Chassis Color

c.) Drawer Color

② Wood Species - Cherry (CH1), Maple (MA1)

Walnut (WA1), Black Oak (BO1) or

Double Cut (DC1) (see page VI1)

③ Finish Color (see page VI1)

④ Edge Profile (see page VI4)

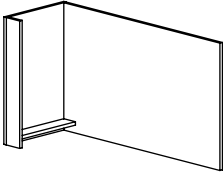
⑤ Pull Style and Color (see page VI5)

⑥ Optional Grommet Location & Color - Matte Black (MBK) or Arctic Silver (ASL) (see page VI6)

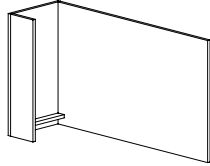
⑦ Other Product Options (see page VI10)

⑧ Accessories (see page VS314)

⑨ Power and Data Options (see page VS324)

Description	D	W	H	CTN WT	CU FT	① Model	Laminate	Flat Cut Veneer	Double Cut Veneer
18" d Modular Wing End Support  right shown	47 7/8	18	28 3/16	59	16	VST1848WEAR	\$433		
	47 7/8	18	28 3/16	59	16	VSV1848WEAR		\$832	\$916
	47 7/8	18	28 3/16	59	16	VST1848WEAL	\$433		
	47 7/8	18	28 3/16	59	16	VSV1848WEAL		\$832	\$916
	41 1/2	18	28 3/16	55	0	VST1842WEAR	\$420		
	41 1/2	18	28 3/16	55	14	VSV1842WEAR		\$816	\$898
	41 1/2	18	28 3/16	55	14	VST1842WEAL	\$420		
	41 1/2	18	28 3/16	55	14	VSV1842WEAL		\$816	\$898
	35 1/2	18	28 3/16	51	12	VST1836WEAR	\$406		
	35 1/2	18	28 3/16	51	12	VSV1836WEAR		\$801	\$881
	35 1/2	18	28 3/16	51	12	VST1836WEAL	\$406		
	35 1/2	18	28 3/16	51	12	VSV1836WEAL		\$801	\$881
	29 1/2	18	28 3/16	46	10	VST1830WEAR	\$395		
	29 1/2	18	28 3/16	46	10	VSV1830WEAR		\$786	\$865
	29 1/2	18	28 3/16	46	10	VST1830WEAL	\$395		
	29 1/2	18	28 3/16	46	10	VSV1830WEAL		\$786	\$865
	23 1/2	18	28 3/16	42	9	VST1824WEAR	\$382		
	23 1/2	18	28 3/16	42	9	VSV1824WEAR		\$768	\$847
	23 1/2	18	28 3/16	42	9	VST1824WEAL	\$382		
	23 1/2	18	28 3/16	42	9	VSV1824WEAL		\$768	\$847
19 1/2	18	28 3/16	38	7	VST1820WEAR	\$376			
19 1/2	18	28 3/16	38	7	VSV1820WEAR		\$755	\$830	
19 1/2	18	28 3/16	38	7	VST1820WEAL	\$376			
19 1/2	18	28 3/16	38	7	VSV1820WEAL		\$755	\$830	

- chassis grommet available, specify and add \$49 list

Description	D	W	H	CTN WT	CU FT	① Model	Laminate	Flat Cut Veneer	Double Cut Veneer
15 7/8" d Wing End Support	47 7/8	15 5/8	28 5/16	58	16	VST1648WEAR	\$392		
	47 7/8	15 5/8	28 5/16	58	16	VSV1648WEAR		\$760	\$836
	47 7/8	15 5/8	28 5/16	58	16	VST1648WEAL	\$392		
	47 7/8	15 5/8	28 5/16	58	16	VSV1648WEAL		\$760	\$836
right shown	41 1/8	15 5/8	28 5/16	54	14	VST1642WEAR	\$379		
	41 1/8	15 5/8	28 5/16	54	14	VSV1642WEAR		\$743	\$817
	41 1/8	15 5/8	28 5/16	54	14	VST1642WEAL	\$379		
	41 1/8	15 5/8	28 5/16	54	14	VSV1642WEAL		\$743	\$817
	35 5/8	15 5/8	28 5/16	50	12	VST1636WEAR	\$365		
	35 5/8	15 5/8	28 5/16	50	12	VSV1636WEAR		\$727	\$801
	35 5/8	15 5/8	28 5/16	50	12	VST1636WEAL	\$365		
	35 5/8	15 5/8	28 5/16	50	12	VSV1636WEAL		\$727	\$801
	29 5/8	15 5/8	28 5/16	45	10	VST1630WEAR	\$354		
	29 5/8	15 5/8	28 5/16	45	10	VSV1630WEAR		\$713	\$785
	29 5/8	15 5/8	28 5/16	45	10	VST1630WEAL	\$354		
	29 5/8	15 5/8	28 5/16	45	10	VSV1630WEAL		\$713	\$785
	23 3/8	15 5/8	28 5/16	41	9	VST1624WEAR	\$341		
	23 3/8	15 5/8	28 5/16	41	9	VSV1624WEAR		\$695	\$765
	23 3/8	15 5/8	28 5/16	41	9	VST1624WEAL	\$341		
	23 3/8	15 5/8	28 5/16	41	9	VSV1624WEAL		\$695	\$765
	19 3/8	15 5/8	28 5/16	37	7	VST1620WEAR	\$334		
	19 3/8	15 5/8	28 5/16	37	7	VSV1620WEAR		\$681	\$750
	19 3/8	15 5/8	28 5/16	37	7	VST1620WEAL	\$334		
	19 3/8	15 5/8	28 5/16	37	7	VSV1620WEAL		\$681	\$750

- chassis grommet available, specify and add \$49 list

To Order, Specify:

① Model Number

Laminate - VST

Veneer - VSV

② Worksurface Material (see page VI3)

a.) TFL

b.) HPL

③ Laminate Color (see page VI3)

a.) Worksurface Color

b.) Chassis Color

c.) Drawer Color

② Wood Species - Cherry (CH1), Maple (MA1)

Walnut (WA1), Black Oak (BO1) or

Double Cut (DC1) (see page VI1)

③ Finish Color (see page VI1)

④ Edge Profile (see page VI4)

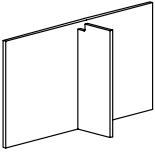
⑤ Pull Style and Color (see page VI5)

⑥ Optional Grommet Location & Color -
Matte Black (MBK) or Arctic Silver (ASL)
(see page VI6)

⑦ Other Product Options (see page VI10)

⑧ Accessories (see page VS314)

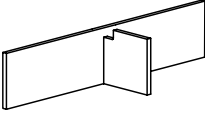
⑨ Power and Data Options (see page VS324)

Description	D	W	H	CTN WT	CU FT	① Model	Laminate	Flat Cut Veneer	Double Cut Veneer
Full Height “T” Supports 	9 3/4	59 5/8	28 3/16	48	13	VST1060TSP	\$383		
	9 3/4	59 5/8	28 3/16	48	13	VSV1060TSP		\$731	\$804
	9 3/4	47 5/8	28 3/16	42	11	VST1048TSP	\$307		
	9 3/4	47 5/8	28 3/16	42	11	VSV1048TSP		\$614	\$676
	9 3/4	41 5/8	28 3/16	38	9	VST1042TSP	\$296		
	9 3/4	41 5/8	28 3/16	38	9	VSV1042TSP		\$599	\$660
	9 3/4	35 5/8	28 3/16	32	8	VST1036TSP	\$285		
	9 3/4	35 5/8	28 3/16	32	8	VSV1036TSP		\$586	\$643
	9 3/4	29 5/8	28 3/16	28	7	VST1030TSP	\$272		
	9 3/4	29 5/8	28 3/16	28	7	VSV1030TSP		\$568	\$627
	9 3/4	23 5/8	28 3/16	24	6	VST1024TSP	\$263		
	9 3/4	23 5/8	28 3/16	24	6	VSV1024TSP		\$553	\$608
	9 3/4	19 5/8	28 3/16	21	5	VST1020TSP	\$255		
	9 3/4	19 5/8	28 3/16	21	5	VSV1020TSP		\$544	\$598

- use with peninsula or modular tops
- chassis grommet available, specify and add \$49 list

Full Height End Support with Metal Braces 	9 3/4	59 5/8	28 3/16	46	8	VST1060ASP	\$383		
	9 3/4	59 5/8	28 3/16	46	8	VSV1060ASP		\$731	\$804
	9 3/4	47 5/8	28 3/16	40	7	VST1048ASP	\$307		
	9 3/4	47 5/8	28 3/16	40	7	VSV1048ASP		\$614	\$676
	9 3/4	41 5/8	28 3/16	37	6	VST1042ASP	\$296		
	9 3/4	41 5/8	28 3/16	37	6	VSV1042ASP		\$599	\$660
	9 3/4	35 5/8	28 3/16	30	5	VST1036ASP	\$285		
	9 3/4	35 5/8	28 3/16	30	5	VSV1036ASP		\$586	\$643
	9 3/4	29 5/8	28 3/16	26	5	VST1030ASP	\$272		
	9 3/4	29 5/8	28 3/16	26	5	VSV1030ASP		\$568	\$627
	9 3/4	23 5/8	28 3/16	22	4	VST1024ASP	\$263		
	9 3/4	23 5/8	28 3/16	22	4	VSV1024ASP		\$553	\$608
	9 3/4	19 5/8	28 3/16	19	3	VST1020ASP	\$255		
	9 3/4	19 5/8	28 3/16	19	3	VSV1020ASP		\$544	\$598

- use with peninsula or modular tops
- chassis grommet available, specify and add \$49 list

Description	D	W	H	CTN WT	CU FT	① Model	Laminate	Flat Cut Veneer	Double Cut Veneer
Bench Height "T" Supports 	9 3/4	59 5/8	8 1/2	21	6	VSTB1060TSP	\$263		
	9 3/4	59 5/8	8 1/2	21	6	VSVB1060TSP		\$550	\$605
	9 3/4	47 5/8	8 1/2	18	4	VSTB1048TSP	\$252		
	9 3/4	47 5/8	8 1/2	18	4	VSVB1048TSP		\$537	\$591
	9 3/4	41 5/8	8 1/2	16	4	VSTB1042TSP	\$246		
	9 3/4	41 5/8	8 1/2	16	4	VSVB1042TSP		\$530	\$584
	9 3/4	35 5/8	8 1/2	15	3	VSTB1036TSP	\$240		
	9 3/4	35 5/8	8 1/2	15	3	VSVB1036TSP		\$526	\$579
	9 3/4	29 5/8	8 1/2	14	3	VSTB1030TSP	\$234		
	9 3/4	29 5/8	8 1/2	14	3	VSVB1030TSP		\$519	\$570
	9 3/4	23 5/8	8 1/2	12	2	VSTB1024TSP	\$230		
	9 3/4	23 5/8	8 1/2	12	2	VSVB1024TSP		\$514	\$566
	9 3/4	19 5/8	8 1/2	11	2	VSTB1020TSP	\$228		
	9 3/4	19 5/8	8 1/2	11	2	VSVB1020TSP		\$511	\$563

- use with modular tops or bench height configurations
- chassis grommet available, specify and add \$49 list

Description	D	W	H	CTN WT	CU FT	① Model	Laminate	Flat Cut Veneer	Double Cut Veneer
Bench Height Support with Metal Braces 	9 3/4	19 5/8	8 1/2	19	3	VSTB1060ASP	\$314		
	9 3/4	19 5/8	8 1/2	19	3	VSVB1060ASP		\$594	\$654
	9 3/4	19 5/8	8 1/2	16	2	VSTB1048ASP	\$252		
	9 3/4	19 5/8	8 1/2	16	2	VSVB1048ASP		\$537	\$591
	9 3/4	19 5/8	8 1/2	14	2	VSTB1042ASP	\$246		
	9 3/4	19 5/8	8 1/2	14	2	VSVB1042ASP		\$530	\$584
	9 3/4	19 5/8	8 1/2	13	2	VSTB1036ASP	\$240		
	9 3/4	19 5/8	8 1/2	13	2	VSVB1036ASP		\$526	\$579
	9 3/4	19 5/8	8 1/2	12	2	VSTB1030ASP	\$234		
	9 3/4	19 5/8	8 1/2	12	2	VSVB1030ASP		\$519	\$570
	9 3/4	19 5/8	8 1/2	10	1	VSTB1024ASP	\$230		
	9 3/4	19 5/8	8 1/2	10	1	VSVB1024ASP		\$514	\$566
	9 3/4	19 5/8	8 1/2	9	1	VSTB1020ASP	\$228		
	9 3/4	19 5/8	8 1/2	9	1	VSVB1020ASP		\$511	\$563

- use with modular tops or bench height configurations
- chassis grommet available, specify and add \$49 list

To Order, Specify:

① Model Number

Laminate - VST

Veneer - VSV

② Worksurface Material (see page VI3)

- a.) TFL
- b.) HPL

② Wood Species - Cherry (CH1), Maple (MA1)

- Walnut (WA1), Black Oak (BO1) or
- Double Cut (DC1) (see page VI1)

④ Edge Profile (see page VI4)

⑤ Pull Style and Color (see page VI5)

③ Laminate Color (see page VI3)

- a.) Worksurface Color
- b.) Chassis Color
- c.) Drawer Color

③ Finish Color (see page VI1)

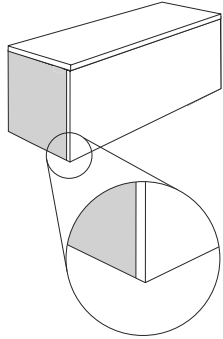
⑥ Optional Grommet Location & Color - Matte Black (MBK) or Arctic Silver (ASL) (see page VI6)

⑦ Other Product Options (see page VI10)

⑧ Accessories (see page VS314)

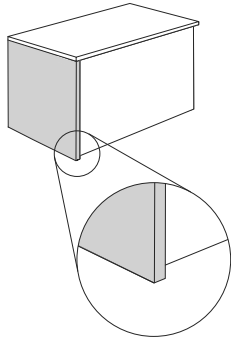
⑨ Power and Data Options (see page VS324)

Description	D	W	H	CTN WT	CU FT	① Model	Laminate	Flat Cut Veneer	Double Cut Veneer
Modular End Panel for Shell Desks and Credenzas	¾	46 ⅞	28 ⅞	31	4	VST47EP	\$242		
	¾	46 ⅞	28 ⅞	31	4	VSV47EP		\$481	\$529
	¾	40 ⅞	28 ⅞	27	4	VST41EP	\$231		
	¾	40 ⅞	28 ⅞	27	4	VSV41EP		\$467	\$514
	¾	34 ⅞	28 ⅞	23	3	VST35EP	\$218		
	¾	34 ⅞	28 ⅞	23	3	VSV35EP		\$449	\$494
	¾	28 ⅞	28 ⅞	18	3	VST29EP	\$204		
	¾	28 ⅞	28 ⅞	18	3	VSV29EP		\$434	\$478
	¾	22 ⅞	28 ⅞	14	2	VST23EP	\$193		
	¾	22 ⅞	28 ⅞	14	2	VSV23EP		\$418	\$460
	¾	18 ⅞	28 ⅞	13	2	VST19EP	\$185		
	¾	18 ⅞	28 ⅞	13	2	VSV19EP		\$406	\$447



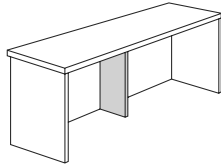
- use to create desk or credenza using modular top and modesty panel
- see pages [VS146-VS153](#) for modesty panels and pages [VI25-VI27](#) for selection guide
- chassis grommet available, specify and add \$49 list
- metal attachment brackets field installed to allow for use as right or left

Modular End Panel for Return Shell	¾	47 ⅞	28 ⅞	31	4	VST48EP	\$242		
	¾	47 ⅞	28 ⅞	31	4	VSV48EP		\$481	\$529
	¾	41 ⅞	28 ⅞	27	4	VST42EP	\$231		
	¾	41 ⅞	28 ⅞	27	4	VSV42EP		\$467	\$514
	¾	35 ⅞	28 ⅞	23	3	VST36EP	\$218		
	¾	35 ⅞	28 ⅞	23	3	VSV36EP		\$449	\$494
	¾	29 ⅞	28 ⅞	19	3	VST30EP	\$204		
	¾	29 ⅞	28 ⅞	19	3	VSV30EP		\$434	\$478
	¾	23 ⅞	28 ⅞	15	2	VST24EP	\$193		
	¾	23 ⅞	28 ⅞	15	2	VSV24EP		\$418	\$460
	¾	19 ⅞	28 ⅞	13	2	VST20EP	\$185		
	¾	19 ⅞	28 ⅞	13	2	VSV20EP		\$406	\$447



- use to create return shell using modular top and modesty panel
- see pages [VS146-VS153](#) for modesty panels and pages [VI25-VI27](#) for selection guide
- chassis grommet available, specify and add \$49 list
- metal attachment brackets field installed to allow for use as right or left

Description	D	W	H	CTN WT	CU FT	① Model	Laminate	Flat Cut Veneer	Double Cut Veneer
Modular Center Support Panel	¾	12	28 ⅝	8	1	VST12SP	\$170		
	¾	12	28 ⅝	8	1	VSV12SP		\$389	\$427



- for use with modular configurations with an unsupported span greater than 48" NOT FOR USE ON THE END OF THE UNIT. Used as additional support for center of top
- MUST be used in conjunction with a modesty panel
- see pages [VS146-VS153](#) for modesty panels and pages [VI25-VI27](#) for selection guide
- metal attachment brackets field installed

Description	D	W	H	CTN WT	CU FT	① Model	List Price
Metal Support Rail for Modular Work Surface	2	67	¾	5	1	GP0267SB	\$112
	2	61	¾	5	1	GP0261SB	\$100
	2	55	¾	4	1	GP0255SB	\$94
	2	49	¾	4	1	GP0249SB	\$85
	2	43	¾	3	1	GP0243SB	\$80



- black metal
- includes screws for attachment to worksurfaces 1" thick and greater
- required when worksurfaces unsupported span is greater than 48"
- GP0267SB used where unsupported width span is 67" to 74"
- GP0261SB used where unsupported width span is 63" to 68"
- GP0255SB used where unsupported width span is 57" to 62"
- GP0249SB used where unsupported width span is 51" to 56"
- GP0243SB used where unsupported width span is 48" to 50"
- 30"d tops with unsupported span 63"-74" require 2 rails; 36"d & 42"d tops require 2 rails

To Order, Specify:

① Model Number

Laminate - VST

Veneer - VSV

② Worksurface Material (see page [VI3](#))

a.) TFL

b.) HPL

③ Laminate Color (see page [VI3](#))

a.) Worksurface Color

b.) Chassis Color

c.) Drawer Color

② Wood Species - Cherry (CH1), Maple (MA1)

Walnut (WA1), Black Oak (BO1) or

Double Cut (DC1) (see page [VI1](#))

③ Finish Color (see page [VI1](#))

④ Edge Profile (see page [VI4](#))

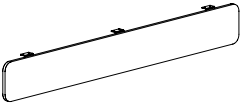
⑤ Pull Style and Color (see page [VI5](#))

⑥ Optional Grommet Location & Color - Matte Black (MBK) or Arctic Silver (ASL) (see page [VI6](#))

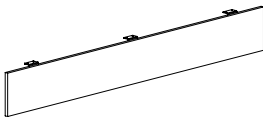
⑦ Other Product Options (see page [VI10](#))

⑧ Accessories (see page [VS314](#))

⑨ Power and Data Options (see page [VS324](#))

Description	D	W	H	CTN WT	CU FT	① Model	Laminate	Flat Cut Veneer	Double Cut Veneer
Rounded Corner Hanging Modesty Panel 	¾	77 ½	10	19	3	VST7810HMPR	\$343		
	¾	77 ½	10	19	3	VSV7810HMPR		\$749	\$825
	¾	71 ½	10	18	3	VST7210HMPR	\$335		
	¾	71 ½	10	18	3	VSV7210HMPR		\$740	\$813
	¾	65 ½	10	17	2	VST6610HMPR	\$328		
	¾	65 ½	10	17	2	VSV6610HMPR		\$734	\$807
	¾	59 ½	10	15	2	VST6010HMPR	\$319		
	¾	59 ½	10	15	2	VSV6010HMPR		\$726	\$800
	¾	53 ½	10	14	2	VST5410HMPR	\$312		
	¾	53 ½	10	14	2	VSV5410HMPR		\$717	\$789
	¾	47 ½	10	12	2	VST4810HMPR	\$294		
	¾	47 ½	10	12	2	VSV4810HMPR		\$703	\$774
	¾	41 ½	10	11	2	VST4210HMPR	\$290		
	¾	41 ½	10	11	2	VSV4210HMPR		\$692	\$762
	¾	35 ½	10	10	2	VST3610HMPR	\$283		
	¾	35 ½	10	10	2	VSV3610HMPR		\$686	\$756
¾	29 ½	10	8	1	VST3010HMPR	\$278			
¾	29 ½	10	8	1	VSV3010HMPR		\$679	\$748	

- use with table desk, peninsula desk or run-off desk
- laminates up to 60" w runs vertical grain; wider than 60" will run horizontal grain
- veneer runs vertical grain
- mounting bracket is always Black

Description	D	W	H	CTN WT	CU FT	① Model	Laminate	Flat Cut Veneer	Double Cut Veneer
Square Corner Hanging Modesty Panel 	¾	77 ⅝	10	19	3	VST7810HMPS	\$252		
	¾	77 ⅝	10	19	3	VSV7810HMPS		\$668	\$735
	¾	71 ⅝	10	18	3	VST7210HMPS	\$244		
	¾	71 ⅝	10	18	3	VSV7210HMPS		\$660	\$726
	¾	65 ⅝	10	17	2	VST6610HMPS	\$240		
	¾	65 ⅝	10	17	2	VSV6610HMPS		\$652	\$717
	¾	59 ⅝	10	15	2	VST6010HMPS	\$234		
	¾	59 ⅝	10	15	2	VSV6010HMPS		\$643	\$708
	¾	53 ⅝	10	14	2	VST5410HMPS	\$230		
	¾	53 ⅝	10	14	2	VSV5410HMPS		\$637	\$702
	¾	47 ⅝	10	12	2	VST4810HMPS	\$213		
	¾	47 ⅝	10	12	2	VSV4810HMPS		\$623	\$685
	¾	41 ⅝	10	11	2	VST4210HMPS	\$208		
	¾	41 ⅝	10	11	2	VSV4210HMPS		\$612	\$675
	¾	35 ⅝	10	10	2	VST3610HMPS	\$203		
	¾	35 ⅝	10	10	2	VSV3610HMPS		\$606	\$667
¾	29 ⅝	10	8	1	VST3010HMPS	\$196			
¾	29 ⅝	10	8	1	VSV3010HMPS		\$599	\$660	

- use with table desk, peninsula desk or run-off desk
- laminates up to 60" w runs vertical grain; wider than 60" will run horizontal grain
- veneer runs vertical grain
- mounting bracket is always Black

To Order, Specify:

① Model Number

Laminate - VST

Veneer - VSV

② Worksurface Material (see page VI3)

- a.) TFL
- b.) HPL

② Wood Species - Cherry (CH1), Maple (MA1)

- Walnut (WA1), Black Oak (BO1) or
- Double Cut (DC1) (see page VI1)

③ Laminate Color (see page VI3)

- a.) Worksurface Color
- b.) Chassis Color
- c.) Drawer Color

③ Finish Color (see page VI1)

④ Edge Profile (see page VI4)

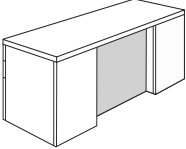
⑤ Pull Style and Color (see page VI5)

⑥ Optional Grommet Location & Color -
Matte Black (MBK) or Arctic Silver (ASL)
(see page VI6)

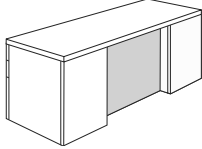
⑦ Other Product Options (see page VI10)

⑧ Accessories (see page VS314)

⑨ Power and Data Options (see page VS324)

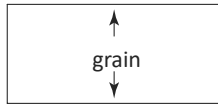
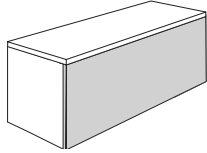
Description	D	W	H	CTN WT	CU FT	① Model	Laminate	Flat Cut Veneer	Double Cut Veneer
Modular Break Front Desk and Credenza Modesty Panel - 15 5/8" Pedestal 	3/4	58 3/8	28	35	4	VST5928MDDE	\$296		
	3/4	59 3/8	28	35	4	VSV5928MDDE		\$539	\$593
	3/4	52 3/8	28	31	4	VST5328MDDE	\$281		
	3/4	52 3/8	28	31	4	VSV5328MDDE		\$523	\$576
	3/4	46 3/8	28	28	4	VST4728MDDE	\$264		
	3/4	46 3/8	28	28	4	VSV4728MDDE		\$504	\$555
	3/4	40 3/8	28	24	4	VST4128MDDE	\$250		
	3/4	40 3/8	28	24	4	VSV4128MDDE		\$486	\$536
	3/4	34 3/8	28	21	3	VST3528MDDE	\$235		
	3/4	34 3/8	28	21	3	VSV3528MDDE		\$471	\$518
	3/4	28 3/8	28	17	2	VST2928MDDE	\$201		
3/4	28 3/8	28	17	2	VSV2928MDDE		\$460	\$506	

- use with combination or 15 5/8" w pedestals and/or wing end assemblies
 - chassis grommet available, specify and add \$49 list
 - see specification guide on pages [VI25-VI27](#) to determine proper size and model for your application
- Note: If desired application is not listed contact customer service for a quote.

Modular Break Front Desk and Credenza Modesty Panel - 18" Pedestal 	3/4	53 3/8	28	39	4	VST5428MDDE	\$283		
	3/4	53 3/8	28	39	4	VSV5428MDDE		\$525	\$579
	3/4	47 3/8	28	35	4	VST4828MDDE	\$267		
	3/4	47 3/8	28	35	4	VSV4828MDDE		\$508	\$559
	3/4	41 3/8	28	31	3	VST4228MDDE	\$251		
	3/4	41 3/8	28	31	3	VSV4228MDDE		\$489	\$539
	3/4	35 3/8	28	27	3	VST3628MDDE	\$236		
	3/4	35 3/8	28	27	3	VSV3628MDDE		\$473	\$521
	3/4	29 3/8	28	23	3	VST3028MDDE	\$213		
	3/4	29 3/8	28	23	3	VSV3028MDDE		\$462	\$508
	3/4	23 3/8	28	19	2	VST2428MDDE	\$203		
3/4	23 3/8	28	19	2	VSV2428MDDE		\$446	\$491	

- use with combination or 18" w pedestals and/or wing end assemblies
 - chassis grommet available, specify and add \$49 list
 - see specification guide on pages [VI25-VI27](#) to determine proper size and model for your application
- Note: If desired application is not listed contact customer service for a quote.

Description	D	W	H	CTN WT	CU FT	① Model	Laminate	Flat Cut Veneer	Double Cut Veneer
Modular Desk and Credenza Overlay Back Panels - Vertical Grain	¾	107 ⅞	28	76	8	VSV10828MBK		\$713	\$785
	¾	101 ⅞	28	72	7	VSV10228MBK		\$692	\$762
	¾	95 ⅞	28	68	7	VSV9628MBK		\$673	\$740
	¾	89 ⅞	28	64	6	VSV9028MBK		\$651	\$717
	¾	83 ⅞	28	60	6	VSV8428MBK		\$648	\$713
	¾	77 ⅞	28	55	6	VSV7828MBK		\$630	\$693
	¾	71 ⅞	28	51	5	VSV7228MBK		\$614	\$676
	¾	65 ⅞	28	47	5	VSV6628MBK		\$596	\$656
	¾	59 ⅞	28	35	4	VST6028MBK	\$301		
	¾	59 ⅞	28	35	4	VSV6028MBK		\$553	\$608
	¾	53 ⅞	28	32	4	VST5428MBK	\$288		
	¾	53 ⅞	28	32	4	VSV5428MBK		\$525	\$579
	¾	47 ⅞	28	28	4	VST4828MBK	\$271		
	¾	47 ⅞	28	28	4	VSV4828MBK		\$508	\$559
	¾	41 ⅞	28	25	3	VST4228MBK	\$256		
	¾	41 ⅞	28	25	3	VSV4228MBK		\$489	\$539
	¾	35 ⅞	28	21	3	VST3628MBK	\$240		
¾	35 ⅞	28	21	3	VSV3628MBK		\$481	\$529	
¾	29 ⅞	28	18	2	VST3028MBK	\$219			
¾	29 ⅞	28	18	2	VSV3028MBK		\$466	\$513	



- use with modular pedestals and/or modular end panel for shell desk and credenza
 - panel overlays the back of pedestals or end panel
 - finished on both sides so can be used for open kneespace or shell applications
 - chassis grommet available, specify and add \$49 list
 - see specification guide on pages [VI25-VI27](#) to determine proper size and model for your application
- Note: If desired application is not listed contact customer service for a quote.

To Order, Specify:

① Model Number

Laminate - VST

Veneer - VSV

② Worksurface Material (see page [VI3](#))

a.) TFL

b.) HPL

③ Laminate Color (see page [VI3](#))

a.) Worksurface Color

b.) Chassis Color

c.) Drawer Color

② Wood Species - Cherry (CH1), Maple (MA1)

Walnut (WA1), Black Oak (BO1) or

Double Cut (DC1) (see page [VI1](#))

③ Finish Color (see page [VI1](#))

④ Edge Profile (see page [VI4](#))

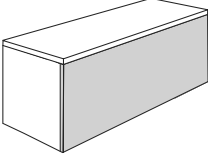

⑤ Pull Style and Color (see page [VI5](#))

⑥ Optional Grommet Location & Color -
Matte Black (MBK) or Arctic Silver (ASL)
(see page [VI6](#))

⑦ Other Product Options (see page [VI10](#))

⑧ Accessories (see page [VS314](#))

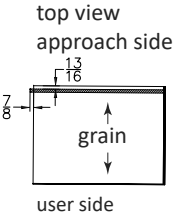
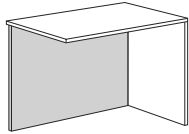
⑨ Power and Data Options (see page [VS324](#))

Description	D	W	H	CTN WT	CU FT	① Model	List Price
Modular Desk and Credenza Overlay Back Panel - Horizontal Grain  	¾	107 ⅞	28	76	8	VST28108MBK	\$436
	¾	101 ⅞	28	72	7	VST28102MBK	\$417
	¾	95 ⅞	28	68	7	VST2896MBK	\$398
	¾	89 ⅞	28	64	6	VST2890MBK	\$379
	¾	83 ⅞	28	60	6	VST2884MBK	\$359
	¾	77 ⅞	28	55	6	VST2878MBK	\$339
	¾	71 ⅞	28	51	5	VST2872MBK	\$321
	¾	65 ⅞	28	47	5	VST2866MBK	\$301
	¾	59 ⅞	28	43	5	VST2860MBK	\$282
	¾	53 ⅞	28	39	4	VST2854MBK	\$260
	¾	47 ⅞	28	35	4	VST2848MBK	\$241
	¾	41 ⅞	28	31	3	VST2842MBK	\$222
	¾	35 ⅞	28	27	3	VST2836MBK	\$202
	¾	29 ⅞	28	23	3	VST2830MBK	\$183

- use with modular pedestals and/or modular end panel for shell desk and credenza
- panel overlays the back of pedestals or end panel
- horizontal grain direction due to panel size limitations
- finished on both sides so can be used for open kneespace or shell applications
- chassis grommet available, specify and add \$49 list
- see specification guide on pages [VI25-VI27](#) to determine proper size and model for your application

Note: If desired application is not listed contact customer service for a quote.

Description	D	W	H	CTN WT	CU FT	① Model	Laminate	Flat Cut Veneer	Double Cut Veneer
Modular Shell Return	¾	84 ⅛	28	60	6	VSV8528MDRS		\$642	\$707
Modesty Panel - Vertical Grain	¾	78 ⅛	28	60	6	VSV7928MDRS		\$619	\$681
	¾	72 ⅛	28	56	6	VSV7328MDRS		\$595	\$654
	¾	66 ⅛	28	56	6	VSV6728MDRS		\$571	\$629
	¾	60 ⅛	28	52	5	VSV6128MDRS		\$558	\$614
	¾	54 ⅛	28	32	4	VST5528MDRS	\$274		
	¾	54 ¾	28	32	4	VSV5528MDRS		\$527	\$580
	¾	48 ⅛	28	28	4	VST4928MDRS	\$260		
	¾	48 ⅛	28	28	4	VSV4928MDRS		\$502	\$552
	¾	42 ⅛	28	25	3	VST4328MDRS	\$249		
	¾	42 ⅛	28	25	3	VSV4328MDRS		\$491	\$541
	¾	36 ⅛	28	21	3	VST3728MDRS	\$236		
	¾	36 ⅛	28	21	3	VSV3728MDRS		\$477	\$525



- use with modular end panels for return shell, see page [VS142](#)
- chassis grommet available, specify and add \$49 list
- vertical grain direction
- modesty panel extends 7/8" beyond the end of the top to attach to the inside of the wind end of adjacent desk
- modesty panel is inset 13/16" from the approach side of return
- can be used for left or right unit
- panel includes screw holes on end for hookup of connecting unit wing end panel
- see specification guide on pages [VI25-VI27](#) to determine proper size and model for your application

To Order, Specify:

① Model Number

Laminate - VST

Veneer - VSV

② Worksurface Material (see page [VI3](#))

- a.) TFL
- b.) HPL

② Wood Species - Cherry (CH1), Maple (MA1)

- Walnut (WA1), Black Oak (BO1) or
- Double Cut (DC1) (see page [VI1](#))

④ Edge Profile (see page [VI4](#))

⑤ Pull Style and Color (see page [VI5](#))

③ Laminate Color (see page [VI3](#))

- a.) Worksurface Color
- b.) Chassis Color
- c.) Drawer Color

③ Finish Color (see page [VI1](#))

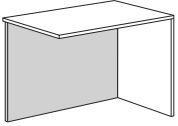
⑥ Optional Grommet Location & Color -
Matte Black (MBK) or Arctic Silver (ASL)
(see page [VI6](#))

⑦ Other Product Options (see page [VI10](#))

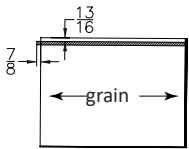
⑧ Accessories (see page [VS314](#))

⑨ Power and Data Options (see page [VS324](#))

Description	D	W	H	CTN WT	CU FT	① Model	List Price
Modular Shell Return	¾	84 ¼	28	52	5	VST2885MDRS	\$346
Modesty Panel - Horizontal Grain	¾	78 ¼	28	47	5	VST2879MDRS	\$334
	¾	72 ¼	28	47	5	VST2873MDRS	\$321
	¾	66 ¼	28	43	5	VST2867MDRS	\$301
	¾	60 ¼	28	43	5	VST2861MDRS	\$291

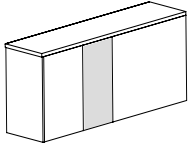


top view
approach side



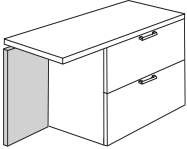
user side

- use with modular end panels for return shell, see page [VS142](#)
- chassis grommet available, specify and add \$49 list
- horizontal grain direction due to panel size limitations
- modesty panel extends 7/8" beyond the end of the top to attach to the inside of the wind end of adjacent desk
- modesty panel is inset 1/16" from the approach side of return
- can be used for left or right unit
- panel includes screw holes on end for hookup of connecting unit wing end panel
- see specification guide on pages [VI25-VI27](#) to determine proper size and model for your application

Description	D	W	H	CTN WT	CU FT	① Model	Laminate	Flat Cut Veneer	Double Cut Veneer
Modular Credenza Modesty Panels 	¾	56 ¾	28	34	5	VST5728MDCG	\$277		
	¾	56 ¾	28	34	5	VSV5728MDCG		\$527	\$580
	¾	50 ¾	28	30	4	VST5128MDCG	\$267		
	¾	50 ¾	28	30	4	VSV5128MDCG		\$505	\$555
	¾	44 ¾	28	26	4	VST4528MDCG	\$255		
	¾	44 ¾	28	26	4	VSV4528MDCG		\$499	\$549
	¾	38 ¾	28	23	4	VST3928MDCG	\$241		
	¾	38 ¾	28	23	4	VSV3928MDCG		\$484	\$531
	¾	32 ¾	28	19	3	VST3328MDCG	\$228		
	¾	32 ¾	28	19	3	VSV3328MDCG		\$462	\$507
	¾	26 ¾	28	16	2	VST2728MDCG	\$213		
	¾	26 ¾	28	16	2	VSV2728MDCG		\$454	\$499
	¾	20 ¾	28	12	2	VST2128MDCG	\$200		
	¾	20 ¾	28	12	2	VSV2128MDCG		\$460	\$506
	¾	14 ¾	28	9	2	VST1528MDCG	\$190		
¾	14 ¾	28	9	2	VSV1528MDCG		\$425	\$468	

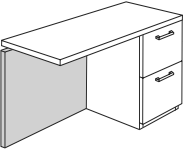
- use with one lateral file width pedestal and one 15 ¾" wing end assembly
 - chassis grommet available, specify and add \$49 list
 - see specification guide on pages [VI25-VI27](#) to determine proper size and model for your application
- Note: If desired application is not listed contact customer service for a quote.

To Order, Specify:	
① Model Number	Laminate - VST Veneer - VSV
② Worksurface Material (see page VI3)	② Wood Species - Cherry (CH1), Maple (MA1) Walnut (WA1), Black Oak (BO1) or Double Cut (DC1) (see page VI1)
a.) TFL	
b.) HPL	
③ Laminate Color (see page VI3)	③ Finish Color (see page VI1)
a.) Worksurface Color	
b.) Chassis Color	
c.) Drawer Color	
	④ Edge Profile (see page VI4)
	⑤ Pull Style and Color (see page VI5)
	⑥ Optional Grommet Location & Color - Matte Black (MBK) or Arctic Silver (ASL) (see page VI6)
	⑦ Other Product Options (see page VI10)
	⑧ Accessories (see page VS314)
	⑨ Power and Data Options (see page VS324)

Description	D	W	H	CTN WT	CU FT	① Model	Laminate	Flat Cut Veneer	Double Cut Veneer
Modular Pedestal Return Modesty Panel 	¾	54 1⁄16	28	40	4	VST5528MDRB	\$274		
	¾	54 1⁄16	28	40	4	VSV5528MDRB		\$527	\$580
	¾	48 1⁄16	28	36	4	VST4928MDRB	\$260		
	¾	48 1⁄16	28	36	4	VSV4928MDRB		\$502	\$552
	¾	42 1⁄16	28	32	3	VST4328MDRB	\$249		
	¾	42 1⁄16	28	32	3	VSV4328MDRB		\$491	\$541
	¾	36 1⁄16	28	28	3	VST3728MDRB	\$236		
	¾	36 1⁄16	28	28	3	VSV3728MDRB		\$477	\$525
	¾	30 1⁄16	28	19	3	VST3128MDRB	\$222		
	¾	30 1⁄16	28	19	3	VSV3128MDRB		\$462	\$507
	¾	24 1⁄16	28	15	2	VST2528MDRB	\$205		
	¾	24 1⁄16	28	15	2	VSV2528MDRB		\$446	\$491
	¾	18 1⁄16	28	12	2	VST1828MDRB	\$195		
	¾	18 1⁄16	28	12	2	VSV1828MDRB		\$428	\$471
	¾	12 1⁄16	28	8	1	VST1328MDRB	\$189		
	¾	12 1⁄16	28	8	1	VSV1328MDRB		\$414	\$455
¾	6 1⁄16	28	5	1	VST0728MDRB	\$179			
¾	6 1⁄16	28	5	1	VSV0728MDRB		\$399	\$439	

* If desired application is not listed, contact customer service for a quote.

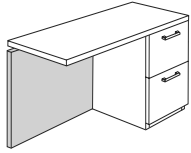
- use with lateral file or multi-file modular pedestals
- can be used for left or right unit
- panel butts to side of pedestal (pedestal back panel purchased separately)
- panel includes screw holes on end for hookup of return unit to desk unit
- extends 7/8" inside of connecting unit wing end panel
- chassis grommet available, specify and add \$49 list
- see specification guide on pages [VI25-VI27](#) to determine proper size and model for your application

Modular Pedestal Return Modesty Panel - 15 5⁄8" w Ped 	¾	57 3⁄16	28	41	4	VST5728MDRA	\$277		
	¾	57 3⁄16	28	41	4	VSV5728MDRA		\$527	\$580
	¾	51 3⁄16	28	37	4	VST5128MDRA	\$267		
	¾	51 3⁄16	28	37	4	VSV5128MDRA		\$505	\$555
	¾	45 3⁄16	28	27	4	VST4528MDRA	\$255		
	¾	45 3⁄16	28	27	4	VSV4528MDRA		\$499	\$549
	¾	39 3⁄16	28	23	3	VST3928MDRA	\$241		
	¾	39 3⁄16	28	23	3	VSV3928MDRA		\$484	\$531
	¾	33 3⁄16	28	20	3	VST3328MDRA	\$228		
	¾	33 3⁄16	28	20	3	VSV3328MDRA		\$462	\$507
	¾	27 3⁄16	28	16	2	VST2728MDRA	\$213		
	¾	27 3⁄16	28	16	2	VSV2728MDRA		\$454	\$499
	¾	21 3⁄16	28	13	2	VST2128MDRA	\$200		
	¾	21 3⁄16	28	13	2	VSV2128MDRA		\$433	\$477

* If desired application is not listed, contact customer service for a quote.

- use with 15 5/8" w modular pedestal or wing end assembly
- can be used for left or right unit
- panel butts to side of pedestal (pedestal back panel purchased separately)
- panel includes screw holes on end for hookup of return unit to desk unit
- extends 7/8" inside of connecting unit wing end panel
- chassis grommet available, specify and add \$49 list
- see specification guide on pages [VI25-VI27](#) to determine proper size and model for your application

Description	D	W	H	CTN WT	CU FT	① Model	Laminate	Flat Cut Veneer	Double Cut Veneer
Modular Pedestal Return	¾	54 13/16	28	40	4	VST5528MDRA	\$273		
Modesty Panel - 18" w Ped	¾	54 13/16	28	40	4	VSV5528MDRA		\$527	\$580
	¾	48 13/16	28	36	4	VST4928MDRA	\$260		
	¾	48 13/16	28	36	4	VSV4928MDRA		\$505	\$555
	¾	42 13/16	28	32	3	VST4328MDRA	\$249		
	¾	42 13/16	28	32	3	VSV4328MDRA		\$491	\$541
	¾	36 13/16	28	28	3	VST3728MDRA	\$235		
	¾	36 13/16	28	28	3	VSV3728MDRA		\$477	\$525
	¾	30 13/16	28	23	3	VST3128MDRA	\$222		
	¾	30 13/16	28	23	3	VSV3128MDRA		\$462	\$507
	¾	24 13/16	28	19	2	VST2528MDRA	\$205		
	¾	24 13/16	28	19	2	VSV2528MDRA		\$446	\$491
	¾	18 13/16	28	15	2	VST1928MDRA	\$195		
	¾	18 13/16	28	15	2	VSV1928MDRA		\$433	\$477



* If desired application is not listed, contact customer service for a quote.

- use with 18" w modular pedestal or wing end assembly
- can be used for left or right unit
- panel butts to side of pedestal (pedestal back panel purchased separately)
- panel includes screw holes on end for hookup of return unit to desk unit
- extends 7/8" inside of connecting unit back panel
- chassis grommet available, specify and add \$49 list
- see specification guide on pages [VI25-VI27](#) to determine proper size and model for your application

To Order, Specify:

① Model Number

Laminate - VST

Veneer - VSV

② Worksurface Material (see page [VI3](#))

a.) TFL

b.) HPL

③ Laminate Color (see page [VI3](#))

a.) Worksurface Color

b.) Chassis Color

c.) Drawer Color

② Wood Species - Cherry (CH1), Maple (MA1)

Walnut (WA1), Black Oak (BO1) or

Double Cut (DC1) (see page [VI1](#))

③ Finish Color (see page [VI1](#))

④ Edge Profile (see page [VI4](#))

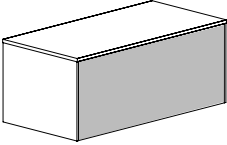
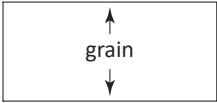
⑤ Pull Style and Color (see page [VI5](#))

⑥ Optional Grommet Location & Color - Matte Black (MBK) or Arctic Silver (ASL) (see page [VI6](#))

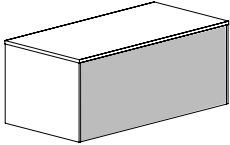

⑦ Other Product Options (see page [VI10](#))

⑧ Accessories (see page [VS314](#))

⑨ Power and Data Options (see page [VS324](#))

Description	D	W	H	CTN WT	CU FT	① Model	Laminate	Flat Cut Veneer	Double Cut Veneer
Modular Desk Shell Modesty Panel - Vertical Grain  	¾	106 ¾	28	75	8	VSV10828MODF		\$713	\$785
	¾	100 ¾	28	71	7	VSV10228MODF		\$692	\$762
	¾	94 ¾	28	67	7	VSV9628MODF		\$673	\$740
	¾	88 ¾	28	63	6	VSV9028MODF		\$651	\$717
	¾	82 ¾	28	59	6	VSV8428MODF		\$648	\$713
	¾	76 ¾	28	54	6	VSV7828MODF		\$630	\$693
	¾	70 ¾	28	50	5	VSV7228MODF		\$614	\$676
	¾	64 ¾	28	46	5	VSV6628MODF		\$596	\$656
	¾	58 ¾	28	42	4	VST6028MODF	\$263		
	¾	58 ¾	28	42	4	VSV6028MODF		\$567	\$625
	¾	52 ¾	28	38	4	VST5428MODF	\$246		
	¾	52 ¾	28	38	4	VSV5428MODF		\$550	\$605
	¾	46 ¾	28	34	4	VST4828MODF	\$232		
	¾	46 ¾	28	34	4	VSV4828MODF		\$530	\$584
	¾	40 ¾	28	30	3	VST4228MODF	\$220		
	¾	40 ¾	28	30	3	VSV4228MODF		\$513	\$565
	¾	34 ¾	28	26	3	VST3628MODF	\$208		
	¾	34 ¾	28	26	3	VSV3628MODF		\$496	\$545
	¾	28 ¾	28	22	2	VST3028MODF	\$196		
	¾	28 ¾	28	22	2	VSV3028MODF		\$480	\$528

- used to make a desk shell with inset modesty
- vertical grain direction

Description	D	W	H	CTN WT	CU FT	① Model	List Price
Laminate Modular Desk Shell Modesty Panel - Horizontal Grain  	¾	106 ⅜	28	75	8	VST28108MODF	\$359
	¾	100 ⅜	28	71	7	VST28102MODF	\$348
	¾	94 ⅜	28	67	7	VST2896MODF	\$335
	¾	88 ⅜	28	63	6	VST2890MODF	\$320
	¾	82 ⅜	28	59	6	VST2884MODF	\$310
	¾	76 ⅜	28	54	6	VST2878MODF	\$298
	¾	70 ⅜	28	50	5	VST2872MODF	\$285
	¾	64 ⅜	28	46	5	VST2866MODF	\$273
	¾	58 ⅜	28	42	4	VST2860MODF	\$263
	¾	52 ⅜	28	38	4	VST2854MODF	\$246
	¾	46 ⅜	28	34	4	VST2848MODF	\$232
	¾	40 ⅜	28	30	3	VST2842MODF	\$220
	¾	34 ⅜	28	26	3	VST2836MODF	\$208
	¾	28 ⅜	28	22	2	VST2830MODF	\$196

- used to make desk shell with inset modesty
- horizontal grain direction due to panel size limitations

To Order, Specify:

① Model Number

Laminate - VST

Veneer - VSV

② Worksurface Material (see page VI3)

a.) TFL

b.) HPL

③ Laminate Color (see page VI3)

a.) Worksurface Color

b.) Chassis Color

c.) Drawer Color

② Wood Species - Cherry (CH1), Maple (MA1)

Walnut (WA1), Black Oak (BO1) or

Double Cut (DC1) (see page VI1)

③ Finish Color (see page VI1)

④ Edge Profile (see page VI4)

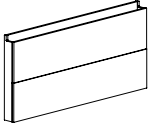
⑤ Pull Style and Color (see page VI5)

⑥ Optional Grommet Location & Color -
Matte Black (MBK) or Arctic Silver (ASL)
(see page VI6)

⑦ Other Product Options (see page VI10)

⑧ Accessories (see page VS314)

⑨ Power and Data Options (see page VS324)

Description	D	W	H	CTN WT	CU FT	① Model	Laminate	Flat Cut Veneer	Double Cut Veneer
Wall Access Modesty Panel for Bridge 	4 ¼	61 ½	28	60	7	VST6028WABM	\$835		
	4 ¼	61 ½	28	60	7	VSV6028WABM		\$1,514	\$1,667
	4 ¼	55 ½	28	54	7	VST5428WABM	\$806		
	4 ¼	55 ½	28	54	7	VSV5428WABM		\$1,463	\$1,610
	4 ¼	49 ½	28	48	6	VST4828WABM	\$778		
	4 ¼	49 ½	28	48	6	VSV4828WABM		\$1,413	\$1,555
	4 ¼	43 ½	28	42	5	VST4228WABM	\$751		
	4 ¼	43 ½	28	42	5	VSV4228WABM		\$1,365	\$1,502
	4 ¼	37 ½	28	36	5	VST3628WABM	\$725		
4 ¼	37 ½	28	36	5	VSV3628WABM		\$1,319	\$1,450	

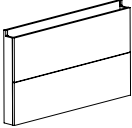
- use with desk and credenzas
- use as an alternative to bridge modesty
- top panel folds down to access wall outlets

Wall Access Modesty Panel for Return 	4 ¼	42 1/16	28	41	5	VST4328WARM	\$744		
	4 ¼	42 1/16	28	41	5	VSV4328WARM		\$1,375	\$1,512
	4 ¼	36 1/16	28	35	5	VST3728WARM	\$718		
	4 ¼	36 1/16	28	35	5	VSV3728WARM		\$1,327	\$1,461
	4 ¼	30 1/16	28	29	4	VST3128WARM	\$693		
	4 ¼	30 1/16	28	29	4	VSV3128WARM		\$1,288	\$1,418
	4 ¼	24 1/16	28	23	3	VST2528WARM	\$670		
	4 ¼	24 1/16	28	23	3	VSV2528WARM		\$1,244	\$1,369
	4 ¼	18 1/16	28	17	3	VST1928WARM	\$647		
4 ¼	18 1/16	28	17	3	VSV1928WARM		\$1,201	\$1,322	

- use for return with a 18" w pedestal
- use with peninsula workwall desk
- use as an alternative to bridge modesty
- top panel folds down to access wall outlets

Wall Access Modesty Panel for Return 	4 ¼	45 1/16	28	43	6	VST4628WARM	\$757		
	4 ¼	45 1/16	28	43	6	VSV4628WARM		\$1,384	\$1,524
	4 ¼	39 1/16	28	37	5	VST4028WARM	\$731		
	4 ¼	39 1/16	28	37	5	VSV4028WARM		\$1,337	\$1,471
	4 ¼	33 1/16	28	31	4	VST3428WARM	\$707		
	4 ¼	33 1/16	28	31	4	VSV3428WARM		\$1,298	\$1,427
	4 ¼	27 1/16	28	25	4	VST2828WARM	\$682		
	4 ¼	27 1/16	28	25	4	VSV2828WARM		\$1,253	\$1,380
	4 ¼	21 1/16	28	20	3	VST2228WARM	\$660		
4 ¼	21 1/16	28	20	3	VSV2228WARM		\$1,211	\$1,333	

- use for return with a 15 3/8" w pedestal
- use with peninsula workwall desk
- use as an alternative to bridge modesty
- top panel folds down to access wall outlets

Description	D	W	H	CTN WT	CU FT	① Model	Laminate	Flat Cut Veneer	Double Cut Veneer
Wall Access Modesty Panel for Credenza 	4 ¼	47 ⅞	28	46	6	VST4828WADM	\$755		
	4 ¼	47 ⅞	28	46	6	VSV4828WADM		\$1,390	\$1,531
	4 ¼	41 ⅞	28	40	5	VST4228WADM	\$734		
	4 ¼	41 ⅞	28	40	5	VSV4228WADM		\$1,344	\$1,478
	4 ¼	35 ⅞	28	34	5	VST3628WADM	\$713		
	4 ¼	35 ⅞	28	34	5	VSV3628WADM		\$1,298	\$1,427
	4 ¼	29 ⅞	28	28	4	VST3028WADM	\$693		
	4 ¼	29 ⅞	28	28	4	VSV3028WADM		\$1,253	\$1,380
	4 ¼	23 7/8	28	22	3	VST2428WADM	\$673		
	4 ¼	23 ⅞	28	22	3	VSV2428WADM		\$1,220	\$1,343

- use for return with a 18" w pedestal
- use as an alternative to credenza modesty
- top panel folds down to access wall outlets

Wall Access Modesty Panel for Credenza 	4 ¼	52 ⅞	28	50	6	VST5328WADM	\$764		
	4 ¼	52 ⅞	28	50	6	VSV5328WADM		\$1,430	\$1,574
	4 ¼	46 ⅞	28	44	6	VST4728WADM	\$738		
	4 ¼	46 ⅞	28	44	6	VSV4728WADM		\$1,382	\$1,521
	4 ¼	40 ⅞	28	38	5	VST4128WADM	\$713		
	4 ¼	40 ⅞	28	38	5	VSV4128WADM		\$1,335	\$1,469
	4 ¼	34 ⅞	28	32	4	VST3528WADM	\$688		
	4 ¼	34 ⅞	28	32	4	VSV3528WADM		\$1,289	\$1,419
	4 ¼	28 ⅞	28	26	4	VST2928WADM	\$664		
	4 ¼	28 ⅞	28	26	4	VSV2928WADM		\$1,246	\$1,370

- use for return with a 15 ⅞" w pedestal
- use as an alternative to credenza modesty
- top panel folds down to access wall outlets

To Order, Specify:

① Model Number

Laminate - VST

Veneer - VSV

② Worksurface Material (see page VI3)

a.) TFL

b.) HPL

③ Laminate Color (see page VI3)

a.) Worksurface Color

b.) Chassis Color

c.) Drawer Color

② Wood Species - Cherry (CH1), Maple (MA1)

Walnut (WA1), Black Oak (BO1) or

Double Cut (DC1) (see page VI1)

③ Finish Color (see page VI1)

④ Edge Profile (see page VI4)

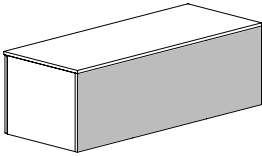
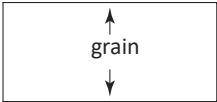
⑤ Pull Style and Color (see page VI5)

⑥ Optional Grommet Location & Color -
Matte Black (MBK) or Arctic Silver (ASL)
(see page VI6)

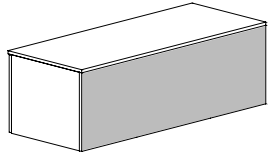
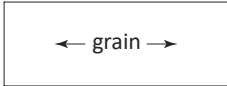
⑦ Other Product Options (see page VI10)

⑧ Accessories (see page VS314)

⑨ Power and Data Options (see page VS324)

Description	D	W	H	CTN WT	CU FT	① Model	Laminate	Flat Cut Veneer	Double Cut Veneer
Modular Back Panel for Bench Height - Vertical Grain  	¾	108	18 ¾	54	4	VSVB10819MBK		\$579	\$637
	¾	102	18 ¾	50	4	VSVB10219MBK		\$563	\$620
	18 ¾	96	18 ¾	49	4	VSVB9619MBK		\$547	\$602
	18 ¾	90	18 ¾	46	4	VSVB9019MBK		\$531	\$585
	18 ¾	84	18 ¾	41	4	VSVB8419MBK		\$515	\$567
	18 ¾	78	18 ¾	39	3	VSVB7819MBK		\$500	\$550
	18 ¾	72	18 ¾	36	3	VSVB7219MBK		\$483	\$532
	18 ¾	66	18 ¾	33	3	VSVB6619MBK		\$467	\$514
	18 ¾	60	18 ¾	30	2	VSTB6019MBK	\$255		
	18 ¾	60	18 ¾	30	2	VSVB6019MBK		\$451	\$497
	18 ¾	54	18 ¾	27	2	VSTB5419MBK	\$240		
	18 ¾	54	18 ¾	27	2	VSVB5419MBK		\$435	\$479
	18 ¾	48	18 ¾	24	2	VSTB4819MBK	\$223		
	18 ¾	48	18 ¾	24	2	VSVB4819MBK		\$420	\$462
	18 ¾	36	18 ¾	18	2	VSTB3619MBK	\$193		
	18 ¾	36	18 ¾	18	2	VSVB3619MBK		\$388	\$427
	18 ¾	30	18 ¾	15	2	VSTB3019MBK	\$175		
	18 ¾	30	18 ¾	15	2	VSVB3019MBK		\$372	\$409
	18 ¾	18	18 ¾	9	1	VSTB1819MBK	\$146		
	18 ¾	18	18 ¾	9	1	VSVB1819MBK		\$340	\$375

- use with bench height modular pedestals
- panel overlays the back of pedestal
- finished on both sides
- provides a finished back for modular pedestals
- vertical grain direction

Description	D	W	H	CTN WT	CU FT	1 Model	List Price
Laminate Modular Back Panel for Bench Height - Horizontal Grain  	¾	108	18 ¾	54	4	VSTB19108MBK	\$382
	¾	102	18 ¾	50	4	VSTB19102MBK	\$366
	¾	96	18 ¾	49	4	VSTB1996MBK	\$349
	¾	90	18 ¾	46	4	VSTB1990MBK	\$335
	¾	84	18 ¾	41	4	VSTB1984MBK	\$318
	¾	78	18 ¾	39	3	VSTB1978MBK	\$302
	¾	72	18 ¾	36	3	VSTB1972MBK	\$288
	¾	66	18 ¾	33	3	VSTB1966MBK	\$270
	¾	60	18 ¾	30	2	VSTB1960MBK	\$255
	¾	54	18 ¾	27	2	VSTB1954MBK	\$240
	¾	48	18 ¾	24	2	VSTB1948MBK	\$223
	¾	36	18 ¾	18	2	VSTB1936MBK	\$193
	¾	30	18 ¾	15	2	VSTB1930MBK	\$175
	¾	18	18 ¾	9	1	VSTB1918MBK	\$146

- use with bench height modular pedestals
- panel overlays the back of pedestal
- finished on both sides
- provides a finished back for modular pedestals
- horizontal grain direction

To Order, Specify:

1 Model Number

Laminate - VST

Veneer - VSV

2 Worksurface Material (see page VI3)

- a.) TFL
- b.) HPL

3 Laminate Color (see page VI3)

- a.) Worksurface Color
- b.) Chassis Color
- c.) Drawer Color

2 Wood Species - Cherry (CH1), Maple (MA1)

- Walnut (WA1), Black Oak (BO1) or
- Double Cut (DC1) (see page VI1)

3 Finish Color (see page VI1)

4 Edge Profile (see page VI4)

5 Pull Style and Color (see page VI5)

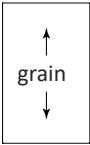
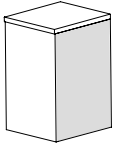
6 Optional Grommet Location & Color -
Matte Black (MBK) or Arctic Silver (ASL)
(see page VI6)

7 Other Product Options (see page VI10)

8 Accessories (see page VS314)

9 Power and Data Options (see page VS324)

Description	D	W	H	CTN WT	CU FT	① Model	Laminate	Flat Cut Veneer	Double Cut Veneer
Modular Full Height Back Panel for Modular Pedestal	¾	35 ⅞	28	21	3	VST3628MPBK	\$184		
	¾	35 ⅞	28	21	3	VSV3628MPBK		\$458	\$504
	¾	29 ⅞	28	18	2	VST3028MPBK	\$172		
	¾	29 ⅞	28	18	2	VSV3028MPBK		\$441	\$486
	¾	18	28	15	2	VST1828MPBK	\$155		
	¾	18	28	15	2	VSV1828MPBK		\$438	\$481
	¾	15 ⅞	28	9	2	VST1628MPBK	\$145		
	¾	15 ⅞	28	9	2	VSV1628MPBK		\$404	\$445



- use on back of modular pedestals
 - panel overlays the back of pedestals
 - see specification guide on pages [VI25-VI27](#) to determine proper size and model for your application
- Note: If desired application is not listed contact customer service for a quote.

Modular Filler Back Panel	¾	4	28	4	1	VST0428MBK	\$156		
	¾	4	28	4	1	VSV0428MBK		\$392	\$432



- use on backside of modular pedestal to fill gap created when back panel not specified
- fills space between pedestal and wall at end of modular run
- vertical grain

Filler Back Panel for Bench Height	¾	4	18 ¾	3	1	VSTB0419MBK	\$90		
	¾	4	18 ¾	3	1	VSVB0419MBK		\$303	\$334



- use on backside of modular pedestal to fill gap created when back panel not specified
- fills space between pedestal and wall at end of modular run
- vertical grain

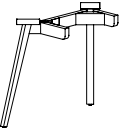
Description	D	W	H	CTN WT	CU FT	① Model	Laminate	Flat Cut Veneer	Double Cut Veneer
Peninsula Base Support - Executive Base	1 ½	12 ½	28 ⅝	21	2	VST1328PEXB	\$630		
	1 ½	12 ½	28 ⅝	21	2	VSV1328PEXB		\$1,033	\$1,114




- used with peninsula and run-off desk
- specify Matte Black (MBK), Arctic Silver (ASL), Pewter (PEW), Soft Nickel (SNK), Soft Bronze (SBZ), Aged Bronze (ABZ) or Gold (GLD) metal finish

To Order, Specify:

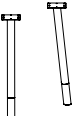
① Model Number	Laminate - VST	Veneer - VSV	
	<p>② Worksurface Material (see page VI3)</p> <p>a.) TFL</p> <p>b.) HPL</p> <p>③ Laminate Color (see page VI3)</p> <p>a.) Worksurface Color</p> <p>b.) Chassis Color</p> <p>c.) Drawer Color</p>	<p>② Wood Species - Cherry (CH1), Maple (MA1) Walnut (WA1), Black Oak (BO1) or Double Cut (DC1) (see page VI1)</p> <p>③ Finish Color (see page VI1)</p>	<p>④ Edge Profile (see page VI4)</p> <p>⑤ Pull Style and Color (see page VI5)</p> <p>⑥ Optional Grommet Location & Color - Matte Black (MBK) or Arctic Silver (ASL) (see page VI6)</p> <p>⑦ Other Product Options (see page VI10)</p> <p>⑧ Accessories (see page VS314)</p> <p>⑨ Power and Data Options (see page VS324)</p>

Description	D	W	H	CTN WT	CU FT	① Model	List Price
Taper Base 	17 ½	33 ¾	28 ⅝	12	12	VSV3428PAB	\$1,233
	17 ½	27 ⅞	28 ⅝	11	11	VSV2828PAB	\$1,224

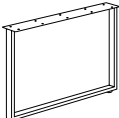
- used with peninsula and run-off desk
- specify wood finish no upcharge or paint with upcharge of \$45

Truss Base 	1 ¾	29 ½	28 ⅝	7	4	VSV3028PXB	\$1,150
---	-----	------	------	---	---	-------------------	----------------

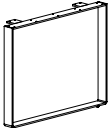
- used with peninsula and run-off desk 30" or 36" deep and 72" long or less
- specify wood finish
- total weight limit of items placed on peninsula is 150 lbs. maximum

Dowel Base (2 Leg Support) 	2	2	28 ⅝	15	2	VSV0228MKL2	\$788
---	---	---	------	----	---	--------------------	--------------


- used with peninsula and run-off desk
- legs are metal with wood feet
- specify wood finish no upcharge or paint with upcharge of \$45
- specify Matte Black (MBK), Arctic Silver (ASL), Pewter (PEW), Soft Nickel (SNK), Soft Bronze (SBZ), Aged Bronze (ABZ) or Gold (GLD) metal finish

Rectangular Base 	2	35 ⅞	28 ⅝	18	4	VSB3628FSQ	\$659
	2	29 ⅞	28 ⅝	16	3	VSB3028FSQ	\$637
	2	23 ⅞	28 ⅝	14	3	VSB2428FSQ	\$601

- used with peninsula and run-off desk
- VSB3628FSQ use with 36" d tops, VSB3028FSQ use with 30" d tops, VSB2428FSQ use with 24" d tops
- specify Matte Black (MBK), Arctic Silver (ASL), Pewter (PEW), Soft Nickel (SNK), Soft Bronze (SBZ), Aged Bronze (ABZ) or Gold (GLD) metal finish

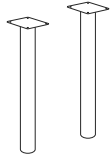
Perimeter Base 	3	35 ⅞	28 ⅝	58	4	VSB3628CPS	\$2,053
	3	29 ⅞	28 ⅝	53	3	VSB3028CPS	\$1,955

- used with peninsula and run-off desk
- VSB3628CPS use with 36" d tops, VSB3028CPS use with 30" d tops
- chrome metal finish

Column Base 	4	4	28 ⅝	10	2	GP0428COL	\$448
--	---	---	------	----	---	------------------	--------------

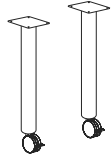
- used with peninsula and run-off desk
- 13 gauge steel
- specify Matte Black (MBK) or Arctic Silver (ASL) metal finish

Description	D	W	H	CTN WT	CU FT	1 Model	List Price
Metal Legs	2	2	28 3/16	12	1	VSB28LEG2	\$367



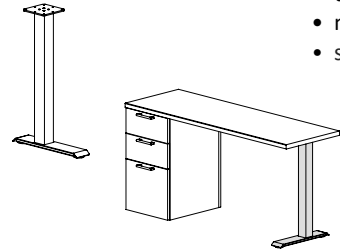
- set of two legs
- 2" diameter column
- 6" square mounting plate
- wood screws included for attachment to top
- specify Matte Black (MBK) or Arctic Silver (ASL)

Metal Legs with Casters	2	2	28 3/16	12	1	VSB28LEG2C	\$382
--------------------------------	---	---	---------	----	---	-------------------	--------------



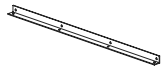
- set of two legs
- 2" diameter column
- 6" square mounting plate
- wood screws included for attachment to top
- specify Matte Black (MBK) or Arctic Silver (ASL)
- black nylon locking casters

Fixed Height T-Base	18	3 3/8	28	28	1	VSB0418FTB	\$381
----------------------------	----	-------	----	----	---	-------------------	--------------



- used on one end of modular return or bridge when placed alongside height adjustable T-base units
- not intended to be used as a set for freestanding
- specify Matte Black (MBK), Arctic Silver (ASL) or White (WH) metal finish

L-Bracket	1	27	1	4	1	VSB-LBRKT-30	\$103
	1	21	1	4	1	VSB-LBRKT-24	\$97
	1	17	1	3	1	VSB-LBRKT-20	\$92



- attach to tall storage or wall
- silver finish
- VSB-LBRKT-30 typically used with 30"d tops
- VSB-LBRKT-24 typically used with 24"d tops
- VSB-LBRKT-20 typically used with 20"d tops

To Order, Specify:

1 Model Number

Laminate - VST

Veneer - VSV

2 Worksurface Material (see page VI3)

a.) TFL

b.) HPL

3 Laminate Color (see page VI3)

a.) Worksurface Color

b.) Chassis Color

c.) Drawer Color

2 Wood Species - Cherry (CH1), Maple (MA1)

Walnut (WA1), Black Oak (BO1) or

Double Cut (DC1) (see page VI1)

3 Finish Color (see page VI1)

4 Edge Profile (see page VI4)

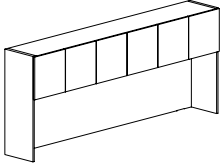
5 Pull Style and Color (see page VI5)

6 Optional Grommet Location & Color - Matte Black (MBK) or Arctic Silver (ASL) (see page VI6)

7 Other Product Options (see page VI10)

8 Accessories (see page VS314)

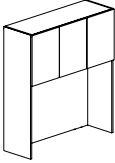
9 Power and Data Options (see page VS324)

Description	D	W	H	CTN WT	CU FT	① Model	Laminate		Flat Cut Veneer			Double Cut Veneer			
							Laminate Door	Alum. Frm Glass Door	Veneer Door	Alum. Frm Glass Door	Wood Frm Glass Door	Veneer Door	Alum. Frm Glass Door	Wood Frm Glass Door	
Storage Overhead Cabinet with Six Doors 	16 3/16	107 3/4	42 1/2	327	51	VST16108SO	\$2,463	\$3,894							
	16 3/16	107 3/4	42 1/2	327	51	VSV16108SO			\$4,479	\$5,911	\$4,981	\$4,928	\$6,360	\$5,430	
	16 3/16	101 3/4	42 1/2	309	48	VST16102SO	\$2,324	\$3,717							
	16 3/16	101 3/4	42 1/2	309	48	VSV16102SO			\$4,155	\$5,548	\$4,657	\$4,572	\$5,965	\$5,074	
	16 3/16	95 3/4	42 1/2	291	45	VST1696SO	\$2,193	\$3,551							
	16 3/16	95 3/4	42 1/2	291	45	VSV1696SO			\$3,843	\$5,201	\$4,345	\$4,230	\$5,588	\$4,732	
	16 3/16	89 3/4	42 1/2	273	43	VST1690SO	\$2,068	\$3,388							
	16 3/16	89 3/4	42 1/2	273	43	VSV1690SO			\$3,537	\$4,857	\$4,039	\$3,893	\$5,214	\$4,396	

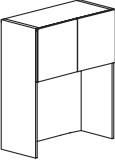
- select door style
- aluminum frame door offered in both frosted or white back painted glass, specify when ordering
- white markerboard doors available, specify and add \$635 list to laminate or veneer door price
- locking available on laminate or wood doors, specify and add \$115 list; glass doors are non-locking
- small grommet in top of back to fit LED lights
- tackboards available, see pages [VS172-VS175](#) or [VS176-VS179](#)
- tasklights available, see pages [VS318](#)
- 25" vertical clearance from desk top to bottom of valance rail
- pulls not available

Description	D	W	H	CTN WT	CU FT	① Model	Laminate		Flat Cut Veneer			Double Cut Veneer			
							Laminate Door	Alum. Frm Glass Door	Veneer Door	Alum. Frm Glass Door	Wood Frm Glass Door	Veneer Door	Alum. Frm Glass Door	Wood Frm Glass Door	
Storage Overhead Cabinet with Four Doors 	16 3/16	77 3/4	42 1/2	244	40	VST1684SO	\$1,951	\$2,981							
	16 3/16	83 3/4	42 1/2	244	40	VSV1684SO			\$3,263	\$4,293	\$3,704	\$3,590	\$4,620	\$4,031	
	16 3/16	77 3/4	42 1/2	231	37	VST1678SO	\$1,839	\$2,834							
	16 3/16	77 3/4	42 1/2	231	37	VSV1678SO			\$3,044	\$4,038	\$3,484	\$3,349	\$4,343	\$3,790	
	16 3/16	71 3/4	42 1/2	218	34	VST1672SO	\$1,735	\$2,689							
	16 3/16	71 3/4	42 1/2	218	34	VSV1672SO			\$2,840	\$3,794	\$3,280	\$3,124	\$4,078	\$3,564	
	16 3/16	65 3/4	42 1/2	206	32	VST1666SO	\$1,640	\$2,558							
	16 3/16	65 3/4	42 1/2	206	32	VSV1666SO			\$2,712	\$3,629	\$3,152	\$2,984	\$3,902	\$3,425	
	16 3/16	59 3/4	42 1/2	193	29	VST1660SO	\$1,553	\$2,434							
	16 3/16	59 3/4	42 1/2	193	29	VSV1660SO			\$2,591	\$3,471	\$3,031	\$2,850	\$3,730	\$3,291	
	16 3/16	53 3/4	42 1/2	175	26	VST1654SO	\$1,469	\$2,312							
	16 3/16	53 3/4	42 1/2	175	26	VSV1654SO			\$2,491	\$3,334	\$2,932	\$2,740	\$3,583	\$3,181	

- select door style
- aluminum frame door offered in both frosted or white back painted glass, specify when ordering
- white markerboard doors available, specify and add \$557 list to laminate or veneer door price
- locking available on laminate or wood doors, specify and add \$79 list; glass doors are non-locking
- small grommet in top of back to fit LED lights
- tackboards available, see pages [VS172-VS175](#) or [VS176-VS179](#)
- tasklights available, see pages [VS318](#)
- 25" vertical clearance from desk top to bottom of valance rail
- pulls not available

Description	D	W	H	CTN WT	CU FT	① Model	Laminate		Flat Cut Veneer			Double Cut Veneer		
							Laminate Door	Alum. Frm Glass Door	Veneer Door	Alum. Frm Glass Door	Wood Glass Door	Veneer Door	Alum. Frm Glass Door	Wood Frm Glass Door
Storage Overhead Cabinet with Three Doors 	16 3/16	47 3/4	42 1/2	154	23	VST1648SOR	\$1,390	\$2,070						
	16 3/16	47 3/4	42 1/2	154	23	VSV1648SOR			\$2,407	\$3,087	\$2,717	\$2,647	\$3,327	\$2,957
	16 3/16	47 3/4	42 1/2	154	23	VST1648SOL	\$1,390	\$2,070						
	16 3/16	47 3/4	42 1/2	154	23	VSV1648SOL			\$2,407	\$3,087	\$2,717	\$2,647	\$3,327	\$2,957
	16 3/16	41 3/4	42 1/2	135	21	VST1642SOR	\$1,320	\$1,961						
	16 3/16	41 3/4	42 1/2	135	21	VSV1642SOR			\$2,330	\$2,972	\$2,640	\$2,563	\$3,205	\$2,873
	16 3/16	41 3/4	42 1/2	135	21	VST1642SOL	\$1,320	\$1,961						
	16 3/16	41 3/4	42 1/2	135	21	VSV1642SOL			\$2,330	\$2,972	\$2,640	\$2,563	\$3,205	\$2,873

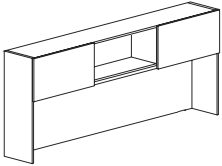
- select door style
- aluminum frame door offered in both frosted or white back painted glass, specify when ordering
- white markerboard doors available, specify and add \$392 list to laminate or veneer door price
- locking available on laminate or wood doors, specify and add \$74 list; glass doors are non-locking
- small grommet in top of back to fit LED lights
- tackboards available, see pages [VS172-VS175](#) or [VS176-VS179](#)
- tasklights available, see pages [VS318](#)
- 25" vertical clearance from desk top to bottom of valance rail
- right door configuration - 1 door hinges left and 2 doors hinge right
- left door configuration - 1 door hinges right and 2 doors hinge left
- pulls not available

Description	D	W	H	CTN WT	CU FT	① Model	Laminate		Flat Cut Veneer			Double Cut Veneer		
							Laminate Door	Alum. Frm Glass Door	Veneer Door	Alum. Frm Glass Door	Wood Frm Glass Door	Veneer Door	Alum. Frm Glass Door	Wood Frm Glass Door
Storage Overhead Cabinet with Two Doors 	16 3/16	35 3/4	42 1/2	115	18	VST1636SO	\$1,248	\$1,727						
	16 3/16	35 3/4	42 1/2	115	18	VSV1636SO			\$2,259	\$2,737	\$2,443	\$2,486	\$2,965	\$2,671
	16 3/16	29 3/4	42 1/2	101	15	VST1630SO	\$1,184	\$1,626						
	16 3/16	29 3/4	42 1/2	101	15	VSV1630SO			\$2,200	\$2,642	\$2,385	\$2,419	\$2,861	\$2,604

- select door style
- aluminum frame door offered in both frosted or white back painted glass, specify when ordering
- white markerboard doors available, specify and add \$233 list to laminate or veneer door price
- locking available on laminate or wood doors, specify and add \$47 list; glass doors are non-locking
- small grommet in top of back to fit LED lights
- tackboards available, see pages [VS172-VS175](#) or [VS176-VS179](#)
- tasklights available, see pages [VS318](#)
- 25" vertical clearance from desk top to bottom of valance rail
- pulls not available

To Order, Specify:

- | | | | |
|--|-----------------------|-------------------|--|
| ① Model Number | Laminate - VST | Veneer - VSV | |
| ② Worksurface Material (see page VI3) | a.) TFL | b.) HPL | ② Wood Species - Cherry (CH1), Maple (MA1)
Walnut (WA1), Black Oak (BO1) or
Double Cut (DC1) (see page VI1) |
| ③ Laminate Color (see page VI3) | a.) Worksurface Color | b.) Chassis Color | c.) Drawer Color |
| | | | ④ Edge Profile (see page VI4) |
| | | | ⑤ Pull Style and Color (see page VI5) |
| | | | ⑥ Optional Grommet Location & Color -
Matte Black (MBK) or Arctic Silver (ASL)
(see page VI6) |
| | | | ⑦ Other Product Options (see page VI10) |
| | | | ⑧ Accessories (see page VS314) |
| | | | ⑨ Power and Data Options (see page VS324) |

Description	D	W	H	CTN WT	CU FT	① Model	Laminate	Flat Cut Veneer	Double Cut Veneer
Storage Overhead Cabinet with Two Sliding Doors 	16 3/16	107 3/4	42 1/2	309	51	VST16108SD	\$2,851		
	16 3/16	107 3/4	42 1/2	327	51	VSV16108SD		\$4,870	\$5,357
	16 3/16	101 3/4	42 1/2	309	48	VST16102SD	\$2,699		
	16 3/16	101 3/4	42 1/2	309	48	VSV16102SD		\$4,543	\$4,999
	16 3/16	95 3/4	42 1/2	291	45	VST1696SD	\$2,557		
	16 3/16	95 3/4	42 1/2	291	45	VSV1696SD		\$4,235	\$4,655
	16 3/16	89 3/4	42 1/2	273	43	VST1690SD	\$2,421		
	16 3/16	89 3/4	42 1/2	273	43	VSV1690SD		\$3,928	\$4,323

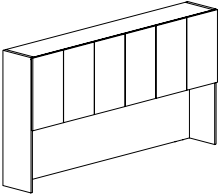
- white markerboard doors available, specify and add \$428 list to laminate or veneer door price
- locking not available
- small grommet in top of back to fit LED lights
- tackboards available, see pages [VS172-VS175](#) or [VS176-VS179](#)
- tasklights available, see pages [VS318](#)
- 25" vertical clearance from desk top to bottom of valance rail
- pulls not available

Description	D	W	H	CTN WT	CU FT	① Model	Laminate	Flat Cut Veneer	Double Cut Veneer
Storage Overhead Cabinet with Sliding Door 	16 3/16	83 3/4	42 1/2	244	40	VST1684SD	\$2,292		
	16 3/16	83 3/4	42 1/2	244	40	VSV1684SD		\$3,653	\$4,018
	16 3/16	77 3/4	42 1/2	231	37	VST1678SD	\$2,175		
	16 3/16	77 3/4	42 1/2	231	37	VSV1678SD		\$3,433	\$3,777
	16 3/16	71 3/4	42 1/2	218	34	VST1672SD	\$2,058		
	16 3/16	71 3/4	42 1/2	218	34	VSV1672SD		\$3,186	\$3,504
	16 3/16	65 3/4	42 1/2	206	32	VST1666SD	\$1,957		
	16 3/16	65 3/4	42 1/2	206	32	VSV1666SD		\$3,058	\$3,362
	16 3/16	59 3/4	42 1/2	193	29	VST1660SD	\$1,862		
	16 3/16	59 3/4	42 1/2	193	29	VSV1660SD		\$2,939	\$3,233
	16 3/16	53 3/4	42 1/2	175	26	VST1654SD	\$1,773		
	16 3/16	53 3/4	42 1/2	175	26	VSV1654SD		\$2,841	\$3,125
	16 3/16	47 3/4	42 1/2	154	23	VST1648SD	\$1,688		
	16 3/16	47 3/4	42 1/2	154	23	VSV1648SD		\$2,755	\$3,029
	16 3/16	41 3/4	42 1/2	135	21	VST1642SD	\$1,608		
	16 3/16	41 3/4	42 1/2	135	21	VSV1642SD		\$2,678	\$2,946
	16 3/16	41 3/4	42 1/2	115	18	VST1636SD	\$1,538		
	16 3/16	35 3/4	42 1/2	115	18	VSV1636SD		\$2,606	\$2,866
16 3/16	29 3/4	42 1/2	101	15	VST1630SD	\$1,513			
16 3/16	29 3/4	42 1/2	101	15	VSV1630SD		\$2,549	\$2,803	

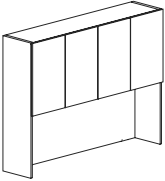
- white markerboard door available, specify and add \$215 list to laminate or veneer door price
- locking not available
- small grommet in top of back to fit LED lights
- tackboards available, see pages [VS172-VS175](#) or [VS176-VS179](#)
- tasklights available, see pages [VS318](#)
- 25" vertical clearance from desk top to bottom of valance rail
- pulls not available

To Order, Specify:

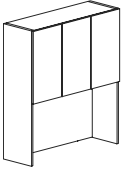
① Model Number	Laminate - VST	Veneer - VSV	
	② Worksurface Material (see page VI3) a.) TFL b.) HPL ③ Laminate Color (see page VI3) a.) Worksurface Color b.) Chassis Color c.) Drawer Color	② Wood Species - Cherry (CH1), Maple (MA1) Walnut (WA1), Black Oak (BO1) or Double Cut (DC1) (see page VI1) ③ Finish Color (see page VI1)	④ Edge Profile (see page VI4) ⑤ Pull Style and Color (see page VI5) ⑥ Optional Grommet Location & Color - Matte Black (MBK) or Arctic Silver (ASL) (see page VI6) ⑦ Other Product Options (see page VI10) ⑧ Accessories (see page VS314) ⑨ Power and Data Options (see page VS324)

Description	D	W	H	CTN WT	CU FT	① Model	Laminate		Flat Cut Veneer			Double Cut Veneer		
							Laminate Door	Alum. Frm Glass Door	Veneer Door	Alum. Frm Glass Door	Wood Frm Glass Door	Veneer Door	Alum. Frm Glass Door	Wood Frm Glass Door
Double Height Storage Overhead Cabinet with Six Doors 	16 ³ / ₁₆	107 ³ / ₄	54 ¹ / ₂	421	65	VST16108DSO	\$3,029	\$4,918						
	16 ³ / ₁₆	107 ³ / ₄	54 ¹ / ₂	421	65	VSV16108DSO			\$5,421	\$7,310	\$6,243	\$5,964	\$7,853	\$6,786
	16 ³ / ₁₆	101 ³ / ₄	54 ¹ / ₂	398	61	VST16102DSO	\$2,877	\$4,713						
	16 ³ / ₁₆	101 ³ / ₄	54 ¹ / ₂	398	61	VSV16102DSO			\$5,110	\$6,947	\$5,932	\$5,622	\$7,458	\$6,444
	16 ³ / ₁₆	95 ³ / ₄	54 ¹ / ₂	375	58	VST1696DSO	\$2,718	\$4,501						
	16 ³ / ₁₆	95 ³ / ₄	54 ¹ / ₂	375	58	VSV1696DSO			\$4,803	\$6,586	\$5,625	\$5,283	\$7,067	\$6,105
	16 ³ / ₁₆	89 ³ / ₄	54 ¹ / ₂	351	54	VST1690DSO	\$2,575	\$4,308						
	16 ³ / ₁₆	89 ³ / ₄	54 ¹ / ₂	351	54	VSV1690DSO			\$4,601	\$6,333	\$5,423	\$5,061	\$6,793	\$5,883

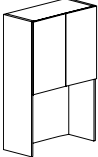
- select door style
- aluminum frame door offered in both frosted or white back painted glass, specify when ordering
- white markerboard doors available, specify and add \$1,040 list to laminate or veneer door price
- locking available on laminate or wood doors, specify and add \$115 list; glass doors are non-locking
- small grommet in top of back to fit LED lights
- tackboards available, see pages [VS172-VS175](#) or [VS176-VS179](#)
- tasklights available, see pages [VS318](#)
- 25" vertical clearance from desk top to bottom of valance rail
- pulls not available
- backside of unit intended to go against a wall, cabinet should be secured to a wall as a safety precaution

Description	D	W	H	CTN WT	CU FT	① Model	Laminate		Flat Cut Veneer			Double Cut Veneer		
							Laminate Door	Alum. Frm Glass Door	Veneer Door	Alum. Frm Glass Door	Wood Frm Glass Door	Veneer Door	Alum. Frm Glass Door	Wood Frm Glass Door
Double Height Storage Overhead Cabinet with Four Doors 	16 ³ / ₁₆	83 ³ / ₄	54 ¹ / ₂	314	47	VST1684DSO	\$2,438	\$3,801						
	16 ³ / ₁₆	83 ³ / ₄	54 ¹ / ₂	314	51	VSV1684DSO			\$4,241	\$5,604	\$4,882	\$4,665	\$6,029	\$5,306
	16 ³ / ₁₆	77 ³ / ₄	54 ¹ / ₂	297	47	VST1678DSO	\$2,308	\$3,621						
	16 ³ / ₁₆	77 ³ / ₄	54 ¹ / ₂	297	47	VSV1678DSO			\$3,956	\$5,269	\$4,597	\$4,353	\$5,666	\$4,993
	16 ³ / ₁₆	71 ³ / ₄	54 ¹ / ₂	281	44	VST1672DSO	\$2,183	\$3,441						
	16 ³ / ₁₆	71 ³ / ₄	54 ¹ / ₂	281	44	VSV1672DSO			\$3,690	\$4,949	\$4,331	\$4,059	\$5,318	\$4,700
	16 ³ / ₁₆	65 ³ / ₄	54 ¹ / ₂	265	40	VST1666DSO	\$2,067	\$3,276						
	16 ³ / ₁₆	65 ³ / ₄	54 ¹ / ₂	265	40	VSV1666DSO			\$3,524	\$4,734	\$4,165	\$3,876	\$5,086	\$4,517
	16 ³ / ₁₆	59 ³ / ₄	54 ¹ / ₂	249	37	VST1660DSO	\$1,971	\$3,127						
	16 ³ / ₁₆	59 ³ / ₄	54 ¹ / ₂	249	37	VSV1660DSO			\$3,365	\$4,521	\$4,005	\$3,704	\$4,860	\$4,344
	16 ³ / ₁₆	53 ³ / ₄	54 ¹ / ₂	225	33	VST1654DSO	\$1,872	\$2,976						
	16 ³ / ₁₆	53 ³ / ₄	54 ¹ / ₂	225	33	VSV1654DSO			\$3,238	\$4,342	\$3,879	\$3,564	\$4,668	\$4,205

- select door style
- aluminum frame door offered in both frosted or white back painted glass, specify when ordering
- white markerboard doors available, specify and add \$811 list to laminate or veneer door price
- locking available on laminate or wood doors, specify and add \$79 list; glass doors are non-locking
- small grommet in top of back to fit LED lights
- tackboards available, see pages [VS172-VS175](#) or [VS176-VS179](#)
- tasklights available, see pages [VS318](#)
- 25" vertical clearance from desk top to bottom of valance rail
- pulls not available
- backside of unit intended to go against a wall, cabinet should be secured to a wall as a safety precaution

Description	D	W	H	CTN WT	CU FT	① Model	Laminate		Flat Cut Veneer			Double Cut Veneer		
							Laminate Door	Alum. Frm Glass Door	Veneer Door	Alum. Frm Glass Door	Wood Frm Glass Door	Veneer Door	Alum. Frm Glass Door	Wood Frm Glass Door
 Double Height Storage Overhead Cabinet with Three Doors	16 3/16	47 3/4	54 1/2	198	30	VST1648DSOR	\$1,780	\$2,672						
	16 3/16	47 3/4	54 1/2	198	30	VSV1648DSOR			\$3,128	\$4,020	\$3,552	\$3,440	\$4,332	\$3,865
	16 3/16	47 3/4	54 1/2	198	30	VST1648DSOL	\$1,780	\$2,672						
	16 3/16	47 3/4	54 1/2	198	30	VSV1648DSOL			\$3,128	\$4,020	\$3,552	\$3,440	\$4,332	\$3,865
	16 3/16	41 3/4	54 1/2	174	26	VST1642DSOR	\$1,694	\$2,535						
	16 3/16	41 3/4	54 1/2	174	26	VSV1642DSOR			\$3,027	\$3,869	\$3,452	\$3,332	\$4,173	\$3,756
	16 3/16	41 3/4	54 1/2	174	26	VST1642DSOL	\$1,694	\$2,535						
	16 3/16	41 3/4	54 1/2	174	26	VSV1642DSOL			\$3,027	\$3,869	\$3,452	\$3,332	\$4,173	\$3,756

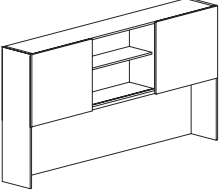
- select door style
- aluminum frame door offered in both frosted or white back painted glass, specify when ordering
- white markerboard doors available, specify and add \$537 list to laminate or veneer door price
- locking available on laminate or wood doors, specify and add \$74 list; glass doors are non-locking
- small grommet in top of back to fit LED lights
- tackboards available, see pages [VS172-VS175](#) or [VS176-VS179](#)
- tasklights available, see pages [VS318](#)
- 25" vertical clearance from desk top to bottom of valance rail
- right door configuration - 1 door hinges left and 2 doors hinge right
- left door configuration - 1 door hinges right and 2 doors hinge left
- pulls not available
- backside of unit intended to go against a wall, cabinet should be secured to a wall as a safety precaution

Description	D	W	H	CTN WT	CU FT	① Model	Laminate		Flat Cut Veneer			Double Cut Veneer		
							Laminate Door	Alum. Frm Glass Door	Veneer Door	Alum. Frm Glass Door	Wood Frm Glass Door	Veneer Door	Alum. Frm Glass Door	Wood Frm Glass Door
 Double Height Storage Overhead Cabinet with Two Doors	16 3/16	35 3/4	54 1/2	130	23	VST1636DSO	\$1,608	\$2,238						
	16 3/16	35 3/4	54 1/2	148	23	VSV1636DSO			\$2,935	\$3,565	\$3,226	\$3,230	\$3,861	\$3,521
	16 3/16	29 3/4	54 1/2	130	19	VST1630DSO	\$1,531	\$2,109						
	16 3/16	29 3/4	54 1/2	130	19	VSV1630DSO			\$2,754	\$3,332	\$3,045	\$3,028	\$3,606	\$3,319

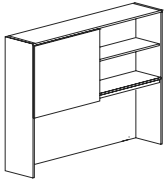
- select door style
- aluminum frame door offered in both frosted or white back painted glass, specify when ordering
- white markerboard doors available, specify and add \$368 list to laminate or veneer door price
- locking available on laminate or wood doors, specify and add \$47 list; glass doors are non-locking
- small grommet in top of back to fit LED lights
- tackboards available, see pages [VS172-VS175](#) or [VS176-VS179](#)
- tasklights available, see pages [VS318](#)
- 25" vertical clearance from desk top to bottom of valance rail
- pulls not available
- backside of unit intended to go against a wall, cabinet should be secured to a wall as a safety precaution

To Order, Specify:

① Model Number	Laminate - VST	Veneer - VSV
	<ul style="list-style-type: none"> ② Worksurface Material (see page V13) <ul style="list-style-type: none"> a.) TFL b.) HPL ③ Laminate Color (see page V13) <ul style="list-style-type: none"> a.) Worksurface Color b.) Chassis Color c.) Drawer Color 	<ul style="list-style-type: none"> ② Wood Species - Cherry (CH1), Maple (MA1) Walnut (WA1), Black Oak (BO1) or Double Cut (DC1) (see page V11) ③ Finish Color (see page V11)
		<ul style="list-style-type: none"> ④ Edge Profile (see page V14) ⑤ Pull Style and Color (see page V15) ⑥ Optional Grommet Location & Color - Matte Black (MBK) or Arctic Silver (ASL) (see page V16) ⑦ Other Product Options (see page V10) ⑧ Accessories (see page VS314) ⑨ Power and Data Options (see page VS324)

Description	D	W	H	CTN WT	CU FT	① Model	Laminate	Flat Cut Veneer	Double Cut Veneer
Double Height Storage Overhead Cabinet with Two Sliding Doors 	16 3/16	107 3/4	54 1/2	421	65	VST16108DSD	\$3,422		
	16 3/16	107 3/4	54 1/2	421	65	VSV16108DSD		\$5,891	\$6,481
	16 3/16	101 3/4	54 1/2	398	61	VST16102DSD	\$3,252		
	16 3/16	101 3/4	54 1/2	398	61	VSV16102DSD		\$5,589	\$6,147
	16 3/16	95 3/4	54 1/2	375	58	VST1696DSD	\$3,094		
	16 3/16	95 3/4	54 1/2	375	58	VSV1696DSD		\$5,288	\$5,819
	16 3/16	89 3/4	54 1/2	351	54	VST1690DSD	\$2,944		
	16 3/16	89 3/4	54 1/2	351	54	VSV1690DSD		\$5,107	\$5,617

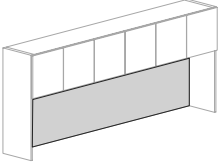
- white markerboard doors available, specify and add \$565 list to laminate or veneer door price
- locking not available
- small grommet in top of back to fit LED lights
- tackboards available, see pages [VS172-VS175](#) or [VS176-VS179](#)
- tasklights available, see pages [VS318](#)
- 25" vertical clearance from desk top to bottom of valance rail
- pulls not available
- backside of unit intended to go against a wall, cabinet should be secured to a wall as a safety precaution

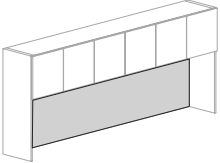
Description	D	W	H	CTN WT	CU FT	① Model	Laminate	Flat Cut Veneer	Double Cut Veneer
Double Height Storage Overhead Cabinet with Sliding Door 	16 3/16	83 3/4	54 1/2	297	51	VST1684DSD	\$2,798		
	16 3/16	83 3/4	54 1/2	314	51	VSV1684DSD		\$4,747	\$5,223
	16 3/16	77 3/4	54 1/2	297	47	VST1678DSD	\$2,662		
	16 3/16	77 3/4	54 1/2	297	47	VSV1678DSD		\$4,463	\$4,908
	16 3/16	71 3/4	54 1/2	281	44	VST1672DSD	\$2,534		
	16 3/16	71 3/4	54 1/2	281	44	VSV1672DSD		\$4,143	\$4,558
	16 3/16	65 3/4	54 1/2	265	40	VST1666DSD	\$2,408		
	16 3/16	65 3/4	54 1/2	265	40	VSV1666DSD		\$3,976	\$4,373
	16 3/16	59 3/4	54 1/2	249	37	VST1660DSD	\$2,311		
	16 3/16	59 3/4	54 1/2	249	37	VSV1660DSD		\$3,820	\$4,203
	16 3/16	53 3/4	54 1/2	225	33	VST1654DSD	\$2,206		
	16 3/16	53 3/4	54 1/2	225	33	VSV1654DSD		\$3,692	\$4,062
	16 3/16	47 3/4	54 1/2	198	30	VST1648DSD	\$2,109		
	16 3/16	47 3/4	54 1/2	198	30	VSV1648DSD		\$3,580	\$3,938
	16 3/16	41 3/4	54 1/2	174	26	VST1642DSD	\$2,020		
	16 3/16	41 3/4	54 1/2	174	26	VSV1642DSD		\$3,481	\$3,830
16 3/16	35 3/4	54 1/2	148	23	VST1636DSD	\$1,937			
16 3/16	35 3/4	54 1/2	148	23	VSV1636DSD		\$3,389	\$3,727	
16 3/16	29 3/4	54 1/2	130	19	VST1630DSD	\$1,915			
16 3/16	29 3/4	54 1/2	130	19	VSV1630DSD		\$3,312	\$3,642	

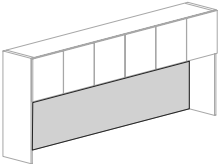
- white markerboard door available, specify and add \$284 list to laminate or veneer door price
- locking not available
- small grommet in top of back to fit LED lights
- tackboards available, see pages [VS172-VS175](#) or [VS176-VS179](#)
- tasklights available, see pages [VS318](#)
- 25" vertical clearance from desk top to bottom of valance rail
- pulls not available
- backside of unit intended to go against a wall, cabinet should be secured to a wall as a safety precaution

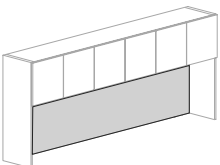
To Order, Specify:

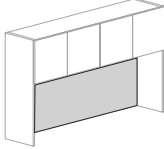
① Model Number	Laminate - VST	Veneer - VSV	
	② Worksurface Material (see page VI3) a.) TFL b.) HPL ③ Laminate Color (see page VI3) a.) Worksurface Color b.) Chassis Color c.) Drawer Color	② Wood Species - Cherry (CH1), Maple (MA1) Walnut (WA1), Black Oak (BO1) or Double Cut (DC1) (see page VI1) ③ Finish Color (see page VI1)	④ Edge Profile (see page VI4) ⑤ Pull Style and Color (see page VI5) ⑥ Optional Grommet Location & Color - Matte Black (MBK) or Arctic Silver (ASL) (see page VI6) ⑦ Other Product Options (see page VI10) ⑧ Accessories (see page VS314) ⑨ Power and Data Options (see page VS324)

Description	D	W	H	CTN WT	CU FT	① Model	List Price Per Grade
Tackboard for Front of 108" w Storage Overhead Cabinet  <ul style="list-style-type: none"> · for use with 108" w overhead · com ydg: 3 	½	106⅞	23	22	7	VSB10823TK	COM \$540 A \$571 B \$639 C \$757 D \$909 E \$1,060 F \$1,295 G \$1,547 H \$1,816 I \$2,237 J \$2,739

Tackboard for Front of 102" w Storage Overhead Cabinet  <ul style="list-style-type: none"> · for use with 102" w overhead · com ydg: 3 	½	100⅞	23	21	6	VSB10223TK	COM \$524 A \$557 B \$626 C \$742 D \$893 E \$1,045 F \$1,281 G \$1,532 H \$1,800 I \$2,221 J \$2,726
--	---	------	----	----	---	-------------------	--

Tackboard for Front of 96" w Storage Overhead Cabinet  <ul style="list-style-type: none"> · for use with 96" w overhead · com ydg: 3 	½	94⅞	23	20	6	VSB9623TK	COM \$462 A \$491 B \$554 C \$663 D \$802 E \$941 F \$1,160 G \$1,390 H \$1,640 I \$2,028 J \$2,493
--	---	-----	----	----	---	------------------	--

Tackboard for Front of 90" w Storage Overhead Cabinet  <ul style="list-style-type: none"> · for use with 90" w overhead · com ydg: 3 	½	88⅞	23	18	6	VSB9023TK	COM \$456 A \$487 B \$549 C \$656 D \$798 E \$936 F \$1,153 G \$1,386 H \$1,634 I \$2,022 J \$2,487
--	---	-----	----	----	---	------------------	--

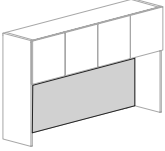
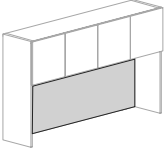
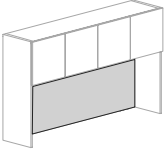
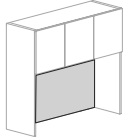
Description	D	W	H	CTN WT	CU FT	① Model	List Price Per Grade
Tackboard for Front of 84" w Storage Overhead Cabinet · for use with 84" w overhead · com ydg: 3 	1/2	82 1/8	23	17	5	VSB8423TK	COM \$421
							A \$449
							B \$506
							C \$606
							D \$734
							E \$863
							F \$1,061
							G \$1,275
							H \$1,502
							I \$1,857
							J \$2,283

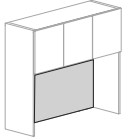
Tackboard for Front of 78" w Storage Overhead Cabinet · for use with 78" w overhead · com ydg: 3 	1/2	76 1/8	23	16	5	VSB7823TK	COM \$406
							A \$433
							B \$484
							C \$576
							D \$691
							E \$807
							F \$990
							G \$1,183
							H \$1,389
							I \$1,712
							J \$2,101

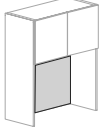
Tackboard for Front of 72" w Storage Overhead Cabinet · for use with 72" w overhead · com ydg: 2 	1/2	70 1/8	23	15	5	VSB7223TK	COM \$382
							A \$405
							B \$453
							C \$532
							D \$638
							E \$743
							F \$906
							G \$1,080
							H \$1,266
							I \$1,557
							J \$1,906

To Order, Specify:

- ① Model Number
- ② Fabric Selection: vendor, pattern, color
 Visit www.jsifurniture.com/finishes-and-materials/textiles
 for our textiles program. See selection of standard and
 graded in manufacturers and patterns.

Description	D	W	H	CTN WT	CU FT	① Model	List Price Per Grade
Tackboard for Front of 66" w Storage Overhead Cabinet  <ul style="list-style-type: none"> · for use with 66" w overhead · com ydg: 2 	1/2	64 1/8	23	14	4	VSB6623TK	COM \$356 A \$378 B \$419 C \$490 D \$584 E \$677 F \$823 G \$977 H \$1,142 I \$1,402 J \$1,711
Tackboard for Front of 60" w Storage Overhead Cabinet  <ul style="list-style-type: none"> · for use with 60" w overhead · com ydg: 2 	1/2	58 1/8	23	11	4	VSB6023TK	COM \$343 A \$363 B \$404 C \$478 D \$570 E \$664 F \$807 G \$963 H \$1,128 I \$1,387 J \$1,698
Tackboard for Front of 54" w Storage Overhead Cabinet  <ul style="list-style-type: none"> · for use with 54" w overhead · com ydg: 2 	1/2	52 1/8	23	11	4	VSB5423TK	COM \$317 A \$336 B \$372 C \$436 D \$517 E \$598 F \$725 G \$861 H \$1,005 I \$1,232 J \$1,504
Tackboard for Front of 48" w Storage Overhead Cabinet  <ul style="list-style-type: none"> · for use with 48" w overhead · com ydg: 2 	1/2	46 1/8	23	10	3	VSB4823TK	COM \$289 A \$306 B \$342 C \$405 D \$487 E \$568 F \$694 G \$830 H \$975 I \$1,201 J \$1,472

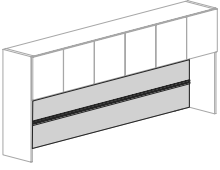
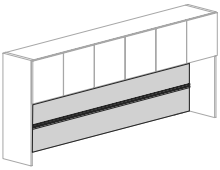
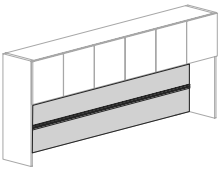
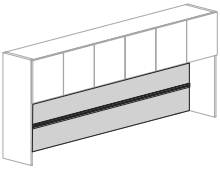
Description	D	W	H	CTN WT	CU FT	① Model	List Price Per Grade
Tackboard for Front of 42" w Storage Overhead Cabinet  <ul style="list-style-type: none"> · for use with 42" w overhead · com ydg: 2 	1/2	40 1/8	23	9	3	VSB4223TK	COM \$261 A \$276 B \$308 C \$362 D \$432 E \$502 F \$610 G \$726 H \$850 I \$1,045 J \$1,277

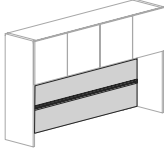
Tackboard for Front of 36" w Storage Overhead Cabinet  <ul style="list-style-type: none"> · for use with 36" w overhead · com ydg: 1 	1/2	34 1/8	23	8	3	VSB3623TK	COM \$234 A \$248 B \$273 C \$319 D \$378 E \$436 F \$526 G \$625 H \$726 I \$888 J \$1,083
---	-----	--------	----	---	---	------------------	--

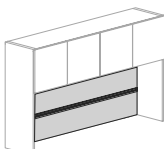
Tackboard for Front of 30" w Storage Overhead Cabinet  <ul style="list-style-type: none"> · for use with 30" w overhead · com ydg: 1 	1/2	28 1/8	23	7	2	VSB3023TK	COM \$223 A \$235 B \$263 C \$307 D \$365 E \$424 F \$514 G \$611 H \$715 I \$876 J \$1,070
---	-----	--------	----	---	---	------------------	--

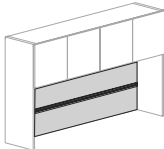
To Order, Specify:

- ① Model Number
- ② Fabric Selection: vendor, pattern, color
 Visit www.jsifurniture.com/finishes-and-materials/textiles
 for our textiles program. See selection of standard and
 graded in manufacturers and patterns.

Description	D	W	H	CTN WT	CU FT	① Model	List Price Per Grade
Tackboard for Accessory Rail of 108" w Storage Overhead Cabinet 	1/2	106 1/8	0	19	4	VSB10823TKA	COM \$605
							A \$638
<ul style="list-style-type: none"> · tackboard panels for above and below accessory rail · not required; add-on for convenience application · com ydg: 3 · upper tackboard height: 8 1/4" · lower tackboard height: 11 1/2" · coordinates with VS_16108DSO, VS_16108SO, VS_16108DSD and VS_16108SD · accessory rail sold separately, see page VS180 							B \$705
							C \$824
						D \$974	
						E \$1,126	
						F \$1,361	
						G \$1,613	
						H \$1,881	
						I \$2,303	
						J \$2,805	
Tackboard for Accessory Rail of 102" w Storage Overhead Cabinet 	1/2	100 1/8	0	18	4	VSB10223TKA	COM \$590
							A \$625
<ul style="list-style-type: none"> · tackboard panels for above and below accessory rail · not required; add-on for convenience application · com ydg: 3 · upper tackboard height: 8 1/4" · lower tackboard height: 11 1/2" · coordinates with VS_16102DSO, VS_16102SO, VS_16102DSD and VS_16102SD · accessory rail sold separately, see page VS180 							B \$691
							C \$807
						D \$960	
						E \$1,111	
						F \$1,346	
						G \$1,597	
						H \$1,868	
						I \$2,287	
						J \$2,792	
Tackboard for Accessory Rail of 96" w Storage Overhead Cabinet 	1/2	94 1/8	0	17	4	VSB9623TKA	COM \$527
							A \$557
<ul style="list-style-type: none"> · tackboard panels for above and below accessory rail · not required; add-on for convenience application · com ydg: 3 · upper tackboard height: 8 1/4" · lower tackboard height: 11 1/2" · coordinates with VS_1696DSO, VS_1696SO, VS_1696DSD and VS_1696SD · accessory rail sold separately, see page VS180 							B \$620
							C \$728
						D \$868	
						E \$1,008	
						F \$1,225	
						G \$1,457	
						H \$1,706	
						I \$2,094	
						J \$2,560	
Tackboard for Accessory Rail of 90" w Storage Overhead Cabinet 	1/2	88 1/8	0	16	3	VSB9023TKA	COM \$521
							A \$553
<ul style="list-style-type: none"> · tackboard panels for above and below accessory rail · not required; add-on for convenience application · com ydg: 3 · upper tackboard height: 8 1/4" · lower tackboard height: 11 1/2" · coordinates with VS_1690DSO, VS_1690SO, VS_1690DSD and VS_1690SD · accessory rail sold separately, see page VS180 							B \$614
							C \$723
						D \$864	
						E \$1,002	
						F \$1,219	
						G \$1,452	
						H \$1,700	
						I \$2,088	
						J \$2,554	

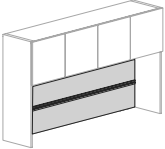
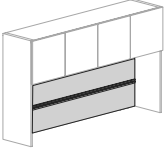
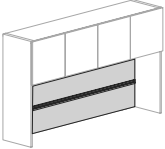
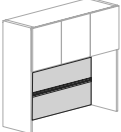
Description	D	W	H	CTN WT	CU FT	① Model	List Price Per Grade	
Tackboard for Accessory Rail of 84" w Storage Overhead Cabinet 	1/2	82 1/8	0	15	3	VSB8423TKA	COM \$482	
	<ul style="list-style-type: none"> tackboard panels for above and below accessory rail not required; add-on for convenience application com ydg: 3 upper tackboard height: 8 1/4" lower tackboard height: 11 1/2" coordinates with VS_1684DSO, VS_1684SO, VS_1684DSD and VS_1684SD accessory rail sold separately, see page VS180 							A \$511
								B \$567
								C \$668
								D \$795
								E \$924
								F \$1,123
								G \$1,336
								H \$1,563
								I \$1,918
								J \$2,345

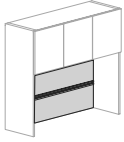
Tackboard for Accessory Rail of 78" w Storage Overhead Cabinet 	1/2	76 1/8	0	14	3	VSB7823TKA	COM \$468	
	<ul style="list-style-type: none"> tackboard panels for above and below accessory rail not required; add-on for convenience application com ydg: 3 upper tackboard height: 8 1/4" lower tackboard height: 11 1/2" coordinates with VS_1678DSO, VS_1678SO, VS_1678DSD and VS_1678SD accessory rail sold separately, see page VS180 							A \$494
								B \$546
								C \$637
								D \$753
								E \$869
								F \$1,050
								G \$1,244
								H \$1,451
								I \$1,774
								J \$2,162

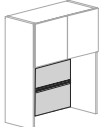
Tackboard for Accessory Rail of 72" w Storage Overhead Cabinet 	1/2	70 1/8	0	13	3	VSB7223TKA	COM \$440	
	<ul style="list-style-type: none"> tackboard panels for above and below accessory rail not required; add-on for convenience application com ydg: 2 upper tackboard height: 8 1/4" lower tackboard height: 11 1/2" coordinates with VS_1672DSO, VS_1672SO, VS_1672DSD and VS_1672SD accessory rail sold separately, see page VS180 							A \$464
								B \$509
								C \$591
								D \$695
								E \$801
								F \$963
								G \$1,138
								H \$1,324
								I \$1,616
								J \$1,964


To Order, Specify:

- ① Model Number
- ② Fabric Selection: vendor, pattern, color
 Visit www.jsifurniture.com/finishes-and-materials/textiles for our textiles program. See selection of standard and graded in manufacturers and patterns.

Description	D	W	H	CTN WT	CU FT	① Model	List Price Per Grade
Tackboard for Accessory Rail of 66" w Storage Overhead Cabinet  <ul style="list-style-type: none"> tackboard panels for above and below accessory rail not required; add-on for convenience application com ydg: 2 upper tackboard height: 8 1/4" lower tackboard height: 11 1/2" coordinates with VS_1666DSO, VS_1666SO, VS_1666DSD and VS_1666SD accessory rail sold separately, see page VS180 	1/2	64 1/8	0	12	3	VSB6623TKA	COM \$415 A \$436 B \$477 C \$549 D \$641 E \$735 F \$879 G \$1,036 H \$1,200 I \$1,460 J \$1,770
Tackboard for Accessory Rail of 60" w Storage Overhead Cabinet  <ul style="list-style-type: none"> tackboard panels for above and below accessory rail not required; add-on for convenience application com ydg: 2 upper tackboard height: 8 1/4" lower tackboard height: 11 1/2" coordinates with VS_1660DSO, VS_1660SO, VS_1660DSD and VS_1660SD accessory rail sold separately, see page VS180 	1/2	58 1/8	0	11	2	VSB6023TKA	COM \$401 A \$421 B \$463 C \$536 D \$629 E \$722 F \$866 G \$1,021 H \$1,186 I \$1,446 J \$1,755
Tackboard for Accessory Rail of 54" w Storage Overhead Cabinet  <ul style="list-style-type: none"> tackboard panels for above and below accessory rail not required; add-on for convenience application com ydg: 2 upper tackboard height: 8 1/4" lower tackboard height: 11 1/2" coordinates with VS_1654DSO, VS_1654SO, VS_1654DSD and VS_1654SD accessory rail sold separately, see page VS180 	1/2	52 1/8	0	10	2	VSB5423TKA	COM \$376 A \$394 B \$429 C \$492 D \$574 E \$655 F \$783 G \$918 H \$1,063 I \$1,289 J \$1,561
Tackboard for Accessory Rail of 48" w Storage Overhead Cabinet  <ul style="list-style-type: none"> tackboard panels for above and below accessory rail not required; add-on for convenience application com ydg: 2 upper tackboard height: 8 1/4" lower tackboard height: 11 1/2" coordinates with VS_1648DSO, VS_1648SO, VS_1648DSD and VS_1648SD accessory rail sold separately, see page VS180 	1/2	46 1/8	0	9	2	VSB4823TKA	COM \$342 A \$359 B \$396 C \$460 D \$542 E \$623 F \$749 G \$885 H \$1,029 I \$1,256 J \$1,527


Description	D	W	H	CTN WT	CU FT	① Model	List Price Per Grade	
Tackboard for Accessory Rail of 42" w Storage Overhead Cabinet 	1/2	40 1/8	0	8	2	VSB4223TKA	COM \$315	
	<ul style="list-style-type: none"> tackboard panels for above and below accessory rail not required; add-on for convenience application com ydg: 2 upper tackboard height: 8 1/4" lower tackboard height: 11 1/2" coordinates with VS_1642DSO, VS_1642SO, VS_1642DSD and VS_1642SD accessory rail sold separately, see page VS180 							A \$331
								B \$362
								C \$417
								D \$486
								E \$555
								F \$664
								G \$781
								H \$905
								I \$1,099
							J \$1,332	

Tackboard for Accessory Rail of 36" w Storage Overhead Cabinet 	1/2	34 1/8	0	7	2	VSB3623TKA	COM \$290	
	<ul style="list-style-type: none"> tackboard panels for above and below accessory rail not required; add-on for convenience application com ydg: 1 upper tackboard height: 8 1/4" lower tackboard height: 11 1/2" coordinates with VS_1636DSO, VS_1636SO, VS_1636DSD and VS_1636SD accessory rail sold separately, see page VS180 							A \$303
								B \$328
								C \$375
								D \$432
								E \$489
								F \$581
								G \$678
								H \$781
								I \$941
							J \$1,136	

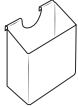


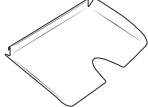
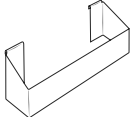
Tackboard for Accessory Rail of 30" w Storage Overhead Cabinet 	1/2	28 1/8	0	6	1	VSB3023TKA	COM \$277	
	<ul style="list-style-type: none"> tackboard panels for above and below accessory rail not required; add-on for convenience application com ydg: 1 upper tackboard height: 8 1/4" lower tackboard height: 11 1/2" coordinates with VS_1630DSO, VS_1630SO, VS_1630DSD and VS_1630SD accessory rail sold separately, see page VS180 							A \$291
								B \$316
								C \$360
								D \$420
								E \$478
								F \$568
								G \$665
								H \$768
								I \$930
							J \$1,124	

To Order, Specify:

- ① Model Number
- ② Fabric Selection: vendor, pattern, color
 Visit www.jsifurniture.com/finishes-and-materials/textiles for our textiles program. See selection of standard and graded in manufacturers and patterns.

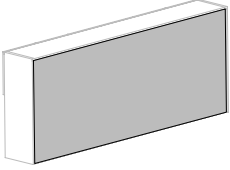
Description	D	W	H	CTN WT	CU FT	① Model	List Price
 <p>Accessory Rail</p>	¾	106 ⅞	3 ¼	9	3	VSB108AR	\$500
	¾	100 ⅞	3 ¼	8	3	VSB102AR	\$479
	¾	94 ⅞	3 ¼	7	3	VSB96AR	\$440
	¾	88 ⅞	3 ¼	7	3	VSB90AR	\$420
	¾	82 ⅞	3 ¼	6	2	VSB84AR	\$399
	¾	76 ⅞	3 ¼	6	2	VSB78AR	\$381
	¾	70 ⅞	3 ¼	5	2	VSB72AR	\$359
	¾	64 ⅞	3 ¼	4	2	VSB66AR	\$342
	¾	58 ⅞	3 ¼	4	2	VSB60AR	\$321
	¾	52 ⅞	3 ¼	4	2	VSB54AR	\$301
	¾	46 ⅞	3 ¼	3	2	VSB48AR	\$283
	¾	40 ⅞	3 ¼	3	1	VSB42AR	\$265
	¾	34 ⅞	3 ¼	3	1	VSB36AR	\$244
	¾	28 ⅞	3 ¼	2	1	VSB30AR	\$224

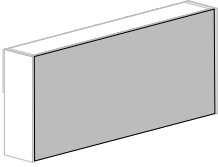
· used within overhead units for accessory tools

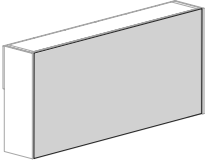
Description	D	W	H	CTN WT	CU FT	① Model	List Price
Upright Tray  <ul style="list-style-type: none"> pen and gadget cup Arctic Silver finish 	1 9/16	3 1/8	3 3/16	1	1	AC203CUP	\$108
Small Tray  <ul style="list-style-type: none"> tray for paper clips and other small items Arctic Silver finish 	3 5/16	2 1/4	7/8	1	1	AC403TRAY	\$82
Pencil Tray  <ul style="list-style-type: none"> tray for pencils and other small items Arctic Silver finish 	3 5/16	7 1/4	7/8	1	1	AC408TRAY	\$100
Paper Tray  <ul style="list-style-type: none"> tray for 8 1/2" x 11" letter paper size Arctic Silver finish 	9 7/16	13 3/16	7/8	1	1	AC912PAP	\$152
File Hanger  <ul style="list-style-type: none"> file hanger for 8 1/2" x 11" letter size hanging file folders Arctic Silver finish 	2 13/16	12 3/16	4	1	1	AC313FILE	\$144

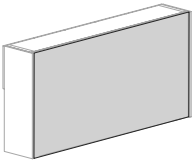
To Order, Specify:

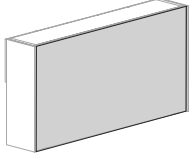
① Model Number	Laminate - VST	Veneer - VSV	
	② Worksurface Material (see page V13) a.) TFL b.) HPL ③ Laminate Color (see page V13) a.) Worksurface Color b.) Chassis Color c.) Drawer Color	② Wood Species - Cherry (CH1), Maple (MA1) Walnut (WA1), Black Oak (BO1) or Double Cut (DC1) (see page V11) ③ Finish Color (see page V11)	④ Edge Profile (see page V14) ⑤ Pull Style and Color (see page V15) ⑥ Optional Grommet Location & Color - Matte Black (MBK) or Arctic Silver (ASL) (see page V16) ⑦ Other Product Options (see page V110) ⑧ Accessories (see page VS314) ⑨ Power and Data Options (see page VS324)

Description	D	W	H	CTN WT	CU FT	① Model	List Price Per Grade
Tackboard for Back of 108" w Storage Overhead Cabinet  <ul style="list-style-type: none"> · for use with 108" w storage overhead cabinet · com ydg: 3 	1/2	106 1/8	41 5/8	38	11	VSB10842TKB	COM \$749
							A \$783 B \$850 C \$968 D \$1,120 E \$1,271 F \$1,506 G \$1,757 H \$2,027 I \$2,448 J \$2,950

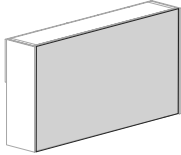
Tackboard for Back of 102" w Storage Overhead Cabinet  <ul style="list-style-type: none"> · for use with 102" w storage overhead cabinet · com ydg: 3 	1/2	100 1/8	41 5/8	36	11	VSB10242TKB	COM \$728
							A \$763 B \$830 C \$949 D \$1,099 E \$1,250 F \$1,486 G \$1,738 H \$2,006 I \$2,427 J \$2,930

Tackboard for Back of 96" w Storage Overhead Cabinet  <ul style="list-style-type: none"> · for use with 96" w storage overhead cabinet · com ydg: 3 	1/2	94 1/8	41 5/8	34	10	VSB9642TKB	COM \$661
							A \$691 B \$754 C \$863 D \$1,002 E \$1,141 F \$1,359 G \$1,592 H \$1,839 I \$2,227 J \$2,692

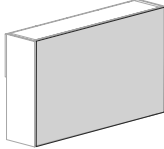
Tackboard for Back of 90" w Storage Overhead Cabinet  <ul style="list-style-type: none"> · for use with 90" w storage overhead cabinet · com ydg: 3 	1/2	88 1/8	41 5/8	32	9	VSB9042TKB	COM \$660
							A \$690 B \$753 C \$861 D \$1,000 E \$1,140 F \$1,358 G \$1,589 H \$1,837 I \$2,226 J \$2,691

Description	D	W	H	CTN WT	CU FT	① Model	List Price Per Grade
Tackboard for Back of 84" w Storage Overhead Cabinet 	1/2	82 1/8	41 5/8	30	9	VSB8442TKB	COM \$618
							A \$647
							B \$703
							C \$803
							D \$930
							E \$1,059
							F \$1,258
							G \$1,470
							H \$1,699
							I \$2,054
							J \$2,480

- for use with 84" w storage overhead cabinet
- com ydg: 3

Tackboard for Back of 78" w Storage Overhead Cabinet 	1/2	76 1/8	41 5/8	28	8	VSB7842TKB	COM \$574
							A \$600
							B \$652
							C \$743
							D \$858
							E \$975
							F \$1,155
							G \$1,349
							H \$1,556
							I \$1,880
							J \$2,268

- for use with 78" w storage overhead cabinet
- com ydg: 3

Tackboard for Back of 72" w Storage Overhead Cabinet 	1/2	70 1/8	41 5/8	26	8	VSB7242TKB	COM \$540
							A \$563
							B \$608
							C \$690
							D \$795
							E \$899
							F \$1,062
							G \$1,237
							H \$1,423
							I \$1,713
							J \$2,064

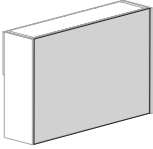
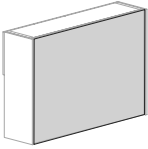
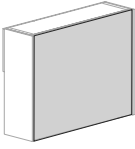
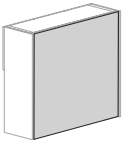
- for use with 72" w storage overhead cabinet
- com ydg: 2

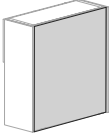
To Order, Specify:

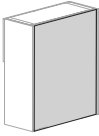
① Model Number

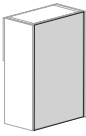
② Fabric Selection: vendor, pattern, color

Visit www.jsifurniture.com/finishes-and-materials/textiles for our textiles program. See selection of standard and graded in manufacturers and patterns.

Description	D	W	H	CTN WT	CU FT	① Model	List Price Per Grade
Tackboard for Back of 66" w Storage Overhead Cabinet 	1/2	64 1/8	41 5/8	23	7	VSB6642TKB	COM \$505
							A \$525
<ul style="list-style-type: none"> · for use with 66" w storage overhead cabinet · com ydg: 2 							B \$567
							C \$639
							D \$732
							E \$826
							F \$971
							G \$1,125
							H \$1,291
							I \$1,549
							J \$1,859
							Tackboard for Back of 60" w Storage Overhead Cabinet 
A \$504							
<ul style="list-style-type: none"> · for use with 60" w storage overhead cabinet · com ydg: 2 							B \$545
							C \$618
							D \$712
							E \$804
							F \$950
							G \$1,103
							H \$1,270
							I \$1,529
							J \$1,837
							Tackboard for Back of 54" w Storage Overhead Cabinet 
A \$466							
<ul style="list-style-type: none"> · for use with 54" w storage overhead cabinet · com ydg: 2 							B \$503
							C \$565
							D \$647
							E \$727
							F \$854
							G \$991
							H \$1,135
							I \$1,362
							J \$1,633
							Tackboard for Back of 48" w Storage Overhead Cabinet 
A \$417							
<ul style="list-style-type: none"> · for use with 48" w storage overhead cabinet · com ydg: 2 							B \$454
							C \$517
							D \$598
							E \$679
							F \$805
							G \$940
							H \$1,086
							I \$1,312
							J \$1,584

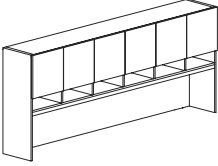
Description	D	W	H	CTN WT	CU FT	① Model	List Price Per Grade
Tackboard for Back of 42" w Storage Overhead Cabinet  <ul style="list-style-type: none"> · for use with 42" w storage overhead cabinet · com ydg: 2 	1/2	40 1/8	41 5/8	15	5	VSB4242TKB	COM \$364 A \$380 B \$412 C \$465 D \$536 E \$605 F \$714 G \$830 H \$954 I \$1,147 J \$1,381

Tackboard for Back of 36" w Storage Overhead Cabinet  <ul style="list-style-type: none"> · for use with 36" w storage overhead cabinet · com ydg: 1 	1/2	34 1/8	41 5/8	13	5	VSB3642TKB	COM \$327 A \$340 B \$365 C \$412 D \$469 E \$527 F \$618 G \$715 H \$818 I \$979 J \$1,173
--	-----	--------	--------	----	---	------------	--

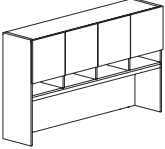
Tackboard for Back of 30" w Storage Overhead Cabinet  <ul style="list-style-type: none"> · for use with 30" w storage overhead cabinet · com ydg: 1 	1/2	28 1/8	41 5/8	11	4	VSB3042TKB	COM \$306 A \$318 B \$345 C \$390 D \$447 E \$506 F \$596 G \$693 H \$798 I \$959 J \$1,152
--	-----	--------	--------	----	---	------------	--

To Order, Specify:

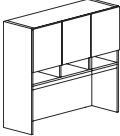
- ① Model Number
- ② Fabric Selection: vendor, pattern, color
 Visit www.jsifurniture.com/finishes-and-materials/textiles
 for our textiles program. See selection of standard and
 graded in manufacturers and patterns.

Description	D	W	H	CTN WT	CU FT	① Model	Laminate		Flat Cut Veneer			Double Cut Veneer			
							Laminate Door	Alum. Frm Glass Door	Veneer Door	Alum. Frm Glass Door	Wood Frm Glass Door	Veneer Door	Alum. Frm Glass Door	Wood Frm Glass Door	
Storage Overhead Cabinet with Six Doors and Cubbies 	16 3/16	107 3/4	42 1/2	48	51	VST16108SOC	\$2,933	\$4,365							
	16 3/16	107 3/4	42 1/2	372	51	VSV16108SOC			\$5,704	\$7,136	\$6,206	\$6,271	\$7,703	\$6,774	
	16 3/16	101 3/4	42 1/2	352	48	VST16102SOC	\$2,777	\$4,170							
	16 3/16	101 3/4	42 1/2	352	48	VSV16102SOC			\$5,375	\$6,768	\$5,877	\$5,914	\$7,307	\$6,416	
	16 3/16	95 3/4	42 1/2	331	45	VST1696SOC	\$2,631	\$3,989							
	16 3/16	95 3/4	42 1/2	331	45	VSV1696SOC			\$5,065	\$6,423	\$5,567	\$5,570	\$6,928	\$6,073	
	16 3/16	89 3/4	42 1/2	311	43	VST1690SOC	\$2,491	\$3,811							
	16 3/16	89 3/4	42 1/2	311	43	VSV1690SOC			\$4,608	\$5,928	\$5,110	\$5,069	\$6,389	\$5,571	

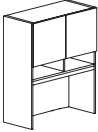
- select door style
- aluminum frame door offered in both frosted or white back painted glass, specify when ordering
- white markerboard doors available, specify and add \$635 list to laminate or veneer door price
- locking available on laminate or wood doors, specify and add \$115 list; glass doors are non-locking
- small grommet in top of back to fit LED lights
- tackboards available, see pages [VS196-VS199](#) or [VS200-VS203](#)
- tasklights available, see pages [VS318](#)
- 19" vertical clearance from desk top to bottom of valance rail
- pulls not available

Description	D	W	H	CTN WT	CU FT	① Model	Laminate		Flat Cut Veneer			Double Cut Veneer			
							Laminate Door	Alum. Frm Glass Door	Veneer Door	Alum. Frm Glass Door	Wood Frm Glass Door	Veneer Door	Alum. Frm Glass Door	Wood Frm Glass Door	
Storage Overhead Cabinet with Four Doors and Cubbies 	16 3/16	83 3/4	42 1/2	279	40	VST1684SOC	\$2,361	\$3,391							
	16 3/16	83 3/4	42 1/2	279	40	VSV1684SOC			\$4,194	\$5,224	\$4,635	\$4,613	\$5,643	\$5,054	
	16 3/16	77 3/4	42 1/2	264	37	VST1678SOC	\$2,234	\$3,228							
	16 3/16	77 3/4	42 1/2	264	37	VSV1678SOC			\$3,865	\$4,859	\$4,305	\$4,250	\$5,244	\$4,691	
	16 3/16	71 3/4	42 1/2	248	34	VST1672SOC	\$2,114	\$3,068							
	16 3/16	71 3/4	42 1/2	248	34	VSV1672SOC			\$3,558	\$4,513	\$3,999	\$3,913	\$4,867	\$4,354	
	16 3/16	65 3/4	42 1/2	234	32	VST1666SOC	\$2,002	\$2,920							
	16 3/16	65 3/4	42 1/2	234	32	VSV1666SOC			\$3,364	\$4,281	\$3,804	\$3,703	\$4,620	\$4,144	
	16 3/16	59 3/4	42 1/2	218	29	VST1660SOC	\$1,910	\$2,791							
	16 3/16	59 3/4	42 1/2	218	29	VSV1660SOC			\$3,185	\$4,066	\$3,626	\$3,503	\$4,383	\$3,944	
	16 3/16	53 3/4	42 1/2	198	26	VST1654SOC	\$1,815	\$2,657							
	16 3/16	53 3/4	42 1/2	198	26	VSV1654SOC			\$3,037	\$3,879	\$3,477	\$3,341	\$4,184	\$3,782	

- select door style
- aluminum frame door offered in both frosted or white back painted glass, specify when ordering
- white markerboard doors available, specify and add \$557 list to laminate or veneer door price
- locking available on laminate or wood doors, specify and add \$79 list; glass doors are non-locking
- small grommet in top of back to fit LED lights
- tackboards available, see pages [VS196-VS199](#) or [VS200-VS203](#)
- tasklights available, see pages [VS318](#)
- 19" vertical clearance from desk top to bottom of valance rail
- pulls not available

Description	D	W	H	CTN WT	CU FT	① Model	Laminate		Flat Cut Veneer			Double Cut Veneer			
							Laminate Door	Alum. Frm Glass Door	Veneer Door	Alum. Frm Glass Door	Wood Glass Door	Veneer Door	Alum. Frm Glass Door	Wood Frm Glass Door	
Storage Overhead Cabinet with Three Doors and Cubbies 	16 3/16	47 3/4	42 1/2	174	23	VST1648SOCR	\$1,728	\$2,407							
	16 3/16	47 3/4	42 1/2	174	23	VSV1648SOCR			\$2,909	\$3,589	\$3,219	\$3,201	\$3,880	\$3,510	
	16 3/16	47 3/4	42 1/2	174	23	VST1648SOCL	\$1,728	\$2,407							
	16 3/16	47 3/4	42 1/2	174	23	VSV1648SOCL			\$2,909	\$3,589	\$3,219	\$3,201	\$3,880	\$3,510	
	16 3/16	41 3/4	42 1/2	153	21	VST1642SOCR	\$1,640	\$2,282							
	16 3/16	41 3/4	42 1/2	153	21	VSV1642SOCR			\$2,794	\$3,435	\$3,103	\$3,075	\$3,717	\$3,385	
	16 3/16	41 3/4	42 1/2	153	21	VST1642SOCL	\$1,640	\$2,282							
	16 3/16	41 3/4	42 1/2	153	21	VSV1642SOCL			\$2,794	\$3,435	\$3,103	\$3,075	\$3,717	\$3,385	

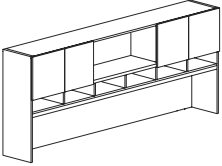
- select door style
- aluminum frame door offered in both frosted or white back painted glass, specify when ordering
- white markerboard doors available, specify and add \$392 list to laminate or veneer door price
- locking available on laminate or wood doors, specify and add \$74 list; glass doors are non-locking
- small grommet in top of back to fit LED lights
- tackboards available, see pages [VS196-VS199](#) or [VS200-VS203](#)
- tasklights available, see pages [VS318](#)
- 19" vertical clearance from desk top to bottom of valance rail
- right door configuration - 1 door hinges left and 2 doors hinge right
- left door configuration - 1 door hinges right and 2 doors hinge left
- pulls not available

Description	D	W	H	CTN WT	CU FT	① Model	Laminate		Flat Cut Veneer			Double Cut Veneer			
							Laminate Door	Alum. Frm Glass Door	Veneer Door	Alum. Frm Glass Door	Wood Frm Glass Door	Veneer Door	Alum. Frm Glass Door	Wood Frm Glass Door	
Storage Overhead Cabinet with Two Doors and Cubbies 	16 3/16	35 3/4	42 1/2	130	18	VST1636SOC	\$1,560	\$2,038							
	16 3/16	35 3/4	42 1/2	130	18	VSV1636SOC			\$2,687	\$3,166	\$2,872	\$2,957	\$3,435	\$3,141	
	16 3/16	29 3/4	42 1/2	114	15	VST1630SOC	\$1,485	\$1,926							
	16 3/16	29 3/4	42 1/2	114	15	VSV1630SOC			\$2,606	\$3,048	\$2,791	\$2,866	\$3,308	\$3,051	

- select door style
- aluminum frame door offered in both frosted or white back painted glass, specify when ordering
- white markerboard doors available, specify and add \$233 list to laminate or veneer door price
- locking available on laminate or wood doors, specify and add \$47 list; glass doors are non-locking
- small grommet in top of back to fit LED lights
- tackboards available, see pages [VS196-VS199](#) or [VS200-VS203](#)
- tasklights available, see pages [VS318](#)
- 19" vertical clearance from desk top to bottom of valance rail
- pulls not available

To Order, Specify:

- | | | | |
|--|--|--|--|
| ① Model Number | Laminate - VST | Veneer - VSV | |
| ② Worksurface Material (see page VI3) | ② Wood Species - Cherry (CH1), Maple (MA1)
Walnut (WA1), Black Oak (BO1) or
Double Cut (DC1) (see page VI1) | ④ Edge Profile (see page VI4) | |
| a.) TFL | | ⑤ Pull Style and Color (see page VI5) | |
| b.) HPL | | ⑥ Optional Grommet Location & Color -
Matte Black (MBK) or Arctic Silver (ASL)
(see page VI6) | |
| ③ Laminate Color (see page VI3) | ③ Finish Color (see page VI1) | ⑦ Other Product Options (see page VI10) | |
| a.) Worksurface Color | | ⑧ Accessories (see page VS314) | |
| b.) Chassis Color | | ⑨ Power and Data Options (see page VS324) | |
| c.) Drawer Color | | | |

Description	D	W	H	CTN WT	CU FT	① Model	Laminate		Flat Cut Veneer			Double Cut Veneer		
							Laminate Door	Alum. Frm Glass Door	Veneer Door	Alum. Frm Glass Door	Wood Frm Glass Door	Veneer Door	Alum. Frm Glass Door	Wood Frm Glass Door
Storage Overhead Cabinet with Four Doors, Open Center Shelf and Cubbies 	16 3/16	107 3/4	42 1/2	317	51	VST16108SMOC	\$2,850	\$3,809						
	16 3/16	107 3/4	42 1/2	317	51	VSV16108SMOC			\$5,556	\$6,515	\$5,997	\$6,113	\$7,072	\$6,553
	16 3/16	101 3/4	42 1/2	299	48	VST16102SMOC	\$2,692	\$3,626						
	16 3/16	101 3/4	42 1/2	299	48	VSV16102SMOC			\$5,230	\$6,164	\$5,671	\$5,754	\$6,688	\$6,195
	16 3/16	95 3/4	42 1/2	281	45	VST1696SMOC	\$2,549	\$3,744						
	16 3/16	95 3/4	42 1/2	281	45	VSV1696SMOC			\$4,919	\$6,115	\$5,360	\$5,410	\$6,606	\$5,851
	16 3/16	89 3/4	42 1/2	263	43	VST1690SMOC	\$2,408	\$3,570						
	16 3/16	89 3/4	42 1/2	263	43	VSV1690SMOC			\$4,463	\$5,625	\$4,904	\$4,908	\$6,070	\$5,349

- select door style
- aluminum frame door offered in both frosted or white back painted glass, specify when ordering
- white markerboard doors available, specify and add \$557 list to laminate or veneer door price
- locking available on laminate or wood doors, specify and add \$79 list; glass doors are non-locking
- small grommet in top of back to fit LED lights
- tackboards available, see pages [VS196-VS199](#) or [VS200-VS203](#)
- tasklights available, see pages [VS318](#)
- 19" vertical clearance from desk top to bottom of valance rail
- pulls not available

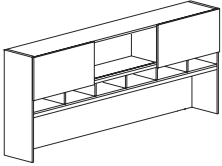
Description	D	W	H	CTN WT	CU FT	① Model	Laminate		Flat Cut Veneer			Double Cut Veneer			
							Laminate Door	Alum. Frm Glass Door	Veneer Door	Alum. Frm Glass Door	Wood Glass Door	Veneer Door	Alum. Frm Glass Door	Wood Frm Glass Door	
Storage Overhead Cabinet with Two Doors, Open Center Shelf and Cubbies 	16 3/16	83 3/4	42 1/2	234	40	VST1684SMOC	\$2,277	\$2,794							
	16 3/16	83 3/4	42 1/2	234	40	VSV1684SMOC			\$4,046	\$4,563	\$4,231	\$4,455	\$4,972	\$4,640	
	16 3/16	77 3/4	42 1/2	221	37	VST1678SMOC	\$2,150	\$2,649							
	16 3/16	77 3/4	42 1/2	221	37	VSV1678SMOC			\$3,719	\$4,218	\$3,904	\$4,091	\$4,590	\$4,276	
	16 3/16	71 3/4	42 1/2	208	34	VST1672SMOC	\$2,032	\$2,511							
	16 3/16	71 3/4	42 1/2	208	34	VSV1672SMOC			\$3,413	\$3,891	\$3,597	\$3,754	\$4,233	\$3,939	
	16 3/16	65 3/4	42 1/2	196	32	VST1666SMOC	\$1,918	\$2,377							
	16 3/16	65 3/4	42 1/2	196	32	VSV1666SMOC			\$3,221	\$3,680	\$3,406	\$3,542	\$4,001	\$3,726	
	16 3/16	59 3/4	42 1/2	183	29	VST1660SMOC	\$1,827	\$2,269							
	16 3/16	59 3/4	42 1/2	183	29	VSV1660SMOC			\$3,040	\$3,481	\$3,224	\$3,344	\$3,786	\$3,529	
	16 3/16	53 3/4	42 1/2	165	26	VST1654SMOC	\$1,732	\$2,155							
	16 3/16	53 3/4	42 1/2	165	26	VSV1654SMOC			\$2,890	\$3,313	\$3,074	\$3,180	\$3,603	\$3,365	

- select door style
- aluminum frame door offered in both frosted or white back painted glass, specify when ordering
- white markerboard doors available, specify and add \$233 list to laminate or veneer door price
- locking available on laminate or wood doors, specify and add \$79 list; glass doors are non-locking
- small grommet in top of back to fit LED lights
- tackboards available, see pages [VS196-VS199](#) or [VS200-VS203](#)
- tasklights available, see pages [VS318](#)
- 19" vertical clearance from desk top to bottom of valance rail
- pulls not available

To Order, Specify:

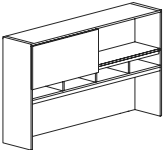
① Model Number	Laminate - VST	Veneer - VSV
	<ul style="list-style-type: none"> ② Worksurface Material (see page VI3) <ul style="list-style-type: none"> a.) TFL b.) HPL ③ Laminate Color (see page VI3) <ul style="list-style-type: none"> a.) Worksurface Color b.) Chassis Color c.) Drawer Color 	<ul style="list-style-type: none"> ② Wood Species - Cherry (CH1), Maple (MA1) Walnut (WA1), Black Oak (BO1) or Double Cut (DC1) (see page VI1) ③ Finish Color (see page VI1)
		<ul style="list-style-type: none"> ④ Edge Profile (see page VI4) ⑤ Pull Style and Color (see page VI5) ⑥ Optional Grommet Location & Color - Matte Black (MBK) or Arctic Silver (ASL) (see page VI6) ⑦ Other Product Options (see page VI10) ⑧ Accessories (see page VS314) ⑨ Power and Data Options (see page VS324)

Description	D	W	H	CTN WT	CU FT	① Model	Laminate	Flat Cut Veneer	Double Cut Veneer
Storage Overhead Cabinet with Two Sliding Doors and Cubbies	16 3/16	107 3/4	42 1/2	48	51	VST16108SDC	\$3,361		
	16 3/16	107 3/4	42 1/2	372	51	VSV16108SDC		\$6,086	\$6,695
	16 3/16	101 3/4	42 1/2	352	48	VST16102SDC	\$3,200		
	16 3/16	101 3/4	42 1/2	352	48	VSV16102SDC		\$5,679	\$6,247
	16 3/16	95 3/4	42 1/2	331	45	VST1696SDC	\$3,042		
	16 3/16	95 3/4	42 1/2	331	45	VSV1696SDC		\$5,288	\$5,819
	16 3/16	89 3/4	42 1/2	311	43	VST1690SDC	\$2,896		
	16 3/16	89 3/4	42 1/2	311	43	VSV1690SDC		\$4,910	\$5,400

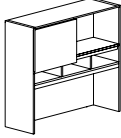


- white markerboard doors available, specify and add \$428 list to laminate or veneer door price
- locking not available
- small grommet in top of back to fit LED lights
- tackboards available, see pages [VS196-VS199](#) or [VS200-VS203](#)
- tasklights available, see pages [VS318](#)
- 19" vertical clearance from desk top to bottom of valance rail
- pulls not available

Storage Overhead Cabinet with Sliding Door and Cubbies	16 3/16	83 3/4	42 1/2	279	40	VST1684SDC	\$2,754		
	16 3/16	83 3/4	42 1/2	279	40	VSV1684SDC		\$4,419	\$4,861
	16 3/16	77 3/4	42 1/2	264	37	VST1678SDC	\$2,618		
	16 3/16	77 3/4	42 1/2	264	37	VSV1678SDC		\$4,153	\$4,571
	16 3/16	71 3/4	42 1/2	248	34	VST1672SDC	\$2,491		
	16 3/16	71 3/4	42 1/2	248	34	VSV1672SDC		\$3,857	\$4,242
	16 3/16	65 3/4	42 1/2	234	32	VST1666SDC	\$2,369		
	16 3/16	65 3/4	42 1/2	234	32	VSV1666SDC		\$3,702	\$4,071
	16 3/16	59 3/4	42 1/2	218	29	VST1660SDC	\$2,272		
	16 3/16	59 3/4	42 1/2	218	29	VSV1660SDC		\$3,557	\$3,910
	16 3/16	53 3/4	42 1/2	198	26	VST1654SDC	\$2,171		
	16 3/16	53 3/4	42 1/2	198	26	VSV1654SDC		\$3,435	\$3,782



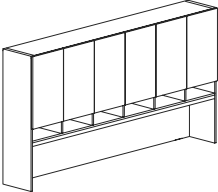
- white markerboard door available, specify and add \$215 list to laminate or veneer door price
- locking not available
- small grommet in top of back to fit LED lights
- tackboards available, see pages [VS196-VS199](#) or [VS200-VS203](#)
- tasklights available, see pages [VS318](#)
- 19" vertical clearance from desk top to bottom of valance rail
- pulls not available

Description	D	W	H	CTN WT	CU FT	① Model	Laminate	Flat Cut Veneer	Double Cut Veneer
Storage Overhead Cabinet with Sliding Door and Cubbies 	16 3/16	47 3/4	42 1/2	174	23	VST1648SDC	\$2,076		
	16 3/16	47 3/4	42 1/2	174	23	VSV1648SDC		\$3,236	\$3,562
	16 3/16	41 3/4	42 1/2	153	21	VST1642SDC	\$1,989		
	16 3/16	41 3/4	42 1/2	153	21	VSV1642SDC		\$3,146	\$3,461
	16 3/16	35 3/4	42 1/2	130	18	VST1636SDC	\$1,906		
	16 3/16	35 3/4	42 1/2	130	18	VSV1636SDC		\$2,998	\$3,298
	16 3/16	29 3/4	42 1/2	114	15	VST1630SDC	\$1,883		
	16 3/16	29 3/4	42 1/2	114	15	VSV1630SDC		\$2,841	\$3,125

- white markerboard door available, specify and add \$215 list to laminate or veneer door price
- locking not available
- small grommet in top of back to fit LED lights
- tackboards available, see pages [VS196-VS199](#) or [VS200-VS203](#)
- tasklights available, see pages [VS318](#)
- 19" vertical clearance from desk top to bottom of valance rail
- pulls not available

To Order, Specify:

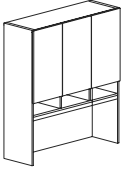
① Model Number	Laminate - VST	Veneer - VSV	
	② Worksurface Material (see page VI3) a.) TFL b.) HPL ③ Laminate Color (see page VI3) a.) Worksurface Color b.) Chassis Color c.) Drawer Color	② Wood Species - Cherry (CH1), Maple (MA1) Walnut (WA1), Black Oak (BO1) or Double Cut (DC1) (see page VI1) ③ Finish Color (see page VI1)	④ Edge Profile (see page VI4) ⑤ Pull Style and Color (see page VI5) ⑥ Optional Grommet Location & Color - Matte Black (MBK) or Arctic Silver (ASL) (see page VI6) ⑦ Other Product Options (see page VI10) ⑧ Accessories (see page VS314) ⑨ Power and Data Options (see page VS324)

Description	D	W	H	CTN WT	CU FT	① Model	Laminate		Flat Cut Veneer			Double Cut Veneer			
							Laminate Door	Alum. Frm Glass Door	Veneer Door	Alum. Frm Glass Door	Wood Frm Glass Door	Veneer Door	Alum. Frm Glass Door	Wood Frm Glass Door	
Double Height Storage Overhead Cabinet with Six Doors and Cubbies 	16 ³ / ₁₆	107 ³ / ₄	54 ¹ / ₂	466	65	VST16108DSOC	\$3,521	\$5,410							
	16 ³ / ₁₆	107 ³ / ₄	54 ¹ / ₂	466	65	VSV16108DSOC			\$6,395	\$8,285	\$7,218	\$7,036	\$8,925	\$7,858	
	16 ³ / ₁₆	101 ³ / ₄	54 ¹ / ₂	441	61	VST16102DSOC	\$3,348	\$5,185							
	16 ³ / ₁₆	101 ³ / ₄	54 ¹ / ₂	441	61	VSV16102DSOC			\$6,030	\$7,866	\$6,852	\$6,632	\$8,469	\$7,454	
	16 ³ / ₁₆	95 ³ / ₄	54 ¹ / ₂	415	58	VST1696DSOC	\$3,184	\$4,968							
	16 ³ / ₁₆	95 ³ / ₄	54 ¹ / ₂	415	58	VSV1696DSOC			\$5,670	\$7,453	\$6,492	\$6,235	\$8,018	\$7,057	
	16 ³ / ₁₆	89 ³ / ₄	54 ¹ / ₂	389	54	VST1690DSOC	\$3,026	\$4,759							
	16 ³ / ₁₆	89 ³ / ₄	54 ¹ / ₂	389	54	VSV1690DSOC			\$5,428	\$7,160	\$6,250	\$5,969	\$7,701	\$6,791	

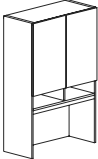
- select door style
- aluminum frame door offered in both frosted or white back painted glass, specify when ordering
- white markerboard doors available, specify and add \$1,040 list to laminate or veneer door price
- locking available on laminate or wood doors, specify and add \$115 list; glass doors are non-locking
- small grommet in top of back to fit LED lights
- tackboards available, see pages [VS196-VS199](#) or [VS200-VS203](#)
- tasklights available, see pages [VS318](#)
- 19" vertical clearance from desk top to bottom of valance rail
- pulls not available
- backside of unit intended to go against a wall, cabinet should be secured to a wall as a safety precaution

Description	D	W	H	CTN WT	CU FT	① Model	Laminate		Flat Cut Veneer			Double Cut Veneer			
							Laminate Door	Alum. Frm Glass Door	Veneer Door	Alum. Frm Glass Door	Wood Frm Glass Door	Veneer Door	Alum. Frm Glass Door	Wood Frm Glass Door	
Double Height Storage Overhead Cabinet with Four Doors and Cubbies 	16 ³ / ₁₆	83 ³ / ₄	54 ¹ / ₂	349	51	VST1684DSOC	\$2,879	\$4,242							
	16 ³ / ₁₆	83 ³ / ₄	54 ¹ / ₂	349	51	VSV1684DSOC			\$5,134	\$6,497	\$5,774	\$5,645	\$7,008	\$6,286	
	16 ³ / ₁₆	77 ³ / ₄	54 ¹ / ₂	330	47	VST1678DSOC	\$2,737	\$4,050							
	16 ³ / ₁₆	77 ³ / ₄	54 ¹ / ₂	330	47	VSV1678DSOC			\$4,785	\$6,098	\$5,426	\$5,264	\$6,577	\$5,904	
	16 ³ / ₁₆	71 ³ / ₄	54 ¹ / ₂	311	44	VST1672DSOC	\$2,601	\$3,860							
	16 ³ / ₁₆	71 ³ / ₄	54 ¹ / ₂	311	44	VSV1672DSOC			\$4,464	\$5,723	\$5,105	\$4,910	\$6,169	\$5,551	
	16 ³ / ₁₆	65 ³ / ₄	54 ¹ / ₂	293	40	VST1666DSOC	\$2,460	\$3,670							
	16 ³ / ₁₆	65 ³ / ₄	54 ¹ / ₂	293	40	VSV1666DSOC			\$4,261	\$5,471	\$4,902	\$4,688	\$5,897	\$5,328	
	16 ³ / ₁₆	59 ³ / ₄	54 ¹ / ₂	274	37	VST1660DSOC	\$2,369	\$3,525							
	16 ³ / ₁₆	59 ³ / ₄	54 ¹ / ₂	274	37	VSV1660DSOC			\$4,071	\$5,227	\$4,711	\$4,479	\$5,635	\$5,119	
	16 ³ / ₁₆	53 ³ / ₄	54 ¹ / ₂	248	33	VST1654DSOC	\$2,259	\$3,362							
	16 ³ / ₁₆	53 ³ / ₄	54 ¹ / ₂	248	33	VSV1654DSOC			\$3,918	\$5,022	\$4,559	\$4,311	\$5,415	\$4,951	

- select door style
- aluminum frame door offered in both frosted or white back painted glass, specify when ordering
- white markerboard doors available, specify and add \$811 list to laminate or veneer door price
- locking available on laminate or wood doors, specify and add \$79 list; glass doors are non-locking
- small grommet in top of back to fit LED lights
- tackboards available, see pages [VS196-VS199](#) or [VS200-VS203](#)
- tasklights available, see pages [VS318](#)
- 19" vertical clearance from desk top to bottom of valance rail
- pulls not available
- backside of unit intended to go against a wall, cabinet should be secured to a wall as a safety precaution

Description	D	W	H	CTN WT	CU FT	① Model	Laminate		Flat Cut Veneer			Double Cut Veneer		
							Laminate Door	Alum. Frm Glass Door	Veneer Door	Alum. Frm Glass Door	Wood Glass Door	Veneer Door	Alum. Frm Glass Door	Wood Frm Glass Door
Double Height Storage Overhead Cabinet with Three Doors and Cubbies 	16 3/16	47 3/4	54 1/2	218	30	VST1648DSOCR	\$2,155	\$3,047						
	16 3/16	47 3/4	54 1/2	218	30	VSV1648DSOCR			\$3,674	\$4,566	\$4,098	\$4,042	\$4,934	\$4,466
	16 3/16	47 3/4	54 1/2	218	30	VST1648DSOCL	\$2,155	\$3,047						
	16 3/16	47 3/4	54 1/2	218	30	VSV1648DSOCL			\$3,674	\$4,566	\$4,098	\$4,042	\$4,934	\$4,466
	16 3/16	41 3/4	54 1/2	192	26	VST1642DSOCR	\$2,057	\$2,898						
	16 3/16	41 3/4	54 1/2	192	26	VSV1642DSOCR			\$3,558	\$4,400	\$3,983	\$3,913	\$4,754	\$4,337
	16 3/16	41 3/4	54 1/2	192	26	VST1642DSOCL	\$2,057	\$2,898						
	16 3/16	41 3/4	54 1/2	192	26	VSV1642DSOCL			\$3,558	\$4,400	\$3,983	\$3,913	\$4,754	\$4,337

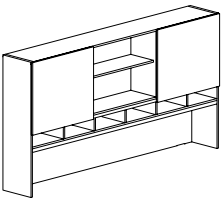
- select door style
- aluminum frame door offered in both frosted or white back painted glass, specify when ordering
- white markerboard doors available, specify and add \$537 list to laminate or veneer door price
- locking available on laminate or wood doors, specify and add \$74 list; glass doors are non-locking
- small grommet in top of back to fit LED lights
- tackboards available, see pages [VS196-VS199](#) or [VS200-VS203](#)
- tasklights available, see pages [VS318](#)
- 19" vertical clearance from desk top to bottom of valance rail
- right door configuration - 1 door hinges left and 2 doors hinge right
- left door configuration - 1 door hinges right and 2 doors hinge left
- pulls not available
- backside of unit intended to go against a wall, cabinet should be secured to a wall as a safety precaution

Description	D	W	H	CTN WT	CU FT	① Model	Laminate		Flat Cut Veneer			Double Cut Veneer		
							Laminate Door	Alum. Frm Glass Door	Veneer Door	Alum. Frm Glass Door	Wood Frm Glass Door	Veneer Door	Alum. Frm Glass Door	Wood Frm Glass Door
Double Height Storage Overhead Cabinet with Two Doors and Cubbies 	16 3/16	35 3/4	54 1/2	163	23	VST1636DSOC	\$1,965	\$2,596						
	16 3/16	35 3/4	54 1/2	163	23	VSV1636DSOC			\$3,379	\$4,009	\$3,670	\$3,716	\$4,346	\$4,007
	16 3/16	29 3/4	54 1/2	143	19	VST1630DSOC	\$1,879	\$2,457						
	16 3/16	29 3/4	54 1/2	143	19	VSV1630DSOC			\$3,301	\$3,879	\$3,592	\$3,632	\$4,210	\$3,923

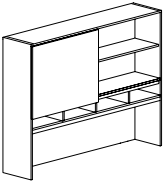
- select door style
- aluminum frame door offered in both frosted or white back painted glass, specify when ordering
- white markerboard doors available, specify and add \$368 list to laminate or veneer door price
- locking available on laminate or wood doors, specify and add \$47 list; glass doors are non-locking
- small grommet in top of back to fit LED lights
- tackboards available, see pages [VS196-VS199](#) or [VS200-VS203](#)
- tasklights available, see pages [VS318](#)
- 19" vertical clearance from desk top to bottom of valance rail
- pulls not available
- backside of unit intended to go against a wall, cabinet should be secured to a wall as a safety precaution

To Order, Specify:

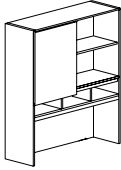
① Model Number	Laminate - VST	Veneer - VSV
	<p>② Worksurface Material (see page VI3)</p> <p>a.) TFL</p> <p>b.) HPL</p> <p>③ Laminate Color (see page VI3)</p> <p>a.) Worksurface Color</p> <p>b.) Chassis Color</p> <p>c.) Drawer Color</p>	<p>② Wood Species - Cherry (CH1), Maple (MA1)</p> <p>Walnut (WA1), Black Oak (BO1) or</p> <p>Double Cut (DC1) (see page VI1)</p> <p>③ Finish Color (see page VI1)</p>
		<p>④ Edge Profile (see page VI4)</p> <p>⑤ Pull Style and Color (see page VI5)</p> <p>⑥ Optional Grommet Location & Color -</p> <p>Matte Black (MBK) or Arctic Silver (ASL)</p> <p>(see page VI6)</p> <p>⑦ Other Product Options (see page VI10)</p> <p>⑧ Accessories (see page VS314)</p> <p>⑨ Power and Data Options (see page VS324)</p>

Description	D	W	H	CTN WT	CU FT	① Model	Laminate	Flat Cut Veneer	Double Cut Veneer
Double Height Storage Overhead Cabinet with Two Sliding Doors and Cubbies 	16 3/16	107 3/4	54 1/2	466	65	VST16108DSDC	\$3,934		
	16 3/16	107 3/4	54 1/2	466	65	VSV16108DSDC		\$6,633	\$7,297
	16 3/16	101 3/4	54 1/2	441	61	VST16102DSDC	\$3,758		
	16 3/16	101 3/4	54 1/2	441	61	VSV16102DSDC		\$6,303	\$6,934
	16 3/16	95 3/4	54 1/2	415	58	VST1696DSDC	\$3,590		
	16 3/16	95 3/4	54 1/2	415	58	VSV1696DSDC		\$6,082	\$6,691
	16 3/16	89 3/4	54 1/2	389	54	VST1690DSDC	\$3,429		
	16 3/16	89 3/4	54 1/2	389	54	VSV1690DSDC		\$5,792	\$6,371

- white markerboard doors available, specify and add \$565 list to laminate or veneer door price
- locking not available
- small grommet in top of back to fit LED lights
- tackboards available, see pages [VS196-VS199](#) or [VS200-VS203](#)
- tasklights available, see pages [VS318](#)
- 19" vertical clearance from desk top to bottom of valance rail
- pulls not available
- backside of unit intended to go against a wall, cabinet should be secured to a wall as a safety precaution

Double Height Storage Overhead Cabinet with Sliding Door and Cubbies 	16 3/16	83 3/4	54 1/2	349	51	VST1684DSDC	\$3,275		
	16 3/16	83 3/4	54 1/2	349	51	VSV1684DSDC		\$5,391	\$5,929
	16 3/16	77 3/4	54 1/2	330	47	VST1678DSDC	\$3,129		
	16 3/16	77 3/4	54 1/2	330	47	VSV1678DSDC		\$5,067	\$5,571
	16 3/16	71 3/4	54 1/2	311	44	VST1672DSDC	\$2,989		
	16 3/16	71 3/4	54 1/2	311	44	VSV1672DSDC		\$4,702	\$5,174
	16 3/16	65 3/4	54 1/2	293	40	VST1666DSDC	\$2,842		
	16 3/16	65 3/4	54 1/2	293	40	VSV1666DSDC		\$4,514	\$4,966
	16 3/16	59 3/4	54 1/2	274	37	VST1660DSDC	\$2,750		
	16 3/16	59 3/4	54 1/2	274	37	VSV1660DSDC		\$4,337	\$4,773
16 3/16	53 3/4	54 1/2	248	33	VST1654DSDC	\$2,640			
16 3/16	53 3/4	54 1/2	248	33	VSV1654DSDC		\$4,190	\$4,609	

- white markerboard door available, specify and add \$284 list to laminate or veneer door price
- locking not available
- small grommet in top of back to fit LED lights
- tackboards available, see pages [VS196-VS199](#) or [VS200-VS203](#)
- tasklights available, see pages [VS318](#)
- 19" vertical clearance from desk top to bottom of valance rail
- pulls not available
- backside of unit intended to go against a wall, cabinet should be secured to a wall as a safety precaution

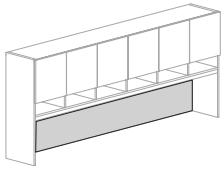
Description	D	W	H	CTN WT	CU FT	① Model	Laminate	Flat Cut Veneer	Double Cut Veneer
Double Height Storage Overhead Cabinet with Sliding Door and Cubbies 	16 3/16	47 3/4	54 1/2	218	30	VST1648DSDC	\$2,531		
	16 3/16	47 3/4	54 1/2	218	30	VSV1648DSDC		\$3,948	\$4,343
	16 3/16	41 3/4	54 1/2	192	26	VST1642DSDC	\$2,436		
	16 3/16	41 3/4	54 1/2	192	26	VSV1642DSDC		\$3,836	\$4,219
	16 3/16	35 3/4	54 1/2	163	23	VST1636DSDC	\$2,344		
	16 3/16	35 3/4	54 1/2	163	23	VSV1636DSDC		\$3,658	\$4,025
	16 3/16	29 3/4	54 1/2	143	19	VST1630DSDC	\$2,327		
	16 3/16	29 3/4	54 1/2	143	19	VSV1630DSDC		\$3,605	\$3,964

- white markerboard door available, specify and add \$284 list to laminate or veneer door price
- locking not available
- small grommet in top of back to fit LED lights
- tackboards available, see pages [VS196-VS199](#) or [VS200-VS203](#)
- tasklights available, see pages [VS318](#)
- 19" vertical clearance from desk top to bottom of valance rail
- pulls not available
- backside of unit intended to go against a wall, cabinet should be secured to a wall as a safety precaution

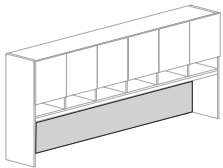
To Order, Specify:

① Model Number	Laminate - VST	Veneer - VSV	
	② Worksurface Material (see page VI3) a.) TFL b.) HPL ③ Laminate Color (see page VI3) a.) Worksurface Color b.) Chassis Color c.) Drawer Color	② Wood Species - Cherry (CH1), Maple (MA1) Walnut (WA1), Black Oak (BO1) or Double Cut (DC1) (see page VI1) ③ Finish Color (see page VI1)	④ Edge Profile (see page VI4) ⑤ Pull Style and Color (see page VI5) ⑥ Optional Grommet Location & Color - Matte Black (MBK) or Arctic Silver (ASL) (see page VI6) ⑦ Other Product Options (see page VI10) ⑧ Accessories (see page VS314) ⑨ Power and Data Options (see page VS324)

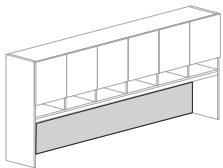
Description	D	W	H	CTN WT	CU FT	① Model	List Price Per Grade
Tackboard for Front of 108" w Storage Overhead Cabinet with Cubbies	1/2	106 1/8	19 1/2	19	6	VSB10820TKC	COM \$508
							A \$542
<ul style="list-style-type: none"> · for use with 108" w overhead · com ydg: 3 							B \$608
							C \$726
							D \$877
							E \$1,029
							F \$1,263
							G \$1,516
							H \$1,785
							I \$2,205
							J \$2,710



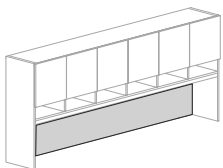
Tackboard for Front of 102" w Storage Overhead Cabinet with Cubbies	1/2	100 1/8	19 1/2	18	6	VSB10220TKC	COM \$496
							A \$529
<ul style="list-style-type: none"> · for use with 102" w overhead · com ydg: 3 							B \$596
							C \$715
							D \$866
							E \$1,016
							F \$1,252
							G \$1,505
							H \$1,773
							I \$2,193
							J \$2,697

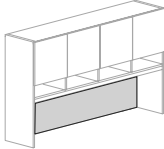


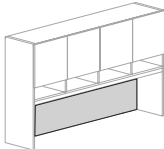
Tackboard for Front of 96" w Storage Overhead Cabinet with Cubbies	1/2	94 1/8	19 1/2	17	5	VSB9620TKC	COM \$462
							A \$491
<ul style="list-style-type: none"> · for use with 96" w overhead · com ydg: 3 							B \$554
							C \$663
							D \$802
							E \$941
							F \$1,160
							G \$1,390
							H \$1,640
							I \$2,028
							J \$2,493

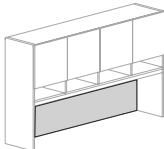


Tackboard for Front of 90" w Storage Overhead Cabinet with Cubbies	1/2	88 1/8	19 1/2	16	5	VSB9020TKC	COM \$455
							A \$486
<ul style="list-style-type: none"> · for use with 90" w overhead · com ydg: 3 							B \$549
							C \$656
							D \$797
							E \$936
							F \$1,153
							G \$1,385
							H \$1,634
							I \$2,022
							J \$2,487



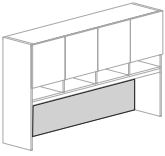
Description	D	W	H	CTN WT	CU FT	① Model	List Price Per Grade
Tackboard for Front of 84" w Storage Overhead Cabinet with Cubbies  <ul style="list-style-type: none"> · for use with 84" w overhead · com ydg: 3 	1/2	82 1/8	19 1/2	15	5	VSB8420TKC	COM \$412 A \$439 B \$497 C \$595 D \$724 E \$851 F \$1,050 G \$1,263 H \$1,492 I \$1,848 J \$2,275

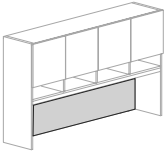
Tackboard for Front of 78" w Storage Overhead Cabinet with Cubbies  <ul style="list-style-type: none"> · for use with 78" w overhead · com ydg: 3 	1/2	76 1/8	19 1/2	14	4	VSB7820TKC	COM \$387 A \$414 B \$465 C \$555 D \$671 E \$788 F \$970 G \$1,163 H \$1,370 I \$1,693 J \$2,081
--	-----	--------	--------	----	---	-------------------	--

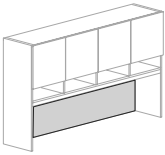
Tackboard for Front of 72" w Storage Overhead Cabinet with Cubbies  <ul style="list-style-type: none"> · for use with 72" w overhead · com ydg: 2 	1/2	70 1/8	19 1/2	13	4	VSB7220TKC	COM \$362 A \$385 B \$432 C \$513 D \$618 E \$723 F \$886 G \$1,060 H \$1,247 I \$1,537 J \$1,885
--	-----	--------	--------	----	---	-------------------	--

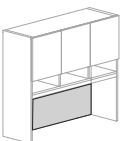
To Order, Specify:

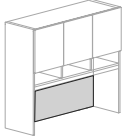
- ① Model Number
- ② Fabric Selection: vendor, pattern, color
 Visit www.jsifurniture.com/finishes-and-materials/textiles
 for our textiles program. See selection of standard and
 graded in manufacturers and patterns.

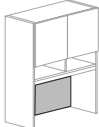
Description	D	W	H	CTN WT	CU FT	① Model	List Price Per Grade
Tackboard for Front of 66" w Storage Overhead Cabinet with Cubbies  <ul style="list-style-type: none"> · for use with 66" w overhead · com ydg: 2 	1/2	64 1/8	19 1/2	12	4	VSB6620TKC	COM \$339
	A \$358						
	B \$400						
	C \$472						
	D \$566						
	E \$660						
	F \$804						
	G \$959						
	H \$1,125						
	I \$1,383						
	J \$1,693						

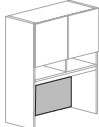
Tackboard for Front of 60" w Storage Overhead Cabinet with Cubbies  <ul style="list-style-type: none"> · for use with 60" w overhead · com ydg: 2 	1/2	58 1/8	19 1/2	11	3	VSB6020TKC	COM \$326
	A \$347						
	B \$389						
	C \$462						
	D \$554						
	E \$647						
	F \$791						
	G \$948						
	H \$1,112						
	I \$1,371						
	J \$1,681						

Tackboard for Front of 54" w Storage Overhead Cabinet with Cubbies  <ul style="list-style-type: none"> · for use with 54" w overhead · com ydg: 2 	1/2	52 1/8	19 1/2	10	3	VSB5420TKC	COM \$303
	A \$320						
	B \$356						
	C \$420						
	D \$502						
	E \$583						
	F \$711						
	G \$846						
	H \$991						
	I \$1,216						
	J \$1,488						

Tackboard for Front of 48" w Storage Overhead Cabinet with Cubbies  <ul style="list-style-type: none"> · for use with 48" w overhead · com ydg: 2 	1/2	46 1/8	19 1/2	9	3	VSB4820TKC	COM \$273
	A \$293						
	B \$330						
	C \$392						
	D \$472						
	E \$555						
	F \$681						
	G \$817						
	H \$962						
	I \$1,188						
	J \$1,460						

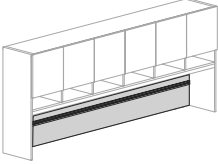
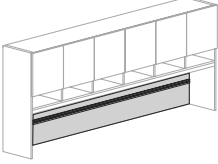
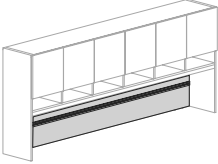
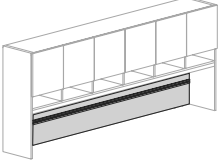
Description	D	W	H	CTN WT	CU FT	① Model	List Price Per Grade	
Tackboard for Front of 42" w Storage Overhead Cabinet with Cubbies 	1/2	40 1/8	19 1/2	8	3	VSB4220TKC	COM \$249	
	<ul style="list-style-type: none"> · for use with 42" w overhead · com ydg: 2 							A \$265
								B \$296
								C \$351
								D \$420
								E \$489
								F \$598
								G \$715
								H \$839
								I \$1,034
								J \$1,264

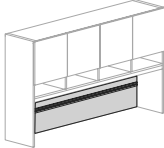
Tackboard for Front of 36" w Storage Overhead Cabinet with Cubbies 	1/2	34 1/8	19 1/2	7	2	VSB3620TKC	COM \$226	
	<ul style="list-style-type: none"> · for use with 36" w overhead · com ydg: 1 							A \$239
								B \$265
								C \$309
								D \$368
								E \$426
								F \$517
								G \$613
								H \$717
								I \$878
								J \$1,072

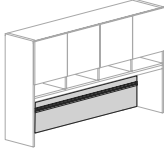
Tackboard for Front of 30" w Storage Overhead Cabinet with Cubbies 	1/2	28 1/8	19 1/2	6	2	VSB3020TKC	COM \$215	
	<ul style="list-style-type: none"> · for use with 30" w overhead · com ydg: 1 							A \$228
								B \$254
								C \$298
								D \$357
								E \$416
								F \$506
								G \$603
								H \$706
								I \$868
								J \$1,061

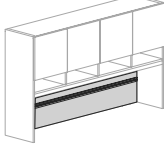
To Order, Specify:

- ① Model Number
- ② Fabric Selection: vendor, pattern, color
 Visit www.jsifurniture.com/finishes-and-materials/textiles
 for our textiles program. See selection of standard and
 graded in manufacturers and patterns.

Description	D	W	H	CTN WT	CU FT	① Model	List Price Per Grade
Tackboard for Accessory Rail of 108" w Storage Overhead Cabinet with Cubbies 	1/2	106 1/8	0	14	4	VSB10820TKAC	COM \$574
							A \$607
<ul style="list-style-type: none"> · tackboard panels for above and below accessory rail · not required; add-on for convenience application · com ydg: 3 · upper tackboard height: 2 1/4" · lower tackboard height: 11 1/2" · coordinates with VST16108DSOC, VST16108SOC, VST16108SDC, VST16108SDC and VST16108SMOC · accessory rail sold separately, see page VS226 							B \$675
							C \$792
							D \$942
							E \$1,096
							F \$1,330
							G \$1,582
							H \$1,852
							I \$2,271
							J \$2,775
	Tackboard for Accessory Rail of 102" w Storage Overhead Cabinet with Cubbies 	1/2	100 1/8	0	13	4	VSB10220TKAC
A \$595							
<ul style="list-style-type: none"> · tackboard panels for above and below accessory rail · not required; add-on for convenience application · com ydg: 3 · upper tackboard height: 2 1/4" · lower tackboard height: 11 1/2" · coordinates with VST16102DSOC, VST16102SOC, VST16102SDC, VST16102SDC and VST16102SMOC · accessory rail sold separately, see page VS226 							B \$663
							C \$781
							D \$931
							E \$1,083
							F \$1,319
							G \$1,571
							H \$1,839
							I \$2,259
							J \$2,763
	Tackboard for Accessory Rail of 96" w Storage Overhead Cabinet with Cubbies 	1/2	94 1/8	0	12	4	VSB9620TKAC
A \$557							
<ul style="list-style-type: none"> · tackboard panels for above and below accessory rail · not required; add-on for convenience application · com ydg: 3 · upper tackboard height: 2 1/4" · lower tackboard height: 11 1/2" · coordinates with VST1696DSOC, VST1696SOC, VST1696SDC, VST1696SDC and VST1696SMOC · accessory rail sold separately, see page VS226 							B \$620
							C \$728
							D \$868
							E \$1,008
							F \$1,225
							G \$1,457
							H \$1,706
							I \$2,094
							J \$2,560
	Tackboard for Accessory Rail of 90" w Storage Overhead Cabinet with Cubbies 	1/2	88 1/8	0	12	3	VSB9020TKAC
A \$552							
<ul style="list-style-type: none"> · tackboard panels for above and below accessory rail · not required; add-on for convenience application · com ydg: 3 · upper tackboard height: 2 1/4" · lower tackboard height: 11 1/2" · coordinates with VST1690DSOC, VST1690SOC, VST1690SDC, VST1690SDC and VST1690SMOC · accessory rail sold separately, see page VS226 							B \$614
							C \$723
							D \$863
							E \$1,002
							F \$1,219
							G \$1,451
							H \$1,700
							I \$2,088
							J \$2,554

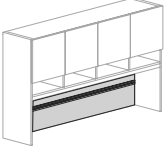
Description	D	W	H	CTN WT	CU FT	① Model	List Price Per Grade
Tackboard for Accessory Rail of 84" w Storage Overhead Cabinet with Cubbies 	1/2	82 1/8	0	11	3	VSB8420TKAC	COM \$471
	<ul style="list-style-type: none"> tackboard panels for above and below accessory rail not required; add-on for convenience application com ydg: 3 upper tackboard height: 2 1/4" lower tackboard height: 11 1/2" coordinates with VST1684DSOC, VST1684SOC, VST1684DSDC, VST1684SDC and VST1684SMOC accessory rail sold separately, see page VS226 						
							A \$501
							B \$557
							C \$656
							D \$786
							E \$913
							F \$1,112
							G \$1,325
							H \$1,553
							I \$1,908
							J \$2,335

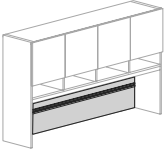
Tackboard for Accessory Rail of 78" w Storage Overhead Cabinet with Cubbies 	1/2	76 1/8	0	10	3	VSB7820TKAC	COM \$447
	<ul style="list-style-type: none"> tackboard panels for above and below accessory rail not required; add-on for convenience application com ydg: 3 upper tackboard height: 2 1/4" lower tackboard height: 11 1/2" coordinates with VST1678DSOC, VST1678SOC, VST1678DSDC, VST1678SDC and VST1678SMOC accessory rail sold separately, see page VS226 						
							A \$475
							B \$526
							C \$617
							D \$732
							E \$849
							F \$1,031
							G \$1,224
							H \$1,431
							I \$1,754
							J \$2,142

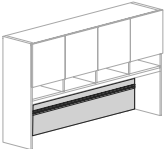
Tackboard for Accessory Rail of 72" w Storage Overhead Cabinet with Cubbies 	1/2	70 1/8	0	10	3	VSB7220TKAC	COM \$420
	<ul style="list-style-type: none"> tackboard panels for above and below accessory rail not required; add-on for convenience application com ydg: 2 upper tackboard height: 2 1/4" lower tackboard height: 11 1/2" coordinates with VST1672DSOC, VST1672SOC, VST1672DSDC, VST1672SDC, and VST1672SMOC accessory rail sold separately, see page VS226 						
							A \$443
							B \$489
							C \$570
							D \$676
							E \$781
							F \$942
							G \$1,118
							H \$1,303
							I \$1,595
							J \$1,944

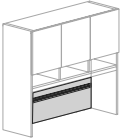
To Order, Specify:

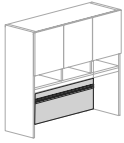
- ① Model Number
- ② Fabric Selection: vendor, pattern, color
 Visit www.jsifurniture.com/finishes-and-materials/textiles for our textiles program. See selection of standard and graded in manufacturers and patterns.

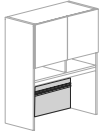
Description	D	W	H	CTN WT	CU FT	① Model	List Price Per Grade
Tackboard for Accessory Rail of 66" w Storage Overhead Cabinet with Cubbies  <ul style="list-style-type: none"> · tackboard panels for above and below accessory rail · not required; add-on for convenience application · com ydg: 2 · upper tackboard height: 2 1/4" · lower tackboard height: 11 1/2" · coordinates with VST1666DSOC, VST1666SOC, VST1666SDC, VST1666SDC and VST1666SMOC · accessory rail sold separately, see page VS226 	1/2	64 1/8	0	9	3	VSB6620TKAC	COM \$396
	A \$417						
	B \$458						
	C \$530						
	D \$625						
	E \$717						
	F \$863						
	G \$1,016						
	H \$1,183						
	I \$1,442						
	J \$1,750						

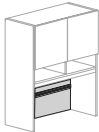
Tackboard for Accessory Rail of 60" w Storage Overhead Cabinet with Cubbies  <ul style="list-style-type: none"> · tackboard panels for above and below accessory rail · not required; add-on for convenience application · com ydg: 2 · upper tackboard height: 2 1/4" · lower tackboard height: 11 1/2" · coordinates with VST1660DSOC, VST1660SOC, VST1660SDC, VST1660SDC and VST1660SMOC · accessory rail sold separately, see page VS226 	1/2	58 1/8	0	8	2	VSB6020TKAC	COM \$383
	A \$404						
	B \$445						
	C \$519						
	D \$612						
	E \$704						
	F \$849						
	G \$1,004						
	H \$1,170						
	I \$1,429						
	J \$1,740						

Tackboard for Accessory Rail of 54" w Storage Overhead Cabinet with Cubbies  <ul style="list-style-type: none"> · tackboard panels for above and below accessory rail · not required; add-on for convenience application · com ydg: 2 · upper tackboard height: 2 1/4" · lower tackboard height: 11 1/2" · coordinates with VST1654DSOC, VST1654SOC, VST1654SDC, VST1654SDC and VST1654SMOC · accessory rail sold separately, see page VS226 	1/2	52 1/8	0	7	2	VSB5420TKAC	COM \$359
	A \$379						
	B \$415						
	C \$478						
	D \$559						
	E \$640						
	F \$767						
	G \$904						
	H \$1,048						
	I \$1,275						
	J \$1,546						

Tackboard for Accessory Rail of 48" w Storage Overhead Cabinet with Cubbies  <ul style="list-style-type: none"> · tackboard panels for above and below accessory rail · not required; add-on for convenience application · com ydg: 2 · upper tackboard height: 2 1/4" · lower tackboard height: 11 1/2" · coordinates with VST1648DSOC, VST1648SOC, VST1648SDC and VST1648SDC · accessory rail sold separately, see page VS226 	1/2	46 1/8	0	7	2	VSB4820TKAC	COM \$328
	A \$347						
	B \$383						
	C \$445						
	D \$527						
	E \$610						
	F \$736						
	G \$872						
	H \$1,016						
	I \$1,242						
	J \$1,513						

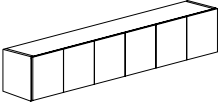
Description	D	W	H	CTN WT	CU FT	① Model	List Price Per Grade	
Tackboard for Accessory Rail of 42" w Storage Overhead Cabinet with Cubbies 	1/2	40 1/8	0	6	2	VSB4220TKAC	COM \$304	
	<ul style="list-style-type: none"> · tackboard panels for above and below accessory rail · not required; add-on for convenience application · com ydg: 2 · upper tackboard height: 2 1/4" · lower tackboard height: 11 1/2" · coordinates with VST1642DSOC, VST1642SDC and VST1642SDC · accessory rail sold separately, see page VS226 							A \$318
								B \$351
								C \$404
								D \$475
								E \$544
								F \$652
								G \$768
								H \$892
								I \$1,087
							J \$1,320	

Tackboard for Accessory Rail of 36" w Storage Overhead Cabinet with Cubbies 	1/2	34 1/8	0	5	2	VSB3620TKAC	COM \$279	
	<ul style="list-style-type: none"> · tackboard panels for above and below accessory rail · not required; add-on for convenience application · com ydg: 1 · upper tackboard height: 2 1/4" · lower tackboard height: 11 1/2" · coordinates with VST1636DSOC, VST1636SDC and VST1636SDC · accessory rail sold separately, see page VS226 							A \$293
								B \$318
								C \$363
								D \$422
								E \$480
								F \$570
								G \$668
								H \$771
								I \$933
							J \$1,126	

Tackboard for Accessory Rail of 30" w Storage Overhead Cabinet with Cubbies 	1/2	28 1/8	0	5	1	VSB3020TKAC	COM \$269	
	<ul style="list-style-type: none"> · tackboard panels for above and below accessory rail · not required; add-on for convenience application · com ydg: 1 · upper tackboard height: 2 1/4" · lower tackboard height: 11 1/2" · coordinates with VST1630DSOC, VST1630SDC and VST1630SDC · accessory rail sold separately, see page VS226 							A \$282
								B \$308
								C \$353
								D \$413
								E \$469
								F \$561
								G \$656
								H \$761
								I \$922
							J \$1,115	

To Order, Specify:

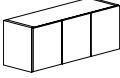
- ① Model Number
- ② Fabric Selection: vendor, pattern, color
 Visit www.jsifurniture.com/finishes-and-materials/textiles for our textiles program. See selection of standard and graded in manufacturers and patterns.

Description	D	W	H	CTN WT	CU FT	① Model	Laminate		Flat Cut Veneer			Double Cut Veneer		
							Laminate Door	Alum. Frm Glass Door	Veneer Door	Alum. Frm Glass Door	Wood Frm Glass Door	Veneer Door	Alum. Frm Glass Door	Wood Frm Glass Door
Wall Mount Overhead Cabinet with Six Doors 	16 ³ / ₁₆	108	17 ¹ / ₂	281	23	VST16108WSO	\$2,150	\$3,582						
	16 ³ / ₁₆	108	17 ¹ / ₂	281	23	VSV16108WSO			\$3,867	\$5,299	\$4,369	\$4,254	\$5,686	\$4,756
	16 ³ / ₁₆	102	17 ¹ / ₂	266	22	VST16102WSO	\$2,030	\$3,423						
	16 ³ / ₁₆	102	17 ¹ / ₂	266	22	VSV16102WSO			\$3,552	\$4,945	\$4,054	\$3,906	\$5,299	\$4,408
	16 ³ / ₁₆	96	17 ¹ / ₂	250	21	VST1696WSO	\$1,915	\$3,273						
	16 ³ / ₁₆	96	17 ¹ / ₂	250	21	VSV1696WSO			\$3,245	\$4,603	\$3,747	\$3,567	\$4,926	\$4,070
	16 ³ / ₁₆	90	17 ¹ / ₂	235	20	VST1690WSO	\$1,807	\$3,127						
	16 ³ / ₁₆	90	17 ¹ / ₂	235	20	VSV1690WSO			\$3,093	\$4,413	\$3,595	\$3,399	\$4,720	\$3,902


- select door style
- aluminum frame door offered in both frosted or white back painted glass, specify when ordering
- white markerboard doors available, specify and add \$635 list to laminate or veneer door price
- locking available on laminate or wood doors, specify and add \$115 list; glass doors are non-locking
- supported by wall cleat - hardware provided by installer
- no pulls

Description	D	W	H	CTN WT	CU FT	① Model	Laminate		Flat Cut Veneer			Double Cut Veneer		
							Laminate Door	Alum. Frm Glass Door	Veneer Door	Alum. Frm Glass Door	Wood Frm Glass Door	Veneer Door	Alum. Frm Glass Door	Wood Frm Glass Door
Wall Mount Overhead Cabinet with Four Doors 	16 ³ / ₁₆	84	17 ¹ / ₂	219	18	VST1684WSO	\$1,701	\$2,731						
	16 ³ / ₁₆	84	17 ¹ / ₂	219	18	VSV1684WSO			\$2,946	\$3,976	\$3,387	\$3,243	\$4,273	\$3,683
	16 ³ / ₁₆	78	17 ¹ / ₂	203	17	VST1678WSO	\$1,605	\$2,599						
	16 ³ / ₁₆	78	17 ¹ / ₂	203	17	VSV1678WSO			\$2,785	\$3,780	\$3,226	\$3,064	\$4,058	\$3,505
	16 ³ / ₁₆	72	17 ¹ / ₂	187	16	VST1672WSO	\$1,553	\$2,508						
	16 ³ / ₁₆	72	17 ¹ / ₂	187	16	VSV1672WSO			\$2,628	\$3,582	\$3,068	\$2,890	\$3,844	\$3,331
	16 ³ / ₁₆	66	17 ¹ / ₂	174	15	VST1666WSO	\$1,437	\$2,354						
	16 ³ / ₁₆	66	17 ¹ / ₂	174	15	VSV1666WSO			\$2,513	\$3,430	\$2,954	\$2,763	\$3,680	\$3,204
	16 ³ / ₁₆	60	17 ¹ / ₂	163	13	VST1660WSO	\$1,318	\$2,198						
	16 ³ / ₁₆	60	17 ¹ / ₂	163	13	VSV1660WSO			\$2,304	\$3,184	\$2,744	\$2,534	\$3,415	\$2,975
	16 ³ / ₁₆	54	17 ¹ / ₂	160	12	VST1654WSO	\$1,246	\$2,088						
16 ³ / ₁₆	54	17 ¹ / ₂	160	12	VSV1654WSO			\$2,177	\$3,019	\$2,617	\$2,393	\$3,235	\$2,834	

- select door style
- aluminum frame door offered in both frosted or white back painted glass, specify when ordering
- white markerboard doors available, specify and add \$557 list to laminate or veneer door price
- locking available on laminate or wood doors, specify and add \$79 list; glass doors are non-locking
- supported by wall cleat - hardware provided by installer
- no pulls

Description	D	W	H	CTN WT	CU FT	① Model	Laminate		Flat Cut Veneer			Double Cut Veneer		
							Laminate Door	Alum. Frm Glass Door	Veneer Door	Alum. Frm Glass Door	Wood Glass Door	Veneer Door	Alum. Frm Glass Door	Wood Frm Glass Door
Wall Mount Overhead Cabinet with Three Doors 	16 3/16	48	17 1/2	154	11	VST1648WSOR	\$1,142	\$1,822						
	16 3/16	48	17 1/2	154	11	VSV1648WSOR			\$1,885	\$2,565	\$2,195	\$2,076	\$2,756	\$2,386
	16 3/16	48	17 1/2	154	11	VST1648WSOL	\$1,142	\$1,822						
	16 3/16	48	17 1/2	154	11	VSV1648WSOL			\$1,885	\$2,565	\$2,195	\$2,076	\$2,756	\$2,386
	16 3/16	42	17 1/2	142	10	VST1642WSOR	\$1,082	\$1,724						
	16 3/16	42	17 1/2	142	10	VSV1642WSOR			\$1,765	\$2,406	\$2,074	\$1,940	\$2,581	\$2,249
	16 3/16	42	17 1/2	142	10	VST1642WSOL	\$1,082	\$1,724						
	16 3/16	42	17 1/2	142	10	VSV1642WSOL			\$1,765	\$2,406	\$2,074	\$1,940	\$2,581	\$2,249

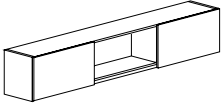
- select door style
- aluminum frame door offered in both frosted or white back painted glass, specify when ordering
- white markerboard doors available, specify and add \$392 list to laminate or veneer door price
- locking available on laminate or wood doors, specify and add \$74 list to laminate or veneer door price
- supported by wall cleat - hardware provided by installer
- right door configuration - 1 door hinges left and 2 doors hinge right
- left door configuration - 1 door hinges right and 2 doors hinge left
- no pulls

Description	D	W	H	CTN WT	CU FT	① Model	Laminate		Flat Cut Veneer			Double Cut Veneer		
							Laminate Door	Alum. Frm Glass Door	Veneer Door	Alum. Frm Glass Door	Wood Frm Glass Door	Veneer Door	Alum. Frm Glass Door	Wood Frm Glass Door
Wall Mount Overhead Cabinet with Two Doors 	16 3/16	36	17 1/2	133	8	VST1636WSO	\$937	\$1,416						
	16 3/16	36	17 1/2	133	8	VSV1636WSO			\$1,638	\$2,117	\$1,823	\$1,806	\$2,284	\$1,990
	16 3/16	30	17 1/2	128	7	VST1630WSO	\$889	\$1,331						
	16 3/16	30	17 1/2	128	7	VSV1630WSO			\$1,549	\$1,991	\$1,734	\$1,705	\$2,147	\$1,890

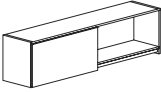
- select door style
- aluminum frame door offered in both frosted or white back painted glass, specify when ordering
- white markerboard doors available, specify and add \$233 list to laminate or veneer door price
- locking available on laminate or wood doors, specify and add \$47 list to laminate or veneer door price
- supported by wall cleat - hardware provided by installer
- no pulls

To Order, Specify:

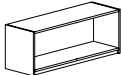
① Model Number	Laminate - VST	Veneer - VSV
	<ul style="list-style-type: none"> ② Worksurface Material (see page VI3) <ul style="list-style-type: none"> a.) TFL b.) HPL ③ Laminate Color (see page VI3) <ul style="list-style-type: none"> a.) Worksurface Color b.) Chassis Color c.) Drawer Color 	<ul style="list-style-type: none"> ② Wood Species - Cherry (CH1), Maple (MA1) Walnut (WA1), Black Oak (BO1) or Double Cut (DC1) (see page VI1) ③ Finish Color (see page VI1)
		<ul style="list-style-type: none"> ④ Edge Profile (see page VI4) ⑤ Pull Style and Color (see page VI5) ⑥ Optional Grommet Location & Color - Matte Black (MBK) or Arctic Silver (ASL) (see page VI6) ⑦ Other Product Options (see page VI10) ⑧ Accessories (see page VS314) ⑨ Power and Data Options (see page VS324)

Description	D	W	H	CTN WT	CU FT	① Model	Laminate	Flat Cut Veneer	Double Cut Veneer
Wall Mount Overhead Cabinet with Two Sliding Doors 	16 3/16	108	17 1/2	281	23	VST16108WSD	\$2,538		
	16 3/16	108	17 1/2	281	23	VSV16108WSD		\$4,334	\$4,769
	16 3/16	102	17 1/2	266	22	VST16102WSD	\$2,405		
	16 3/16	102	17 1/2	266	22	VSV16102WSD		\$4,096	\$4,504
	16 3/16	96	17 1/2	250	21	VST1696WSD	\$2,277		
	16 3/16	96	17 1/2	250	21	VSV1696WSD		\$3,852	\$4,239
	16 3/16	90	17 1/2	235	20	VST1690WSD	\$2,157		
	16 3/16	90	17 1/2	235	20	VSV1690WSD		\$3,615	\$3,975

- white markerboard doors available, specify and add \$428 list to laminate or veneer door price
- locking not available
- supported by wall cleat - hardware provided by installer
- pulls not available

Description	D	W	H	CTN WT	CU FT	① Model	Laminate	Flat Cut Veneer	Double Cut Veneer
Wall Mount Overhead Cabinet with Sliding Door 	16 3/16	84	17 1/2	219	18	VST1684WSD	\$2,044		
	16 3/16	84	17 1/2	219	18	VSV1684WSD		\$3,371	\$3,708
	16 3/16	78	17 1/2	203	17	VST1678WSD	\$2,001		
	16 3/16	78	17 1/2	203	17	VSV1678WSD		\$3,132	\$3,446
	16 3/16	72	17 1/2	187	16	VST1672WSD	\$1,896		
	16 3/16	72	17 1/2	187	16	VSV1672WSD		\$2,944	\$3,236
	16 3/16	66	17 1/2	174	15	VST1666WSD	\$1,804		
	16 3/16	66	17 1/2	174	15	VSV1666WSD		\$2,818	\$3,099
	16 3/16	60	17 1/2	163	13	VST1660WSD	\$1,713		
	16 3/16	60	17 1/2	163	13	VSV1660WSD		\$2,681	\$2,950
	16 3/16	54	17 1/2	160	12	VST1654WSD	\$1,613		
	16 3/16	54	17 1/2	160	12	VSV1654WSD		\$2,504	\$2,755
	16 3/16	48	17 1/2	154	11	VST1648WSD	\$1,383		
	16 3/16	48	17 1/2	154	11	VSV1648WSD		\$2,302	\$2,529
	16 3/16	42	17 1/2	142	10	VST1642WSD	\$1,322		
	16 3/16	42	17 1/2	142	10	VSV1642WSD		\$2,170	\$2,388
16 3/16	36	17 1/2	133	8	VST1636WSD	\$1,155			
16 3/16	36	17 1/2	133	8	VSV1636WSD		\$2,055	\$2,262	
16 3/16	30	17 1/2	128	7	VST1630WSD	\$1,136			
16 3/16	30	17 1/2	128	7	VSV1630WSD		\$1,914	\$2,105	

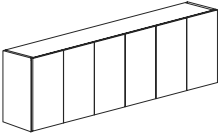
- white markerboard doors available, specify and add \$215 list to laminate or veneer door price
- locking not available
- supported by wall cleat - hardware provided by installer
- pulls not available

Description	D	W	H	CTN WT	CU FT	① Model	Laminate	Flat Cut Veneer	Double Cut Veneer
Wall Mount Open Overhead 	15 7/16	54	17 1/2	73	12	VST1554W00	\$984		
	15 7/16	54	17 1/2	73	12	VSV1554W00		\$1,556	\$1,711
	15 7/16	48	17 1/2	68	10	VST1548W00	\$893		
	15 7/16	48	17 1/2	68	10	VSV1548W00		\$1,418	\$1,560
	15 7/16	42	17 1/2	61	9	VST1542W00	\$816		
	15 7/16	42	17 1/2	61	9	VSV1542W00		\$1,291	\$1,419
	15 7/16	36	17 1/2	53	8	VST1536W00	\$743		
	15 7/16	36	17 1/2	53	8	VSV1536W00		\$1,176	\$1,295
	15 7/16	30	17 1/2	46	7	VST1530W00	\$673		
	15 7/16	30	17 1/2	46	7	VSV1530W00		\$1,065	\$1,173

• supported by wall cleat - hardware provided by installer

To Order, Specify:

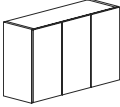
① Model Number	Laminate - VST	Veneer - VSV	
	② Worksurface Material (see page VI3) a.) TFL b.) HPL ③ Laminate Color (see page VI3) a.) Worksurface Color b.) Chassis Color c.) Drawer Color	② Wood Species - Cherry (CH1), Maple (MA1) Walnut (WA1), Black Oak (BO1) or Double Cut (DC1) (see page VI1) ③ Finish Color (see page VI1)	④ Edge Profile (see page VI4) ⑤ Pull Style and Color (see page VI5) ⑥ Optional Grommet Location & Color - Matte Black (MBK) or Arctic Silver (ASL) (see page VI6) ⑦ Other Product Options (see page VI10) ⑧ Accessories (see page VS314) ⑨ Power and Data Options (see page VS324)

Description	D	W	H	CTN WT	CU FT	① Model	Laminate		Flat Cut Veneer			Double Cut Veneer			
							Laminate Door	Alum. Frm Glass Door	Veneer Door	Alum. Frm Glass Door	Wood Frm Glass Door	Veneer Door	Alum. Frm Glass Door	Wood Frm Glass Door	
Double Height Wall Mount Overhead Cabinet with Six Doors 	16 3/16	108	29 1/2	366	37	VST16108WDSO	\$2,698	\$4,587							
	16 3/16	108	29 1/2	366	37	VSV16108WDSO			\$5,119	\$7,008	\$5,941	\$5,633	\$7,522	\$6,455	
	16 3/16	102	29 1/2	346	35	VST16102WDSO	\$2,561	\$4,398							
	16 3/16	102	29 1/2	346	35	VSV16102WDSO			\$4,837	\$6,674	\$5,660	\$5,322	\$7,159	\$6,144	
	16 3/16	96	29 1/2	325	33	VST1696WDSO	\$2,421	\$4,204							
	16 3/16	96	29 1/2	325	33	VSV1696WDSO			\$4,551	\$6,335	\$5,374	\$5,008	\$6,791	\$5,830	
	16 3/16	90	29 1/2	306	31	VST1690WDSO	\$2,291	\$4,024							
	16 3/16	90	29 1/2	306	31	VSV1690WDSO			\$4,270	\$6,002	\$5,092	\$4,697	\$6,429	\$5,519	


- select door style
- aluminum frame door offered in both frosted or white back painted glass, specify when ordering
- white markerboard doors available, specify and add \$1,040 list to laminate or veneer door price
- locking available on laminate or wood doors, specify and add \$115 list; glass doors are non-locking
- supported by wall cleat - hardware provided by installer
- no pulls

Description	D	W	H	CTN WT	CU FT	① Model	Laminate		Flat Cut Veneer			Double Cut Veneer			
							Laminate Door	Alum. Frm Glass Door	Veneer Door	Alum. Frm Glass Door	Wood Frm Glass Door	Veneer Door	Alum. Frm Glass Door	Wood Frm Glass Door	
Double Height Wall Mount Overhead Cabinet with Four Doors 	16 3/16	84	29 1/2	285	29	VST1684WDSO	\$2,170	\$3,534							
	16 3/16	84	29 1/2	285	29	VSV1684WDSO			\$3,984	\$5,347	\$4,624	\$4,382	\$5,746	\$5,023	
	16 3/16	78	29 1/2	264	27	VST1678WDSO	\$2,122	\$3,435							
	16 3/16	78	29 1/2	264	27	VSV1678WDSO			\$3,700	\$5,013	\$4,340	\$4,070	\$5,383	\$4,710	
	16 3/16	72	29 1/2	244	25	VST1672WDSO	\$2,008	\$3,267							
	16 3/16	72	29 1/2	244	25	VSV1672WDSO			\$3,417	\$4,676	\$4,057	\$3,757	\$5,016	\$4,398	
	16 3/16	66	29 1/2	227	23	VST1666WDSO	\$1,904	\$3,113							
	16 3/16	66	29 1/2	227	23	VSV1666WDSO			\$3,268	\$4,478	\$3,909	\$3,594	\$4,804	\$4,235	
	16 3/16	60	29 1/2	212	21	VST1660WDSO	\$1,815	\$2,971							
	16 3/16	60	29 1/2	212	21	VSV1660WDSO			\$3,108	\$4,264	\$3,749	\$3,419	\$4,575	\$4,059	
	16 3/16	54	29 1/2	208	19	VST1654WDSO	\$1,706	\$2,810							
	16 3/16	54	29 1/2	208	19	VSV1654WDSO			\$2,803	\$3,907	\$3,443	\$3,083	\$4,187	\$3,723	

- select door style
- aluminum frame door offered in both frosted or white back painted glass, specify when ordering
- white markerboard doors available, specify and add \$811 list to laminate or veneer door price
- locking available on laminate or wood doors, specify and add \$79 list; glass doors are non-locking
- supported by wall cleat - hardware provided by installer
- no pulls

Description	D	W	H	CTN WT	CU FT	① Model	Laminate		Flat Cut Veneer			Double Cut Veneer		
							Laminate Door	Alum. Frm Glass Door	Veneer Door	Alum. Frm Glass Door	Wood Glass Door	Veneer Door	Alum. Frm Glass Door	Wood Frm Glass Door
Double Height Wall Mount Overhead Cabinet with Three Doors 	16 3/16	48	29 1/2	201	17	VST1648WDSOR	\$1,463	\$2,355						
	16 3/16	48	29 1/2	201	17	VSV1648WDSOR			\$2,453	\$3,345	\$2,878	\$2,698	\$3,590	\$3,123
	16 3/16	48	29 1/2	201	17	VST1648WDSOL	\$1,463	\$2,355						
	16 3/16	48	29 1/2	201	17	VSV1648WDSOL			\$2,453	\$3,345	\$2,878	\$2,698	\$3,590	\$3,123
	16 3/16	42	29 1/2	185	15	VST1642WDSOR	\$1,389	\$2,231						
	16 3/16	42	29 1/2	185	15	VSV1642WDSOR			\$2,253	\$3,095	\$2,678	\$2,479	\$3,320	\$2,903
	16 3/16	42	29 1/2	185	15	VST1642WDSOL	\$1,389	\$2,231						
	16 3/16	42	29 1/2	185	15	VSV1642WDSOL			\$2,253	\$3,095	\$2,678	\$2,479	\$3,320	\$2,903

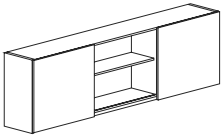
- select door style
- aluminum frame door offered in both frosted or white back painted glass, specify when ordering
- white markerboard doors available, specify and add \$537 list to laminate or veneer door price
- locking available on laminate or wood doors, specify and add \$74 list; glass doors are non-locking
- supported by wall cleat - hardware provided by installer
- right door configuration - 1 door hinges left and 2 doors hinge right
- left door configuration - 1 door hinges right and 2 doors hinge left
- no pulls

Description	D	W	H	CTN WT	CU FT	① Model	Laminate		Flat Cut Veneer			Double Cut Veneer		
							Laminate Door	Alum. Frm Glass Door	Veneer Door	Alum. Frm Glass Door	Wood Frm Glass Door	Veneer Door	Alum. Frm Glass Door	Wood Frm Glass Door
Double Height Wall Mount Overhead Cabinet with Two Doors 	16 3/16	36	29 1/2	173	13	VST1636WDSO	\$1,209	\$1,839						
	16 3/16	36	29 1/2	173	13	VSV1636WDSO			\$2,112	\$2,742	\$2,403	\$2,323	\$2,954	\$2,614
	16 3/16	30	29 1/2	167	11	VST1630WDSO	\$1,152	\$1,730						
	16 3/16	30	29 1/2	167	11	VSV1630WDSO			\$2,011	\$2,589	\$2,302	\$2,213	\$2,792	\$2,505

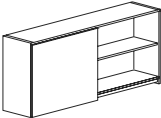
- select door style
- aluminum frame door offered in both frosted or white back painted glass, specify when ordering
- white markerboard doors available, specify and add \$368 list to laminate or veneer door price
- locking available on laminate or wood doors, specify and add \$47 list; glass doors are non-locking
- supported by wall cleat - hardware provided by installer
- no pulls

To Order, Specify:

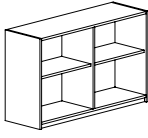
① Model Number	Laminate - VST	Veneer - VSV
	<ul style="list-style-type: none"> ② Worksurface Material (see page VI3) <ul style="list-style-type: none"> a.) TFL b.) HPL ③ Laminate Color (see page VI3) <ul style="list-style-type: none"> a.) Worksurface Color b.) Chassis Color c.) Drawer Color 	<ul style="list-style-type: none"> ② Wood Species - Cherry (CH1), Maple (MA1) Walnut (WA1), Black Oak (BO1) or Double Cut (DC1) (see page VI1) ③ Finish Color (see page VI1)
		<ul style="list-style-type: none"> ④ Edge Profile (see page VI4) ⑤ Pull Style and Color (see page VI5) ⑥ Optional Grommet Location & Color - Matte Black (MBK) or Arctic Silver (ASL) (see page VI6) ⑦ Other Product Options (see page VI10) ⑧ Accessories (see page VS314) ⑨ Power and Data Options (see page VS324)

Description	D	W	H	CTN WT	CU FT	① Model	Laminate	Flat Cut Veneer	Double Cut Veneer
Double Height Wall Mount Overhead Cabinet with Two Sliding Doors 	16 ³ / ₁₆	108	29 1/2	366	37	VST16108WDS	\$3,081		
	16 ³ / ₁₆	108	29 1/2	366	37	VSV16108WDS		\$5,632	\$6,194
	16 ³ / ₁₆	102	29 1/2	346	35	VST16102WDS	\$2,929		
	16 ³ / ₁₆	102	29 1/2	346	35	VSV16102WDS		\$5,322	\$5,855
	16 ³ / ₁₆	96	29 1/2	325	33	VST1696WDS	\$2,848		
	16 ³ / ₁₆	96	29 1/2	325	33	VSV1696WDS		\$5,007	\$5,508
	16 ³ / ₁₆	90	29 1/2	306	31	VST1690WDS	\$2,710		
	16 ³ / ₁₆	90	29 1/2	306	31	VSV1690WDS		\$4,697	\$5,169

- white markerboard doors available, specify and add \$565 list to laminate or veneer door price
- locking not available
- supported by wall cleat - hardware provided by installer

Double Height Wall Mount Overhead Cabinet with Sliding Door 	16 ³ / ₁₆	84	29 1/2	285	29	VST1684WDS	\$2,576		
	16 ³ / ₁₆	84	29 1/2	285	29	VSV1684WDS		\$4,382	\$4,821
	16 ³ / ₁₆	78	29 1/2	264	27	VST1678WDS	\$2,450		
	16 ³ / ₁₆	78	29 1/2	264	27	VSV1678WDS		\$4,069	\$4,476
	16 ³ / ₁₆	72	29 1/2	244	25	VST1672WDS	\$2,332		
	16 ³ / ₁₆	72	29 1/2	244	25	VSV1672WDS		\$3,826	\$4,207
	16 ³ / ₁₆	66	29 1/2	227	23	VST1666WDS	\$2,218		
	16 ³ / ₁₆	66	29 1/2	227	23	VSV1666WDS		\$3,702	\$4,071
	16 ³ / ₁₆	60	29 1/2	212	21	VST1660WDS	\$2,126		
	16 ³ / ₁₆	60	29 1/2	212	21	VSV1660WDS		\$3,560	\$3,917
	16 ³ / ₁₆	54	29 1/2	208	19	VST1654WDS	\$2,032		
	16 ³ / ₁₆	54	29 1/2	208	19	VSV1654WDS		\$3,421	\$3,761
	16 ³ / ₁₆	48	29 1/2	201	17	VST1648WDS	\$1,793		
	16 ³ / ₁₆	48	29 1/2	201	17	VSV1648WDS		\$3,063	\$3,370
	16 ³ / ₁₆	42	29 1/2	185	15	VST1642WDS	\$1,718		
	16 ³ / ₁₆	42	29 1/2	185	15	VSV1642WDS		\$2,935	\$3,230
	16 ³ / ₁₆	36	29 1/2	173	13	VST1636WDS	\$1,647		
	16 ³ / ₁₆	36	29 1/2	173	13	VSV1636WDS		\$2,716	\$2,988
16 ³ / ₁₆	30	29 1/2	167	11	VST1630WDS	\$1,629			
16 ³ / ₁₆	30	29 1/2	167	11	VSV1630WDS		\$2,684	\$2,952	

- white markerboard door available, specify and add \$284 list to laminate or veneer door price
- locking not available
- supported by wall cleat - hardware provided by installer

Description	D	W	H	CTN WT	CU FT	① Model	Laminate	Flat Cut Veneer	Double Cut Veneer
Double Height Wall Mount Open Overhead 	15 7/16	54	29 1/2	95	19	VST1554DW00	\$1,082		
	15 7/16	54	29 1/2	95	19	VSV1554DW00		\$1,881	\$2,069
	15 7/16	48	29 1/2	89	17	VST1548DW00	\$984		
	15 7/16	48	29 1/2	89	17	VSV1548DW00		\$1,715	\$1,885
	15 7/16	42	29 1/2	80	15	VST1542DW00	\$894		
	15 7/16	42	29 1/2	80	15	VSV1542DW00		\$1,561	\$1,717

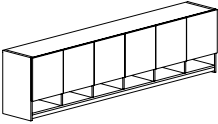
· supported by wall cleat - hardware provided by installer

Double Height Wall Mount Open Overhead 	15 7/16	36	29 1/2	69	13	VST1536DW00	\$817		
	15 7/16	36	29 1/2	69	13	VSV1536DW00		\$1,423	\$1,565
	15 7/16	30	29 1/2	60	11	VST1530DW00	\$740		
	15 7/16	30	29 1/2	60	11	VSV1530DW00		\$1,290	\$1,418

· supported by wall cleat - hardware provided by installer

To Order, Specify:

① Model Number	Laminate - VST	Veneer - VSV	
	② Worksurface Material (see page VI3) a.) TFL b.) HPL ③ Laminate Color (see page VI3) a.) Worksurface Color b.) Chassis Color c.) Drawer Color	② Wood Species - Cherry (CH1), Maple (MA1) Walnut (WA1), Black Oak (BO1) or Double Cut (DC1) (see page VI1) ③ Finish Color (see page VI1)	④ Edge Profile (see page VI4) ⑤ Pull Style and Color (see page VI5) ⑥ Optional Grommet Location & Color - Matte Black (MBK) or Arctic Silver (ASL) (see page VI6) ⑦ Other Product Options (see page VI10) ⑧ Accessories (see page VS314) ⑨ Power and Data Options (see page VS324)

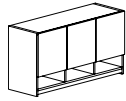
Description	D	W	H	CTN WT	CU FT	① Model	Laminate		Flat Cut Veneer			Double Cut Veneer			
							Laminate Door	Alum. Frm Glass Door	Veneer Door	Alum. Frm Glass Door	Wood Frm Glass Door	Veneer Door	Alum. Frm Glass Door	Wood Frm Glass Door	
Wall Mount Overhead Cabinet with Six Doors and Cubbies 	16 ³ / ₁₆	108	23 ¹ / ₂	326	30	VST16108WSOC	\$2,612	\$4,044							
	16 ³ / ₁₆	108	23 ¹ / ₂	326	30	VSV16108WSOC			\$4,989	\$6,421	\$5,491	\$5,490	\$6,922	\$5,993	
	16 ³ / ₁₆	102	23 ¹ / ₂	309	29	VST16102WSOC	\$2,474	\$3,867							
	16 ³ / ₁₆	102	23 ¹ / ₂	309	29	VSV16102WSOC			\$4,712	\$6,105	\$5,215	\$5,184	\$6,577	\$5,686	
	16 ³ / ₁₆	96	23 ¹ / ₂	290	27	VST1696WSOC	\$2,344	\$3,702							
	16 ³ / ₁₆	96	23 ¹ / ₂	290	27	VSV1696WSOC			\$4,436	\$5,794	\$4,938	\$4,882	\$6,240	\$5,384	
	16 ³ / ₁₆	90	23 ¹ / ₂	273	25	VST1690WSOC	\$2,219	\$3,539							
	16 ³ / ₁₆	90	23 ¹ / ₂	273	25	VSV1690WSOC			\$4,162	\$5,482	\$4,664	\$4,576	\$5,896	\$5,078	

- select door style
- aluminum frame door offered in both frosted or white back painted glass, specify when ordering
- white markerboard doors available, specify and add \$635 list to laminate or veneer door price
- locking available on laminate or wood doors, specify and add \$115 list; glass doors are non-locking
- supported by wall cleat - hardware provided by installer
- no pulls

Description	D	W	H	CTN WT	CU FT	① Model	Laminate		Flat Cut Veneer			Double Cut Veneer			
							Laminate Door	Alum. Frm Glass Door	Veneer Door	Alum. Frm Glass Door	Wood Frm Glass Door	Veneer Door	Alum. Frm Glass Door	Wood Frm Glass Door	
Wall Mount Overhead Cabinet with Four Doors and Cubbies 	16 ³ / ₁₆	84	23 ¹ / ₂	254	24	VST1684WSOC	\$2,103	\$3,133							
	16 ³ / ₁₆	84	23 ¹ / ₂	254	24	VSV1684WSOC			\$3,882	\$4,912	\$4,323	\$4,270	\$5,300	\$4,710	
	16 ³ / ₁₆	78	23 ¹ / ₂	236	22	VST1678WSOC	\$2,055	\$3,049							
	16 ³ / ₁₆	78	23 ¹ / ₂	236	22	VSV1678WSOC			\$3,606	\$4,601	\$4,047	\$3,965	\$4,959	\$4,406	
	16 ³ / ₁₆	72	23 ¹ / ₂	217	21	VST1672WSOC	\$1,946	\$2,900							
	16 ³ / ₁₆	72	23 ¹ / ₂	217	21	VSV1672WSOC			\$3,356	\$4,311	\$3,797	\$3,693	\$4,647	\$4,133	
	16 ³ / ₁₆	66	23 ¹ / ₂	202	19	VST1666WSOC	\$1,842	\$2,760							
	16 ³ / ₁₆	66	23 ¹ / ₂	202	19	VSV1666WSOC			\$3,174	\$4,091	\$3,615	\$3,492	\$4,409	\$3,932	
	16 ³ / ₁₆	60	23 ¹ / ₂	188	17	VST1660WSOC	\$1,757	\$2,638							
	16 ³ / ₁₆	60	23 ¹ / ₂	188	17	VSV1660WSOC			\$3,072	\$3,953	\$3,513	\$3,380	\$4,260	\$3,821	
	16 ³ / ₁₆	54	23 ¹ / ₂	183	16	VST1654WSOC	\$1,654	\$2,496							
	16 ³ / ₁₆	54	23 ¹ / ₂	183	16	VSV1654WSOC			\$2,930	\$3,772	\$3,371	\$3,223	\$4,066	\$3,664	

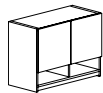
- select door style
- aluminum frame door offered in both frosted or white back painted glass, specify when ordering
- white markerboard doors available, specify and add \$557 list to laminate or veneer door price
- locking available on laminate or wood doors, specify and add \$79 list; glass doors are non-locking
- supported by wall cleat - hardware provided by installer
- no pulls

Description	D	W	H	CTN WT	CU FT	① Model	Laminate		Flat Cut Veneer			Double Cut Veneer		
							Laminate Door	Alum. Frm Glass Door	Veneer Door	Alum. Frm Glass Door	Wood Glass Door	Veneer Door	Alum. Frm Glass Door	Wood Frm Glass Door
Wall Mount Overhead Cabinet with Three Doors and Cubbies	16 3/16	48	23 1/2	174	14	VST1648WSOCR	\$1,415	\$2,095						
	16 3/16	48	23 1/2	174	14	VSV1648WSOCR			\$2,547	\$3,226	\$2,856	\$2,801	\$3,480	\$3,110
	16 3/16	48	23 1/2	174	14	VST1648WSOCL	\$1,415	\$2,095						
	16 3/16	48	23 1/2	174	14	VSV1648WSOCL			\$2,547	\$3,226	\$2,856	\$2,801	\$3,480	\$3,110
	16 3/16	42	23 1/2	160	12	VST1642WSOCR	\$1,345	\$1,987						
	16 3/16	42	23 1/2	160	12	VSV1642WSOCR			\$2,353	\$2,995	\$2,662	\$2,590	\$3,231	\$2,899
	16 3/16	42	23 1/2	160	12	VST1642WSOCL	\$1,345	\$1,987						
	16 3/16	42	23 1/2	160	12	VSV1642WSOCL			\$2,353	\$2,995	\$2,662	\$2,590	\$3,231	\$2,899



- select door style
- aluminum frame door offered in both frosted or white back painted glass, specify when ordering
- white markerboard doors available, specify and add \$392 list to laminate or veneer door price
- locking available on laminate or wood doors, specify and add \$74 list; glass doors are non-locking
- supported by wall cleat - hardware provided by installer
- right door configuration - 1 door hinges left and 2 doors hinge right
- left door configuration - 1 door hinges right and 2 doors hinge left
- no pulls

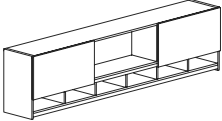
Description	D	W	H	CTN WT	CU FT	① Model	Laminate		Flat Cut Veneer			Double Cut Veneer		
							Laminate Door	Alum. Frm Glass Door	Veneer Door	Alum. Frm Glass Door	Wood Frm Glass Door	Veneer Door	Alum. Frm Glass Door	Wood Frm Glass Door
Wall Mount Overhead Cabinet with Two Doors and Cubbies	16 3/16	36	23 1/2	148	11	VST1636WSOC	\$1,173	\$1,652						
	16 3/16	36	23 1/2	148	11	VSV1636WSOC			\$2,050	\$2,529	\$2,235	\$2,255	\$2,734	\$2,440
	16 3/16	30	23 1/2	141	9	VST1630WSOC	\$1,115	\$1,556						
	16 3/16	30	23 1/2	141	9	VSV1630WSOC			\$1,941	\$2,383	\$2,125	\$2,134	\$2,575	\$2,318



- select door style
- aluminum frame door offered in both frosted or white back painted glass, specify when ordering
- white markerboard doors available, specify and add \$233 list to laminate or veneer door price
- locking available on laminate or wood doors, specify and add \$47 list; glass doors are non-locking
- supported by wall cleat - hardware provided by installer
- no pulls

To Order, Specify:

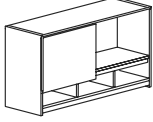
① Model Number	Laminate - VST	Veneer - VSV
	<ul style="list-style-type: none"> ② Worksurface Material (see page VI3) <ul style="list-style-type: none"> a.) TFL b.) HPL ③ Laminate Color (see page VI3) <ul style="list-style-type: none"> a.) Worksurface Color b.) Chassis Color c.) Drawer Color 	<ul style="list-style-type: none"> ② Wood Species - Cherry (CH1), Maple (MA1) Walnut (WA1), Black Oak (BO1) or Double Cut (DC1) (see page VI1) ③ Finish Color (see page VI1)
		<ul style="list-style-type: none"> ④ Edge Profile (see page VI4) ⑤ Pull Style and Color (see page VI5) ⑥ Optional Grommet Location & Color - Matte Black (MBK) or Arctic Silver (ASL) (see page VI6) ⑦ Other Product Options (see page VI10) ⑧ Accessories (see page VS314) ⑨ Power and Data Options (see page VS324)

Description	D	W	H	CTN WT	CU FT	① Model	Laminate	Flat Cut Veneer	Double Cut Veneer
Wall Mount Overhead Cabinet with Two Sliding Doors and Cubbies 	16 3/16	108	23 1/2	326	30	VST16108WSDC	\$2,993		
	16 3/16	108	23 1/2	326	30	VSV16108WSDC		\$5,383	\$5,921
	16 3/16	102	23 1/2	309	29	VST16102WSDC	\$2,849		
	16 3/16	102	23 1/2	309	29	VSV16102WSDC		\$5,086	\$5,593
	16 3/16	96	23 1/2	290	27	VST1696WSDC	\$2,710		
	16 3/16	96	23 1/2	290	27	VSV1696WSDC		\$4,785	\$5,264
	16 3/16	90	23 1/2	273	25	VST1690WSDC	\$2,577		
	16 3/16	90	23 1/2	273	25	VSV1690WSDC		\$4,489	\$4,937

- white markerboard doors available, specify and add \$428 list to laminate or veneer door price
- locking not available
- supported by wall cleat - hardware provided by installer
- pulls not available

Wall Mount Overhead Cabinet with Sliding Door and Cubbies 	16 3/16	84	23 1/2	254	24	VST1684WSDC	\$2,452		
	16 3/16	84	23 1/2	254	24	VSV1684WSDC		\$4,189	\$4,608
	16 3/16	78	23 1/2	236	22	VST1678WSDC	\$2,411		
	16 3/16	78	23 1/2	236	22	VSV1678WSDC		\$3,889	\$4,278
	16 3/16	72	23 1/2	217	21	VST1672WSDC	\$2,291		
	16 3/16	72	23 1/2	217	21	VSV1672WSDC		\$3,672	\$4,039
	16 3/16	66	23 1/2	202	19	VST1666WSDC	\$2,180		
	16 3/16	66	23 1/2	202	19	VSV1666WSDC		\$3,491	\$3,840
	16 3/16	60	23 1/2	188	17	VST1660WSDC	\$2,090		
	16 3/16	60	23 1/2	188	17	VSV1660WSDC		\$3,385	\$3,722
16 3/16	54	23 1/2	183	16	VST1654WSDC	\$1,978			
16 3/16	54	23 1/2	183	16	VSV1654WSDC		\$3,162	\$3,476	

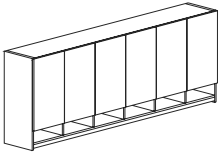
- white markerboard door available, specify and add \$215 list to laminate or veneer door price
- locking not available
- supported by wall cleat - hardware provided by installer
- pulls not available

Description	D	W	H	CTN WT	CU FT	① Model	Laminate	Flat Cut Veneer	Double Cut Veneer
Wall Mount Overhead Cabinet with Sliding Door and Cubbies 	16 3/16	48	23 1/2	174	14	VST1648WSDC	\$1,703		
	16 3/16	48	23 1/2	174	14	VSV1648WSDC		\$2,721	\$2,993
	16 3/16	42	23 1/2	160	12	VST1642WSDC	\$1,632		
	16 3/16	42	23 1/2	160	12	VSV1642WSDC		\$2,605	\$2,865
	16 3/16	36	23 1/2	148	11	VST1636WSDC	\$1,431		
	16 3/16	36	23 1/2	148	11	VSV1636WSDC		\$2,287	\$2,517
	16 3/16	30	23 1/2	141	9	VST1630WSDC	\$1,413		
	16 3/16	30	23 1/2	141	9	VSV1630WSDC		\$2,262	\$2,487

- white markerboard door available, specify and add \$215 list to laminate or veneer door price
- locking not available
- supported by wall cleat - hardware provided by installer
- pulls not available

To Order, Specify:

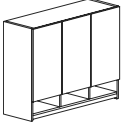
① Model Number	Laminate - VST	Veneer - VSV	
	② Worksurface Material (see page VI3) a.) TFL b.) HPL ③ Laminate Color (see page VI3) a.) Worksurface Color b.) Chassis Color c.) Drawer Color	② Wood Species - Cherry (CH1), Maple (MA1) Walnut (WA1), Black Oak (BO1) or Double Cut (DC1) (see page VI1) ③ Finish Color (see page VI1)	④ Edge Profile (see page VI4) ⑤ Pull Style and Color (see page VI5) ⑥ Optional Grommet Location & Color - Matte Black (MBK) or Arctic Silver (ASL) (see page VI6) ⑦ Other Product Options (see page VI10) ⑧ Accessories (see page VS314) ⑨ Power and Data Options (see page VS324)

Description	D	W	H	CTN WT	CU FT	① Model	Laminate		Flat Cut Veneer			Double Cut Veneer			
							Laminate Door	Alum. Frm Glass Door	Veneer Door	Alum. Frm Glass Door	Wood Frm Glass Door	Veneer Door	Alum. Frm Glass Door	Wood Frm Glass Door	
Double Height Wall Mount Overhead Cabinet with Six Doors and Cubbies 	16 ³ / ₁₆	108	35 ¹ / ₂	411	44	VST16108WDSOC	\$3,133	\$5,022							
	16 ³ / ₁₆	108	35 ¹ / ₂	411	44	VSV16108WDSOC			\$6,169	\$8,058	\$6,991	\$6,787	\$8,676	\$7,609	
	16 ³ / ₁₆	102	35 ¹ / ₂	389	42	VST16102WDSOC	\$2,982	\$4,819							
	16 ³ / ₁₆	102	35 ¹ / ₂	389	42	VSV16102WDSOC			\$5,828	\$7,664	\$6,650	\$6,413	\$8,250	\$7,235	
	16 ³ / ₁₆	96	35 ¹ / ₂	365	39	VST1696WDSOC	\$2,833	\$4,616							
	16 ³ / ₁₆	96	35 ¹ / ₂	365	39	VSV1696WDSOC			\$5,483	\$7,267	\$6,305	\$6,034	\$7,817	\$6,856	
	16 ³ / ₁₆	90	35 ¹ / ₂	344	37	VST1690WDSOC	\$2,694	\$4,426							
	16 ³ / ₁₆	90	35 ¹ / ₂	344	37	VSV1690WDSOC			\$5,144	\$6,876	\$5,966	\$5,657	\$7,390	\$6,480	

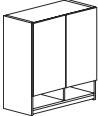
- select door style
- aluminum frame door offered in both frosted or white back painted glass, specify when ordering
- white markerboard doors available, specify and add \$1,040 list to laminate or veneer door price
- locking available on laminate or wood doors, specify and add \$115 list; glass doors are non-locking
- supported by wall cleat - hardware provided by installer
- no pulls

Description	D	W	H	CTN WT	CU FT	① Model	Laminate		Flat Cut Veneer			Double Cut Veneer			
							Laminate Door	Alum. Frm Glass Door	Veneer Door	Alum. Frm Glass Door	Wood Frm Glass Door	Veneer Door	Alum. Frm Glass Door	Wood Frm Glass Door	
Double Height Wall Mount Overhead Cabinet with Four Doors and Cubbies 	16 ³ / ₁₆	84	35 ¹ / ₂	320	35	VST1684WDSOC	\$2,563	\$3,926							
	16 ³ / ₁₆	84	35 ¹ / ₂	320	35	VSV1684WDSOC			\$4,800	\$6,163	\$5,440	\$5,281	\$6,645	\$5,922	
	16 ³ / ₁₆	78	35 ¹ / ₂	297	32	VST1678WDSOC	\$2,518	\$3,831							
	16 ³ / ₁₆	78	35 ¹ / ₂	297	32	VSV1678WDSOC			\$4,460	\$5,773	\$5,101	\$4,905	\$6,218	\$5,546	
	16 ³ / ₁₆	72	35 ¹ / ₂	274	30	VST1672WDSOC	\$2,393	\$3,652							
	16 ³ / ₁₆	72	35 ¹ / ₂	274	30	VSV1672WDSOC			\$4,145	\$5,403	\$4,785	\$4,560	\$5,818	\$5,200	
	16 ³ / ₁₆	66	35 ¹ / ₂	255	27	VST1666WDSOC	\$2,267	\$3,476							
	16 ³ / ₁₆	66	35 ¹ / ₂	255	27	VSV1666WDSOC			\$3,931	\$5,141	\$4,572	\$4,325	\$5,534	\$4,966	
	16 ³ / ₁₆	60	35 ¹ / ₂	237	25	VST1660WDSOC	\$2,180	\$3,336							
	16 ³ / ₁₆	60	35 ¹ / ₂	237	25	VSV1660WDSOC			\$3,815	\$4,971	\$4,455	\$4,199	\$5,355	\$4,840	
	16 ³ / ₁₆	54	35 ¹ / ₂	231	23	VST1654WDSOC	\$2,056	\$3,160							
	16 ³ / ₁₆	54	35 ¹ / ₂	231	23	VSV1654WDSOC			\$3,649	\$4,753	\$4,290	\$4,014	\$5,118	\$4,655	

- select door style
- aluminum frame door offered in both frosted or white back painted glass, specify when ordering
- white markerboard doors available, specify and add \$811 list to laminate or veneer door price
- locking available on laminate or wood doors, specify and add \$79 list; glass doors are non-locking
- supported by wall cleat - hardware provided by installer
- no pulls

Description	D	W	H	CTN WT	CU FT	① Model	Laminate		Flat Cut Veneer			Double Cut Veneer		
							Laminate Door	Alum. Frm Glass Door	Veneer Door	Alum. Frm Glass Door	Wood Glass Door	Veneer Door	Alum. Frm Glass Door	Wood Frm Glass Door
 Double Height Wall Mount Overhead Cabinet with Three Doors and Cubies	16 3/16	48	35 1/2	221	20	VST1648WDSOCR	\$1,771	\$2,662						
	16 3/16	48	35 1/2	221	20	VSV1648WDSOCR			\$3,136	\$4,028	\$3,560	\$3,451	\$4,342	\$3,875
	16 3/16	48	35 1/2	221	20	VST1648WDSOCL	\$1,771	\$2,662						
	16 3/16	48	35 1/2	221	20	VSV1648WDSOCL			\$3,136	\$4,028	\$3,560	\$3,451	\$4,342	\$3,875
	16 3/16	42	35 1/2	203	18	VST1642WDSOCR	\$1,691	\$2,532						
	16 3/16	42	35 1/2	203	18	VSV1642WDSOCR			\$2,774	\$3,616	\$3,198	\$3,051	\$3,892	\$3,475
	16 3/16	42	35 1/2	203	18	VST1642WDSOCL	\$1,691	\$2,532						
	16 3/16	42	35 1/2	203	18	VSV1642WDSOCL			\$2,774	\$3,616	\$3,198	\$3,051	\$3,892	\$3,475

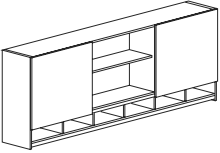
- select door style
- aluminum frame door offered in both frosted or white back painted glass, specify when ordering
- white markerboard doors available, specify and add \$537 list to laminate or veneer door price
- locking available on laminate or wood doors, specify and add \$74 list; glass doors are non-locking
- supported by wall cleat - hardware provided by installer
- right door configuration - 1 door hinges left and 2 doors hinge right
- left door configuration - 1 door hinges right and 2 doors hinge left
- no pulls

Description	D	W	H	CTN WT	CU FT	① Model	Laminate		Flat Cut Veneer			Double Cut Veneer		
							Laminate Door	Alum. Frm Glass Door	Veneer Door	Alum. Frm Glass Door	Wood Frm Glass Door	Veneer Door	Alum. Frm Glass Door	Wood Frm Glass Door
 Double Height Wall Mount Overhead Cabinet with Two Doors and Cubbies	16 3/16	36	35 1/2	188	16	VST1636WDSOC	\$1,474	\$2,105						
	16 3/16	36	35 1/2	188	16	VSV1636WDSOC			\$2,597	\$3,227	\$2,888	\$2,857	\$3,488	\$3,148
	16 3/16	30	35 1/2	180	13	VST1630WDSOC	\$1,410	\$1,988						
	16 3/16	30	35 1/2	180	13	VSV1630WDSOC			\$2,394	\$2,972	\$2,685	\$2,635	\$3,213	\$2,926

- select door style
- aluminum frame door offered in both frosted or white back painted glass, specify when ordering
- white markerboard doors available, specify and add \$368 list to laminate or veneer door price
- locking available on laminate or wood doors, specify and add \$47 list; glass doors are non-locking
- supported by wall cleat - hardware provided by installer
- no pulls

To Order, Specify:

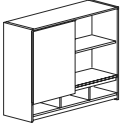
① Model Number	Laminate - VST	Veneer - VSV	④ Edge Profile (see page VI4)
	② Worksurface Material (see page VI3) a.) TFL b.) HPL ③ Laminate Color (see page VI3) a.) Worksurface Color b.) Chassis Color c.) Drawer Color	② Wood Species - Cherry (CH1), Maple (MA1) Walnut (WA1), Black Oak (BO1) or Double Cut (DC1) (see page VI1) ③ Finish Color (see page VI1)	⑤ Pull Style and Color (see page VI5) ⑥ Optional Grommet Location & Color - Matte Black (MBK) or Arctic Silver (ASL) (see page VI6) ⑦ Other Product Options (see page VI10) ⑧ Accessories (see page VS314) ⑨ Power and Data Options (see page VS324)

Description	D	W	H	CTN WT	CU FT	① Model	Laminate	Flat Cut Veneer	Double Cut Veneer
Double Height Wall Mount Overhead Cabinet with Two Sliding Doors and Cubbies 	16 3/16	108	35 1/2	411	44	VST16108WSDSDC	\$3,542		
	16 3/16	108	35 1/2	411	44	VSV16108WSDSDC		\$6,481	\$7,128
	16 3/16	102	35 1/2	389	42	VST16102WSDSDC	\$3,384		
	16 3/16	102	35 1/2	389	42	VSV16102WSDSDC		\$6,086	\$6,695
	16 3/16	96	35 1/2	365	39	VST1696WSDSDC	\$3,305		
	16 3/16	96	35 1/2	365	39	VSV1696WSDSDC		\$5,941	\$6,535
	16 3/16	90	35 1/2	344	37	VST1690WSDSDC	\$3,159		
	16 3/16	90	35 1/2	344	37	VSV1690WSDSDC		\$5,570	\$6,128

- white markerboard doors available, specify and add \$565 list to laminate or veneer door price
- locking not available
- supported by wall cleat - hardware provided by installer
- pulls not available

Double Height Wall Mount Overhead Cabinet with Sliding Door and Cubbies 	16 3/16	84	35 1/2	320	35	VST1684WSDSDC	\$3,016		
	16 3/16	84	35 1/2	320	35	VSV1684WSDSDC		\$5,197	\$5,717
	16 3/16	78	35 1/2	297	32	VST1678WSDSDC	\$2,882		
	16 3/16	78	35 1/2	297	32	VSV1678WSDSDC		\$4,829	\$5,311
	16 3/16	72	35 1/2	274	30	VST1672WSDSDC	\$2,753		
	16 3/16	72	35 1/2	274	30	VSV1672WSDSDC		\$4,553	\$5,009
	16 3/16	66	35 1/2	255	27	VST1666WSDSDC	\$2,614		
	16 3/16	66	35 1/2	255	27	VSV1666WSDSDC		\$4,343	\$4,777
	16 3/16	60	35 1/2	237	25	VST1660WSDSDC	\$2,529		
	16 3/16	60	35 1/2	237	25	VSV1660WSDSDC		\$4,225	\$4,647
	16 3/16	54	35 1/2	231	23	VST1654WSDSDC	\$2,428		
16 3/16	54	35 1/2	231	23	VSV1654WSDSDC		\$3,885	\$4,275	

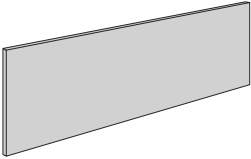
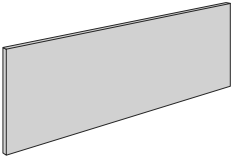
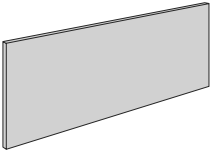
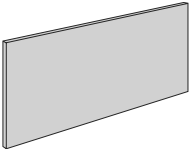
- white markerboard door available, specify and add \$284 list to laminate or veneer door price
- locking not available
- supported by wall cleat - hardware provided by installer
- pulls not available

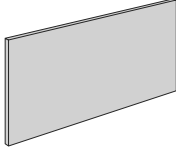
Description	D	W	H	CTN WT	CU FT	① Model	Laminate	Flat Cut Veneer	Double Cut Veneer
Double Height Wall Mount Overhead Cabinet with Sliding Door and Cubbies 	16 3/16	48	35 1/2	221	20	VST1648WDSDC	\$2,152		
	16 3/16	48	35 1/2	221	20	VSV1648WDSDC		\$3,441	\$3,788
	16 3/16	42	35 1/2	203	18	VST1642WDSDC	\$2,070		
	16 3/16	42	35 1/2	203	18	VSV1642WDSDC		\$3,311	\$3,641
	16 3/16	36	35 1/2	188	16	VST1636WDSDC	\$1,995		
	16 3/16	36	35 1/2	188	16	VSV1636WDSDC		\$3,186	\$3,504
	16 3/16	30	35 1/2	180	13	VST1630WDSDC	\$1,979		
	16 3/16	30	35 1/2	180	13	VSV1630WDSDC		\$3,164	\$3,481

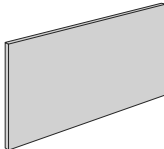
- white markerboard door available, specify and add \$284 list to laminate or veneer door price
- locking not available
- supported by wall cleat - hardware provided by installer
- pulls not available

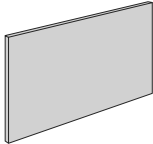
To Order, Specify:

① Model Number	Laminate - VST	Veneer - VSV	
	<p>② Worksurface Material (see page VI3)</p> <p>a.) TFL</p> <p>b.) HPL</p> <p>③ Laminate Color (see page VI3)</p> <p>a.) Worksurface Color</p> <p>b.) Chassis Color</p> <p>c.) Drawer Color</p>	<p>② Wood Species - Cherry (CH1), Maple (MA1) Walnut (WA1), Black Oak (BO1) or Double Cut (DC1) (see page VI1)</p> <p>③ Finish Color (see page VI1)</p>	<p>④ Edge Profile (see page VI4)</p> <p>⑤ Pull Style and Color (see page VI5)</p> <p>⑥ Optional Grommet Location & Color - Matte Black (MBK) or Arctic Silver (ASL) (see page VI6)</p> <p>⑦ Other Product Options (see page VI10)</p> <p>⑧ Accessories (see page VS314)</p> <p>⑨ Power and Data Options (see page VS324)</p>

Description	D	W	H	CTN WT	CU FT	① Model	List Price Per Grade
84" w Wall Mount Tackboard for Overhead Cabinet 	1 ¼	84	21 ½	19	5	VSB8422WT	COM \$434 A \$464 B \$520 C \$619 D \$748 E \$875 F \$1,075 G \$1,288 H \$1,514 I \$1,871 J \$2,299
							· com ydg: 2 ¾
78" w Wall Mount Tackboard for Overhead Cabinet 	1 ¼	78	21 ½	17	5	VSB7822WT	COM \$420 A \$446 B \$499 C \$589 D \$705 E \$823 F \$1,002 G \$1,197 H \$1,403 I \$1,726 J \$2,114
							· com ydg: 2 ½
72" w Wall Mount Tackboard for Overhead Cabinet 	1 ¼	72	21 ½	17	5	VSB7222WT	COM \$394 A \$418 B \$465 C \$546 D \$651 E \$755 F \$918 G \$1,092 H \$1,279 I \$1,570 J \$1,918
							· com ydg: 2 ¼
66" w Wall Mount Tackboard for Overhead Cabinet 	1 ¼	66	21 ½	15	4	VSB6622WT	COM \$367 A \$387 B \$428 C \$502 D \$594 E \$688 F \$831 G \$987 H \$1,152 I \$1,411 J \$1,721
							· com ydg: 2

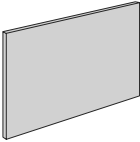
Description	D	W	H	CTN WT	CU FT	① Model	List Price Per Grade
60" w Wall Mount Tackboard for Overhead Cabinet 	1 ¼	60	21 ½	14	4	VSB6022WT	COM \$354 A \$375 B \$416 C \$488 D \$582 E \$675 F \$818 G \$974 H \$1,139 I \$1,399 J \$1,708

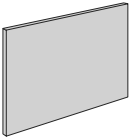
54" w Wall Mount Tackboard for Overhead Cabinet 	1 ¼	54	21 ½	13	4	VSB5422WT	COM \$330 A \$347 B \$383 C \$445 D \$528 E \$610 F \$736 G \$872 H \$1,016 I \$1,242 J \$1,513
---	-----	----	------	----	---	-----------	---

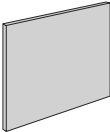
48" w Wall Mount Tackboard for Overhead Cabinet 	1 ¼	48	21 ½	12	3	VSB4822WT	COM \$303 A \$320 B \$357 C \$420 D \$502 E \$584 F \$711 G \$846 H \$991 I \$1,216 J \$1,488
---	-----	----	------	----	---	-----------	---

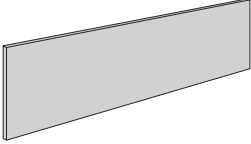
To Order, Specify:

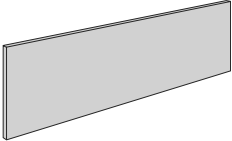
- ① Model Number
- ② Fabric Selection: vendor, pattern, color
Visit www.jsifurniture.com/finishes-and-materials/textiles
for our textiles program. See selection of standard and
graded in manufacturers and patterns.

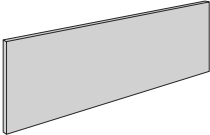
Description	D	W	H	CTN WT	CU FT	① Model	List Price Per Grade	
42" w Wall Mount Tackboard for Overhead Cabinet 	1 ¼	42	21 ½	11	3	VSB4222WT	COM \$275	
	· com ydg: 1 ½							A \$292
								B \$321
								C \$377
								D \$445
								E \$515
								F \$626
								G \$741
								H \$865
								I \$1,059
								J \$1,291

36" w Wall Mount Tackboard for Overhead Cabinet 	1 ¼	36	21 ½	10	3	VSB3622WT	COM \$251	
	· com ydg: 1 ¼							A \$264
								B \$290
								C \$335
								D \$393
								E \$450
								F \$542
								G \$638
								H \$742
								I \$904
								J \$1,098

30" w Wall Mount Tackboard for Overhead Cabinet 	1 ¼	30	21 ½	9	2	VSB3022WT	COM \$240	
	· com ydg: 1 ¼							A \$253
								B \$278
								C \$324
								D \$381
								E \$440
								F \$529
								G \$628
								H \$729
								I \$891
								J \$1,086

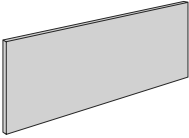
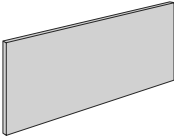
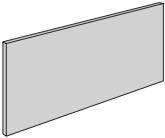
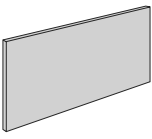
Description	D	W	H	CTN WT	CU FT	① Model	List Price Per Grade
84" w Wall Mount Tackboard for Overhead Cabinet with Cubbies 	1 1/4	83 3/4	19	17	5	VSB8420WTC	COM \$426 A \$456 B \$512 C \$611 D \$740 E \$867 F \$1,065 G \$1,279 H \$1,507 I \$1,862 J \$2,289

78" w Wall Mount Tackboard for Overhead Cabinet with Cubbies 	1 1/4	77 3/4	19	16	4	VSB7820WTC	COM \$413 A \$439 B \$489 C \$581 D \$697 E \$813 F \$995 G \$1,188 H \$1,396 I \$1,718 J \$2,106
---	-------	--------	----	----	---	------------	---

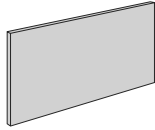
72" w Wall Mount Tackboard for Overhead Cabinet with Cubbies 	1 1/4	71 3/4	19	15	4	VSB7220WTC	COM \$387 A \$412 B \$458 C \$540 D \$643 E \$748 F \$912 G \$1,086 H \$1,273 I \$1,562 J \$1,911
---	-------	--------	----	----	---	------------	---

To Order, Specify:

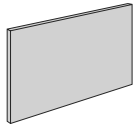
- ① Model Number
- ② Fabric Selection: vendor, pattern, color
Visit www.jsifurniture.com/finishes-and-materials/textiles
for our textiles program. See selection of standard and
graded in manufacturers and patterns.

Description	D	W	H	CTN WT	CU FT	① Model	List Price Per Grade
66" w Wall Mount Tackboard for Overhead Cabinet with Cubbies 	1 1/4	65 3/4	19	14	4	VSB6620WTC	COM \$359 A \$380 B \$421 C \$494 D \$588 E \$680 F \$825 G \$979 H \$1,145 I \$1,405 J \$1,713
60" w Wall Mount Tackboard for Overhead Cabinet with Cubbies 	1 1/4	59 3/4	19	13	4	VSB6020WTC	COM \$348 A \$368 B \$409 C \$482 D \$576 E \$669 F \$812 G \$968 H \$1,133 I \$1,392 J \$1,703
54" w Wall Mount Tackboard for Overhead Cabinet with Cubbies 	1 1/4	53 3/4	19	12	3	VSB5420WTC	COM \$324 A \$341 B \$378 C \$440 D \$523 E \$604 F \$729 G \$866 H \$1,011 I \$1,237 J \$1,508
48" w Wall Mount Tackboard for Overhead Cabinet with Cubbies 	1 1/4	47 3/4	19	11	3	VSB4820WTC	COM \$296 A \$315 B \$352 C \$415 D \$496 E \$578 F \$704 G \$840 H \$984 I \$1,211 J \$1,483

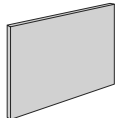
Description	D	W	H	CTN WT	CU FT	① Model	List Price Per Grade
42" w Wall Mount Tackboard for Overhead Cabinet with Cubbies	1 1/4	41 3/4	19	10	3	VSB4220WTC	COM \$270 A \$287 B \$317 C \$372 D \$441 E \$511 F \$620 G \$736 H \$860 I \$1,054 J \$1,286



36" w Wall Mount Tackboard for Overhead Cabinet with Cubbies	1 1/4	35 3/4	19	9	2	VSB3620WTC	COM \$245 A \$258 B \$284 C \$331 D \$389 E \$445 F \$537 G \$633 H \$737 I \$898 J \$1,092
--	-------	--------	----	---	---	------------	---




30" w Wall Mount Tackboard for Overhead Cabinet with Cubbies	1 1/4	29 3/4	19	8	2	VSB3020WTC	COM \$234 A \$248 B \$273 C \$318 D \$377 E \$436 F \$525 G \$623 H \$725 I \$887 J \$1,082
--	-------	--------	----	---	---	------------	---

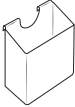


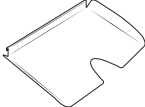
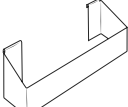


To Order, Specify:

- ① Model Number
- ② Fabric Selection: vendor, pattern, color
Visit www.jsifurniture.com/finishes-and-materials/textiles
for our textiles program. See selection of standard and
graded in manufacturers and patterns.

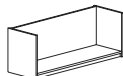
Description	D	W	H	CTN WT	CU FT	① Model	List Price
	¾	106 ⅞	3 ¼	9	3	VSB108AR	\$500
	¾	100 ⅞	3 ¼	8	3	VSB102AR	\$479
	¾	94 ⅞	3 ¼	7	3	VSB96AR	\$440
	¾	88 ⅞	3 ¼	7	3	VSB90AR	\$420
	¾	82 ⅞	3 ¼	6	2	VSB84AR	\$399
	¾	76 ⅞	3 ¼	6	2	VSB78AR	\$381
	¾	70 ⅞	3 ¼	5	2	VSB72AR	\$359
	¾	64 ⅞	3 ¼	4	2	VSB66AR	\$342
	¾	58 ⅞	3 ¼	4	2	VSB60AR	\$321
	¾	52 ⅞	3 ¼	4	2	VSB54AR	\$301
	¾	46 ⅞	3 ¼	3	2	VSB48AR	\$283
	¾	40 ⅞	3 ¼	3	1	VSB42AR	\$265
	¾	34 ⅞	3 ¼	3	1	VSB36AR	\$244
	¾	28 ⅞	3 ¼	2	1	VSB30AR	\$224

· used within overhead units for accessory tools

Description	D	W	H	CTN WT	CU FT	① Model	List Price
Upright Tray  <ul style="list-style-type: none"> pen and gadget cup Arctic Silver finish 	1 9/16	3 1/8	3 3/16	1	1	AC203CUP	\$108
Small Tray  <ul style="list-style-type: none"> tray for paper clips and other small items Arctic Silver finish 	3 5/16	2 1/4	7/8	1	1	AC403TRAY	\$82
Pencil Tray  <ul style="list-style-type: none"> tray for pencils and other small items Arctic Silver finish 	3 5/16	7 1/4	7/8	1	1	AC408TRAY	\$100
Paper Tray  <ul style="list-style-type: none"> tray for 8 1/2" x 11" letter paper size Arctic Silver finish 	9 7/16	13 3/16	7/8	1	1	AC912PAP	\$152
File Hanger  <ul style="list-style-type: none"> file hanger for 8 1/2" x 11" letter size hanging file folders Arctic Silver finish 	2 13/16	12 3/16	4	1	1	AC313FILE	\$144

To Order, Specify:

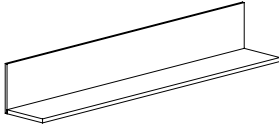
① Model Number	Laminate - VST	Veneer - VSV	
	② Worksurface Material (see page V13) a.) TFL b.) HPL ③ Laminate Color (see page V13) a.) Worksurface Color b.) Chassis Color c.) Drawer Color	② Wood Species - Cherry (CH1), Maple (MA1) Walnut (WA1), Black Oak (BO1) or Double Cut (DC1) (see page V11) ③ Finish Color (see page V11)	④ Edge Profile (see page V14) ⑤ Pull Style and Color (see page V15) ⑥ Optional Grommet Location & Color - Matte Black (MBK) or Arctic Silver (ASL) (see page V16) ⑦ Other Product Options (see page V110) ⑧ Accessories (see page VS314) ⑨ Power and Data Options (see page VS324)

Description	D	W	H	CTN WT	CU FT	① Model	Laminate	Flat Cut Veneer	Double Cut Veneer
Wall Mount Overhead Shelf 	15 7/16	54	17 1/2	65	12	VST1554WTS	\$723		
	15 7/16	54	17 1/2	65	12	VSV1554WTS		\$1,010	\$1,110
	15 7/16	48	17 1/2	58	10	VST1548WTS	\$631		
	15 7/16	48	17 1/2	58	10	VSV1548WTS		\$886	\$974
	15 7/16	42	17 1/2	51	9	VST1542WTS	\$573		
	15 7/16	42	17 1/2	51	9	VSV1542WTS		\$800	\$878
	15 7/16	36	17 1/2	44	8	VST1536WTS	\$490		
	15 7/16	36	17 1/2	44	8	VSV1536WTS		\$692	\$761
	15 7/16	30	17 1/2	42	7	VST1530WTS	\$487		
	15 7/16	30	17 1/2	42	7	VSV1530WTS		\$671	\$740

· supported by wall cleat - hardware provided by installer

Description	D	W	H	CTN WT	CU FT	① Model	Laminate	Flat Cut Veneer	Double Cut Veneer
Double Height Wall Mount Overhead Shelf 	15 7/16	54	30	85	19	VST1554WDTS	\$795		
	15 7/16	54	29 1/2	85	19	VSV1554WDTS		\$984	\$1,085
	15 7/16	48	29 1/2	76	17	VST1548WDTS	\$694		
	15 7/16	48	29 1/2	76	17	VSV1548WDTS		\$861	\$949
	15 7/16	42	29 1/2	67	15	VST1542WDTS	\$630		
	15 7/16	42	29 1/2	67	15	VSV1542WDTS		\$782	\$861
	15 7/16	36	29 1/2	58	13	VST1536WDTS	\$537		
	15 7/16	36	29 1/2	58	13	VSV1536WDTS		\$670	\$737
	15 7/16	30	29 1/2	55	11	VST1530WDTS	\$533		
	15 7/16	30	29 1/2	55	11	VSV1530WDTS		\$665	\$732

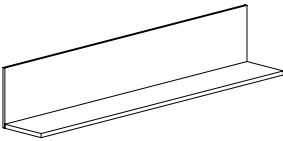
· supported by wall cleat - hardware provided by installer

Description	D	W	H	CTN WT	CU FT	① Model	Laminate	Flat Cut Veneer	Double Cut Veneer
Wall Mount Single Shelf for 84" Height 	15 3/8	96	14 3/4	84	17	VST1596-15WMS	\$837		
	15 3/8	96	14 3/4	84	17	VSV1596-15WMS		\$1,364	\$1,500
	15 3/8	90	14 3/4	79	16	VST1590-15WMS	\$800		
	15 3/8	90	14 3/4	79	16	VSV1590-15WMS		\$1,312	\$1,445
	15 3/8	84	14 3/4	74	15	VST1584-15WMS	\$761		
	15 3/8	84	14 3/4	74	15	VSV1584-15WMS		\$1,259	\$1,385
	15 3/8	78	14 3/4	69	14	VST1578-15WMS	\$741		
	15 3/8	78	14 3/4	69	14	VSV1578-15WMS		\$1,226	\$1,348
	15 3/8	72	14 3/4	64	13	VST1572-15WMS	\$702		
	15 3/8	72	14 3/4	64	13	VSV1572-15WMS		\$1,173	\$1,291
	15 3/8	66	14 3/4	59	12	VST1566-15WMS	\$682		
	15 3/8	66	14 3/4	59	12	VSV1566-15WMS		\$1,140	\$1,254
	15 3/8	60	14 3/4	54	11	VST1560-15WMS	\$612		
	15 3/8	60	14 3/4	54	11	VSV1560-15WMS		\$1,055	\$1,162
	15 3/8	54	14 3/4	49	10	VST1554-15WMS	\$583		
	15 3/8	54	14 3/4	49	10	VSV1554-15WMS		\$1,013	\$1,114
	15 3/8	48	14 3/4	44	9	VST1548-15WMS	\$554		
	15 3/8	48	14 3/4	44	9	VSV1548-15WMS		\$971	\$1,068
	15 3/8	42	14 3/4	39	8	VST1542-15WMS	\$514		
	15 3/8	42	14 3/4	39	8	VSV1542-15WMS		\$921	\$1,013
15 3/8	36	14 3/4	34	7	VST1536-15WMS	\$445			
15 3/8	36	14 3/4	34	7	VSV1536-15WMS		\$839	\$922	
15 3/8	30	14 3/4	29	6	VST1530-15WMS	\$418			
15 3/8	30	14 3/4	29	6	VSV1530-15WMS		\$797	\$876	

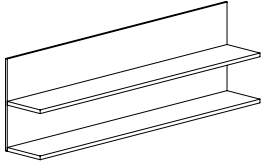
• supported by aluminum wall cleat - hardware provided by installer

To Order, Specify:

① Model Number	Laminate - VST	Veneer - VSV	④ Edge Profile (see page VI4)
	② Worksurface Material (see page VI3) a.) TFL b.) HPL	② Wood Species - Cherry (CH1), Maple (MA1) Walnut (WA1), Black Oak (BO1) or Double Cut (DC1) (see page VI1)	⑤ Pull Style and Color (see page VI5)
	③ Laminate Color (see page VI3) a.) Worksurface Color b.) Chassis Color c.) Drawer Color	③ Finish Color (see page VI1)	⑥ Optional Grommet Location & Color - Matte Black (MBK) or Arctic Silver (ASL) (see page VI6)
			⑦ Other Product Options (see page VI10)
			⑧ Accessories (see page VS314)
			⑨ Power and Data Options (see page VS324)

Description	D	W	H	CTN WT	CU FT	① Model	Laminate	Flat Cut Veneer	Double Cut Veneer
Wall Mount Single Shelf for 72" Height 	15 3/8	96	17 1/2	89	19	VST1596-18WMS	\$861		
	15 3/8	96	17 1/2	89	19	VSV1596-18WMS		\$1,382	\$1,521
	15 3/8	90	17 1/2	84	18	VST1590-18WMS	\$823		
	15 3/8	90	17 1/2	84	18	VSV1590-18WMS		\$1,328	\$1,462
	15 3/8	84	17 1/2	79	17	VST1584-18WMS	\$781		
	15 3/8	84	17 1/2	79	17	VSV1584-18WMS		\$1,275	\$1,402
	15 3/8	78	17 1/2	74	16	VST1578-18WMS	\$761		
	15 3/8	78	17 1/2	74	16	VSV1578-18WMS		\$1,239	\$1,363
	15 3/8	72	17 1/2	69	15	VST1572-18WMS	\$719		
	15 3/8	72	17 1/2	69	15	VSV1572-18WMS		\$1,185	\$1,303
	15 3/8	66	17 1/2	64	14	VST1566-18WMS	\$699		
	15 3/8	66	17 1/2	64	14	VSV1566-18WMS		\$1,151	\$1,266
	15 3/8	60	17 1/2	59	12	VST1560-18WMS	\$627		
	15 3/8	60	17 1/2	59	12	VSV1560-18WMS		\$1,064	\$1,172
	15 3/8	54	17 1/2	54	11	VST1554-18WMS	\$596		
	15 3/8	54	17 1/2	54	11	VSV1554-18WMS		\$1,021	\$1,124
	15 3/8	48	17 1/2	49	10	VST1548-18WMS	\$566		
	15 3/8	48	17 1/2	49	10	VSV1548-18WMS		\$977	\$1,076
	15 3/8	42	17 1/2	44	9	VST1542-18WMS	\$525		
	15 3/8	42	17 1/2	44	9	VSV1542-18WMS		\$926	\$1,018
15 3/8	36	17 1/2	39	8	VST1536-18WMS	\$455			
15 3/8	36	17 1/2	39	8	VSV1536-18WMS		\$842	\$927	
15 3/8	30	17 1/2	34	7	VST1530-18WMS	\$425			
15 3/8	30	17 1/2	34	7	VSV1530-18WMS		\$809	\$890	

· supported by aluminum wall cleat - hardware provided by installer

Description	D	W	H	CTN WT	CU FT	① Model	Laminate	Flat Cut Veneer	Double Cut Veneer
Wall Mount Double Shelf for 84" Height 	15 3/8	96	29 1/2	163	31	VST1596-30WMS	\$1,086		
	15 3/8	96	29 1/2	163	31	VSV1596-30WMS		\$1,658	\$1,824
	15 3/8	90	29 1/2	153	29	VST1590-30WMS	\$1,040		
	15 3/8	90	29 1/2	153	29	VSV1590-30WMS		\$1,594	\$1,754
	15 3/8	84	29 1/2	143	27	VST1584-30WMS	\$972		
	15 3/8	84	29 1/2	143	27	VSV1584-30WMS		\$1,508	\$1,659
	15 3/8	78	29 1/2	133	25	VST1578-30WMS	\$943		
	15 3/8	78	29 1/2	133	25	VSV1578-30WMS		\$1,456	\$1,602
	15 3/8	72	29 1/2	122	24	VST1572-30WMS	\$896		
	15 3/8	72	29 1/2	122	24	VSV1572-30WMS		\$1,390	\$1,531
	15 3/8	66	29 1/2	112	22	VST1566-30WMS	\$869		
	15 3/8	66	29 1/2	112	22	VSV1566-30WMS		\$1,346	\$1,483
	15 3/8	60	29 1/2	102	20	VST1560-30WMS	\$790		
	15 3/8	60	29 1/2	102	20	VSV1560-30WMS		\$1,250	\$1,375
	15 3/8	54	29 1/2	91	18	VST1554-30WMS	\$753		
	15 3/8	54	29 1/2	91	18	VSV1554-30WMS		\$1,196	\$1,316
	15 3/8	48	29 1/2	81	16	VST1548-30WMS	\$716		
	15 3/8	48	29 1/2	81	16	VSV1548-30WMS		\$1,141	\$1,256
	15 3/8	42	29 1/2	71	14	VST1542-30WMS	\$663		
	15 3/8	42	29 1/2	71	14	VSV1542-30WMS		\$1,080	\$1,188
15 3/8	36	29 1/2	61	12	VST1536-30WMS	\$566			
15 3/8	36	29 1/2	61	12	VSV1536-30WMS		\$965	\$1,062	
15 3/8	30	29 1/2	51	10	VST1530-30WMS	\$529			
15 3/8	30	29 1/2	51	10	VSV1530-30WMS		\$912	\$1,003	

• supported by aluminum wall cleat - hardware provided by installer

To Order, Specify:

① Model Number

Laminate - VST

Veneer - VSV

② Worksurface Material (see page V13)

- a.) TFL
- b.) HPL

③ Laminate Color (see page V13)

- a.) Worksurface Color
- b.) Chassis Color
- c.) Drawer Color

② Wood Species - Cherry (CH1), Maple (MA1)

- Walnut (WA1), Black Oak (BO1) or
- Double Cut (DC1) (see page V11)

③ Finish Color (see page V11)

④ Edge Profile (see page V14)

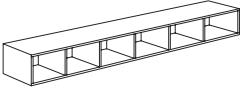
⑤ Pull Style and Color (see page V15)

⑥ Optional Grommet Location & Color -
Matte Black (MBK) or Arctic Silver (ASL)
(see page V16)

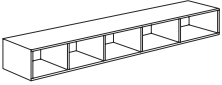
⑦ Other Product Options (see page V110)

⑧ Accessories (see page VS314)

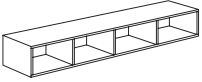
⑨ Power and Data Options (see page VS324)

Description	D	W	H	CTN WT	CU FT	① Model	Laminate	Flat Cut Veneer	Double Cut Veneer
Wall Mount Cubby 	13	108	10	131	12	VST10108WCU	\$1,483		
	13	108	10	131	12	VSV10108WCU		\$2,350	\$2,587
	13	102	10	122	11	VST10102WCU	\$1,383		
	13	102	10	122	11	VSV10102WCU		\$2,196	\$2,415
	13	96	10	113	11	VST1096WCU	\$1,289		
	13	96	10	113	11	VSV1096WCU		\$2,041	\$2,244
	13	90	10	106	10	VST1090WCU	\$1,199		
	13	90	10	106	10	VSV1090WCU		\$1,899	\$2,089

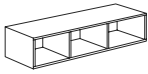
- 6 compartments
- supported by wall cleat - hardware provided by installer
- VST10108WCU or VSV10108WCU interior dimensions - 11 7/16 d x 17 1/8 w x 8 1/2 h
- VST10102WCU or VSV10102WCU interior dimensions - 11 7/16 d x 16 1/8 w x 8 1/2 h
- VST1096WCU or VSV1096WCU interior dimensions - 11 7/16 d x 15 1/8 w x 8 1/2 h
- VST1090WCU or VSV1090WCU interior dimensions - 11 7/16 d x 14 1/8 w x 8 1/2 h

Wall Mount Cubby 	13	84	10	98	9	VST1084WCU	\$1,102		
	13	84	10	98	9	VSV1084WCU		\$1,746	\$1,921
	13	78	10	89	9	VST1078WCU	\$1,017		
	13	78	10	89	9	VSV1078WCU		\$1,610	\$1,773

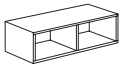
- 5 compartments
- supported by wall cleat - hardware provided by installer
- VST1084WCU or VSV1084WCU interior dimensions - 11 7/16 d x 15 7/8 w x 8 1/2 h
- VST1078WCU or VSV1078WCU interior dimensions - 11 7/16 d x 14 3/4 w x 8 1/2 h

Wall Mount Cubby 	13	72	10	81	8	VST1072WCU	\$940		
	13	72	10	81	8	VSV1072WCU		\$1,489	\$1,636
	13	66	10	74	8	VST1066WCU	\$864		
	13	66	10	74	8	VSV1066WCU		\$1,366	\$1,502
	13	60	10	68	7	VST1060WCU	\$795		
	13	60	10	68	7	VSV1060WCU		\$1,256	\$1,381

- 4 compartments
- supported by wall cleat - hardware provided by installer
- VST1072WCU or VSV1072WCU interior dimensions - 11 7/16 d x 17 1/16 w x 8 1/2 h
- VST1066WCU or VSV1066WCU interior dimensions - 11 7/16 d x 15 9/16 w x 8 1/2 h
- VST1060WCU or VSV1060WCU interior dimensions - 11 7/16 d x 14 1/16 w x 8 1/2 h

Description	D	W	H	CTN WT	CU FT	① Model	Laminate	Flat Cut Veneer	Double Cut Veneer
Wall Mount Cubby 	13	54	10	62	6	VST1054WCU	\$731		
	13	54	10	62	6	VSV1054WCU		\$1,158	\$1,274
	13	48	10	53	6	VST1048WCU	\$674		
	13	48	10	53	6	VSV1048WCU		\$1,068	\$1,176


- 3 compartments
- supported by wall cleat - hardware provided by installer
- VST1054WCU or VSV1054WCU interior dimensions - 11 7/16 d x 17 w x 8 1/2 h
- VST1048WCU or VSV1048WCU interior dimensions - 11 7/16 d x 15 w x 8 1/2 h

Wall Mount Cubby 	13	42	10	47	5	VST1042WCU	\$619		
	13	42	10	47	5	VSV1042WCU		\$979	\$1,076
	13	36	10	42	4	VST1036WCU	\$568		
	13	36	10	42	4	VSV1036WCU		\$897	\$990
	13	30	10	37	4	VST1030WCU	\$524		
	13	30	10	37	4	VSV1030WCU		\$830	\$913

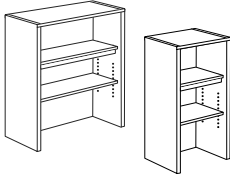
- 2 compartments
- supported by wall cleat - hardware provided by installer
- VST1042WCU or VSV1042WCU interior dimensions - 11 7/16 d x 19 7/8 w x 8 1/2 h
- VST1036WCU or VSV1036WCU interior dimensions - 11 7/16 d x 16 7/8 w x 8 1/2 h
- VST1030WCU or VSV1030WCU interior dimensions - 11 7/16 d x 13 7/8 w x 8 1/2 h

To Order, Specify:

① Model Number	Laminate - VST	Veneer - VSV	
	<ul style="list-style-type: none"> ② Worksurface Material (see page VI3) <ul style="list-style-type: none"> a.) TFL b.) HPL ③ Laminate Color (see page VI3) <ul style="list-style-type: none"> a.) Worksurface Color b.) Chassis Color c.) Drawer Color 	<ul style="list-style-type: none"> ② Wood Species - Cherry (CH1), Maple (MA1) Walnut (WA1), Black Oak (BO1) or Double Cut (DC1) (see page VI1) ③ Finish Color (see page VI1) 	<ul style="list-style-type: none"> ④ Edge Profile (see page VI4) ⑤ Pull Style and Color (see page VI5) ⑥ Optional Grommet Location & Color - Matte Black (MBK) or Arctic Silver (ASL) (see page VI6) ⑦ Other Product Options (see page VI10) ⑧ Accessories (see page VS314) ⑨ Power and Data Options (see page VS324)

Description	D	W	H	CTN WT	CU FT	① Model	Laminate	Flat Cut Veneer	Double Cut Veneer
Floating Shelf 	7	84	1	16	2	VST0784FS	\$480		
	7	84	1	16	2	VSV0784FS		\$680	\$749
	7	78	1	15	2	VST0778FS	\$464		
	7	78	1	15	2	VSV0778FS		\$668	\$735
	7	72	1	14	2	VST0772FS	\$446		
	7	72	1	14	2	VSV0772FS		\$654	\$720
	7	66	1	13	2	VST0766FS	\$431		
	7	66	1	13	2	VSV0766FS		\$641	\$706
	7	60	1	12	1	VST0760FS	\$415		
	7	60	1	12	1	VSV0760FS		\$629	\$692
	7	54	1	11	1	VST0754FS	\$397		
	7	54	1	11	1	VSV0754FS		\$615	\$678
	7	48	1	10	1	VST0748FS	\$380		
	7	48	1	10	1	VSV0748FS		\$603	\$663
	7	42	1	9	1	VST0742FS	\$355		
	7	42	1	9	1	VSV0742FS		\$582	\$640
	7	36	1	8	1	VST0736FS	\$339		
	7	36	1	8	1	VSV0736FS		\$568	\$627
7	30	1	7	1	VST0730FS	\$321			
7	30	1	7	1	VSV0730FS		\$555	\$611	

· concealed mounting brackets included

Description	D	W	H	CTN WT	CU FT	① Model	Laminate	Flat Cut Veneer	Double Cut Veneer
Bookcase Overhead 	15 7/16	35 3/4	42 1/2	78	13	VST1636BO	\$1,077		
	15 7/16	35 3/4	42 1/2	78	13	VSV1636BO		\$1,400	\$1,539
	15 7/16	29 3/4	42 1/2	75	13	VST1630BO	\$984		
	15 7/16	29 3/4	42 1/2	75	13	VSV1630BO		\$1,228	\$1,349
	15 7/16	17 7/8	42 1/2	41	9	VST1618BO	\$757		
	15 7/16	17 7/8	42 1/2	41	9	VSV1618BO		\$1,082	\$1,191

- fixed shelf on top, adjustable shelf on bottom

Double Height Bookcase Overhead 	15 7/16	35 3/4	54 1/2	102	22	VST1636DBO	\$1,240		
	15 7/16	35 3/4	54 1/2	102	22	VSV1636DBO		\$1,858	\$2,042
	15 7/16	29 3/4	54 1/2	98	19	VST1630DBO	\$1,132		
	15 7/16	29 3/4	54 1/2	98	19	VSV1630DBO		\$1,696	\$1,864
	15 7/16	17 7/8	54 1/2	54	12	VST1618DBO	\$876		
	15 7/16	17 7/8	54 1/2	54	12	VSV1618DBO		\$1,314	\$1,445

- one fixed shelf, two adjustable shelves
- backside of unit intended to go against a wall, cabinet should be secured to a wall as a safety precaution

To Order, Specify:

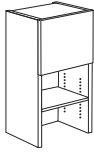
① Model Number	Laminate - VST	Veneer - VSV	
	<ul style="list-style-type: none"> ② Worksurface Material (see page VI3) <ul style="list-style-type: none"> a.) TFL b.) HPL ③ Laminate Color (see page VI3) <ul style="list-style-type: none"> a.) Worksurface Color b.) Chassis Color c.) Drawer Color 	<ul style="list-style-type: none"> ② Wood Species - Cherry (CH1), Maple (MA1) Walnut (WA1), Black Oak (BO1) or Double Cut (DC1) (see page VI1) ③ Finish Color (see page VI1) 	<ul style="list-style-type: none"> ④ Edge Profile (see page VI4) ⑤ Pull Style and Color (see page VI5) ⑥ Optional Grommet Location & Color - Matte Black (MBK) or Arctic Silver (ASL) (see page VI6) ⑦ Other Product Options (see page VI10) ⑧ Accessories (see page VS314) ⑨ Power and Data Options (see page VS324)

Description	D	W	H	CTN WT	CU FT	① Model	Laminate		Flat Cut Veneer			Double Cut Veneer		
							Laminate Door	Alum. Frm Glass Door	Veneer Door	Alum. Frm Glass Door	Wood Frm Glass Door	Veneer Door	Alum. Frm Glass Door	Wood Frm Glass Door
Storage Tower with 17" h Doors	16 ³ / ₁₆	35 ³ / ₄	42 ¹ / ₂	90	13	VST1636SB	\$1,495	\$1,974						
	16 ³ / ₁₆	35 ³ / ₄	42 ¹ / ₂	90	13	VSV1636SB			\$1,885	\$2,364	\$2,070	\$2,076	\$2,555	\$2,261
	16 ³ / ₁₆	29 ³ / ₄	42 ¹ / ₂	80	13	VST1630SB	\$1,386	\$1,828						
	16 ³ / ₁₆	29 ³ / ₄	42 ¹ / ₂	80	13	VSV1630SB			\$1,637	\$2,079	\$1,822	\$1,804	\$2,246	\$1,989



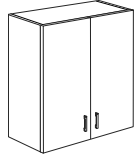
- 17" door height
- select door style
- aluminum frame door offered in both frosted or white back painted glass, specify when ordering
- white markerboard doors available, specify and add \$233 list to laminate or veneer door price
- locking available on laminate or wood doors, specify and add \$47 list; glass doors are non-locking
- adjustable shelf
- no pulls

Description	D	W	H	CTN WT	CU FT	① Model	Laminate		Flat Cut Veneer			Double Cut Veneer		
							Laminate Door	Alum. Frm Glass Door	Veneer Door	Alum. Frm Glass Door	Wood Frm Glass Door	Veneer Door	Alum. Frm Glass Door	Wood Frm Glass Door
Storage Tower with 17" h Door	16 ³ / ₁₆	17 ⁷ / ₈	42 ¹ / ₂	45	9	VST1618SBR	\$986	\$1,226						
	16 ³ / ₁₆	17 ⁷ / ₈	42 ¹ / ₂	45	9	VSV1618SBR			\$1,211	\$1,452	\$1,380	\$1,334	\$1,575	\$1,503
	16 ³ / ₁₆	17 ⁷ / ₈	42 ¹ / ₂	45	9	VST1618SBL	\$986	\$1,226						
	16 ³ / ₁₆	17 ⁷ / ₈	42 ¹ / ₂	45	9	VSV1618SBL			\$1,211	\$1,452	\$1,380	\$1,334	\$1,575	\$1,503



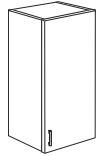
- 17" door height
- select door style
- aluminum frame door offered in both frosted or white back painted glass, specify when ordering
- white markerboard door available, specify and add \$215 list to laminate or veneer door price
- locking available on laminate or wood door, specify and add \$40 list; glass door is non-locking
- adjustable shelf
- no pull

Description	D	W	H	CTN WT	CU FT	① Model	Laminate		Flat Cut Veneer			Double Cut Veneer		
							Laminate Door	Alum. Frm Glass Door	Veneer Door	Alum. Frm Glass Door	Wood Glass Door	Veneer Door	Alum. Frm Glass Door	Wood Frm Glass Door
Storage Tower with 42" h Doors	16 3/16	35 3/4	42 1/2	99	13	VST1636STD	\$1,585	\$2,376						
	16 3/16	35 3/4	42 1/2	99	13	VSV1636STD			\$1,935	\$2,726	\$2,273	\$2,130	\$2,922	\$2,469
	16 3/16	29 3/4	42 1/2	88	13	VST1630STD	\$1,314	\$2,039						
	16 3/16	29 3/4	42 1/2	88	13	VSV1630STD			\$1,707	\$2,433	\$2,045	\$1,879	\$2,605	\$2,218



- 42" door height
- select door style
- aluminum frame door offered in both frosted or white back painted glass, specify when ordering
- white markerboard doors available, specify and add \$428 list to laminate or veneer door price
- locking available on laminate or wood doors, specify and add \$47 list; glass doors are non-locking
- adjustable shelf

Description	D	W	H	CTN WT	CU FT	① Model	Laminate		Flat Cut Veneer			Double Cut Veneer		
							Laminate Door	Alum. Frm Glass Door	Veneer Door	Alum. Frm Glass Door	Wood Frm Glass Door	Veneer Door	Alum. Frm Glass Door	Wood Frm Glass Door
Storage Tower with 42" h Doors	16 3/16	17 7/8	42 1/2	51	9	VST1618STDR	\$1,035	\$1,431						
	16 3/16	17 7/8	42 1/2	51	9	VSV1618STDR			\$1,346	\$1,743	\$1,572	\$1,483	\$1,879	\$1,708
	16 3/16	17 7/8	42 1/2	51	9	VST1618STD	\$1,035	\$1,431						
	16 3/16	17 7/8	42 1/2	51	9	VSV1618STD			\$1,346	\$1,743	\$1,572	\$1,483	\$1,879	\$1,708

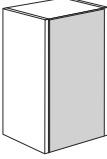


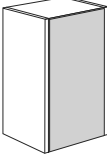
right shown

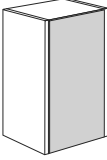
- 42" door height
- select door style
- aluminum frame door offered in both frosted or white back painted glass, specify when ordering
- white markerboard door available, specify and add \$284 list to laminate or veneer door price
- locking available on laminate or wood door, specify and add \$40 list; glass door is non-locking
- adjustable shelf

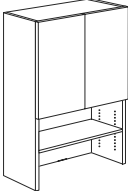
To Order, Specify:

① Model Number	Laminate - VST	Veneer - VSV
	<ul style="list-style-type: none"> ② Worksurface Material (see page VI3) <ul style="list-style-type: none"> a.) TFL b.) HPL ③ Laminate Color (see page VI3) <ul style="list-style-type: none"> a.) Worksurface Color b.) Chassis Color c.) Drawer Color 	<ul style="list-style-type: none"> ② Wood Species - Cherry (CH1), Maple (MA1) Walnut (WA1), Black Oak (BO1) or Double Cut (DC1) (see page VI1) ③ Finish Color (see page VI1)
		<ul style="list-style-type: none"> ④ Edge Profile (see page VI4) ⑤ Pull Style and Color (see page VI5) ⑥ Optional Grommet Location & Color - Matte Black (MBK) or Arctic Silver (ASL) (see page VI6) ⑦ Other Product Options (see page VI10) ⑧ Accessories (see page VS314) ⑨ Power and Data Options (see page VS324)

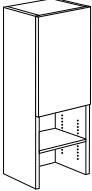
Description	D	W	H	CTN WT	CU FT	① Model	List Price Per Grade
36" w Fabric Back Panel for Storage Tower	1/2	34 1/8	41 5/8	13	5	VSB3642TKB	COM \$327
							A \$340
 <ul style="list-style-type: none"> · for use with 36" w storage tower · com ydg: 1 1/4 							B \$365
							C \$412
							D \$469
							E \$527
							F \$618
							G \$715
							H \$818
							I \$979
							J \$1,173

30" w Fabric Back Panel for Storage Tower	1/2	28 1/8	41 5/8	11	4	VSB3042TKB	COM \$306
							A \$318
 <ul style="list-style-type: none"> · for use with 30" w storage tower · com ydg: 1 1/4 							B \$345
							C \$390
							D \$447
							E \$506
							F \$596
							G \$693
							H \$798
							I \$959
							J \$1,152

18" w Fabric Back Panel for Storage Tower	1/2	16 1/8	41 5/8	7	2	VSB1842TKB	COM \$235
							A \$243
 <ul style="list-style-type: none"> · for use with 18" w storage tower · com ydg: 1 3/4 							B \$258
							C \$285
							D \$320
							E \$356
							F \$412
							G \$468
							H \$530
							I \$628
							J \$744

Description	D	W	H	CTN WT	CU FT	① Model	Laminate		Flat Cut Veneer			Double Cut Veneer		
							Laminate Door	Alum. Frm Glass Door	Veneer Door	Alum. Frm Glass Door	Wood Glass Door	Veneer Door	Alum. Frm Glass Door	Wood Frm Glass Door
Double Height Storage Tower with 29" h Door 	16 3/16	35 3/4	54 1/2	117	23	VST1636DSB	\$1,593	\$2,224						
	16 3/16	35 3/4	54 1/2	117	23	VSV1636DSB			\$2,453	\$3,084	\$2,744	\$2,698	\$3,329	\$2,989
	16 3/16	29 3/4	54 1/2	104	19	VST1630DSB	\$1,541	\$2,119						
	16 3/16	29 3/4	54 1/2	104	19	VSV1630DSB			\$2,004	\$2,582	\$2,295	\$2,204	\$2,782	\$2,495

- 29" door height
- select door style
- aluminum frame door offered in both frosted or white back painted glass, specify when ordering
- white markerboard doors available, specify and add \$368 list to laminate or veneer door price
- locking available on laminate or wood doors, specify and add \$471 list; glass doors are non-locking
- one fixed shelf, two adjustable shelves
- no pulls
- backside of unit intended to go against a wall, cabinet should be secured to a wall as a safety precaution

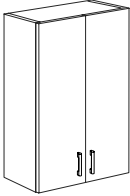
Description	D	W	H	CTN WT	CU FT	① Model	Laminate		Flat Cut Veneer			Double Cut Veneer		
							Laminate Door	Alum. FR Glass Door	Veneer Door	Alum. FR Glass Door	Wood Glass Door	Veneer Door	Alum. FR Glass Door	Wood Glass Door
Double Height Storage Tower with 29" h Door 	16 3/16	17 7/8	54 1/2	59	12	VST1618DSBR	\$1,102	\$1,419						
	16 3/16	17 7/8	54 1/2	59	12	VSV1618DSBR			\$1,575	\$1,892	\$1,744	\$1,734	\$2,050	\$1,903
	16 3/16	17 7/8	54 1/2	59	12	VST1618DSBL	\$1,102	\$1,419						
	16 3/16	17 7/8	54 1/2	59	12	VSV1618DSBL			\$1,575	\$1,892	\$1,744	\$1,734	\$2,050	\$1,903

- 29" door height
- select door style
- aluminum frame door offered in both frosted or white back painted glass, specify when ordering
- white markerboard doors available, specify and add \$284 list to laminate or veneer door price
- locking available on laminate or wood door, specify and add \$40 list; glass door is non-locking
- one fixed shelf, two adjustable shelves
- no pull
- backside of unit intended to go against a wall, cabinet should be secured to a wall as a safety precaution

To Order, Specify:

① Model Number	Laminate - VST	Veneer - VSV
	<ul style="list-style-type: none"> ② Worksurface Material (see page VI3) <ul style="list-style-type: none"> a.) TFL b.) HPL ③ Laminate Color (see page VI3) <ul style="list-style-type: none"> a.) Worksurface Color b.) Chassis Color c.) Drawer Color 	<ul style="list-style-type: none"> ② Wood Species - Cherry (CH1), Maple (MA1) Walnut (WA1), Black Oak (BO1) or Double Cut (DC1) (see page VI1) ③ Finish Color (see page VI1)
		<ul style="list-style-type: none"> ④ Edge Profile (see page VI4) ⑤ Pull Style and Color (see page VI5) ⑥ Optional Grommet Location & Color - Matte Black (MBK) or Arctic Silver (ASL) (see page VI6) ⑦ Other Product Options (see page VI10) ⑧ Accessories (see page VS314) ⑨ Power and Data Options (see page VS324)

Description	D	W	H	CTN WT	CU FT	① Model	Laminate		Flat Cut Veneer			Double Cut Veneer		
							Laminate Door	Alum. Frm Glass Door	Veneer Door	Alum. Frm Glass Door	Wood Frm Glass Door	Veneer Door	Alum. Frm Glass Door	Wood Frm Glass Door
Double Height Storage Tower with 54" h Door	16 ³ / ₁₆	35 ³ / ₄	54 ¹ / ₂	129	23	VST1636DSTD	\$1,708	\$2,654						
	16 ³ / ₁₆	35 ³ / ₄	54 ¹ / ₂	129	23	VSV1636DSTD			\$2,516	\$3,462	\$2,854	\$2,767	\$3,713	\$3,105
	16 ³ / ₁₆	29 ³ / ₄	54 ¹ / ₂	115	19	VST1630DSTD	\$1,581	\$2,444						
	16 ³ / ₁₆	29 ³ / ₄	54 ¹ / ₂	115	19	VSV1630DSTD			\$2,201	\$3,064	\$2,539	\$2,421	\$3,284	\$2,759



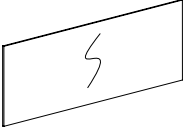
- 54" door height
- select door style
- aluminum frame door offered in both frosted or white back painted glass, specify when ordering
- white markerboard doors available, specify and add \$428 list to laminate or veneer door price
- locking available on laminate or wood doors, specify and add \$47 list; glass doors are non-locking
- one fixed shelf, two adjustable shelves
- backside of unit intended to go against a wall, cabinet should be secured to a wall as a safety precaution

Description	D	W	H	CTN WT	CU FT	① Model	Laminate		Flat Cut Veneer			Double Cut Veneer		
							Laminate Door	Alum.Frm Glass Door	Veneer Door	Alum. Frm Glass Door	Wood Frm Glass Door	Veneer Door	Alum. Frm Glass Door	Wood Frm Glass Door
Double Height Storage Tower with 54" h Door	16 ³ / ₁₆	17 ⁷ / ₈	54 ¹ / ₂	67	12	VST1618DSTDR	\$1,141	\$1,616						
	16 ³ / ₁₆	17 ⁷ / ₈	54 ¹ / ₂	67	12	VSV1618DSTDR			\$1,597	\$2,072	\$1,823	\$1,754	\$2,229	\$1,980
	16 ³ / ₁₆	17 ⁷ / ₈	54 ¹ / ₂	67	12	VST1618DSTDL	\$1,141	\$1,616						
	16 ³ / ₁₆	17 ⁷ / ₈	54 ¹ / ₂	67	12	VSV1618DSTDL			\$1,597	\$2,072	\$1,823	\$1,754	\$2,229	\$1,980



right shown

- 54" door height
- select door style
- aluminum frame door offered in both frosted or white back painted glass, specify when ordering
- white markerboard door available, specify and add \$284 list to laminate or veneer door price
- locking available on laminate or wood door, specify and add \$40 list; glass door is non-locking
- one fixed shelf, two adjustable shelves
- backside of unit intended to go against a wall, cabinet should be secured to a wall as a safety precaution

Description	D	W	H	CTN WT	CU FT	① Model	List Price
Markerboard for Front of Storage Overhead Cabinet 	1/2	106 1/8	23	32	7	VSB10823MB	\$612
	1/2	100 1/8	23	30	6	VSB10223MB	\$589
	1/2	94 1/8	23	29	6	VSB9623MB	\$564
	1/2	88 1/8	23	27	6	VSB9023MB	\$543
	1/2	82 1/8	23	25	5	VSB8423MB	\$521
	1/2	76 1/8	23	23	5	VSB7823MB	\$499
	1/2	70 1/8	23	22	5	VSB7223MB	\$457
	1/2	64 1/8	23	20	4	VSB6623MB	\$433
	1/2	58 1/8	23	18	4	VSB6023MB	\$409
	1/2	52 1/8	23	16	4	VSB5423MB	\$385
	1/2	46 1/8	23	14	3	VSB4823MB	\$343
	1/2	40 1/8	23	13	3	VSB4223MB	\$319
	1/2	34 1/8	23	11	3	VSB3623MB	\$296
	1/2	28 1/8	23	9	2	VSB3023MB	\$272

· use with standard overheads

To Order, Specify:

① Model Number	Laminate - VST	Veneer - VSV	
	② Worksurface Material (see page VI3) a.) TFL b.) HPL ③ Laminate Color (see page VI3) a.) Worksurface Color b.) Chassis Color c.) Drawer Color	② Wood Species - Cherry (CH1), Maple (MA1) Walnut (WA1), Black Oak (BO1) or Double Cut (DC1) (see page VI1) ③ Finish Color (see page VI1)	④ Edge Profile (see page VI4) ⑤ Pull Style and Color (see page VI5) ⑥ Optional Grommet Location & Color - Matte Black (MBK) or Arctic Silver (ASL) (see page VI6) ⑦ Other Product Options (see page VI10) ⑧ Accessories (see page VS314) ⑨ Power and Data Options (see page VS324)

Description	D	W	H	CTN WT	CU FT	① Model	List Price Per Grade
Half Markerboard/Half Tackboard for Front of 108" w Storage Overhead Cabinet	1/2	23	106 1/8	21	7	VSB10823MBTK1	COM \$759 A \$776 B \$812 C \$876 D \$958 E \$1,039 F \$1,165 G \$1,301 H \$1,446 I \$1,671 J \$1,944

· for use with 108" w overhead
· com ydg: 1 3/4

Half Markerboard/Half Tackboard for Front of 102" w Storage Overhead Cabinet	1/2	23	100 1/8	19	6	VSB10223MBTK1	COM \$742 A \$760 B \$797 C \$860 D \$940 E \$1,022 F \$1,148 G \$1,285 H \$1,429 I \$1,656 J \$1,927
--	-----	----	---------	----	---	---------------	---

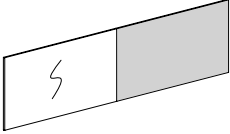
· for use with 102" w overhead
· com ydg: 1 3/4

Half Markerboard/Half Tackboard for Front of 96" w Storage Overhead Cabinet	1/2	23	94 1/8	18	6	VSB9623MBTK1	COM \$725 A \$741 B \$771 C \$826 D \$896 E \$965 F \$1,075 G \$1,191 H \$1,315 I \$1,508 J \$1,742
---	-----	----	--------	----	---	--------------	---

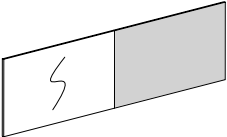
· for use with 96" w overhead
· com ydg: 1 1/2

Half Markerboard/Half Tackboard for Front of 90" w Storage Overhead Cabinet	1/2	23	88 1/8	17	6	VSB9023MBTK1	COM \$706 A \$722 B \$753 C \$806 D \$877 E \$948 F \$1,055 G \$1,172 H \$1,296 I \$1,489 J \$1,722
---	-----	----	--------	----	---	--------------	---

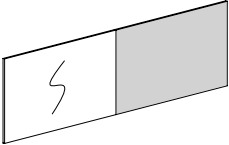
· for use with 90" w overhead
· com ydg: 1 1/2

Description	D	W	H	CTN WT	CU FT	① Model	List Price Per Grade
Half Markerboard/Half Tackboard for Front of 84" w Storage Overhead Cabinet 	1/2	23	82 1/8	16	5	VSB8423MBTK1	COM \$688 A \$703 B \$734 C \$788 D \$856 E \$928 F \$1,037 G \$1,152 H \$1,277 I \$1,470 J \$1,704

- for use with 84" w overhead
- com ydg: 1 1/2

Half Markerboard/Half Tackboard for Front of 78" w Storage Overhead Cabinet 	1/2	23	76 1/8	15	5	VSB7823MBTK1	COM \$668 A \$680 B \$706 C \$753 D \$810 E \$868 F \$959 G \$1,055 H \$1,160 I \$1,321 J \$1,514
--	-----	----	--------	----	---	--------------	---

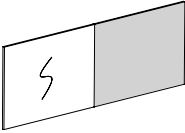
- for use with 78" w overhead
- com ydg: 1 1/4

Half Markerboard/Half Tackboard for Front of 72" w Storage Overhead Cabinet 	1/2	23	70 1/8	14	5	VSB7223MBTK1	COM \$649 A \$662 B \$688 C \$734 D \$791 E \$849 F \$939 G \$1,037 H \$1,140 I \$1,301 J \$1,496
--	-----	----	--------	----	---	--------------	---

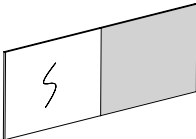
- for use with 72" w overhead
- com ydg: 1 1/4

To Order, Specify:

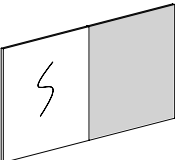
- ① Model Number
- ② Fabric Selection: vendor, pattern, color
Visit www.jsifurniture.com/finishes-and-materials/textiles
for our textiles program. See selection of standard and
graded in manufacturers and patterns.

Description	D	W	H	CTN WT	CU FT	① Model	List Price Per Grade
Half Markerboard/Half Tackboard for Front of 66" w Storage Overhead Cabinet 	1/2	23	64 1/8	13	4	VSB6623MBTK1	COM \$639 A \$652 B \$678 C \$724 D \$782 E \$840 F \$930 G \$1,027 H \$1,130 I \$1,293 J \$1,487

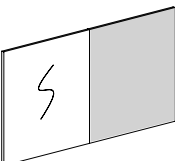
- for use with 66" w overhead
- com ydg: 1 1/4

Half Markerboard/Half Tackboard for Front of 60" w Storage Overhead Cabinet 	1/2	23	58 1/8	12	4	VSB6023MBTK1	COM \$620 A \$631 B \$651 C \$688 D \$735 E \$781 F \$853 G \$930 H \$1,014 I \$1,142 J \$1,298
---	-----	----	--------	----	---	--------------	---

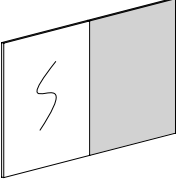
- for use with 60" w overhead
- com ydg: 1

Half Markerboard/Half Tackboard for Front of 54" w Storage Overhead Cabinet 	1/2	23	52 1/8	10	4	VSB5423MBTK1	COM \$601 A \$612 B \$632 C \$669 D \$715 E \$762 F \$834 G \$912 H \$995 I \$1,124 J \$1,279
---	-----	----	--------	----	---	--------------	---

- for use with 54" w overhead
- com ydg: 1

Half Markerboard/Half Tackboard for Front of 48" w Storage Overhead Cabinet 	1/2	23	46 1/8	9	3	VSB4823MBTK1	COM \$583 A \$593 B \$613 C \$650 D \$695 E \$743 F \$814 G \$892 H \$975 I \$1,104 J \$1,260
---	-----	----	--------	---	---	--------------	---

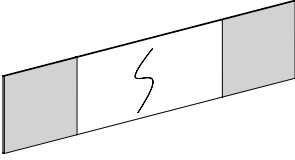
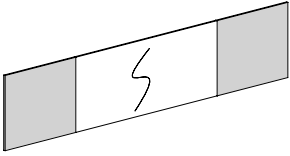
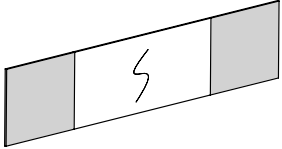
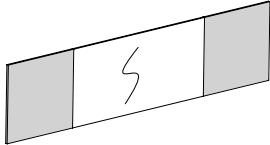
- for use with 48" w overhead
- com ydg: 1

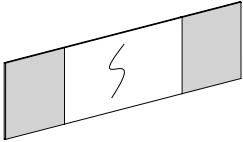
Description	D	W	H	CTN WT	CU FT	① Model	List Price Per Grade
Half Markerboard/Half Tackboard for Front of 42" w Storage Overhead Cabinet 	1/2	23	40 1/8	8	3	VSB4223MBTK1	COM \$564 A \$573 B \$594 C \$631 D \$677 E \$724 F \$797 G \$874 H \$956 I \$1,086 J \$1,240

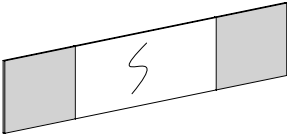
- for use with 42" w overhead
- com ydg: 1

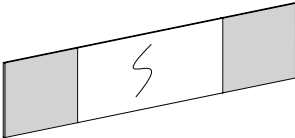
To Order, Specify:

- ① Model Number
- ② Fabric Selection: vendor, pattern, color
 Visit www.jsifurniture.com/finishes-and-materials/textiles
 for our textiles program. See selection of standard and
 graded in manufacturers and patterns.

Description	D	W	H	CTN WT	CU FT	① Model	List Price Per Grade
Center Markerboard/Left and Right Tackboard for Front of 108" w Storage Overhead Cabinet  <ul style="list-style-type: none"> · for use with 108" w overhead · com ydg: 1 3/4 	1/2	23	106 1/8	21	7	VSB10823MBTK2	COM \$836 A \$856 B \$898 C \$971 D \$1,063 E \$1,157 F \$1,301 G \$1,457 H \$1,622 I \$1,880 J \$2,192
Center Markerboard/Left and Right Tackboard for Front of 102" w Storage Overhead Cabinet  <ul style="list-style-type: none"> · for use with 102" w overhead · com ydg: 1 3/4 	1/2	23	100 1/8	19	6	VSB10223MBTK2	COM \$819 A \$839 B \$874 C \$937 D \$1,018 E \$1,100 F \$1,227 G \$1,363 H \$1,508 I \$1,734 J \$2,005
Center Markerboard/Left and Right Tackboard for Front of 96" w Storage Overhead Cabinet  <ul style="list-style-type: none"> · for use with 96" w overhead · com ydg: 1 3/4 	1/2	23	94 1/8	18	6	VSB9623MBTK2	COM \$776 A \$793 B \$830 C \$893 D \$975 E \$1,057 F \$1,183 G \$1,320 H \$1,463 I \$1,689 J \$1,961
Center Markerboard/Left and Right Tackboard for Front of 90" w Storage Overhead Cabinet  <ul style="list-style-type: none"> · for use with 90" w overhead · com ydg: 1 3/4 	1/2	23	88 1/8	17	6	VSB9023MBTK2	COM \$757 A \$775 B \$811 C \$875 D \$956 E \$1,038 F \$1,164 G \$1,299 H \$1,445 I \$1,670 J \$1,943

Description	D	W	H	CTN WT	CU FT	① Model	List Price Per Grade
Center Markerboard/Left and Right Tackboard for Front of 84" w Storage Overhead Cabinet  <ul style="list-style-type: none"> · for use with 84" w overhead · com ydg: 1 1/2 	1/2	23	82 1/8	16	5	VSB8423MBTK2	COM \$738 A \$754 B \$785 C \$839 D \$909 E \$978 F \$1,087 G \$1,204 H \$1,327 I \$1,521 J \$1,754

Center Markerboard/Left and Right Tackboard for Front of 78" w Storage Overhead Cabinet  <ul style="list-style-type: none"> · for use with 78" w overhead · com ydg: 1 1/2 	1/2	23	76 1/8	15	5	VSB7823MBTK2	COM \$718 A \$735 B \$765 C \$819 D \$889 E \$960 F \$1,068 G \$1,184 H \$1,308 I \$1,502 J \$1,735
--	-----	----	--------	----	---	--------------	---

Center Markerboard/Left and Right Tackboard for Front of 72" w Storage Overhead Cabinet  <ul style="list-style-type: none"> · for use with 72" w overhead · com ydg: 1 1/2 	1/2	23	70 1/8	14	5	VSB7223MBTK2	COM \$700 A \$716 B \$747 C \$801 D \$871 E \$939 F \$1,049 G \$1,165 H \$1,290 I \$1,484 J \$1,715
--	-----	----	--------	----	---	--------------	---

To Order, Specify:

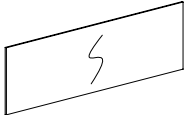
- ① Model Number
- ② Fabric Selection: vendor, pattern, color
 Visit www.jsifurniture.com/finishes-and-materials/textiles for our textiles program. See selection of standard and graded in manufacturers and patterns.

Description	D	W	H	CTN WT	CU FT	① Model	List Price Per Grade
Center Markerboard/Left and Right Tackboard for Front of 66" w Storage Overhead Cabinet	1/2	23	64 1/8	13	4	VSB6623MBTK2	COM \$680 A \$693 B \$719 C \$765 D \$824 E \$881 F \$972 G \$1,068 H \$1,172 I \$1,334 J \$1,529

· for use with 66" w overhead
· com ydg: 1 1/4

Center Markerboard/Left and Right Tackboard for Front of 60" w Storage Overhead Cabinet	1/2	23	58 1/8	12	4	VSB6023MBTK2	COM \$662 A \$675 B \$701 C \$745 D \$804 E \$863 F \$953 G \$1,049 H \$1,153 I \$1,315 J \$1,508
---	-----	----	--------	----	---	--------------	---

· for use with 60" w overhead
· com ydg: 1 1/4

Description	D	W	H	CTN WT	CU FT	1 Model	List Price
Markerboard for Front of Storage Overhead Cabinet with Cubbies 	1/2	19 1/2	106 1/8	27	7	VSB10820MBC	\$555
	1/2	19 1/2	100 1/8	26	6	VSB10220MBC	\$536
	1/2	19 1/2	94 1/8	24	6	VSB9620MBC	\$514
	1/2	19 1/2	88 1/8	23	6	VSB9020MBC	\$496
	1/2	19 1/2	82 1/8	21	5	VSB8420MBC	\$478
	1/2	19 1/2	76 1/8	20	5	VSB7820MBC	\$458
	1/2	19 1/2	70 1/8	18	5	VSB7220MBC	\$419
	1/2	19 1/2	64 1/8	17	4	VSB6620MBC	\$399
	1/2	19 1/2	58 1/8	15	4	VSB6020MBC	\$379
	1/2	19 1/2	52 1/8	14	4	VSB5420MBC	\$357
	1/2	19 1/2	46 1/8	12	3	VSB4820MBC	\$318
	1/2	19 1/2	40 1/8	11	3	VSB4220MBC	\$298
	1/2	19 1/2	34 1/8	9	3	VSB3620MBC	\$278
	1/2	19 1/2	28 1/8	8	2	VSB3020MBC	\$258

· use with standard storage overhead with cubbies

To Order, Specify:

1 Model Number	Laminate - VST	Veneer - VSV	
	<p>2 Worksurface Material (see page VI3)</p> <p>a.) TFL</p> <p>b.) HPL</p> <p>3 Laminate Color (see page VI3)</p> <p>a.) Worksurface Color</p> <p>b.) Chassis Color</p> <p>c.) Drawer Color</p>	<p>2 Wood Species - Cherry (CH1), Maple (MA1) Walnut (WA1), Black Oak (BO1) or Double Cut (DC1) (see page VI1)</p> <p>3 Finish Color (see page VI1)</p>	<p>4 Edge Profile (see page VI4)</p> <p>5 Pull Style and Color (see page VI5)</p> <p>6 Optional Grommet Location & Color - Matte Black (MBK) or Arctic Silver (ASL) (see page VI6)</p> <p>7 Other Product Options (see page VI10)</p> <p>8 Accessories (see page VS314)</p> <p>9 Power and Data Options (see page VS324)</p>

Description	D	W	H	CTN WT	CU FT	① Model	List Price Per Grade
Half Markerboard/Half Tackboard for Front of 108" w Storage Overhead Cabinet with Cubbies	1/2	19 1/2	106 1/8	18	7	VSB10820MBTK1C	COM \$694 A \$714 B \$749 C \$812 D \$893 E \$975 F \$1,102 G \$1,238 H \$1,383 I \$1,610 J \$1,880
<ul style="list-style-type: none"> · for use with 108" w overhead with cubbies · com ydg: 1 3/4 							

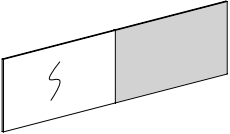
Half Markerboard/Half Tackboard for Front of 102" w Storage Overhead Cabinet with Cubbies	1/2	19 1/2	100 1/8	17	6	VSB10220MBTK1C	COM \$680 A \$700 B \$735 C \$799 D \$879 E \$961 F \$1,088 G \$1,224 H \$1,369 I \$1,595 J \$1,867
<ul style="list-style-type: none"> · for use with 102" w overhead with cubbies · com ydg: 1 3/4 							

Half Markerboard/Half Tackboard for Front of 96" w Storage Overhead Cabinet with Cubbies	1/2	19 1/2	94 1/8	16	6	VSB9620MBTK1C	COM \$667 A \$682 B \$714 C \$767 D \$837 E \$907 F \$1,015 G \$1,132 H \$1,256 I \$1,450 J \$1,683
<ul style="list-style-type: none"> · for use with 96" w overhead with cubbies · com ydg: 1 1/2 							

Half Markerboard/Half Tackboard for Front of 90" w Storage Overhead Cabinet with Cubbies	1/2	19 1/2	88 1/8	15	6	VSB9020MBTK1C	COM \$650 A \$667 B \$697 C \$751 D \$822 E \$890 F \$999 G \$1,115 H \$1,239 I \$1,433 J \$1,666
<ul style="list-style-type: none"> · for use with 90" w overhead with cubbies · com ydg: 1 1/2 							

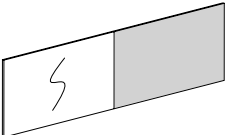
Description	D	W	H	CTN WT	CU FT	① Model	List Price Per Grade
Half Markerboard/Half Tackboard for Front of 84" w Storage Overhead Cabinet with Cubbies	1/2	19 1/2	82 1/8	14	5	VSB8420MBTK1C	COM \$633 A \$649 B \$680 C \$735 D \$804 E \$874 F \$982 G \$1,099 H \$1,222 I \$1,418 J \$1,649

· for use with 84" w overhead with cubbies
· com ydg: 1 1/4



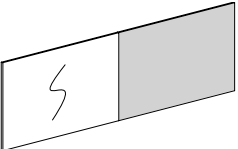
Half Markerboard/Half Tackboard for Front of 78" w Storage Overhead Cabinet with Cubbies	1/2	19 1/2	76 1/8	13	5	VSB7820MBTK1C	COM \$617 A \$630 B \$655 C \$702 D \$760 E \$817 F \$909 G \$1,004 H \$1,109 I \$1,270 J \$1,464
--	-----	--------	--------	----	---	---------------	---

· for use with 78" w overhead with cubbies
· com ydg: 1 1/4



Half Markerboard/Half Tackboard for Front of 72" w Storage Overhead Cabinet with Cubbies	1/2	19 1/2	70 1/8	12	5	VSB7220MBTK1C	COM \$600 A \$613 B \$639 C \$685 D \$743 E \$801 F \$891 G \$989 H \$1,091 I \$1,253 J \$1,448
--	-----	--------	--------	----	---	---------------	---

· for use with 72" w overhead with cubbies
· com ydg: 1 1/4



To Order, Specify:

- ① Model Number
- ② Fabric Selection: vendor, pattern, color
Visit www.jsifurniture.com/finishes-and-materials/textiles
for our textiles program. See selection of standard and
graded in manufacturers and patterns.

Description	D	W	H	CTN WT	CU FT	① Model	List Price Per Grade
Half Markerboard/Half Tackboard for Front of 66" w Storage Overhead Cabinet with Cubbies	1/2	19 1/2	64 1/8	11	4	VSB6620MBTK1C	COM \$593 A \$606 B \$632 C \$678 D \$736 E \$793 F \$885 G \$980 H \$1,085 I \$1,247 J \$1,442
<ul style="list-style-type: none"> · for use with 66" w overhead with cubbies · com ydg: 1 1/4 							

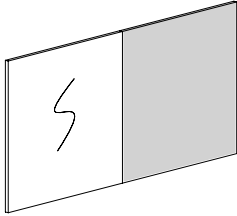
Half Markerboard/Half Tackboard for Front of 60" w Storage Overhead Cabinet with Cubbies	1/2	19 1/2	58 1/8	10	4	VSB6020MBTK1C	COM \$577 A \$588 B \$608 C \$643 D \$691 E \$737 F \$810 G \$887 H \$971 I \$1,099 J \$1,254
<ul style="list-style-type: none"> · for use with 60" w overhead with cubbies · com ydg: 1 							

Half Markerboard/Half Tackboard for Front of 54" w Storage Overhead Cabinet with Cubbies	1/2	19 1/2	52 1/8	9	4	VSB5420MBTK1C	COM \$561 A \$570 B \$592 C \$628 D \$675 E \$720 F \$793 G \$871 H \$954 I \$1,083 J \$1,238
<ul style="list-style-type: none"> · for use with 54" w overhead with cubbies · com ydg: 1 							

Half Markerboard/Half Tackboard for Front of 48" w Storage Overhead Cabinet with Cubbies	1/2	19 1/2	46 1/8	8	3	VSB4820MBTK1C	COM \$544 A \$554 B \$576 C \$611 D \$658 E \$704 F \$777 G \$853 H \$937 I \$1,065 J \$1,221
<ul style="list-style-type: none"> · for use with 48" w overhead with cubbies · com ydg: 1 							

Description	D	W	H	CTN WT	CU FT	① Model	List Price Per Grade
Half Markerboard/Half Tackboard for Front of 42" w Storage Overhead Cabinet with Cubbies	1/2	19 1/2	40 1/8	7	3	VSB4220MBTK1C	COM \$527 A \$539 B \$557 C \$594 D \$641 E \$688 F \$761 G \$837 H \$921 I \$1,049 J \$1,206

- for use with 42" w overhead with cubbies
- com ydg: 1

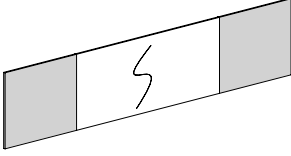


To Order, Specify:

- ① Model Number
- ② Fabric Selection: vendor, pattern, color
Visit www.jsifurniture.com/finishes-and-materials/textiles
for our textiles program. See selection of standard and
graded in manufacturers and patterns.

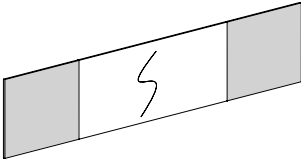
Description	D	W	H	CTN WT	CU FT	① Model	List Price Per Grade
Center Markerboard/Left and Right Tackboard for Front of 108" w Storage Overhead Cabinet with Cubbies	1/2	19 1/2	106 1/8	17	6	VSB10820MBTK2C	COM \$772 A \$793 B \$835 C \$909 D \$1,001 E \$1,094 F \$1,238 G \$1,393 H \$1,558 I \$1,818 J \$2,128

· for use with 108" w overhead with cubbies
· com ydg: 1 3/4



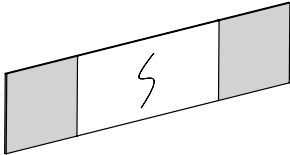
Center Markerboard/Left and Right Tackboard for Front of 102" w Storage Overhead Cabinet with Cubbies	1/2	19 1/2	100 1/8	17	6	VSB10220MBTK2C	COM \$760 A \$777 B \$813 C \$876 D \$958 E \$1,040 F \$1,166 G \$1,301 H \$1,447 I \$1,672 J \$1,944
---	-----	--------	---------	----	---	----------------	---

· for use with 102" w overhead with cubbies
· com ydg: 1 3/4



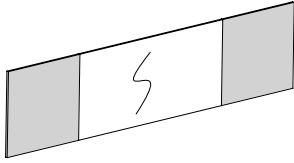
Center Markerboard/Left and Right Tackboard for Front of 96" w Storage Overhead Cabinet with Cubbies	1/2	19 1/2	94 1/8	16	6	VSB9620MBTK2C	COM \$717 A \$736 B \$772 C \$835 D \$916 E \$998 F \$1,125 G \$1,260 H \$1,406 I \$1,632 J \$1,903
--	-----	--------	--------	----	---	---------------	---

· for use with 96" w overhead with cubbies
· com ydg: 1 3/4



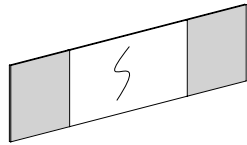
Description	D	W	H	CTN WT	CU FT	① Model	List Price Per Grade
Center Markerboard/Left and Right Tackboard for Front of 90" w Storage Overhead Cabinet with Cubbies	1/2	19 1/2	88 1/8	15	6	VSB9020MBTK2C	COM \$701 A \$719 B \$755 C \$818 D \$899 E \$980 F \$1,109 G \$1,244 H \$1,388 I \$1,616 J \$1,885

- for use with 90" w overhead with cubbies
- com ydg: 1 3/4



Center Markerboard/Left and Right Tackboard for Front of 84" w Storage Overhead Cabinet with Cubbies	1/2	19 1/2	82 1/8	14	5	VSB8420MBTK2C	COM \$683 A \$701 B \$731 C \$786 D \$854 E \$925 F \$1,034 G \$1,150 H \$1,274 I \$1,468 J \$1,700
--	-----	--------	--------	----	---	---------------	---

- for use with 84" w overhead with cubbies
- com ydg: 1 1/2

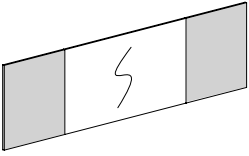


To Order, Specify:

- ① Model Number
- ② Fabric Selection: vendor, pattern, color
Visit www.jsifurniture.com/finishes-and-materials/textiles for our textiles program. See selection of standard and graded in manufacturers and patterns.

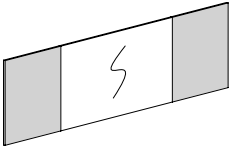
Description	D	W	H	CTN WT	CU FT	① Model	List Price Per Grade
Center Markerboard/Left and Right Tackboard for Front of 78" w Storage Overhead Cabinet with Cubbies	1/2	19 1/2	76 1/8	13	5	VSB7820MBTK2C	COM \$668 A \$683 B \$715 C \$768 D \$839 E \$909 F \$1,016 G \$1,133 H \$1,257 I \$1,451 J \$1,684

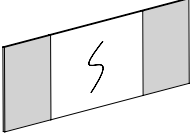
· for use with 78" w overhead with cubbies
· com ydg: 1 1/2

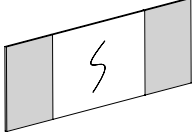


Center Markerboard/Left and Right Tackboard for Front of 72" w Storage Overhead Cabinet with Cubbies	1/2	19 1/2	70 1/8	12	5	VSB7220MBTK2C	COM \$651 A \$667 B \$699 C \$753 D \$823 E \$891 F \$1,000 G \$1,117 H \$1,240 I \$1,434 J \$1,667
--	-----	--------	--------	----	---	---------------	---

· for use with 72" w overhead with cubbies
· com ydg: 1 1/2

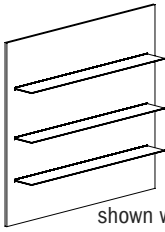


Description	D	W	H	CTN WT	CU FT	① Model	List Price Per Grade
Center Markerboard/Left and Right Tackboard for Front of 66" w Storage Overhead Cabinet with Cubbies <ul style="list-style-type: none"> for use with 66" w overhead with cubbies com ydg: 1 1/4 	1/2	19 1/2	64 1/8	11	4	VSB6620MBTK2C	COM \$635 A \$648 B \$674 C \$719 D \$777 E \$835 F \$926 G \$1,022 H \$1,126 I \$1,288 J \$1,483

Center Markerboard/Left and Right Tackboard for Front of 60" w Storage Overhead Cabinet with Cubbies <ul style="list-style-type: none"> for use with 60" w overhead with cubbies com ydg: 1 1/4 	1/2	19 1/2	58 1/8	10	4	VSB6020MBTK2C	COM \$618 A \$631 B \$656 C \$703 D \$761 E \$818 F \$910 G \$1,005 H \$1,110 I \$1,271 J \$1,465
--	-----	--------	--------	----	---	---------------	--

To Order, Specify:

- ① Model Number
- ② Fabric Selection: vendor, pattern, color
 Visit www.jsifurniture.com/finishes-and-materials/textiles for our textiles program. See selection of standard and graded in manufacturers and patterns.



54 1/2" h Wall Panel with Glass Shelf

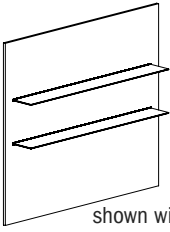
- use with standard height surfaces for 84" overall height (nothing above)
- specify number of shelves, shelf locations, shelf color (contrasting shelves on laminate models only)
- reference planning pages for shelf location options

shown with three shelves

Model	One Shelf			Two Shelves			Three Shelves			D	W	H	CTN WT	CU FT
	Laminate	Flat Cut Veneer	Dble Cut Veneer	Laminate	Flat Cut Veneer	Dble Cut Veneer	Laminate	Flat Cut Veneer	Dble Cut Veneer					
VST6054WPGS	\$1,184			\$1,871			\$2,558			7 15/16	60	54 1/2	102	21
VSV6054WPGS		\$1,562	\$1,640		\$2,248	\$2,327		\$2,935	\$3,014	7 15/16	60	54 1/2	102	21
VST5454WPGS	\$1,075			\$1,686			\$2,298			7 15/16	54	54 1/2	92	19
VSV5454WPGS		\$1,438	\$1,510		\$2,049	\$2,122		\$2,661	\$2,734	7 15/16	54	54 1/2	92	19
VST4854WPGS	\$949			\$1,486			\$2,024			7 15/16	48	54 1/2	82	17
VSV4854WPGS		\$1,298	\$1,364		\$1,835	\$1,901		\$2,373	\$2,439	7 15/16	48	54 1/2	82	17
VST4254WPGS	\$832			\$1,294			\$1,757			7 15/16	42	54 1/2	72	15
VSV4254WPGS		\$1,167	\$1,225		\$1,630	\$1,689		\$2,093	\$2,151	7 15/16	42	54 1/2	72	15
VST3954WPGS	\$790			\$1,224			\$1,658			7 15/16	39	54 1/2	66	14
VSV3954WPGS		\$1,119	\$1,175		\$1,552	\$1,609		\$1,987	\$2,043	7 15/16	39	54 1/2	66	14
VST3654WPGS	\$721			\$1,109			\$1,497			7 15/16	36	54 1/2	63	13
VSV3654WPGS		\$1,043	\$1,095		\$1,430	\$1,483		\$1,819	\$1,871	7 15/16	36	54 1/2	63	13
VST3354WPGS	\$679			\$1,039			\$1,398			7 15/16	33	54 1/2	57	12
VSV3354WPGS		\$994	\$1,044		\$1,353	\$1,404		\$1,712	\$1,762	7 15/16	33	54 1/2	57	12
VST3054WPGS	\$612			\$926			\$1,240			7 15/16	30	54 1/2	54	11
VSV3054WPGS		\$920	\$966		\$1,234	\$1,280		\$1,548	\$1,594	7 15/16	30	54 1/2	54	11
VST2454WPGS	\$476			\$690			\$905			7 15/16	24	54 1/2	44	9
VSV2454WPGS		\$770	\$809		\$984	\$1,023		\$1,199	\$1,238	7 15/16	24	54 1/2	44	9
VST1854WPGS	\$397			\$562			\$727			7 15/16	18	54 1/2	34	7
VSV1854WPGS		\$678	\$713		\$843	\$878		\$1,008	\$1,043	7 15/16	18	54 1/2	34	7

To Order, Specify:

- | | | | |
|---|---|---|--|
| <p>1 Model Number</p> | <p>Laminate - VST</p> | <p>Veneer - VSV</p> | <p>4 Edge Profile (see page VI4)</p> |
| <p>2 Worksurface Material (see page VI3)</p> <p>a.) TFL</p> <p>b.) HPL</p> | <p>3 Laminate Color (see page VI3)</p> <p>a.) Worksurface Color</p> <p>b.) Chassis Color</p> <p>c.) Drawer Color</p> | <p>2 Wood Species - Cherry (CH1), Maple (MA1)
Walnut (WA1), Black Oak (BO1) or
Double Cut (DC1) (see page VI1)</p> <p>3 Finish Color (see page VI1)</p> | <p>5 Pull Style and Color (see page VI4)</p> <p>6 Optional Grommet Location & Color -
Matte Black (MBK) or Arctic Silver (ASL)
(see page VI6)</p> <p>7 Other Product Options (see page VI10)</p> <p>8 Accessories (see page VS314)</p> <p>9 Power and Data Options (see page VS324)</p> |



52 3/16" h Wall Panel with Glass Shelf

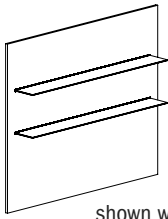
- use with bench height surfaces for 72" overall height (nothing above)
- specify number of shelves, shelf locations, shelf color (contrasting shelves on laminate models only)
- reference planning pages for shelf location options

shown with two shelves

Model	One Shelf			Two Shelves			D	W	H	CTN WT	CU FT
	Laminate	Flat Cut Veneer	Dble Cut Veneer	Laminate	Flat Cut Veneer	Dble Cut Veneer					
VST6053WPGS	\$1,174			\$1,861			7 15/16	60	52 3/16	90	20
VSV6053WPGS		\$1,546	\$1,624		\$2,232	\$2,310	7 15/16	60	52 3/16	90	20
VST453WPGS	\$1,065			\$1,677			7 15/16	54	52 3/16	81	18
VSV453WPGS		\$1,423	\$1,495		\$2,035	\$2,107	7 15/16	54	52 3/16	81	18
VST4853WPGS	\$940			\$1,479			7 15/16	48	52 3/16	72	16
VSV4853WPGS		\$1,285	\$1,349		\$1,823	\$1,888	7 15/16	48	52 3/16	72	16
VST4253WPGS	\$825			\$1,288			7 15/16	42	52 3/16	63	14
VSV4253WPGS		\$1,157	\$1,215		\$1,619	\$1,677	7 15/16	42	52 3/16	63	14
VST3953WPGS	\$784			\$1,218			7 15/16	39	52 3/16	58	13
VSV3953WPGS		\$1,109	\$1,165		\$1,543	\$1,599	7 15/16	39	52 3/16	58	13
VST3653WPGS	\$715			\$1,103			7 15/16	36	52 3/16	55	12
VSV3653WPGS		\$1,034	\$1,086		\$1,421	\$1,473	7 15/16	36	52 3/16	55	12
VST3353WPGS	\$674			\$1,033			7 15/16	33	52 3/16	50	11
VSV3353WPGS		\$986	\$1,036		\$1,344	\$1,394	7 15/16	33	52 3/16	50	11
VST3053WPGS	\$607			\$921			7 15/16	30	52 3/16	47	10
VSV3053WPGS		\$913	\$959		\$1,226	\$1,273	7 15/16	30	52 3/16	47	10
VST2453WPGS	\$473			\$686			7 15/16	24	52 3/16	38	9
VSV2453WPGS		\$764	\$803		\$978	\$1,017	7 15/16	24	52 3/16	38	9
VST1853WPGS	\$394			\$559			7 15/16	18	52 3/16	29	7
VSV1853WPGS		\$673	\$707		\$838	\$872	7 15/16	18	52 3/16	29	7

To Order, Specify:

- | | | | |
|---|---|--|--|
| <p>① Model Number</p> | <p>Laminate - VST</p> | <p>Veneer - VSV</p> | |
| <p>② Worksurface Material (see page VI3)</p> <p>a.) TFL</p> <p>b.) HPL</p> <p>③ Laminate Color (see page VI3)</p> <p>a.) Worksurface Color</p> <p>b.) Chassis Color</p> <p>c.) Drawer Color</p> | <p>② Wood Species - Cherry (CH1), Maple (MA1)</p> <p>Walnut (WA1), Black Oak (BO1) or</p> <p>Double Cut (DC1) (see page VI1)</p> <p>③ Finish Color (see page VI1)</p> | <p>④ Edge Profile (see page VI4)</p> <p>⑤ Pull Style and Color (see page VI5)</p> <p>⑥ Optional Grommet Location & Color -</p> <p>Matte Black (MBK) or Arctic Silver (ASL)</p> <p>(see page VI6)</p> <p>⑦ Other Product Options (see page VI10)</p> <p>⑧ Accessories (see page VS314)</p> <p>⑨ Power and Data Options (see page VS324)</p> | |



49 1/16" h Wall Panel with Glass Shelf

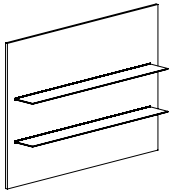
- use with bench height surfaces and 14 3/4" h L-shelf for 84" overall height
- specify number of shelves, shelf locations, shelf color (contrasting shelves on laminate models only)
- reference planning pages for shelf location options

shown with two shelves

Model	One Shelf			Two Shelves			D	W	H	CTN WT	CU FT
	Laminate	Flat Cut Veneer	Dble Cut Veneer	Laminate	Flat Cut Veneer	Dble Cut Veneer					
VST6050WPGS	\$1,158			\$1,844			7 15/16	60	49 11/16	88	19
VSV6050WPGS		\$1,522	\$1,598		\$2,208	\$2,285	7 15/16	60	49 11/16	88	19
VST5450WPGS	\$1,050			\$1,662			7 15/16	54	49 11/16	79	17
VSV5450WPGS		\$1,402	\$1,472		\$2,014	\$2,084	7 15/16	54	49 11/16	79	17
VST4850WPGS	\$926			\$1,464			7 15/16	48	49 11/16	70	15
VSV4850WPGS		\$1,265	\$1,329		\$1,803	\$1,867	7 15/16	48	49 11/16	70	15
VST4250WPGS	\$812			\$1,276			7 15/16	42	49 11/16	61	14
VSV4250WPGS		\$1,139	\$1,197		\$1,602	\$1,659	7 15/16	42	49 11/16	61	14
VST3950WPGS	\$772			\$1,206			7 15/16	39	49 11/16	56	13
VSV3950WPGS		\$1,092	\$1,147		\$1,527	\$1,582	7 15/16	39	49 11/16	56	13
VST3650WPGS	\$705			\$1,092			7 15/16	36	49 11/16	53	12
VSV3650WPGS		\$1,018	\$1,070		\$1,407	\$1,458	7 15/16	36	49 11/16	53	12
VST3350WPGS	\$664			\$1,023			7 15/16	33	49 11/16	48	11
VSV3350WPGS		\$972	\$1,021		\$1,331	\$1,380	7 15/16	33	49 11/16	48	11
VST3050WPGS	\$598			\$912			7 15/16	30	49 11/16	45	10
VSV3050WPGS		\$899	\$945		\$1,214	\$1,259	7 15/16	30	49 11/16	45	10
VST2450WPGS	\$465			\$679			7 15/16	24	49 11/16	36	8
VSV2450WPGS		\$754	\$792		\$968	\$1,006	7 15/16	24	49 11/16	36	8
VST1850WPGS	\$388			\$553			7 15/16	18	49 11/16	27	6
VSV1850WPGS		\$665	\$699		\$830	\$864	7 15/16	18	49 11/16	27	6

To Order, Specify:

- | | | |
|------------------------------|-----------------------|---------------------|
| <p>1 Model Number</p> | <p>Laminate - VST</p> | <p>Veneer - VSV</p> |
|------------------------------|-----------------------|---------------------|
-
- | | | |
|---|---|---|
| <p>2 Worksurface Material (see page VI3)</p> <p>a.) TFL</p> <p>b.) HPL</p> | <p>2 Wood Species - Cherry (CH1), Maple (MA1)</p> <p>Walnut (WA1), Black Oak (BO1) or</p> <p>Double Cut (DC1) (see page VI1)</p> | <p>4 Edge Profile (see page VI4)</p> |
| <p>3 Laminate Color (see page VI3)</p> <p>a.) Worksurface Color</p> <p>b.) Chassis Color</p> <p>c.) Drawer Color</p> | <p>3 Finish Color (see page VI1)</p> | <p>5 Pull Style and Color (see page VI4)</p> |
| | | <p>6 Optional Grommet Location & Color -</p> <p>Matte Black (MBK) or Arctic Silver (ASL)</p> <p>(see page VI6)</p> |
| | | <p>7 Other Product Options (see page VI10)</p> |
| | | <p>8 Accessories (see page VS314)</p> |
| | | <p>9 Power and Data Options (see page VS324)</p> |



42 1/2" h Wall Panel with Glass Shelf

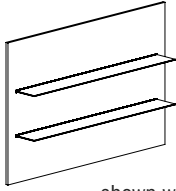
- use with standard height surfaces for 72" overall height (nothing above)
- specify number of shelves, shelf locations, shelf color (contrasting shelves on laminate models only)
- reference planning pages for shelf location options

shown with two shelves

Model	One Shelf			Two Shelves			D	W	H	CTN WT	CU FT
	Laminate	Flat Cut Veneer	Dble Cut Veneer	Laminate	Flat Cut Veneer	Dble Cut Veneer					
VST6042WPGS	\$1,128			\$1,815			7 15/16	60	42 1/2	79	16
VSV6042WPGS		\$1,474	\$1,548		\$2,161	\$2,235	7 15/16	60	42 1/2	79	16
VST5442WPGS	\$1,023			\$1,635			7 15/16	54	42 1/2	71	15
VSV5442WPGS		\$1,360	\$1,428		\$1,972	\$2,040	7 15/16	54	42 1/2	71	15
VST4842WPGS	\$904			\$1,441			7 15/16	48	42 1/2	63	13
VSV4842WPGS		\$1,228	\$1,290		\$1,766	\$1,827	7 15/16	48	42 1/2	63	13
VST4242WPGS	\$792			\$1,254			7 15/16	42	42 1/2	56	12
VSV4242WPGS		\$1,106	\$1,162		\$1,569	\$1,624	7 15/16	42	42 1/2	56	12
VST3942WPGS	\$753			\$1,187			7 15/16	39	42 1/2	51	11
VSV3942WPGS		\$1,061	\$1,115		\$1,496	\$1,549	7 15/16	39	42 1/2	51	11
VST3642WPGS	\$687			\$1,075			7 15/16	36	42 1/2	48	10
VSV3642WPGS		\$991	\$1,041		\$1,378	\$1,428	7 15/16	36	42 1/2	48	10
VST3342WPGS	\$647			\$1,007			7 15/16	33	42 1/2	43	9
VSV3342WPGS		\$946	\$994		\$1,305	\$1,353	7 15/16	33	42 1/2	43	9
VST3042WPGS	\$584			\$897			7 15/16	30	42 1/2	40	9
VSV3042WPGS		\$876	\$920		\$1,189	\$1,234	7 15/16	30	42 1/2	40	9
VST2442WPGS	\$454			\$667			7 15/16	24	42 1/2	33	7
VSV2442WPGS		\$735	\$772		\$950	\$987	7 15/16	24	42 1/2	33	7
VST1842WPGS	\$379			\$544			7 15/16	18	42 1/2	25	6
VSV1842WPGS		\$650	\$683		\$815	\$848	7 15/16	18	42 1/2	25	6

To Order, Specify:

- | | | |
|------------------------------|-----------------------|---------------------|
| <p>1 Model Number</p> | <p>Laminate - VST</p> | <p>Veneer - VSV</p> |
|------------------------------|-----------------------|---------------------|
-
- | | | |
|---|---|--|
| <p>2 Worksurface Material (see page VI3)</p> <p>a.) TFL</p> <p>b.) HPL</p> <p>3 Laminate Color (see page VI3)</p> <p>a.) Worksurface Color</p> <p>b.) Chassis Color</p> <p>c.) Drawer Color</p> | <p>2 Wood Species - Cherry (CH1), Maple (MA1)
Walnut (WA1), Black Oak (BO1) or
Double Cut (DC1) (see page VI1)</p> <p>3 Finish Color (see page VI1)</p> | <p>4 Edge Profile (see page VI4)</p> <p>5 Pull Style and Color (see page VI5)</p> <p>6 Optional Grommet Location & Color -
Matte Black (MBK) or Arctic Silver (ASL)
(see page VI6)</p> <p>7 Other Product Options (see page VI10)</p> <p>8 Accessories (see page VS314)</p> <p>9 Power and Data Options (see page VS324)</p> |
|---|---|--|



39 3/4" h Wall Panel with Glass Shelf

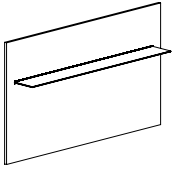
- use with standard height surfaces and 14 3/4" h L-shelf for 84" overall height
- specify number of shelves, shelf locations, shelf color (contrasting shelves on laminate models only)
- reference planning pages for shelf location options

shown with two shelves

Model	One Shelf			Two Shelves			D	W	H	CTN WT	CU FT
	Laminate	Flat Cut Veneer	Dble Cut Veneer	Laminate	Flat Cut Veneer	Dble Cut Veneer					
VST6040WPGS	\$1,112			\$1,797			7 15/16	60	39 3/4	75	15
VSV6040WPGS		\$1,451	\$1,524		\$2,138	\$2,210	7 15/16	60	39 3/4	75	15
VST5440WPGS	\$1,008			\$1,620			7 15/16	54	39 3/4	68	14
VSV5440WPGS		\$1,338	\$1,406		\$1,950	\$2,018	7 15/16	54	39 3/4	68	14
VST4840WPGS	\$889			\$1,427			7 15/16	48	39 3/4	60	13
VSV4840WPGS		\$1,209	\$1,269		\$1,746	\$1,807	7 15/16	48	39 3/4	60	13
VST4240WPGS	\$779			\$1,242			7 15/16	42	39 3/4	53	11
VSV4240WPGS		\$1,089	\$1,144		\$1,551	\$1,607	7 15/16	42	39 3/4	53	11
VST3940WPGS	\$742			\$1,175			7 15/16	39	39 3/4	49	10
VSV3940WPGS		\$1,046	\$1,098		\$1,480	\$1,532	7 15/16	39	39 3/4	49	10
VST3640WPGS	\$676			\$1,063			7 15/16	36	39 3/4	46	10
VSV3640WPGS		\$975	\$1,024		\$1,363	\$1,412	7 15/16	36	39 3/4	46	10
VST3340WPGS	\$638			\$997			7 15/16	33	39 3/4	41	9
VSV3340WPGS		\$932	\$979		\$1,291	\$1,338	7 15/16	33	39 3/4	41	9
VST3040WPGS	\$574			\$888			7 15/16	30	39 3/4	39	8
VSV3040WPGS		\$864	\$908		\$1,177	\$1,221	7 15/16	30	39 3/4	39	8
VST2440WPGS	\$445			\$660			7 15/16	24	39 3/4	31	7
VSV2440WPGS		\$725	\$762		\$938	\$975	7 15/16	24	39 3/4	31	7
VST1840WPGS	\$374			\$539			7 15/16	18	39 3/4	24	5
VSV1840WPGS		\$642	\$675		\$807	\$840	7 15/16	18	39 3/4	24	5

To Order, Specify:

- | | | |
|------------------------------|-----------------------|---------------------|
| <p>1 Model Number</p> | <p>Laminate - VST</p> | <p>Veneer - VSV</p> |
|------------------------------|-----------------------|---------------------|
-
- | | | |
|---|---|--|
| <p>2 Worksurface Material (see page VI3)</p> <p>a.) TFL</p> <p>b.) HPL</p> | <p>2 Wood Species - Cherry (CH1), Maple (MA1)</p> <p>Walnut (WA1), Black Oak (BO1) or</p> <p>Double Cut (DC1) (see page VI1)</p> | <p>4 Edge Profile (see page VI4)</p> |
| <p>3 Laminate Color (see page VI3)</p> <p>a.) Worksurface Color</p> <p>b.) Chassis Color</p> <p>c.) Drawer Color</p> | <p>3 Finish Color (see page VI1)</p> | <p>5 Pull Style and Color (see page VI4)</p> <p>6 Optional Grommet Location & Color -</p> <p>Matte Black (MBK) or Arctic Silver (ASL)</p> <p>(see page VI6)</p> <p>7 Other Product Options (see page VI10)</p> <p>8 Accessories (see page VS314)</p> <p>9 Power and Data Options (see page VS324)</p> |



34 1/16" h Wall Panel with Glass Shelf

- use with bench height surfaces and 17 1/2" h wall mount overhead or L-shelf for 72" overall height
- specify number of shelves, shelf locations, shelf color (contrasting shelves on laminate models only)
- reference planning pages for shelf location options

Model	One Shelf			D	W	H	CTN WT	CU FT
	Laminate	Flat Cut Veneer	Dble Cut Veneer					
VST6035WPGS	\$1,090			7 15/16	60	34 11/16	58	14
VSV6035WPGS		\$1,417	\$1,489	7 15/16	60	34 11/16	58	14
VST5435WPGS	\$990			7 15/16	54	34 11/16	53	12
VSV5435WPGS		\$1,307	\$1,373	7 15/16	54	34 11/16	53	12
VST4835WPGS	\$872			7 15/16	48	34 11/16	48	11
VSV4835WPGS		\$1,181	\$1,241	7 15/16	48	34 11/16	48	11
VST4235WPGS	\$764			7 15/16	42	34 11/16	42	10
VSV4235WPGS		\$1,065	\$1,119	7 15/16	42	34 11/16	42	10
VST3935WPGS	\$727			7 15/16	39	34 11/16	38	9
VSV3935WPGS		\$1,023	\$1,075	7 15/16	39	34 11/16	38	9
VST3635WPGS	\$664			7 15/16	36	34 11/16	36	9
VSV3635WPGS		\$955	\$1,003	7 15/16	36	34 11/16	36	9
VST3335WPGS	\$626			7 15/16	33	34 11/16	33	8
VSV3335WPGS		\$913	\$959	7 15/16	33	34 11/16	33	8
VST3035WPGS	\$563			7 15/16	30	34 11/16	30	7
VSV3035WPGS		\$846	\$889	7 15/16	30	34 11/16	30	7
VST2435WPGS	\$437			7 15/16	24	34 11/16	25	6
VSV2435WPGS		\$711	\$747	7 15/16	24	34 11/16	25	6
VST1835WPGS	\$366			7 15/16	18	34 11/16	19	5
VSV1835WPGS		\$632	\$664	7 15/16	18	34 11/16	19	5

To Order, Specify:

1 Model Number

Laminate - VST

Veneer - VSV

2 Worksurface Material (see page VI3)

- a.) TFL
- b.) HPL

3 Laminate Color (see page VI3)

- a.) Worksurface Color
- b.) Chassis Color
- c.) Drawer Color

2 Wood Species - Cherry (CH1), Maple (MA1)

- Walnut (WA1), Black Oak (BO1) or Double Cut (DC1) (see page VI1)

3 Finish Color (see page VI1)

4 Edge Profile (see page VI4)

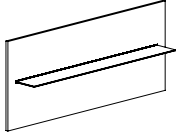
5 Pull Style and Color (see page VI5)

6 Optional Grommet Location & Color - Matte Black (MBK) or Arctic Silver (ASL) (see page VI6)

7 Other Product Options (see page VI10)

8 Accessories (see page VS314)

9 Power and Data Options (see page VS324)



25" h Wall Panel with Glass Shelf

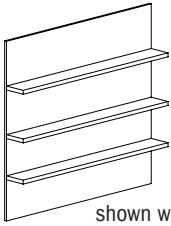
- use with standard height surfaces and 17 ½" h wall mount overhead or L-shelf for 72" overall height
- use with standard height surfaces and 29 ½" h wall mount overhead or L-shelf for 84" overall height
- specify number of shelves, shelf locations, shelf color (contrasting shelves on laminate models only)
- reference planning pages for shelf location options

Model	One Shelf			D	W	H	CTN WT	CU FT
	Laminate	Flat Cut Veneer	Dble Cut Veneer					
VST6025WPGS	\$1,045			7 15/16	60	25	47	10
VSV6025WPGS		\$1,347	\$1,415	7 15/16	60	25	47	10
VST5425WPGS	\$949			7 15/16	54	25	42	9
VSV5425WPGS		\$1,245	\$1,307	7 15/16	54	25	42	9
VST4825WPGS	\$836			7 15/16	48	25	37	8
VSV4825WPGS		\$1,126	\$1,182	7 15/16	48	25	37	8
VST4225WPGS	\$733			7 15/16	42	25	34	7
VSV4225WPGS		\$1,016	\$1,068	7 15/16	42	25	34	7
VST3925WPGS	\$697			7 15/16	39	25	31	7
VSV3925WPGS		\$978	\$1,028	7 15/16	39	25	31	7
VST3625WPGS	\$636			7 15/16	36	25	29	6
VSV3625WPGS		\$913	\$959	7 15/16	36	25	29	6
VST3325WPGS	\$600			7 15/16	33	25	26	6
VSV3325WPGS		\$875	\$919	7 15/16	33	25	26	6
VST3025WPGS	\$541			7 15/16	30	25	24	5
VSV3025WPGS		\$811	\$852	7 15/16	30	25	24	5
VST2425WPGS	\$418			7 15/16	24	25	20	5
VSV2425WPGS		\$682	\$717	7 15/16	24	25	20	5
VST1825WPGS	\$352			7 15/16	18	25	16	4
VSV1825WPGS		\$610	\$641	7 15/16	18	25	16	4

To Order, Specify:

- | | | | |
|--|---|---|---|
| <p>① Model Number</p> | <p>Laminate - VST</p> | <p>Veneer - VSV</p> | <p>④ Edge Profile (see page VI4)</p> |
| <p>② Worksurface Material (see page VI3)</p> <p>a.) TFL</p> <p>b.) HPL</p> | <p>③ Laminates Color (see page VI3)</p> <p>a.) Worksurface Color</p> <p>b.) Chassis Color</p> <p>c.) Drawer Color</p> | <p>③ Wood Species - Cherry (CH1), Maple (MA1) Walnut (WA1), Black Oak (BO1) or Double Cut (DC1) (see page VI1)</p> <p>③ Finish Color (see page VI1)</p> | <p>⑤ Pull Style and Color (see page VI4)</p> <p>⑥ Optional Grommet Location & Color - Matte Black (MBK) or Arctic Silver (ASL) (see page VI6)</p> <p>⑦ Other Product Options (see page VI10)</p> <p>⑧ Accessories (see page VS314)</p> <p>⑨ Power and Data Options (see page VS324)</p> |

left intentionally blank



54 1/2" h Wall Panel

- use with standard height surfaces for 84" overall height (nothing above)
- standard price includes no shelves, see next page for shelf options

shown with three shelves

Model	No Shelves			D	W	H	CTN WT	CU FT
	Laminate	Flat Cut Veneer	Dble Cut Veneer					
VST6054WP	\$489			7 15/16	60	54 1/2	117	21
VSV6054WP		\$867	\$954	7 15/16	60	54 1/2	117	21
VST5454WP	\$456			7 15/16	54	54 1/2	107	19
VSV5454WP		\$818	\$900	7 15/16	54	54 1/2	107	19
VST4854WP	\$404			7 15/16	48	54 1/2	94	17
VSV4854WP		\$753	\$829	7 15/16	48	54 1/2	94	17
VST4254WP	\$362			7 15/16	42	54 1/2	84	15
VSV4254WP		\$699	\$769	7 15/16	42	54 1/2	84	15
VST3954WP	\$349			7 15/16	39	54 1/2	78	14
VSV3954WP		\$678	\$747	7 15/16	39	54 1/2	78	14
VST3654WP	\$327			7 15/16	36	54 1/2	72	13
VSV3654WP		\$649	\$715	7 15/16	36	54 1/2	72	13
VST3354WP	\$314			7 15/16	33	54 1/2	66	12
VSV3354WP		\$629	\$692	7 15/16	33	54 1/2	66	12
VST3054WP	\$294			7 15/16	30	54 1/2	60	11
VSV3054WP		\$601	\$662	7 15/16	30	54 1/2	60	11
VST2454WP	\$258			7 15/16	24	54 1/2	50	9
VSV2454WP		\$552	\$607	7 15/16	24	54 1/2	50	9
VST1854WP	\$228			7 15/16	18	54 1/2	37	7
VSV1854WP		\$508	\$559	7 15/16	18	54 1/2	37	7

To Order, Specify:

1 Model Number

Laminate - VST

Veneer - VSV

2 Worksurface Material (see page VI3)

- a.) TFL
- b.) HPL

3 Laminate Color (see page VI3)

- a.) Worksurface Color
- b.) Chassis Color
- c.) Drawer Color

2 Wood Species - Cherry (CH1), Maple (MA1)

- Walnut (WA1), Black Oak (BO1) or Double Cut (DC1) (see page VI1)

3 Finish Color (see page VI1)

4 Edge Profile (see page VI4)

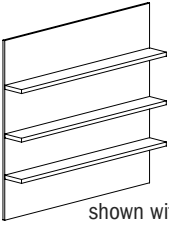
5 Pull Style and Color (see page VI4)

6 Optional Grommet Location & Color - Matte Black (MBK) or Arctic Silver (ASL) (see page VI6)

7 Other Product Options (see page VI10)

8 Accessories (see page VS314)

9 Power and Data Options (see page VS324)



54 1/2" h Wall Panel Cont.

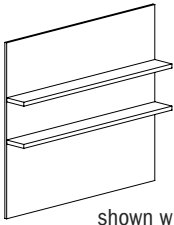
- use with standard height surfaces for 84" overall height (nothing above)
- specify number of shelves, shelf locations, shelf color (contrasting shelves on laminate models only)
- reference planning pages for shelf location options

shown with three shelves

Model	One Shelf			Two Shelves			Three Shelves			D	W	H	CTN WT	CU FT
	Laminate	Flat Cut Veneer	Dble Cut Veneer	Laminate	Flat Cut Veneer	Dble Cut Veneer	Laminate	Flat Cut Veneer	Dble Cut Veneer					
VST6054WP	\$622			\$696			\$771			7 15/16	60	54 1/2	117	21
VSV6054WP		\$1,089	\$1,199		\$1,216	\$1,338		\$1,343	\$1,478	7 15/16	60	54 1/2	117	21
VST5454WP	\$581			\$651			\$721			7 15/16	54	54 1/2	107	19
VSV5454WP		\$1,028	\$1,131		\$1,146	\$1,261		\$1,265	\$1,392	7 15/16	54	54 1/2	107	19
VST4854WP	\$522			\$589			\$654			7 15/16	48	54 1/2	94	17
VSV4854WP		\$950	\$1,045		\$1,060	\$1,167		\$1,170	\$1,288	7 15/16	48	54 1/2	94	17
VST4254WP	\$474			\$536			\$598			7 15/16	42	54 1/2	84	15
VSV4254WP		\$882	\$970		\$983	\$1,082		\$1,085	\$1,194	7 15/16	42	54 1/2	84	15
VST3954WP	\$458			\$517			\$577			7 15/16	39	54 1/2	78	14
VSV3954WP		\$855	\$941		\$953	\$1,048		\$1,050	\$1,156	7 15/16	39	54 1/2	78	14
VST3654WP	\$432			\$489			\$547			7 15/16	36	54 1/2	72	13
VSV3654WP		\$820	\$902		\$914	\$1,006		\$1,007	\$1,109	7 15/16	36	54 1/2	72	13
VST3354WP	\$416			\$471			\$526			7 15/16	33	54 1/2	66	12
VSV3354WP		\$794	\$874		\$883	\$972		\$971	\$1,069	7 15/16	33	54 1/2	66	12
VST3054WP	\$391			\$444			\$498			7 15/16	30	54 1/2	60	11
VSV3054WP		\$759	\$835		\$844	\$929		\$929	\$1,022	7 15/16	30	54 1/2	60	11
VST2454WP	\$349			\$397			\$446			7 15/16	24	54 1/2	50	9
VSV2454WP		\$697	\$767		\$773	\$851		\$849	\$934	7 15/16	24	54 1/2	50	9
VST1854WP	\$312			\$356			\$400			7 15/16	18	54 1/2	37	7
VSV1854WP		\$641	\$706		\$709	\$781		\$776	\$854	7 15/16	18	49 11/16	37	7

To Order, Specify:

- | | | |
|--|---|--|
| <p>① Model Number</p> <p>② Worksurface Material (see page VI3)
a.) TFL
b.) HPL</p> <p>③ Laminate Color (see page VI3)
a.) Worksurface Color
b.) Chassis Color
c.) Drawer Color</p> | <p>Laminate - VST</p> <p>Veneer - VSV</p> <p>② Wood Species - Cherry (CH1), Maple (MA1)
Walnut (WA1), Black Oak (BO1) or
Double Cut (DC1) (see page VI1)</p> <p>③ Finish Color (see page VI1)</p> | <p>④ Edge Profile (see page VI4)</p> <p>⑤ Pull Style and Color (see page VI5)</p> <p>⑥ Optional Grommet Location & Color -
Matte Black (MBK) or Arctic Silver (ASL)
(see page VI6)</p> <p>⑦ Other Product Options (see page VI10)</p> <p>⑧ Accessories (see page VS314)</p> <p>⑨ Power and Data Options (see page VS324)</p> |
|--|---|--|



52 3/16" h Wall Panel

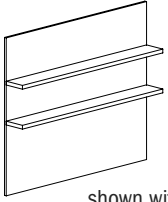
- use with bench height surfaces for 72" overall height (nothing above)
- specify number of shelves, shelf locations, shelf color (contrasting shelves on laminate models only)
- reference planning pages for shelf location options

shown with two shelves

Model	No Shelves			One Shelf			Two Shelves			D	W	H	CTN WT	CU FT
	Laminate	Flat Cut Veneer	Dble Cut Veneer	Laminate	Flat Cut Veneer	Dble Cut Veneer	Laminate	Flat Cut Veneer	Dble Cut Veneer					
VST6053WP	\$480			\$611			\$686			7 15/16	60	52 3/16	100	20
VSV6053WP		\$851	\$936		\$1,071	\$1,178		\$1,198	\$1,318	7 15/16	60	52 3/16	100	20
VST5453WP	\$446			\$571			\$641			7 15/16	54	52 3/16	91	18
VSV5453WP		\$805	\$886		\$1,012	\$1,114		\$1,130	\$1,244	7 15/16	54	52 3/16	91	18
VST4853WP	\$396			\$514			\$580			7 15/16	48	52 3/16	80	16
VSV4853WP		\$741	\$815		\$935	\$1,030		\$1,045	\$1,150	7 15/16	48	52 3/16	80	16
VST4253WP	\$356			\$467			\$528			7 15/16	42	52 3/16	71	14
VSV4253WP		\$687	\$756		\$870	\$957		\$971	\$1,069	7 15/16	42	52 3/16	71	14
VST3953WP	\$343			\$450			\$510			7 15/16	39	52 3/16	66	13
VSV3953WP		\$668	\$735		\$844	\$929		\$940	\$1,035	7 15/16	39	52 3/16	66	13
VST3653WP	\$321			\$426			\$483			7 15/16	36	52 3/16	61	12
VSV3653WP		\$640	\$705		\$809	\$890		\$902	\$993	7 15/16	36	52 3/16	61	12
VST3353WP	\$309			\$409			\$465			7 15/16	33	52 3/16	56	11
VSV3353WP		\$621	\$683		\$784	\$863		\$873	\$961	7 15/16	33	52 3/16	56	11
VST3053WP	\$289			\$386			\$438			7 15/16	30	52 3/16	51	10
VSV3053WP		\$593	\$652		\$751	\$827		\$835	\$919	7 15/16	30	52 3/16	51	10
VST2453WP	\$254			\$344			\$393			7 15/16	24	52 3/16	42	9
VSV2453WP		\$546	\$601		\$690	\$760		\$766	\$843	7 15/16	24	52 3/16	42	9
VST1853WP	\$225			\$309			\$353			7 15/16	18	52 3/16	31	7
VSV1853WP		\$504	\$555		\$636	\$700		\$703	\$773	7 15/16	18	52 3/16	31	7

To Order, Specify:

- | | | | |
|---|---|---|--|
| <p>1 Model Number</p> | <p>Laminate - VST</p> | <p>Veneer - VSV</p> | <p>4 Edge Profile (see page VI4)</p> |
| <p>2 Worksurface Material (see page VI3)</p> <p>a.) TFL</p> <p>b.) HPL</p> | <p>3 Laminate Color (see page VI3)</p> <p>a.) Worksurface Color</p> <p>b.) Chassis Color</p> <p>c.) Drawer Color</p> | <p>2 Wood Species - Cherry (CH1), Maple (MA1) Walnut (WA1), Black Oak (BO1) or Double Cut (DC1) (see page VI1)</p> <p>3 Finish Color (see page VI1)</p> | <p>5 Pull Style and Color (see page VI4)</p> <p>6 Optional Grommet Location & Color - Matte Black (MBK) or Arctic Silver (ASL) (see page VI6)</p> <p>7 Other Product Options (see page VI10)</p> <p>8 Accessories (see page VS314)</p> <p>9 Power and Data Options (see page VS324)</p> |



49 7/16" h Wall Panel

- use with bench height surfaces and 14 3/4" h L-shelf for 84" overall height
- specify number of shelves, shelf locations, shelf color (contrasting shelves on laminate models only)
- reference planning pages for shelf location options

shown with two shelves

Model	No Shelves			One Shelf			Two Shelves			D	W	H	CTN WT	CU FT
	Laminate	Flat Cut Veneer	Dble Cut Veneer	Laminate	Flat Cut Veneer	Dble Cut Veneer	Laminate	Flat Cut Veneer	Dble Cut Veneer					
VST6050WP	\$469			\$592			\$666			7 15/16	60	49 11/16	98	19
VSV6050WP		\$833	\$917		\$1,043	\$1,147		\$1,169	\$1,286	7 15/16	60	49 11/16	98	19
VST5450WP	\$436			\$553			\$623			7 15/16	54	49 11/16	89	17
VSV5450WP		\$788	\$867		\$987	\$1,086		\$1,104	\$1,215	7 15/16	54	49 11/16	89	17
VST4850WP	\$387			\$498			\$563			7 15/16	48	49 11/16	78	15
VSV4850WP		\$726	\$799		\$913	\$1,004		\$1,021	\$1,124	7 15/16	48	49 11/16	78	15
VST4250WP	\$348			\$453			\$513			7 15/16	42	49 11/16	69	14
VSV4250WP		\$674	\$742		\$849	\$934		\$950	\$1,045	7 15/16	42	49 11/16	69	14
VST3950WP	\$336			\$437			\$497			7 15/16	39	49 11/16	64	13
VSV3950WP		\$655	\$721		\$825	\$908		\$922	\$1,014	7 15/16	39	49 11/16	64	13
VST3650WP	\$315			\$414			\$470			7 15/16	36	49 11/16	59	12
VSV3650WP		\$629	\$692		\$792	\$872		\$884	\$973	7 15/16	36	49 11/16	59	12
VST3350WP	\$303			\$398			\$453			7 15/16	33	49 11/16	54	11
VSV3350WP		\$610	\$672		\$768	\$845		\$855	\$941	7 15/16	33	49 11/16	54	11
VST3050WP	\$282			\$375			\$428			7 15/16	30	49 11/16	49	10
VSV3050WP		\$584	\$642		\$735	\$809		\$819	\$901	7 15/16	30	49 11/16	49	10
VST2450WP	\$249			\$335			\$384			7 15/16	24	49 11/16	40	8
VSV2450WP		\$538	\$592		\$678	\$747		\$753	\$829	7 15/16	24	49 11/16	40	8
VST1850WP	\$221			\$301			\$345			7 15/16	18	49 11/16	29	6
VSV1850WP		\$498	\$548		\$626	\$688		\$692	\$762	7 15/16	18	49 11/16	29	6

To Order, Specify:

1 Model Number

Laminate - VST

Veneer - VSV

2 Worksurface Material (see page VI3)

- a.) TFL
- b.) HPL

3 Laminate Color (see page VI3)

- a.) Worksurface Color
- b.) Chassis Color
- c.) Drawer Color

2 Wood Species - Cherry (CH1), Maple (MA1)

- Walnut (WA1), Black Oak (BO1) or Double Cut (DC1) (see page VI1)

3 Finish Color (see page VI1)

4 Edge Profile (see page VI4)

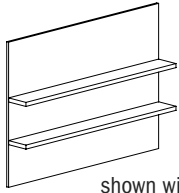
5 Pull Style and Color (see page VI5)

6 Optional Grommet Location & Color - Matte Black (MBK) or Arctic Silver (ASL) (see page VI6)

7 Other Product Options (see page VI10)

8 Accessories (see page VS314)

9 Power and Data Options (see page VS324)



42 1/2" h Wall Panel

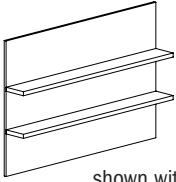
- use with standard height surfaces for 72" overall height (nothing above)
- specify number of shelves, shelf locations, shelf color (contrasting shelves on laminate models only)
- reference planning pages for shelf location options

shown with two shelves

Model	No Shelves			One Shelf			Two Shelves			D	W	H	CTN WT	CU FT
	Laminate	Flat Cut Veneer	Dble Cut Veneer	Laminate	Flat Cut Veneer	Dble Cut Veneer	Laminate	Flat Cut Veneer	Dble Cut Veneer					
VST6042WP	\$434			\$559			\$633			7 15/16	60	42 1/2	87	16
VSV6042WP		\$781	\$859		\$991	\$1,090		\$1,115	\$1,226	7 15/16	60	42 1/2	87	16
VST5442WP	\$405			\$524			\$593			7 15/16	54	42 1/2	78	15
VSV5442WP		\$742	\$816		\$939	\$1,034		\$1,054	\$1,160	7 15/16	54	42 1/2	78	15
VST4842WP	\$359			\$472			\$537			7 15/16	48	42 1/2	70	13
VSV4842WP		\$684	\$753		\$871	\$958		\$978	\$1,077	7 15/16	48	42 1/2	70	13
VST4242WP	\$323			\$430			\$490			7 15/16	42	42 1/2	60	12
VSV4242WP		\$638	\$703		\$812	\$894		\$912	\$1,003	7 15/16	42	42 1/2	60	12
VST3942WP	\$313			\$416			\$474			7 15/16	39	42 1/2	56	11
VSV3942WP		\$622	\$684		\$791	\$871		\$886	\$975	7 15/16	39	42 1/2	56	11
VST3642WP	\$294			\$394			\$450			7 15/16	36	42 1/2	54	10
VSV3642WP		\$597	\$658		\$760	\$837		\$851	\$936	7 15/16	36	42 1/2	54	10
VST3342WP	\$283			\$380			\$434			7 15/16	33	42 1/2	49	9
VSV3342WP		\$582	\$640		\$738	\$812		\$826	\$909	7 15/16	33	42 1/2	49	9
VST3042WP	\$265			\$358			\$410			7 15/16	30	42 1/2	46	9
VSV3042WP		\$557	\$613		\$709	\$781		\$792	\$872	7 15/16	30	42 1/2	46	9
VST2442WP	\$234			\$322			\$369			7 15/16	24	42 1/2	37	7
VSV2442WP		\$516	\$568		\$656	\$722		\$731	\$805	7 15/16	24	42 1/2	37	7
VST1842WP	\$210			\$292			\$335			7 15/16	18	42 1/2	29	6
VSV1842WP		\$481	\$529		\$609	\$671		\$676	\$744	7 15/16	18	42 1/2	29	6

To Order, Specify:

- | | | |
|---|---|--|
| <p>1 Model Number</p> <p>2 Worksurface Material (see page VI3)
a.) TFL
b.) HPL</p> <p>3 Laminate Color (see page VI3)
a.) Worksurface Color
b.) Chassis Color
c.) Drawer Color</p> | <p>Laminate - VST</p> <p>Veneer - VSV</p> <p>2 Wood Species - Cherry (CH1), Maple (MA1)
Walnut (WA1), Black Oak (BO1) or
Double Cut (DC1) (see page VI1)</p> <p>3 Finish Color (see page VI1)</p> | <p>4 Edge Profile (see page VI4)</p> <p>5 Pull Style and Color (see page VI4)</p> <p>6 Optional Grommet Location & Color -
Matte Black (MBK) or Arctic Silver (ASL)
(see page VI6)</p> <p>7 Other Product Options (see page VI10)</p> <p>8 Accessories (see page VS314)</p> <p>9 Power and Data Options (see page VS324)</p> |
|---|---|--|



39 3/4" h Wall Panel

- use with standard height surfaces and 14 3/4" h L-shelf for 84" overall height
- specify number of shelves, shelf locations, shelf color (contrasting shelves on laminate models only)
- reference planning pages for shelf location options

shown with two shelves

Model	No Shelves			One Shelf			Two Shelves			D	W	H	CTN WT	CU FT
	Laminate	Flat Cut Veneer	Dble Cut Veneer	Laminate	Flat Cut Veneer	Dble Cut Veneer	Laminate	Flat Cut Veneer	Dble Cut Veneer					
VST6040WP	\$423			\$541			\$613			7 15/16	60	39 3/4	79	15
VSV6040WP		\$762	\$839		\$963	\$1,059		\$1,086	\$1,195	7 15/16	60	39 3/4	79	15
VST5440WP	\$395			\$507			\$576			7 15/16	54	39 3/4	74	14
VSV5440WP		\$724	\$797		\$914	\$1,006		\$1,030	\$1,133	7 15/16	54	39 3/4	74	14
VST4840WP	\$350			\$456			\$520			7 15/16	48	39 3/4	68	13
VSV4840WP		\$670	\$737		\$848	\$933		\$955	\$1,051	7 15/16	48	39 3/4	68	13
VST4240WP	\$315			\$416			\$476			7 15/16	42	39 3/4	59	11
VSV4240WP		\$625	\$687		\$793	\$873		\$891	\$980	7 15/16	42	39 3/4	59	11
VST3940WP	\$305			\$403			\$461			7 15/16	39	39 3/4	55	10
VSV3940WP		\$609	\$671		\$772	\$850		\$867	\$954	7 15/16	39	39 3/4	55	10
VST3640WP	\$286			\$382			\$437			7 15/16	36	39 3/4	52	10
VSV3640WP		\$586	\$645		\$743	\$817		\$834	\$918	7 15/16	36	39 3/4	52	10
VST3340WP	\$276			\$368			\$423			7 15/16	33	39 3/4	47	9
VSV3340WP		\$571	\$629		\$723	\$796		\$809	\$890	7 15/16	33	39 3/4	47	9
VST3040WP	\$259			\$348			\$400			7 15/16	30	39 3/4	43	8
VSV3040WP		\$548	\$603		\$694	\$764		\$776	\$854	7 15/16	30	39 3/4	43	8
VST2440WP	\$230			\$313			\$361			7 15/16	24	39 3/4	35	7
VSV2440WP		\$509	\$560		\$644	\$709		\$719	\$792	7 15/16	24	39 3/4	35	7
VST1840WP	\$207			\$284			\$327			7 15/16	18	39 3/4	28	5
VSV1840WP		\$476	\$524		\$600	\$661		\$667	\$733	7 15/16	18	39 3/4	28	5

To Order, Specify:

1 Model Number

Laminate - VST

Veneer - VSV

2 Worksurface Material (see page VI3)

- a.) TFL
- b.) HPL

3 Laminate Color (see page VI3)

- a.) Worksurface Color
- b.) Chassis Color
- c.) Drawer Color

2 Wood Species - Cherry (CH1), Maple (MA1)

- Walnut (WA1), Black Oak (BO1) or Double Cut (DC1) (see page VI1)

3 Finish Color (see page VI1)

4 Edge Profile (see page VI4)

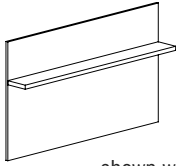
5 Pull Style and Color (see page VI5)

6 Optional Grommet Location & Color - Matte Black (MBK) or Arctic Silver (ASL) (see page VI6)

7 Other Product Options (see page VI10)

8 Accessories (see page VS314)

9 Power and Data Options (see page VS324)



34 1/16" h Wall Panel

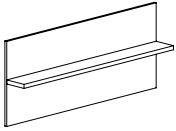
- use with bench height surfaces and 17 1/2" h wall mount overhead or L-shelf for 72" overall height
- specify number of shelves, shelf locations, shelf color (contrasting shelves on laminate models only)
- reference planning pages for shelf location options

shown with one shelf

Model	No Shelves			One Shelf			D	W	H	CTN WT	CU FT
	Laminate	Flat Cut Veneer	Dble Cut Veneer	Laminate	Flat Cut Veneer	Dble Cut Veneer					
VST6035WP	\$398			\$517			7 15/16	60	34 11/16	62	14
VSV6035WP		\$724	\$797		\$925	\$1,018	7 15/16	60	34 11/16	62	14
VST5435WP	\$373			\$485			7 15/16	54	34 11/16	56	12
VSV5435WP		\$690	\$760		\$880	\$968	7 15/16	54	34 11/16	56	12
VST4835WP	\$330			\$437			7 15/16	48	34 11/16	50	11
VSV4835WP		\$639	\$704		\$817	\$899	7 15/16	48	34 11/16	50	11
VST4235WP	\$298			\$399			7 15/16	42	34 11/16	45	10
VSV4235WP		\$598	\$659		\$765	\$842	7 15/16	42	34 11/16	45	10
VST3935WP	\$289			\$388			7 15/16	39	34 11/16	42	9
VSV3935WP		\$585	\$643		\$747	\$822	7 15/16	39	34 11/16	42	9
VST3635WP	\$271			\$367			7 15/16	36	34 11/16	38	9
VSV3635WP		\$563	\$620		\$720	\$793	7 15/16	36	34 11/16	38	9
VST3335WP	\$263			\$355			7 15/16	33	34 11/16	36	8
VSV3335WP		\$550	\$605		\$702	\$772	7 15/16	33	34 11/16	36	8
VST3035WP	\$245			\$336			7 15/16	30	34 11/16	33	7
VSV3035WP		\$529	\$583		\$675	\$743	7 15/16	30	34 11/16	33	7
VST2435WP	\$219			\$304			7 15/16	24	34 11/16	27	6
VSV2435WP		\$494	\$544		\$629	\$692	7 15/16	24	34 11/16	27	6
VST1835WP	\$198			\$277			7 15/16	18	34 11/16	21	5
VSV1835WP		\$464	\$511		\$588	\$647	7 15/16	18	34 11/16	21	5

To Order, Specify:

- | | | |
|------------------------------|-----------------------|---------------------|
| <p>1 Model Number</p> | <p>Laminate - VST</p> | <p>Veneer - VSV</p> |
|------------------------------|-----------------------|---------------------|
-
- | | | |
|---|---|---|
| <p>2 Worksurface Material (see page VI3)</p> <p>a.) TFL</p> <p>b.) HPL</p> | <p>2 Wood Species - Cherry (CH1), Maple (MA1)
Walnut (WA1), Black Oak (BO1) or
Double Cut (DC1) (see page VI1)</p> | <p>4 Edge Profile (see page VI4)</p> |
| <p>3 Laminate Color (see page VI3)</p> <p>a.) Worksurface Color</p> <p>b.) Chassis Color</p> <p>c.) Drawer Color</p> | <p>3 Finish Color (see page VI1)</p> | <p>5 Pull Style and Color (see page VI4)</p> |
| | | <p>6 Optional Grommet Location & Color -
Matte Black (MBK) or Arctic Silver (ASL)
(see page VI6)</p> |
| | | <p>7 Other Product Options (see page VI10)</p> |
| | | <p>8 Accessories (see page VS314)</p> |
| | | <p>9 Power and Data Options (see page VS324)</p> |



25" h Wall Panel

- use with standard height surfaces and 17 ½" h wall mount overhead or L-shelf for 72" overall height
- use with standard height surfaces and 29 ½" h wall mount overhead or L-shelf for 84" overall height
- specify number of shelves, shelf locations, shelf color (contrasting shelves on laminate models only)
- reference planning pages for shelf location options

shown with one shelf

Model	No Shelves			One Shelf			D	W	H	CTN WT	CU FT
	Laminate	Flat Cut Veneer	Dble Cut Veneer	Laminate	Flat Cut Veneer	Dble Cut Veneer					
VST6025WP	\$357			\$462			7 15/16	60	25	50	10
VSV6025WP		\$660	\$726		\$840	\$924	7 15/16	60	25	50	10
VST5425WP	\$336			\$435			7 15/16	54	25	45	9
VSV5425WP		\$632	\$695		\$803	\$884	7 15/16	54	25	45	9
VST4825WP	\$297			\$392			7 15/16	48	25	40	8
VSV4825WP		\$587	\$646		\$749	\$824	7 15/16	48	25	40	8
VST4225WP	\$269			\$359			7 15/16	42	25	35	7
VSV4225WP		\$552	\$607		\$706	\$776	7 15/16	42	25	35	7
VST3925WP	\$262			\$350			7 15/16	39	25	33	7
VSV3925WP		\$542	\$596		\$691	\$761	7 15/16	39	25	33	7
VST3625WP	\$246			\$333			7 15/16	36	25	31	6
VSV3625WP		\$523	\$576		\$668	\$735	7 15/16	36	25	31	6
VST3325WP	\$239			\$323			7 15/16	33	25	29	6
VSV3325WP		\$514	\$566		\$653	\$719	7 15/16	33	25	29	6
VST3025WP	\$225			\$306			7 15/16	30	25	27	5
VSV3025WP		\$496	\$546		\$631	\$694	7 15/16	30	25	27	5
VST2425WP	\$202			\$279			7 15/16	24	25	22	5
VSV2425WP		\$467	\$514		\$593	\$652	7 15/16	24	25	22	5
VST1825WP	\$186			\$258			7 15/16	18	25	17	4
VSV1825WP		\$443	\$488		\$560	\$617	7 15/16	18	25	17	4

To Order, Specify:

1 Model Number

Laminate - VST

Veneer - VSV

2 Worksurface Material (see page VI3)

- a.) TFL
- b.) HPL

3 Laminate Color (see page VI3)

- a.) Worksurface Color
- b.) Chassis Color
- c.) Drawer Color

2 Wood Species - Cherry (CH1), Maple (MA1)

- Walnut (WA1), Black Oak (BO1) or
- Double Cut (DC1) (see page VI1)

3 Finish Color (see page VI1)

4 Edge Profile (see page VI4)

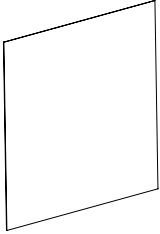
5 Pull Style and Color (see page VI5)

6 Optional Grommet Location & Color -
Matte Black (MBK) or Arctic Silver (ASL)
(see page VI6)

7 Other Product Options (see page VI10)

8 Accessories (see page VS314)

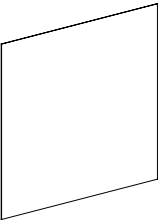
9 Power and Data Options (see page VS324)

Description	D	W	H	CTN WT	CU FT	① Model	List Price
54 1/2" h Magnetic Glass Wall Panel 	7/16	60	54 1/2	68	5	VSB6054WPGP	\$6,248
	7/16	54	54 1/2	62	5	VSB5454WPGP	\$5,769
	7/16	48	54 1/2	55	4	VSB4854WPGP	\$5,291
	7/16	42	54 1/2	49	4	VSB4254WPGP	\$4,598
	7/16	39	54 1/2	46	4	VSB3954WPGP	\$4,358
	7/16	36	54 1/2	42	4	VSB3654WPGP	\$4,119
	7/16	33	54 1/2	39	3	VSB3354WPGP	\$3,881
	7/16	30	54 1/2	36	3	VSB3054WPGP	\$3,558
	7/16	24	54 1/2	29	3	VSB2454WPGP	\$3,097
	7/16	18	54 1/2	23	2	VSB1854WPGP	\$2,635

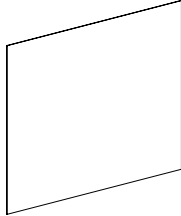
- use with standard height surfaces for 84" overall height (nothing above)
- specify white (WPG) or black (BPG) back painted glass

52 3/16" h Magnetic Glass Wall Panel 	7/16	60	52 3/16	65	5	VSB6053WPGP	\$6,068
	7/16	54	52 3/16	59	5	VSB5453WPGP	\$5,605
	7/16	48	52 3/16	53	4	VSB4853WPGP	\$5,142
	7/16	42	52 3/16	47	4	VSB4253WPGP	\$4,463
	7/16	39	52 3/16	44	4	VSB3953WPGP	\$4,232
	7/16	36	52 3/16	41	3	VSB3653WPGP	\$4,000
	7/16	33	52 3/16	38	3	VSB3353WPGP	\$3,768
	7/16	30	52 3/16	34	3	VSB3053WPGP	\$3,455
	7/16	24	52 3/16	28	2	VSB2453WPGP	\$3,008
	7/16	18	52 3/16	22	2	VSB1853WPGP	\$2,561

- use with bench height surfaces for 72" overall height (nothing above)
- specify white (WPG) or black (BPG) back painted glass

49 1/16" h Magnetic Glass Wall Panel 	7/16	60	49 1/16	62	5	VSB6050WPGP	\$5,855
	7/16	54	49 1/16	56	5	VSB5450WPGP	\$5,409
	7/16	48	49 1/16	50	4	VSB4850WPGP	\$4,964
	7/16	42	49 1/16	45	4	VSB4250WPGP	\$4,303
	7/16	39	49 1/16	42	3	VSB3950WPGP	\$4,081
	7/16	36	49 1/16	39	3	VSB3650WPGP	\$3,858
	7/16	33	49 1/16	36	3	VSB3350WPGP	\$3,635
	7/16	30	49 1/16	33	3	VSB3050WPGP	\$3,331
	7/16	24	49 1/16	27	2	VSB2450WPGP	\$2,901
	7/16	18	49 1/16	21	2	VSB1850WPGP	\$2,473

- use with bench height surface and 14 3/4" Wall Mount Single Shelf for 84" overall height
- specify white (WPG) or black (BPG) back painted glass

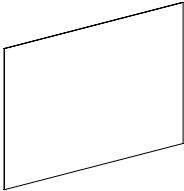
Description	D	W	H	CTN WT	CU FT	① Model	List Price
42 ½" h Magnetic Glass Wall Panel 	7/16	60	42 ½	54	4	VSB6042WPGP	\$5,311
	7/16	54	42 ½	49	4	VSB5442WPGP	\$4,705
	7/16	48	42 ½	44	4	VSB4842WPGP	\$4,304
	7/16	42	42 ½	39	3	VSB4242WPGP	\$3,895
	7/16	39	42 ½	36	3	VSB3942WPGP	\$3,696
	7/16	36	42 ½	34	3	VSB3642WPGP	\$3,497
	7/16	33	42 ½	31	3	VSB3342WPGP	\$3,296
	7/16	30	42 ½	28	3	VSB3042WPGP	\$3,013
	7/16	24	42 ½	23	2	VSB2442WPGP	\$2,630
7/16	18	42 ½	18	2	VSB1842WPGP	\$2,070	

- use alone with standard height surfaces for 72" overall height
- specify white (WPG) or black (BPG) back painted glass

39¾" h Magnetic Glass Wall Panel 	7/16	60	39 ¾	51	4	VSB6040WPGP	\$5,098
	7/16	54	39 ¾	46	4	VSB5440WPGP	\$4,510
	7/16	48	39 ¾	41	3	VSB4840WPGP	\$4,128
	7/16	42	39 ¾	36	3	VSB4240WPGP	\$3,737
	7/16	39	39 ¾	34	3	VSB3940WPGP	\$3,546
	7/16	36	39 ¾	32	3	VSB3640WPGP	\$3,354
	7/16	33	39 ¾	29	3	VSB3340WPGP	\$3,163
	7/16	30	39 ¾	27	2	VSB3040WPGP	\$2,889
	7/16	24	39 ¾	22	2	VSB2440WPGP	\$2,523
7/16	18	39 ¾	17	2	VSB1840WPGP	\$1,982	

- use with standard height surfaces and 14 ¾" Wall Mount Single Shelf for 84" overall height
- specify white (WPG) or black (BPG) back painted glass

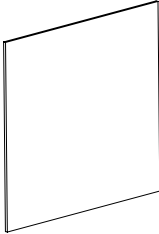
To Order, Specify:	
① Model Number	Laminate - VST Veneer - VSV
② Worksurface Material (see page VI3)	② Wood Species - Cherry (CH1), Maple (MA1) Walnut (WA1), Black Oak (BO1) or Double Cut (DC1) (see page VI1)
a.) TFL	
b.) HPL	
③ Laminate Color (see page VI3)	③ Finish Color (see page VI1)
a.) Worksurface Color	
b.) Chassis Color	
c.) Drawer Color	
	④ Edge Profile (see page VI4)
	⑤ Pull Style and Color (see page VI5)
	⑥ Optional Grommet Location & Color - Matte Black (MBK) or Arctic Silver (ASL) (see page VI6)
	⑦ Other Product Options (see page VI10)
	⑧ Accessories (see page VS314)
	⑨ Power and Data Options (see page VS324)

Description	D	W	H	CTN WT	CU FT	① Model	List Price
34 11/16" h Magnetic Glass Wall Panel 	7/16	60	34 11/16	45	4	VSB6035WPGP	\$4,332
	7/16	54	34 11/16	41	3	VSB5435WPGP	\$3,999
	7/16	48	34 11/16	36	3	VSB4835WPGP	\$3,666
	7/16	42	34 11/16	32	3	VSB4235WPGP	\$3,325
	7/16	39	34 11/16	30	3	VSB3935WPGP	\$3,159
	7/16	36	34 11/16	28	2	VSB3635WPGP	\$2,990
	7/16	33	34 11/16	26	2	VSB3335WPGP	\$2,824
	7/16	30	34 11/16	24	2	VSB3035WPGP	\$2,658
	7/16	24	34 11/16	19	2	VSB2435WPGP	\$2,325
	7/16	18	34 11/16	15	2	VSB1835WPGP	\$1,817

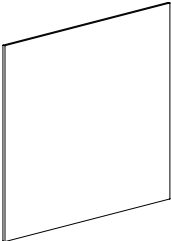
- use with bench height surfaces and 17 1/2" Overhead Shelf or Wall Mount Single Shelf for 72" overall height
- use with bench height surfaces and 29 1/2" Overhead Shelf or Wall Mount Double Shelf for 84" overall height
- specify white (WPG) or black (BPG) back painted glass

25" h Magnetic Glass Wall Panel 	7/16	60	25	33	3	VSB6025WPGP	\$3,583
	7/16	54	25	30	3	VSB5425WPGP	\$3,311
	7/16	48	25	27	2	VSB4825WPGP	\$3,041
	7/16	42	25	24	2	VSB4225WPGP	\$2,762
	7/16	39	25	22	2	VSB3925WPGP	\$2,627
	7/16	36	25	21	2	VSB3625WPGP	\$2,491
	7/16	33	25	19	2	VSB3325WPGP	\$2,356
	7/16	30	25	18	2	VSB3025WPGP	\$2,045
	7/16	24	25	14	1	VSB2425WPGP	\$1,774
	7/16	18	25	11	1	VSB1825WPGP	\$1,505

- use with standard height surfaces and 17 1/2" Overhead Shelf or Wall Mount Single Shelf for 72" overall height
- use with standard height surfaces and 29 1/2" Overhead Shelf or Wall Mount Double Shelf for 84" overall height
- specify white (WPG) or black (BPG) back painted glass

Description	D	W	H	CTN WT	CU FT	① Model	List Price
54 ½" h Laminate Markerboard Wall Panel 	1	60	54½	72	7	VSB6054WPMB	\$1,463
	1	54	54½	65	6	VSB5454WPMB	\$1,337
	1	48	54½	58	5	VSB4854WPMB	\$1,189
	1	42	54½	51	5	VSB4254WPMB	\$1,057
	1	39	54½	48	5	VSB3954WPMB	\$999
	1	36	54½	45	4	VSB3654WPMB	\$929
	1	33	54½	42	4	VSB3354WPMB	\$872
	1	30	54½	39	4	VSB3054WPMB	\$804
	1	24	54½	32	3	VSB2454WPMB	\$677
	1	18	54½	25	2	VSB1854WPMB	\$556

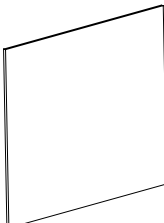
· use with standard height surfaces for 84" h overall height (nothing above)

52 ¾" h Laminate Markerboard Wall Panel 	1	60	52¾	70	6	VSB6053WPMB	\$1,415
	1	54	52¾	63	6	VSB5453WPMB	\$1,295
	1	48	52¾	56	5	VSB4853WPMB	\$1,152
	1	42	52¾	49	5	VSB4253WPMB	\$1,023
	1	39	52¾	46	4	VSB3953WPMB	\$967
	1	36	52¾	43	4	VSB3653WPMB	\$900
	1	33	52¾	40	4	VSB3353WPMB	\$846
	1	30	52¾	37	4	VSB3053WPMB	\$781
	1	24	52¾	30	3	VSB2453WPMB	\$658
	1	18	52¾	23	2	VSB1853WPMB	\$543

· use with 19 ¾" h credenza for 72" h overall height (nothing above)

To Order, Specify:

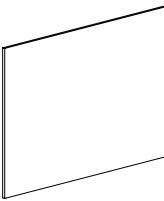
- | | | |
|---|---|---|
| <p>① Model Number</p> <p>② Worksurface Material (see page V13)</p> <p> a.) TFL</p> <p> b.) HPL</p> <p>③ Laminate Color (see page V13)</p> <p> a.) Worksurface Color</p> <p> b.) Chassis Color</p> <p> c.) Drawer Color</p> | <p>Laminate - VST</p> <p>Veneer - VSV</p> <p>② Wood Species - Cherry (CH1), Maple (MA1)</p> <p> Walnut (WA1), Black Oak (BO1) or</p> <p> Double Cut (DC1) (see page V11)</p> <p>③ Finish Color (see page V11)</p> | <p>④ Edge Profile (see page V14)</p> <p>⑤ Pull Style and Color (see page V15)</p> <p>⑥ Optional Grommet Location & Color -</p> <p> Matte Black (MBK) or Arctic Silver (ASL)</p> <p> (see page V16)</p> <p>⑦ Other Product Options (see page V10)</p> <p>⑧ Accessories (see page VS314)</p> <p>⑨ Power and Data Options (see page VS324)</p> |
|---|---|---|

Description	D	W	H	CTN WT	CU FT	① Model	List Price
49 1¹/₁₆"h Laminate Markerboard Wall Panel 	1	60	49 ⁷ / ₁₆	68	6	VSB6050WPMB	\$1,360
	1	54	49 ⁷ / ₁₆	61	6	VSB5450WPMB	\$1,244
	1	48	49 ⁷ / ₁₆	54	5	VSB4850WPMB	\$1,107
	1	42	49 ⁷ / ₁₆	47	4	VSB4250WPMB	\$983
	1	39	49 ⁷ / ₁₆	44	4	VSB3950WPMB	\$930
	1	36	49 ⁷ / ₁₆	41	4	VSB3650WPMB	\$867
	1	33	49 ⁷ / ₁₆	38	4	VSB3350WPMB	\$814
	1	30	49 ⁷ / ₁₆	35	3	VSB3050WPMB	\$753
	1	24	49 ⁷ / ₁₆	28	3	VSB2450WPMB	\$635
	1	18	49 ⁷ / ₁₆	21	2	VSB1850WPMB	\$525

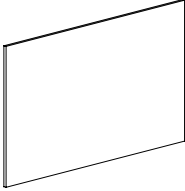
· use with 19 3¹/₁₆"h credenza and 14 3³/₄"h L-Shelf for 84"h overall height (nothing above)

42 1¹/₂"h Laminate Markerboard Wall Panel 	1	60	42 1 ¹ / ₂	59	5	VSB6042WPMB	\$1,211
	1	54	42 1 ¹ / ₂	53	5	VSB5442WPMB	\$1,110
	1	48	42 1 ¹ / ₂	47	4	VSB4842WPMB	\$989
	1	42	42 1 ¹ / ₂	42	4	VSB4242WPMB	\$878
	1	39	42 1 ¹ / ₂	39	4	VSB3942WPMB	\$834
	1	36	42 1 ¹ / ₂	36	3	VSB3642WPMB	\$777
	1	33	42 1 ¹ / ₂	33	3	VSB3342WPMB	\$732
	1	30	42 1 ¹ / ₂	30	3	VSB3042WPMB	\$677
	1	24	42 1 ¹ / ₂	25	3	VSB2442WPMB	\$574
	1	18	42 1 ¹ / ₂	19	2	VSB1842WPMB	\$480

· use with standard height surfaces for 72"h overall height (nothing above)

39 3³/₄"h Laminate Markerboard Wall Panel 	1	60	39 3 ³ / ₄	55	5	VSB6040WPMB	\$1,154
	1	54	39 3 ³ / ₄	50	5	VSB5440WPMB	\$1,059
	1	48	39 3 ³ / ₄	44	4	VSB4840WPMB	\$942
	1	42	39 3 ³ / ₄	39	4	VSB4240WPMB	\$840
	1	39	39 3 ³ / ₄	37	3	VSB3940WPMB	\$798
	1	36	39 3 ³ / ₄	34	3	VSB3640WPMB	\$744
	1	33	39 3 ³ / ₄	31	3	VSB3340WPMB	\$701
	1	30	39 3 ³ / ₄	29	3	VSB3040WPMB	\$649
	1	24	39 3 ³ / ₄	23	2	VSB2440WPMB	\$552
	1	18	39 3 ³ / ₄	18	2	VSB1840WPMB	\$463

· use with 29 1¹/₂"h credenza and 14 3³/₄"h L-Shelf for 84"h overall height (nothing above)

Description	D	W	H	CTN WT	CU FT	1 Model	List Price
34 1/16" h Laminate Markerboard Wall Panel 	1	60	34 1/16	48	4	VSB6035WPMB	\$1,046
	1	54	34 1/16	44	4	VSB5435WPMB	\$962
	1	48	34 1/16	40	4	VSB4835WPMB	\$855
	1	42	34 1/16	35	3	VSB4235WPMB	\$763
	1	39	34 1/16	32	3	VSB3935WPMB	\$726
	1	36	34 1/16	30	3	VSB3635WPMB	\$678
	1	33	34 1/16	28	3	VSB3335WPMB	\$640
	1	30	34 1/16	25	3	VSB3035WPMB	\$594
	1	24	34 1/16	21	2	VSB2435WPMB	\$508
	1	18	34 1/16	16	2	VSB1835WPMB	\$429

- use with bench height surfaces and 17 1/2" h wall mount overhead or L-shelf for 72" h overall height
- use with bench height surfaces and 29 1/2" h wall mount overhead or L-shelf for 84" h overall height

25" h Laminate Markerboard Wall Panel 	1	60	25	37	3	VSB6025WPMB	\$848
	1	54	25	33	3	VSB5425WPMB	\$783
	1	48	25	29	3	VSB4825WPMB	\$697
	1	42	25	27	3	VSB4225WPMB	\$625
	1	39	25	25	2	VSB3925WPMB	\$596
	1	36	25	23	2	VSB3625WPMB	\$559
	1	33	25	21	2	VSB3325WPMB	\$531
	1	30	25	19	2	VSB3025WPMB	\$494
	1	24	25	16	2	VSB2425WPMB	\$428
	1	18	25	13	1	VSB1825WPMB	\$369

- use with standard height surfaces and 17 1/2" h wall mount overhead or L-shelf for 72" h overall height
- use with standard height surfaces and 29 1/2" h wall mount overhead or L-shelf for 84" h overall height

To Order, Specify:

1 Model Number

Laminate - VST

Veneer - VSV

2 Worksurface Material (see page VI3)

- a.) TFL
- b.) HPL

2 Wood Species - Cherry (CH1), Maple (MA1)

- Walnut (WA1), Black Oak (BO1) or
- Double Cut (DC1) (see page VI1)

4 Edge Profile (see page VI4)

5 Pull Style and Color (see page VI5)

6 Optional Grommet Location & Color -
Matte Black (MBK) or Arctic Silver (ASL)
(see page VI6)

7 Other Product Options (see page VI10)

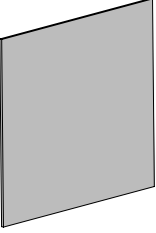
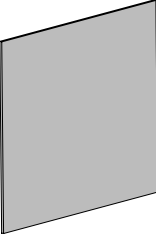
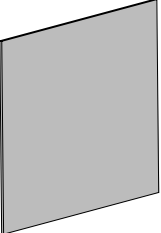
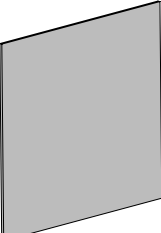
8 Accessories (see page VS314)

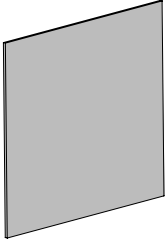
9 Power and Data Options (see page VS324)

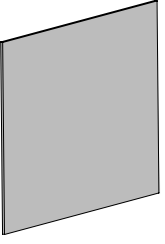
3 Laminate Color (see page VI3)

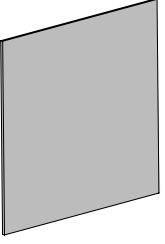
- a.) Worksurface Color
- b.) Chassis Color
- c.) Drawer Color

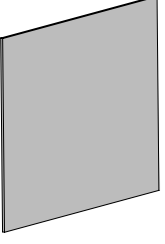
3 Finish Color (see page VI1)

Description	D	W	H	CTN WT	CU FT	① Model	List Price Per Grade
54 ½" h Tackable Wall Panel 	1	48	54½	30	5	VSB4854WPTK	COM \$782 A \$801 B \$837 C \$899 D \$980 E \$1,063 F \$1,189 G \$1,325 H \$1,470 I \$1,697 J \$1,967
<ul style="list-style-type: none"> • use with 29 ½" h credenza for 84" overall height (nothing above) • com ydg: 1 ¾ 							
54 ½" h Tackable Wall Panel 	1	42	54½	26	5	VSB4254WPTK	COM \$713 A \$731 B \$767 C \$830 D \$912 E \$995 F \$1,121 G \$1,256 H \$1,401 I \$1,626 J \$1,898
<ul style="list-style-type: none"> • use with 29 ½" h credenza for 84" overall height (nothing above) • com ydg: 1 ¾ 							
54 ½" h Tackable Wall Panel 	1	39	54½	24	5	VSB3954WPTK	COM \$686 A \$705 B \$742 C \$804 D \$886 E \$968 F \$1,094 G \$1,229 H \$1,375 I \$1,601 J \$1,872
<ul style="list-style-type: none"> • use with 29 ½" h credenza for 84" overall height (nothing above) • com ydg: 1 ¾ 							
54 ½" h Tackable Wall Panel 	1	36	54½	22	4	VSB3654WPTK	COM \$650 A \$669 B \$705 C \$767 D \$849 E \$931 F \$1,058 G \$1,194 H \$1,338 I \$1,564 J \$1,835
<ul style="list-style-type: none"> • use with 29 ½" h credenza for 84" overall height (nothing above) • com ydg: 1 ¾ 							

Description	D	W	H	CTN WT	CU FT	① Model	List Price Per Grade
54 1/2" h Tackable Wall Panel	1	33	54 1/2	20	4	VSB3354WPTK	COM \$626
 <ul style="list-style-type: none"> • use with 29 1/2" h credenza for 84" overall height (nothing above) • com ydg: 1 3/4 							A \$643
							B \$680
							C \$743
							D \$825
							E \$907
							F \$1,034
							G \$1,169
							H \$1,314
							I \$1,539
							J \$1,811

54 1/2" h Tackable Wall Panel	1	30	54 1/2	19	4	VSB3054WPTK	COM \$589
 <ul style="list-style-type: none"> • use with 29 1/2" h credenza for 84" overall height (nothing above) • com ydg: 1 3/4 							A \$607
							B \$643
							C \$706
							D \$788
							E \$871
							F \$997
							G \$1,132
							H \$1,277
							I \$1,504
							J \$1,774

54 1/2" h Tackable Wall Panel	1	24	54 1/2	15	3	VSB2454WPTK	COM \$526
 <ul style="list-style-type: none"> • use with 29 1/2" h credenza for 84" overall height (nothing above) • com ydg: 1 3/4 							A \$545
							B \$582
							C \$643
							D \$725
							E \$807
							F \$934
							G \$1,070
							H \$1,214
							I \$1,442
							J \$1,711

54 1/2" h Tackable Wall Panel	1	18	54 1/2	11	2	VSB1854WPTK	COM \$470
 <ul style="list-style-type: none"> • use with 29 1/2" h credenza for 84" overall height (nothing above) • com ydg: 1 3/4 							A \$489
							B \$526
							C \$589
							D \$670
							E \$753
							F \$878
							G \$1,014
							H \$1,160
							I \$1,385
							J \$1,657

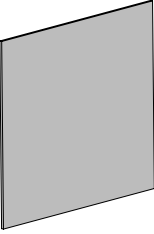
To Order, Specify:

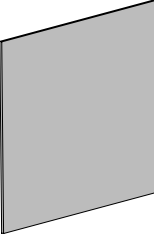
① Model Number

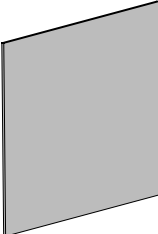
② Fabric Selection: vendor, pattern, color

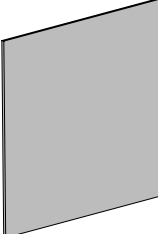
Visit www.jsifurniture.com/finishes-and-materials/textiles

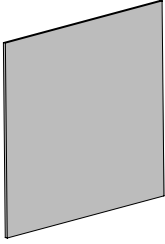
for our textiles program. See selection of standard and graded in manufacturers and patterns.

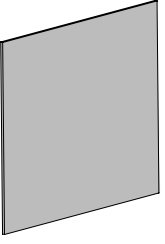
Description	D	W	H	CTN WT	CU FT	① Model	List Price Per Grade
52 3/16" h Tackable Wall Panel	1	48	52 3/16	28	5	VSB4853WPTK	COM \$766
 <ul style="list-style-type: none"> • use with 19 13/16" h credenza for 72" overall height (nothing above) • com ydg: 1 3/4 							A \$786
							B \$823
							C \$885
							D \$965
							E \$1,048
							F \$1,174
							G \$1,310
							H \$1,455
							I \$1,681
							J \$1,953

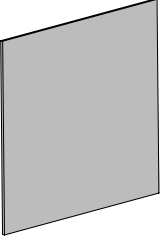
52 3/16" h Tackable Wall Panel	1	42	52 3/16	25	5	VSB4253WPTK	COM \$699
 <ul style="list-style-type: none"> • use with 19 13/16" h credenza for 72" overall height (nothing above) • com ydg: 1 3/4 							A \$717
							B \$754
							C \$816
							D \$897
							E \$979
							F \$1,106
							G \$1,241
							H \$1,386
							I \$1,613
							J \$1,883

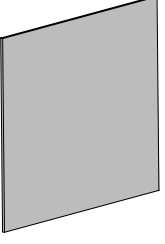
52 3/16" h Tackable Wall Panel	1	39	52 3/16	23	4	VSB3953WPTK	COM \$674
 <ul style="list-style-type: none"> • use with 19 13/16" h credenza for 72" overall height (nothing above) • com ydg: 1 3/4 							A \$692
							B \$728
							C \$791
							D \$873
							E \$955
							F \$1,082
							G \$1,216
							H \$1,362
							I \$1,588
							J \$1,859

52 3/16" h Tackable Wall Panel	1	36	52 3/16	21	4	VSB3653WPTK	COM \$638
 <ul style="list-style-type: none"> • use with 19 13/16" h credenza for 72" overall height (nothing above) • com ydg: 1 3/4 							A \$656
							B \$693
							C \$756
							D \$837
							E \$919
							F \$1,046
							G \$1,182
							H \$1,326
							I \$1,553
							J \$1,824

Description	D	W	H	CTN WT	CU FT	① Model	List Price Per Grade
52 3/16" h Tackable Wall Panel	1	33	52 3/16	20	4	VSB3353WPTK	COM \$613
 <ul style="list-style-type: none"> • use with 19 3/16" h credenza for 72" overall height (nothing above) • com ydg: 1 3/4 							A \$632
							B \$669
							C \$731
							D \$812
							E \$894
							F \$1,021
							G \$1,157
							H \$1,301
							I \$1,529
							J \$1,798

52 3/16" h Tackable Wall Panel	1	30	52 3/16	18	4	VSB3053WPTK	COM \$579
 <ul style="list-style-type: none"> • use with 19 3/16" h credenza for 72" overall height (nothing above) • com ydg: 1 3/4 							A \$598
							B \$635
							C \$697
							D \$778
							E \$861
							F \$987
							G \$1,123
							H \$1,268
							I \$1,494
							J \$1,766

52 3/16" h Tackable Wall Panel	1	24	52 3/16	14	3	VSB2453WPTK	COM \$518
 <ul style="list-style-type: none"> • use with 19 3/16" h credenza for 72" overall height (nothing above) • com ydg: 1 3/4 							A \$537
							B \$573
							C \$636
							D \$717
							E \$800
							F \$926
							G \$1,061
							H \$1,207
							I \$1,432
							J \$1,704

52 3/16" h Tackable Wall Panel	1	18	52 3/16	11	2	VSB1853WPTK	COM \$465
 <ul style="list-style-type: none"> • use with 19 3/16" h credenza for 72" overall height (nothing above) • com ydg: 1 3/4 							A \$483
							B \$520
							C \$583
							D \$664
							E \$747
							F \$873
							G \$1,008
							H \$1,153
							I \$1,380
							J \$1,650

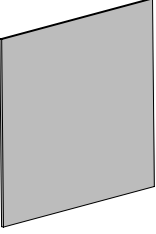
To Order, Specify:

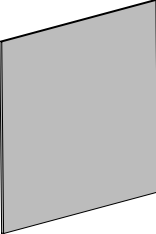
① Model Number

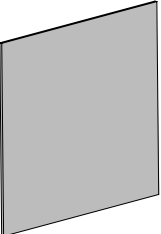
② Fabric Selection: vendor, pattern, color

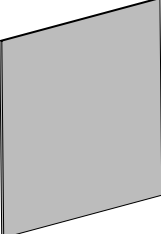
Visit www.jsifurniture.com/finishes-and-materials/textiles

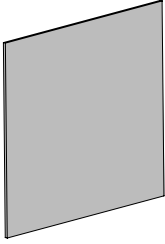
for our textiles program. See selection of standard and graded in manufacturers and patterns.

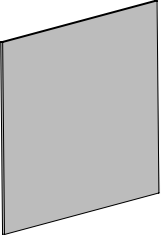
Description	D	W	H	CTN WT	CU FT	① Model	List Price Per Grade
49 7/16" h Tackable Wall Panel	1	48	49 7/16	27	5	VSB4850WPTK	COM \$731
						<ul style="list-style-type: none"> • use with 19 13/16" h credenza and 14 3/4" h L-shelf for 84" overall height • com ydg: 1 1/2 	A \$748 B \$778 C \$832 D \$902 E \$973 F \$1,082 G \$1,197 H \$1,322 I \$1,514 J \$1,748

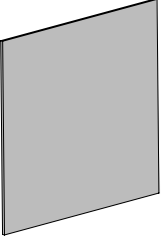
49 7/16" h Tackable Wall Panel	1	42	49 7/16	24	4	VSB4250WPTK	COM \$667
						<ul style="list-style-type: none"> • use with 19 13/16" h credenza and 14 3/4" h L-shelf for 84" overall height • com ydg: 1 1/2 	A \$682 B \$714 C \$767 D \$837 E \$909 F \$1,016 G \$1,132 H \$1,257 I \$1,450 J \$1,684

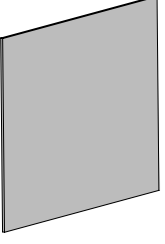
49 7/16" h Tackable Wall Panel	1	39	49 7/16	22	4	VSB3950WPTK	COM \$642
						<ul style="list-style-type: none"> • use with 19 13/16" h credenza and 14 3/4" h L-shelf for 84" overall height • com ydg: 1 1/2 	A \$660 B \$690 C \$744 D \$813 E \$885 F \$993 G \$1,109 H \$1,234 I \$1,426 J \$1,660

49 7/16" h Tackable Wall Panel	1	36	49 7/16	20	4	VSB3650WPTK	COM \$608
						<ul style="list-style-type: none"> • use with 19 13/16" h credenza and 14 3/4" h L-shelf for 84" overall height • com ydg: 1 1/2 	A \$626 B \$655 C \$711 D \$779 E \$850 F \$959 G \$1,075 H \$1,199 I \$1,392 J \$1,625

Description	D	W	H	CTN WT	CU FT	① Model	List Price Per Grade
49 7/16" h Tackable Wall Panel	1	33	49 7/16	19	4	VSB3350WPTK	COM \$586
	<ul style="list-style-type: none"> • use with 19 3/16" h credenza and 14 3/4" h L-shelf for 84" overall height • com ydg: 1 1/2 						A \$601 B \$632 C \$686 D \$756 E \$827 F \$935 G \$1,050 H \$1,175 I \$1,369 J \$1,602

49 7/16" h Tackable Wall Panel	1	30	49 7/16	17	3	VSB3050WPTK	COM \$552
	<ul style="list-style-type: none"> • use with 19 3/16" h credenza and 14 3/4" h L-shelf for 84" overall height • com ydg: 1 1/2 						A \$568 B \$599 C \$653 D \$723 E \$793 F \$902 G \$1,017 H \$1,142 I \$1,336 J \$1,570

49 7/16" h Tackable Wall Panel	1	24	49 7/16	14	3	VSB2450WPTK	COM \$492
	<ul style="list-style-type: none"> • use with 19 3/16" h credenza and 14 3/4" h L-shelf for 84" overall height • com ydg: 1 1/2 						A \$509 B \$541 C \$594 D \$664 E \$735 F \$843 G \$959 H \$1,084 I \$1,277 J \$1,510

49 7/16" h Tackable Wall Panel	1	18	49 7/16	10	2	VSB1850WPTK	COM \$441
	<ul style="list-style-type: none"> • use with 19 3/16" h credenza and 14 3/4" h L-shelf for 84" overall height • com ydg: 1 1/2 						A \$458 B \$488 C \$543 D \$612 E \$682 F \$791 G \$907 H \$1,033 I \$1,225 J \$1,458

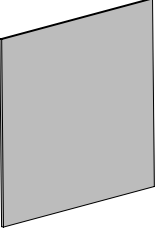
To Order, Specify:

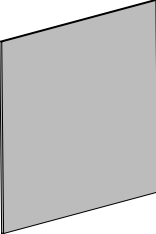
① Model Number

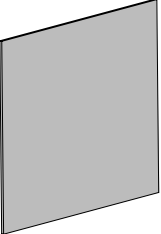
② Fabric Selection: vendor, pattern, color

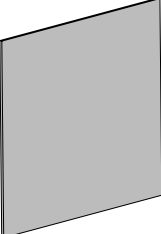
Visit www.jsifurniture.com/finishes-and-materials/textiles

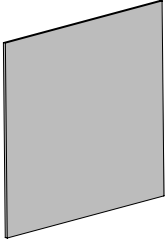
for our textiles program. See selection of standard and graded in manufacturers and patterns.

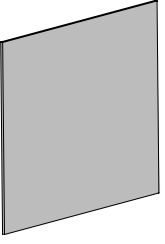
Description	D	W	H	CTN WT	CU FT	① Model	List Price Per Grade
42 ½" h Tackable Wall Panel	1	48	42½	23	4	VSB4842WPTK	COM \$678
 <ul style="list-style-type: none"> · use with 29 ½" h credenza for 72" overall height (nothing above) · com ydg: 1 ½ 							A \$694
							B \$725
							C \$779
							D \$849
							E \$919
							F \$1,028
							G \$1,144
							H \$1,269
							I \$1,462
							J \$1,696

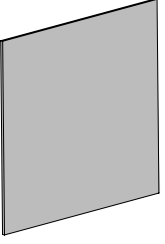
42 ½" h Tackable Wall Panel	1	42	42½	20	4	VSB4242WPTK	COM \$619
 <ul style="list-style-type: none"> · use with 29 ½" h credenza for 72" overall height (nothing above) · com ydg: 1 ½ 							A \$636
							B \$667
							C \$720
							D \$790
							E \$861
							F \$970
							G \$1,085
							H \$1,210
							I \$1,403
							J \$1,636

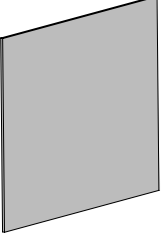
42 ½" h Tackable Wall Panel	1	39	42½	19	4	VSB3942WPTK	COM \$599
 <ul style="list-style-type: none"> · use with 29 ½" h credenza for 72" overall height (nothing above) · com ydg: 1 ½ 							A \$615
							B \$647
							C \$701
							D \$769
							E \$841
							F \$950
							G \$1,064
							H \$1,189
							I \$1,383
							J \$1,617

42 ½" h Tackable Wall Panel	1	36	42½	17	3	VSB3642WPTK	COM \$568
 <ul style="list-style-type: none"> · use with 29 ½" h credenza for 72" overall height (nothing above) · com ydg: 1 ½ 							A \$586
							B \$615
							C \$670
							D \$740
							E \$810
							F \$918
							G \$1,035
							H \$1,160
							I \$1,352
							J \$1,585

Description	D	W	H	CTN WT	CU FT	① Model	List Price Per Grade
42 1/2" h Tackable Wall Panel	1	33	42 1/2	16	3	VSB3342WPTK	COM \$548
 <ul style="list-style-type: none"> · use with 29 1/2" h credenza for 72" overall height (nothing above) · com ydg: 1 1/2 							A \$564
							B \$594
							C \$649
							D \$718
							E \$789
							F \$897
							G \$1,013
							H \$1,138
							I \$1,332
							J \$1,564

42 1/2" h Tackable Wall Panel	1	30	42 1/2	15	3	VSB3042WPTK	COM \$518
 <ul style="list-style-type: none"> · use with 29 1/2" h credenza for 72" overall height (nothing above) · com ydg: 1 1/2 							A \$533
							B \$565
							C \$619
							D \$689
							E \$760
							F \$868
							G \$983
							H \$1,109
							I \$1,301
							J \$1,535

42 1/2" h Tackable Wall Panel	1	24	42 1/2	12	3	VSB2442WPTK	COM \$466
 <ul style="list-style-type: none"> · use with 29 1/2" h credenza for 72" overall height (nothing above) · com ydg: 1 1/2 							A \$482
							B \$513
							C \$567
							D \$637
							E \$707
							F \$816
							G \$931
							H \$1,057
							I \$1,250
							J \$1,484

42 1/2" h Tackable Wall Panel	1	18	42 1/2	9	2	VSB1842WPTK	COM \$421
 <ul style="list-style-type: none"> · use with 29 1/2" h credenza for 72" overall height (nothing above) · com ydg: 1 1/2 							A \$438
							B \$468
							C \$523
							D \$592
							E \$663
							F \$771
							G \$887
							H \$1,012
							I \$1,206
							J \$1,439

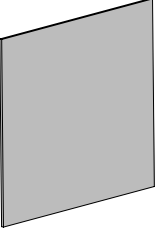
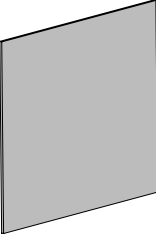
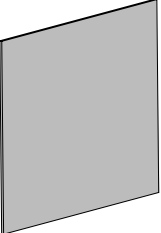
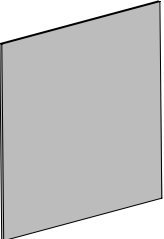
To Order, Specify:

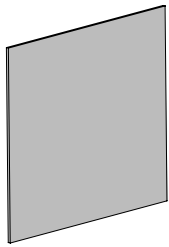
① Model Number

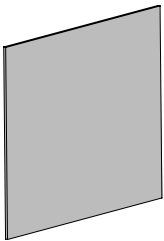
② Fabric Selection: vendor, pattern, color

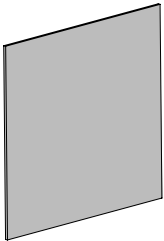
Visit www.jsifurniture.com/finishes-and-materials/textiles

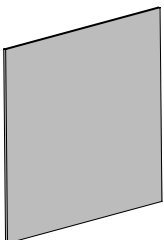
for our textiles program. See selection of standard and graded in manufacturers and patterns.

Description	D	W	H	CTN WT	CU FT	① Model	List Price Per Grade
39 3/4" h Tackable Wall Panel  <ul style="list-style-type: none"> · use with 29 1/2" h credenza and 14 3/4" h L-shelf for 84" overall height · com ydg: 1 1/4 	1	48	39 3/4	22	4	VSB4840WPTK	COM \$643 A \$658 B \$682 C \$728 D \$787 E \$846 F \$935 G \$1,034 H \$1,135 I \$1,297 J \$1,492
39 3/4" h Tackable Wall Panel  <ul style="list-style-type: none"> · use with 29 1/2" h credenza and 14 3/4" h L-shelf for 84" overall height · com ydg: 1 1/4 	1	42	39 3/4	19	4	VSB4240WPTK	COM \$588 A \$601 B \$627 C \$673 D \$729 E \$789 F \$878 G \$976 H \$1,079 I \$1,240 J \$1,434
39 3/4" h Tackable Wall Panel  <ul style="list-style-type: none"> · use with 29 1/2" h credenza and 14 3/4" h L-shelf for 84" overall height · com ydg: 1 1/4 	1	39	39 3/4	18	3	VSB3940WPTK	COM \$568 A \$583 B \$607 C \$653 D \$712 E \$769 F \$860 G \$958 H \$1,060 I \$1,221 J \$1,415
39 3/4" h Tackable Wall Panel  <ul style="list-style-type: none"> · use with 29 1/2" h credenza and 14 3/4" h L-shelf for 84" overall height · com ydg: 1 1/4 	1	36	39 3/4	16	3	VSB3640WPTK	COM \$539 A \$552 B \$577 C \$623 D \$680 E \$740 F \$829 G \$927 H \$1,029 I \$1,191 J \$1,385

Description	D	W	H	CTN WT	CU FT	① Model	List Price Per Grade
39 3/4" h Tackable Wall Panel	1	33	39 3/4	15	3	VSB3340WPTK	COM \$519
 <ul style="list-style-type: none"> · use with 29 1/2" h credenza and 14 3/4" h L-shelf for 84" overall height · com ydg: 1 1/4 							A \$532
							B \$557
							C \$604
							D \$662
							E \$720
							F \$810
							G \$909
							H \$1,011
							I \$1,172
							J \$1,366

39 3/4" h Tackable Wall Panel	1	30	39 3/4	14	3	VSB3040WPTK	COM \$490
 <ul style="list-style-type: none"> · use with 29 1/2" h credenza and 14 3/4" h L-shelf for 84" overall height · com ydg: 1 1/4 							A \$505
							B \$529
							C \$576
							D \$633
							E \$692
							F \$782
							G \$879
							H \$982
							I \$1,144
							J \$1,338

39 3/4" h Tackable Wall Panel	1	24	39 3/4	11	2	VSB2440WPTK	COM \$441
 <ul style="list-style-type: none"> · use with 29 1/2" h credenza and 14 3/4" h L-shelf for 84" overall height · com ydg: 1 1/4 							A \$456
							B \$480
							C \$526
							D \$584
							E \$642
							F \$732
							G \$830
							H \$933
							I \$1,094
							J \$1,289

39 3/4" h Tackable Wall Panel	1	18	39 3/4	8	2	VSB1840WPTK	COM \$399
 <ul style="list-style-type: none"> · use with 29 1/2" h credenza and 14 3/4" h L-shelf for 84" overall height · com ydg: 1 1/4 							A \$414
							B \$438
							C \$483
							D \$542
							E \$600
							F \$690
							G \$788
							H \$890
							I \$1,052
							J \$1,247

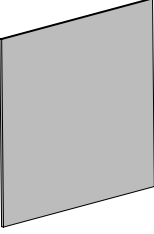
To Order, Specify:

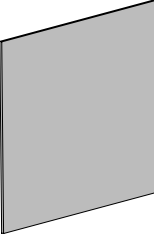
① Model Number

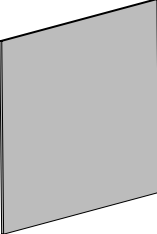
② Fabric Selection: vendor, pattern, color

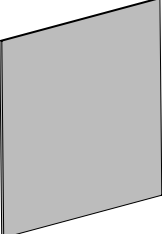
Visit www.jsifurniture.com/finishes-and-materials/textiles

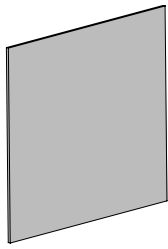
for our textiles program. See selection of standard and graded in manufacturers and patterns.

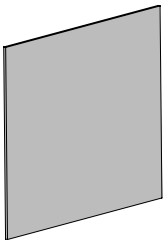
Description	D	W	H	CTN WT	CU FT	① Model	List Price Per Grade
34 1/16" h Tackable Wall Panel	1	48	34 1/16	19	4	VSB4835WPTK	COM \$605
 <ul style="list-style-type: none"> · use with 19 13/16" h credenza and 17 1/2" h wall mount overhead or L-shelf for 72" overall height · use with 19 13/16" h credenza and 29 1/2" h wall mount overhead or L-shelf for 84" overall height · com ydg: 1 1/4 							A \$619
							B \$643
							C \$690
							D \$748
							E \$806
							F \$896
							G \$995
							H \$1,097
							I \$1,258
							J \$1,452

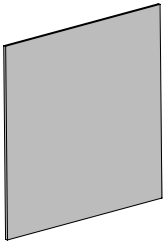
34 1/16" h Tackable Wall Panel	1	42	34 1/16	17	3	VSB4235WPTK	COM \$553
 <ul style="list-style-type: none"> · use with 19 13/16" h credenza and 17 1/2" h wall mount overhead or L-shelf for 72" overall height · use with 19 13/16" h credenza and 29 1/2" h wall mount overhead or L-shelf for 84" overall height · com ydg: 1 1/4 							A \$567
							B \$592
							C \$638
							D \$695
							E \$755
							F \$844
							G \$941
							H \$1,045
							I \$1,207
							J \$1,401

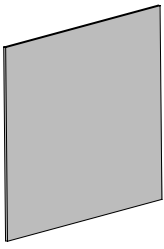
34 1/16" h Tackable Wall Panel	1	39	34 1/16	16	3	VSB3935WPTK	COM \$537
 <ul style="list-style-type: none"> · use with 19 13/16" h credenza and 17 1/2" h wall mount overhead or L-shelf for 72" overall height · use with 19 13/16" h credenza and 29 1/2" h wall mount overhead or L-shelf for 84" overall height · com ydg: 1 1/4 							A \$551
							B \$576
							C \$621
							D \$679
							E \$738
							F \$828
							G \$926
							H \$1,028
							I \$1,189
							J \$1,384

34 1/16" h Tackable Wall Panel	1	36	34 1/16	14	3	VSB3635WPTK	COM \$509
 <ul style="list-style-type: none"> · use with 19 13/16" h credenza and 17 1/2" h wall mount overhead or L-shelf for 72" overall height · use with 19 13/16" h credenza and 29 1/2" h wall mount overhead or L-shelf for 84" overall height · com ydg: 1 1/4 							A \$524
							B \$549
							C \$594
							D \$652
							E \$712
							F \$801
							G \$898
							H \$1,001
							I \$1,163
							J \$1,358

Description	D	W	H	CTN WT	CU FT	① Model	List Price Per Grade
34 1 ¹ / ₁₆ " h Tackable Wall Panel	1	33	34 1 ¹ / ₁₆	13	3	VSB3335WPTK	COM \$491
 <ul style="list-style-type: none"> · use with 19 1³/₁₆"h credenza and 17 1¹/₂"h wall mount overhead or L-shelf for 72" overall height · use with 19 1³/₁₆"h credenza and 29 1¹/₂"h wall mount overhead or L-shelf for 84" overall height · com ydg: 1 1¹/₄ 	A						\$506
	B						\$530
	C						\$577
	D						\$635
	E						\$693
	F						\$783
	G						\$881
	H						\$983
	I						\$1,145
	J						\$1,339

34 1 ¹ / ₁₆ " h Tackable Wall Panel	1	30	34 1 ¹ / ₁₆	12	3	VSB3035WPTK	COM \$466
 <ul style="list-style-type: none"> · use with 19 1³/₁₆"h credenza and 17 1¹/₂"h wall mount overhead or L-shelf for 72" overall height · use with 19 1³/₁₆"h credenza and 29 1¹/₂"h wall mount overhead or L-shelf for 84" overall height · com ydg: 1 1¹/₄ 	A						\$480
	B						\$505
	C						\$551
	D						\$608
	E						\$668
	F						\$757
	G						\$854
	H						\$958
	I						\$1,120
	J						\$1,314

34 1 ¹ / ₁₆ " h Tackable Wall Panel	1	24	34 1 ¹ / ₁₆	10	2	VSB2435WPTK	COM \$421
 <ul style="list-style-type: none"> · use with 19 1³/₁₆"h credenza and 17 1¹/₂"h wall mount overhead or L-shelf for 72" overall height · use with 19 1³/₁₆"h credenza and 29 1¹/₂"h wall mount overhead or L-shelf for 84" overall height · com ydg: 1 1¹/₄ 	A						\$436
	B						\$460
	C						\$506
	D						\$564
	E						\$623
	F						\$713
	G						\$810
	H						\$913
	I						\$1,075
	J						\$1,269

34 1 ¹ / ₁₆ " h Tackable Wall Panel	1	18	34 1 ¹ / ₁₆	7	2	VSB1835WPTK	COM \$383
 <ul style="list-style-type: none"> · use with 29 1¹/₂"h credenza and 17 1¹/₂"h wall mount overhead or L-shelf for 72" overall height · use with 29 1¹/₂"h credenza and 29 1¹/₂"h wall mount overhead or L-shelf for 84" overall height · com ydg: 1 1¹/₄ 	A						\$397
	B						\$422
	C						\$468
	D						\$526
	E						\$586
	F						\$675
	G						\$772
	H						\$875
	I						\$1,037
	J						\$1,232

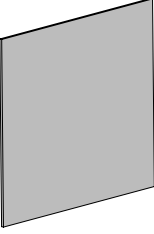
To Order, Specify:

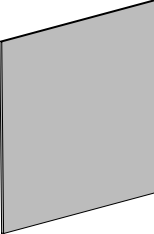
① Model Number

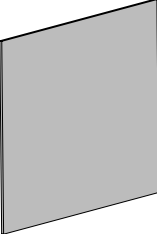
② Fabric Selection: vendor, pattern, color

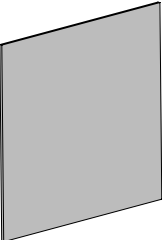
Visit www.jsifurniture.com/finishes-and-materials/textiles

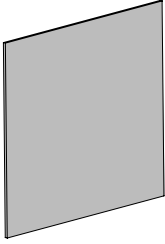
for our textiles program. See selection of standard and graded in manufacturers and patterns.

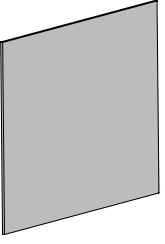
Description	D	W	H	CTN WT	CU FT	① Model	List Price Per Grade
25" h Tackable Wall Panel	1	48	25	14	3	VSB4825WPTK	COM \$521
 <ul style="list-style-type: none"> · use with 29 ½" h credenza and 17 ½" h wall mount overhead or L-shelf for 72" overall height · use with 29 ½" h credenza and 29 ½" h wall mount overhead or L-shelf for 84" overall height · com ydg: 1 							A \$531
							B \$553
							C \$590
							D \$636
							E \$682
							F \$755
							G \$832
							H \$915
							I \$1,045
							J \$1,199

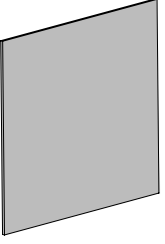
25" h Tackable Wall Panel	1	42	25	12	3	VSB4225WPTK	COM \$479
 <ul style="list-style-type: none"> · use with 29 ½" h credenza and 17 ½" h wall mount overhead or L-shelf for 72" overall height · use with 29 ½" h credenza and 29 ½" h wall mount overhead or L-shelf for 84" overall height · com ydg: 1 							A \$489
							B \$511
							C \$548
							D \$593
							E \$640
							F \$713
							G \$790
							H \$873
							I \$1,002
							J \$1,157

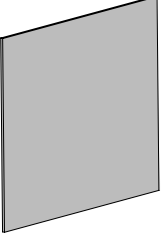
25" h Tackable Wall Panel	1	39	25	11	2	VSB3925WPTK	COM \$466
 <ul style="list-style-type: none"> · use with 29 ½" h credenza and 17 ½" h wall mount overhead or L-shelf for 72" overall height · use with 29 ½" h credenza and 29 ½" h wall mount overhead or L-shelf for 84" overall height · com ydg: 1 							A \$477
							B \$499
							C \$533
							D \$581
							E \$628
							F \$700
							G \$777
							H \$860
							I \$990
							J \$1,144

25" h Tackable Wall Panel	1	36	25	10	2	VSB3625WPTK	COM \$443
 <ul style="list-style-type: none"> · use with 29 ½" h credenza and 17 ½" h wall mount overhead or L-shelf for 72" overall height · use with 29 ½" h credenza and 29 ½" h wall mount overhead or L-shelf for 84" overall height · com ydg: 1 							A \$455
							B \$476
							C \$512
							D \$557
							E \$605
							F \$677
							G \$755
							H \$837
							I \$967
							J \$1,122

Description	D	W	H	CTN WT	CU FT	① Model	List Price Per Grade
25" h Tackable Wall Panel	1	33	25	10	2	VSB3325WPTK	COM \$431
 <ul style="list-style-type: none"> · use with 29 ½" h credenza and 17 ½" h wall mount overhead or L-shelf for 72" overall height · use with 29 ½" h credenza and 29 ½" h wall mount overhead or L-shelf for 84" overall height · com ydg: 1 							A \$441
							B \$463
							C \$500
							D \$545
							E \$592
							F \$664
							G \$742
							H \$825
							I \$954
							J \$1,109

25" h Tackable Wall Panel	1	30	25	9	2	VSB3025WPTK	COM \$407
 <ul style="list-style-type: none"> · use with 29 ½" h credenza and 17 ½" h wall mount overhead or L-shelf for 72" overall height · use with 29 ½" h credenza and 29 ½" h wall mount overhead or L-shelf for 84" overall height · com ydg: 1 							A \$419
							B \$440
							C \$477
							D \$523
							E \$569
							F \$641
							G \$719
							H \$802
							I \$931
							J \$1,086

25" h Tackable Wall Panel	1	24	25	7	2	VSB2425WPTK	COM \$372
 <ul style="list-style-type: none"> · use with 29 ½" h credenza and 17 ½" h wall mount overhead or L-shelf for 72" overall height · use with 29 ½" h credenza and 29 ½" h wall mount overhead or L-shelf for 84" overall height · com ydg: 1 							A \$382
							B \$403
							C \$440
							D \$486
							E \$532
							F \$605
							G \$682
							H \$765
							I \$894
							J \$1,049

25" h Tackable Wall Panel	1	18	25	5	1	VSB1825WPTK	COM \$343
 <ul style="list-style-type: none"> · use with 29 ½" h credenza and 17 ½" h wall mount overhead or L-shelf for 72" overall height · use with 29 ½" h credenza and 29 ½" h wall mount overhead or L-shelf for 84" overall height · com ydg: 1 							A \$354
							B \$376
							C \$413
							D \$458
							E \$505
							F \$577
							G \$654
							H \$737
							I \$867
							J \$1,021

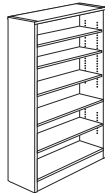
To Order, Specify:

① Model Number

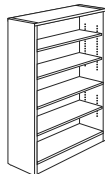
② Fabric Selection: vendor, pattern, color

Visit www.jsifurniture.com/finishes-and-materials/textiles

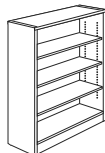
for our textiles program. See selection of standard and graded in manufacturers and patterns.

Description	D	W	H	CTN WT	CU FT	① Model	Laminate	Flat Cut Veneer	Double Cut Veneer
Bookcase 	15 7/16	35 7/8	84	181	35	VST3684BC	\$1,507		
	15 7/16	35 7/8	84	181	35	VSV3684BC		\$2,631	\$2,896
	15 7/16	29 7/8	84	170	29	VST3084BC	\$1,405		
	15 7/16	29 7/8	84	170	29	VSV3084BC		\$2,614	\$2,877

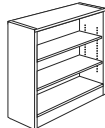
- four adjustable shelves
- one fixed shelf
- no profile edge
- unfinished backs
- secured to wall as a safety precaution

Bookcase 	15 7/16	35 7/8	72	155	30	VST3672BC	\$1,349		
	15 7/16	35 7/8	72	155	30	VSV3672BC		\$2,255	\$2,481
	15 7/16	29 7/8	72	145	25	VST3072BC	\$1,199		
	15 7/16	29 7/8	72	145	25	VSV3072BC		\$2,242	\$2,467

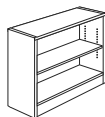
- three adjustable shelves
- one fixed shelf
- no profile edge
- unfinished backs

Bookcase 	15 7/16	35 7/8	55 7/16	115	23	VST3654BC	\$1,256		
	15 7/16	35 7/8	55 7/16	115	23	VSV3654BC		\$1,921	\$2,114
	15 7/16	29 7/8	55 7/16	108	20	VST3054BC	\$1,062		
	15 7/16	29 7/8	55 7/16	108	20	VSV3054BC		\$1,681	\$1,852

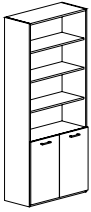
- three adjustable shelves
- no profile edge
- unfinished backs

Bookcase 	15 7/16	35 7/8	42 5/16	108	18	VST3642BC	\$1,158		
	15 7/16	35 7/8	42 5/16	108	18	VSV3642BC		\$1,795	\$1,976
	15 7/16	29 7/8	42 5/16	98	15	VST3042BC	\$928		
	15 7/16	29 7/8	42 5/16	98	15	VSV3042BC		\$1,538	\$1,693

- two adjustable shelves
- no profile edge
- unfinished backs

Bookcase 	15 7/16	35 7/8	30 5/16	108	13	VST3630BC	\$906		
	15 7/16	35 7/8	29 1/2	108	13	VSV3630BC		\$1,347	\$1,484
	15 7/16	29 7/8	29 1/2	98	11	VST3030BC	\$837		
	15 7/16	29 7/8	29 1/2	98	11	VSV3030BC		\$1,232	\$1,356

- one adjustable shelf
- no profile edge
- unfinished backs

Description	D	W	H	CTN WT	CU FT	① Model	Laminate	Flat Cut Veneer	Double Cut Veneer
	16 3/16	35 7/8	84	196	35	VST3684BCD	\$1,812		
	16 3/16	35 7/8	84	196	35	VSV3684BCD		\$2,965	\$3,263
	16 3/16	29 7/8	84	182	29	VST3084BCD	\$1,697		
	16 3/16	29 7/8	84	182	29	VSV3084BCD		\$2,950	\$3,247

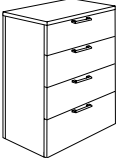
- three adjustable shelves (top section)
- one fixed shelf (top section)
- one adjustable shelf (bottom section)
- no profile edge
- locking available, specify and add \$47 list

	16 3/16	35 7/8	72	170	30	VST3672BCD	\$1,538		
	16 3/16	35 7/8	72	170	30	VSV3672BCD		\$2,591	\$2,850
	16 3/16	29 7/8	72	157	25	VST3072BCD	\$1,457		
	16 3/16	29 7/8	72	157	25	VSV3072BCD		\$2,576	\$2,833


- two adjustable shelves (top section)
- one fixed shelf (top section)
- one adjustable shelf (bottom section)
- no profile edge
- locking available, specify and add \$47 list

To Order, Specify:

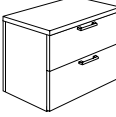
① Model Number	Laminate - VST	Veneer - VSV	
	<p>② Worksurface Material (see page VI3)</p> <p>a.) TFL</p> <p>b.) HPL</p> <p>③ Laminate Color (see page VI3)</p> <p>a.) Worksurface Color</p> <p>b.) Chassis Color</p> <p>c.) Drawer Color</p>	<p>② Wood Species - Cherry (CH1), Maple (MA1) Walnut (WA1), Black Oak (BO1) or Double Cut (DC1) (see page VI1)</p> <p>③ Finish Color (see page VI1)</p>	<p>④ Edge Profile (see page VI4)</p> <p>⑤ Pull Style and Color (see page VI5)</p> <p>⑥ Optional Grommet Location & Color - Matte Black (MBK) or Arctic Silver (ASL) (see page VI6)</p> <p>⑦ Other Product Options (see page VI10)</p> <p>⑧ Accessories (see page VS314)</p> <p>⑨ Power and Data Options (see page VS324)</p>

Description	D	W	H	CTN WT	CU FT	① Model	TFL Laminate	HPL Laminate	Flat Cut Veneer	Double Cut Veneer
	24	36	56½	287	34	VST2436-57LF	\$2,419	\$2,553		
	24	36	56½	287	34	VSV2436-57LF			\$3,292	\$3,632
	24	30	56½	270	29	VST2430-57LF	\$2,367	\$2,495		
	24	30	56½	270	29	VSV2430-57LF			\$3,113	\$3,434
	20	36	56½	266	29	VST2036-57LF	\$2,318	\$2,448		
	20	36	56½	266	29	VSV2036-57LF			\$3,160	\$3,484
	20	30	56½	251	24	VST2030-57LF	\$2,268	\$2,393		
	20	30	56½	251	24	VSV2030-57LF			\$2,985	\$3,293


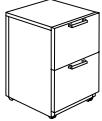


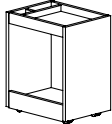
- top edge profile on user side
- four drawers
- anti-tip interlock mechanism
- locking available, specify and add \$126 list

	24	36	43½	232	26	VST2436-42LF	\$1,788	\$1,890		
	24	36	43½	232	26	VSV2436-42LF			\$2,963	\$3,271
	24	30	43½	218	22	VST2430-42LF	\$1,753	\$1,850		
	24	30	43½	218	22	VSV2430-42LF			\$2,662	\$2,939
	20	36	43½	216	22	VST2036-42LF	\$1,711	\$1,808		
	20	36	43½	216	22	VSV2036-42LF			\$2,839	\$3,135
	20	30	43½	201	19	VST2030-42LF	\$1,678	\$1,773		
	20	30	43½	201	19	VSV2030-42LF			\$2,554	\$2,820

- top edge profile on user side
- three drawers
- anti-tip interlock mechanism
- locking available, specify and add \$126 list

	24	36	29½	192	19	VST2436-30LF	\$1,268	\$1,338		
	24	36	29½	192	19	VSV2436-30LF			\$2,276	\$2,513
	24	30	29½	179	16	VST2430-30LF	\$1,192	\$1,259		
	24	30	29½	179	16	VSV2430-30LF			\$1,919	\$2,122
	20	36	29½	174	16	VST2036-30LF	\$1,213	\$1,281		
	20	36	29½	174	16	VSV2036-30LF			\$2,181	\$2,410
	20	30	29½	165	14	VST2030-30LF	\$1,139	\$1,203		
	20	30	29½	165	14	VSV2030-30LF			\$1,839	\$2,033

- top edge profile on user side
- two drawers
- chassis grommet available, specify and add \$49 list
- anti-tip interlock mechanism
- locking available, specify and add \$112 list

Description	D	W	H	CTN WT	CU FT	① Model	Laminate	Flat Cut Veneer	Double Cut Veneer
Box/Box/File Mobile Pedestal 	19 3/8	15 3/8	27 1/16	97	8	VST1620MP	\$1,023		
	19 3/8	15 3/8	27 1/16	97	8	VSV1620MP		\$1,762	\$1,944
File/File Mobile Pedestal 	19 3/8	15 3/8	27 1/16	97	8	VST1620-28FFMP	\$1,023		
	19 3/8	15 3/8	27 1/16	97	8	VSV1620-28FFMP		\$1,762	\$1,944
Box/File Mobile Pedestal 	17	15 3/8	21	68	5	VST1617-21BFMP	\$954		
	17	15 3/8	21	68	5	VSV1617-21BFMP		\$1,597	\$1,757
Box/File Compact Mobile Pedestal 	17	13	21	63	4	VST1317-21BFMP	\$938		
	17	13	21	63	4	VSV1317-21BFMP		\$1,577	\$1,735
Tray/Storage Compact Mobile Pedestal 	17	13	21	27	4	VST1317-21SMP	\$755		
	17	13	21	27	4	VSV1317-21SMP		\$1,517	\$1,669

- box/box/file only
- letter width pedestal
- locking available, specify and add \$80 list
- no additional top needed

- no additional top needed
- locking available, specify and add \$80 list




- no additional top needed
- locking available, specify and add \$80 list

- no additional top needed
- locking available, specify and add \$80 list

- non-handed
- top is divided for accessories
 - lower section: 11 3/8" x 12 1/16"
 - small section: 2" x 6 1/2"
 - smallest section: 2" x 4"

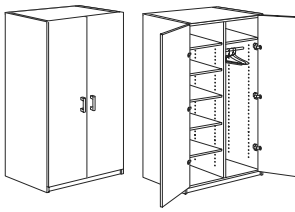
To Order, Specify:

① Model Number	Laminate - VST	Veneer - VSV
	<ul style="list-style-type: none"> ② Worksurface Material (see page V13) <ul style="list-style-type: none"> a.) TFL b.) HPL ③ Laminate Color (see page V13) <ul style="list-style-type: none"> a.) Worksurface Color b.) Chassis Color c.) Drawer Color 	<ul style="list-style-type: none"> ② Wood Species - Cherry (CH1), Maple (MA1) Walnut (WA1), Black Oak (BO1) or Double Cut (DC1) (see page V11) ③ Finish Color (see page V11)
		<ul style="list-style-type: none"> ④ Edge Profile (see page V14) ⑤ Pull Style and Color (see page V15) ⑥ Optional Grommet Location & Color - Matte Black (MBK) or Arctic Silver (ASL) (see page V16) ⑦ Other Product Options (see page V110) ⑧ Accessories (see page VS314) ⑨ Power and Data Options (see page VS324)

Description	D	W	H	CTN WT	CU FT	① Model	List Price Per Grade		
Laminate Box/File Mobile Pedestal with Cushion  <ul style="list-style-type: none"> locking available, specify and add \$80 list com ydg: 1 	17	15%	23	68	5	VST1617-21BFMPC	COM \$1,178 A \$1,186 B \$1,203 C \$1,232 D \$1,269 E \$1,304 F \$1,364 G \$1,424 H \$1,489 I \$1,592 J \$1,713 L1 \$1,468 L2 \$1,551		
	Flat Cut Veneer Box/File Mobile Pedestal with Cushion  <ul style="list-style-type: none"> locking available, specify and add \$80 list com ydg: 1 	17	15%	23	68	5	VSV1617-21BFMPC	COM \$1,858 A \$1,866 B \$1,882 C \$1,911 D \$1,949 E \$1,984 F \$2,043 G \$2,104 H \$2,168 I \$2,272 J \$2,393 L1 \$2,148 L2 \$2,231	
		Double Cut Veneer Box/File Mobile Pedestal with Cushion  <ul style="list-style-type: none"> locking available, specify and add \$80 list com ydg: 1 	17	15%	23	68	5	VSV1617-21BFMPC	COM \$2,043 A \$2,052 B \$2,068 C \$2,097 D \$2,135 E \$2,169 F \$2,229 G \$2,289 H \$2,354 I \$2,457 J \$2,578 L1 \$2,333 L2 \$2,416

To Order, Specify:

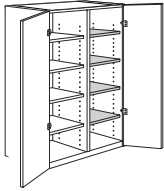
- ① Model Number
- ② Fabric Selection: vendor, pattern, color

Description	D	W	H	CTN WT	CU FT	① Model	Laminate	Flat Cut Veneer	Double Cut Veneer
84" h Wardrobe 	23 7/8	35 7/8	84	264	50	VST2436-84W	\$3,009		
	23 7/8	35 7/8	84	264	50	VSV2436-84W		\$4,465	\$4,912
	23 7/8	29 7/8	84	248	42	VST2430-84W	\$2,854		
	23 7/8	29 7/8	84	248	42	VSV2430-84W		\$4,040	\$4,444
	19 5/8	35 7/8	84	230	42	VST2036-84W	\$2,741		
	19 5/8	35 7/8	84	230	42	VSV2036-84W		\$4,241	\$4,665
	19 5/8	29 7/8	84	216	36	VST2030-84W	\$2,661		
	19 5/8	29 7/8	84	216	36	VSV2030-84W		\$3,840	\$4,220

- right side - chrome hanging bar with fixed shelf
- left side - three adjustable shelves; top shelf and shelf second from bottom fixed
- locking available, specify and add \$47 list

72" h Wardrobe 	23 7/8	35 7/8	72	226	43	VST2436-72W	\$2,615		
	23 7/8	35 7/8	72	226	43	VSV2436-72W		\$4,043	\$4,447
	23 7/8	29 7/8	72	212	36	VST2430-72W	\$2,400		
	23 7/8	29 7/8	72	212	36	VSV2430-72W		\$3,605	\$3,964
	19 5/8	35 7/8	72	197	36	VST2036-72W	\$2,351		
	19 5/8	35 7/8	72	197	36	VSV2036-72W		\$3,842	\$4,227
	19 5/8	29 7/8	72	185	31	VST2030-72W	\$2,279		
	19 5/8	29 7/8	72	185	31	VSV2030-72W		\$3,424	\$3,765

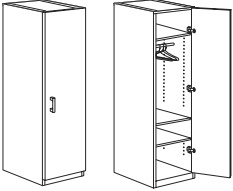
- right side - chrome hanging bar
- left side - three adjustable shelves; shelf second from bottom fixed
- locking available, specify and add \$47 list

Hanging Bar to Shelves Conversion Kit 			3/4	18	2	VST1824SK	\$697		
			3/4	18	2	VSV1824SK		\$858	\$943
			3/4	15	2	VST1524SK	\$691		
			3/4	15	2	VSV1524SK		\$843	\$928
			3/4	16	2	VST1820SK	\$663		
			3/4	16	2	VSV1820SK		\$816	\$896
			3/4	14	2	VST1520SK	\$655		
			3/4	14	2	VSV1520SK		\$803	\$885

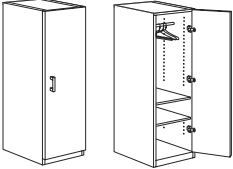
- four shelves
- VST1824SK or VSV1824SK - for VST2436-84W or VSV2436-84W and VST2436-72W or VSV2436-72W
- VST1524SK or VSV1524SK - for VST2430-84W or VSV2430-84W and VST2430-72W or VSV2430-72W
- VST1820SK or VSV1820SK - for VST2036-84W or VSV2036-84W and VST2036-72W or VSV2036-72W
- VST1520SK or VSV1520SK - for VST2030-84W or VSV2030-84W and VST2030-72W or VSV2030-72W

To Order, Specify:

① Model Number	Laminate - VST	Veneer - VSV
② Worksurface Material (see page V13)	② Wood Species - Cherry (CH1), Maple (MA1) Walnut (WA1), Black Oak (BO1) or Double Cut (DC1) (see page V11)	④ Edge Profile (see page V14)
a.) TFL		⑤ Pull Style and Color (see page V15)
b.) HPL		⑥ Optional Grommet Location & Color - Matte Black (MBK) or Arctic Silver (ASL) (see page V16)
③ Laminate Color (see page V13)	③ Finish Color (see page V11)	⑦ Other Product Options (see page V110)
a.) Worksurface Color		⑧ Accessories (see page VS314)
b.) Chassis Color		⑨ Power and Data Options (see page VS324)
c.) Drawer Color		

Description	D	W	H	CTN WT	CU FT	① Model	Laminate	Flat Cut Veneer	Double Cut Veneer
 right shown	23 $\frac{5}{8}$	17 $\frac{7}{8}$	84	181	26	VST2418-84WR	\$2,012		
	23 $\frac{5}{8}$	17 $\frac{7}{8}$	84	181	26	VSV2418-84WR		\$3,583	\$3,941
	23 $\frac{5}{8}$	17 $\frac{7}{8}$	84	181	26	VST2418-84WL	\$2,012		
	23 $\frac{5}{8}$	17 $\frac{7}{8}$	84	181	26	VSV2418-84WL		\$3,583	\$3,941
	19 $\frac{5}{8}$	17 $\frac{7}{8}$	84	158	22	VST2018-84WR	\$1,915		
	19 $\frac{5}{8}$	17 $\frac{7}{8}$	84	158	22	VSV2018-84WR		\$3,403	\$3,747
	19 $\frac{5}{8}$	17 $\frac{7}{8}$	84	158	22	VST2018-84WL	\$1,915		
	19 $\frac{5}{8}$	17 $\frac{7}{8}$	84	158	22	VSV2018-84WL		\$3,403	\$3,747

- chrome hanging bar and fixed shelf at top
- one adjustable shelf and one fixed shelf 29" from cabinet floor
- locking available, specify and add \$40 list

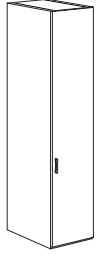
 right shown	23 $\frac{5}{8}$	17 $\frac{7}{8}$	72	155	23	VST2418-72WR	\$1,728		
	23 $\frac{5}{8}$	17 $\frac{7}{8}$	72	155	23	VSV2418-72WR		\$3,163	\$3,480
	23 $\frac{5}{8}$	17 $\frac{7}{8}$	72	155	23	VST2418-72WL	\$1,728		
	23 $\frac{5}{8}$	17 $\frac{7}{8}$	72	155	23	VSV2418-72WL		\$3,163	\$3,480
	19 $\frac{5}{8}$	17 $\frac{7}{8}$	72	135	19	VST2018-72WR	\$1,638		
	19 $\frac{5}{8}$	17 $\frac{7}{8}$	72	135	19	VSV2018-72WR		\$2,917	\$3,210
	19 $\frac{5}{8}$	17 $\frac{7}{8}$	72	135	19	VST2018-72WL	\$1,638		
	19 $\frac{5}{8}$	17 $\frac{7}{8}$	72	135	19	VSV2018-72WL		\$2,917	\$3,210

- chrome hanging bar at top
- one adjustable shelf and one fixed shelf 29" from cabinet floor
- locking available, specify and add \$40 list

Hanging Bar to Shelves Conversion Kit 			$\frac{3}{4}$	16	2	VST1624SK	\$548		
			$\frac{3}{4}$	16	2	VSV1624SK		\$680	\$748
			$\frac{3}{4}$	14	2	VST1620SK	\$529		
			$\frac{3}{4}$	14	2	VSV1620SK		\$649	\$711

- two shelves
- VST1624SK or VSV1624SK- for VST2418-84WR/WL or VSV2418-84WR/WL and VST2418-72WR/WL or VSV2418-72WR/WL
- VST1620SK or VSV1620SK- for VST2018-84WR/WL or VSV2018-84WR/WL and VST2018-72WR/WL or VSV2018-72WR/WL

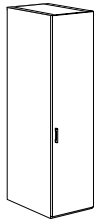
Description	D	W	H	CTN WT	CU FT	① Model	Laminate	Flat Cut Veneer	Double Cut Veneer
84" h Storage Cabinet	23 5/8	17 7/8	84	137	26	VST2418-84HR	\$2,030		
	23 5/8	17 7/8	84	137	26	VSV2418-84HR		\$3,608	\$3,970
	23 5/8	17 7/8	84	137	26	VST2418-84HL	\$2,030		
	23 5/8	17 7/8	84	137	26	VSV2418-84HL		\$3,608	\$3,970
	19 5/8	17 7/8	84	120	22	VST2018-84HR	\$1,927		
	19 5/8	17 7/8	84	120	22	VSV2018-84HR		\$3,428	\$3,770
	19 5/8	17 7/8	84	120	22	VST2018-84HL	\$1,927		
	19 5/8	17 7/8	84	120	22	VSV2018-84HL		\$3,428	\$3,770



right shown

- one fixed shelf 29 1/2" from cabinet floor
- four adjustable shelves
- locking available, specify and add \$40 list

Description	D	W	H	CTN WT	CU FT	① Model	Laminate	Flat Cut Veneer	Double Cut Veneer
72" h Storage Cabinet	23 5/8	17 7/8	72	165	23	VST2418-72HR	\$1,742		
	23 5/8	17 7/8	72	165	23	VSV2418-72HR		\$3,084	\$3,393
	23 5/8	17 7/8	72	165	23	VST2418-72HL	\$1,742		
	23 5/8	17 7/8	72	165	23	VSV2418-72HL		\$3,084	\$3,393
	19 5/8	17 7/8	72	144	19	VST2018-72HR	\$1,657		
	19 5/8	17 7/8	72	144	19	VSV2018-72HR		\$2,932	\$3,224
	19 5/8	17 7/8	72	144	19	VST2018-72HL	\$1,657		
	19 5/8	17 7/8	72	144	19	VSV2018-72HL		\$2,932	\$3,224



right shown

- one fixed shelf 29 1/2" from cabinet floor
- three adjustable shelves
- locking available, specify and add \$40 list

To Order, Specify:

① Model Number

Laminate - VST

Veneer - VSV

② Worksurface Material (see page V13)

- a.) TFL
- b.) HPL

③ Laminate Color (see page V13)

- a.) Worksurface Color
- b.) Chassis Color
- c.) Drawer Color

② Wood Species - Cherry (CH1), Maple (MA1)

- Walnut (WA1), Black Oak (BO1) or
- Double Cut (DC1) (see page V11)

③ Finish Color (see page V11)

④ Edge Profile (see page V14)

⑤ Pull Style and Color (see page V15)

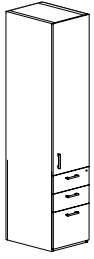
⑥ Optional Grommet Location & Color -
Matte Black (MBK) or Arctic Silver (ASL)
(see page V16)

⑦ Other Product Options (see page V110)

⑧ Accessories (see page VS314)

⑨ Power and Data Options (see page VS324)

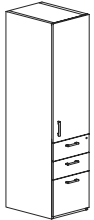
Description	D	W	H	CTN WT	CU FT	① Model	Laminate	Flat Cut Veneer	Double Cut Veneer
84" h Box/Box/File Storage Cabinet	23%	17%	84	205	26	VST2418-84BBFTR	\$2,630		
	23%	17%	84	205	26	VSV2418-84BBFTR		\$4,210	\$4,638
	23%	17%	84	205	26	VST2418-84BBFTL	\$2,630		
	23%	17%	84	205	26	VSV2418-84BBFTL		\$4,210	\$4,638
	19%	17%	84	179	22	VST2018-84BBFTR	\$2,494		
	19%	17%	84	179	22	VSV2018-84BBFTR		\$3,997	\$4,403
	19%	17%	84	179	22	VST2018-84BBFTL	\$2,494		
	19%	17%	84	179	22	VSV2018-84BBFTL		\$3,997	\$4,403



right shown

- three adjustable shelves
- locking available, specify and add \$118 list

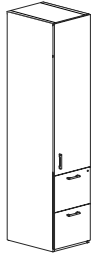
Description	D	W	H	CTN WT	CU FT	① Model	Laminate	Flat Cut Veneer	Double Cut Veneer
72" h Box/Box/File Storage Cabinet	23%	17%	72	177	23	VST2418-72BBFTR	\$2,429		
	23%	17%	72	177	23	VSV2418-72BBFTR		\$3,891	\$4,287
	23%	17%	72	177	23	VST2418-72BBFTL	\$2,429		
	23%	17%	72	177	23	VSV2418-72BBFTL		\$3,891	\$4,287
	19%	17%	72	154	19	VST2018-72BBFTR	\$2,305		
	19%	17%	72	154	19	VSV2018-72BBFTR		\$3,694	\$4,071
	19%	17%	72	154	19	VST2018-72BBFTL	\$2,305		
	19%	17%	72	154	19	VSV2018-72BBFTL		\$3,694	\$4,071



right shown

- two adjustable shelves
- locking available, specify and add \$118 list

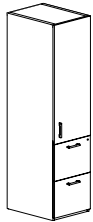
Description	D	W	H	CTN WT	CU FT	① Model	Laminate	Flat Cut Veneer	Double Cut Veneer
84" h File/File Storage Cabinet	23 5/8	17 7/8	84	205	26	VST2418-84FFTR	\$2,621		
	23 5/8	17 7/8	84	205	26	VSV2418-84FFTR		\$4,195	\$4,623
	23 5/8	17 7/8	84	205	26	VST2418-84FFTL	\$2,621		
	23 5/8	17 7/8	84	205	26	VSV2418-84FFTL		\$4,195	\$4,623
	19 5/8	17 7/8	84	179	22	VST2018-84FFTR	\$2,487		
	19 5/8	17 7/8	84	179	22	VSV2018-84FFTR		\$3,985	\$4,391
	19 5/8	17 7/8	84	179	22	VST2018-84FFTL	\$2,487		
	19 5/8	17 7/8	84	179	22	VSV2018-84FFTL		\$3,985	\$4,391



right shown

- three adjustable shelves
- locking available, specify and add \$118 list

72" h File/File Storage Cabinet	23 5/8	17 7/8	72	177	23	VST2418-72FFTR	\$2,419		
	23 5/8	17 7/8	72	177	23	VSV2418-72FFTR		\$3,878	\$4,275
	23 5/8	17 7/8	72	177	23	VST2418-72FFTL	\$2,419		
	23 5/8	17 7/8	72	177	23	VSV2418-72FFTL		\$3,878	\$4,275
	19 5/8	17 7/8	72	154	19	VST2018-72FFTR	\$2,299		
	19 5/8	17 7/8	72	154	19	VSV2018-72FFTR		\$3,682	\$4,057
	19 5/8	17 7/8	72	154	19	VST2018-72FFTL	\$2,299		
	19 5/8	17 7/8	72	154	19	VSV2018-72FFTL		\$3,682	\$4,057



right shown

- two adjustable shelves
- locking available, specify and add \$118 list

To Order, Specify:

① Model Number

Laminate - VST

Veneer - VSV

② Worksurface Material (see page VI3)

- a.) TFL
- b.) HPL

③ Laminate Color (see page VI3)

- a.) Worksurface Color
- b.) Chassis Color
- c.) Drawer Color

② Wood Species - Cherry (CH1), Maple (MA1)

- Walnut (WA1), Black Oak (BO1) or
- Double Cut (DC1) (see page VI1)

③ Finish Color (see page VI1)

④ Edge Profile (see page VI4)

⑤ Pull Style and Color (see page VI5)

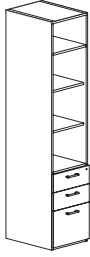
⑥ Optional Grommet Location & Color -
Matte Black (MBK) or Arctic Silver (ASL)
(see page VI6)

⑦ Other Product Options (see page VI10)

⑧ Accessories (see page VS314)

⑨ Power and Data Options (see page VS324)

Description	D	W	H	CTN WT	CU FT	① Model	Laminate	Flat Cut Veneer	Double Cut Veneer
84" h Open Top, Box/Box/File Storage Cabinet	23%	17%	84	197	26	VST2418-84BBFO	\$2,537		
	23%	17%	84	197	26	VSV2418-84BBFO		\$4,064	\$4,477
	19%	17%	84	172	22	VST2018-84BBFO	\$2,410		
	19%	17%	84	172	22	VSV2018-84BBFO		\$3,858	\$4,253



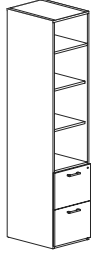
- two adjustable shelves, top shelf fixed
- box/box/file pedestal
- locking available, specify and add \$80 list

72" h Open Top, Box/Box/File Storage Cabinet	23%	17%	72	185	23	VST2418-72BBFO	\$2,339		
	23%	17%	72	185	23	VSV2418-72BBFO		\$3,744	\$4,129
	19%	17%	72	161	19	VST2018-72BBFO	\$2,217		
	19%	17%	72	161	19	VSV2018-72BBFO		\$3,555	\$3,918



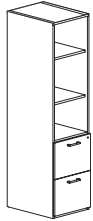
- two adjustable shelves
- box/box/file pedestal
- locking available, specify and add \$80 list

Description	D	W	H	CTN WT	CU FT	① Model	Laminate	Flat Cut Veneer	Double Cut Veneer
84" h Open Top, File/File Storage Cabinet	23 $\frac{5}{8}$	17 $\frac{7}{8}$	84	197	26	VST2418-84FFO	\$2,522		
	23 $\frac{5}{8}$	17 $\frac{7}{8}$	84	197	26	VSV2418-84FFO		\$4,051	\$4,463
	19 $\frac{5}{8}$	17 $\frac{7}{8}$	84	172	22	VST2018-84FFO	\$2,391		
	19 $\frac{5}{8}$	17 $\frac{7}{8}$	84	172	22	VSV2018-84FFO		\$3,847	\$4,238



- two adjustable shelves, top shelf fixed
- file/file pedestal
- locking available, specify and add \$80 list

72" h Open Top, File/File Storage Cabinet	23 $\frac{5}{8}$	17 $\frac{7}{8}$	72	185	23	VST2418-72FFO	\$2,320		
	23 $\frac{5}{8}$	17 $\frac{7}{8}$	72	185	23	VSV2418-72FFO		\$3,734	\$4,112
	19 $\frac{5}{8}$	17 $\frac{7}{8}$	72	161	19	VST2018-72FFO	\$2,201		
	19 $\frac{5}{8}$	17 $\frac{7}{8}$	72	161	19	VSV2018-72FFO		\$3,544	\$3,905

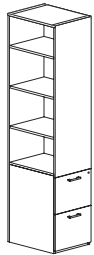


- two adjustable shelves
- file/file pedestal
- locking available, specify and add \$80 list

To Order, Specify:

① Model Number	Laminate - VST	Veneer - VSV	
	<p>② Worksurface Material (see page VI3)</p> <p>a.) TFL</p> <p>b.) HPL</p> <p>③ Laminate Color (see page VI3)</p> <p>a.) Worksurface Color</p> <p>b.) Chassis Color</p> <p>c.) Drawer Color</p>	<p>② Wood Species - Cherry (CH1), Maple (MA1) Walnut (WA1), Black Oak (BO1) or Double Cut (DC1) (see page VI1)</p> <p>③ Finish Color (see page VI1)</p>	<p>④ Edge Profile (see page VI4)</p> <p>⑤ Pull Style and Color (see page VI5)</p> <p>⑥ Optional Grommet Location & Color - Matte Black (MBK) or Arctic Silver (ASL) (see page VI6)</p> <p>⑦ Other Product Options (see page VI10)</p> <p>⑧ Accessories (see page VS314)</p> <p>⑨ Power and Data Options (see page VS324)</p>

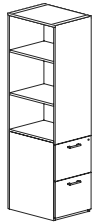
Description	D	W	H	CTN WT	CU FT	① Model	Laminate	Flat Cut Veneer	Double Cut Veneer
84" h File/File Storage Cabinet with Side Access	23%	17%	84	197	26	VST2418-84FFSSTR	\$2,538		
	23%	17%	84	197	26	VSV2418-84FFSSTR		\$4,235	\$4,666
	23%	17%	84	197	26	VST2418-84FFSSTL	\$2,538		
	23%	17%	84	197	26	VSV2418-84FFSSTL		\$4,235	\$4,666
	19%	17%	84	172	22	VST2018-84FFSSTR	\$2,411		
	19%	17%	84	172	22	VSV2018-84FFSSTR		\$4,022	\$4,431
	19%	17%	84	172	22	VST2018-84FFSSTL	\$2,411		
	19%	17%	84	172	22	VSV2018-84FFSSTL		\$4,022	\$4,431



right shown

- two adjustable shelves, top shelf fixed
- file/file pedestal
- locking available, specify and add \$80 list

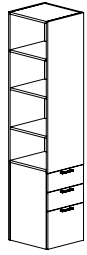
Description	D	W	H	CTN WT	CU FT	① Model	Laminate	Flat Cut Veneer	Double Cut Veneer
72" h File/File Storage Cabinet with Side Access	23%	17%	72	185	23	VST2418-72FFSSTR	\$2,339		
	23%	17%	72	185	23	VSV2418-72FFSSTR		\$3,908	\$4,305
	23%	17%	72	185	23	VST2418-72FFSSTL	\$2,339		
	23%	17%	72	185	23	VSV2418-72FFSSTL		\$3,908	\$4,305
	19%	17%	72	161	19	VST2018-72FFSSTR	\$2,217		
	19%	17%	72	161	19	VSV2018-72FFSSTR		\$3,708	\$4,089
	19%	17%	72	161	19	VST2018-72FFSSTL	\$2,217		
	19%	17%	72	161	19	VSV2018-72FFSSTL		\$3,708	\$4,089



right shown

- two adjustable shelves
- file/file pedestal
- locking available, specify and add \$80 list

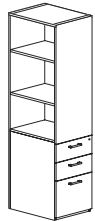
Description	D	W	H	CTN WT	CU FT	① Model	Laminate	Flat Cut Veneer	Double Cut Veneer
84" h Box/Box/File Storage Cabinet with Side Access	23 3/8"	17 7/8"	84"	197	26	VST2418-84BBFSSTR	\$2,557		
	23 3/8"	17 7/8"	84"	197	26	VSV2418-84BBFSSTR		\$4,248	\$4,679
	23 3/8"	17 7/8"	84"	197	26	VST2418-84BBFSSTL	\$2,557		
	23 3/8"	17 7/8"	84"	197	26	VSV2418-84BBFSSTL		\$4,248	\$4,679
	19 5/8"	17 7/8"	84"	172	22	VST2018-84BBFSSTR	\$2,427		
	19 5/8"	17 7/8"	84"	172	22	VSV2018-84BBFSSTR		\$4,034	\$4,444
	19 5/8"	17 7/8"	84"	172	22	VST2018-84BBFSSTL	\$2,427		
	19 5/8"	17 7/8"	84"	172	22	VSV2018-84BBFSSTL		\$4,034	\$4,444



right shown

- two adjustable shelves, top shelf fixed
- box/box/file pedestal
- locking available, specify and add \$80 list

72" h Box/Box/File Storage Cabinet with Side Access	23 3/8"	17 7/8"	72"	185	23	VST2418-72BBFSSTR	\$2,353		
	23 3/8"	17 7/8"	72"	185	23	VSV2418-72BBFSSTR		\$3,920	\$4,320
	23 3/8"	17 7/8"	72"	185	23	VST2418-72BBFSSTL	\$2,353		
	23 3/8"	17 7/8"	72"	185	23	VSV2418-72BBFSSTL		\$3,920	\$4,320
	19 5/8"	17 7/8"	72"	161	19	VST2018-72BBFSSTR	\$2,237		
	19 5/8"	17 7/8"	72"	161	19	VSV2018-72BBFSSTR		\$3,722	\$4,103
	19 5/8"	17 7/8"	72"	161	19	VST2018-72BBFSSTL	\$2,237		
	19 5/8"	17 7/8"	72"	161	19	VSV2018-72BBFSSTL		\$3,722	\$4,103



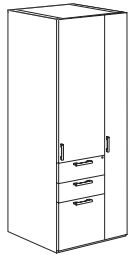
right shown

- two adjustable shelves
- box/box/file pedestal
- locking available, specify and add \$80 list

To Order, Specify:

① Model Number	Laminate - VST	Veneer - VSV	
	<ul style="list-style-type: none"> ② Worksurface Material (see page V13) <ul style="list-style-type: none"> a.) TFL b.) HPL ③ Laminate Color (see page V13) <ul style="list-style-type: none"> a.) Worksurface Color b.) Chassis Color c.) Drawer Color 	<ul style="list-style-type: none"> ② Wood Species - Cherry (CH1), Maple (MA1) Walnut (WA1), Black Oak (BO1) or Double Cut (DC1) (see page V11) ③ Finish Color (see page V11) 	<ul style="list-style-type: none"> ④ Edge Profile (see page V14) ⑤ Pull Style and Color (see page V15) ⑥ Optional Grommet Location & Color - Matte Black (MBK) or Arctic Silver (ASL) (see page V16) ⑦ Other Product Options (see page V110) ⑧ Accessories (see page VS314) ⑨ Power and Data Options (see page VS324)

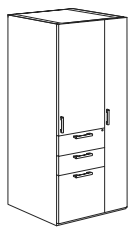
Description	D	W	H	CTN WT	CU FT	① Model	Laminate	Flat Cut Veneer	Double Cut Veneer
84" h Box/Box/File Storage Wardrobe	23 $\frac{5}{8}$	29 $\frac{7}{8}$	84	311	42	VST2430-84WR	\$3,350		
	23 $\frac{5}{8}$	29 $\frac{7}{8}$	84	311	42	VSV2430-84WR		\$5,353	\$5,894
	23 $\frac{5}{8}$	29 $\frac{7}{8}$	84	311	42	VST2430-84WL	\$3,350		
	23 $\frac{5}{8}$	29 $\frac{7}{8}$	84	311	42	VSV2430-84WL		\$5,353	\$5,894
	19 $\frac{5}{8}$	29 $\frac{7}{8}$	84	271	36	VST2030-84WR	\$3,180		
	19 $\frac{5}{8}$	29 $\frac{7}{8}$	84	271	36	VSV2030-84WR		\$5,082	\$5,597
	19 $\frac{5}{8}$	29 $\frac{7}{8}$	84	271	36	VST2030-84WL	\$3,180		
	19 $\frac{5}{8}$	29 $\frac{7}{8}$	84	271	36	VSV2030-84WL		\$5,082	\$5,597



right shown

- box/box/file pedestal
- chrome hanging bar
- three adjustable shelves
- locking available, specify and add \$157 list

Description	D	W	H	CTN WT	CU FT	① Model	Laminate	Flat Cut Veneer	Double Cut Veneer
72" h Box/Box/File Storage Wardrobe	23 $\frac{5}{8}$	29 $\frac{7}{8}$	72	271	36	VST2430-72WR	\$3,143		
	23 $\frac{5}{8}$	29 $\frac{7}{8}$	72	271	36	VSV2430-72WR		\$5,027	\$5,535
	23 $\frac{5}{8}$	29 $\frac{7}{8}$	72	271	36	VST2430-72WL	\$3,143		
	23 $\frac{5}{8}$	29 $\frac{7}{8}$	72	271	36	VSV2430-72WL		\$5,027	\$5,535
	19 $\frac{5}{8}$	29 $\frac{7}{8}$	72	236	31	VST2030-72WR	\$2,984		
	19 $\frac{5}{8}$	29 $\frac{7}{8}$	72	236	31	VSV2030-72WR		\$4,773	\$5,257
	19 $\frac{5}{8}$	29 $\frac{7}{8}$	72	236	31	VST2030-72WL	\$2,984		
	19 $\frac{5}{8}$	29 $\frac{7}{8}$	72	236	31	VSV2030-72WL		\$4,773	\$5,257



right shown

- box/box/file pedestal
- chrome hanging bar
- two adjustable shelves
- locking available, specify and add \$157 list

Description	D	W	H	CTN WT	CU FT	① Model	Laminate	Flat Cut Veneer	Double Cut Veneer
84" h Multi-File Storage Cabinet	23 5/8	29 7/8	84	344	42	VST2430-84MFR	\$3,140		
	23 5/8	29 7/8	84	344	42	VSV2430-84MFR		\$5,470	\$6,029
	23 5/8	29 7/8	84	344	42	VST2430-84MFL	\$3,140		
	23 5/8	29 7/8	84	344	42	VSV2430-84MFL		\$5,470	\$6,029
	19 5/8	29 7/8	84	300	36	VST2030-84MFR	\$2,983		
	19 5/8	29 7/8	84	300	36	VSV2030-84MFR		\$5,193	\$5,722
	19 5/8	29 7/8	84	300	36	VST2030-84MFL	\$2,983		
	19 5/8	29 7/8	84	300	36	VSV2030-84MFL		\$5,193	\$5,722



right shown

- three adjustable shelves
- locking available, specify and add \$160 list

Description	D	W	H	CTN WT	CU FT	① Model	Laminate	Flat Cut Veneer	Double Cut Veneer
72" h Multi-File Storage Cabinet	23 5/8	29 7/8	72	331	36	VST2430-72MFR	\$3,062		
	23 5/8	29 7/8	72	331	36	VSV2430-72MFR		\$5,219	\$5,752
	23 5/8	29 7/8	72	331	36	VST2430-72MFL	\$3,062		
	23 5/8	29 7/8	72	331	36	VSV2430-72MFL		\$5,219	\$5,752
	19 5/8	29 7/8	72	288	31	VST2030-72MFR	\$2,903		
	19 5/8	29 7/8	72	288	31	VSV2030-72MFR		\$4,951	\$5,457
	19 5/8	29 7/8	72	288	31	VST2030-72MFL	\$2,903		
	19 5/8	29 7/8	72	288	31	VSV2030-72MFL		\$4,951	\$5,457



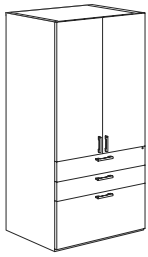
right shown

- two adjustable shelves
- locking available, specify and add \$160 list

To Order, Specify:

① Model Number	Laminate - VST	Veneer - VSV	④ Edge Profile (see page VI4)
	<p>② Worksurface Material (see page VI3)</p> <p>a.) TFL</p> <p>b.) HPL</p> <p>③ Laminate Color (see page VI3)</p> <p>a.) Worksurface Color</p> <p>b.) Chassis Color</p> <p>c.) Drawer Color</p>	<p>② Wood Species - Cherry (CH1), Maple (MA1) Walnut (WA1), Black Oak (BO1) or Double Cut (DC1) (see page VI1)</p> <p>③ Finish Color (see page VI1)</p>	<p>⑤ Pull Style and Color (see page VI5)</p> <p>⑥ Optional Grommet Location & Color - Matte Black (MBK) or Arctic Silver (ASL) (see page VI6)</p> <p>⑦ Other Product Options (see page VI10)</p> <p>⑧ Accessories (see page VS314)</p> <p>⑨ Power and Data Options (see page VS324)</p>

Description	D	W	H	CTN WT	CU FT	① Model	Laminate	Flat Cut Veneer	Double Cut Veneer
84" h Box/Box/Lateral File Storage Cabinet	23 7/8	35 7/8	84	335	50	VST2436-84BBFT	\$3,341		
	23 7/8	35 7/8	84	335	50	VSV2436-84BBFT		\$5,444	\$5,999
	23 7/8	29 7/8	84	322	42	VST2430-84BBFT	\$3,112		
	23 7/8	29 7/8	84	322	42	VSV2430-84BBFT		\$5,076	\$5,593
	19 5/8	35 7/8	84	292	42	VST2036-84BBFT	\$3,171		
	19 5/8	35 7/8	84	292	42	VSV2036-84BBFT		\$5,171	\$5,694
	19 5/8	29 7/8	84	281	36	VST2030-84BBFT	\$2,952		
	19 5/8	29 7/8	84	281	36	VSV2030-84BBFT		\$4,819	\$5,310



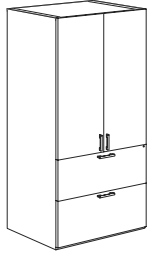
- three adjustable shelves
- locking available, specify and add \$160 list

72" h Box/Box/Lateral File Storage Cabinet	23 7/8	35 7/8	72	285	43	VST2436-72BBFT	\$3,206		
	23 7/8	35 7/8	72	285	43	VSV2436-72BBFT		\$5,189	\$5,719
	23 7/8	29 7/8	72	271	36	VST2430-72BBFT	\$3,037		
	23 7/8	29 7/8	72	271	36	VSV2430-72BBFT		\$4,955	\$5,460
	19 5/8	35 7/8	72	248	36	VST2036-72BBFT	\$3,039		
	19 5/8	35 7/8	72	248	36	VSV2036-72BBFT		\$4,926	\$5,428
	19 5/8	29 7/8	72	236	31	VST2030-72BBFT	\$2,884		
	19 5/8	29 7/8	72	236	31	VSV2030-72BBFT		\$4,703	\$5,183



- two adjustable shelves
- locking available, specify and add \$160 list

Description	D	W	H	CTN WT	CU FT	① Model	Laminate	Flat Cut Veneer	Double Cut Veneer
84" h File/File Lateral Storage Cabinet	23 7/8	35 7/8	84	330	50	VST2436-84FFT	\$3,356		
	23 7/8	35 7/8	84	330	50	VSV2436-84FFT		\$5,465	\$6,020
	23 7/8	29 7/8	84	318	42	VST2430-84FFT	\$3,127		
	23 7/8	29 7/8	84	318	42	VSV2430-84FFT		\$5,094	\$5,611
	19 7/8	35 7/8	84	288	42	VST2036-84FFT	\$3,184		
	19 7/8	35 7/8	84	288	42	VSV2036-84FFT		\$5,187	\$5,717
	19 7/8	29 7/8	84	277	36	VST2030-84FFT	\$2,965		
	19 7/8	29 7/8	84	277	36	VSV2030-84FFT		\$4,835	\$5,329



- three adjustable shelves
- locking available, specify and add \$160 list

Description	D	W	H	CTN WT	CU FT	① Model	Laminate	Flat Cut Veneer	Double Cut Veneer
72" h File/File Lateral Storage Cabinet	23 7/8	35 7/8	72	281	43	VST2436-72FFT	\$3,222		
	23 7/8	35 7/8	72	281	43	VSV2436-72FFT		\$5,212	\$5,743
	23 7/8	29 7/8	72	266	36	VST2430-72FFT	\$3,056		
	23 7/8	29 7/8	72	266	36	VSV2430-72FFT		\$4,975	\$5,482
	19 7/8	35 7/8	72	245	36	VST2036-72FFT	\$3,058		
	19 7/8	35 7/8	72	245	36	VSV2036-72FFT		\$4,945	\$5,449
	19 7/8	29 7/8	72	232	31	VST2030-72FFT	\$2,897		
	19 7/8	29 7/8	72	232	31	VSV2030-72FFT		\$4,724	\$5,206

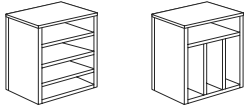


- two adjustable shelves
- locking available, specify and add \$160 list

To Order, Specify:

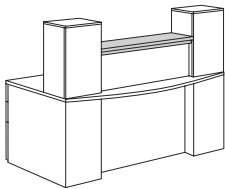
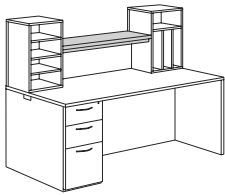
① Model Number	Laminate - VST	Veneer - VSV	④ Edge Profile (see page VI4)
	<p>② Worksurface Material (see page VI3)</p> <p>a.) TFL</p> <p>b.) HPL</p> <p>③ Laminate Color (see page VI3)</p> <p>a.) Worksurface Color</p> <p>b.) Chassis Color</p> <p>c.) Drawer Color</p>	<p>② Wood Species - Cherry (CH1), Maple (MA1) Walnut (WA1), Black Oak (BO1) or Double Cut (DC1) (see page VI1)</p> <p>③ Finish Color (see page VI1)</p>	<p>⑤ Pull Style and Color (see page VI5)</p> <p>⑥ Optional Grommet Location & Color - Matte Black (MBK) or Arctic Silver (ASL) (see page VI6)</p> <p>⑦ Other Product Options (see page VI10)</p> <p>⑧ Accessories (see page VS314)</p> <p>⑨ Power and Data Options (see page VS324)</p>

Description	D	W	H	CTN WT	CU FT	① Model	Laminate	Flat Cut Veneer	Double Cut Veneer
Storage Tower Insert	10 ⁷ / ₈	16	24 ³ / ₄	18	6	VST2016ST	\$823		
Transaction Support Cabinet	10 ⁷ / ₈	16	24 ³ / ₄	18	6	VSV2016ST		\$949	\$1,042



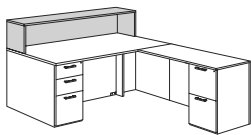
- support for transaction surfaces
- paper management slots can be configured horizontally or with three vertical slots
- can be used under storage overhead cabinet without cubbies

Description	D	W	H	CTN WT	CU FT	① Model	TFL Laminate	HPL Laminate	Flat Cut Veneer	Double Cut Veneer
Transaction Surface Top	10 ⁷ / ₈	39 ³ / ₄	3	21	5	VST1440TS	\$308	\$324		
	10 ⁷ / ₈	39 ³ / ₄	3	21	5	VSV1440TS			\$382	\$420
	10 ⁷ / ₈	33 ³ / ₄	3	17	5	VST1434TS	\$287	\$301		
	10 ⁷ / ₈	33 ³ / ₄	3	17	5	VSV1434TS			\$357	\$393
	10 ⁷ / ₈	27 ³ / ₄	3	13	5	VST1428TS	\$279	\$294		
	10 ⁷ / ₈	27 ³ / ₄	3	13	5	VSV1428TS			\$345	\$380



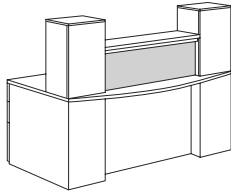
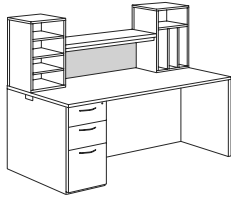
- top edge profile on user and approach sides
- long grain direction
- must be supported by two VST2016ST or VSV2016ST; see above
- VST1440TS or VSV1440TS sets on top of 72" desk or credenza top
- VST1434TS or VSV1434TS sets on top of 66" desk or credenza top
- VST1428TS or VSV1428TS sets on top of 60" desk or credenza top
- transaction trim panel available, see page VS313

Transaction Counter	13	72	17 ³ / ₁₆	87	9	VST1372TC	\$954	\$1,002		
	13	72	17 ³ / ₁₆	87	9	VSV1372TC			\$1,363	\$1,499
	13	66	17 ³ / ₁₆	79	8	VST1366TC	\$910	\$956		
	13	66	17 ³ / ₁₆	79	8	VSV1366TC			\$1,301	\$1,432



- VST1372TC or VSV1372TC coordinates with 72" worksurface
- VST1366TC or VSV1366TC coordinates with 66" worksurface
- back panel grain is horizontal

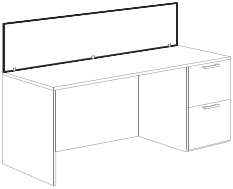
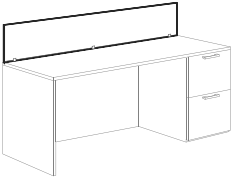
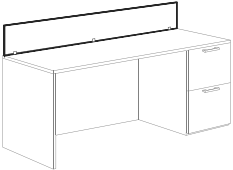
Description	D	W	H	CTN WT	CU FT	① Model	List Price
Transaction Trim Panel	¼	39 ½	12	5	2	VSB1240FTS	\$630
	¼	33 ½	12	5	2	VSB1234FTS	\$605
	¼	27 ½	12	4	2	VSB1228FTS	\$540



- frosted acrylic panel
- coordinates with two VST2016ST or VSV2016ST and transaction surface

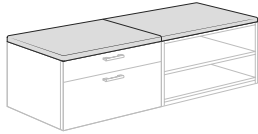
To Order, Specify:

① Model Number	Laminate - VST	Veneer - VSV	
	<p>② Worksurface Material (see page VI3)</p> <p>a.) TFL</p> <p>b.) HPL</p> <p>③ Laminate Color (see page VI3)</p> <p>a.) Worksurface Color</p> <p>b.) Chassis Color</p> <p>c.) Drawer Color</p>	<p>② Wood Species - Cherry (CH1), Maple (MA1) Walnut (WA1), Black Oak (BO1) or Double Cut (DC1) (see page VI1)</p> <p>③ Finish Color (see page VI1)</p>	<p>④ Edge Profile (see page VI4)</p> <p>⑤ Pull Style and Color (see page VI5)</p> <p>⑥ Optional Grommet Location & Color - Matte Black (MBK) or Arctic Silver (ASL) (see page VI6)</p> <p>⑦ Other Product Options (see page VI10)</p> <p>⑧ Accessories (see page VS314)</p> <p>⑨ Power and Data Options (see page VS324)</p>

Description	D	W	H	CTN WT	CU FT	① Model	List Price
	¼	71 ¼	15	7	3	VSB1572ASR	\$935
	¼	65 ¼	15	7	2	VSB1566ASR	\$869
	¼	59 ¼	15	6	2	VSB1560ASR	\$801
	¼	53 ¼	15	6	2	VSB1554ASR	\$736
	¼	47 ¼	15	6	2	VSB1548ASR	\$669
	¼	41 ¼	15	5	2	VSB1542ASR	\$606
	¼	35 ¼	15	5	1	VSB1536ASR	\$528
	¼	29 ¼	15	4	1	VSB1530ASR	\$465
	¼	23 ¼	15	4	1	VSB1524ASR	\$399
	¼	71 ¼	12	7	2	VSB1272ASR	\$772
	¼	65 ¼	12	7	2	VSB1266ASR	\$718
	¼	59 ¼	12	6	2	VSB1260ASR	\$663
	¼	53 ¼	12	6	2	VSB1254ASR	\$613
	¼	47 ¼	12	6	2	VSB1248ASR	\$559
	¼	41 ¼	12	5	2	VSB1242ASR	\$508
	¼	35 ¼	12	5	1	VSB1236ASR	\$442
	¼	29 ¼	12	4	1	VSB1230ASR	\$391
	¼	23 ¼	12	4	1	VSB1224ASR	\$338
	¼	71 ¼	9	6	2	VSB0972ASR	\$693
	¼	65 ¼	9	6	2	VSB0966ASR	\$645
	¼	59 ¼	9	5	2	VSB0960ASR	\$595
	¼	53 ¼	9	5	2	VSB0954ASR	\$552
	¼	47 ¼	9	5	1	VSB0948ASR	\$505
	¼	41 ¼	9	5	1	VSB0942ASR	\$460
	¼	35 ¼	9	4	1	VSB0936ASR	\$400
	¼	29 ¼	9	4	1	VSB0930ASR	\$355
	¼	23 ¼	9	4	1	VSB0924ASR	\$310

- frosted acrylic
- mounts to top of worksurface
- mounting hardware included
- field installed

Description	D	W	H	CTN WT	CU FT	① Model	List Price Per Grade
24"d Bench Height Seat Cushions	24	36	1½	14	3	VSB2436CUSH	COM \$257 A \$270 B \$296 C \$341 D \$400 E \$458 F \$549 G \$645 H \$749 I \$911 J \$1,103 L1 \$716 L2 \$846
24"d Bench Height Seat Cushions	24	30	1½	12	2	VSB2430CUSH	COM \$244 A \$257 B \$283 C \$328 D \$387 E \$444 F \$536 G \$632 H \$736 I \$897 J \$1,090 L1 \$703 L2 \$832
24"d Bench Height Seat Cushions	24	18	1½	7	2	VSB2418CUSH	COM \$196 A \$204 B \$220 C \$246 D \$282 E \$316 F \$372 G \$429 H \$491 I \$589 J \$704 L1 \$471 L2 \$550



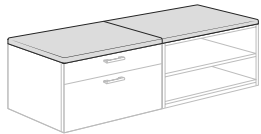
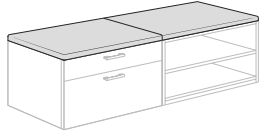
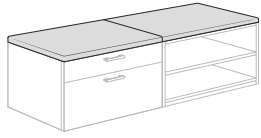
To Order, Specify:

- ① Model Number
- ② Fabric Selection: vendor, pattern, color
 Visit www.jsifurniture.com/finishes-and-materials/textiles
 for our textiles program. See selection of standard and
 graded in manufacturers and patterns.

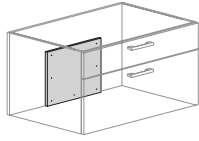
Accessories



Description	D	W	H	CTN WT	CU FT	① Model	List Price Per Grade
18" d Bench Height Seat Cushions	18	36	1 1/2	13	2	VSB1836CUSH	COM \$246 A \$260 B \$285 C \$331 D \$389 E \$446 F \$537 G \$635 H \$737 I \$898 J \$1,092 L1 \$705 L2 \$835
18" d Bench Height Seat Cushions	18	30	1 1/2	11	2	VSB1830CUSH	COM \$240 A \$253 B \$278 C \$324 D \$381 E \$440 F \$529 G \$628 H \$729 I \$891 J \$1,086 L1 \$699 L2 \$828
18" d Bench Height Seat Cushions	18	18	1 1/2	6	1	VSB1818CUSH	COM \$195 A \$202 B \$218 C \$244 D \$279 E \$315 F \$369 G \$427 H \$489 I \$587 J \$703 L1 \$469 L2 \$548



Description	D	W	H	CTN WT	CU FT	① Model	List Price
Counterweights for	3/4	12	11 1/4	21	1	VSB20LB	\$252
Bench Height Units	3/4	12	6	11	1	VSB10LB	\$129

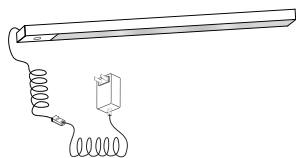


- counterweight for modular bench height cabinets
- attaches to inside back panel of cabinet
- field installed
- hardware included

To Order, Specify:

① Model Number

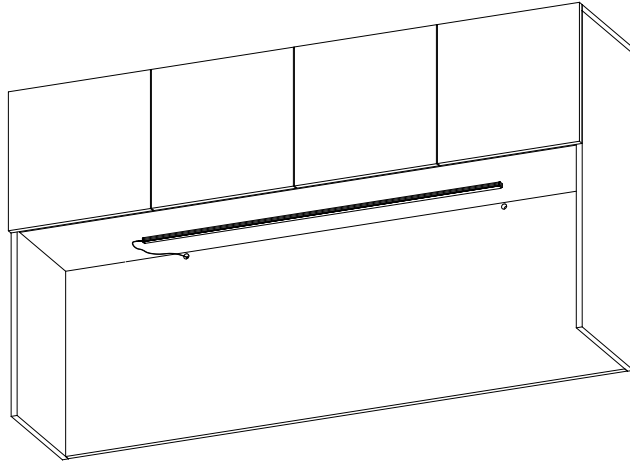
Description	D	W	H	CTN WT	CU FT	① Model	List Price
LED Tasklight	½	60	¾	3	1	TL60LEDF	\$337
	½	45	¾	3	1	TL45LEDF	\$290
	½	39	¾	3	1	TL39LEDF	\$257
	½	27	¾	3	1	TL27LEDF	\$224



- low profile LED tasklight
- toggle on and off switch
- 4000K cool white
- recommended tasklight length for each cabinet size; see chart on page [VS319](#)
- 13ft cord

Tasklights

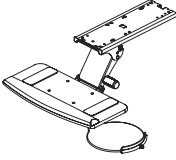
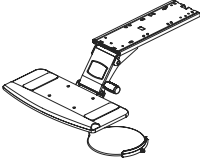
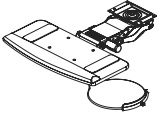
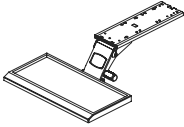

Tasklights are available for overhead cabinets. Specify separately. Grommet holes for wire management are 5/8" diameter for the LED tasklight. Refer to the chart to the right for the recommended tasklight length according to overhead cabinet width.



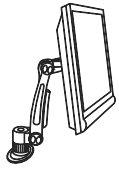
Overhead Width	Tasklight Model Number	Tasklight Length
96"	TL60LEDF	60"
90"	TL60LEDF	60"
84"	TL45LEDF	45"
78"	TL45LEDF	45"
72"	TL45LEDF	45"
66"	TL45LEDF	45"
60"	TL39LEDF	39"
54"	TL27LEDF	27"
48"	TL27LEDF	27"
42"	TL27LEDF	27"
36"	TL27LEDF	27"
30"	TL27LEDF	27"

To Order, Specify:

① Model Number

Description	D	W	H	CTN WT	CU FT	① Model	List Price
 <p>Articulating Keyboard Tray</p> <ul style="list-style-type: none"> · articulating keyboard tray - black color · mouse tray included · 16" glide track · easy one-handed adjustment; vertical range of motion of 5.1" below glide track · tray tilt range +10 degree to -20 degree · unit swivels side-to-side · tray size is 19.4" wide x 9.4" deep · tray includes palm rest · tray is made with recyclable high density polyethylene 	13	24	7	14	2	AK2	\$520
 <p>Articulating Keyboard Tray</p> <ul style="list-style-type: none"> · articulating keyboard tray - black color · mouse tray included · 17" glide track · easy one-handed adjustment; vertical range of motion of 8.9"; (6.5" below the glide track and an additional 2.38" above) · tray tilt range +10 degree to -20 degree · unit swivels side-to-side · tray size is 19.4" wide x 9.4" deep · tray includes palm rest · tray is made with recyclable high density polyethylene 	13	24	7	12	2	AK3	\$550
 <p>Articulating Keyboard Tray</p> <ul style="list-style-type: none"> · trackless articulating keyboard tray - black color · mouse tray included · use when depth under work surface for mounting is limited; minimum of 9.38" depth recommended · easy one-handed adjustment; vertical range of motion of 5.73 · tray tilt range +10 degree to -15 degree · unit swivels side-to-side · tray size is 19.4" wide x 9.4" deep · tray includes palm rest · tray is made with recyclable high density polyethylene 	11	23	3	11	2	AK5	\$535
 <p>Articulating Keyboard Tray</p> <ul style="list-style-type: none"> · trackless articulating keyboard tray - black color · mouse tray included · use when depth under work surface for mounting is limited; minimum of 9.38" depth recommended · easy one-handed adjustment; vertical range of motion of 5.73 · tray tilt range +10 degree to -15 degree · unit swivels side-to-side · tray size is 19.4" wide x 9.4" deep · tray includes palm rest · tray is made with recyclable high density polyethylene 	14	23	7	15	2	AK4	\$580
 <p>Keyboard Tray Mouse Pad</p> <ul style="list-style-type: none"> · adjusts for user comfort · 8" x 8" · for left or right hand operation · compatible with AK4 Keyboard Drawer only 	8	8	¼	2		MT4	\$195

Description	D	W	H	CTN WT	CU FT	① Model	List Price
Monitor Support Arm	12	6	17	9		AMA3B	\$646



- 360 degree swivel
- adjusts height, tilt and distance of monitor screen to user
- integrated cable management
- grommet and edge clamp mount included
- black finish
- monitor not included
- will fit monitors made to the VESA standard of 75 mm or 100 mm hole spacing in a square configuration

To Order, Specify:

① Model Number

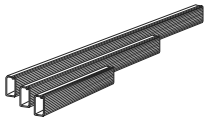
Description	D	W	H	CTN WT	CU FT	① Model	List Price
-------------	---	---	---	-----------	----------	---------	------------

Vertical Wire Manager	1 1/2	1 1/2	45	4	1	45VWM	\$131
-----------------------	-------	-------	----	---	---	-------	-------



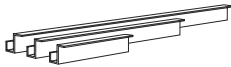
- flexible, vertebrae-style construction
- field installed to bottom of worksurface with screws provided
- length can be adjusted by removing individual discs as required
- wire manager is 1 1/2" diameter
- weighted base is 4" diameter
- black plastic

Wire Management Channel	2 1/2	36	1	4	4	36WC	\$79
	2 1/2	24	1	3	3	24WC	\$71
	2 1/2	12	1	2	2	12WC	\$62



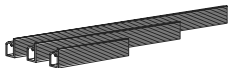
- black plastic
- field installed with adhesive tape provided

Wire Management Trough	2 1/2	36	2 1/2	3	3	36WCT	\$152
	2 1/2	24	2 1/2	3	3	24WCT	\$138
	2 1/2	12	2 1/2	2	2	12WCT	\$119



- black plastic
- field installed with screws provided

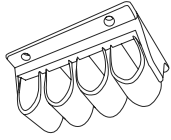
Wire Manager J-Channel	1 1/8	36	2 3/8	1	1	36WJC	\$65
	1 1/8	24	2 3/8	1	1	24WJC	\$47
	1 1/8	12	2 3/8	1	1	12WJC	\$25



- black plastic
- field installed with adhesive tape provided
- mounts to edge of surface top

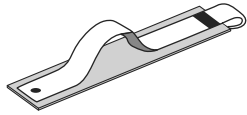
Description	D	W	H	CTN WT	CU FT	① Model	List Price
-------------	---	---	---	-----------	----------	---------	------------

Cable Management Clip	2 5/8	3 3/4	1 5/8	1	1	0304CMC	\$54
------------------------------	-------	-------	-------	---	---	----------------	-------------



- four retention loops
- field installed with screws provided
- mounts under surface
- black

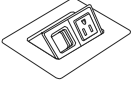


Wire Management Velcro Straps (Set of 4)	1 3/4	3 1/2	1/4	1	1	04WVS	\$56
---	-------	-------	-----	---	---	--------------	-------------

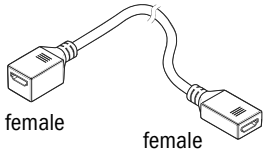
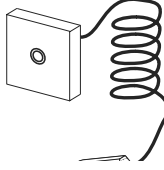
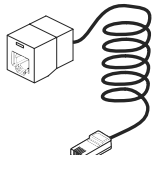

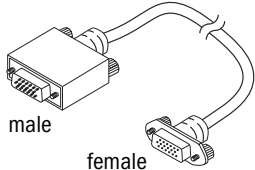
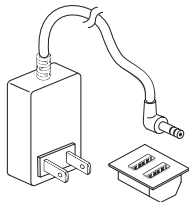
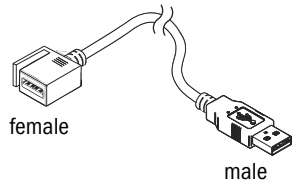


- field installed with adhesive tape provided
- mounts under surface or on vertical panels
- black

To Order, Specify:

① Model Number

Description	D	W	H	CTN WT	CU FT	① Model	List Price
Mini Power and Data Tilt Up  <ul style="list-style-type: none"> · fluid one touch tilt up access · one power receptacle - 120 volt; 15 amp and one voice/data port · data adapter kit provided to accept jacks from most port manufacturers (see page VS326) · accepts one Type 3 Telecom Jack (see page VS325) · 72" power cord with molded plug · drop in field installation required · UL listed component · Black (B) or Silver (S) finish 	4 ¼	5 ½		6	1	EC10	\$382
Mini Power Tilt Up  <ul style="list-style-type: none"> · fluid one touch tilt up access · two power receptacles - 120 volt; 15 amp · 72" power cord with molded plug · drop in field installation required · UL listed component · Black (B) or Silver (S) finish 	4 ¼	5 ½		6	1	EC11	\$397
Mini Power and USB Tilt Up  <ul style="list-style-type: none"> · fluid one touch tilt up access · one power receptacle - 120 volt; 15 amp dual powered USB · 72" power cord with molded plug · drop in field installation required · UL listed component · Black (B) or Silver (S) finish 	4 ¼	5 ½		6	1	EC12	\$428

Description	D	W	H	CTN WT	CU FT	① Model	List Price
HDMI Connector  <ul style="list-style-type: none"> · HDMI coupler · 18" cord · female to female connection · for use in E10, EC11 and EC12 · uses data adapter kit CCC adapter plate 						TCP301	\$110
Mini Stereo Jack  <ul style="list-style-type: none"> · 3.5 mm Mini Stereo Jack · 10 foot cord · female to male connection · for use in E10, EC11 and EC12 · installs directly into unit without need of data adapter kit 						TCP302	\$56
Network Jack  <ul style="list-style-type: none"> · Cat5e RJ-45 Panduit Jack · Pre-terminated · 9 foot cord · 8-Pin · for use in EC10, EC11 and EC12 · uses data adapter kit FFF adapter plate 						TCP303	\$101
Voice Coupler  <ul style="list-style-type: none"> · AMP Category 3, RJ-11 · 6-Pin · connects to standard phone cord · for use in EC10, EC11 and EC12 · uses data adapter kit CCC adapter plate 						TCP304	\$41
Data Jack - VGA 15 Pin  <ul style="list-style-type: none"> · 120" M/F cable - female-to-male connection · 15 pin connections · provides electronic device to remove display connection · uses data adapter kit HHH adapter plate 						TCP305	\$136
Dual Powered Charging USB  <ul style="list-style-type: none"> · two USB-A connections for USB-powered devices and charging mobile electronics · 2000MA (2 AMP) charging power per USB port · black or white option · for use in EC10 · installs directly into unit without need of data adapter kit 						TCP306	\$174
3.0 USB Connector  <ul style="list-style-type: none"> · 3.0 USB coupler · 10 foot cord · male to female connection · for use in EC9, EC10, EC13 and EC15 · data transfer port - no USB charging capability · data transfer speed up to 5gbs/sec · uses data adapter kit CCC adapter plate 						TCP307	\$95

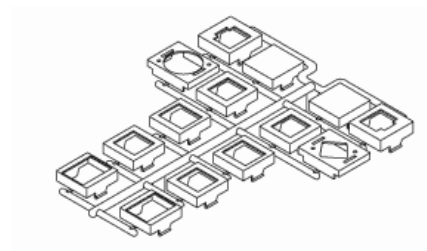
To Order, Specify:

① Model Number

Data Adapter Applications

Data adapter kits ship with each power and data unit.

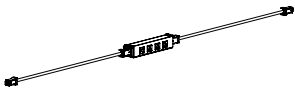
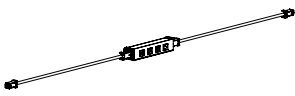

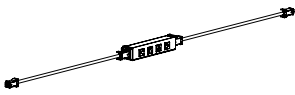

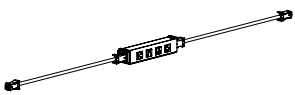
Adapter plates are marked on the back with letter designators to indicate the data jack manufacturer, series and style. Websites are listed below for quick reference to verify data jack series or style.



Included with EC10

NOTE: Verify fit of data jack in adapter before ordering large quantities as manufacturer designs may change without notice.

Adapter	Manufacturer	Website
AA	Uniprise/Systemax/Avaya	www.uniprisesolutions.com
BB	Tyco SL and 100 Connect Series Modular Jacks	www.ampconnect.com
BB	Siemon Keystone Style	www.siemon.com
BB	Allen Tel Versa Tap Series	www.allentel.com
BB	Leviton Quick Port® Series	www.leviton.com
BB	Nordx Keystone Style	www.nordx.com
CC	Tyco SL Coupler Series	www.ampconnect.com
CC	Krone 6000 Series	www.adc.com
CC	Hubbell Xcelerator™ Keystone Series	www.hubbell.com
DD	Blank (no coupler/jack)	
EE	Ortronics TracJack Series	www.ortronics.com
FF	Panduit Mini-Com Series	www.panduit.com
GG	Microphone jack/3-pin XLR, solder type only	
HH	Video Monitor jack/DB-15, panel mount solder style	

Description	D	W	H	CTN WT	CU FT	① Model	List Price
72" Power Link Kits - Circuit 1  <ul style="list-style-type: none"> · use with 72" tables · 72" plug power infeed · 20 amps/110 volts max · 3 prong plug - 15 amp adapter plug · Circuit 1 						ECAH-72UP-1	\$921
72" Power Link Kits - Circuit 2  <ul style="list-style-type: none"> · use with 72" tables · 72" plug power infeed · 20 amps/110 volts max · 3 prong plug - 15 amp adapter plug · Circuit 2 						ECAH-72UP-2	\$921
66" Power Link Kits - Circuit 1  <ul style="list-style-type: none"> · use with 66" tables · 72" plug power infeed · 20 amps/110 volts max · 3 prong plug - 15 amp adapter plug · Circuit 1 						ECAH-66UP-1	\$904
66" Power Link Kits - Circuit 2  <ul style="list-style-type: none"> · use with 66" tables · 72" plug power infeed · 20 amps/110 volts max · 3 prong plug - 15 amp adapter plug · Circuit 2 						ECAH-66UP-2	\$904
60" Power Link Kits - Circuit 1  <ul style="list-style-type: none"> · use with 60" tables · 72" plug power infeed · 20 amps/110 volts max · 3 prong plug - 15 amp adapter plug · Circuit 1 						ECAH-60UP-1	\$886
60" Power Link Kits - Circuit 2  <ul style="list-style-type: none"> · use with 60" tables · 72" plug power infeed · 20 amps/110 volts max · 3 prong plug - 15 amp adapter plug · Circuit 2 						ECAH-60UP-2	\$886

To Order, Specify:

① Model Number

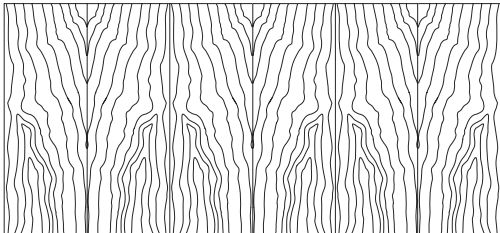
Vision Conference Product Information



Vision Conference Product Information

Exterior Wood Materials

Exterior surfaces are made from the finest selected veneers to achieve clarity and consistency in the Vision Veneer product line. To attain a pleasing, symmetrical pattern, all cherry, maple, walnut veneers in Vision Veneer are book-matched. All exterior solid lumber is matched to coordinate with the veneer.

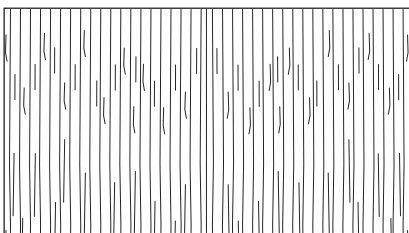


Book-Matched Example

Alternating pieces of veneer are flipped over so they face each other like the pages within a book

Vision Veneer is available in flat cut cherry, maple, walnut and black oak veneer. A wide range of wood stains have been formulated to enhance the beauty of the veneer.

Double Cut veneer is another choice on Vision Veneer product. This veneer is a processed product that has at least two cuttings to create the final veneers. These cuts of veneer strands are dyed and layered into a block to create variation of patterns from a very tight grain pattern to an exotic figure grain pattern. The diagram below show the tight pattern used on Vision Veneer. Use the appropriate pricing column when specifying Double Cut veneer.



Solid painted finishes on MDF are also offered to provide an accent to the Vision Veneer product.

Work Surface Construction

Tops are 5-ply balanced construction, 1 3/16" thick with solid matching hardwood edges. Surfaces are available in wood veneer or high pressure laminate. No additional charge for using our coordinating high pressure laminate with a veneer grain pattern with finish wood edges.

Finish - Stain/Colors

We offer a variety of wood stains and paint colors on Vision Veneer. Please see the chart below. Samples are available upon request.

CH1 Cherry	<i>Flat Cut Veneer</i>	
BBM Bourbon Medium	CLL	Collectors
BRM Brighton Medium	HRV	Harvest
CLA Classic	PRL	Praline

MA1 Maple	<i>Flat Cut Veneer</i>	
ALM Ale Medium	FLX	Flax
BUT Butterscotch	VEN	Venetian

WA1 Walnut	<i>Flat Cut Veneer</i>	
ESP Espresso	TRF	Truffle
MCH Mocha	UMB	Umber
SIE Sienna		

BO1 Black Oak	<i>Flat Cut Veneer</i>	
RAV Raven		

DC1 Double Cut Veneer	<i>Eased Edge Only</i>	
BAR Barrel - Oak Pattern	KHK	Khaki
BUF Buff - Oak Pattern	MIN	Mineral - Oak Pattern
CND Cinder - Oak Pattern	RYE	Rye - Oak Pattern
COF Coffee	SAB	Sable - Oak Pattern
EGR Egret - Oak Pattern	SAD	Saddle - Oak Pattern
FAW Fawn	STU	Studio Teak
GRH Graphite	VAL	Valley

Protective Top Coat

DuraTex™ offers exceptional hardness along with abrasion and impact resistance, it has been formulated to eliminate hazardous and harmful gases that are normally associated with wood finish.

DuraTex™ Features

- Safety - Significantly reduces hazardous formaldehyde emissions which help improve the quality of the of the indoor air we breathe.
- Quality - Developed to be tough and durable with special attention to appearance. The DuraTex™ finish preserves the natural beauty of wood.
- Durability - Designed to meet a wide range of demanding performance and environmental standards to withstand even the highest wear and tear.

Laminate Tops on Veneer

Work surface only, no additional upcharge if Vision Veneer's coordinating wood grain laminate is specified. Contact Customer Service for any other laminate request. Listed below are finishes that have coordinating wood grain HPL laminates.

Cherry Finishes	Walnut Finishes
Collectors	Mocha
Harvest	Night Owl
Praline	Sienna
	Truffle

Vision Conference Product Information

Laminates

Vision Laminate features TFL (thermally fused laminate) chassis and components. Worksurfaces are available in a HPL (high pressure laminate) or in the TFL surface, when indicated by the pricing column.

Edges of the worksurface are impact resistant (PVC) on TFL and HPL tops. The laminate is offered in 16 wood grain patterns and 5 solid colors. The wood grain laminate features an embossed grain to hide finger prints and light scratches. The solid laminate is smooth to the touch with a semi-matte finish. All Vision Laminate products are indoor-air certified by GreenGuard.

The chart below lists the laminates available on the Vision product.

TFL - HPL Wood Grain Pattern Laminates

ALL Ale Light	MIN Mineral
BOL Bourbon Light	OAT Oatmeal Cookie
BZW Brazilwood	PIN Pinnacle Walnut
BGL Brighton Light	STU Studio Teak
CLL Collectors	UMB Umber
FAW Fawn	VAL Valley
FLO Florence Walnut	VIN Vintage
GRH Graphite	WEA Weathered Ash

TFL - HPL Solid Laminates

ALB Alabaster	DWH Designer White
BLK Black	SHD Shadow
BBL Bridal Blanco	SLG Slate Grey

Top Surfaces (*Conference Tops and Credenza Tops*)

Tops have a 3-ply balanced construction. Tops are 1-³/₁₆" thick with coordinating PVC edges.

Conference Tops feature 3mm PVC edges on all sides and are available in HPL. Limited sizes available in TFL, see individual models.

Credenza Tops feature 3mm PVC edges on the user side only. Remaining edges are banded with 1mm PVC which allows for a seamless appearance when units are mated end-to-end or back-to-back.

TFL features on *Conference Top Surfaces**

- fused to the 45 pound density substrate of the top for a durable wear resistance surface
- tops are laminated on both sides
- available in all the wood grain and solid patterns

HPL features on *Conference Top Surfaces**

- bonded layers create a durable wear resistant surface
- tops are 3-ply balanced construction
- matched to the TFL wood grain and solid patterns

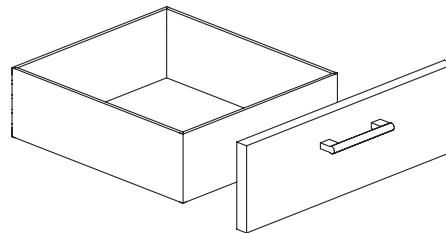
Case Construction

Outside panels are ³/₄" and joined together with dowels reinforced with screws, and metal fasteners for increased stability. Tops are secured to the chassis with screws through pre-bored stretcher rails and pocket holes.

Cabinet doors have 110° swing hinges to allow adequate access into the interior of the cabinet.

Drawers

The unidirectional V- Fold drawer box is a durable miter-fold drawer structure which is glued and doweled. The ¹/₂" thick drawer sides are wrapped in a high grade maple vinyl, with an attached front. The drawer front is attached to the four sided box.



Optional four corner dovetailed wood drawers are available. Specify and add 10% per unit.

Drawer Suspension

High quality black drawer suspension carries a lifetime warranty. File and box drawers have 100% full extension with over travel. Slides feature steel ball bearings for longer wear and positive, cushioned in/out stops.

Locking

All free standing credenzas, and bench height credenza offer optional pedestal locking.

When locks are ordered, units are shipped randomly keyed as standard. Key alike units are available upon request for no additional charges. Removable cores for in-field re-keying are standard.

Product Modification

Wood Drawers

Four corner dovetailed wood drawers must be specified at the time of order placement. There is a 10% upcharge added to the list of each item.

Special Construction

Vision Veneer offers large offering to create many types of configuration. Contact Customer Service if you are having trouble with finding the right units to complete the desired configuration. Requests need to be approved by JSI engineering.

Special Finishes

Special finishes can be requested by following the instruction in the general introduction section. There is a one time charge of \$372 list per order.

Finish Sheen

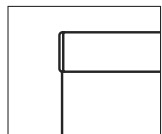
All veneer finishes are standard in 35-sheen, with the exception of Raven. Raven is only offered in 15 sheen. All other finishes are available in 15 sheen, see standard modifications page VI40.

Vision Conference Product Information

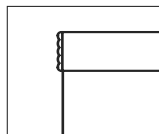
Veneer

Top Edge Profile

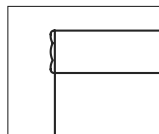
Flat Cut Veneer units are available in all edges. Double Cut units are available only with Eased edge.



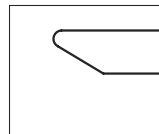
Eased (R3)



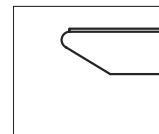
Reeded (H3)



Transitional (C3)



Reverse Knife (R)

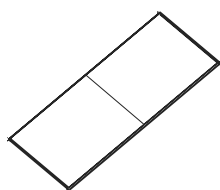


Reverse Knife (R)
with veneer/ laminate top

Veneer Top Shapes - size - base requirement - seating capacity

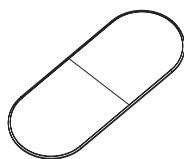
top sizes 108" through 192" are 2 pieces

top sizes above 192" are 3 pieces



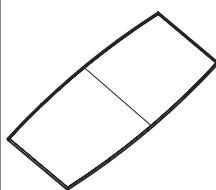
rectangular

264" x 60"	4 bases	seats 24
240" x 60"	4 bases	seats 22
216" x 60"	4 bases	seats 20
192" x 60"	3 bases	seats 18
264" x 54"	4 bases	seats 22
240" x 54"	4 bases	seats 20
216" x 54"	4 bases	seats 18
192" x 54"	3 bases	seats 16
264" x 48"	4 bases	seats 22
240" x 48"	4 bases	seats 20
216" x 48"	4 bases	seats 18
192" x 48"	3 bases	seats 16
168" x 48"	3 bases	seats 14
144" x 48"	3 bases	seats 12
120" x 48"	2-3* bases	seats 8
120" x 42"	2-3* bases	seats 8
108" x 42"	2 bases	seats 8
96" x 48"	2 bases	seats 8
96" x 42"	2 bases	seats 8
84" x 42"	2 bases	seats 8
72" x 36"	2 bases	seats 6



racetrack

264" x 60"	4 bases	seats 24
240" x 60"	4 bases	seats 22
216" x 60"	4 bases	seats 20
192" x 60"	3 bases	seats 18
264" x 54"	4 bases	seats 22
240" x 54"	4 bases	seats 20
216" x 54"	4 bases	seats 18
192" x 54"	3 bases	seats 16
264" x 48"	4 bases	seats 22
240" x 48"	4 bases	seats 20
216" x 48"	4 bases	seats 18
192" x 48"	3 bases	seats 16
168" x 48"	3 bases	seats 14
144" x 48"	3 bases	seats 12
120" x 48"	2-3* bases	seats 8
120" x 42"	2-3* bases	seats 8
108" x 42"	2 bases	seats 8
96" x 48"	2 bases	seats 8
96" x 42"	2 bases	seats 8
84" x 42"	2 bases	seats 8
72" x 36"	2 bases	seats 6



boat

264" x 60"	4 bases	seats 22
240" x 60"	4 bases	seats 20
216" x 60"	4 bases	seats 18
192" x 60"	3 bases	seats 16
264" x 54"	4 bases	seats 22
240" x 54"	4 bases	seats 20
216" x 54"	4 bases	seats 18
192" x 54"	3 bases	seats 16
264" x 48"	4 bases	seats 22
240" x 48"	4 bases	seats 20
216" x 48"	4 bases	seats 18
192" x 48"	3 bases	seats 16
168" x 48"	3 bases	seats 14
144" x 48"	3 bases	seats 12
120" x 48"	2-3* bases	seats 8
120" x 42"	2-3* bases	seats 8
108" x 42"	2 bases	seats 8
96" x 48"	2 bases	seats 8
96" x 42"	2 bases	seats 8
84" x 42"	2 bases	seats 8
72" x 36"	2 bases	seats 6



round*

60" dia.	seats 6
54" dia.	seats 6
48" dia.	seats 4
42" dia.	seats 4
36" dia.	seats 3
30" dia.	seats 3

*requires 1 base



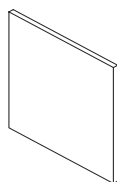
square*

60" sq.	seats 8
54" sq.	seats 6
48" sq.	seats 4
42" sq.	seats 4
36" sq.	seats 4
30" sq.	seats 4

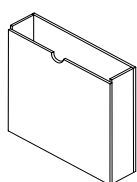
*requires 1 base

* When ordering bases for 120" x 48" and 120" x 42" size tops, three (3) bases are required for Panel and Rectangle bases, two (2) bases are required for all other.

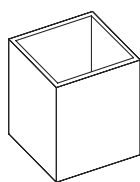
Veneer Table Base (units with access panel in the base for wire management are available, order this feature with the appropriate model number.)



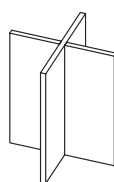
panel base
36", 30" and 24" width



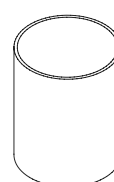
rectangle base
36", 30" and 24" width



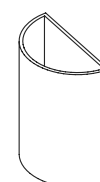
square base
30", 24" and 18" width



cross base
30", 24" and 18" width



round base
24", 20" and 18" dia.



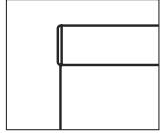
half-round base
24", 20" and 18" dia.

Vision Conference Product Information

Laminate

Top Edge Profile

Laminate units are available only with Eased edge.



Eased (R3)

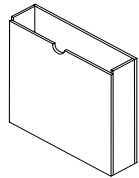
Laminate Top Shapes - size - base requirement - seating capacity

Note size 120" and above are two piece tops.

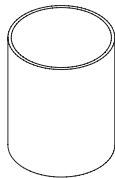
rectangular 144" x 48" 3 bases seats 12 120" x 48" 2-3* bases seats 8 96" x 48" 2 bases seats 8 96" x 42" 2 bases seats 8 84" x 42" 2 bases seats 6 72" x 36" 2 bases seats 6	racetrack 144" x 48" 3 bases seats 12 120" x 48" 2-3* bases seats 8 96" x 48" 2 bases seats 8 96" x 42" 2 bases seats 8 84" x 42" 2 bases seats 6 72" x 36" 2 bases seats 6	boat 144" x 48" 3 bases seats 12 120" x 48" 2-3* bases seats 8 96" x 48" 2 bases seats 8 96" x 42" 2 bases seats 8 84" x 42" 2 bases seats 6 72" x 36" 2 bases seats 6	round* 60" dia. Seats 6 54" dia. Seats 6 48" dia. Seats 4 42" dia. Seats 4 36" dia. Seats 4 30" dia. Seats 4 *requires 1 base

* When ordering bases for 120" x 48" size tops, two (2) Round bases are required, three (3) bases are required for Elliptical and Rectangle.

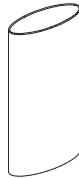
Laminate Table Base



rectangular base 24" width
includes base access panel



round base
18" dia and 24" dia
includes base access panel



ellipse base
9" x 24"
includes base access panel

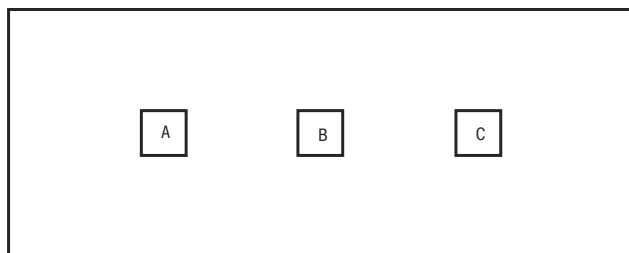
Vision Conference Product Information

Electrical Locations

Conference tops are set up with standard locations, dependant upon the size of worksurface. For custom locations, contact customer service for approval of location and add clearance of base intended to use with.

Specify location and size of cut out specific to the electrical unit intended to use with. Next, reference electrical/base location chart to ensure space for electrical unit above base.

1 Pc Conference Top : widths of 72", 84" or 96"



Location A
EC13
EC23

Location B
EC13
EC23
EC57

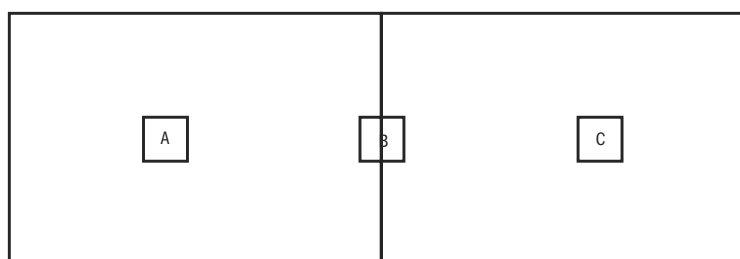
Location C
EC13
EC23

	72					84					96				
	Location A,C		Location B			Location A,C		Location B			Location A,C		Location B		
	EC23	EC13	EC23	EC13	EC57	EC23	EC13	EC23	EC13	EC57	EC23	EC13	EC23	EC13	EC57
Square	X	X	X	X	X	X	X	X	X	X	X	X	X	X	X
Round	X	X	X	X		X	X	X	X	X	X	X	X	X	X
Cross			X	X	X			X	X	X			X	X	X
Half Round			X	X	X			X	X	X			X	X	X
Panel	X	X	X	X	X	X	X	X	X	X	X	X	X	X	X
Rectangular Panel			X	X	X			X	X	X			X	X	X
Ellipse			X*	X*	X*			X*	X*	X*			X*	X*	X*

X* ONLY ON 54" AND 60"

* ONLY AVAILABLE ON LAMINATE

2 Pc Conference Top : widths of 108" or 120"



Location A
EC13
EC23

Location B
EC13
EC23
EC57

Location C
EC13
EC23

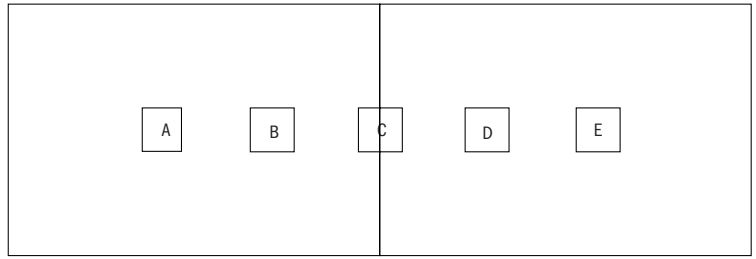
	108					120				
	Location A,C		Location B			Location A,C		Location B		
	EC23	EC13	EC23	EC13	EC57	EC23	EC13	EC23	EC13	EC57
Square	X	X	X	X	X	X	X	X	X	X
Round	X	X	X	X	X	X	X	X	X	X
Cross			X	X	X			X	X	X
Half Round			X	X	X			X	X	
Panel	X	X				X	X			
Rectangular Panel			X	X	X	X	X			
Ellipse						X*				

X* ONLY ON 54" AND 60"

* ONLY AVAILABLE ON LAMINATE

Vision Conference Product Information

2 Pc Conference Top : widths of 144", 168", or 192"



Location A
EC13
EC23

Location B
EC13
EC23
EC57

Location C
EC13
EC23
EC57

Location D
EC13
EC23
EC57

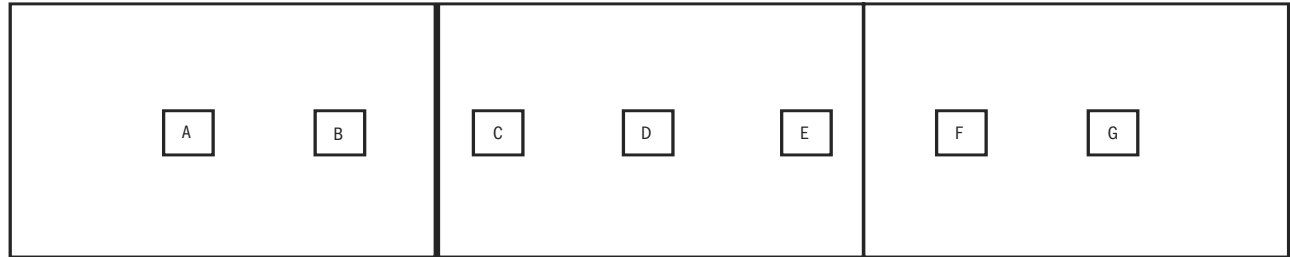
Location E
EC13
EC23

	144					168					192											
	Location A,E		Location B,D			Location C		Location A,E		Location B,D			Location C		Location A,E		Location B,D			Location C		
	EC23	EC13	EC23	EC13	EC57	EC23	EC13	EC23	EC13	EC23	EC13	EC57	EC23	EC13	EC23	EC13	EC23	EC13	EC57	EC23	EC13	
Square	X	X	X	X	X	X	X	X	X	X	X	X	X	X	X	X	X	X	X	X	X	X
Round	X	X	X	X		X	X	X	X	X	X	X	X	X	X	X	X	X	X	X	X	X
Cross			X	X	X					X	X	X					X	X	X			
Half Round			X	X	X	X	X			X	X	X	X	X			X	X	X	X	X	X
Panel	X	X	X	X	X			X	X	X	X	X			X	X	X	X	X			
Rectangular Panel	X	X	X	X	X	X	X	X	X	X	X	X			X	X	X	X	X	X		
Ellipse	X*		X*	X*	X*																	

X* ONLY ON 54" AND 60"

* ONLY AVAILABLE ON LAMINATE

3 Pc Conference Top : widths of 216", 240", or 264"



Location A
EC13
EC23

Location B
EC13
EC23
EC57

Location C
EC13
EC23

Location D
EC57

Location E
EC13
EC23

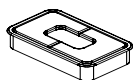
Location F
EC13
EC23
EC57

Location G
EC13
EC23

	216					240					264								
	Location A,C,E,G		Location B,F			Location D	Location A,C,E,G		Location B,F			Location D	Location A,C,E,G		Location B,F			Location D	
	EC23	EC13	EC23	EC13	EC57	EC57	EC23	EC13	EC23	EC13	EC57	EC57	EC23	EC13	EC23	EC13	EC57	EC57	
Square	X	X	X	X	X	X	X	X	X	X	X	X	X	X	X	X	X	X	X
Round	X	X	X	X	X	X	X	X	X	X	X	X	X	X	X	X	X	X	X
Cross				X	X					X	X							X	X
Metal X				X	X					X	X							X	X
Half Round			X	X	X	X	X	X	X	X	X			X	X	X	X	X	X
Panel	X	X		X	X	X	X	X	X	X	X			X	X	X	X		
Rectangular Panel	X			X	X	X	X	X	X	X	X			X	X	X	X		
Ellipse																			

Vision Conference Product Information

Grommets



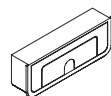
Worksurface Grommet

Standard worksurface grommet are indicated on specific model add \$51 list per location. For custom locations, contact customer service for approval of location and add \$114 list per location.

Grommet color must be specified, select Matte Black or Arctic Silver.

Matte Black (MBK)

Arctic Silver (ASL)



Chassis End/Back Panel Grommet

Chassis grommets, consisting of back and end panels, are dependant on model, which is indicated on pricing pages. Due to the nature of wire management grommets are selected for the complete chassis. Upcharge varies per model.

Drawer Pull Style and Color Options



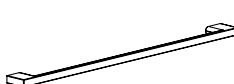
Bar

Matte Black (MBK)
Polished Nickel (PNK)



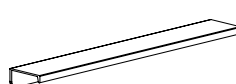
Sweep

Matte Black (MBK)
Matte Nickel (MNK)



Delve

Matte Black (MBK)
Arctic Silver (ASL)
Pewter (PEW)
Soft Nickel (SNK)
Soft Bronze (SBZ)
Aged Bronze (ABZ)
Gold (GLD)
Chrome (CHR)

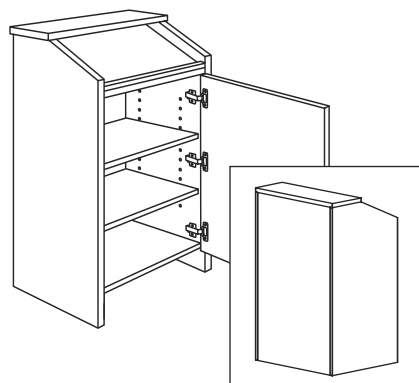


Prospect

Matte Black (MBK)
Arctic Silver (ASL)
Pewter (PEW)
Soft Nickel (SNK)
Soft Bronze (SBZ)
Aged Bronze (ABZ)
Gold (GLD)

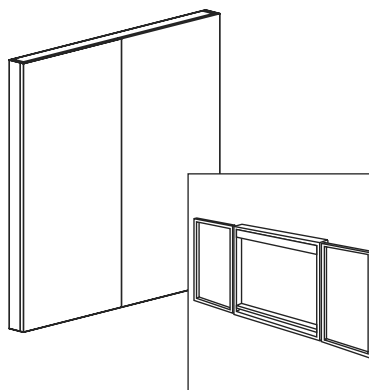
Support Furniture

Lectern



- concealed locking casters
- adjustable shelves
- see pages [VS355-VS365](#) for power and data options

Visual Board



- tackable surface on interior of the doors
- includes two markers and eraser

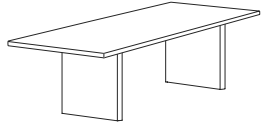
Vision Conference Product Information

Finish and Reference Codes - Summary

Select	Code	Select	Code	Select	Code
Veneer/Substrate		Double Cut Finishes		Solid Laminates	
Cherry	CH1	Barrel - Oak Pattern	BAR	Alabaster	ALB
Maple	MA1	Buff - Oak Pattern	BUF	Bridal Blanco	BBL
Walnut	WA1	Cinder - Oak Pattern	CND	Black	BLK
Black Oak	BO1	Coffee	COF	Designer White	DWH
Double Cut	DC1	Cremello	CRM	Shadow	SHD
Finish		Egret	EGR	Slate Grey	SLG
Cherry Finishes		Fawn	FAW	Top Edge Details	
Bourbon Medium	BBM	Fossil	FOS	Eased	R3
Brighton Medium	BRM	Graphite	GRH	Pull & Finish Codes	
Classic	CLA	Khaki	KHK	Bar - Matte Nickel	MBK
Harvest	HRV	Mineral - Oak Pattern	MIN	Bar - Polished Nickel	PNK
Praline	PRL	Rye - Oak Pattern	RYE	Sweep - Matte Black	MBK
Maples Finishes		Sable - Oak Pattern	SAB	Sweep - Matte Nickel	MNK
Ale Medium	ALM	Saddle - Oak Pattern	SAD	Delve - Matte Black	MBK
Butterscotch	BUT	Studio Teak	STU	Delve - Arctic Silver	ASL
Flax	FLX	Valley	VAL	Delve - Pewter	PEW
Venetian	VEN	Veneer Wood Grain Laminates		Delve - Matte Nickel	MNK
Walnut Finishes		Ale Light	ALL	Delve - Soft Nickel	SNK
Espresso	ESP	Bourbon Light	BOL	Delve - Soft Bronze	SBZ
Mocha	MCH	Brazilwood	BZW	Delve - Aged Bronze	ABZ
Sienna	SIE	Brighton Light	BGL	Delve - Gold	GLD
Truffle	TRF	Collectors	CLL	Prospect - Matte Black	MBK
Umber	UMB	Fawn	FAW	Prospect - Arctic Silver	ASL
Black Oak Finishes		Florence Walnut	FLO	Prospect - Pewter	PEW
<i>Raven</i>	RAV	Graphite	GRH	Prospect - Matte Nickel	MNL
		Mineral	MIN	Prospect - Soft Nickel	SNK
		Oatmeal Cookie	OAT	Prospect - Soft Bronze	SBZ
		Pinnacle Walnut	PIN	Prospect - Aged Bronze	ABZ
		Studio Teak	STU	Prospect - Gold	GLD
		Umber	UMB	Grommet Finish	
		Valley	VAL	Matte Black	MBK
		Vintage	VIN	Arctic Silver	ASL
		Weathered Ash	WEA	Drawer Box	
				Wood Drawers	DRM001
				Vinyl Wrapped Drawers	DRM002

Description	D	W	H	CTN WT	CU FT	① Model	Flat Cut List Price	Double Cut List Price
-------------	---	---	---	-----------	----------	---------	------------------------	--------------------------

Conference Table	42	96	29½			VSV4296CTP	\$4,954	\$5,453
-------------------------	----	----	-----	--	--	-------------------	----------------	----------------

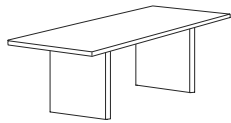


Consists of:

	172	15	(1) VSV4296TT - Table Top	\$3,532	\$3,887
	54 ea.	4 ea.	(2) VSV2428PB - Panel Base	\$711 ea.	\$783 ea.

- ships KD in two cartons
- price reflects two bases
- must order (2) panel bases

Conference Table	36	72	29½			VSV3672CTP	\$3,694	\$4,066
-------------------------	----	----	-----	--	--	-------------------	----------------	----------------

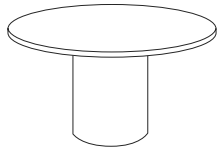


Consists of:

	110	10	(1) VSV3672TT - Table Top	\$2,272	\$2,500
	54 ea.	4 ea.	(2) VSV2428PB - Panel Base	\$711 ea.	\$783 ea.

- ships KD in two cartons
- price reflects two bases
- must order (2) panel bases

Round Conference Table	48	48	29½			VSV48CTD	\$2,835	N/A
-------------------------------	----	----	-----	--	--	-----------------	----------------	------------

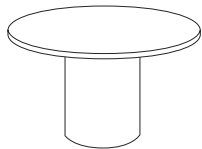


Consists of:

	73	7	VSV48TT - Table Top	\$1,746	N/A
	71	9	VSV20RB - Round Base	\$1,089	N/A

- ships KD in two cartons

Round Conference Table	42	42	29½			VSV42CTD	\$2,441	N/A
-------------------------------	----	----	-----	--	--	-----------------	----------------	------------

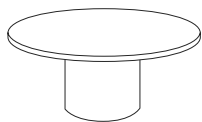


Consists of:

	56	5	VSV42TT - Table Top	\$1,352	N/A
	71	9	VSV20RB - Round Base	\$1,089	N/A

- ships KD in two cartons

Round Conference Table	42	42	16			VSV42MTD	\$2,370	N/A
-------------------------------	----	----	----	--	--	-----------------	----------------	------------

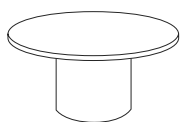


Consists of:

	56	5	VSV42TT - Table Top	\$1,352	N/A
	68	5	VSV18-16RB - Round Base	\$1,018	N/A

- ships KD in two cartons


Round Conference Table	36	36	16			VSV36MTD	\$2,209	N/A
-------------------------------	----	----	----	--	--	-----------------	----------------	------------

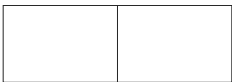


Consists of:


	42	4	VSV36TT - Table Top	\$1,191	N/A
	68	5	VSV18-16RB - Round Base	\$1,018	N/A

- ships KD in two cartons

Description	D	W	Seating Capacity	Top Pieces	Bases Required	CTN WT	CU FT	① Model	Flat Cut List Price	Double Cut List Price
Rectangular Conference Table Top 	60	264	24	3	4	673	57	VSV60264TT	\$14,903	\$16,393
	60	240	22	3	4	613	51	VSV60240TT	\$13,548	\$14,902
	60	216	20	3	4	552	48	VSV60216TT	\$12,197	\$13,415
	54	264	22	3	4	609	52	VSV54264TT	\$12,421	\$13,664
	54	240	20	3	4	554	50	VSV54240TT	\$11,290	\$12,421
	54	216	18	3	4	498	43	VSV54216TT	\$10,164	\$11,179
	48	264	22	3	4	548	47	VSV48264TT	\$11,044	\$12,147
	48	240	20	3	4	498	43	VSV48240TT	\$10,040	\$11,044
	48	216	18	3	4	447	38	VSV48216TT	\$9,032	\$9,937


Rectangular Conference Table Top 	60	192	18	2	3	490	42	VSV60192TT	\$10,840	\$11,924
	54	192	16	2	3	441	38	VSV54192TT	\$9,032	\$9,937
	48	192	16	2	3	396	33	VSV48192TT	\$8,033	\$8,836
	48	168	14	2	3	346	30	VSV48168TT	\$7,032	\$7,734
	48	144	12	2	3	296	28	VSV48144TT	\$6,027	\$6,628
	48	120	8	2	2-3**	245	22	VSV48120TT**	\$5,024	\$5,526
	42	120	8	2	2-3**	217	19	VSV42120TT**	\$4,397	\$4,835
	42	108	8	2	2	195	17	VSV42108TT	\$3,959	\$4,356


** When ordering Panel or Rectangular bases - VSV48120TT and VSV42120TT require three (3) bases and additional stretchers. Stretchers will be included as required.

Rectangular Conference Table Top 	48	96	8	1	2	197	17	VSV4896TT	\$4,035	\$4,439
	42	96	8	1	2	172	15	VSV4296TT	\$3,532	\$3,887
	42	84	6	1	2	151	13	VSV4284TT	\$3,075	\$3,383
	36	72	6	1	2	110	10	VSV3672TT	\$2,272	\$2,500

To Order, Specify:

- ① Model Number
- ② Wood Species - Cherry (CH1), Maple (MA1), Walnut (WA1),
Black Oak (BO1) or Double Cut (see page [VS330](#))
- ③ Finish Color (see page [VS330](#))
- ④ Edge Profile (see page [VS332](#))
- ⑤ Power and Data Options (see pages [VS355](#))
- ⑥ Other Product Options

Description	D	W	Seating Capacity	Top Pieces	Bases Required	CTN WT	CU FT	① Model	Flat Cut List Price	Double Cut List Price
Racetrack Conference Table Top 	60	264	24	3	4	646	57	VSV60264RT	\$17,610	\$19,372
	60	240	22	3	4	589	51	VSV60240RT	\$16,011	\$17,610
	60	216	20	3	4	530	48	VSV60216RT	\$14,410	\$15,850
	54	264	22	3	4	586	52	VSV54264RT	\$14,676	\$16,144
	54	240	20	3	4	530	50	VSV54240RT	\$13,342	\$14,677
	54	216	18	3	4	474	43	VSV54216RT	\$12,012	\$13,212
	48	264	22	3	4	529	47	VSV48264RT	\$13,045	\$14,350
	48	240	20	3	4	479	43	VSV48240RT	\$11,860	\$13,045
	48	216	18	3	4	428	38	VSV48216RT	\$10,676	\$11,743

Racetrack Conference Table Top 	60	192	18	2	3	471	42	VSV60192RT	\$12,811	\$14,092
	54	192	16	2	3	417	38	VSV54192RT	\$10,676	\$11,743
	48	192	16	2	3	377	33	VSV48192RT	\$9,491	\$10,442
	48	168	14	2	3	327	30	VSV48168RT	\$8,334	\$9,166
	48	144	12	2	3	277	28	VSV48144RT	\$7,121	\$7,833
	48	120	8	2	2-3**	226	22	VSV48120RT**	\$5,940	\$6,534
	42	120	8	2	2-3**	203	19	VSV42120RT**	\$5,193	\$5,714
	42	108	8	2	2	180	17	VSV42108RT	\$4,679	\$5,146

** When ordering Panel or Rectangular bases - VSV48120RT and VSV42120RT require three (3) bases and additional stretchers. Stretchers will be included as required.

Racetrack Conference Table Top 	48	96	8	1	2	185	17	VSV4896RT	\$4,748	\$5,224
	42	96	8	1	2	157	15	VSV4296RT	\$4,157	\$4,574
	42	84	6	1	2	142	13	VSV4284RT	\$3,653	\$4,018
	36	72	6	1	2	100	10	VSV3672RT	\$2,677	\$2,945

Description	D	W	Seating Capacity	Top Pieces	Bases Required	CTN WT	CU FT	① Model	Flat Cut List Price	Double Cut List Price
Boat Shape Conference Table Top	60	264	24	3	4	646	57	VSV60264BT	\$17,610	\$19,372
	60	240	22	3	4	589	51	VSV60240BT	\$16,011	\$17,610
	60	216	20	3	4	530	48	VSV60216BT	\$14,410	\$15,850
	54	264	22	3	4	586	52	VSV54264BT	\$14,676	\$16,144
	54	240	20	3	4	530	50	VSV54240BT	\$13,342	\$14,677
	54	216	18	3	4	474	43	VSV54216BT	\$12,012	\$13,212
	48	264	22	3	4	529	47	VSV48264BT	\$13,045	\$14,350
	48	240	20	3	4	479	43	VSV48240BT	\$11,860	\$13,045
	48	216	18	3	4	428	38	VSV48216BT	\$10,676	\$11,743

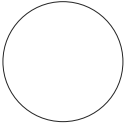
Boat Shape Conference Table Top	60	192	18	2	3	471	42	VSV60192BT	\$12,811	\$14,092
	54	192	16	2	3	417	38	VSV54192BT	\$10,676	\$11,743
	48	192	16	2	3	377	33	VSV48192BT	\$9,491	\$10,442
	48	168	14	2	3	327	30	VSV48168BT	\$8,334	\$9,166
	48	144	12	2	3	277	28	VSV48144BT	\$7,121	\$7,833
	48	120	8	2	2-3**	226	22	VSV48120BT**	\$5,940	\$6,534
	42	120	8	2	2-3**	203	19	VSV42120BT**	\$5,193	\$5,714
	42	108	8	2	2	180	17	VSV42108BT	\$4,679	\$5,146

** When ordering Panel or Rectangular bases - VSV48120BT and VSV42120BT require three (3) bases and additional stretchers. Stretchers will be included as required.

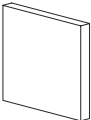
Boat Shape Conference Table Top	48	96	8	1	2	185	17	VSV4896BT	\$4,748	\$5,224
	42	96	8	1	2	157	15	VSV4296BT	\$4,157	\$4,574
	42	84	6	1	2	142	13	VSV4284BT	\$3,653	\$4,018
	36	72	6	1	2	100	10	VSV3672BT	\$2,677	\$2,945

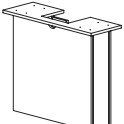
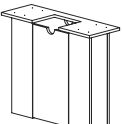
To Order, Specify:

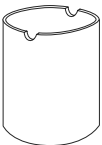
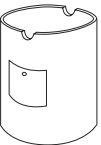
- ① Model Number
- ② Wood Species - Cherry (CH1), Maple (MA1), Walnut (WA1),
Black Oak (BO1) or Double Cut (see page [VS330](#))
- ③ Finish Color (see page [VS330](#))
- ④ Edge Profile (see page [VS332](#))
- ⑤ Power and Data Options (see pages [VS355](#))
- ⑥ Other Product Options

Description	D	W	Seating Capacity	Top Pieces	Bases Required	CTN WT	CU FT	① Model	Flat Cut List Price	Double Cut List Price
Round Tops 	60	n/a	6	1	1	112	10	VSV60TT	\$2,989	\$3,288
	54	n/a	6	1	1	92	8	VSV54TT	\$2,244	\$2,470
	48	n/a	4	1	1	73	7	VSV48TT	\$1,746	\$1,921
	42	n/a	4	1	1	56	5	VSV42TT	\$1,352	\$1,489
	36	n/a	3	1	1	42	4	VSV36TT	\$1,191	\$1,310
	30	n/a	3	1	1	30	3	VSV30TT	\$1,050	\$1,155

Description	D	W	Seating Capacity	Top Pieces	Bases Required	CTN WT	CU FT	① Model	Flat Cut List Price	Double Cut List Price
Square Tops 	60	60	8	1	1	154	10	VSV6060TT	\$2,739	\$3,014
	54	54	6	1	1	125	8	VSV5454TT	\$2,073	\$2,280
	48	48	4	1	1	99	7	VSV4848TT	\$1,637	\$1,804
	42	42	4	1	1	77	5	VSV4242TT	\$1,256	\$1,381
	36	36	4	1	1	56	4	VSV3636TT	\$1,134	\$1,247
	30	30	4	1	1	39	3	VSV3030TT	\$790	\$871

Description	D	W	H	CTN WT	CU FT	① Model	Flat Cut List Price	Double Cut List Price
Panel Base 	7 5/8	36	28 3/4	69	7	VSV3628PB · for use with 60" width tops	\$854	\$941
	7 5/8	30	28 3/4	60	6	VSV3028PB · for use with 54" width tops	\$786	\$867
	7 5/8	24	28 3/4	52	5	VSV2428PB · for use with 36", 42" & 48" width tops	\$711	\$783

Description	D	W	H	CTN WT	CU FT	① Model	Flat Cut List Price	Double Cut List Price
Rectangular Base   side 1 side 2	7 5/8	36	28 3/4	69	7	VSV3628PBA · for use with 60" width tops · access panel	\$1,444	\$1,586
	7 5/8	30	28 3/4	60	6	VSV3028PBA · for use with 54" width tops · access panel	\$1,372	\$1,510
	7 5/8	24	28 3/4	52	5	VSV2428PBA · for use with 36", 42" & 48" width tops · access panel	\$1,296	\$1,426

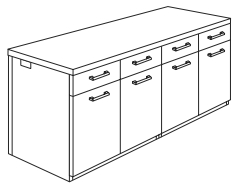
Description	D	W	H	CTN WT	CU FT	① Model	Flat Cut List Price	Double Cut List Price
Cylinder Base   *RB shown *RBA shown	24	n/a	28 3/4	74	12	VSV24RB · for use with 54" & 60" width tops	\$1,238	N/A
	24	n/a	28 3/4	37	12	VSV24RBA · for use with 54" & 60" width tops · access panel	\$1,381	N/A
	20	n/a	28 3/4	71	9	VSV20RB · for use with 42" & 48" width tops	\$1,089	N/A
	20	n/a	28 3/4	34	9	VSV20RBA · for use with 42" & 48" width tops · access panel	\$1,234	N/A
	18	n/a	68	68	7	VSV18RB · for use with 30" & 36" width tops	\$1,018	N/A
	18	n/a	28 3/4	31	7	VSV18RBA · for use with 30" & 36" width tops · access panel	\$1,164	N/A

Description	D	W	H	CTN WT	CU FT	① Model	Flat Cut List Price	Double Cut List Price
Half Round Base *HRB shown *HRBA shown	12	24	28 ¾	35	6	VSV24HRB · for use with 54" width tops	\$935	N/A
	12	24	28 ¾	33	6	VSV24HRBA · for use with 54" width tops · access panel	\$1,100	N/A
	10	20	28 ¾	30	5	VSV20HRB · for use with 42" and 48" width tops	\$852	N/A
	10	20	28 ¾	28	5	VSV20HRBA · for use with 42" and 48" width tops · access panel	\$1,021	N/A
	9	18	28 ¾	27	4	VSV18HRB · for use with 36" width tops	\$818	N/A
	9	18	28 ¾	26	4	VSV18HRBA · for use with 36" width top · access panel	\$989	N/A
Square Base 	30	30	28 ¾	68	16	VSV30SB · for use with 60" width tops	\$1,170	\$1,288
	30	30	28 ¾	68	16	VSV30SBA · for use with 60" width tops · access panel	\$1,316	\$1,447
	24	24	28 ¾	68	12	VSV24SB · for use with 48" & 54" width tops	\$1,033	\$1,135
	24	24	28 ¾	68	12	VSV24SBA · for use with 48" & 54" width tops · access panel	\$1,177	\$1,296
	18	18	28 ¾	39	7	VSV18SB · for use with 30", 36" & 42" width tops	\$890	\$979
	18	18	28 ¾	39	7	VSV18SBA · for use with 30", 36" & 42" width tops · access panel	\$1,036	\$1,140
Cross Base 	30	30	28 ¾	80	16	VSV30XB · for use with 60" width tops	\$968	\$1,065
	24	24	28 ¾	80	12	VSV24XB · for use with 48" & 54" width tops	\$873	\$960
	18	18	28 ¾	50	7	VSV18XB · for use with 30", 36" & 42" width tops	\$779	\$855

To Order, Specify:

- ① Model Number
- ② Wood Species - Cherry (CH1), Maple (MA1), Walnut (WA1),
Black Oak (BO1) or Double Cut (see page [VS330](#))
- ③ Finish Color (see page [VS330](#))
- ④ Edge Profile (see page [VS332](#))
- ⑤ Power and Data Options (see pages [VS355](#))
- ⑥ Other Product Options

Description	D	W	H	CTN WT	CU FT	① Model	Flat Cut List Price	Double Cut List Price
-------------	---	---	---	-----------	----------	---------	------------------------	--------------------------

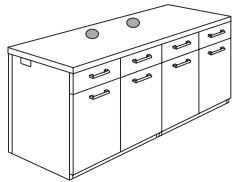


24	72	35 1/2	316	43	VSV2472BSC	\$4,923	\$5,417
----	----	--------	-----	----	------------	---------	---------

20	72	35 1/2	291	31	VSV2072BSC	\$4,728	\$5,200
----	----	--------	-----	----	------------	---------	---------

- four door credenza
- four box drawers above doors
- top edge profile on user side
- chassis grommet available, specify and add \$97 list
- adjustable shelf in storage cabinets
- locking doors and drawers not available

Buffet Credenza - Flat Screen Support	24	72	35 1/2	316	43	VSV2472BSCT	\$5,526	\$6,080
---------------------------------------	----	----	--------	-----	----	-------------	---------	---------



20	72	35 1/2	291	31	VSV2072BSCT	\$5,329	\$5,862
----	----	--------	-----	----	-------------	---------	---------

- four door credenza
- four box drawers above doors
- top edge profile on user side
- chassis grommet available, specify and add \$97 list
- adjustable shelf in storage cabinets
- locking doors and drawers not available
- flat screen mounting grommets in top
- back panel includes cord exit grommets
- flat screen mounting frame sold separately, see below

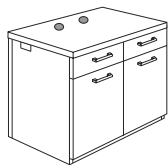
Buffet Credenza	24	36	35 1/2	167	22	VSV2436BSC	\$3,530	\$3,882
-----------------	----	----	--------	-----	----	------------	---------	---------



20	36	35 1/2	155	16	VSV2036BSC	\$3,389	\$3,727
----	----	--------	-----	----	------------	---------	---------

- two door credenza
- two box drawers above doors
- top edge profile on user side
- chassis grommet available, specify and add \$97 list
- adjustable shelf in storage cabinet
- locking doors and drawers not available

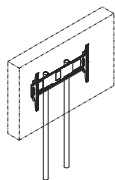
Buffet Credenza - Flat Screen Support	24	36	35 1/2	167	22	VSV2436BSCT	\$4,130	\$4,543
---------------------------------------	----	----	--------	-----	----	-------------	---------	---------



20	36	35 1/2	155	16	VSV2036BSCT	\$3,991	\$4,390
----	----	--------	-----	----	-------------	---------	---------

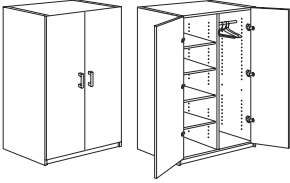
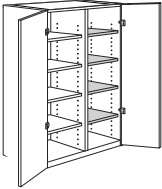
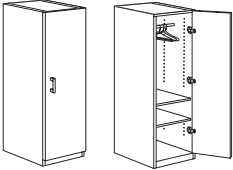
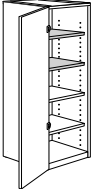
- two door credenza
- two box drawers above doors
- top edge profile on user side
- chassis grommet available, specify and add \$97 list
- adjustable shelf in storage cabinet
- locking doors and drawers not available
- flat screen mounting grommets in top
- back panel includes cord exit grommets
- flat screen mounting frame sold separately, see below

Description	D	W	H	CTN WT	CU FT	① Model	List Price
-------------	---	---	---	-----------	----------	---------	------------



Flat Screen Mounting Frame	2	14	55	35	4	FSTV	\$1,716
----------------------------	---	----	----	----	---	------	---------

- round 2" tube frame with cable management to inside of credenza
- mounting bracket for TV provided
- available in black (B) or silver (S)
- TV not included
- TV dimension not to exceed 70" w x 38" h to allow proper mounting clearance
- coordinates with VSV2472BSC and VSV2436BSC

Description	D	W	H	CTN WT	CU FT	① Model	Flat Cut List Price	Double Cut List Price
72" h Wardrobe	23 5/8	29 7/8	72	226	43	VSV2436-72W	\$4,043	\$4,447
	23 5/8	29 7/8	72	212	36	VSV2430-72W	\$3,605	\$3,964
	19 5/8	29 7/8	72	197	36	VSV2036-72W	\$3,842	\$4,227
	19 5/8	29 7/8	72	185	31	VSV2030-72W	\$3,424	\$3,765
						<ul style="list-style-type: none"> chrome hanging bar on right one fixed shelf second from bottom on left three adjustable shelves locking doors available, specify and add \$47 list 		
Hanging Bar to Shelves Conversion Kit			3/4	18	2	VSV1824SK	\$858	\$943
			3/4	15	2	VSV1524SK	\$843	\$928
			3/4	16	2	VSV1820SK	\$816	\$896
			3/4	14	2	VSV1520SK	\$803	\$885
						<ul style="list-style-type: none"> four shelves VSV1824SK - for VSV2436-84W and VSV2436-72W VSV1524SK - for VSV2430-84W and VSV2430-72W VSV1820SK - for VSV2036-84W and VSV2036-72W VSV1520SK - for VSV2030-84W and VSV2030-72W 		
72" h Wardrobe	23 5/8	177 7/8	72	155	23	VSV2418-72WR	\$3,163	\$3,480
	23 5/8	177 7/8	72	155	23	VSV2418-72WL	\$3,163	\$3,480
	19 5/8	177 7/8	72	135	19	VSV2018-72WR	\$2,917	\$3,210
	19 5/8	177 7/8	72	135	19	VSV2018-72WL	\$2,917	\$3,210
right shown						<ul style="list-style-type: none"> chrome hanging bar on right one fixed shelf 29" from cabinet floor one adjustable shelf locking door available, specify and add \$40 list 		
Hanging Bar to Shelves Conversion Kit			3/4	16	2	VSV1624SK	\$680	\$748
			3/4	14	2	VSV1620SK	\$649	\$711
						<ul style="list-style-type: none"> two shelves VSV1624SK - for VSV2418-84WR/WL and VSV2418-72WR/WL VSV1620SK - for VSV2018-84WR/WL and VSV2018-72WR/WL 		

To Order, Specify:

- ① Model Number
- ② Wood Species - Cherry (CH1), Maple (MA1), Walnut (WA1),
Black Oak (BO1) or Double Cut (see page [VS330](#))
- ③ Finish Color (see page [VS330](#))
- ④ Edge Profile (see page [VS332](#))
- ⑤ Power and Data Options (see pages [VS355](#))
- ⑥ Other Product Options

Description	D	W	Seating Capacity	Top Pieces	Bases Required	CTN WT	CU FT	Model	TFL List Price	HPL List Price
Rectangular Conference Table Top	48	144	12	2	3	296	28	VST48144TT	N/A	\$2,206
	48	120	8	2	2-3**	245	22	VST48120TT**	N/A	\$2,142



· 3" radius corners

** When ordering Elliptical or Rectangle bases - VST48120TT requires three (3) bases and additional stretchers. Stretchers will be included as required.

Rectangular Conference Table Top	48	96	8	1	2	197	17	VST4896TT	N/A	\$1,693
	42	96	8	1	2	172	15	VST4296TT	N/A	\$1,531
	42	84	6	1	2	151	13	VST4284TT	\$1,366	\$1,434
	36	72	6	1	2	110	10	VST3672TT	\$1,028	\$1,082



· 3" radius corners

Racetrack Conference Table Top	48	144	12	2	3	277	28	VST48144RT	N/A	\$2,555
	48	120	8	2	2-3**	226	22	VST48120RT**	N/A	\$2,449



** When ordering Elliptical or Rectangle bases - VST48120RT requires three (3) bases and additional stretchers. Stretchers will be included as required.

Racetrack Conference Table Top	48	96	8	1	2	185	17	VST4896RT	N/A	\$1,917
	42	96	8	1	2	157	15	VST4296RT	N/A	\$1,760
	42	84	6	1	2	142	13	VST4284RT	\$1,570	\$1,654
	36	72	6	1	2	100	10	VST3672RT	\$1,097	\$1,153



Boat Shape Conference Table Top	48	144	12	2	3	277	28	VST48144BT	N/A	\$2,555
	48	120	8	2	2-3**	226	22	VST48120BT**	N/A	\$2,449



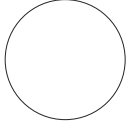
· 3" radius corners


** When ordering Elliptical or Rectangle bases - VST48120BT requires three (3) bases and additional stretchers. Stretchers will be included as required.

Boat Shape Conference Table Top	48	96	8	1	2	185	17	VST4896BT	N/A	\$1,917
	42	96	8	1	2	157	15	VST4296BT	N/A	\$1,760
	42	84	6	1	2	142	13	VST4284BT	\$1,570	\$1,654
	36	72	6	1	2	100	10	VST3672BT	\$1,097	\$1,153



· 3" radius corners

Description	D	W	Seating Capacity	Top Pieces	Bases Required	CTN WT	CU FT	① Model	TFL List Price	HPL List Price
Round Tops 	60	n/a	6	1	1	112	10	VST60TT	\$1,147	\$1,208
	54	n/a	6	1	1	92	8	VST54TT	\$1,099	\$1,155
	48	n/a	4	1	1	73	7	VST48TT	\$909	\$955
	42	n/a	4	1	1	56	5	VST42TT	\$809	\$850
	36	n/a	3	1	1	42	4	VST36TT	\$704	\$742
	30	n/a	3	1	1	30	3	VST30TT	\$673	\$707

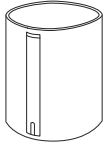
Square Tops 	48	48	4	1	1	99	7	VST4848TT	\$953	\$1,008
	42	42	4	1	1	77	5	VST4242TT	\$855	\$900
	36	36	4	1	1	56	4	VST3636TT	\$743	\$783
	30	30	4	1	1	39	3	VST3030TT	\$706	\$748

· 3" radius corners

To Order, Specify:

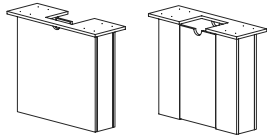
- ① Model Number
- ② Wood Species - Cherry (CH1), Maple (MA1), Walnut (WA1), Black Oak (BO1) or Double Cut (see page [VS330](#))
- ③ Finish Color (see page [VS330](#))
- ④ Edge Profile (see page [VS332](#))
- ⑤ Power and Data Options (see pages [VS355](#))
- ⑥ Other Product Options

Description	D	W	H	CTN WT	CU FT	Model	List Price
Cylinder Base	24	n/a	28 3/4	37	37	VST24RBA · for use with 48", 54" and 60" width tops	\$1,261
	18	n/a	28 3/4	31	7	VST18RBA · for use with 30", 36" and 42" width tops	\$1,227



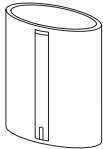
- includes wire access panel
- available in BLK-Black, SLV-Silver Laminate or any Vision laminate

Rectangular Base	7 5/8	30	28 3/4	28 3/4	6	VST3028PBA · for use with 54" width tops	\$907
------------------	-------	----	--------	--------	---	--	-------



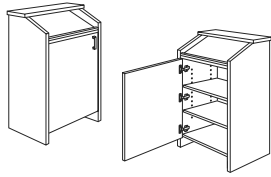
- | | | | | | | | |
|--|-------|----|--------|----|---|---|-------|
| | 7 5/8 | 24 | 28 3/4 | 52 | 5 | VST2428PBA
· for use with 36", 42" and 48" width tops | \$885 |
|--|-------|----|--------|----|---|---|-------|
- includes wire access panel
 - available in BLK-Black, SLV-Silver Laminate or any Vision laminate

Ellipse Base	9	24	28	48	12	VST2428EBA · for use with 36", 42" and 48" width tops	\$1,264
--------------	---	----	----	----	----	---	---------



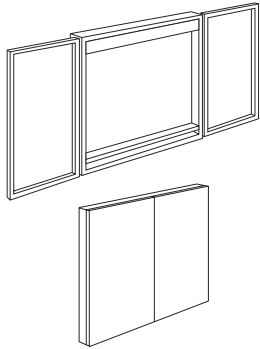
- includes wire access panel
- available in BLK-Black, SLV-Silver Laminate or any Vision laminate

Description	D	W	H	CTN WT	CU FT	① Model	Laminate	Flat Cut Veneer	Double Cut Veneer
Lectern	22	27	48	250	3	VST2622LEC	\$1,897		
	22	27	48	250	23	VSV2622LEC		\$3,304	\$3,633



- two adjustable shelves
- four concealed non-locking casters
- locking door available, specify and add \$40
- standard door is hinged on left
- round grommet in bottom panel
- notches in adjustable shelves allow wires to pass through

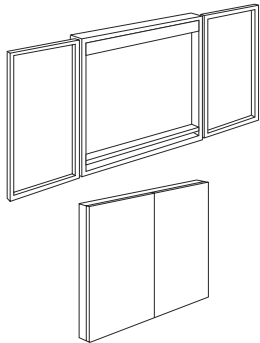
Description	D	W	H	CTN WT	CU FT	① Model	List Price Per Grade
Visual Board	48	48	3½	120	8	VST4848VB	COM \$2,268



- tackboards on right and left
- fabrics available; visit www.jsifurniture.com/finishes-and-materials/textiles
- com ydg: 1 1/2
- marker board in center section
- four markers and eraser included
- locking not available

- A \$2,282
- B \$2,315
- COL/C \$2,369
- D \$2,439
- E \$2,508
- F \$2,617
- G \$2,734
- H \$2,858
- I \$3,052
- J \$3,285

Description	D	W	H	CTN WT	CU FT	① Model	Flat Cut List Price	Double Cut List Price
Visual Board	48	48	3½	120	8	VSV4848VB	COM \$3,832	\$4,214



- tackboards on right and left
- fabrics available; visit www.jsifurniture.com/finishes-and-materials/textiles
- com ydg: 1 1/2
- marker board in center section
- four markers and eraser included
- locking not available

- A \$3,846
- B \$3,877
- C \$3,928
- D \$3,994
- E \$4,059
- F \$4,163
- G \$4,274
- H \$4,391
- I \$4,575
- J \$4,795

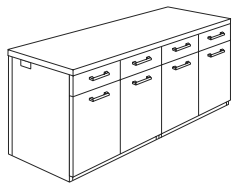
Laminate To Order, Specify:

- ① Model Number
- ② Worksurface Material (see page VS331)
 - a.) TFL
 - b.) HPL
- ③ Laminate Color (see page VS331)
- ④ Edge Profile (see page VS333)
- ⑤ Power and Data Options (see pages VS355)
- ⑥ Other Product Options

Veneer To Order, Specify:

- ① Model Number
- ② Wood Species - Cherry (CH1), Maple (MA1), Walnut (WA1), Black Oak (BO1) or Double Cut (see page VS330)
- ③ Finish Color (see page VS330)
- ④ Edge Profile (see page VS332)
- ⑤ Power and Data Options (see pages VS355)
- ⑥ Other Product Options

Description	D	W	H	CTN WT	CU FT	① Model	Flat Cut List Price	Double Cut List Price
-------------	---	---	---	--------	-------	---------	---------------------	-----------------------

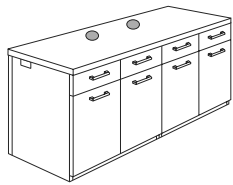


Buffet Credenza	24	72	35 1/2	316	43	VST2472BSC	\$2,918	\$3,073
-----------------	----	----	--------	-----	----	------------	---------	---------

	20	72	35 1/2	291	31	VST2072BSC	\$2,803	\$2,950
--	----	----	--------	-----	----	------------	---------	---------

- four door credenza
- four box drawers above doors
- top edge profile on user side
- chassis grommet available, specify and add \$97 list
- adjustable shelf in storage cabinets
- locking doors and drawers not available

Buffet Credenza - Flat Screen Support	24	72	35 1/2	316	43	VST2472BSCT	\$3,425	\$3,532
---------------------------------------	----	----	--------	-----	----	-------------	---------	---------



	20	72	35 1/2	291	31	VST2072BSCT	\$3,309	\$3,412
--	----	----	--------	-----	----	-------------	---------	---------

- four door credenza
- four box drawers above doors
- top edge profile on user side
- chassis grommet available, specify and add \$97 list
- adjustable shelf in storage cabinets
- locking doors and drawers not available
- flat screen mounting grommets in top
- back panel includes cord exit grommets
- flat screen mounting frame sold separately, see below

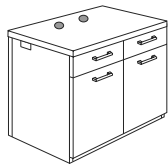
Buffet Credenza	24	36	35 1/2	167	22	VST2436BSC	\$1,935	\$2,035
-----------------	----	----	--------	-----	----	------------	---------	---------



	20	36	35 1/2	155	16	VST2036BSC	\$1,858	\$1,954
--	----	----	--------	-----	----	------------	---------	---------

- two door credenza
- two box drawers above doors
- top edge profile on user side
- chassis grommet available, specify and add \$97 list
- adjustable shelf in storage cabinet
- locking doors and drawers not available

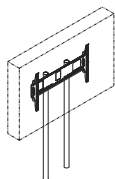
Buffet Credenza - Flat Screen Support	24	36	35 1/2	167	22	VST2436BSCT	\$2,419	\$2,494
---------------------------------------	----	----	--------	-----	----	-------------	---------	---------



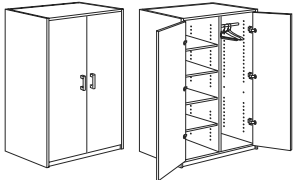
	20	36	35 1/2	155	16	VST2036BSCT	\$2,343	\$2,414
--	----	----	--------	-----	----	-------------	---------	---------

- two door credenza
- two box drawers above doors
- top edge profile on user side
- chassis grommet available, specify and add \$97 list
- adjustable shelf in storage cabinet
- locking doors and drawers not available
- flat screen mounting grommets in top
- back panel includes cord exit grommets
- flat screen mounting frame sold separately, see below

Description	D	W	H	CTN WT	CU FT	① Model	List Price
Flat Screen Mounting Frame	2	14	55	35	4	FSTV	\$1,716



- round 2" tube frame with cable management to inside of credenza
- mounting bracket for TV provide
- available in black (B) or silver (S)
- TV not included
- TV dimension not to exceed 70"w x 38"h to allow proper mounting clearance.
- coordinates with VST2472BSCT and VST2436BSCT

Description	D	W	H	CTN WT	CU FT	① Model	List Price
72" h Wardrobe 	23 5/8	35 7/8	72	226	43	VST2436-72W	\$2,615
	23 5/8	29 7/8	72	212	36	VST2430-72W	\$2,400
	19 5/8	35 7/8	72	197	36	VST2036-72W	\$2,351
	19 5/8	29 7/8	72	185	31	VST2030-72W	\$2,279

- chrome hanging bar on right
- one fixed shelf second from bottom on left
- three adjustable shelves
- locking doors available, specify and add \$47 list

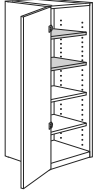
Hanging Bar to Shelves Conversion Kit 			3/4	18	2	VST1824SK	\$697
			3/4	15	2	VST1524SK	\$691
			3/4	16	2	VST1820SK	\$663
			3/4	14	2	VST1520SK	\$655

- four shelves
- VST1824SK - for VST2436-84W and VST2436-72W
- VST1524SK - for VST2430-84W and VST2430-72W
- VST1820SK - for VST2036-84W and VST2036-72W
- VST1520SK - for VST2030-84W and VST2030-72W

72" h Wardrobe 	23 5/8	177 7/8	72	155	23	VST2418-72WR	\$1,728
	23 5/8	177 7/8	72	155	23	VST2418-72WL	\$1,728
	19 5/8	177 7/8	72	135	19	VST2018-72WR	\$1,638
	19 5/8	177 7/8	72	135	19	VST2018-72WL	\$1,638

right shown

- chrome hanging bar on right
- one fixed shelf 29" from cabinet floor
- one adjustable shelf
- locking door available, specify and add \$40 list

Hanging Bar to Shelves Conversion Kit 			3/4	16	2	VST1624SK	\$548
			3/4	14	2	VST1620SK	\$529

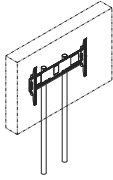
- two shelves
- VST1624SK - for VST2418-84WR/WL and VST2418-72WR/WL
- VST1620SK - for VST2018-84WR/WL and VST2018-72WR/WL

To Order, Specify:

- ① Model Number
- ② Wood Species - Cherry (CH1), Maple (MA1), Walnut (WA1), Black Oak (BO1) or Double Cut (see page VS330)
- ③ Finish Color (see page VS330)
- ④ Edge Profile (see page VS332)
- ⑤ Power and Data Options (see pages VS355)
- ⑥ Other Product Options



Description	D	W	H	CTN WT	CU FT	① Model	List Price
Flat Screen Mounting Frame	2	14	55	35	4	FSTV	\$1,716



- round 2" tube frame with cable management to inside of credenza
- mounting bracket for TV provided
- available in black (B) or silver (S)
- TV not included
- TV dimension not to exceed 70"w x 38"h to allow proper mounting clearance
- coordinates with VST2472BSCT and VST2436BSCT

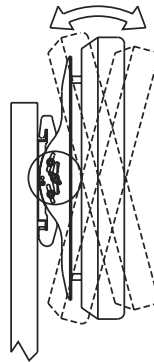
Flat Screen Mount - Universal Bracket (standard with TV, DTV and FSTV model)

Peerless® ST650 universal tilting flat screen mount is supplied with the FSTV Flat Screen Mounting Frame.

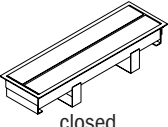
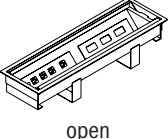
- For use with 32"-50" screens
- Maximum weight 175 lbs. (79kg)
- Tilt 15° forward and -5° backward angles
- Mounting pattern allows up to 6" of vertical adjustment

NOTE: To verify TV interface to universal bracket

1. Access website - www.peerlessmounts.com
2. Locate "Mount Finder™" on home page side navigation bar
3. Enter make and/or model of your flat screen
4. Verify model: ST650 is listed as available model



Description	D	W	H	CTN WT	CU FT	① Model	List Price
-------------	---	---	---	-----------	----------	---------	------------

Power and Data Tilt Out  closed  open	30	9		7	6	EC4	\$3,543
<ul style="list-style-type: none"> · 30" power and data unit · retractable doors · standard in silver pearl powder coat · brush aluminum doors available; specify and add \$1,358 list · door design allows cords/cables to exit while doors are in closed position · seven power receptacles · one dual powered USB · accepts up to six (6) Type 1 Telecom Plates; additional plate configurations sold separately, see pages VS360-VS361 · unit ships standard with six (6) TCP101, three (3) TCP110 Telecom Plates and three (3) data adapter kits · power inserts are UL or ETL listed · two 108" power cords with molded plugs · cannot be positioned over table support base 							

15" Power and Data Unit  closed  open	15	9		4	2	EC5	\$2,084
---	----	---	--	---	---	------------	----------------


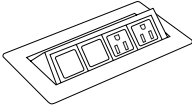



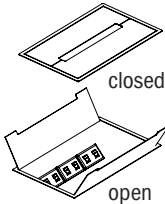
<ul style="list-style-type: none"> · retractable doors · available in silver pearl powder coat · brush aluminum doors available; specify and add \$873 list · door design allows cords/cables to exit while doors are in closed position · three power receptacles · one dual powered USB · accepts up to three (3) Type 1 Telecom Plates; additional plate configurations sold separately, see pages VS360-VS361 · unit ships standard with three (3) TCP101, two (2) TCP110 Telecom Plates and two (2) data adapter kits · power inserts are UL or ETL listed · 108" power cord with molded plug · cannot be positioned over table support base 							
--	--	--	--	--	--	--	--

Dual Sided Power and Data Unit  closed  open	11 ½	14 ¾		7	2	EC6	\$1,448
---	------	------	--	---	---	------------	----------------

<ul style="list-style-type: none"> · door design allows cords/cables to exit while doors are in closed position · eight power receptacles, four per side · accepts up to eight (8) Type 1 Telecom Plates; additional plate configurations sold separately, see pages VS360-VS361 · unit ships standard with four (4) TCP101, four (4) TCP110 Telecom Plates and two (2) data adapter kits · lids lift to open and contain an access slot to allow cords to exit while in use · available in silver pearl and black texture powder coat · units are UL listed and CSA certified · 108" power cord with molded plug · cannot be positioned over table support base 							
---	--	--	--	--	--	--	--

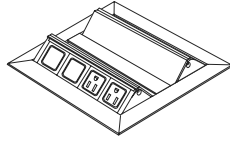
To Order, Specify:

- ① Model number

Description	D	W	H	CTN WT	CU FT	① Model	List Price
 <p>Single Sided Power and Data Unit</p> <ul style="list-style-type: none"> two power receptacles accepts one (1) Type 1 Telecom Plates; additional plate configurations sold separately, see pages VS360-VS361 unit ships standard with one (1) TCP101, one (1) TCP110 Telecom Plate and one (1) data adapter kit additionally accepts up to (4) Type 2 Telecom Jacks lid lifts to open and contain an access slot to allow cords to exit while in use available in silver pearl or black textured powder coat finish units are UL listed and CSA certified 108" power cord with molded plug one under surface power receptacle 	5 5/8	9		4	1	EC7	\$562
 <p>Single Sided Power and Data Unit</p> <ul style="list-style-type: none"> two power receptacles - 120 volt, 15 amp and two openings for voice/data jacks data adapter kit provided to accept jacks from most port manufacturers (see page VS364) accepts up to two Type 3 Telecom Jacks (see page VS363) push to open pop up door clear anodized aluminum 72" power cord with molded plug UL listed 	8 3/8	4		3	1	EC9	\$509
 <p>Mini Power and Data Tilt Up</p> <ul style="list-style-type: none"> fluid one touch tilt up access one power receptacle - 120 volt; 15 amp and one opening for voice/data port data adapter kit provided to accept jacks from most port manufacturers (see page VS364) accepts up to two Type 3 Telecom Jacks (see page VS363) 72" power cord with molded plug drop in field installation required cut out provided in top at specified location (see page VS364) UL listed component Black (B) or Silver (S) finish 	4 1/4	5 1/2		6	1	EC10	\$382
 <p>Mini Power Tilt Up</p> <ul style="list-style-type: none"> fluid one touch tilt up access two power receptacles - 120 volt; 15 amp 72" power cord with molded plug drop in field installation required cut out provided in top at specified location (see page VS364) UL listed component Black (B) or Silver (S) finish 	4 1/4	5 1/2		6	1	EC11	\$397
 <p>Mini Power and USB Tilt Up</p> <ul style="list-style-type: none"> fluid one touch tilt up access one power receptacle - 120 volt; 15 amp dual powered USB 72" power cord with molded plug drop in field installation required cut out provided in top at specified location (see page VS364) UL listed component Black (B) or Silver (S) finish 	4 1/4	5 1/2		6	1	EC12	\$428
 <p>Oasis Mini Power Unit</p> <ul style="list-style-type: none"> undermount power unit with hinged lid four power receptacles - 120 volt, 15 amp and accepts three telecom plates unit ships standard with three (3) TCP 101 and two (2) TCP110 Telecom Plates black interior 108" power cord UL listed component specify metal finish for doors and trim Arctic Silver (ASL), Matte Black (MBK), Pewter (PEW), Soft Nickel (SNK) or Bright White (BWH) 	9	14 3/8	4 3/4	1	1	EC57	\$1,343

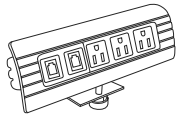
Description	D	W	H	CTN WT	CU FT	① Model	List Price
-------------	---	---	---	-----------	----------	---------	------------

Dual Power and Data Tilt Up	8	8 3/8		16	1	EC13	\$1,011
------------------------------------	---	-------	--	----	---	-------------	----------------



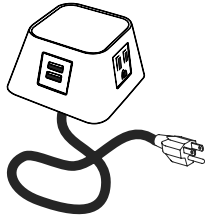
- fluid one touch tilt up access
- back to back tilt sections
- four power receptacles (2 per side) - 120 volt; 15 amp with four openings for voice/data jacks (2 per side)
- data adapter kit provided to accept jacks from most port manufacturers
- accepts up to four Type 3 Telecom Jacks (see page [VS363](#))
- two 72" power cord with molded plug
- drop in field installation required
- cut out provided in top at specified location
- UL listed component
- available in Silver (S)

Edge Mount Electrical	3	10		16	1	EC15	\$474
------------------------------	---	----	--	----	---	-------------	--------------



- clamp mounts to the edge of the worksurface - requiring minimum 2" surface overhang
- three power receptacles - 120 volt; 15 amp with two voice/data ports
- data adapter kit provided to accept jacks from most port manufacturers
- accepts up to four Type 3 Telecom Jacks (see page [VS363](#))
- 72" power cord with molded plug - exits back of unit
- UL listed component
- clear anodized aluminum

Moire Power Unit	3 3/8	3 3/8	2	5	1	EC23	\$481
-------------------------	-------	-------	---	---	---	-------------	--------------

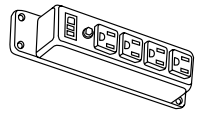


- three 110 outlets
- dual USB-A charging ports
- 72" 3-prong - 15amp plug power feed
- 15amp / 110 volt
- specify Black (BK) or White (WH)

To Order, Specify:

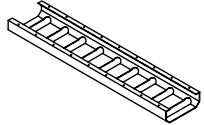
- ① Model number

Description	D	W	H	CTN WT	CU FT	① Model	List Price
-------------	---	---	---	-----------	----------	---------	------------



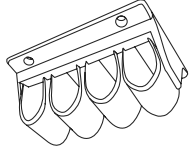
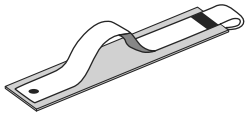
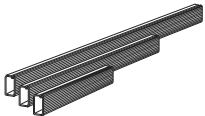
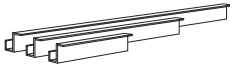
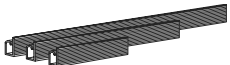
- includes switch
- power surge with 10' cord
- four electrical outlets
- field installed

Wire Management Trays



7 1/2	45					GP9WMT1-0845	\$270
7 1/2	35					GP9WMT1-0835	\$228
7 1/2	25					GP9WMT1-0825	\$185


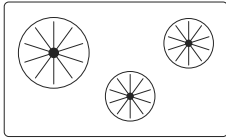
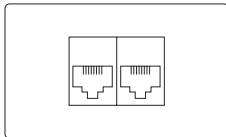
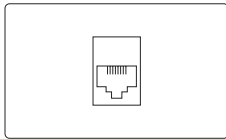
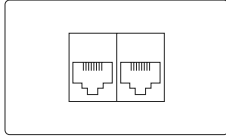
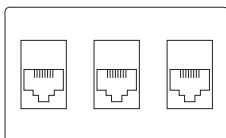
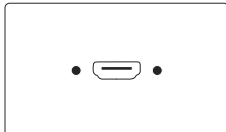
- silver powder-coated finish
- four hanging brackets (CI2C00)

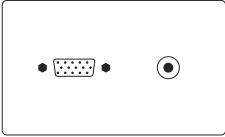
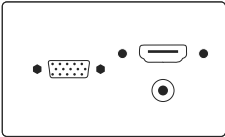
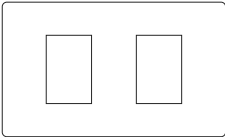

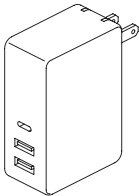
Description	D	W	H	CTN WT	CU FT	① Model	List Price
Cable Management Clip  <ul style="list-style-type: none"> · four retention loops · field installed with screws provided · mounts under surface · black 	2 5/8	3 3/4	1 5/8	1	1	0304CMC	\$54
Wire Management Velcro Straps (Set of 4)  <ul style="list-style-type: none"> · field installed with adhesive tape provided · mounts under surface or on vertical panels · black 	1 3/4	3 1/2	1/4	1	1	04WVS	\$56
Wire Management Channel  <ul style="list-style-type: none"> · black plastic · field installed with adhesive tape provided 	2 1/2	36	1	4		36WC	\$79
	2 1/2	24	1	3		24WC	\$71
	2 1/2	12	1	2		12WC	\$62
Wire Management Trough  <ul style="list-style-type: none"> · black plastic · field installed with screws provided 	2 1/2	36	2 1/2	3		36WCT	\$152
	2 1/2	24	2 1/2	3		24WCT	\$138
	2 1/2	12	2 1/2	2		12WCT	\$119
Wire Management Trough  <ul style="list-style-type: none"> · black plastic · field installed with adhesive tape provided · mounts to edge of surface top 	1 1/8	36	2 3/8	1		36WJC	\$65
	1 1/8	24	2 3/8	1		24WJC	\$47
	1 1/8	12	2 3/8	1		12WJC	\$25

To Order, Specify:

① Model number

Type 1 Telecom Plates/Jacks

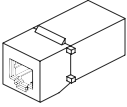
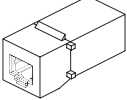
Description	D	W	H	CTN WT	CU FT	① Model	List Price
Data Plate - Blank Cap  <ul style="list-style-type: none"> · for use in EC4, EC5, EC6, EC7 		1 3/4	3 1/8			TCP101	\$16
Data Plate - Three Cord Bushings  <ul style="list-style-type: none"> · for use in EC4, EC5, EC6, EC7 		1 3/4	3 1/8			TCP102	\$76
Data Plate - Two Jacks  <ul style="list-style-type: none"> · one RJ11 Cat3 Jack · one RJ-45 Cat6 Jack · for use in EC4, EC5, EC6, EC7 		1 3/4	3 1/8			TCP103	\$136
Data Plate - One Jack  <ul style="list-style-type: none"> · one RJ-45 Cat6 jack · for use in EC4, EC5, EC6, EC7 		1 3/4	3 1/8			TCP104	\$97
Data Plate - Two Jacks  <ul style="list-style-type: none"> · two RJ-45 Cat6 jacks · for use in EC4, EC5, EC6, EC7 		1 3/4	3 1/8			TCP105	\$163
Data Plate - Three Jacks  <ul style="list-style-type: none"> · three RJ-45 Cat6 jacks · for use in EC4, EC5, EC6, EC7 		1 3/4	3 1/8			TCP106	\$229
Data Plate - HDMI  <ul style="list-style-type: none"> · one HDMI female to female with 36" cord · for use in EC4, EC5, EC6, EC7 		1 3/4	3 1/8			TCP107	\$216

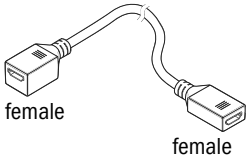
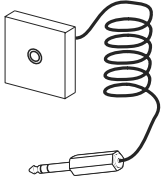
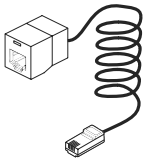
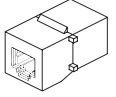
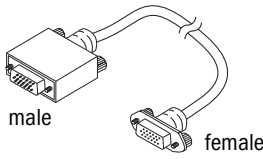
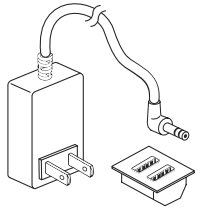
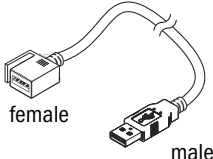
Description	D	W	H	CTN WT	CU FT	① Model	List Price
Data Plate - VGA and Mini-Stereo  <ul style="list-style-type: none"> · one VGA female to female with 72" cord · one Mini-Stereo Inline · for use in EC4, EC5, EC6, EC7 		1 ¾	3 ⅞			TCP108	\$209
Data Plate - VGA, HDMI and Mini-Stereo  <ul style="list-style-type: none"> · one VGA female to female with 72" cord · one HDMI female to female with 36" cord · one Mini-Stereo Inline · for use in EC4, EC5, EC6, EC7 		1 ¾	3 ⅞			TCP109	\$362
Data Plate - Two Open Data Ports  <ul style="list-style-type: none"> · used with two Type 3 Telecom Jacks; see page VS363 · for use in EC4, EC5, EC6, EC7 		1 ¾	3 ⅞			TCP110	\$16
Data Plate - USB 3.0  <ul style="list-style-type: none"> · one USB 3.0 Type A/A with 36" patch cord with male end · for use in EC4, EC5, EC6, EC7 · data transfer port · can become powered USB charging port with addition of TCP111-POW power supply 		1 ¾	3 ⅞			TCP111	\$237
USB Charging - Power Supply  <ul style="list-style-type: none"> · USB power supply · for use with TCP111 · converts TCP111 into USB charging port · power source under table or from building required to power unit 						TCP111-POW	\$102

To Order, Specify:

- ① Model number

Type 2 Telecom Jacks

Description	D	W	H	CTN WT	CU FT	① Model	List Price
Phone Jack 						TCP201	\$67
						<ul style="list-style-type: none">· RJ-11 phone jack· for use in EC7	
Data Jack 						TCP202	\$89
						<ul style="list-style-type: none">· CAT6-RJ45 data jack· for use in EC7	

Description	D	W	H	CTN WT	CU FT	① Model	List Price
HDMI Connector  <ul style="list-style-type: none"> · HDMI coupler · 18" cord · female to female connection · for use in EC9, EC10, EC13, EC15 · uses data adapter kit CCC adapter plate 						TCP301	\$110
Mini Stereo Jack  <ul style="list-style-type: none"> · 3.5 mm Mini Stereo Jack · 10 foot cord · female to male connection · for use in EC9, EC10, EC13, EC15 · installs directly into unit without need of data adapter kit 						TCP302	\$56
Network Jack  <ul style="list-style-type: none"> · Cat5e RJ-45 Panduit Jack · Pre-terminated · 9 foot cord · 8-Pin · for use in EC9, EC10, EC13, EC15 · uses data adapter kit FFF adapter plate 						TCP303	\$101
Voice Coupler  <ul style="list-style-type: none"> · AMP Category 3, RJ-11 · 6-Pin · connects to standard phone cord · for use in EC9, EC10, EC13, EC15 · uses data adapter kit CCC adapter plate 						TCP304	\$41
Data Jack - VGA 15 Pin  <ul style="list-style-type: none"> · 120" M/F cable - female-to-male connection · 15 pin connections · provides electronic device to remove display connection · uses data adapter kit HHH adapter plate 						TCP305	\$136
Dual Powered USB Charging  <ul style="list-style-type: none"> · two (2) USB-A connections for USB powered devices or charging mobile electronics · 2000mA (2 amp) charging power per USB port · black or white option · for use in EC9, EC10, EC13, EC15 · installs directly into unit without need of data adapter kit · 27" cord 						TCP306	\$174
Data Jack - USB 3.0  <ul style="list-style-type: none"> · USB 3.0 data jack with 10' cord and male plug · for use in EC9, EC10, EC13, EC15 · data transfer port - no USB charging capability · data transfer speed up to 5gbs/sec · uses data adapter kit CCC adapter plate 						TCP307	\$95

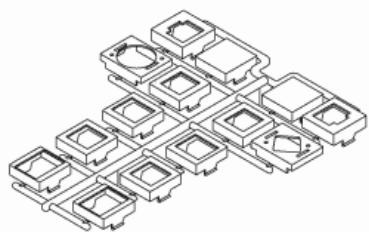
To Order, Specify:

- ① Model number

Data Adapter Applications

Data adapter kits ship with each power and data unit.

Adapter plates are marked on the back with letter designators to indicate the data jack manufacturer, series and style. Websites are listed below for quick reference to verify data jack series or style.



Included with EC9, EC10, EC13, EC15, TCP110 and CC9CNE1-0708.

NOTE: Verify fit of data jack in adapter before ordering large quantities as manufacturer designs may change without notice.

Adapter	Manufacturer	Website
AA	Uniprise/Systimax/Avaya	www.uniprisesolutions.com
BB	Tyco SL and 100 Connect Series Modular Jacks	www.ampconnect.com
BB	Siemon Keystone Style	www.siemon.com
BB	Allen Tel Versa Tap Series	www.allentel.com
BB	Leviton Quick Port® Series	www.leviton.com
BB	Nordx Keystone Style	www.nordx.com
CC	Tyco SL Coupler Series	www.ampconnect.com
CC	Krone 6000 Series	www.adc.com
CC	Hubbell Xcelerator™ Keystone Series	www.hubbell.com
DD	Blank (no coupler/jack)	
EE	Ortronics TracJack Series	www.ortronics.com
FF	Panduit Mini-Com Series	www.panduit.com
GG	Microphone jack/3-pin XLR, solder type only	
HH	Video Monitor jack/DB-15, panel mount solder style	

The TCP110 Type 1 Data plate comes with the adapter kit to allow installation of data jacks listed above. The TCP110 can be installed in the EC4, EC5, EC6, EC7.

